

Plot file version 1 created 19-DEC-2018 17:58:13

J1642+3948 RY007C.UVDATA.1

Freq = 4.9270 GHz, Bw = 16.000 MH No calibration applied and no bandpass applied

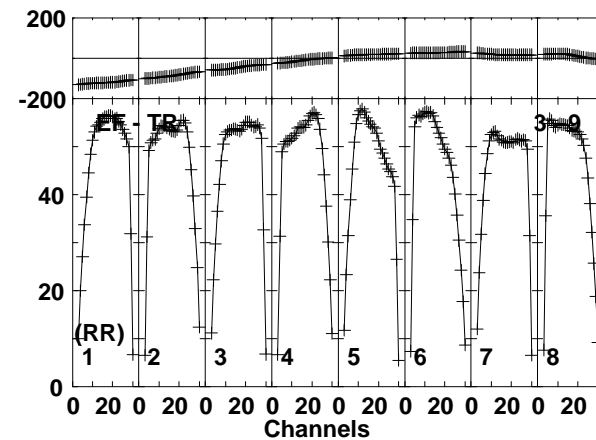
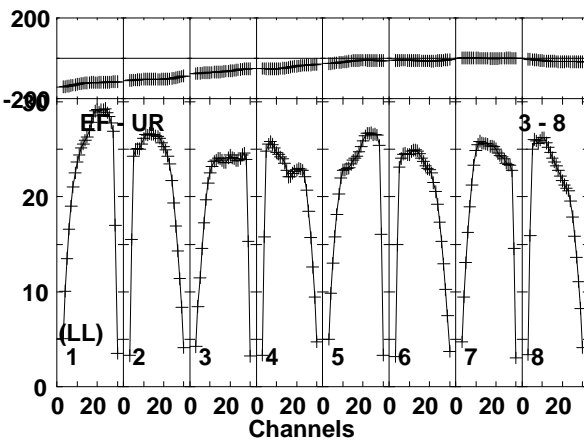
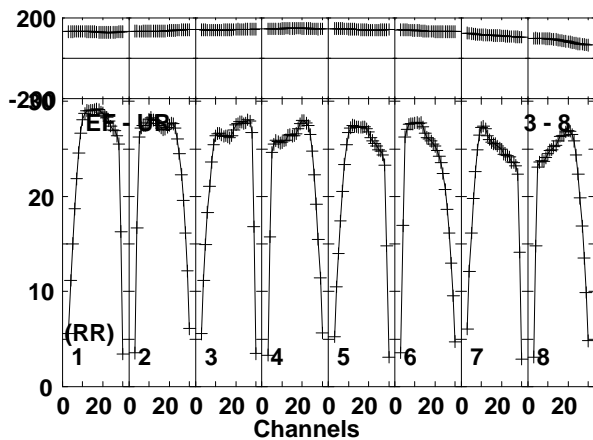
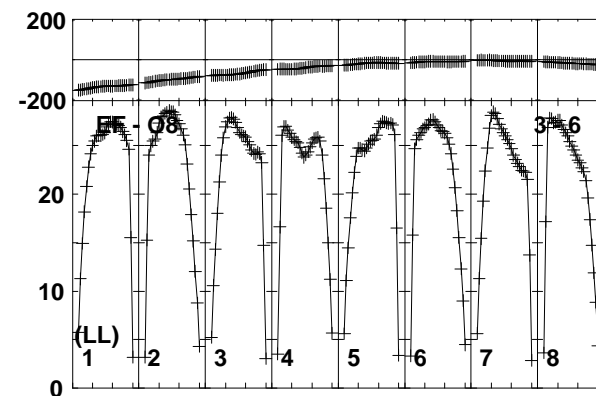
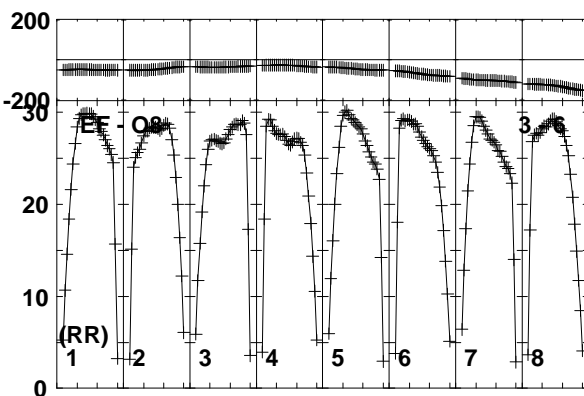
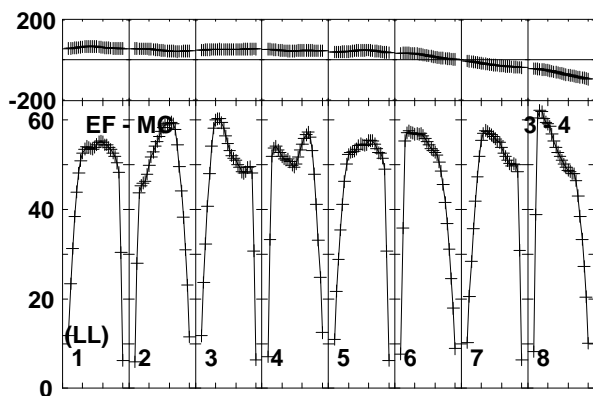
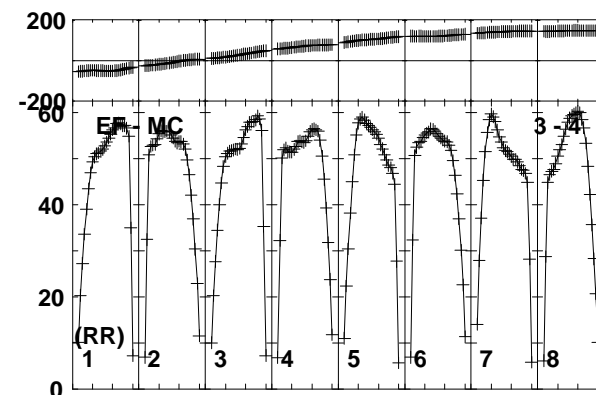
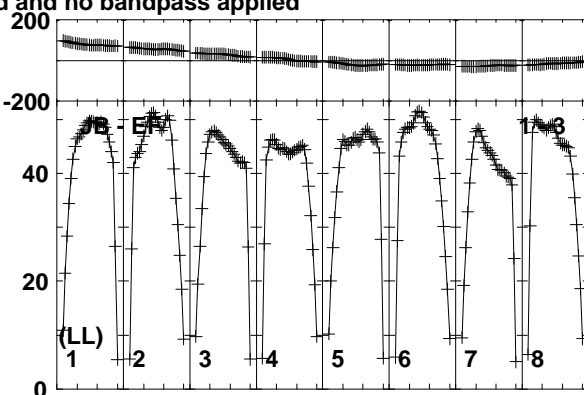
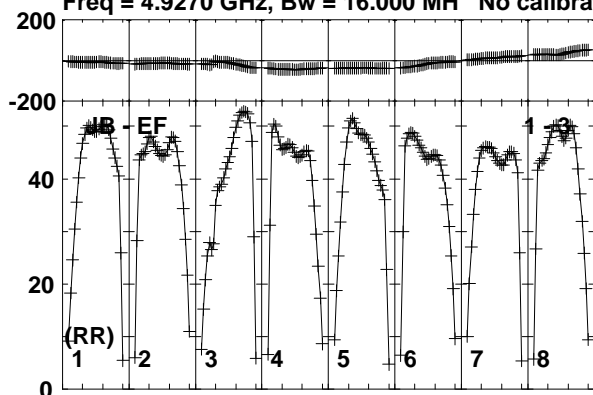

Lower frame: Milli Ampl Jy Top frame: Phas deg  
Vector averaged cross-power spectrum Baseline: JB (01) - EF (03)  
Timerange: 00/08:00:01 to 00/08:02:59

Plot file version 2 created 19-DEC-2018 17:58:13

J1642+3948 RY007C.UVDATA.1

Freq = 4.9270 GHz, Bw = 16.000 MH No calibration applied and no bandpass applied

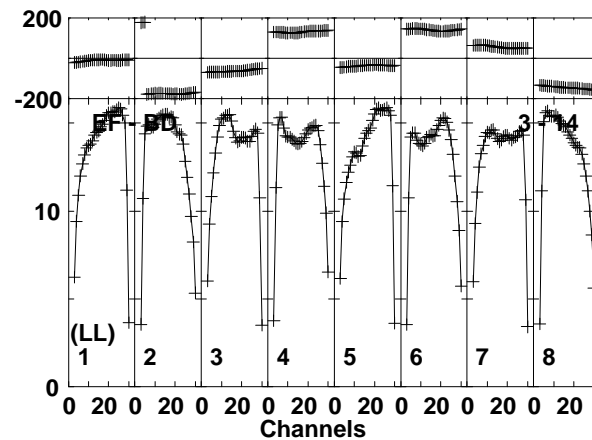
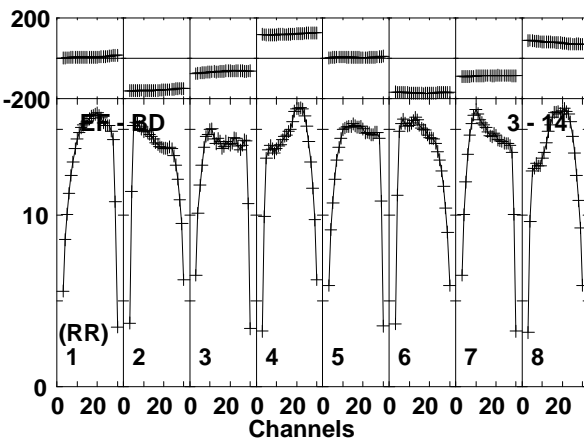
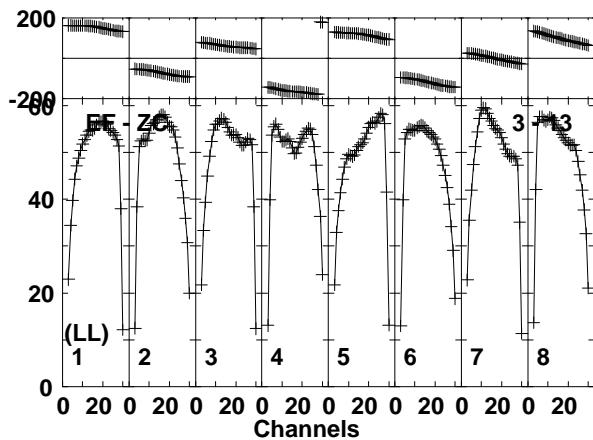
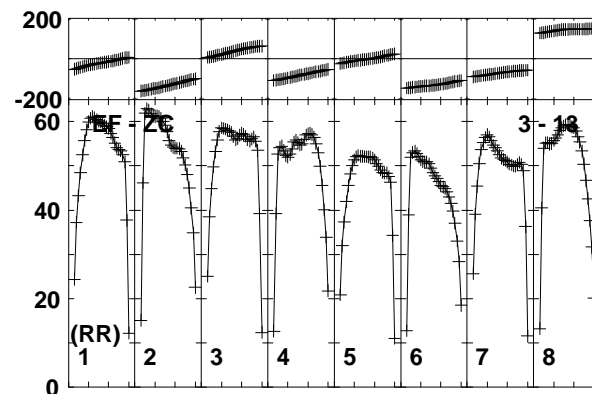
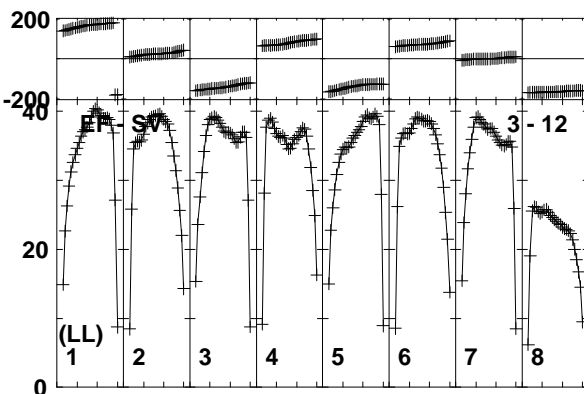
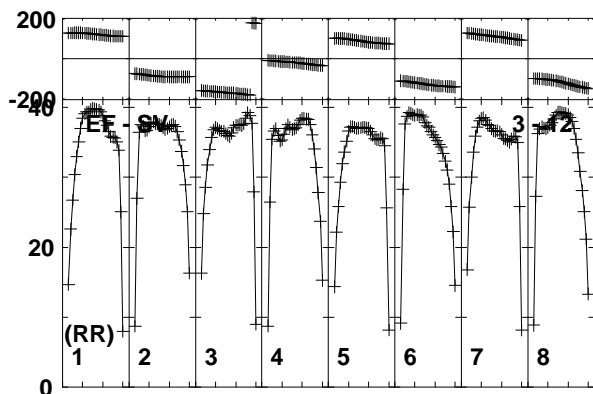
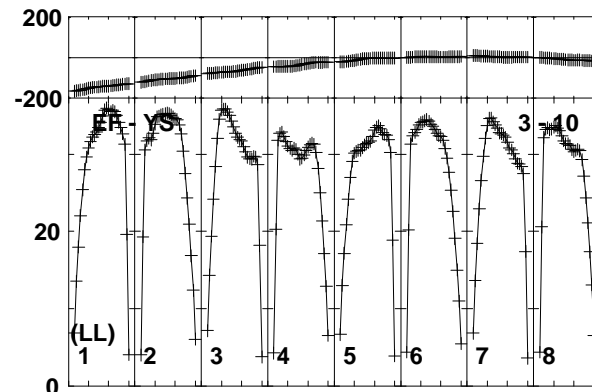
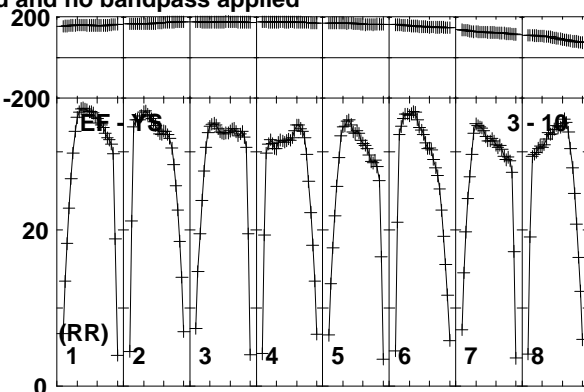
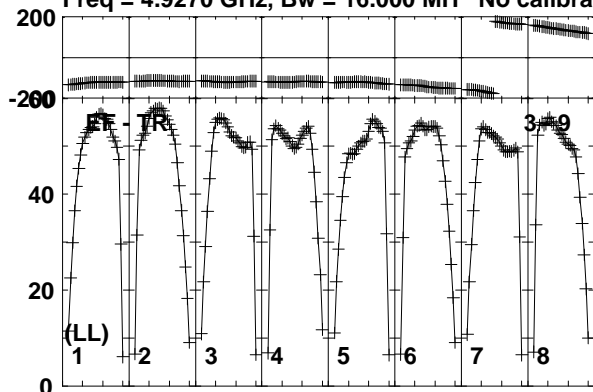

Lower frame: Milli Ampl Jy Top frame: Phas deg  
Vector averaged cross-power spectrum Baseline: EF (03) - TR (09)  
Timerange: 00/08:00:01 to 00/08:02:59



Plot file version 3 created 19-DEC-2018 17:58:13

J1642+3948 RY007C.UVDATA.1

Freq = 4.9270 GHz, Bw = 16.000 MH No calibration applied and no bandpass applied

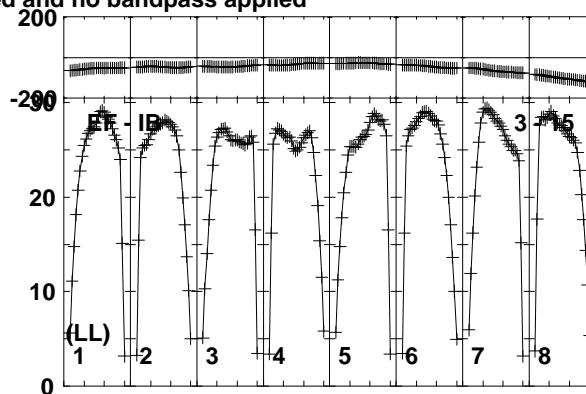
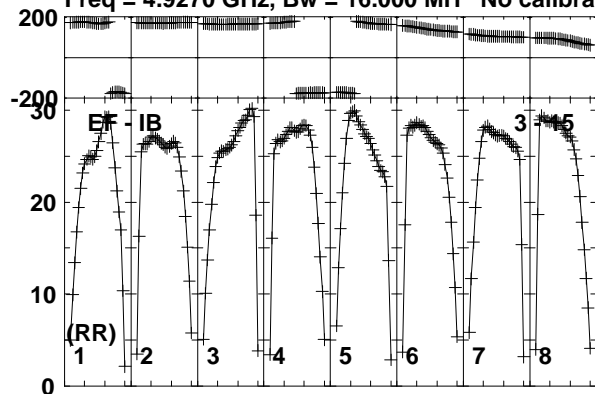

Lower frame: Milli Ampl Jy Top frame: Phas deg  
Vector averaged cross-power spectrum Baseline: EF (03) - IB (15)  
Timerange: 00/08:00:01 to 00/08:02:59

Plot file version 4 created 19-DEC-2018 17:58:13

J1619+2247 RY007C.UVDATA.1

Freq = 4.9270 GHz, Bw = 16.000 MH No calibration applied and no bandpass applied

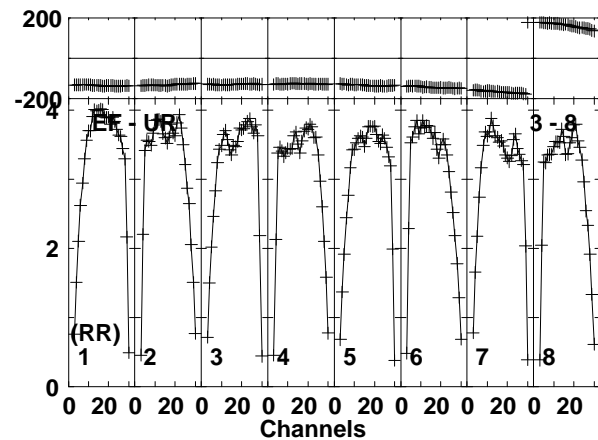
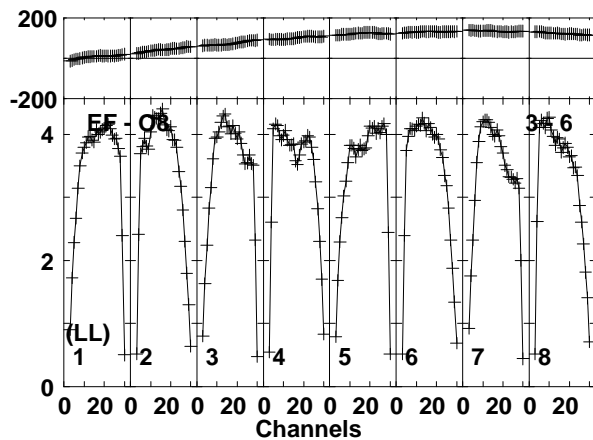
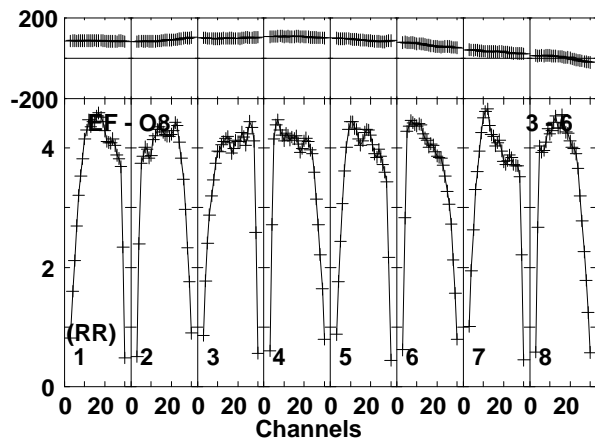
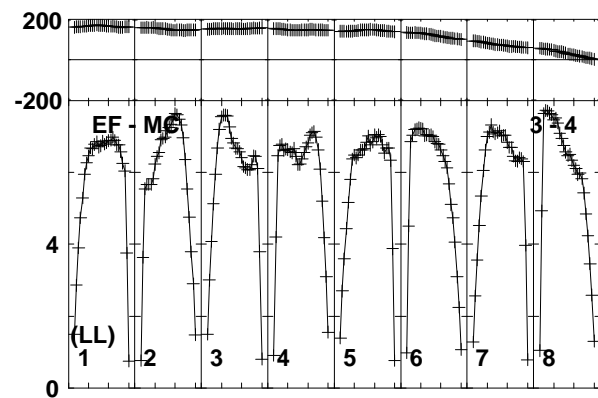
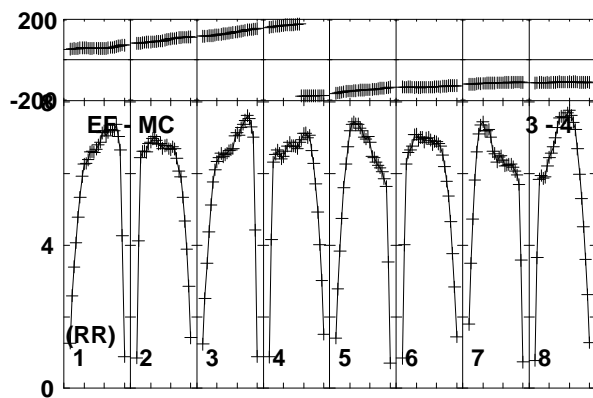
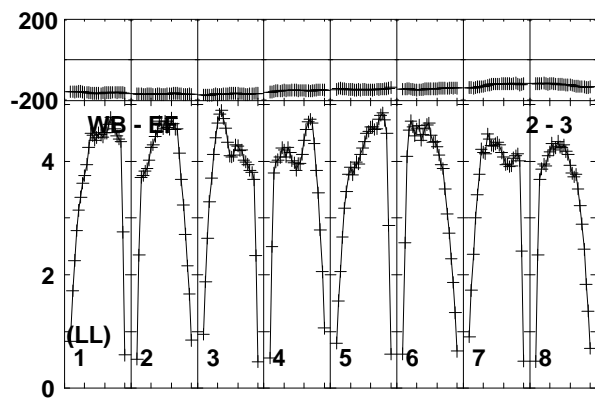
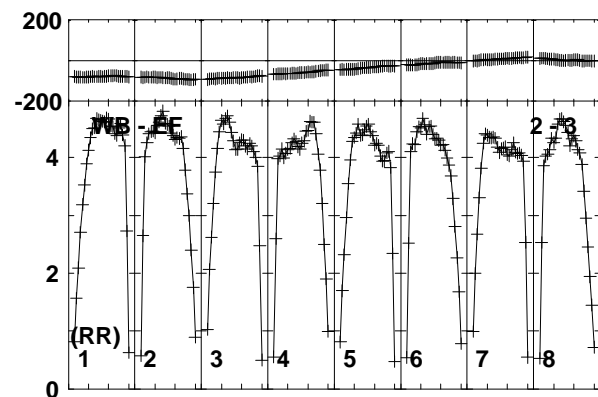
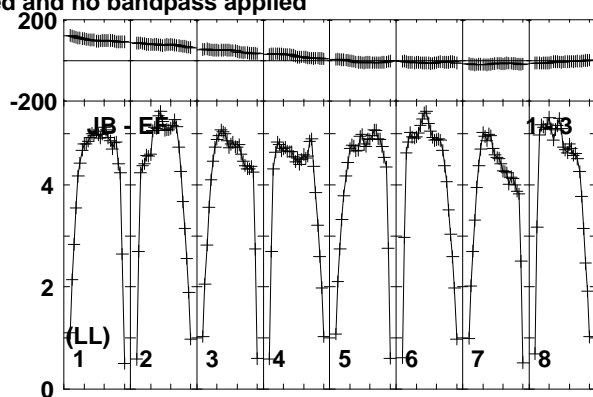
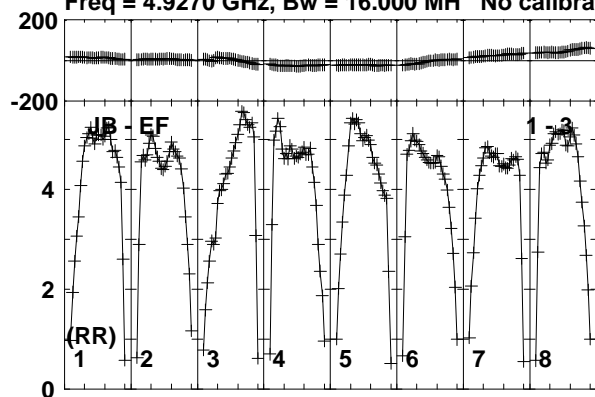

Lower frame: Milli Ampl Jy Top frame: Phas deg  
Vector averaged cross-power spectrum Baseline: JB (01) - EF (03)  
Timerange: 00/08:04:31 to 00/08:06:29

Plot file version 5 created 19-DEC-2018 17:58:13

J1619+2247 RY007C.UVDATA.1

Freq = 4.9270 GHz, Bw = 16.000 MH No calibration applied and no bandpass applied

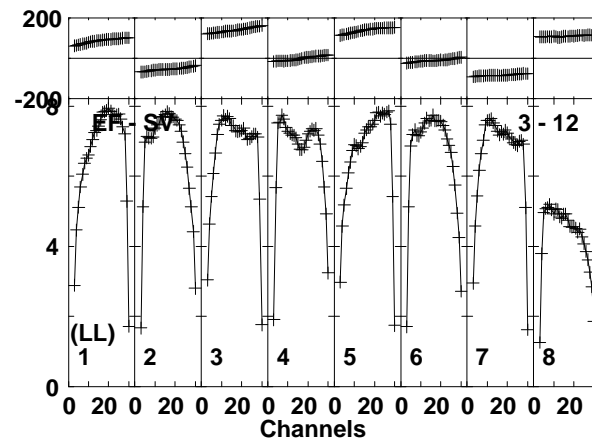
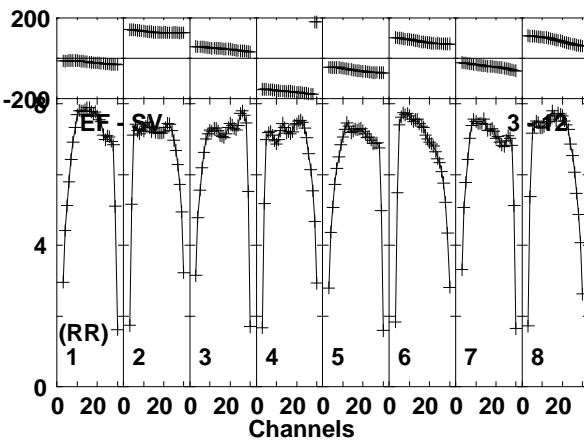
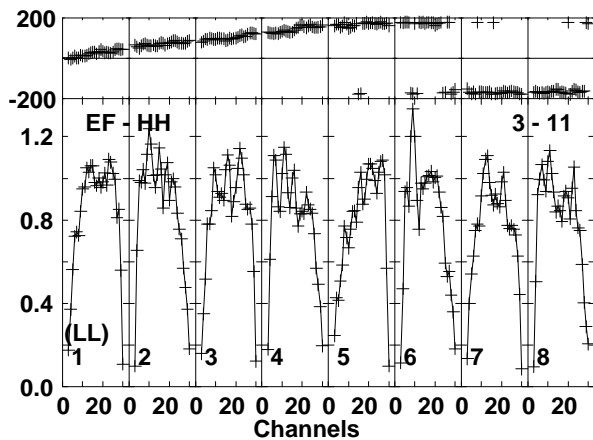
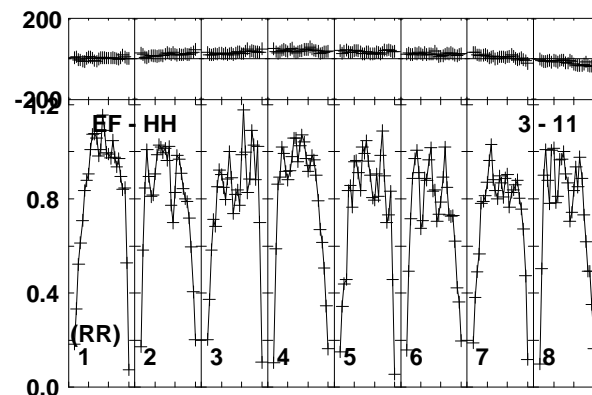
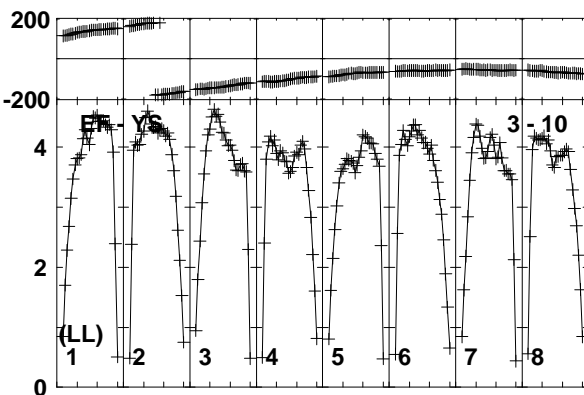
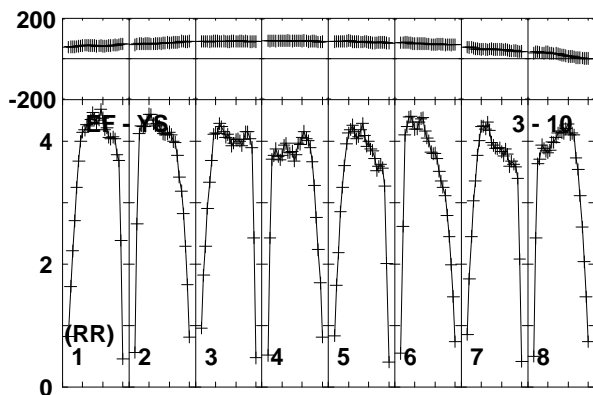
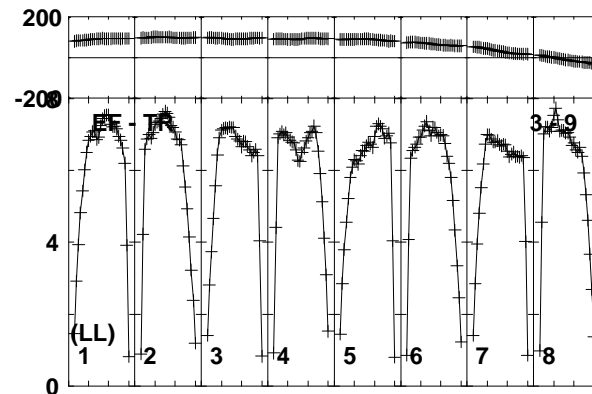
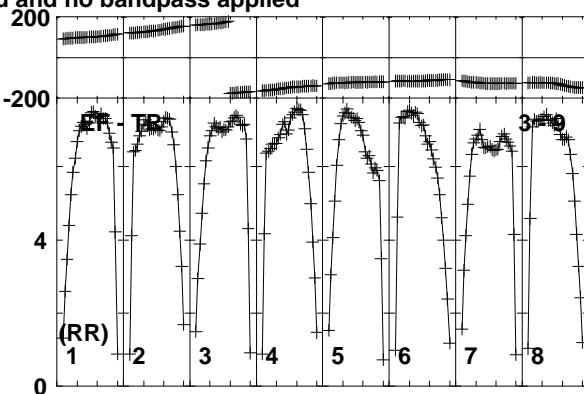
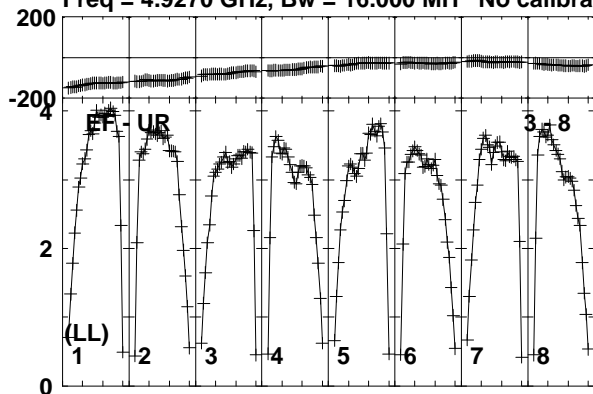

Lower frame: Milli Ampl Jy Top frame: Phas deg  
Vector averaged cross-power spectrum Baseline: EF (03) - UR (08)  
Timerange: 00/08:04:31 to 00/08:06:29

Plot file version 6 created 19-DEC-2018 17:58:13

J1619+2247 RY007C.UVDATA.1

Freq = 4.9270 GHz, Bw = 16.000 MH No calibration applied and no bandpass applied

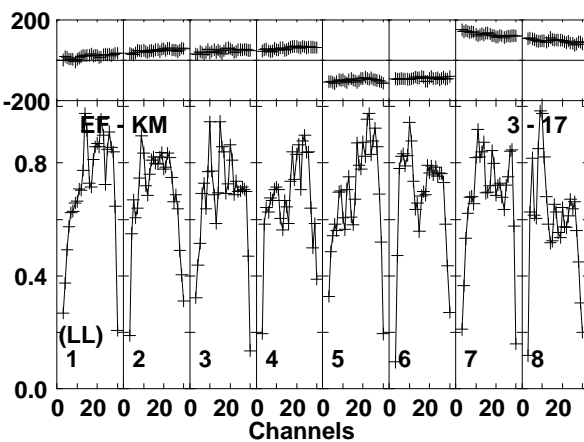
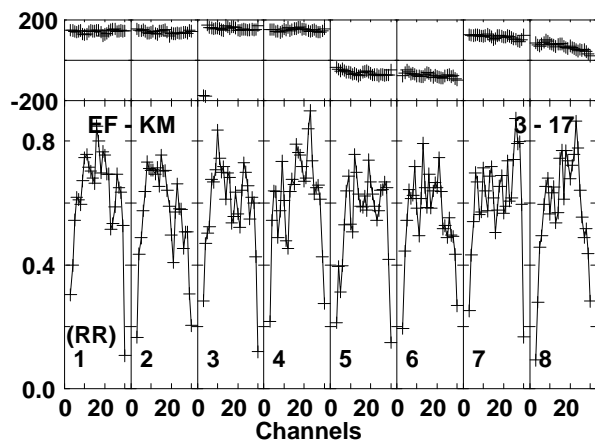
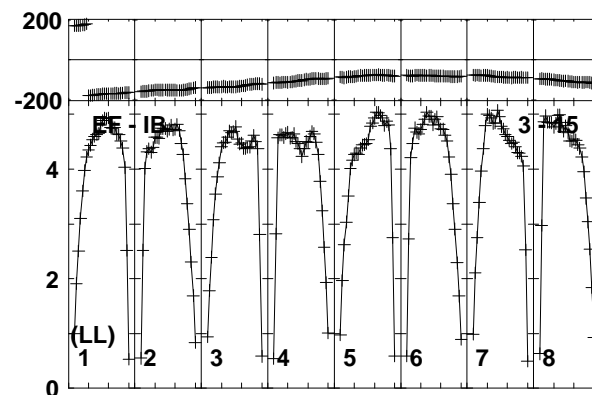
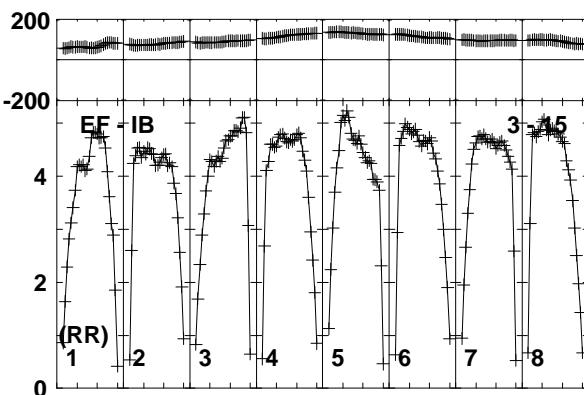
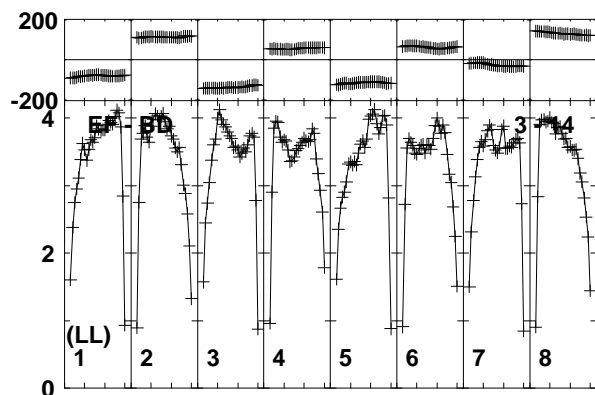
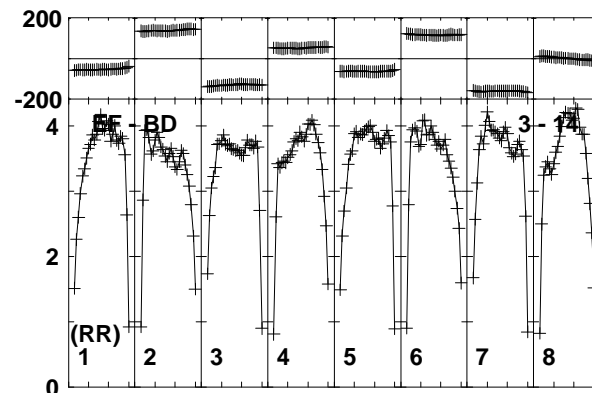
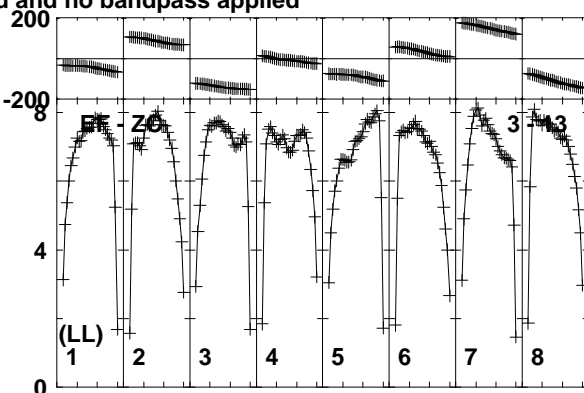
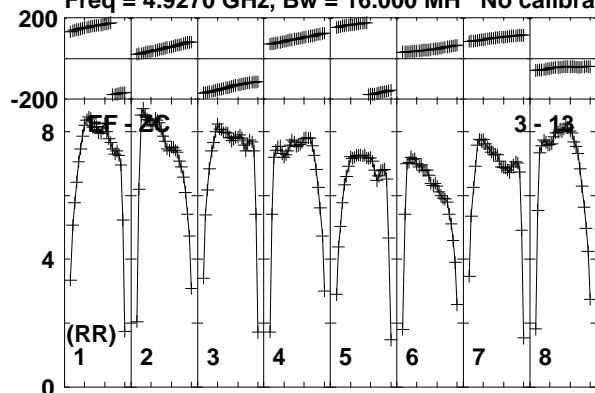

Lower frame: Milli Ampl Jy Top frame: Phas deg  
Vector averaged cross-power spectrum Baseline: EF (03) - ZC (13)  
Timerange: 00/08:04:31 to 00/08:06:29

Plot file version 7 created 19-DEC-2018 17:58:13

AT2018\_RY007C.UVDATA.1

Freq = 4.9270 GHz, Bw = 16.000 MH No calibration applied and no bandpass applied

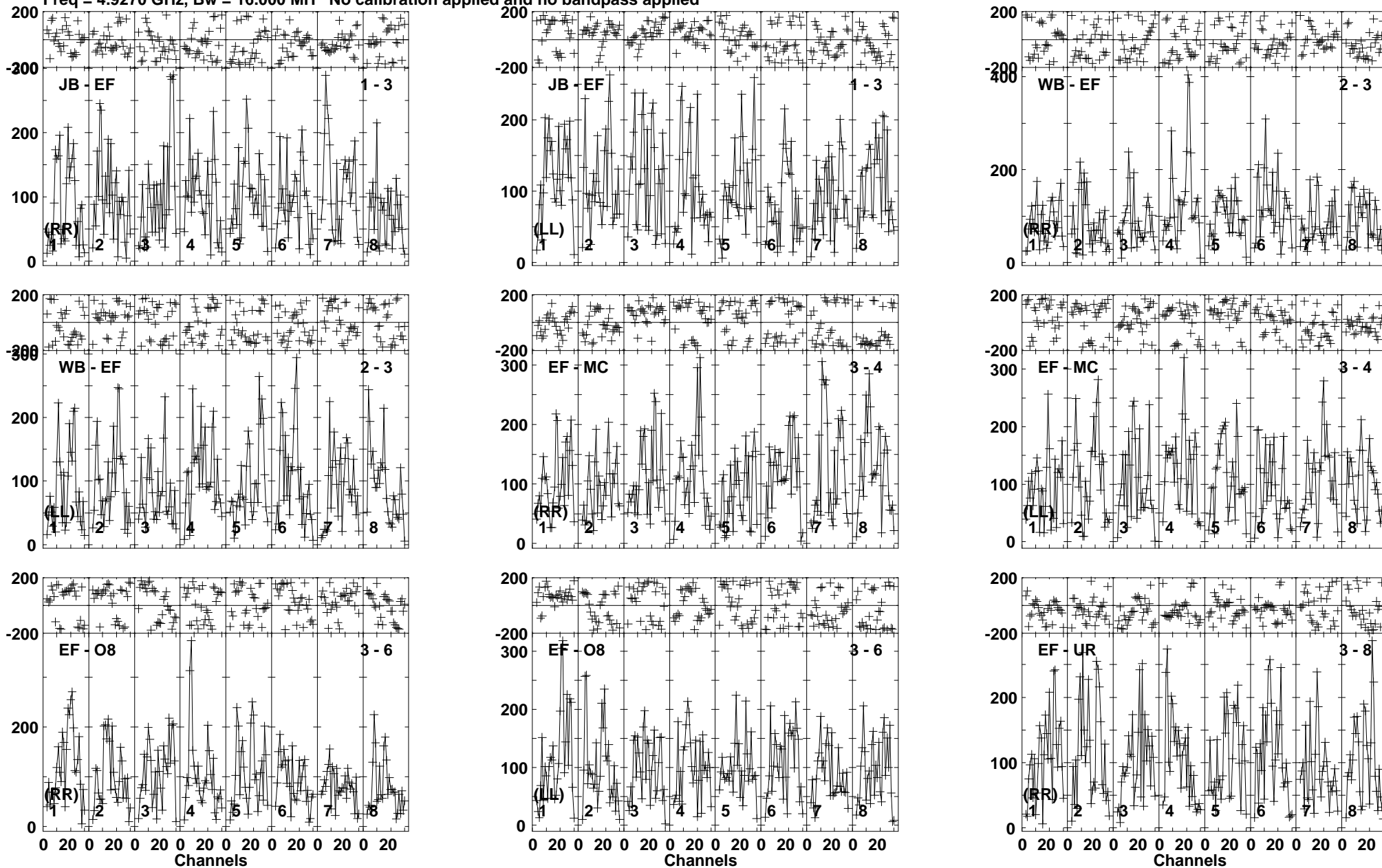

Lower frame: Micro Ampl Jy Top frame: Phas deg  
Vector averaged cross-power spectrum Baseline: JB (01) - EF (03)  
Timerange: 00/08:06:31 to 00/08:09:29

Plot file version 8 created 19-DEC-2018 17:58:14  
AT2018\_RY007C.UVDATA.1

Freq = 4.9270 GHz, Bw = 16.000 MH No calibration applied and no bandpass applied

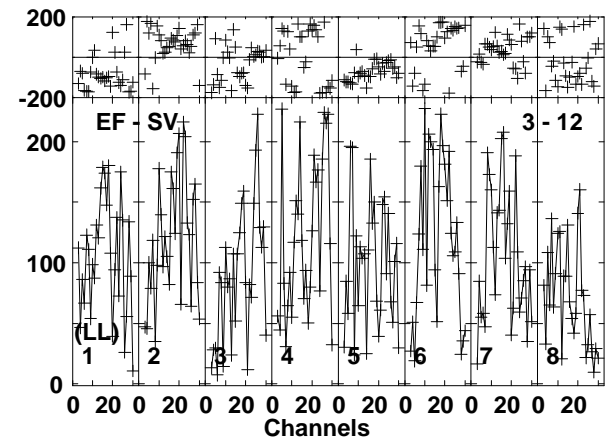
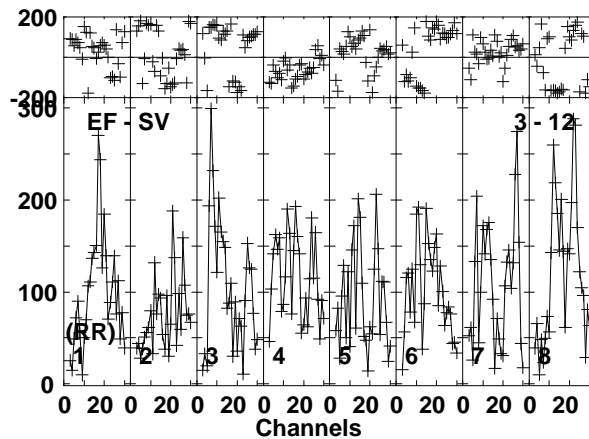
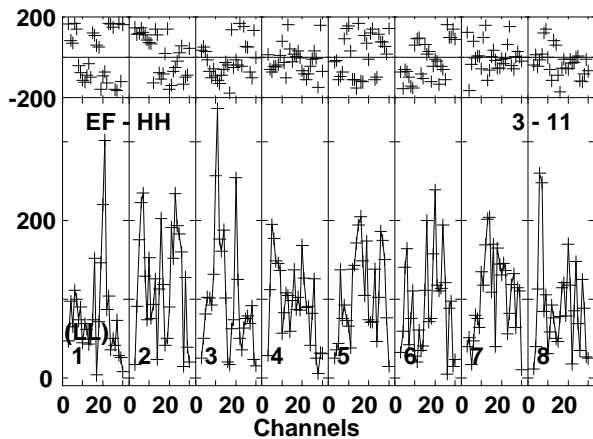
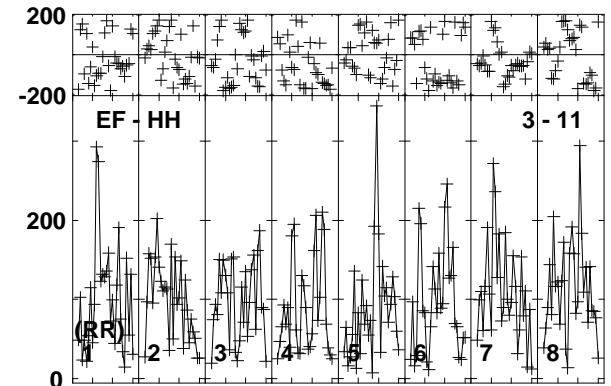
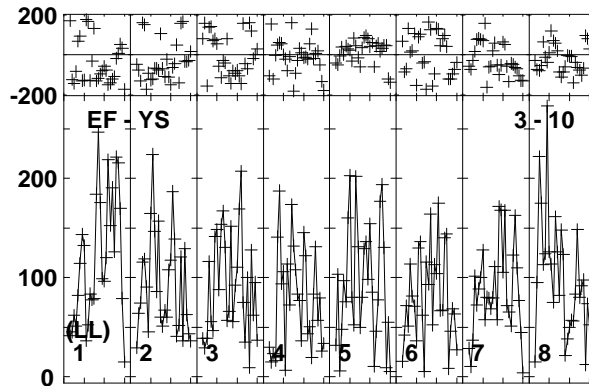
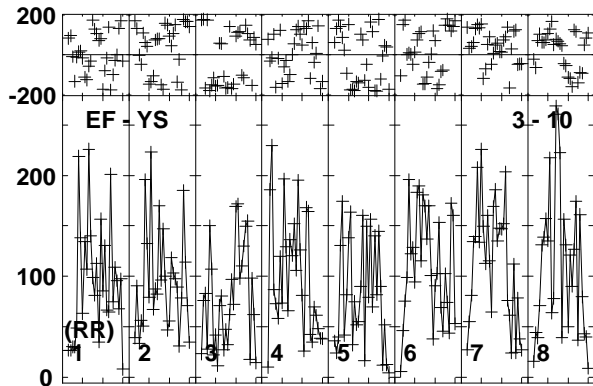
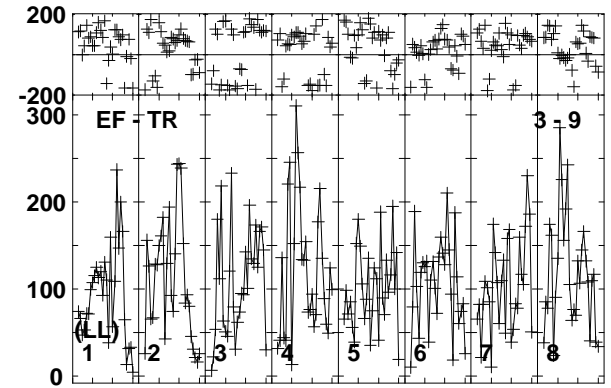
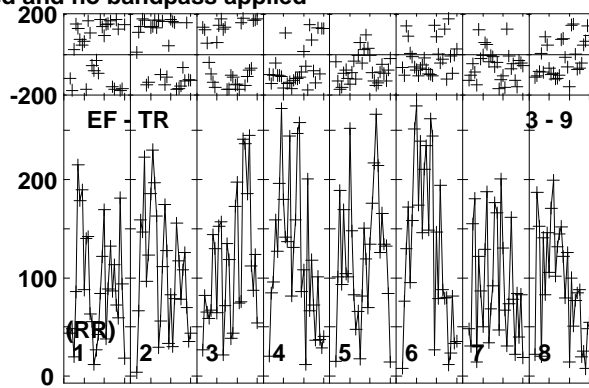
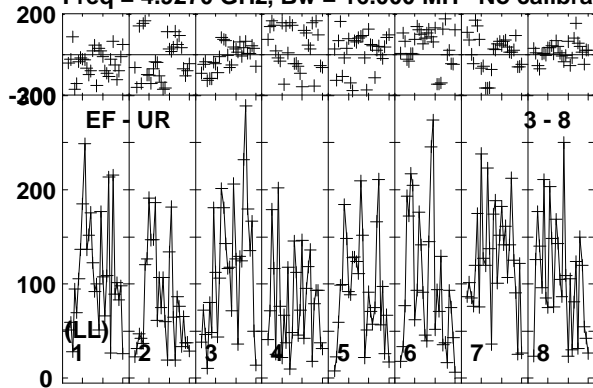

Lower frame: Micro Ampl Jy Top frame: Phas deg  
Vector averaged cross-power spectrum Baseline: EF (03) - UR (08)  
Timerange: 00/08:06:31 to 00/08:09:29

Plot file version 9 created 19-DEC-2018 17:58:14  
AT2018\_RY007C.UVDATA.1

Freq = 4.9270 GHz, Bw = 16.000 MH No calibration applied and no bandpass applied

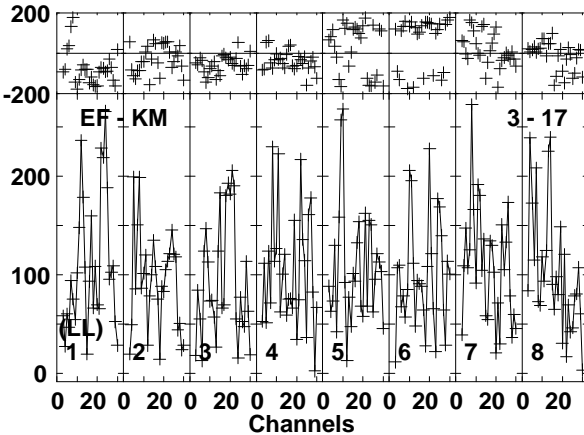
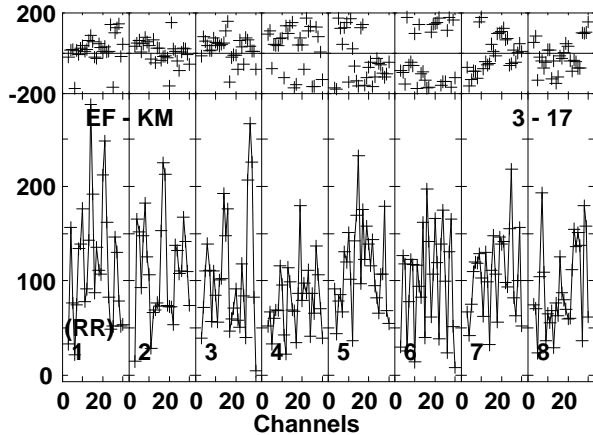
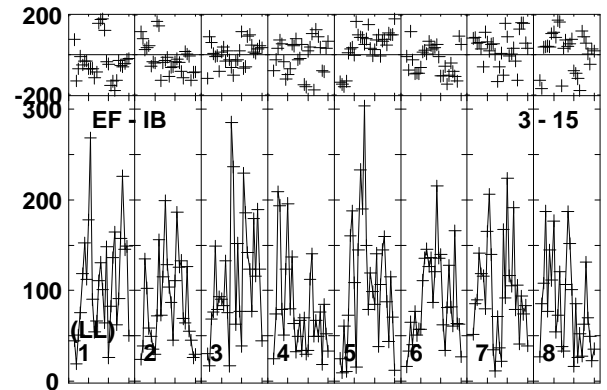
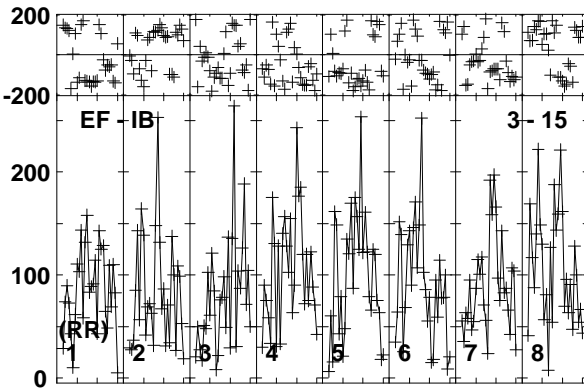
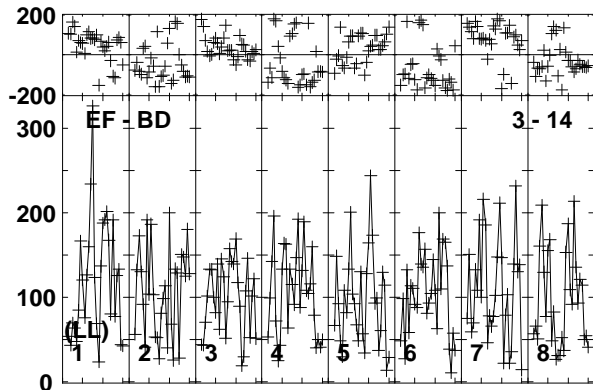
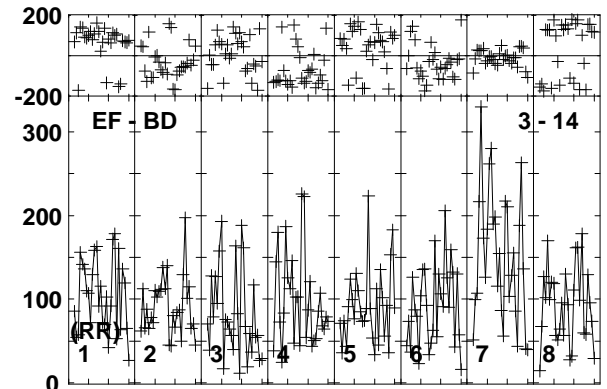
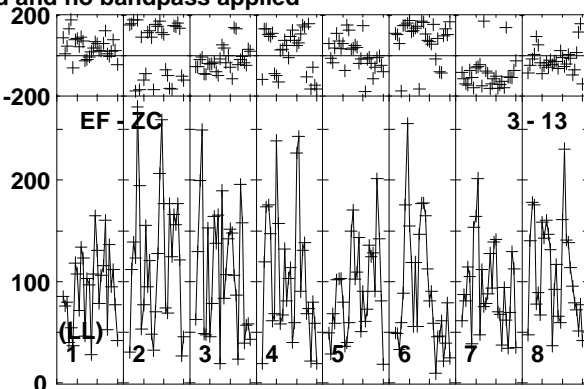
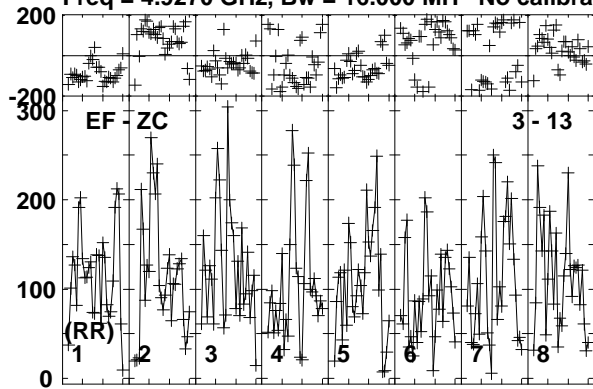

Lower frame: Micro Ampl Jy Top frame: Phas deg  
Vector averaged cross-power spectrum Baseline: EF (03) - ZC (13)  
Timerange: 00/08:06:31 to 00/08:09:29

Plot file version 10 created 19-DEC-2018 17:58:14

J1619+2247 RY007C.UVDATA.1

Freq = 4.9270 GHz, Bw = 16.000 MH No calibration applied and no bandpass applied

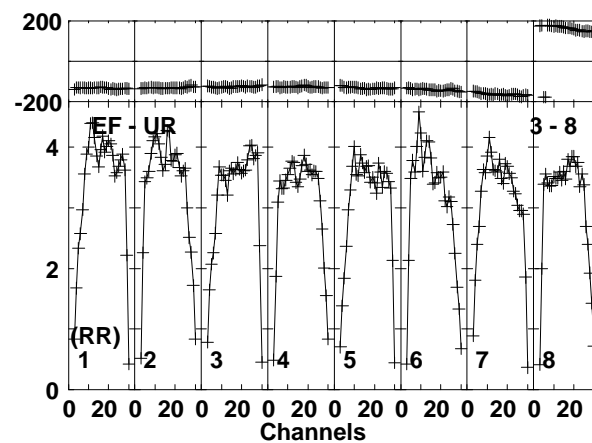
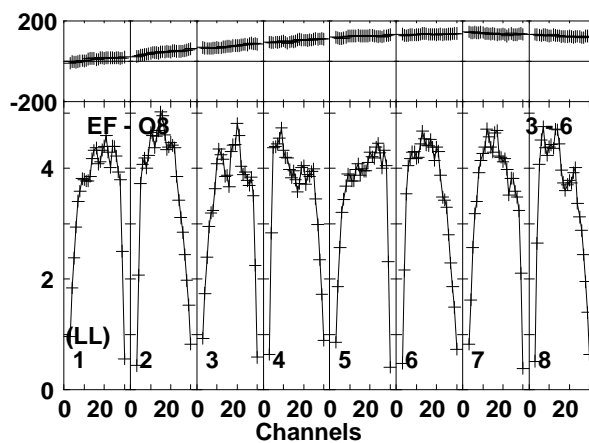
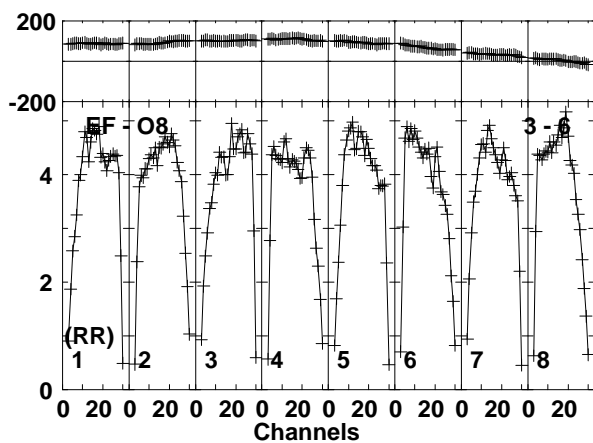
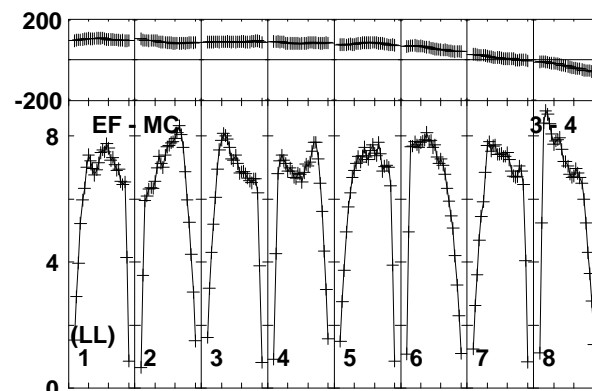
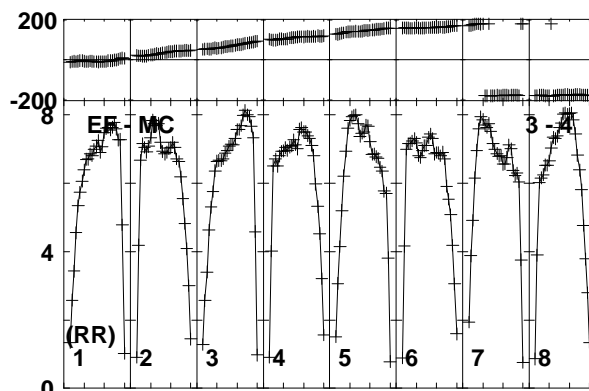
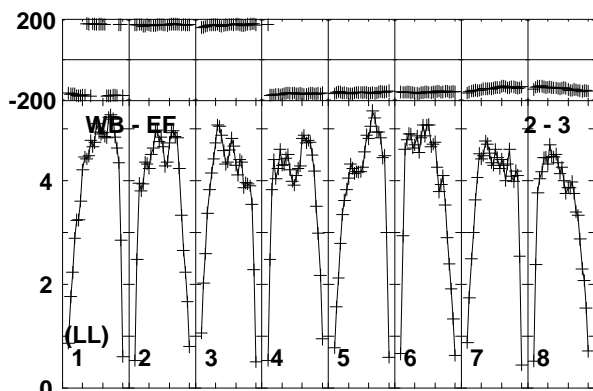
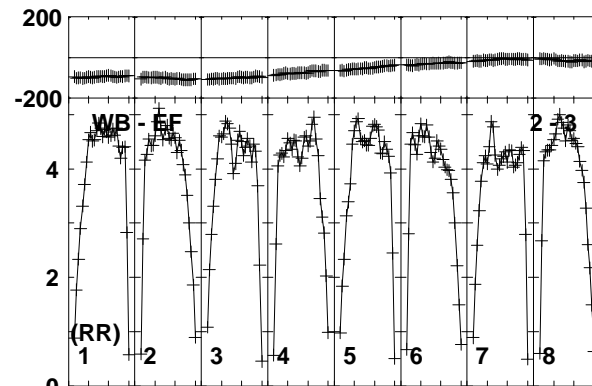
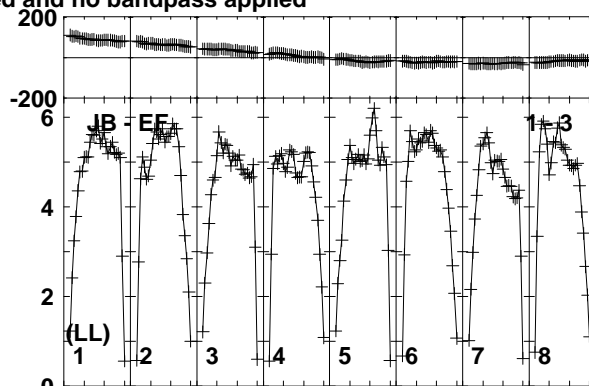
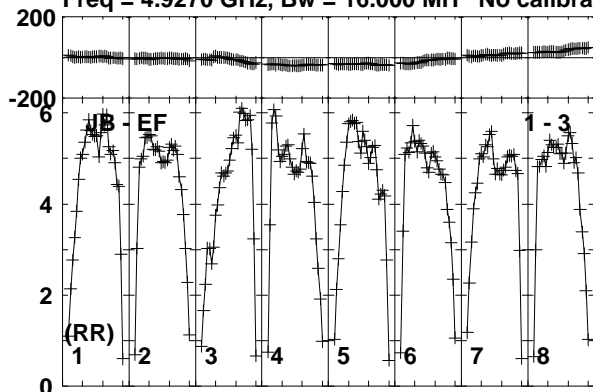

Lower frame: Milli Ampl Jy Top frame: Phas deg  
Vector averaged cross-power spectrum Baseline: JB (01) - EF (03)  
Timerange: 00/08:09:31 to 00/08:10:29



Plot file version 11 created 19-DEC-2018 17:58:14

J1619+2247 RY007C.UVDATA.1

Freq = 4.9270 GHz, Bw = 16.000 MH No calibration applied and no bandpass applied

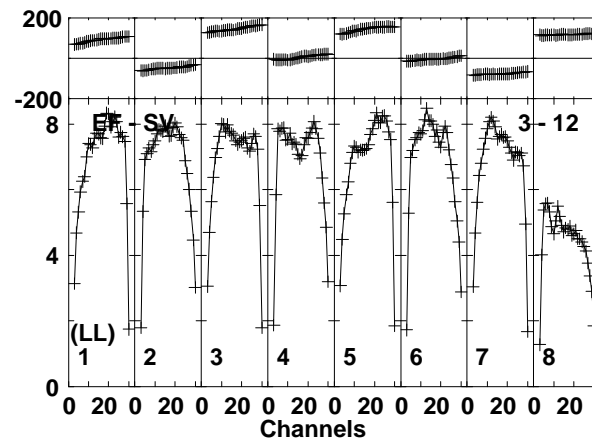
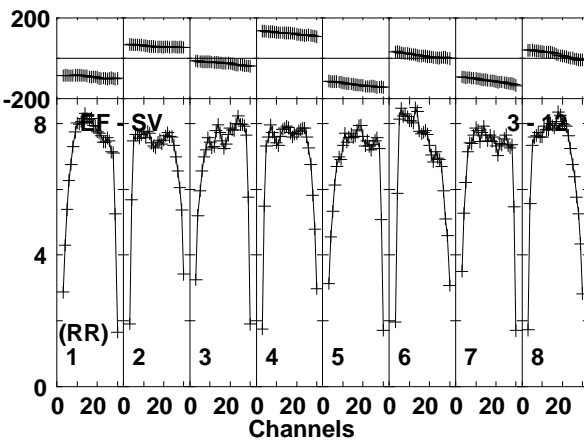
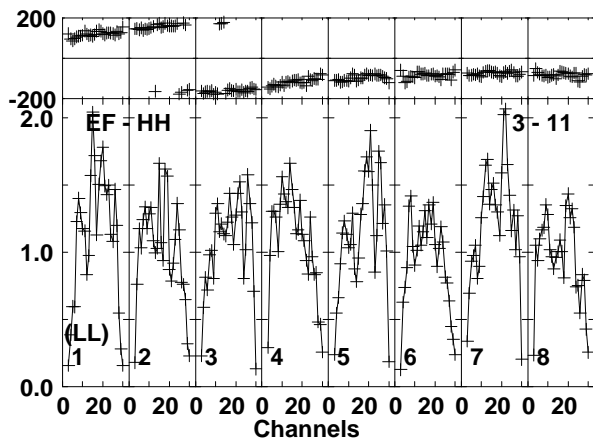
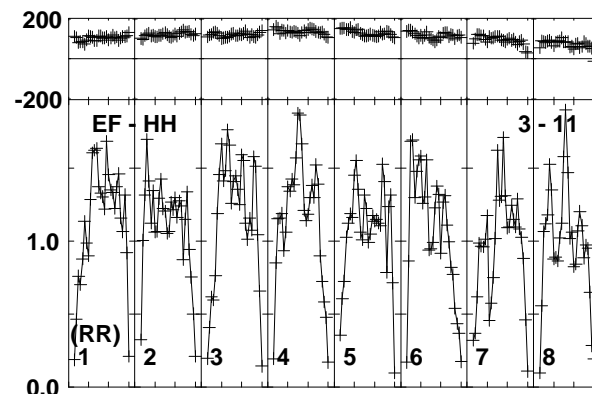
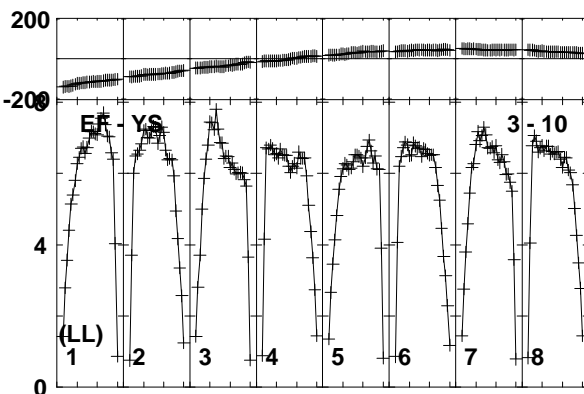
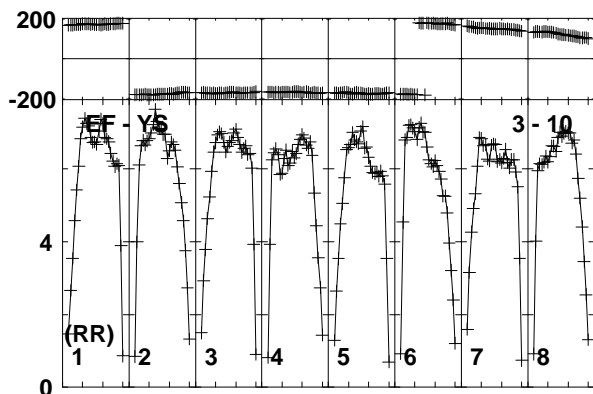
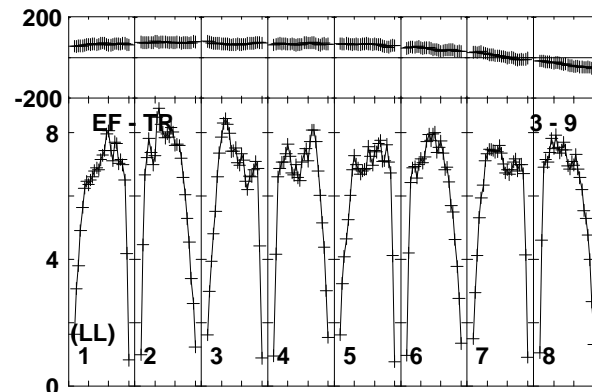
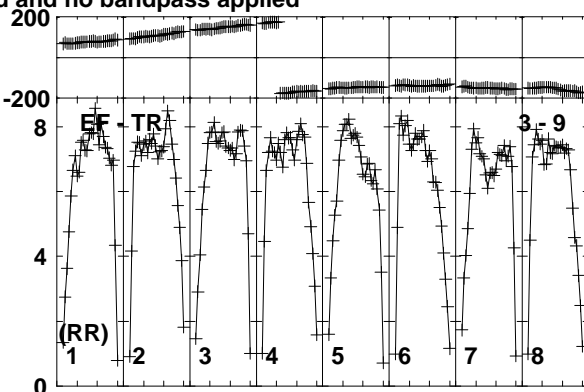
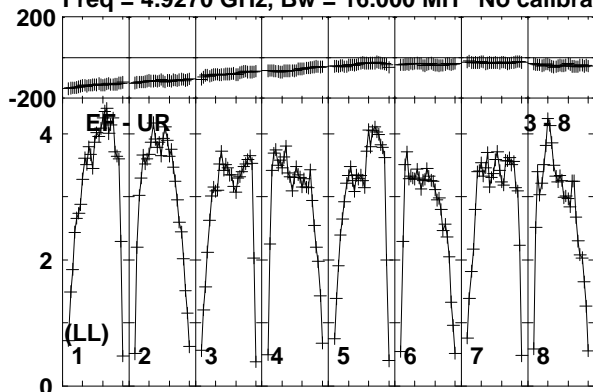

Lower frame: Milli Ampl Jy Top frame: Phas deg  
Vector averaged cross-power spectrum Baseline: EF (03) - UR (08)  
Timerange: 00/08:09:31 to 00/08:10:29

Plot file version 12 created 19-DEC-2018 17:58:14

J1619+2247 RY007C.UVDATA.1

Freq = 4.9270 GHz, Bw = 16.000 MH No calibration applied and no bandpass applied

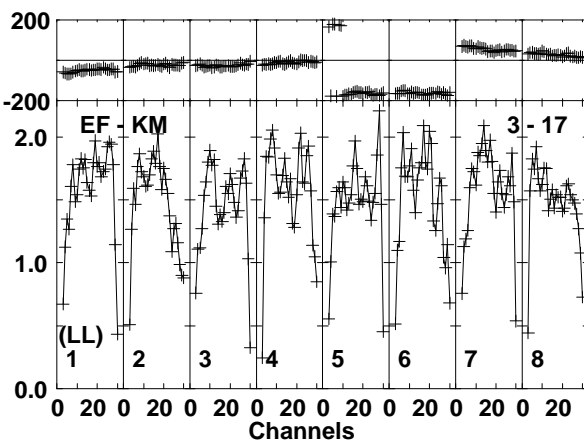
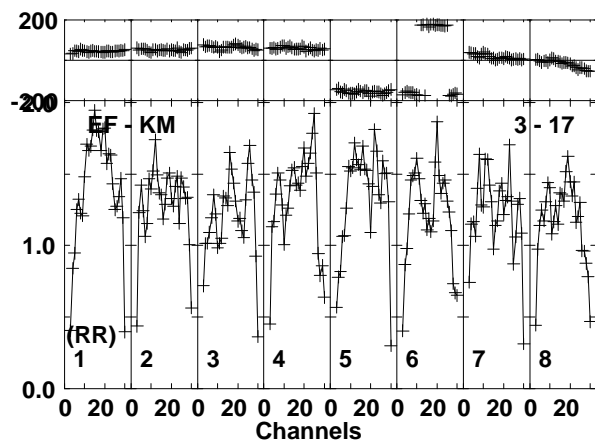
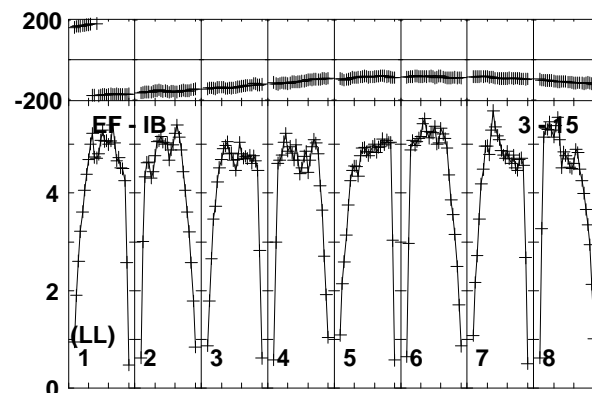
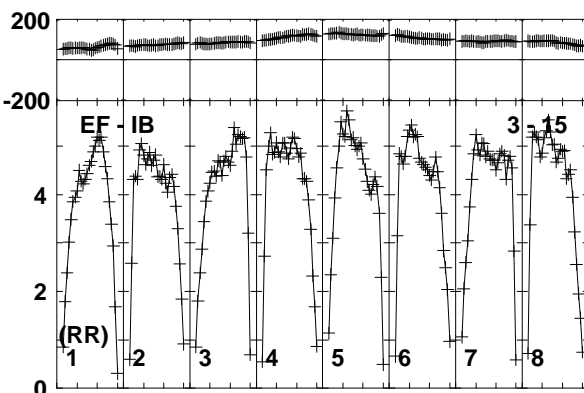
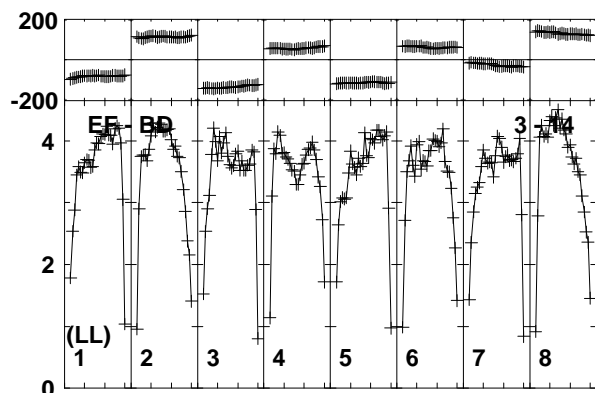
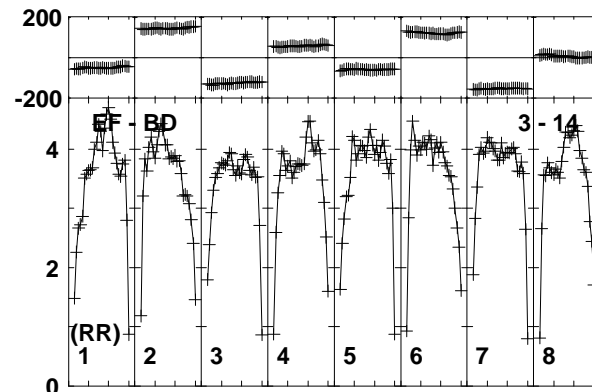
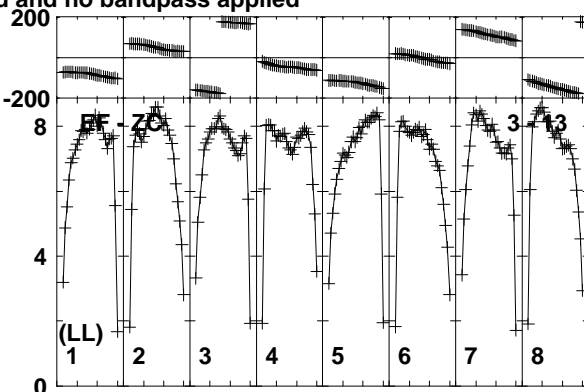
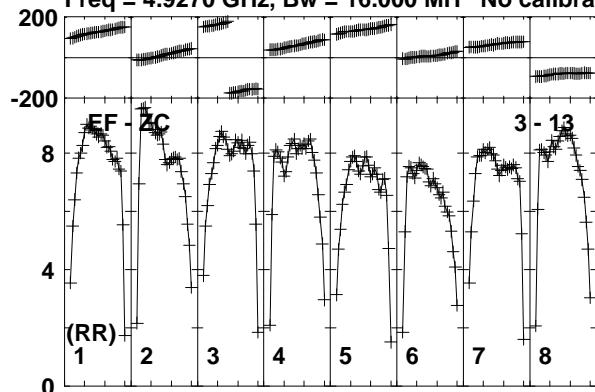

Lower frame: Milli Ampl Jy Top frame: Phas deg  
Vector averaged cross-power spectrum Baseline: EF (03) - ZC (13)  
Timerange: 00/08:09:31 to 00/08:10:29

Plot file version 13 created 19-DEC-2018 17:58:14

AT2018\_RY007C.UVDATA.1

Freq = 4.9270 GHz, Bw = 16.000 MH No calibration applied and no bandpass applied

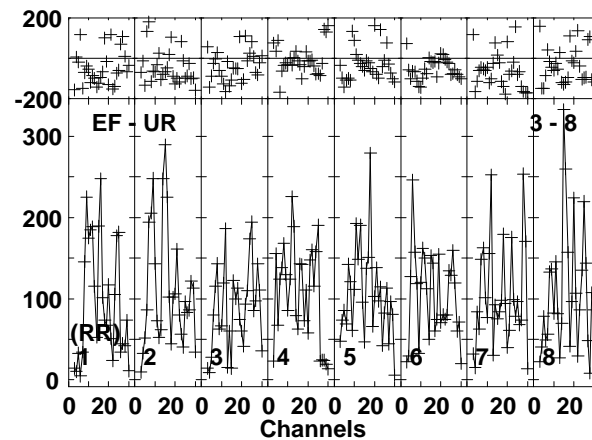
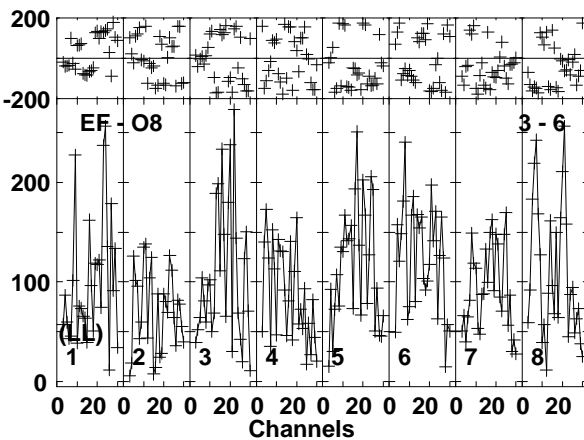
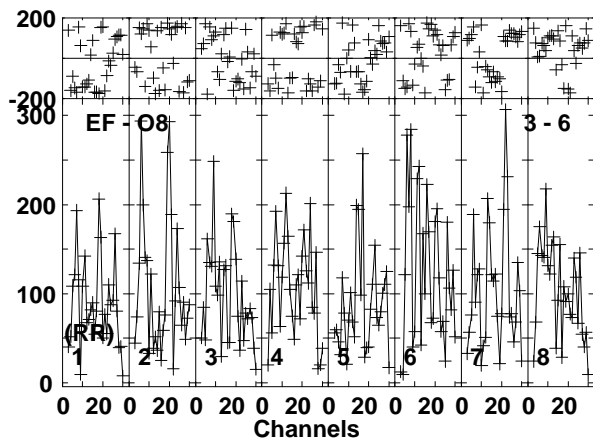
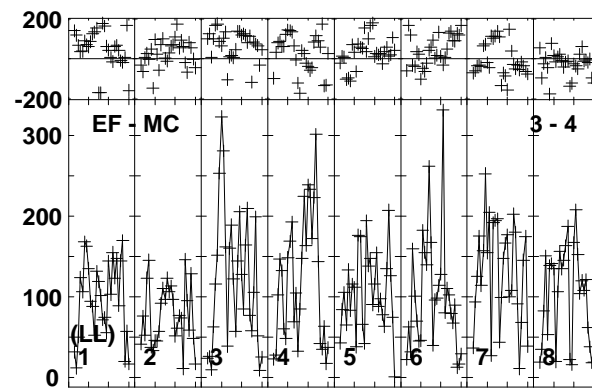
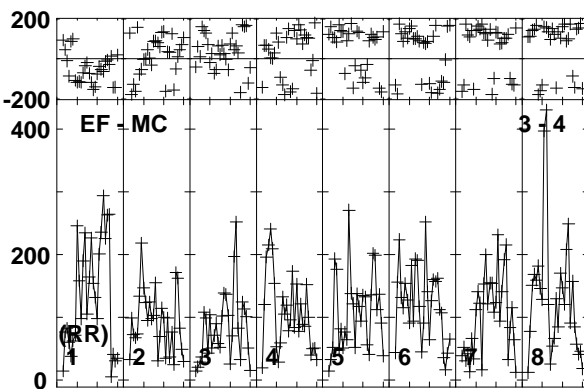
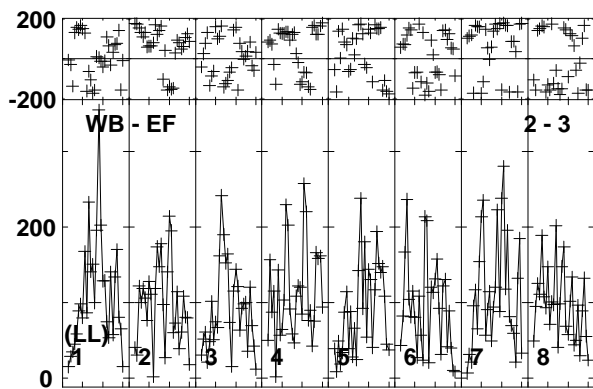
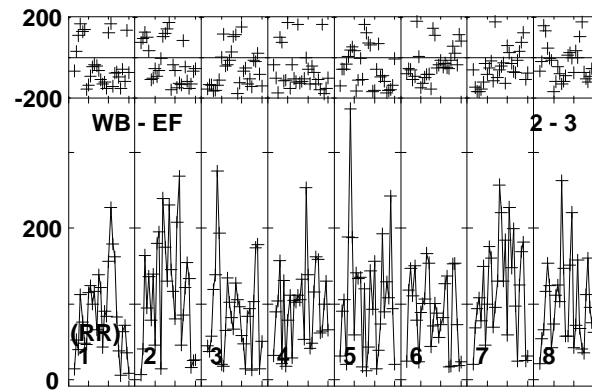
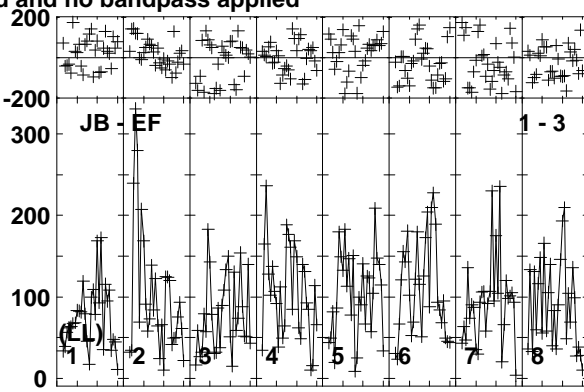
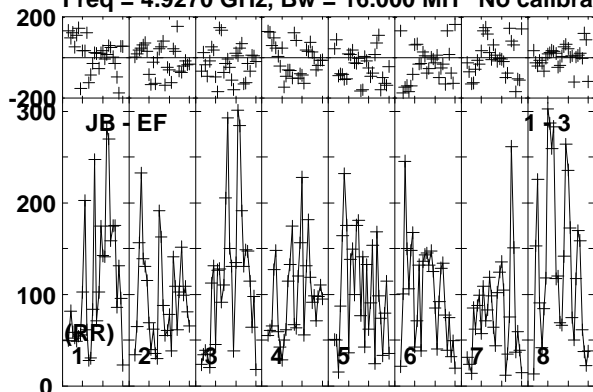

Lower frame: Micro Ampl Jy Top frame: Phas deg  
Vector averaged cross-power spectrum Baseline: JB (01) - EF (03)  
Timerange: 00/08:10:31 to 00/08:13:29

Plot file version 14 created 19-DEC-2018 17:58:14  
 AT2018\_RY007C.UVDATA.1

Freq = 4.9270 GHz, Bw = 16.000 MH No calibration applied and no bandpass applied

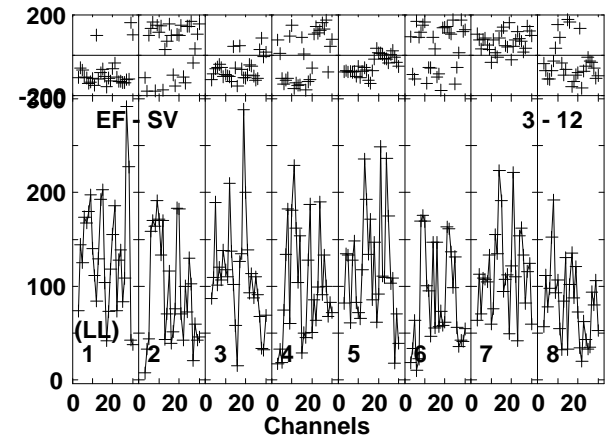
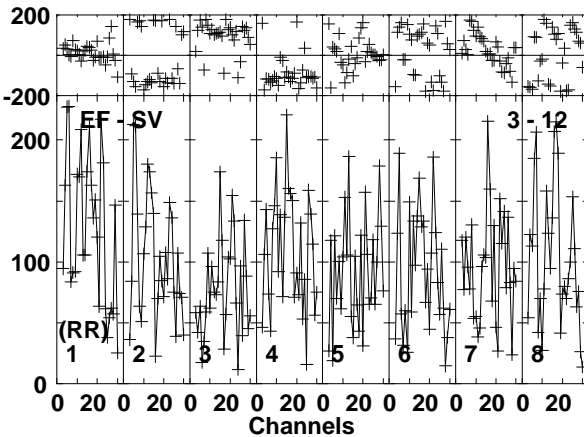
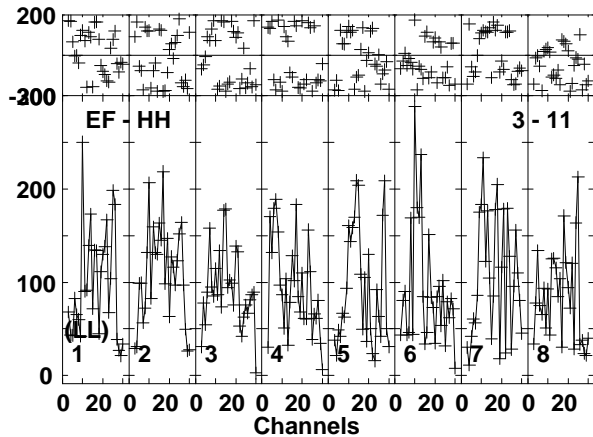
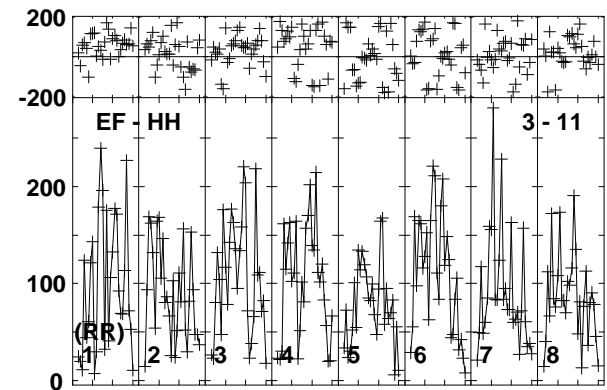
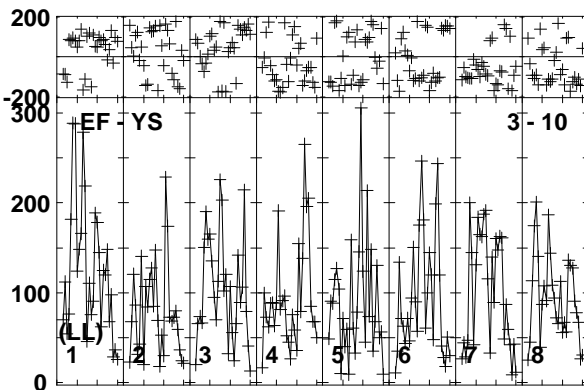
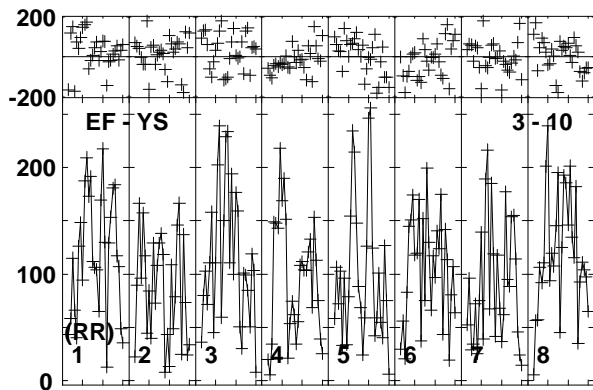
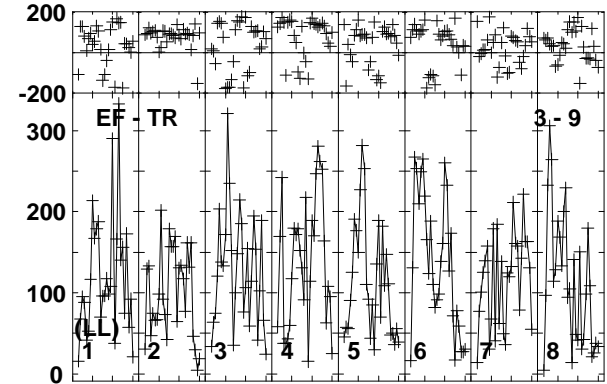
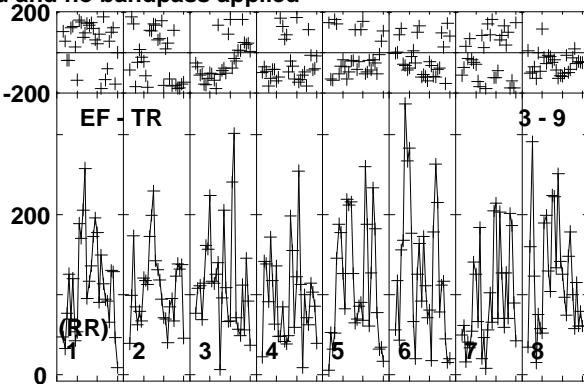
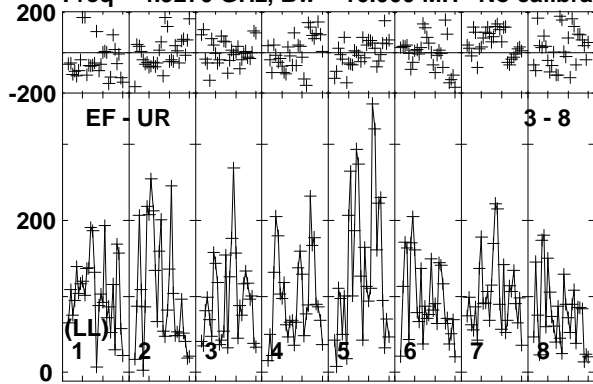

Lower frame: Micro Ampl Jy Top frame: Phas deg  
 Vector averaged cross-power spectrum Baseline: EF (03) - UR (08)  
 Timerange: 00/08:10:31 to 00/08:13:29

Plot file version 15 created 19-DEC-2018 17:58:14

AT2018\_RY007C.UVDATA.1

Freq = 4.9270 GHz, Bw = 16.000 MH No calibration applied and no bandpass applied

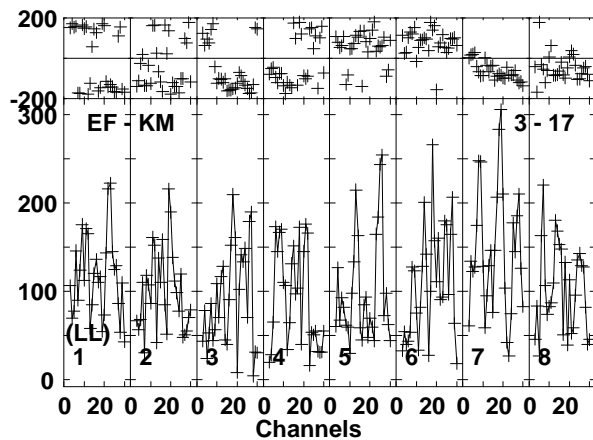
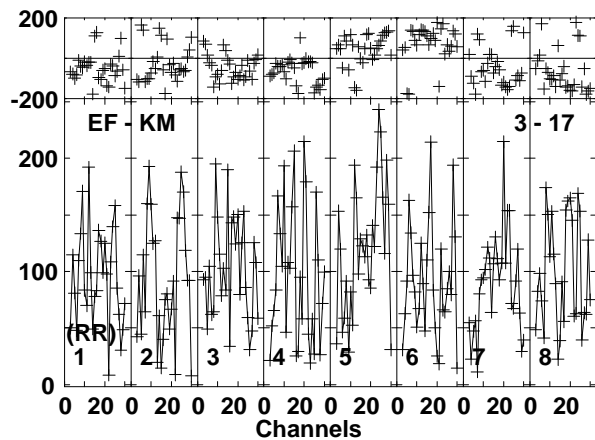
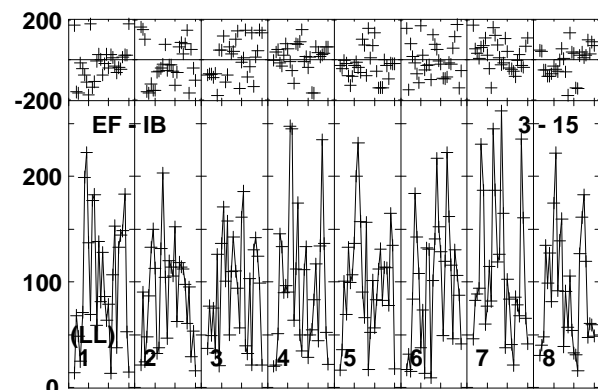
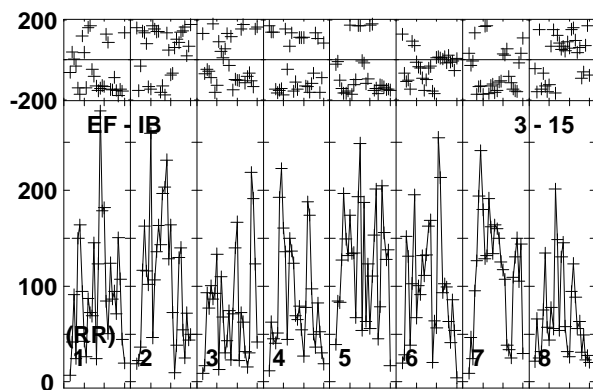
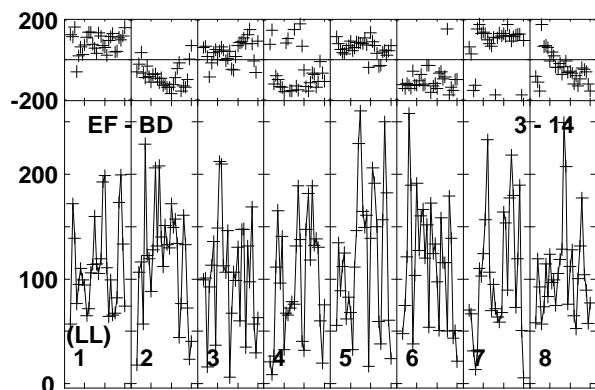
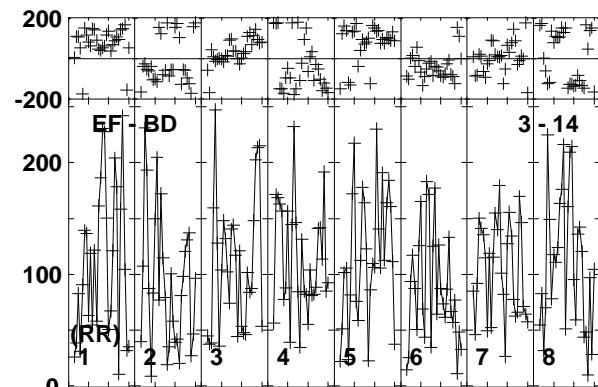
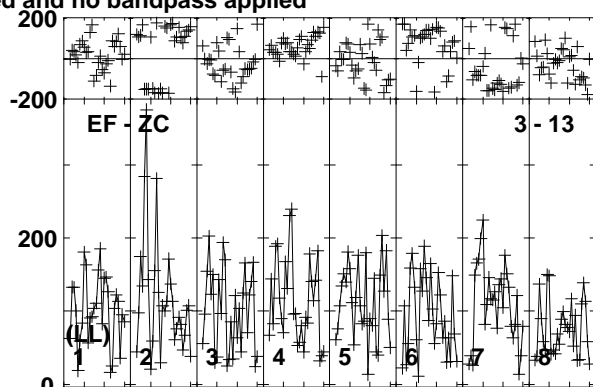
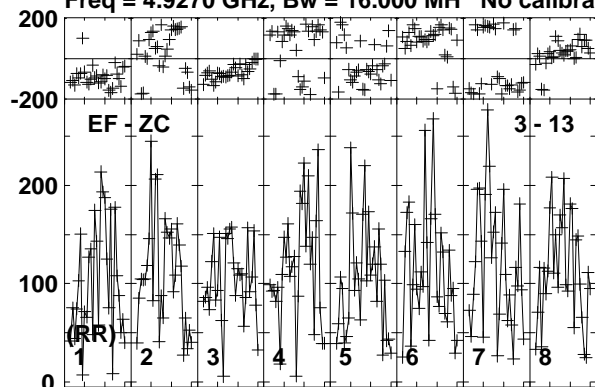

Lower frame: Micro Ampl Jy Top frame: Phas deg  
Vector averaged cross-power spectrum Baseline: EF (03) - ZC (13)  
Timerange: 00/08:10:31 to 00/08:13:29

Plot file version 16 created 19-DEC-2018 17:58:14

J1619+2247 RY007C.UVDATA.1

Freq = 4.9270 GHz, Bw = 16.000 MH No calibration applied and no bandpass applied

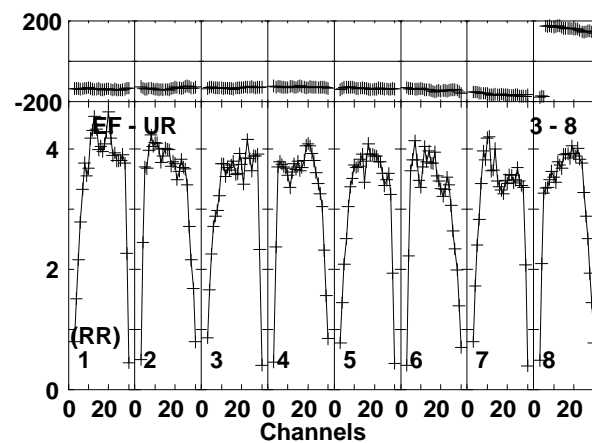
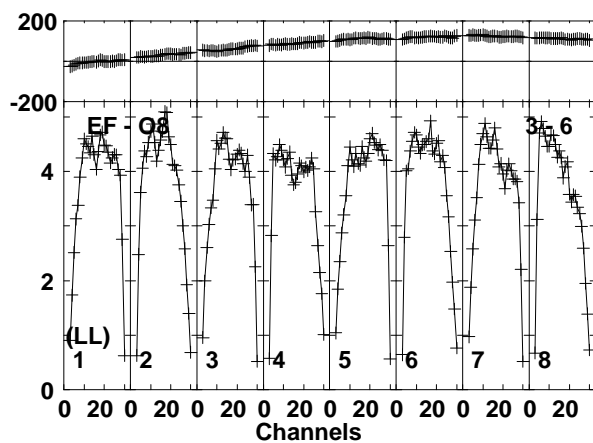
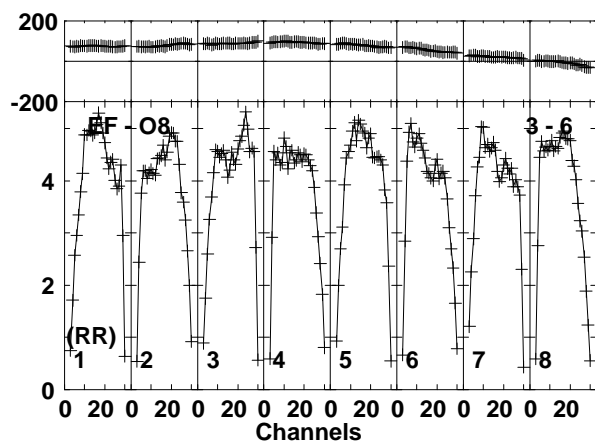
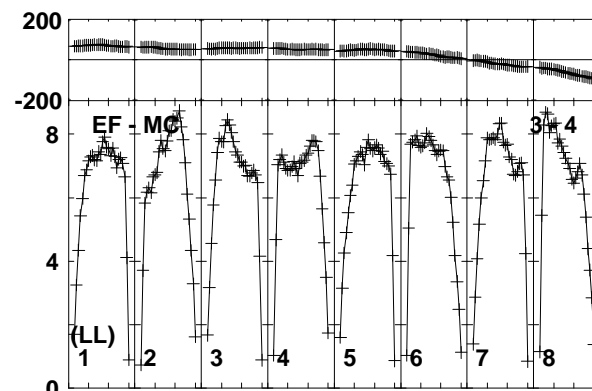
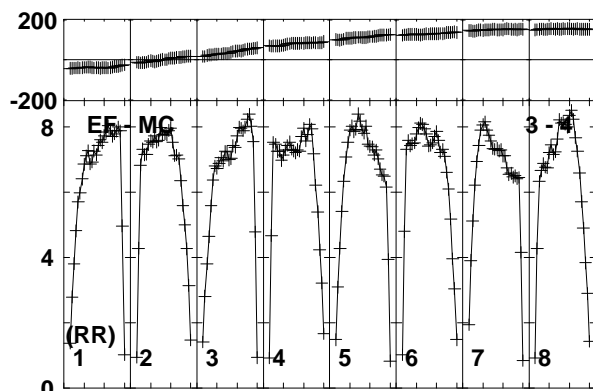
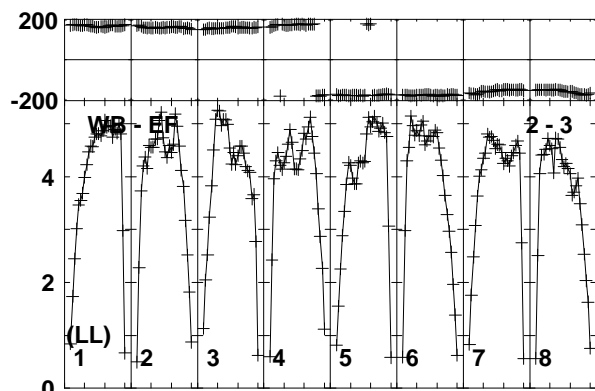
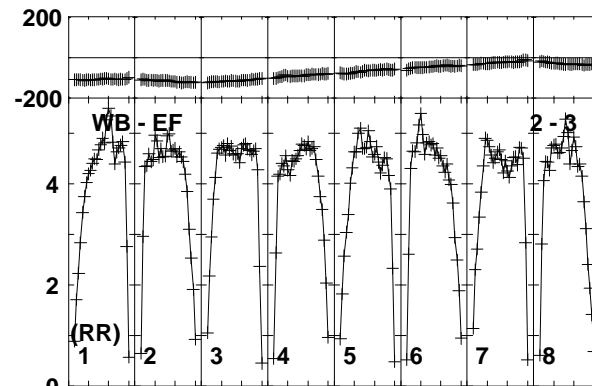
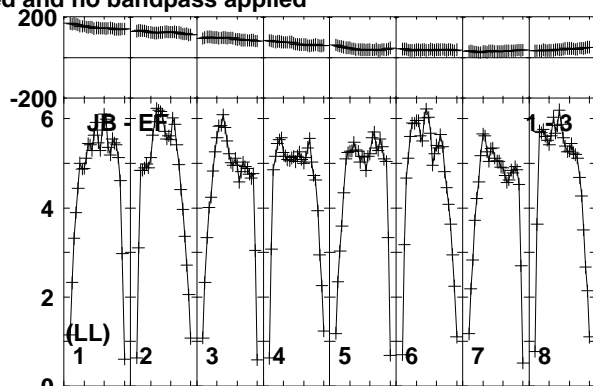
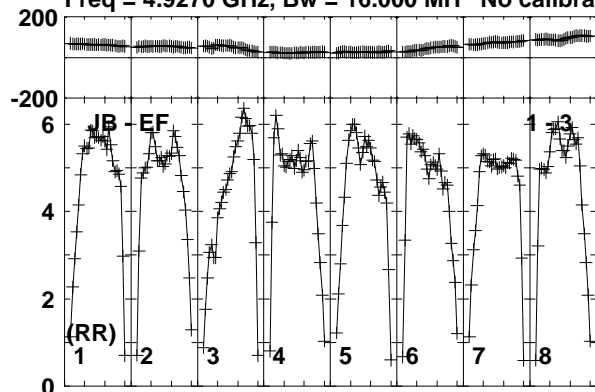

Lower frame: Milli Ampl Jy Top frame: Phas deg  
Vector averaged cross-power spectrum Baseline: JB (01) - EF (03)  
Timerange: 00/08:13:31 to 00/08:14:29

Plot file version 17 created 19-DEC-2018 17:58:14

J1619+2247 RY007C.UVDATA.1

Freq = 4.9270 GHz, Bw = 16.000 MH No calibration applied and no bandpass applied

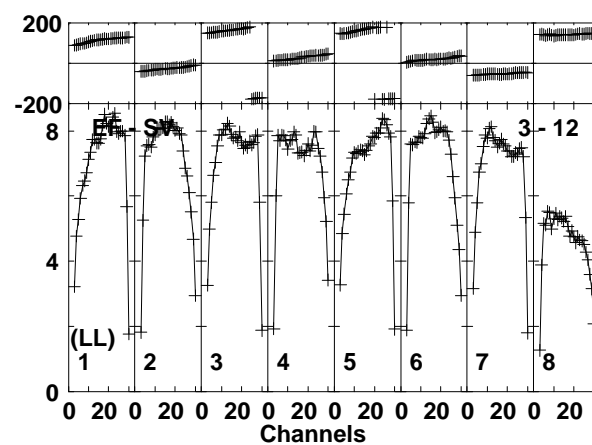
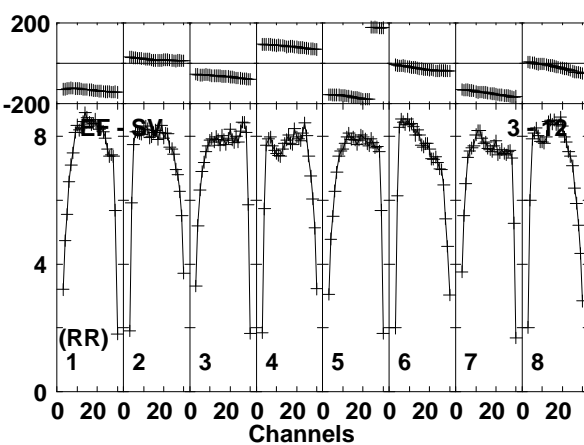
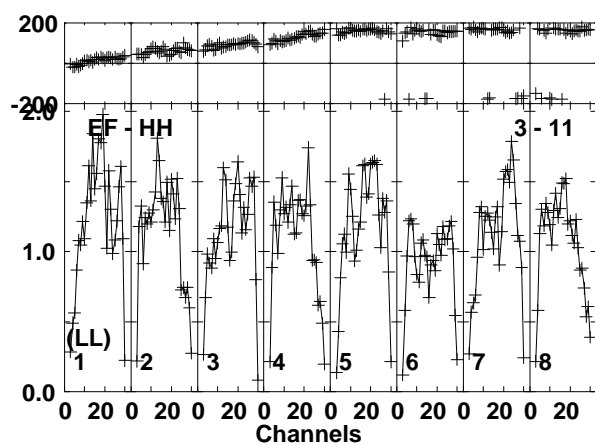
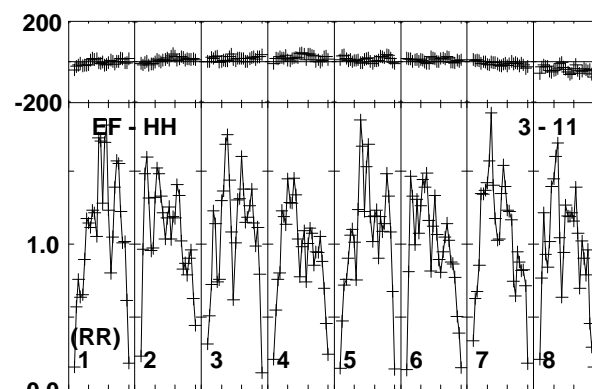
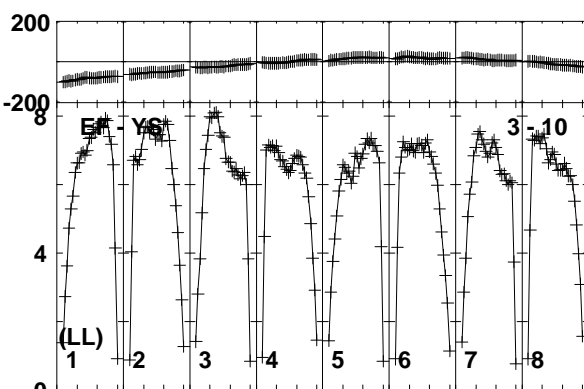
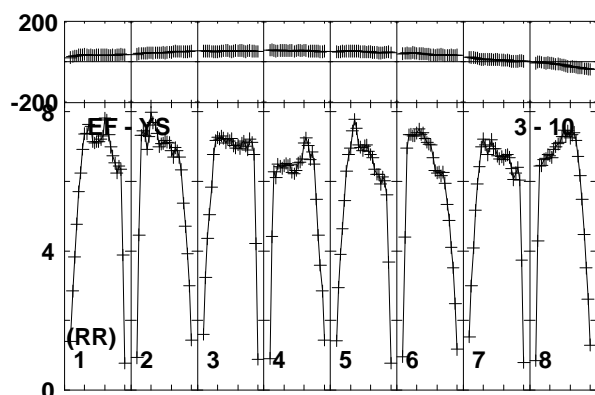
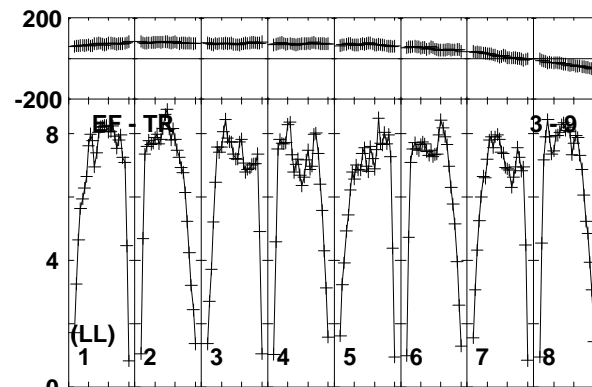
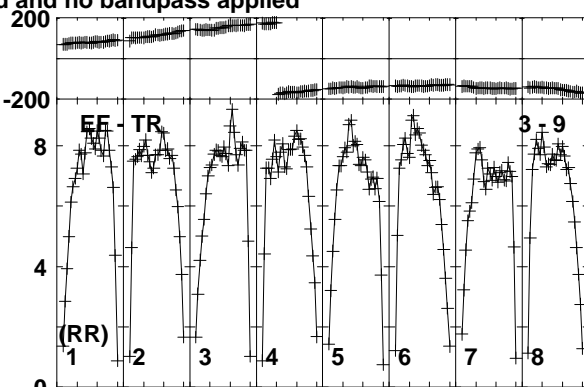
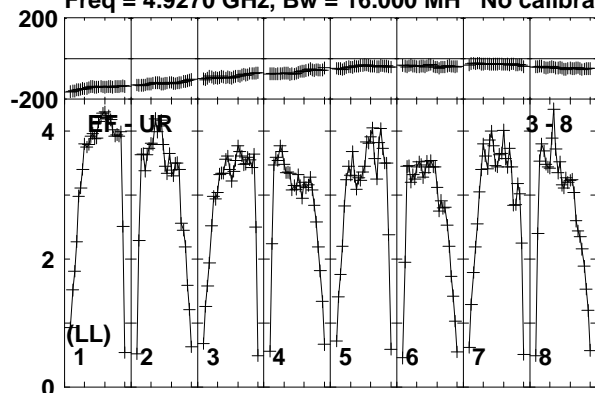

Lower frame: Milli Ampl Jy Top frame: Phas deg  
Vector averaged cross-power spectrum Baseline: EF (03) - UR (08)  
Timerange: 00/08:13:31 to 00/08:14:29

Plot file version 18 created 19-DEC-2018 17:58:14

J1619+2247 RY007C.UVDATA.1

Freq = 4.9270 GHz, Bw = 16.000 MH No calibration applied and no bandpass applied

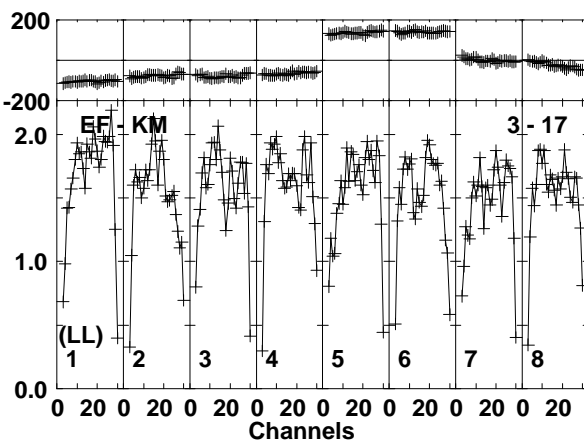
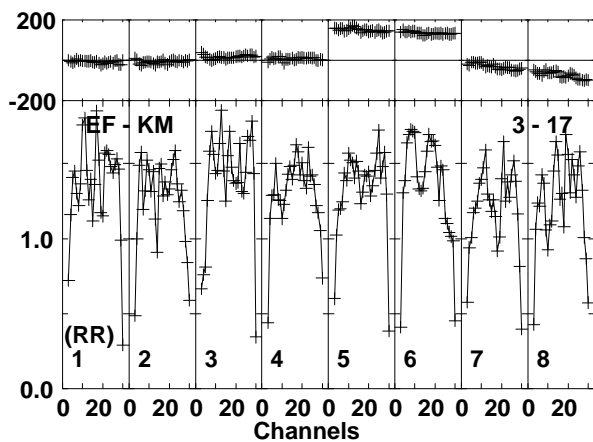
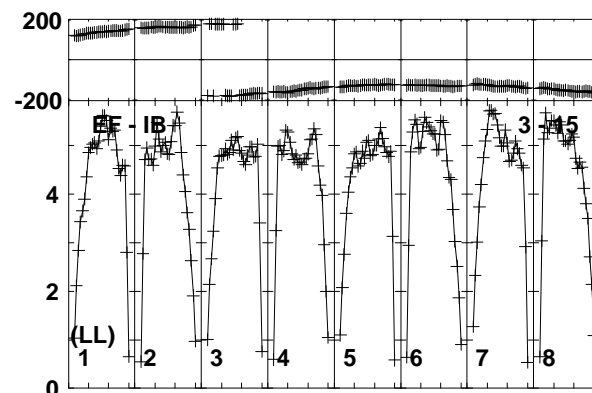
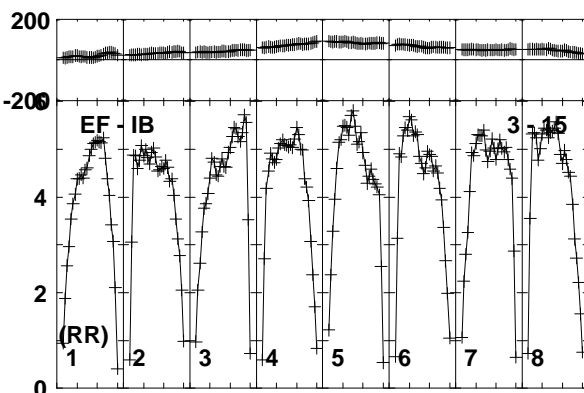
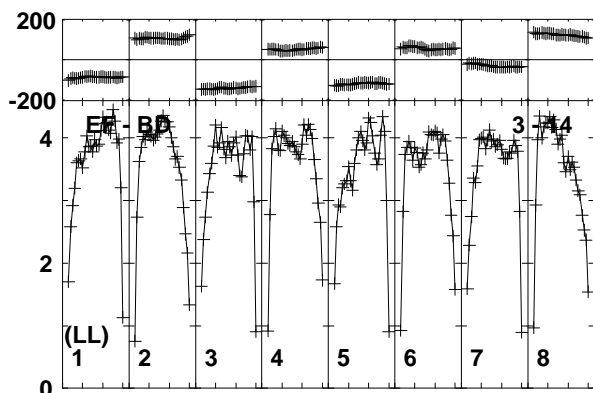
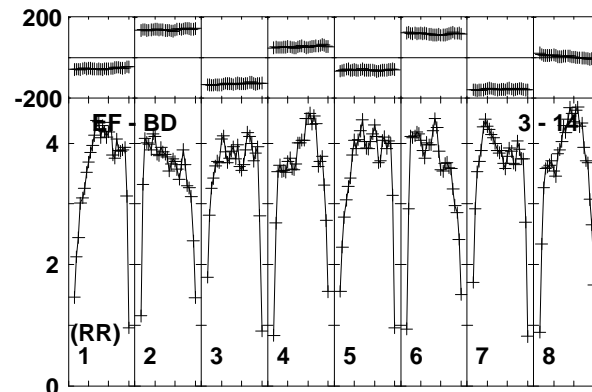
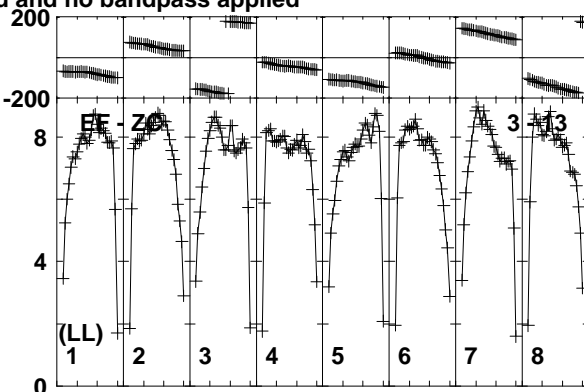
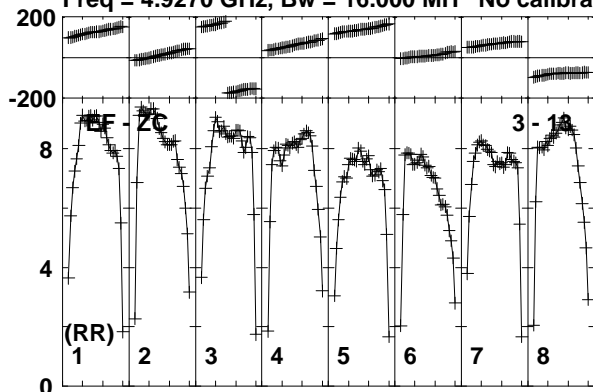

Lower frame: Milli Ampl Jy Top frame: Phas deg  
Vector averaged cross-power spectrum Baseline: EF (03) - ZC (13)  
Timerange: 00/08:13:31 to 00/08:14:29



Plot file version 19 created 19-DEC-2018 17:58:14

VLA1 RY007C.UVDATA.1

Freq = 4.9270 GHz, Bw = 16.000 MH No calibration applied and no bandpass applied

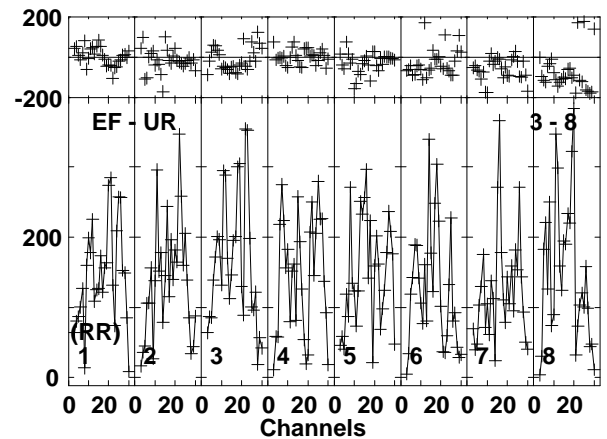
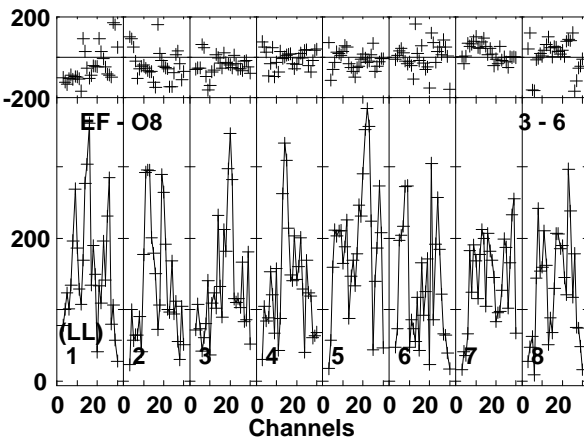
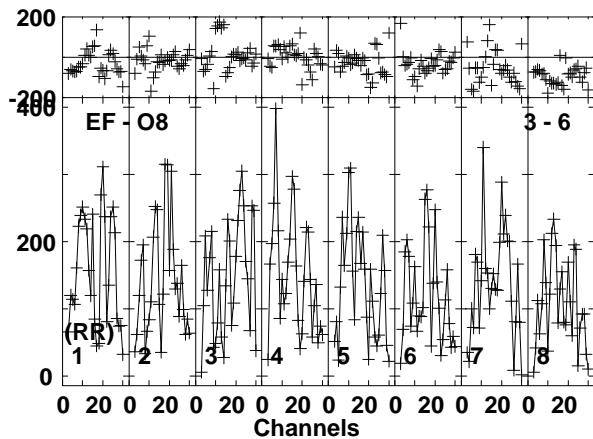
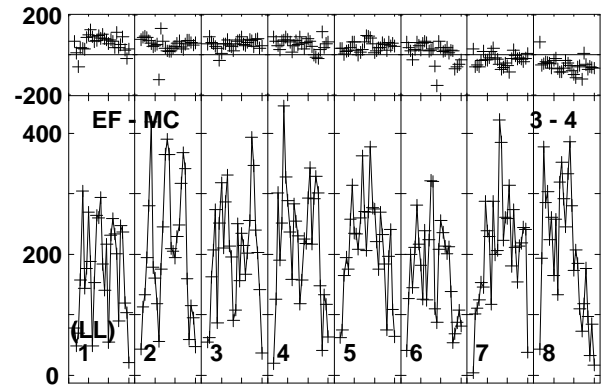
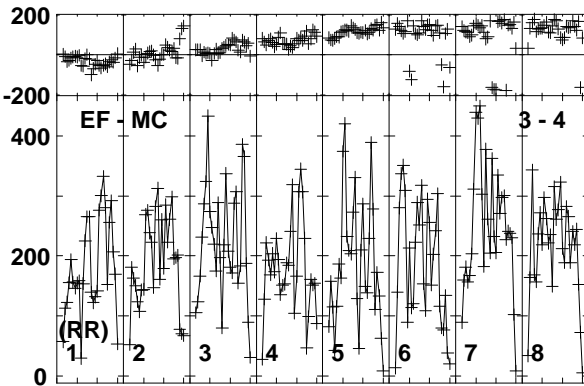
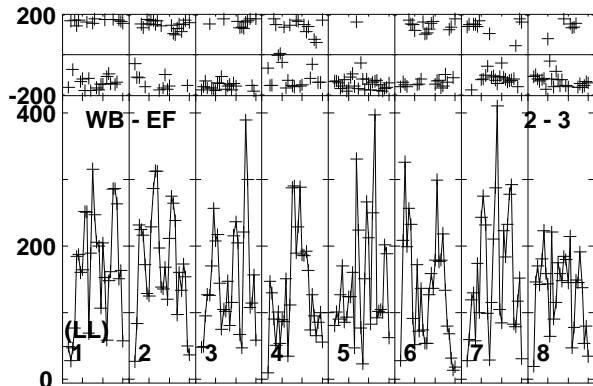
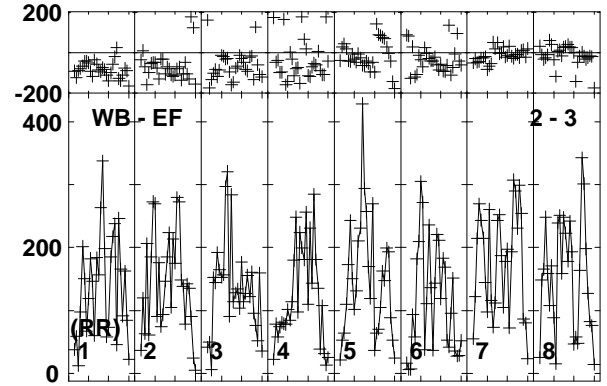
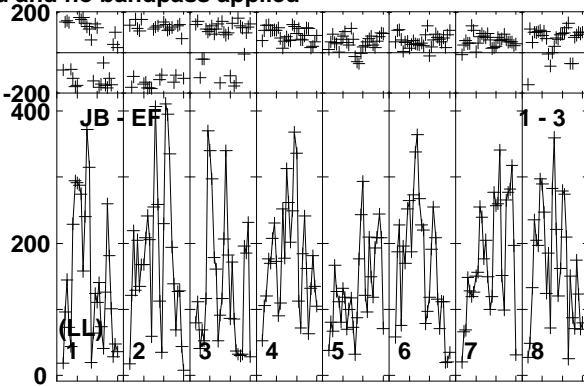
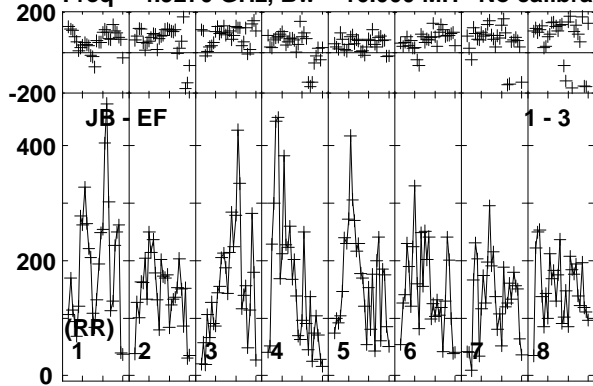

Lower frame: Micro Ampl Jy Top frame: Phas deg  
Vector averaged cross-power spectrum Baseline: JB (01) - EF (03)  
Timerange: 00/08:15:01 to 00/08:16:59

Plot file version 20 created 19-DEC-2018 17:58:14

VLA1 RY007C.UVDATA.1

Freq = 4.9270 GHz, Bw = 16.000 MH No calibration applied and no bandpass applied

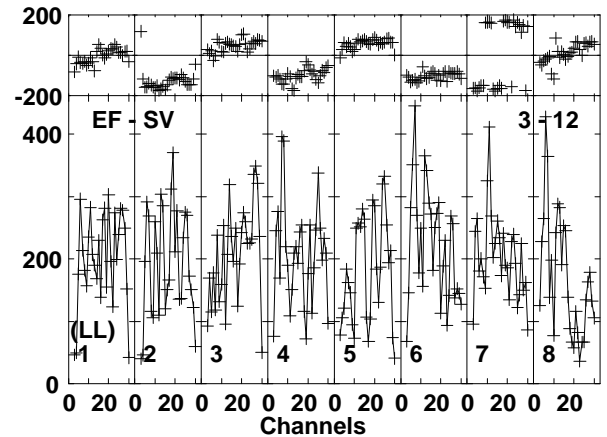
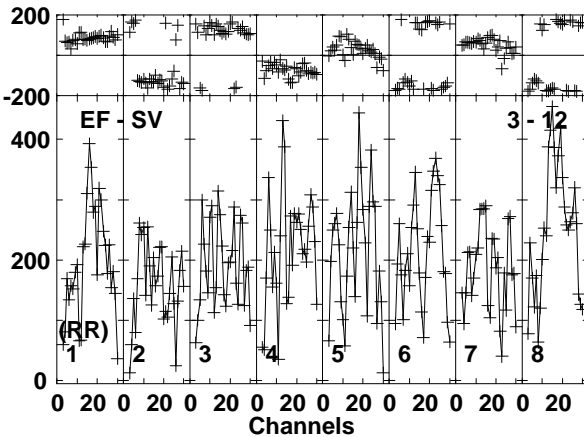
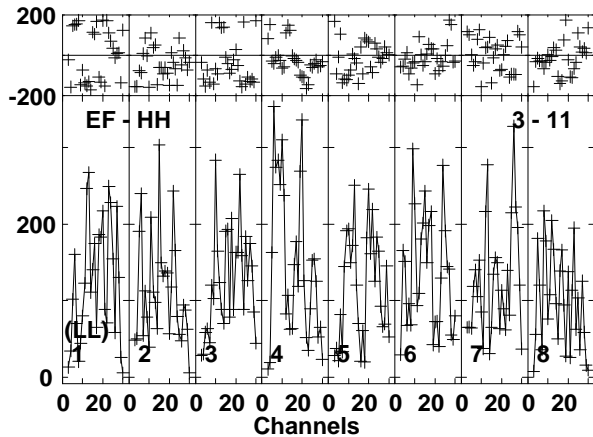
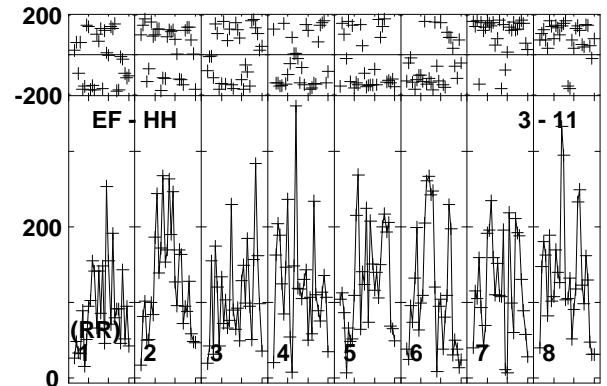
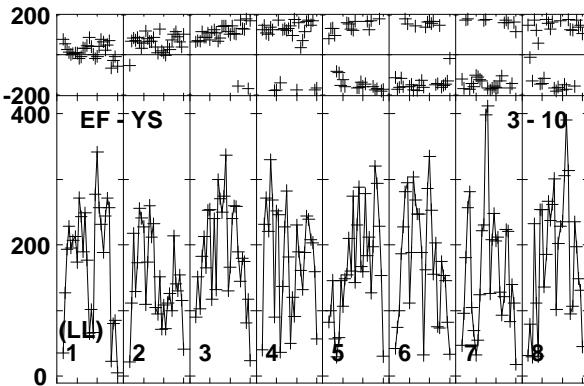
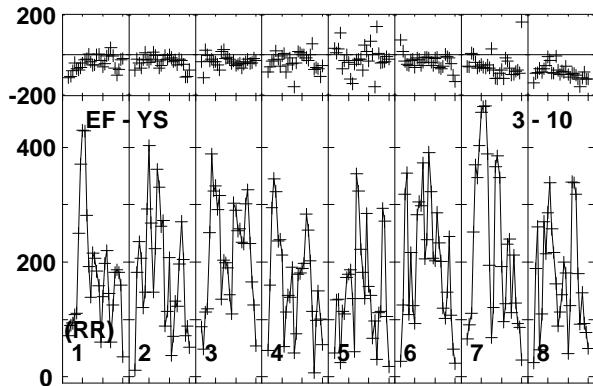
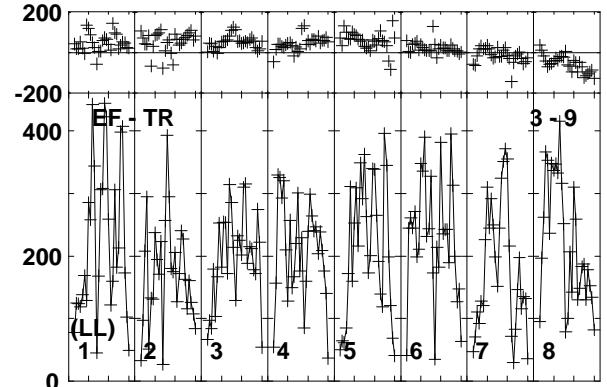
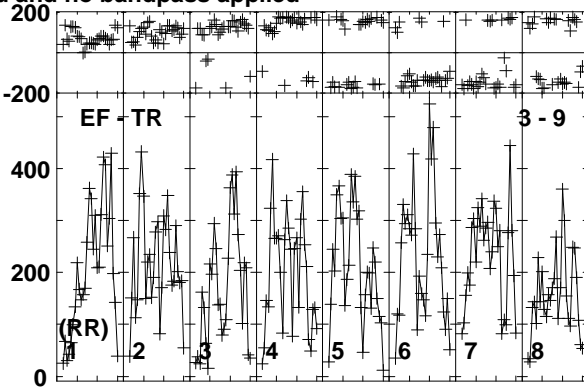
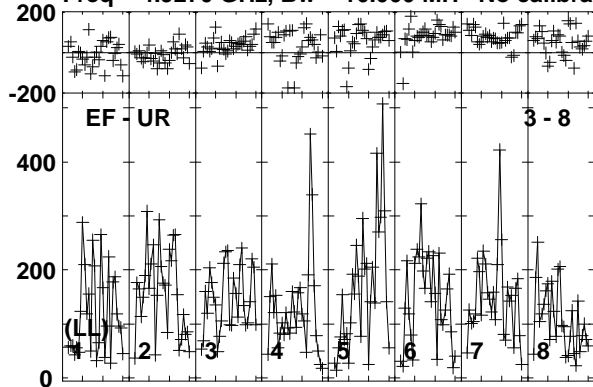

Lower frame: Micro Ampl Jy Top frame: Phas deg  
Vector averaged cross-power spectrum Baseline: EF (03) - UR (08)  
Timerange: 00/08:15:01 to 00/08:16:59

Plot file version 21 created 19-DEC-2018 17:58:14

VLA1 RY007C.UVDATA.1

Freq = 4.9270 GHz, Bw = 16.000 MH No calibration applied and no bandpass applied

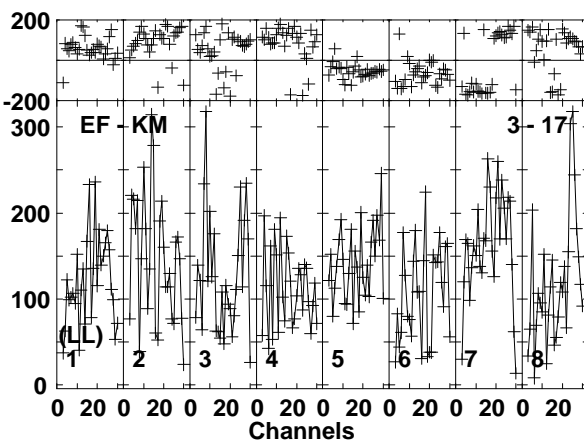
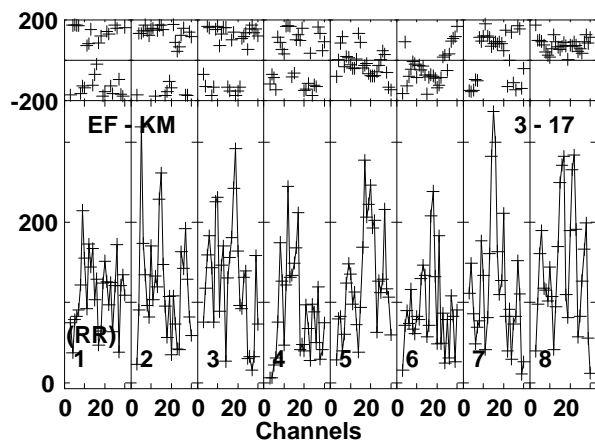
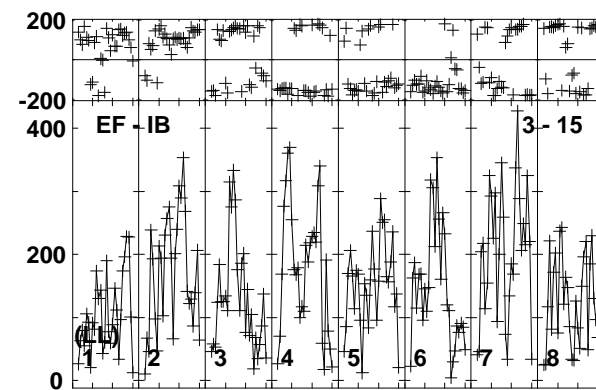
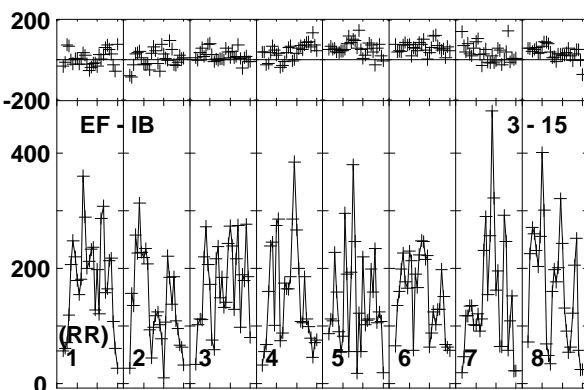
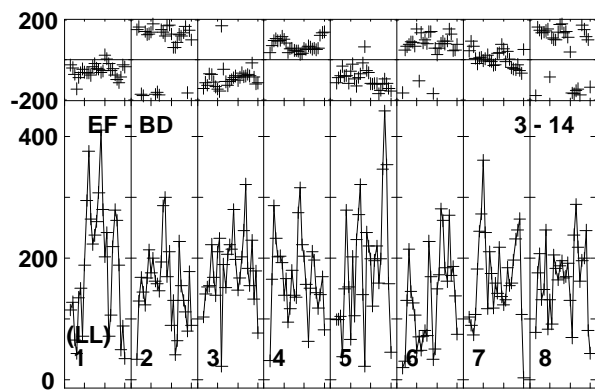
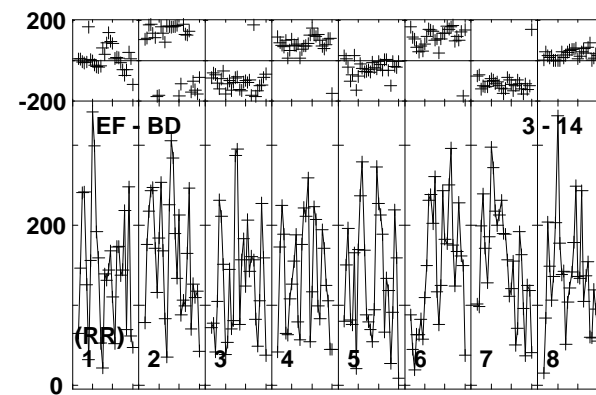
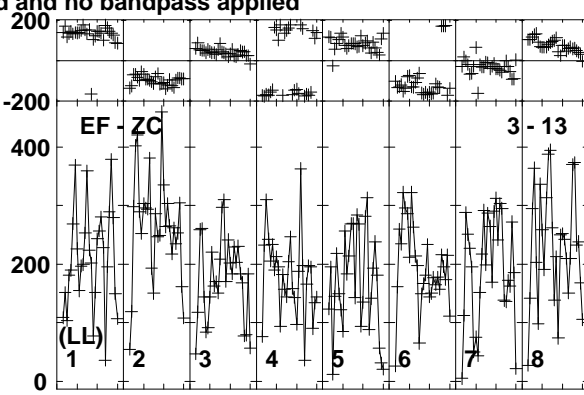
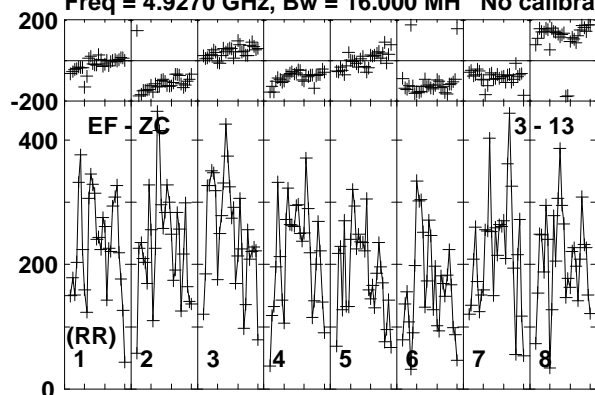

Lower frame: Micro Ampl Jy Top frame: Phas deg  
Vector averaged cross-power spectrum Baseline: EF (03) - ZC (13)  
Timerange: 00/08:15:01 to 00/08:16:59

Plot file version 22 created 19-DEC-2018 17:58:14

J1619+2247 RY007C.UVDATA.1

Freq = 4.9270 GHz, Bw = 16.000 MH No calibration applied and no bandpass applied

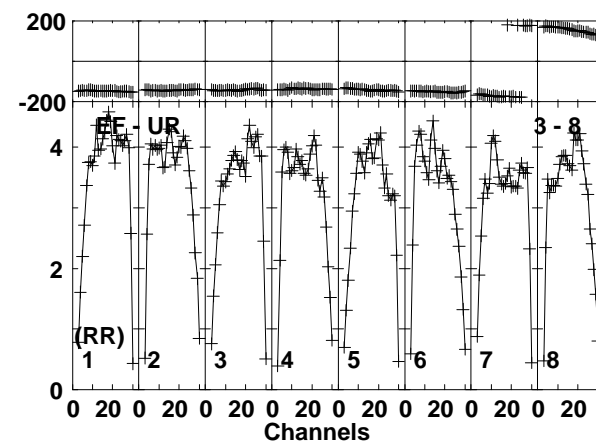
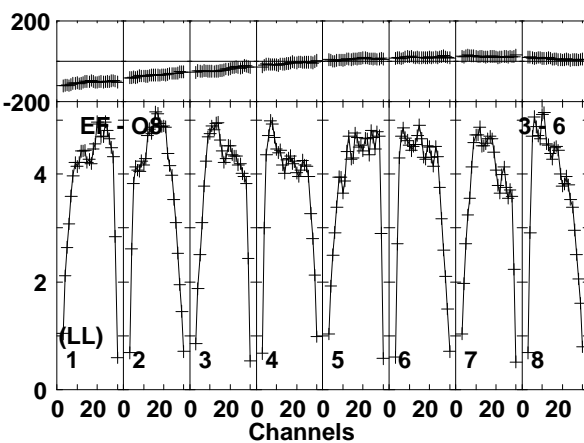
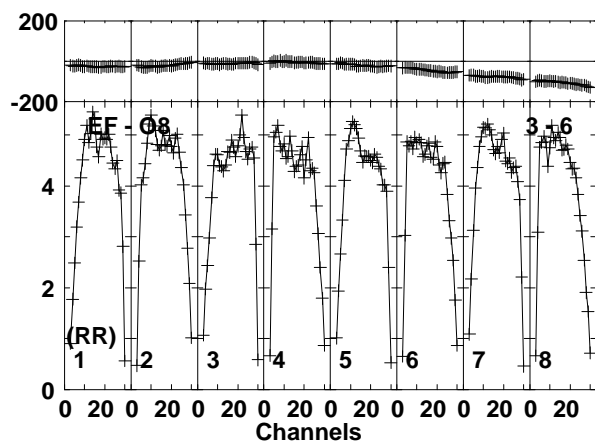
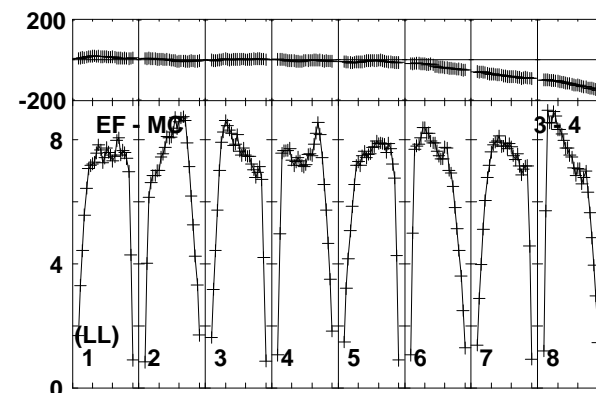
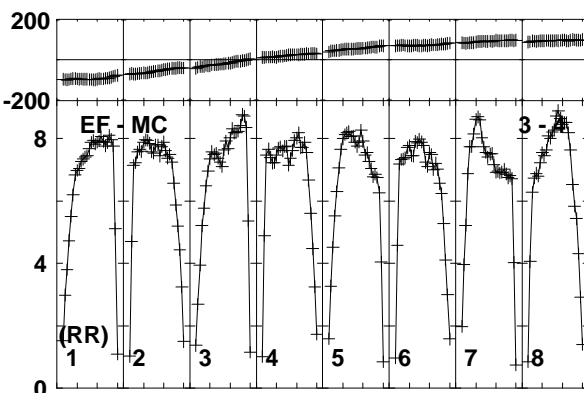
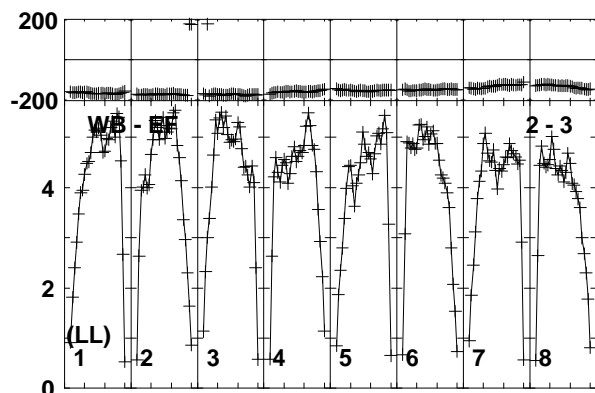
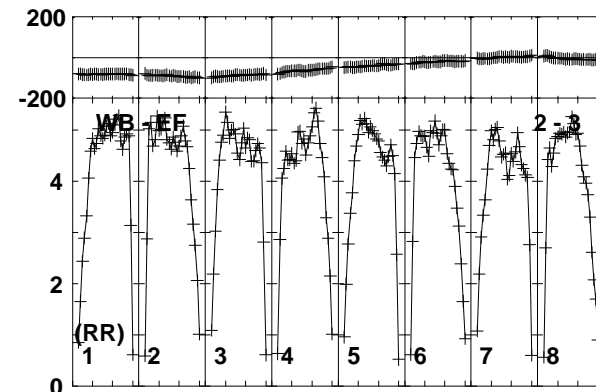
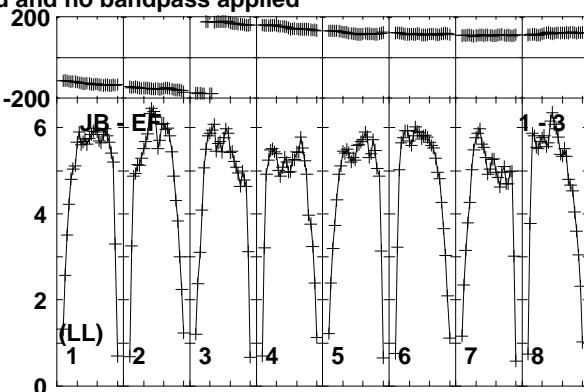
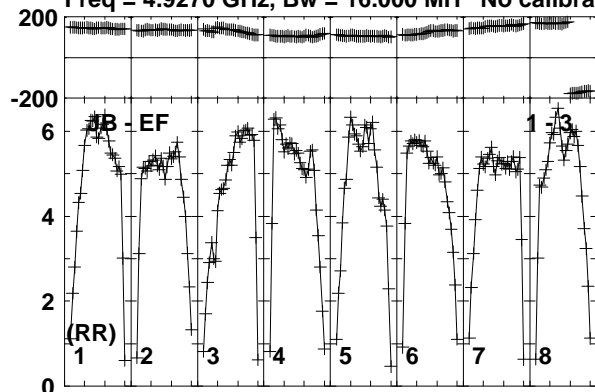

Lower frame: Milli Ampl Jy Top frame: Phas deg  
Vector averaged cross-power spectrum Baseline: JB (01) - EF (03)  
Timerange: 00/08:17:01 to 00/08:17:59

Plot file version 23 created 19-DEC-2018 17:58:15

J1619+2247 RY007C.UVDATA.1

Freq = 4.9270 GHz, Bw = 16.000 MH No calibration applied and no bandpass applied

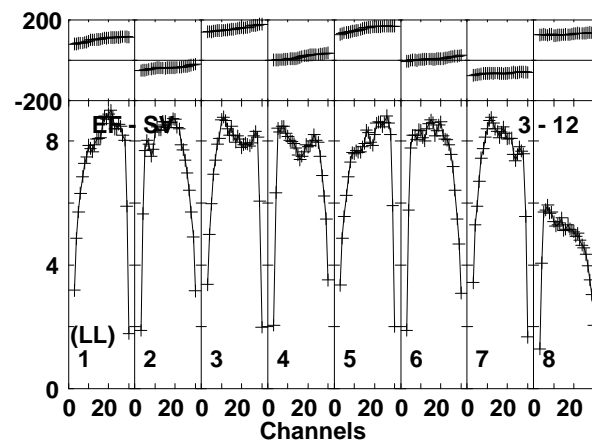
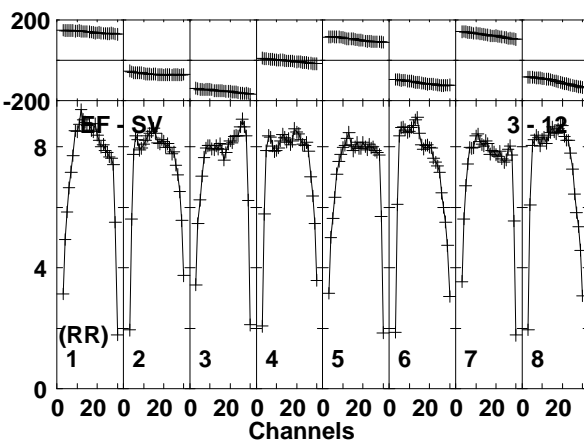
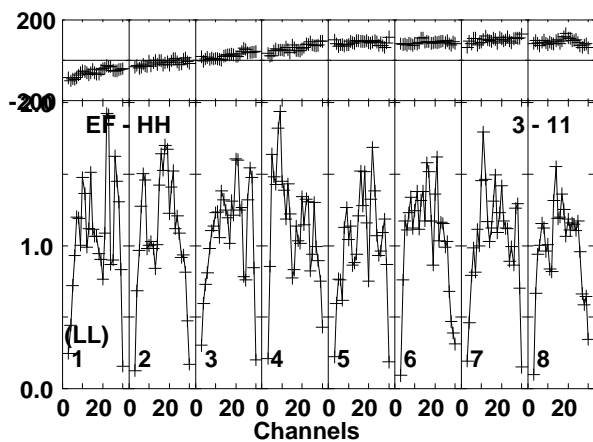
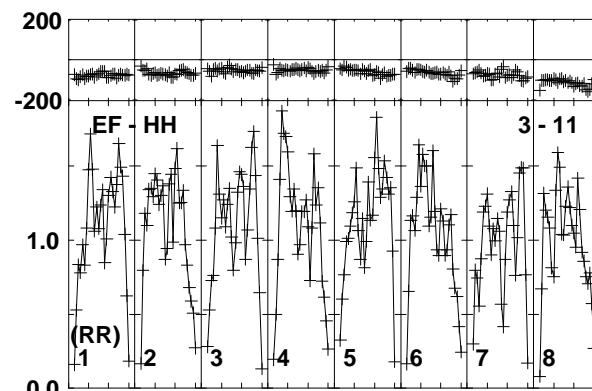
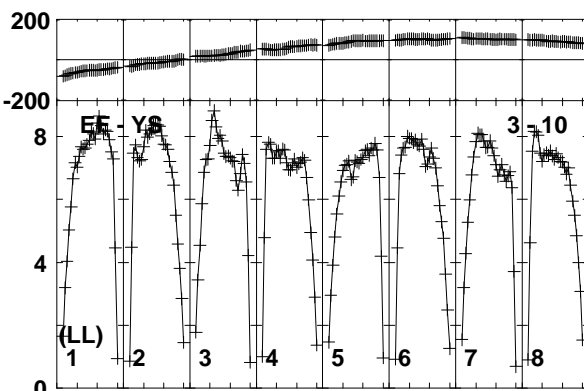
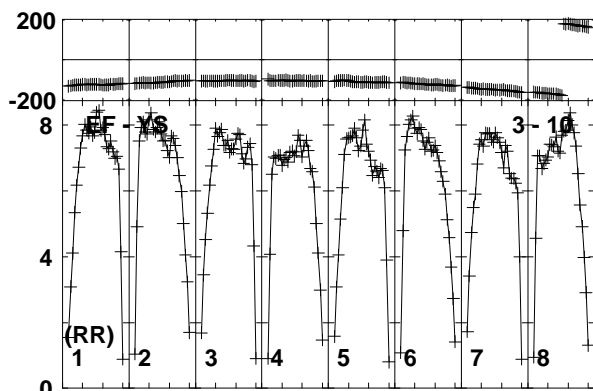
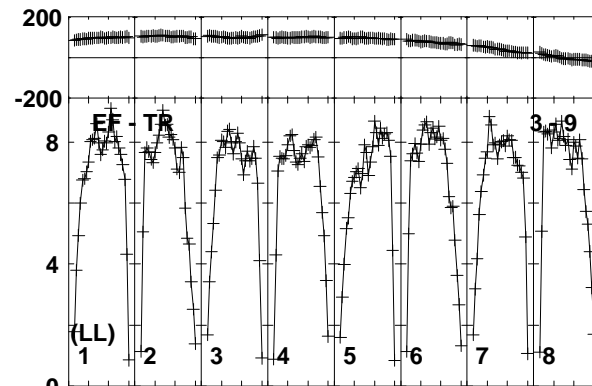
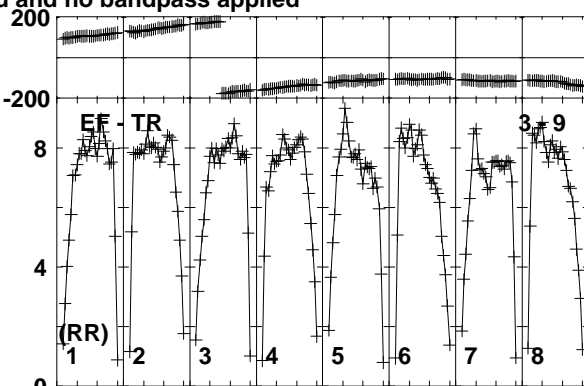
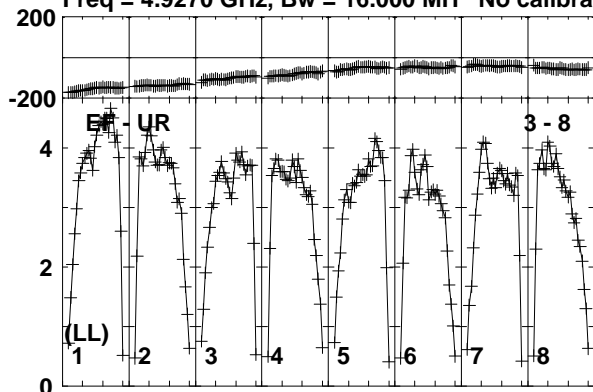

Lower frame: Milli Ampl Jy Top frame: Phas deg  
Vector averaged cross-power spectrum Baseline: EF (03) - UR (08)  
Timerange: 00/08:17:01 to 00/08:17:59

Plot file version 24 created 19-DEC-2018 17:58:15

J1619+2247 RY007C.UVDATA.1

Freq = 4.9270 GHz, Bw = 16.000 MH No calibration applied and no bandpass applied

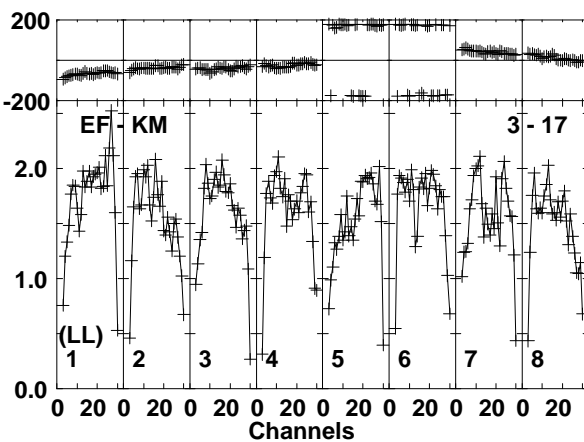
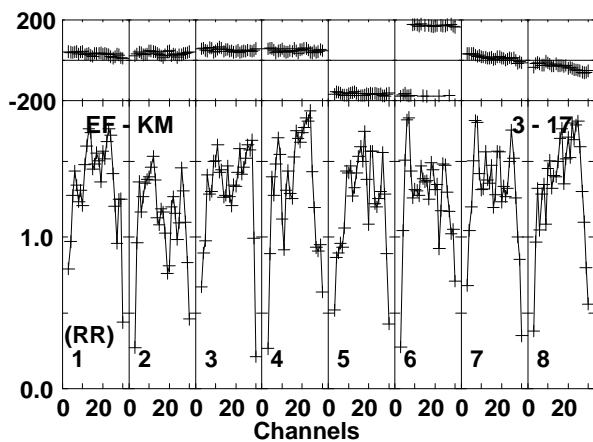
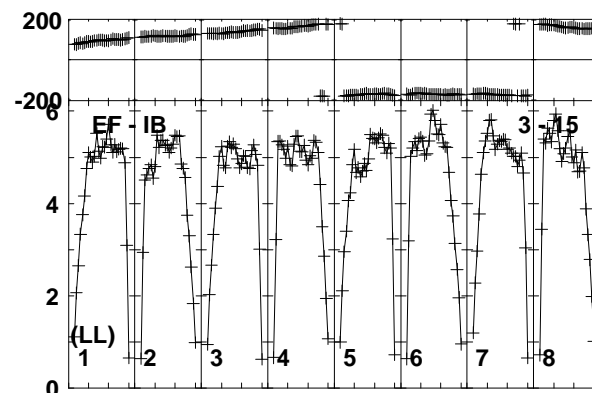
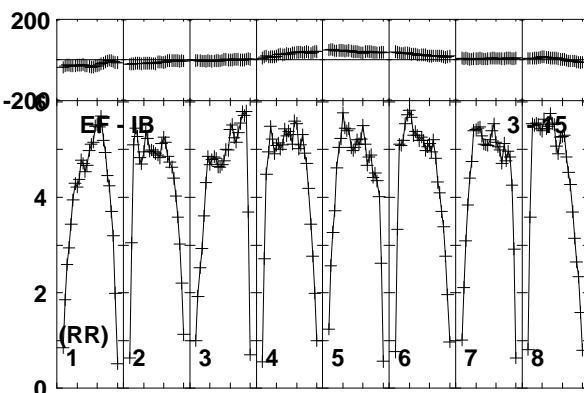
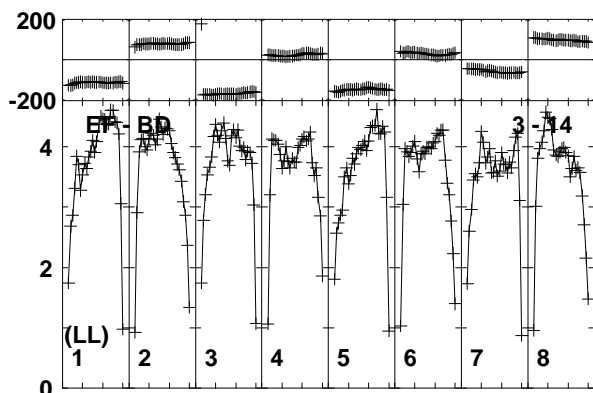
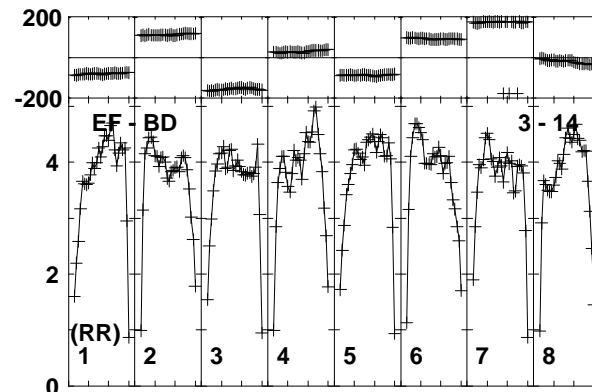
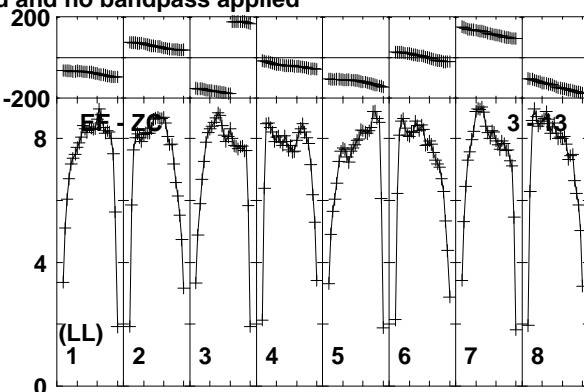
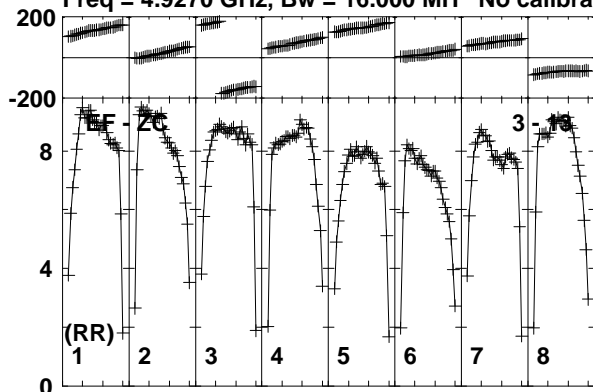

Lower frame: Milli Ampl Jy Top frame: Phas deg  
Vector averaged cross-power spectrum Baseline: EF (03) - ZC (13)  
Timerange: 00/08:17:01 to 00/08:17:59

Plot file version 25 created 19-DEC-2018 17:58:15

AT2018\_RY007C.UVDATA.1

Freq = 4.9270 GHz, Bw = 16.000 MH No calibration applied and no bandpass applied

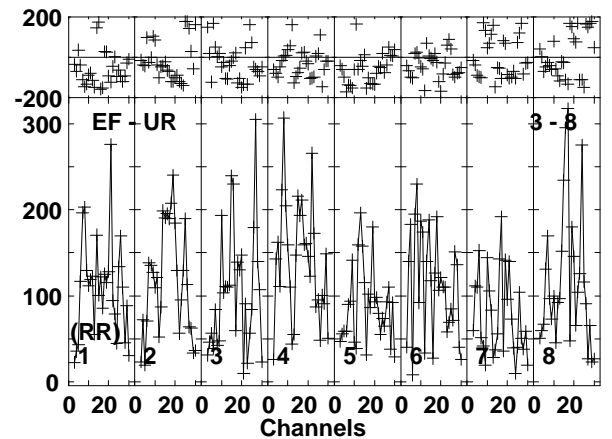
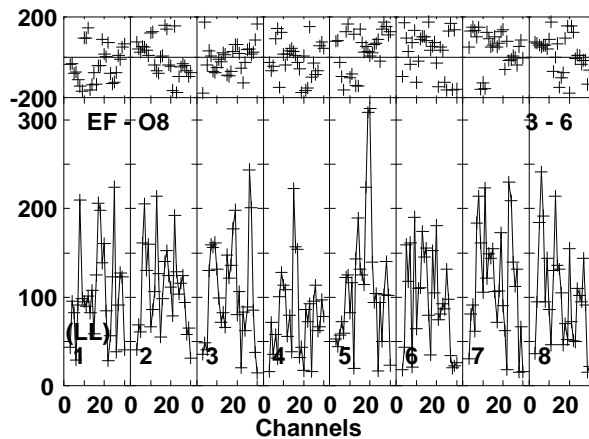
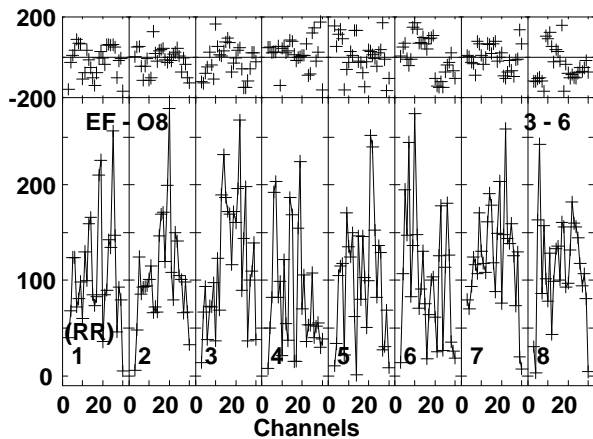
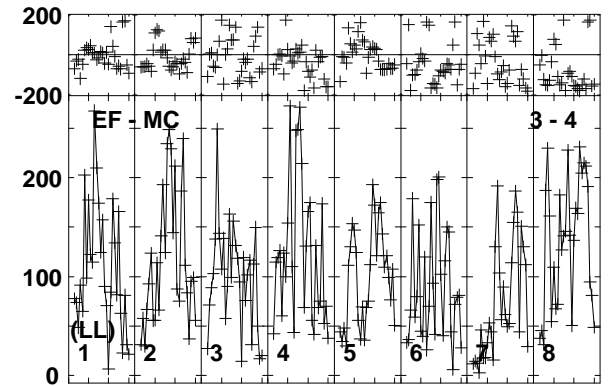
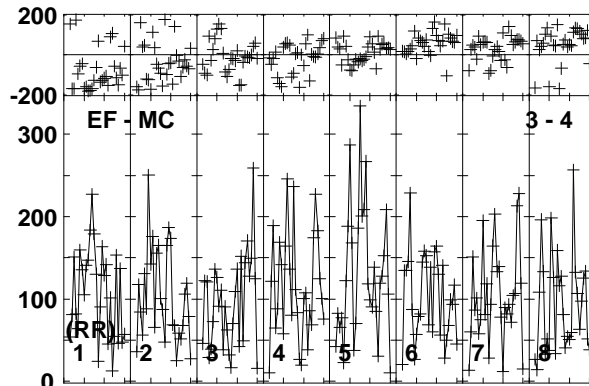
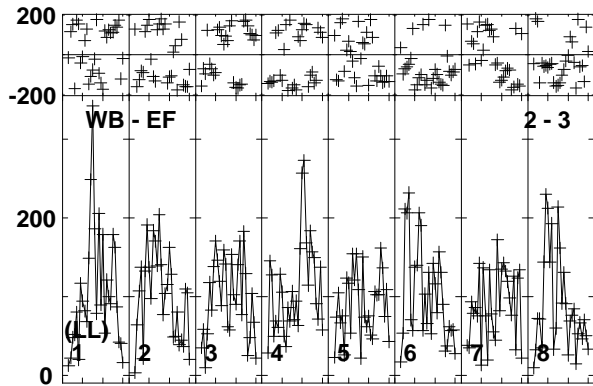
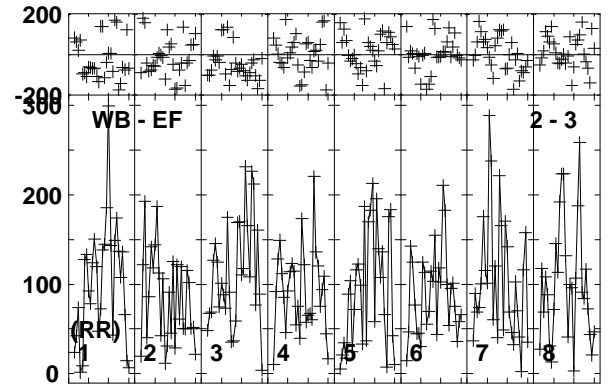
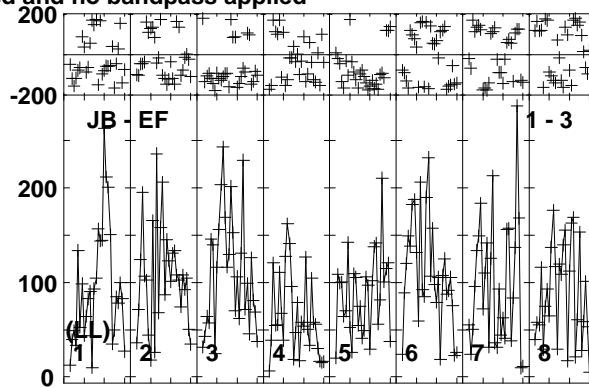
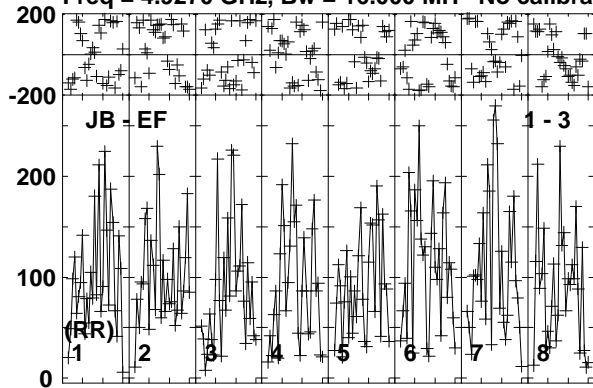

Lower frame: Micro Ampl Jy Top frame: Phas deg  
Vector averaged cross-power spectrum Baseline: JB (01) - EF (03)  
Timerange: 00/08:18:01 to 00/08:20:59

Plot file version 26 created 19-DEC-2018 17:58:15

AT2018\_RY007C.UVDATA.1

Freq = 4.9270 GHz, Bw = 16.000 MH No calibration applied and no bandpass applied

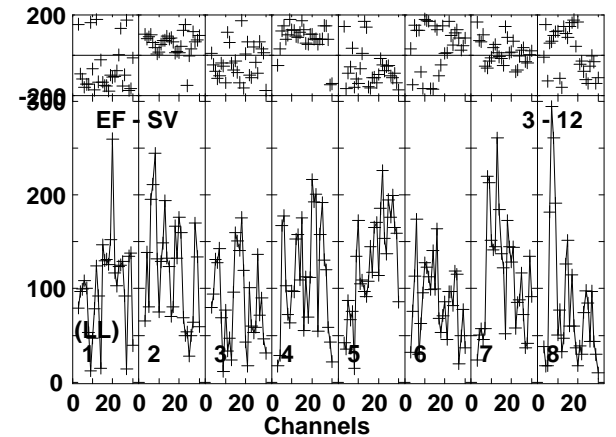
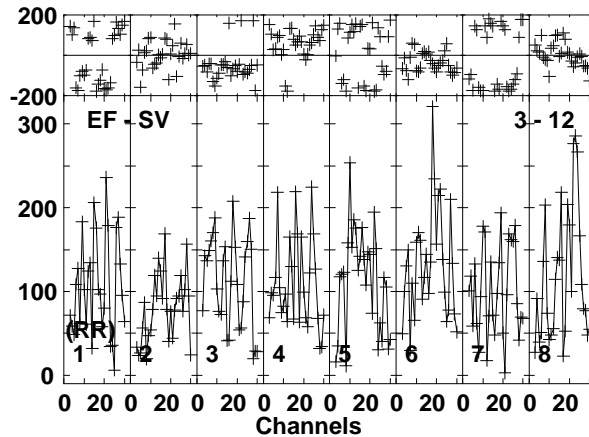
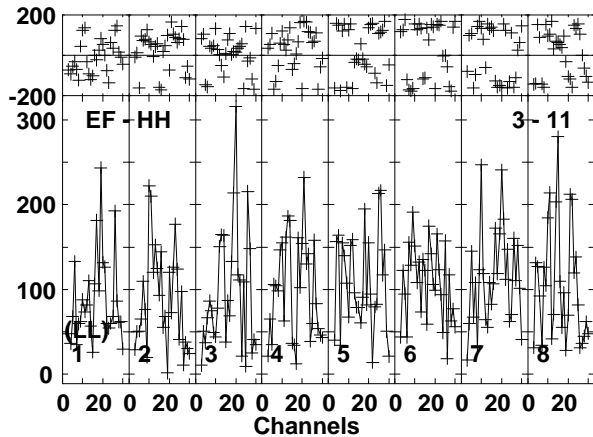
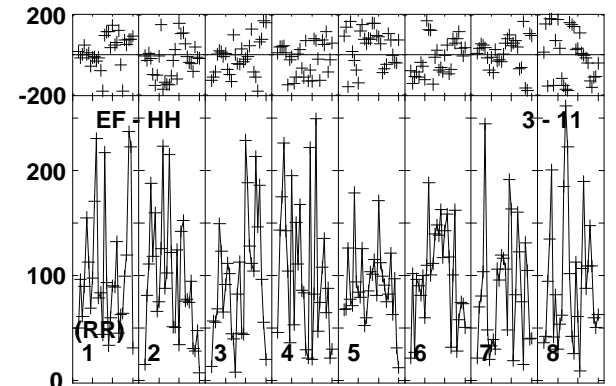
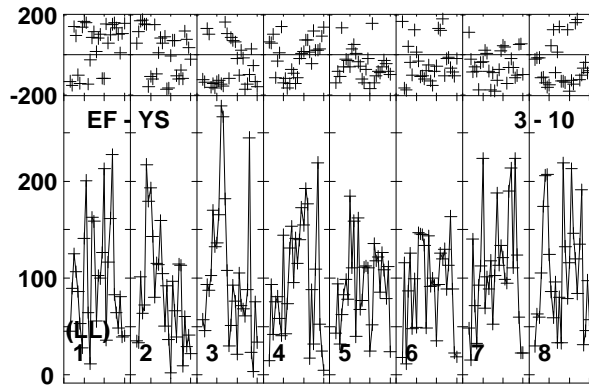
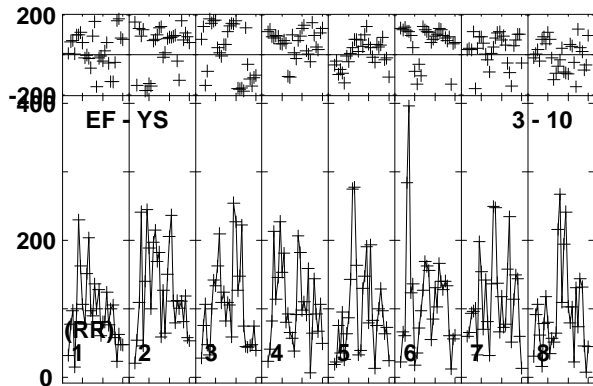
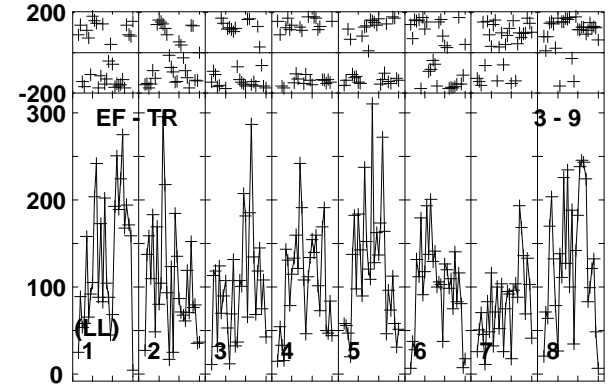
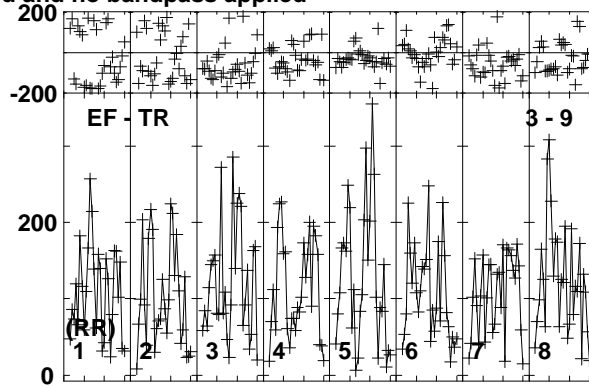
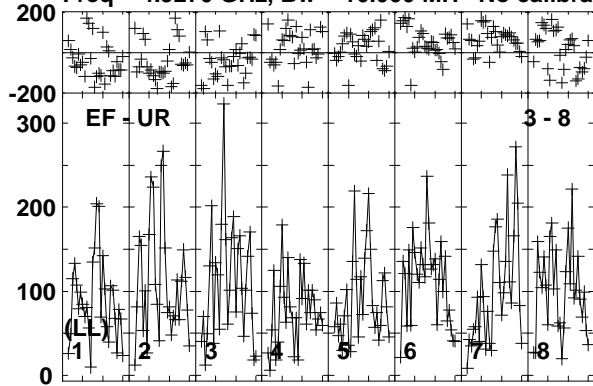

Lower frame: Micro Ampl Jy Top frame: Phas deg  
Vector averaged cross-power spectrum Baseline: EF (03) - UR (08)  
Timerange: 00/08:18:01 to 00/08:20:59



Plot file version 27 created 19-DEC-2018 17:58:15

AT2018\_RY007C.UVDATA.1

Freq = 4.9270 GHz, Bw = 16.000 MH No calibration applied and no bandpass applied

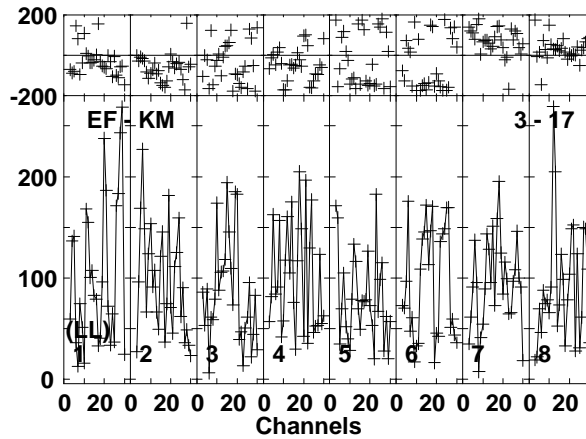
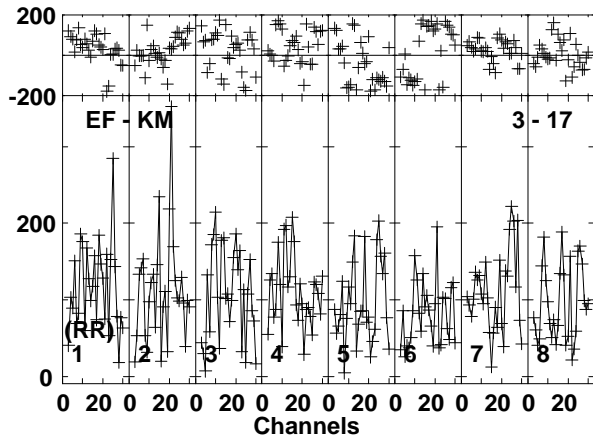
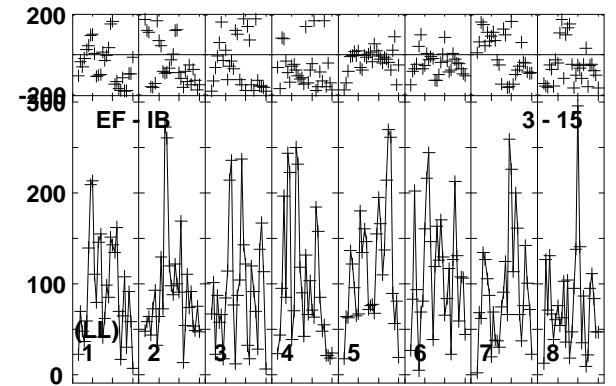
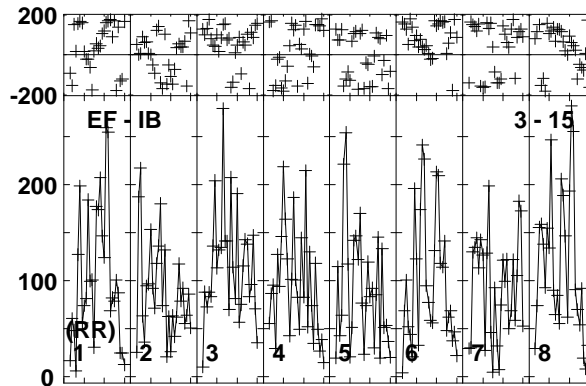
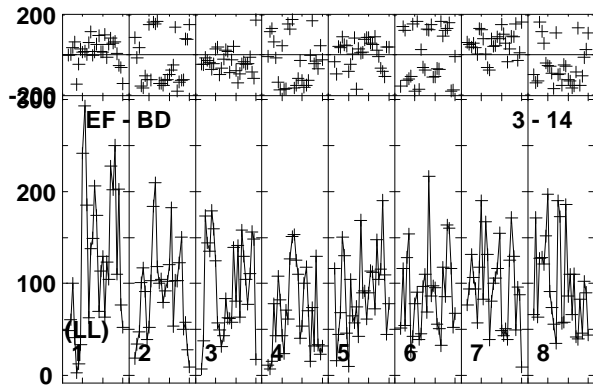
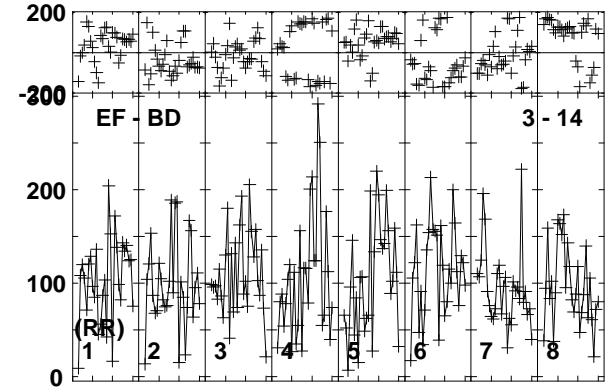
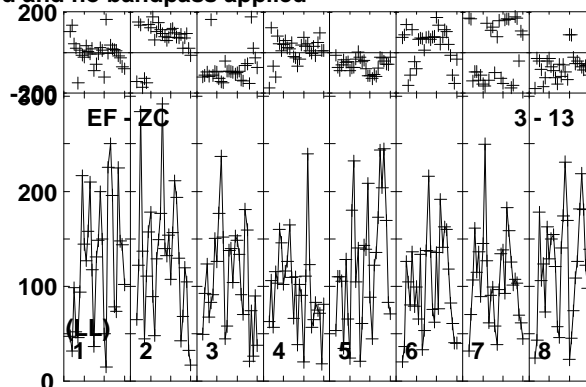
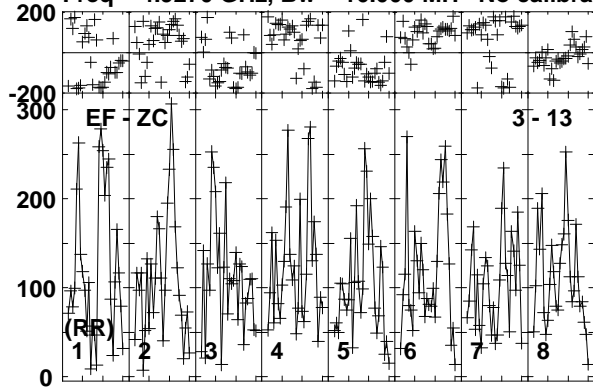

Lower frame: Micro Ampl Jy Top frame: Phas deg  
Vector averaged cross-power spectrum Baseline: EF (03) - ZC (13)  
Timerange: 00/08:18:01 to 00/08:20:59

Plot file version 28 created 19-DEC-2018 17:58:15

J1619+2247 RY007C.UVDATA.1

Freq = 4.9270 GHz, Bw = 16.000 MH No calibration applied and no bandpass applied

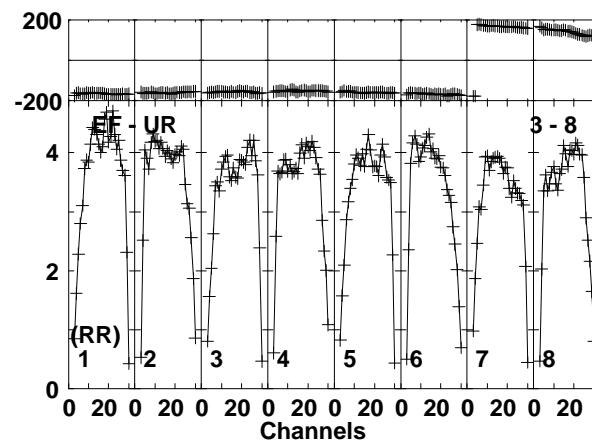
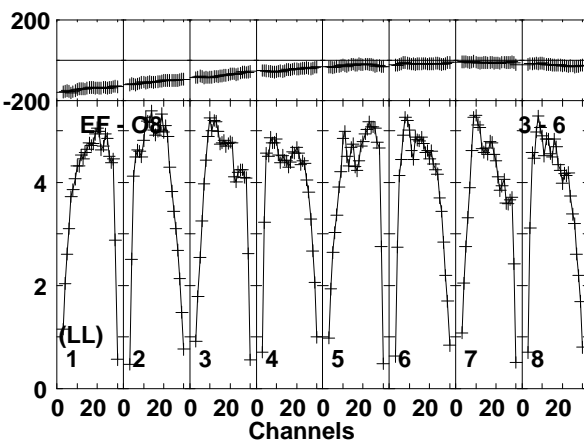
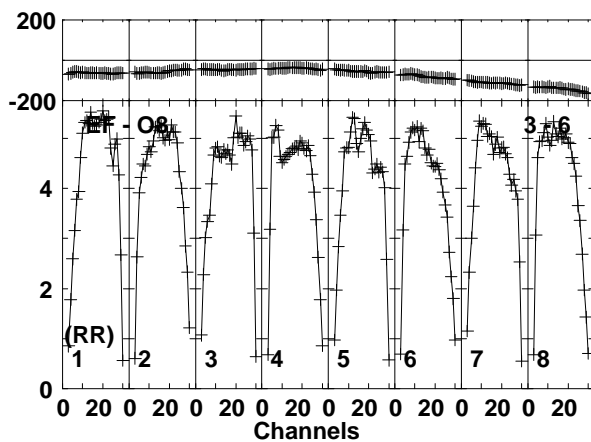
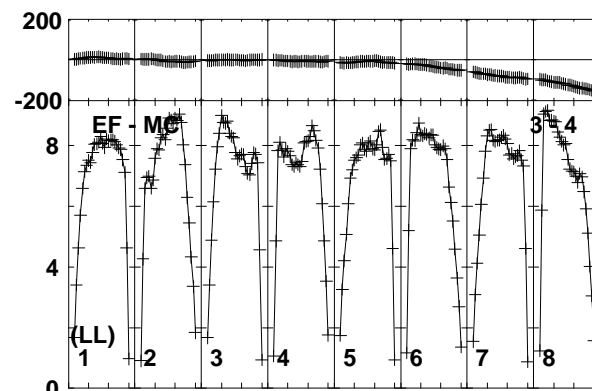
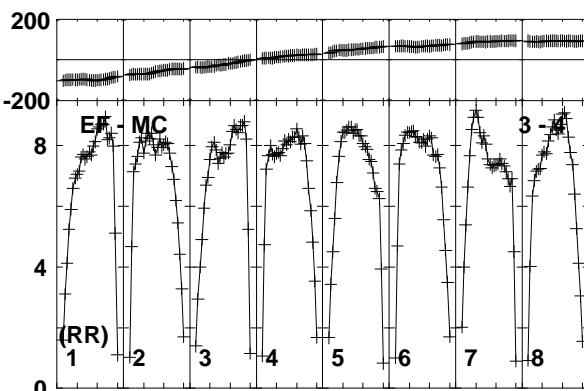
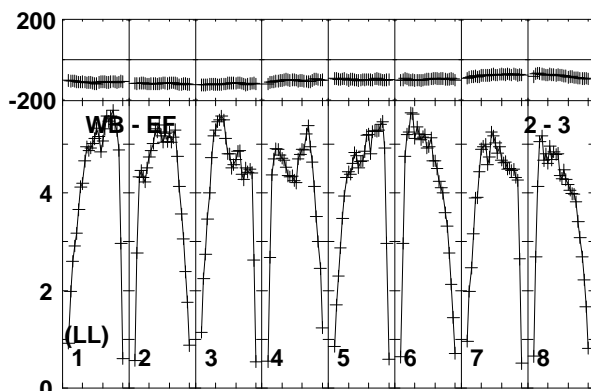
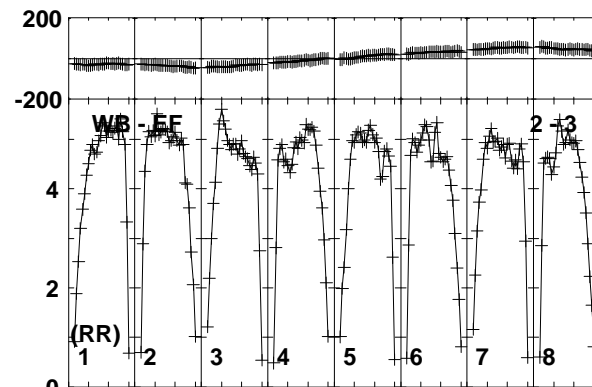
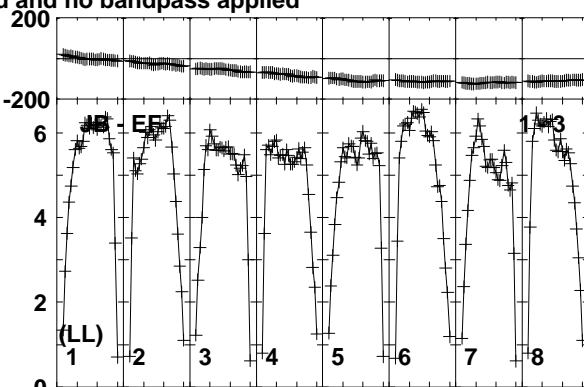
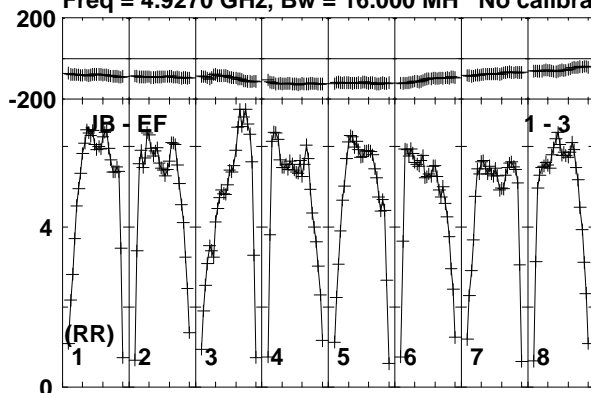

Lower frame: Milli Ampl Jy Top frame: Phas deg  
Vector averaged cross-power spectrum Baseline: JB (01) - EF (03)  
Timerange: 00/08:21:01 to 00/08:21:59

Plot file version 29 created 19-DEC-2018 17:58:15

J1619+2247 RY007C.UVDATA.1

Freq = 4.9270 GHz, Bw = 16.000 MH No calibration applied and no bandpass applied

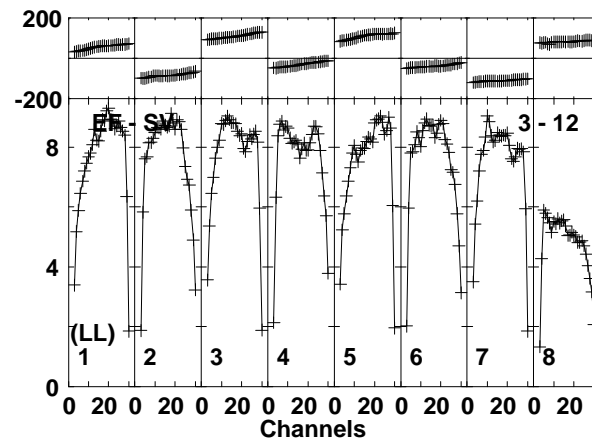
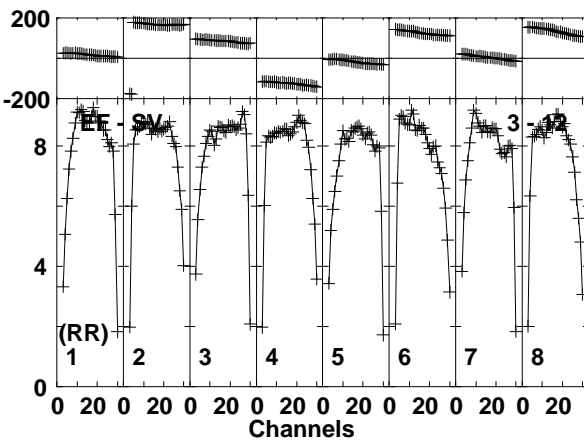
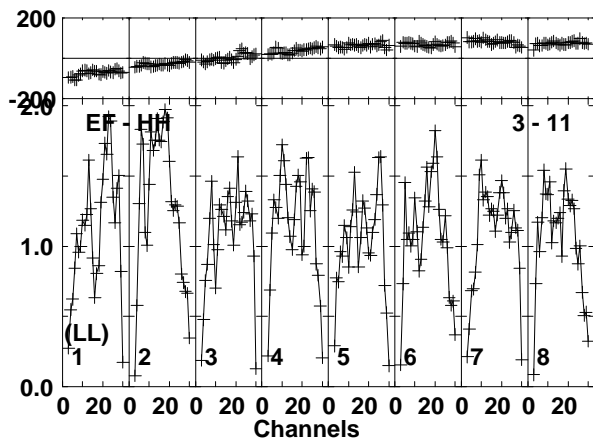
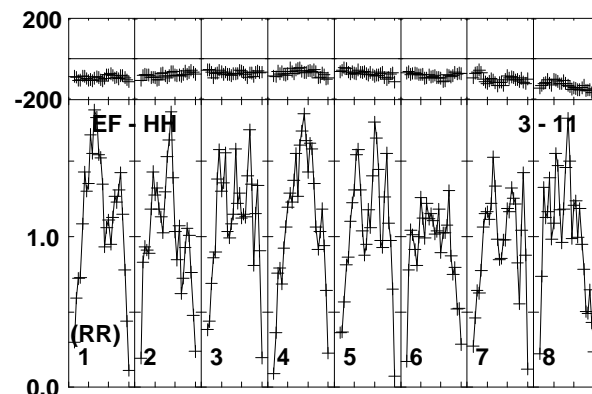
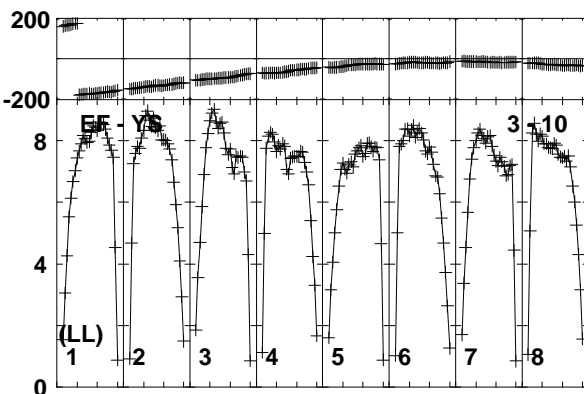
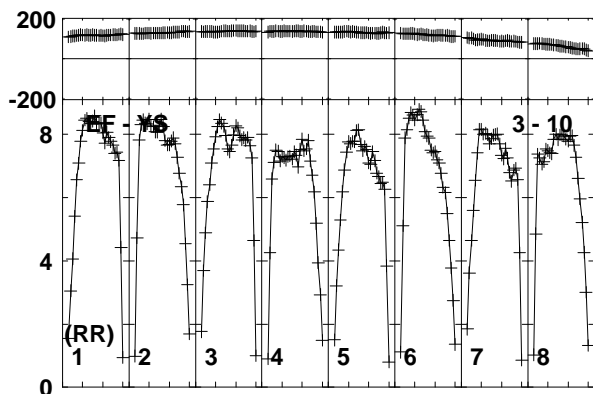
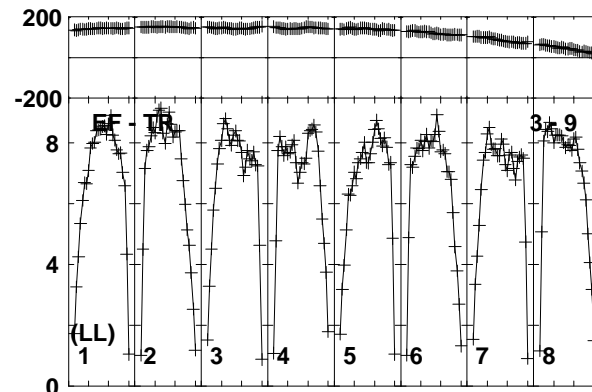
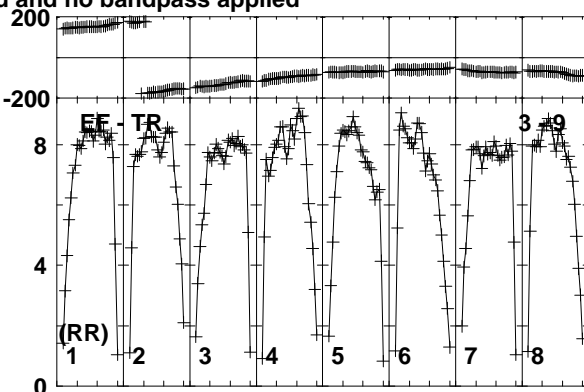
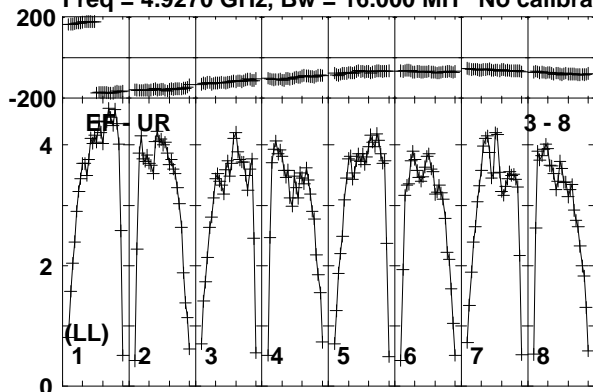

Lower frame: Milli Ampl Jy Top frame: Phas deg  
Vector averaged cross-power spectrum Baseline: EF (03) - UR (08)  
Timerange: 00/08:21:01 to 00/08:21:59

Plot file version 30 created 19-DEC-2018 17:58:15

J1619+2247 RY007C.UVDATA.1

Freq = 4.9270 GHz, Bw = 16.000 MH No calibration applied and no bandpass applied

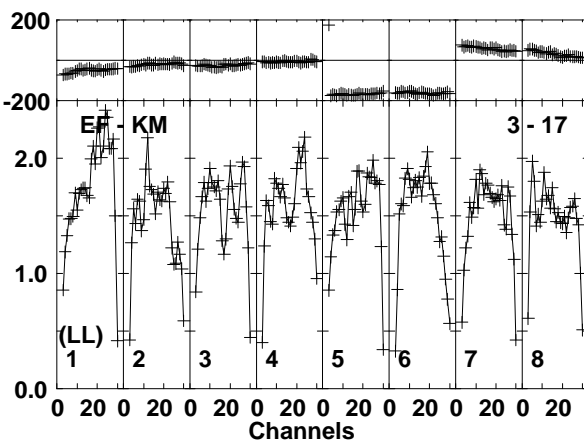
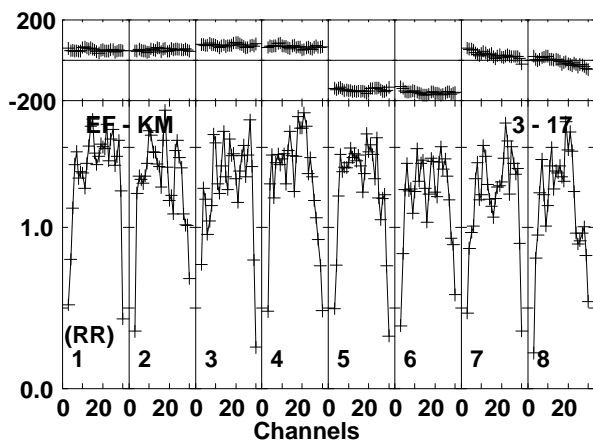
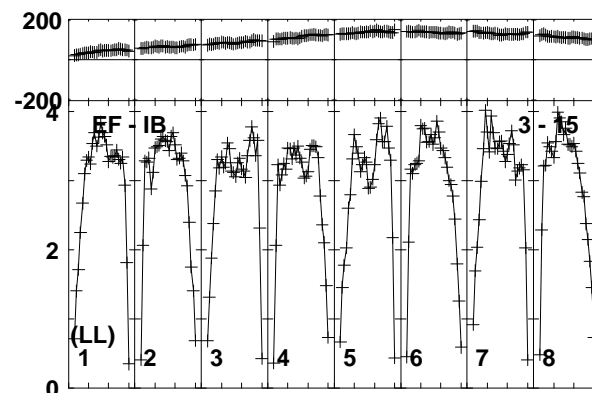
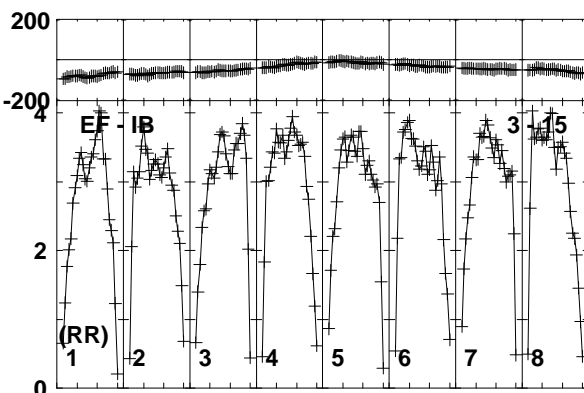
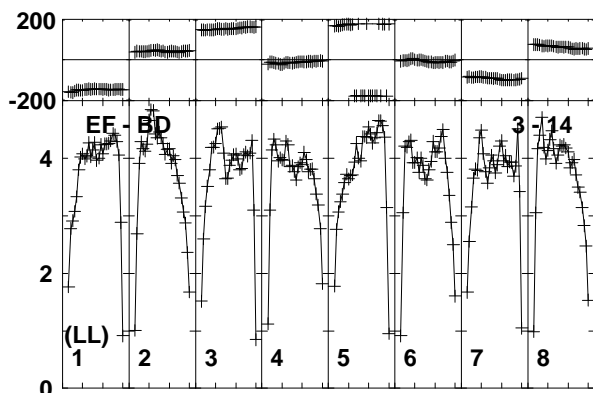
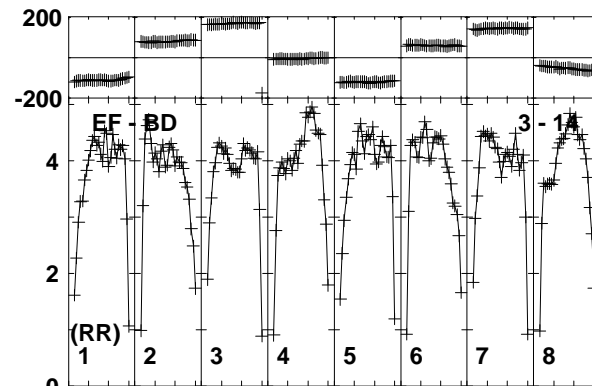
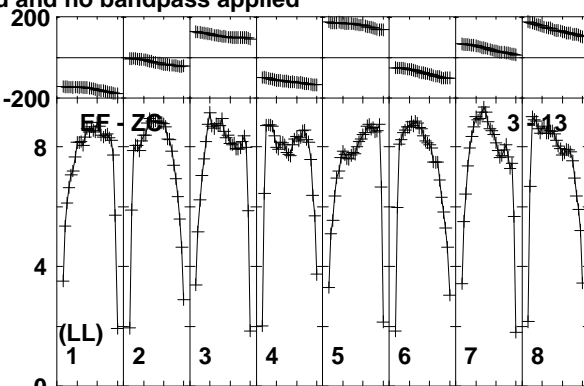
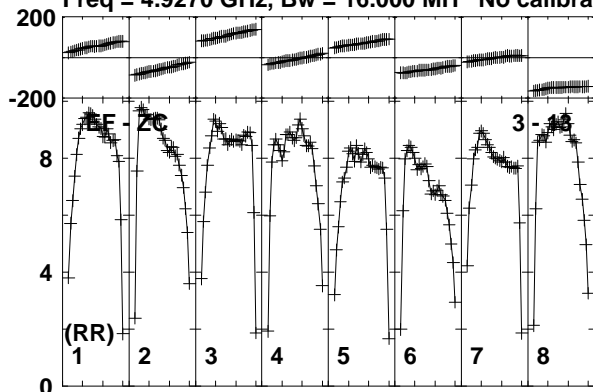

Lower frame: Milli Ampl Jy Top frame: Phas deg  
Vector averaged cross-power spectrum Baseline: EF (03) - ZC (13)  
Timerange: 00/08:21:01 to 00/08:21:59

Plot file version 31 created 19-DEC-2018 17:58:15

AT2018\_RY007C.UVDATA.1

Freq = 4.9270 GHz, Bw = 16.000 MH No calibration applied and no bandpass applied

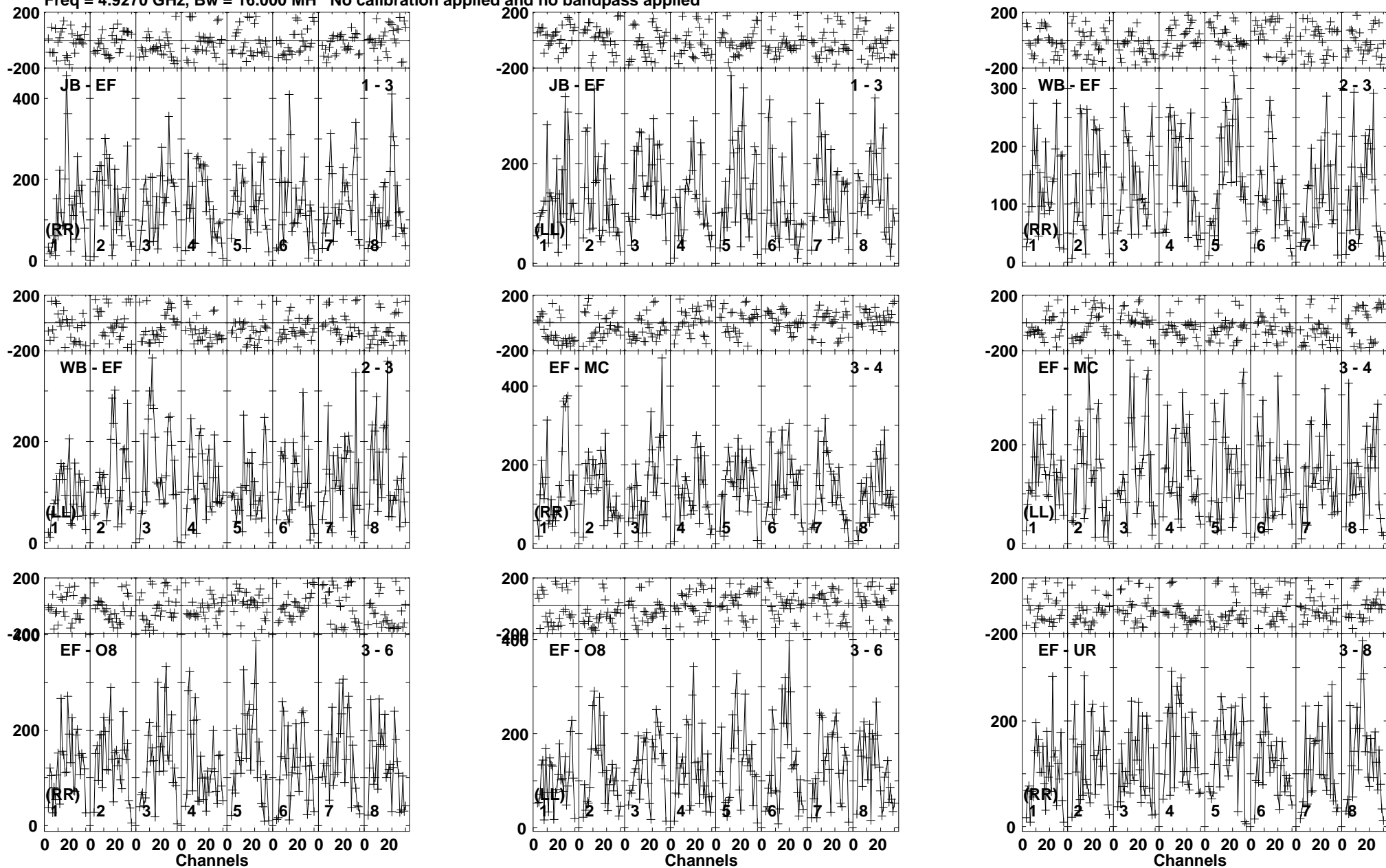

Lower frame: Micro Ampl Jy Top frame: Phas deg  
Vector averaged cross-power spectrum Baseline: JB (01) - EF (03)  
Timerange: 00/08:22:01 to 00/08:23:59

Plot file version 32 created 19-DEC-2018 17:58:15

AT2018\_RY007C.UVDATA.1

Freq = 4.9270 GHz, Bw = 16.000 MH No calibration applied and no bandpass applied

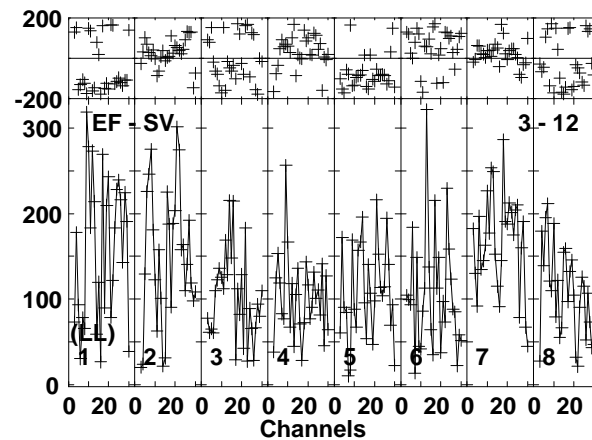
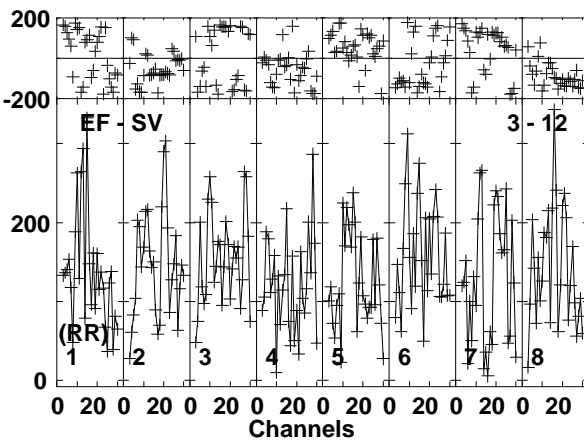
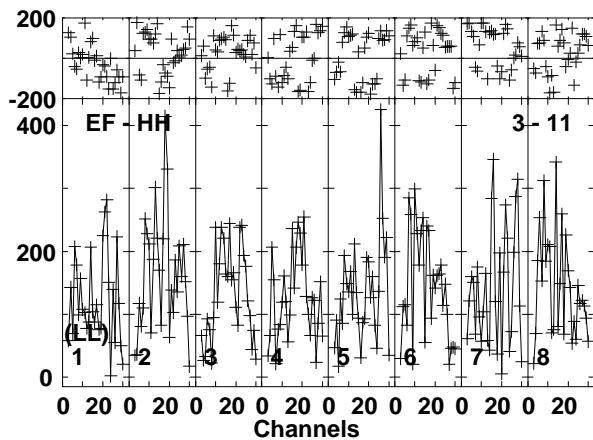
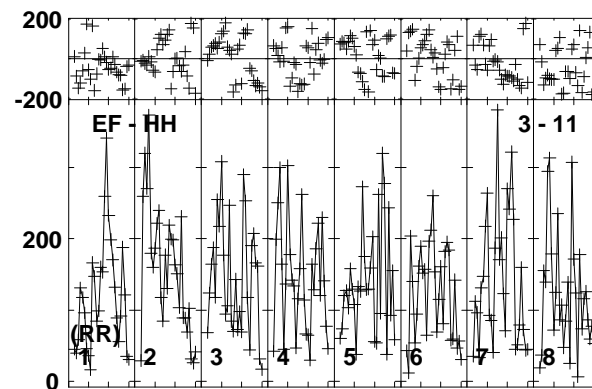
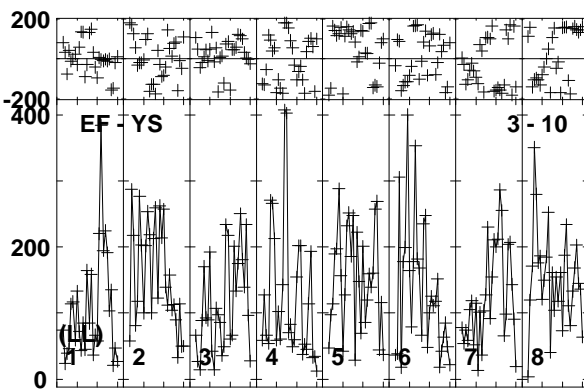
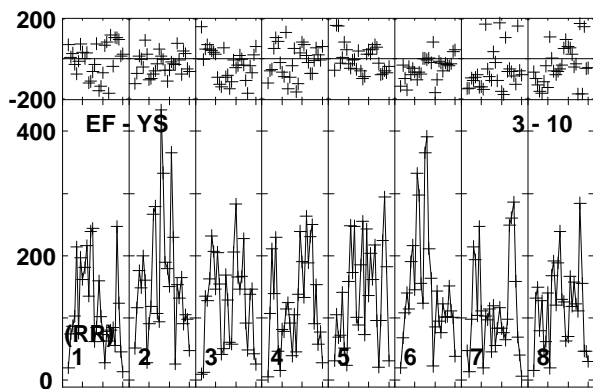
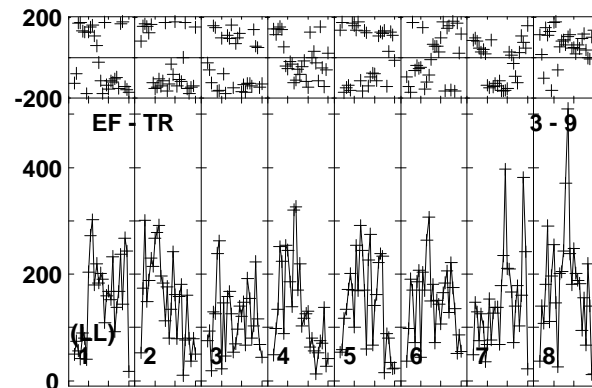
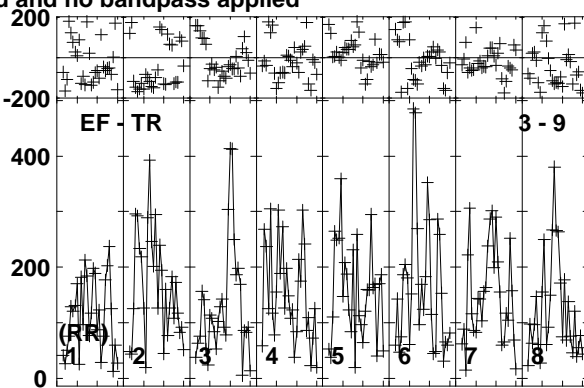
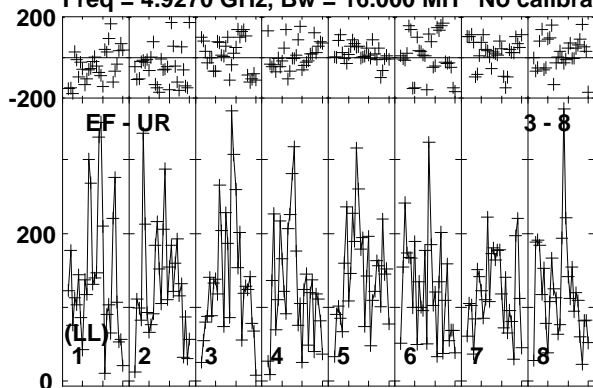

Lower frame: Micro Ampl Jy Top frame: Phas deg  
Vector averaged cross-power spectrum Baseline: EF (03) - UR (08)  
Timerange: 00/08:22:01 to 00/08:23:59

Plot file version 33 created 19-DEC-2018 17:58:15

AT2018\_RY007C.UVDATA.1

Freq = 4.9270 GHz, Bw = 16.000 MH No calibration applied and no bandpass applied

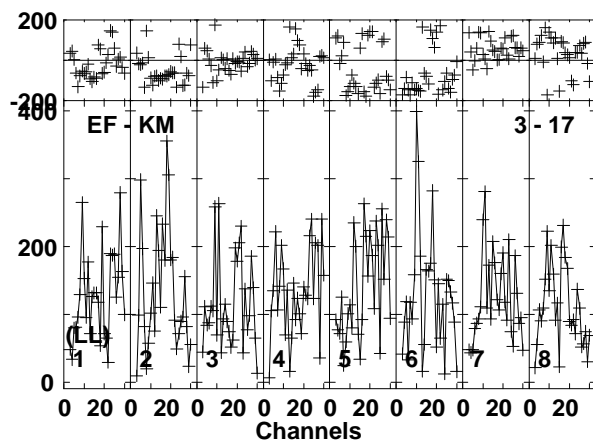
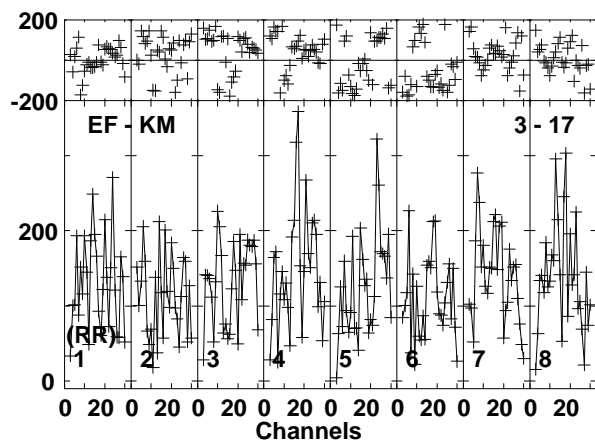
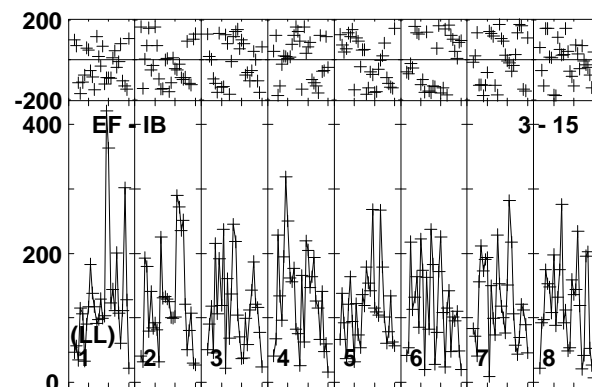
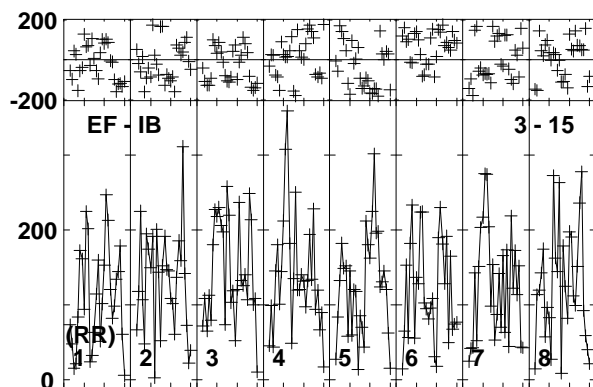
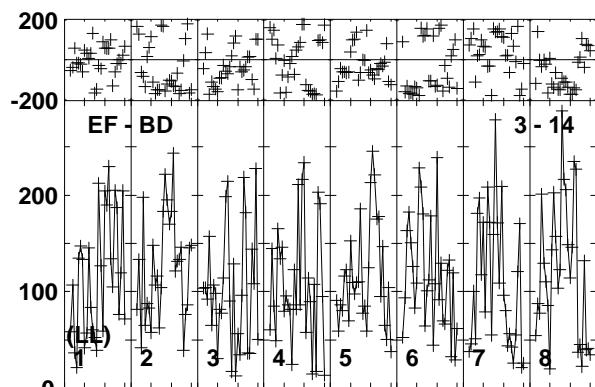
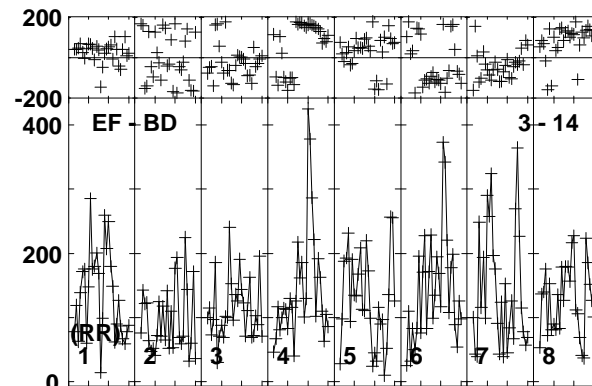
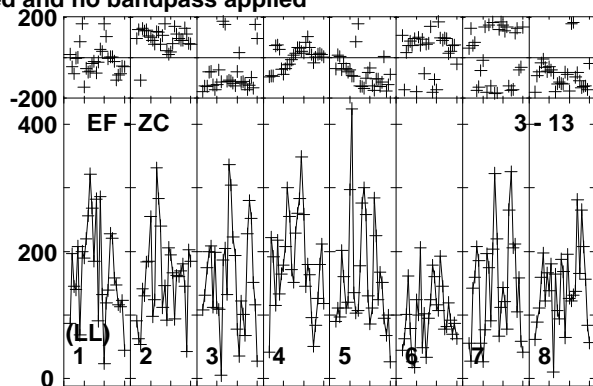
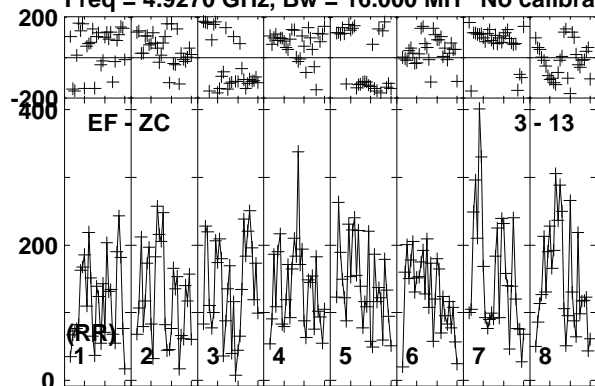

Lower frame: Micro Ampl Jy Top frame: Phas deg  
Vector averaged cross-power spectrum Baseline: EF (03) - ZC (13)  
Timerange: 00/08:22:01 to 00/08:23:59

Plot file version 34 created 19-DEC-2018 17:58:15

VLA2 RY007C.UVDATA.1

Freq = 4.9270 GHz, Bw = 16.000 MH No calibration applied and no bandpass applied

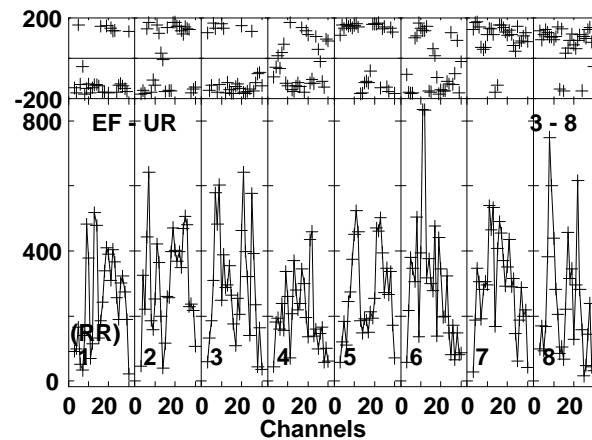
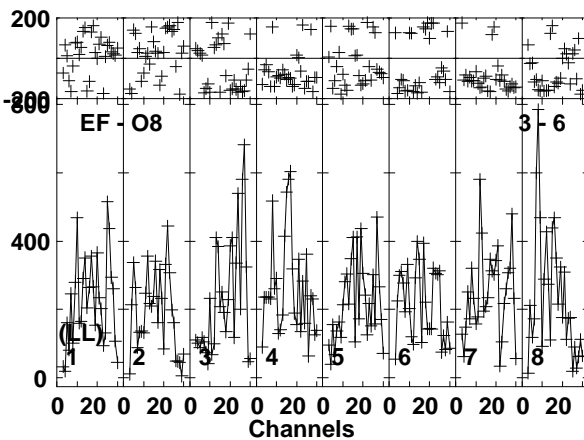
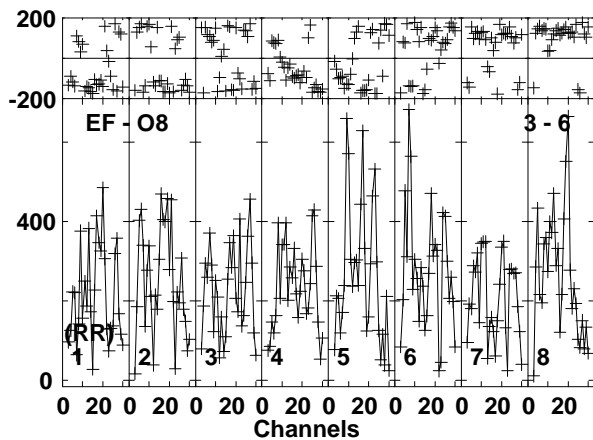
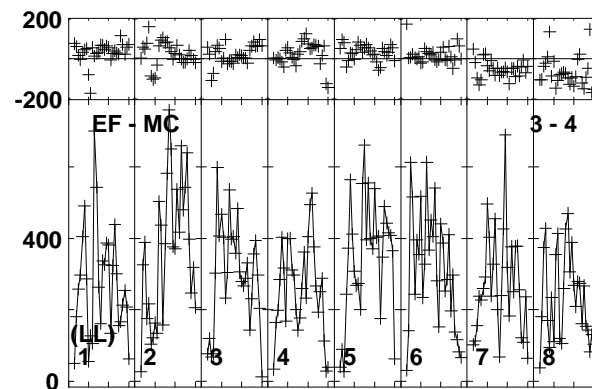
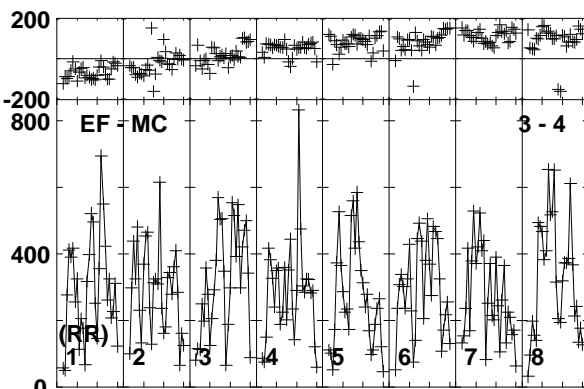
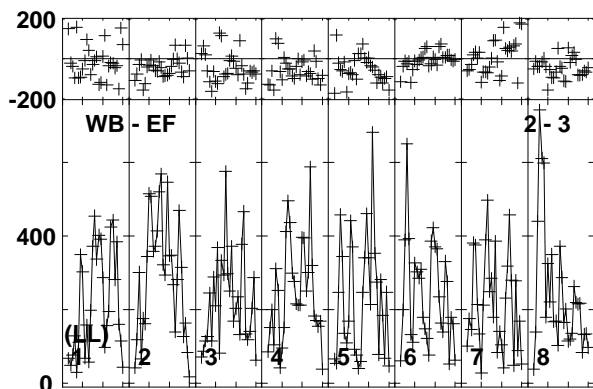
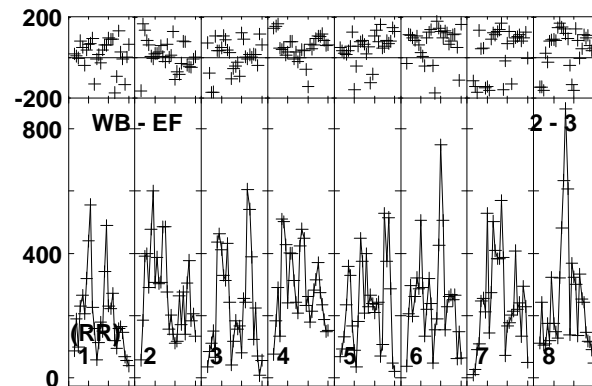
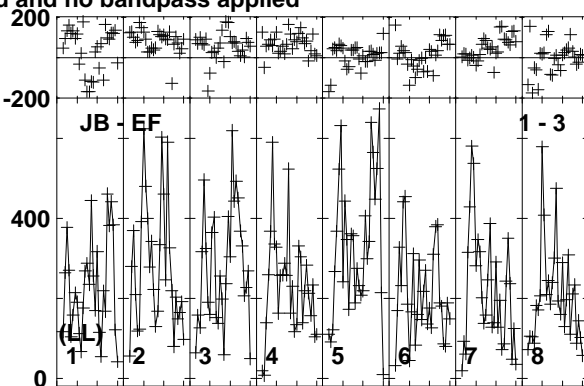
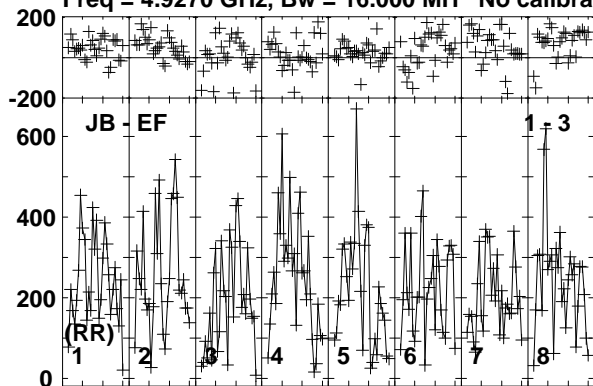

Lower frame: Micro Ampl Jy Top frame: Phas deg  
Vector averaged cross-power spectrum Baseline: JB (01) - EF (03)  
Timerange: 00/08:24:01 to 00/08:24:59



Plot file version 35 created 19-DEC-2018 17:58:15

VLA2 RY007C.UVDATA.1

Freq = 4.9270 GHz, Bw = 16.000 MH No calibration applied and no bandpass applied

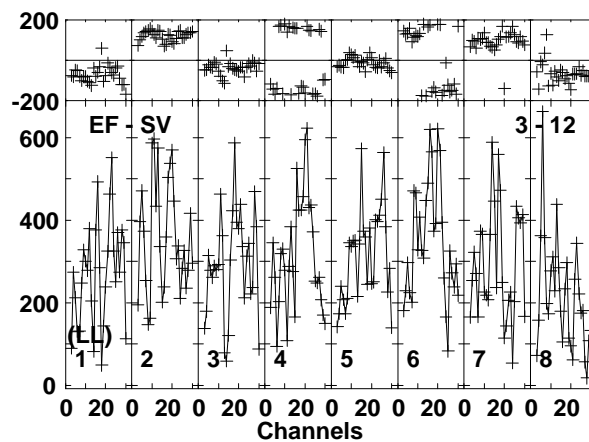
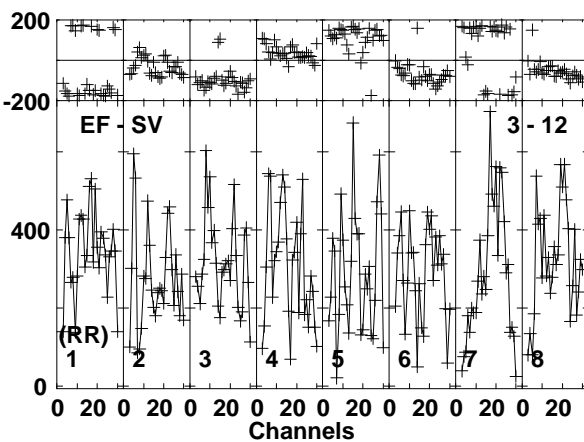
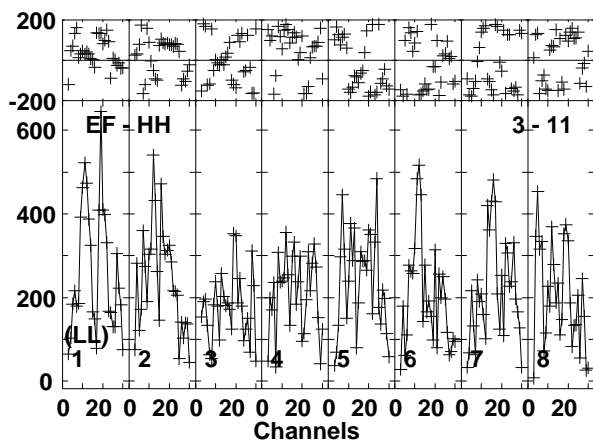
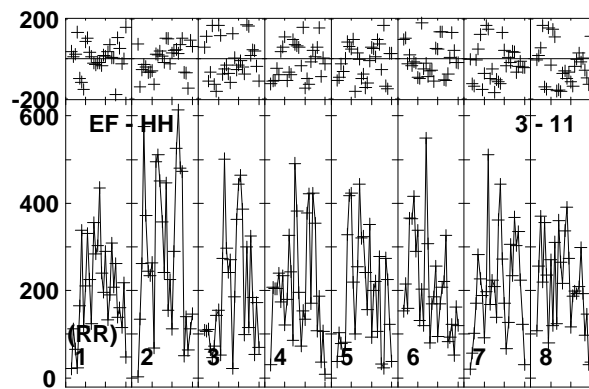
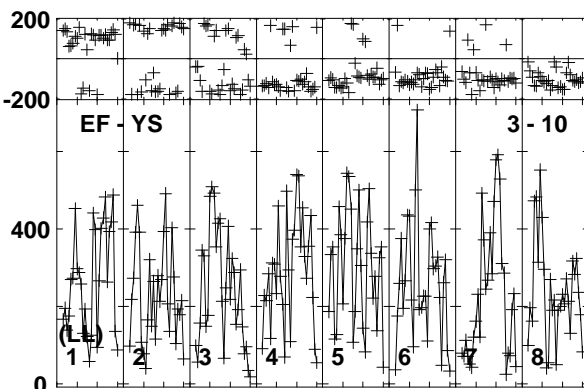
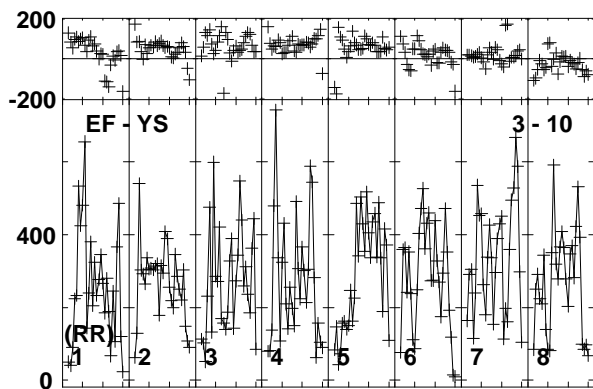
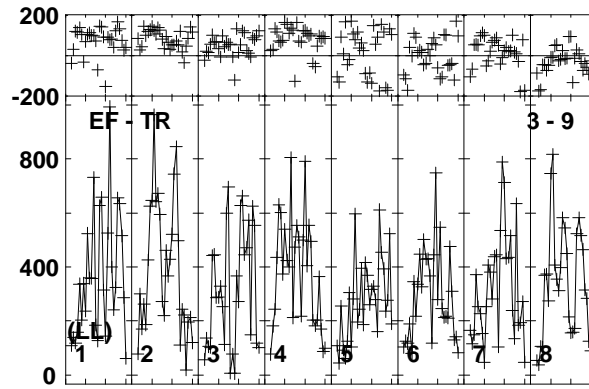
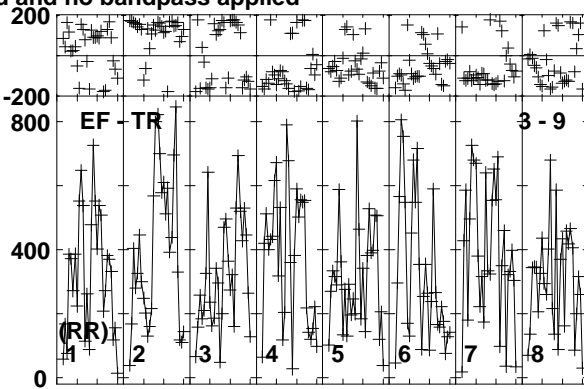
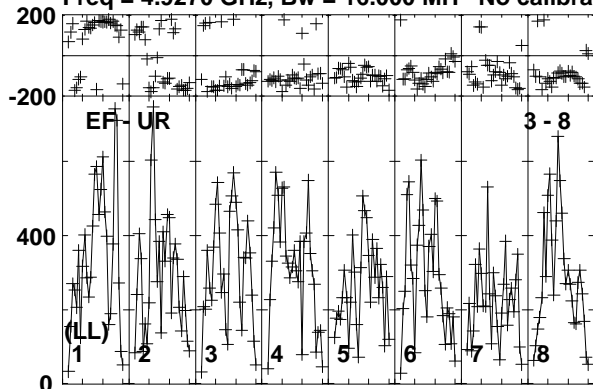

Lower frame: Micro Ampl Jy Top frame: Phas deg  
Vector averaged cross-power spectrum Baseline: EF (03) - UR (08)  
Timerange: 00/08:24:01 to 00/08:24:59

Plot file version 36 created 19-DEC-2018 17:58:15

VLA2 RY007C.UVDATA.1

Freq = 4.9270 GHz, Bw = 16.000 MH No calibration applied and no bandpass applied

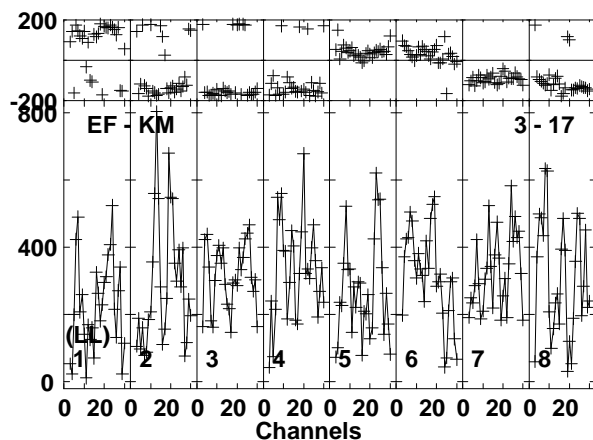
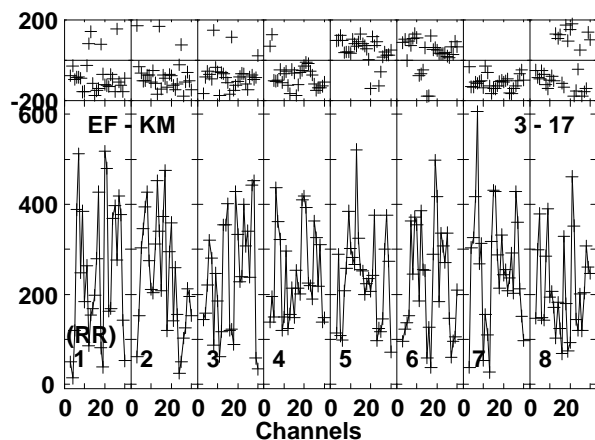
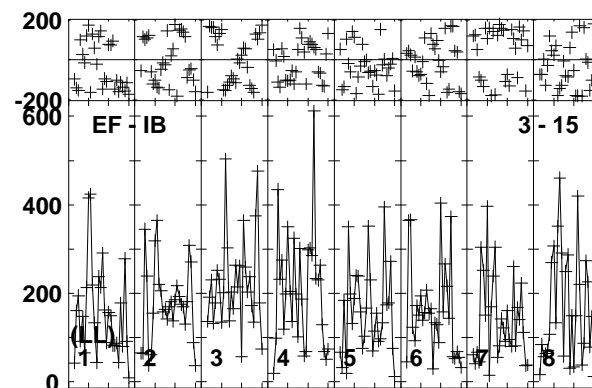
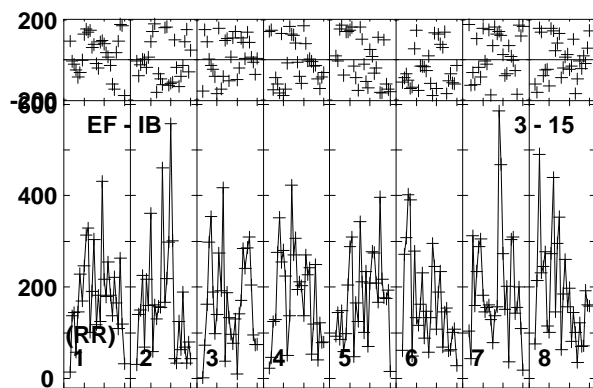
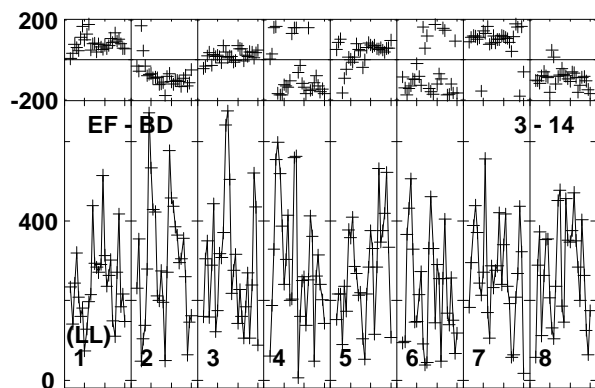
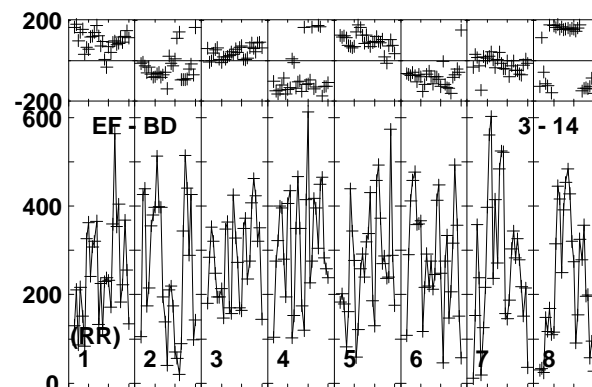
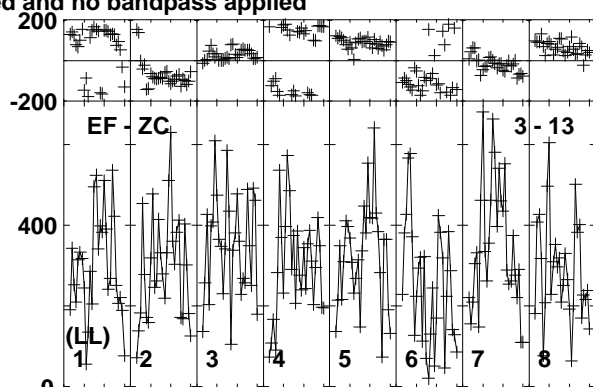
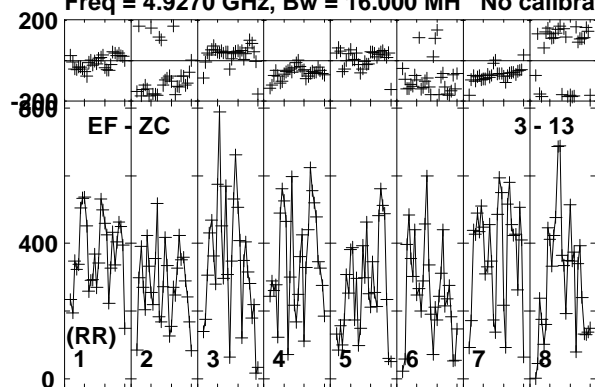

Lower frame: Micro Ampl Jy Top frame: Phas deg  
Vector averaged cross-power spectrum Baseline: EF (03) - ZC (13)  
Timerange: 00/08:24:01 to 00/08:24:59

Plot file version 37 created 19-DEC-2018 17:58:15

J1619+2247 RY007C.UVDATA.1

Freq = 4.9270 GHz, Bw = 16.000 MH No calibration applied and no bandpass applied

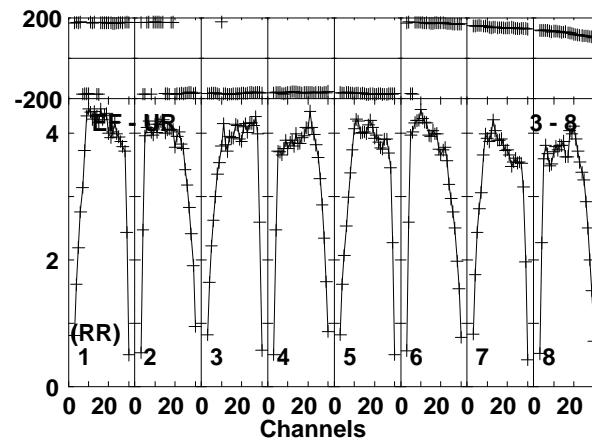
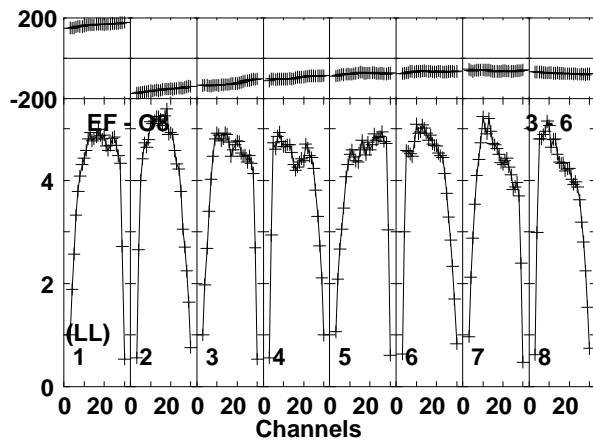
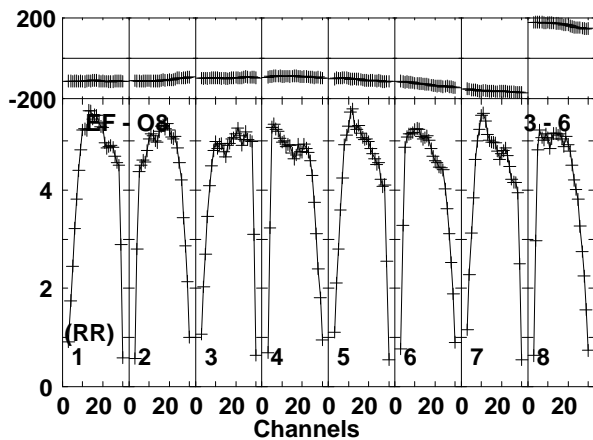
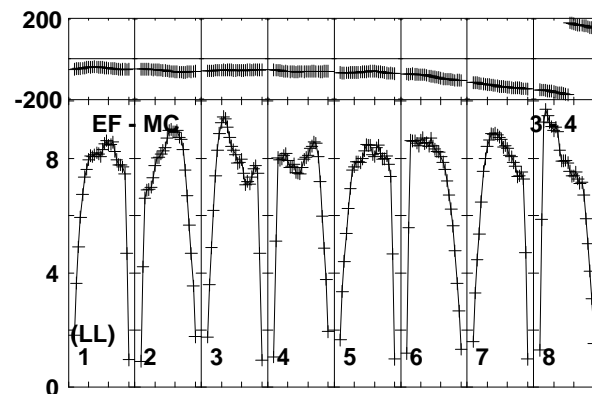
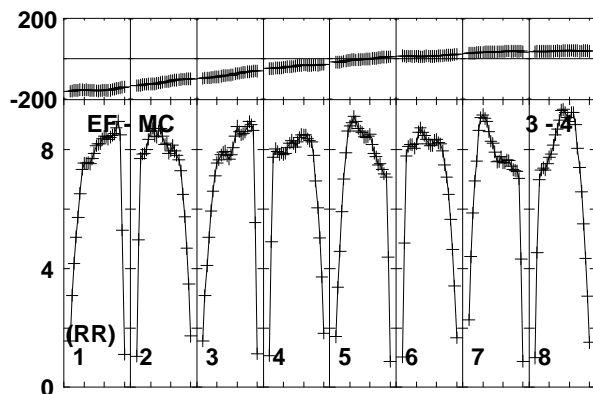
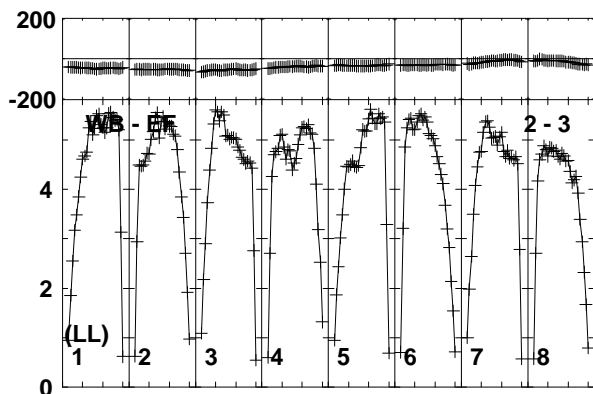
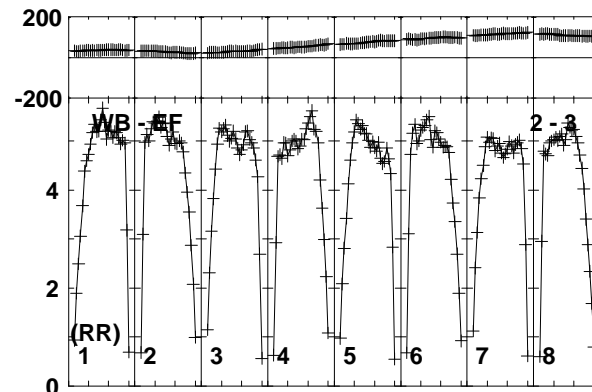
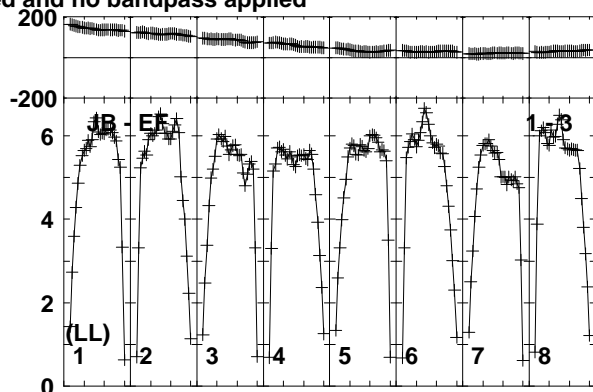
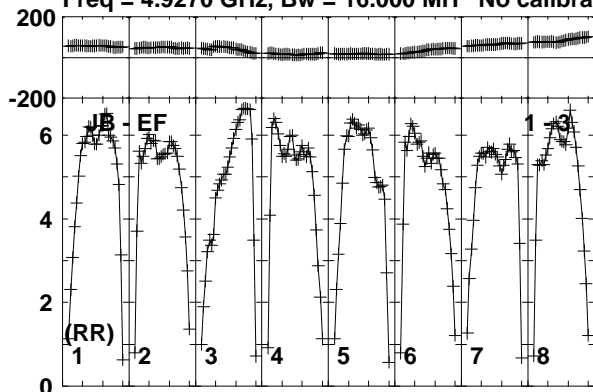

Lower frame: Milli Ampl Jy Top frame: Phas deg  
Vector averaged cross-power spectrum Baseline: JB (01) - EF (03)  
Timerange: 00/08:25:31 to 00/08:26:29

Plot file version 38 created 19-DEC-2018 17:58:15

J1619+2247 RY007C.UVDATA.1

Freq = 4.9270 GHz, Bw = 16.000 MH No calibration applied and no bandpass applied

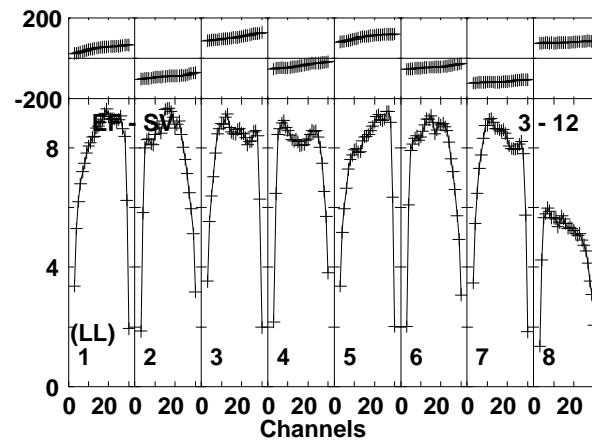
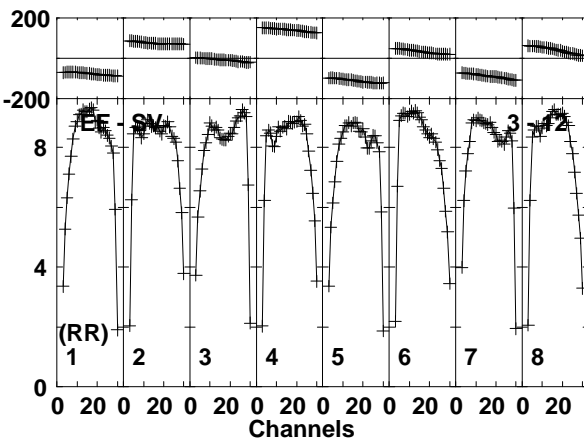
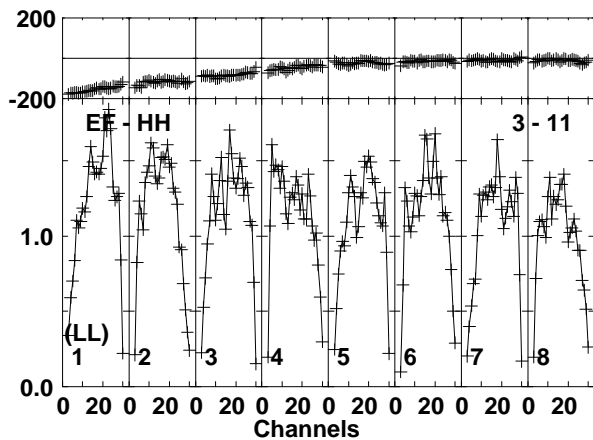
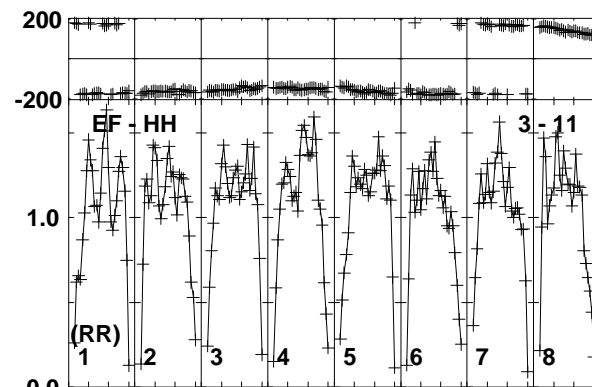
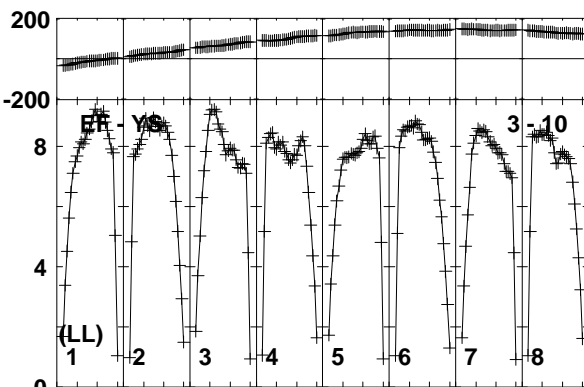
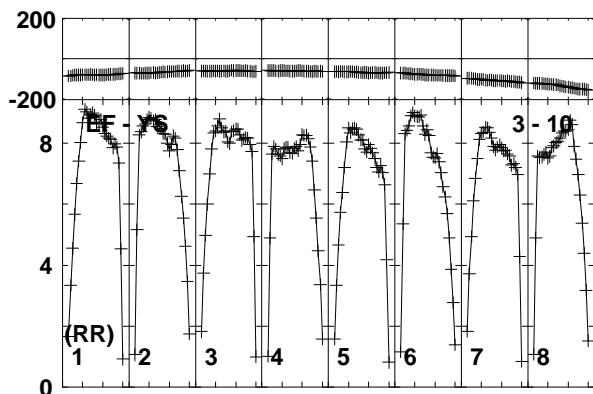
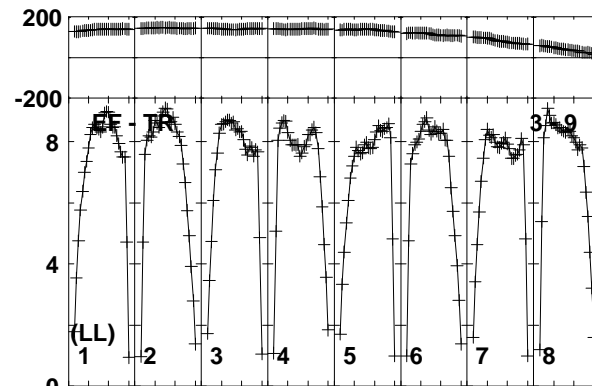
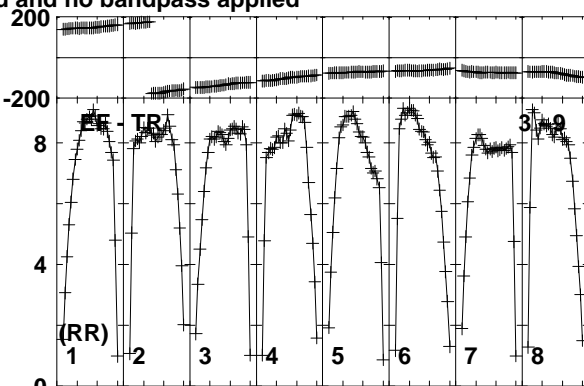
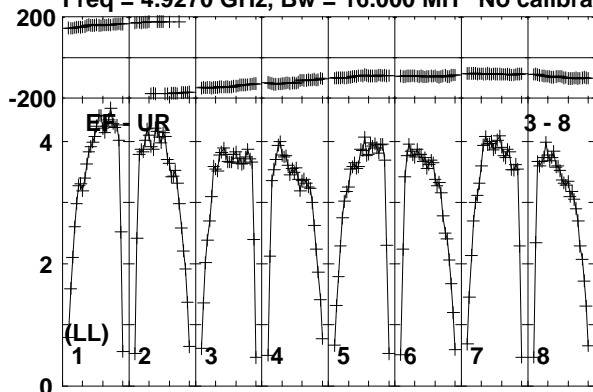

Lower frame: Milli Ampl Jy Top frame: Phas deg  
Vector averaged cross-power spectrum Baseline: EF (03) - UR (08)  
Timerange: 00/08:25:31 to 00/08:26:29

Plot file version 39 created 19-DEC-2018 17:58:15

J1619+2247 RY007C.UVDATA.1

Freq = 4.9270 GHz, Bw = 16.000 MH No calibration applied and no bandpass applied

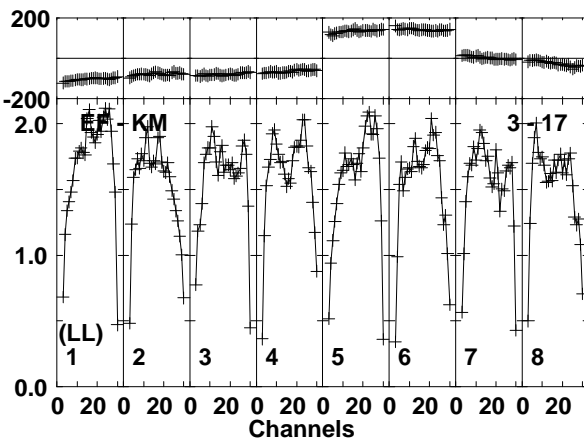
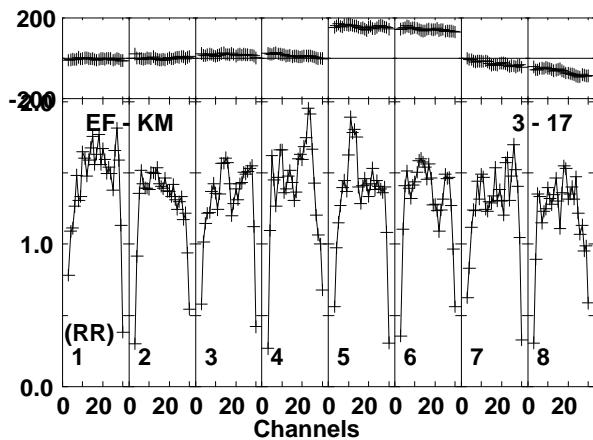
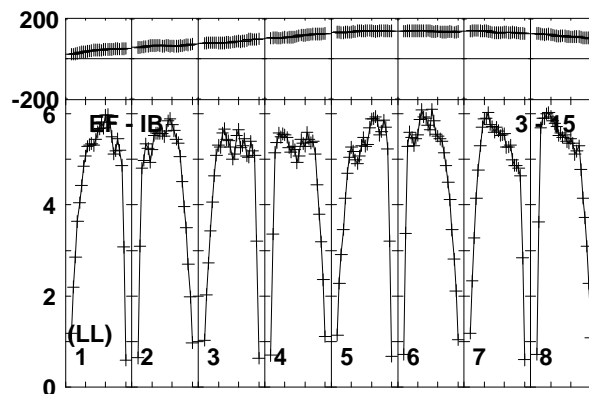
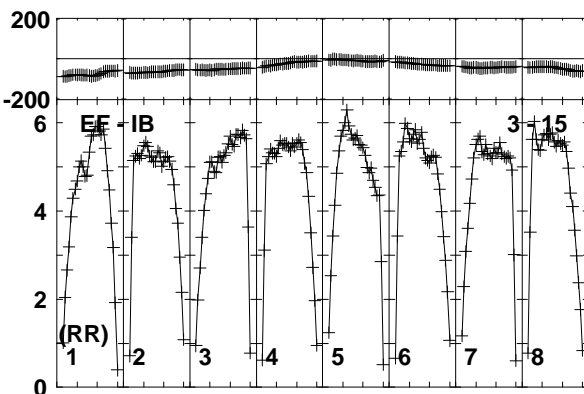
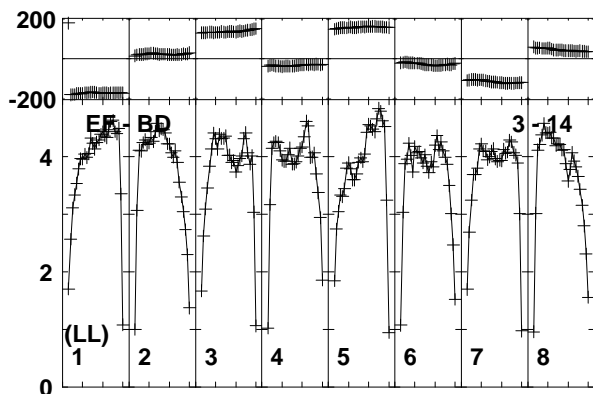
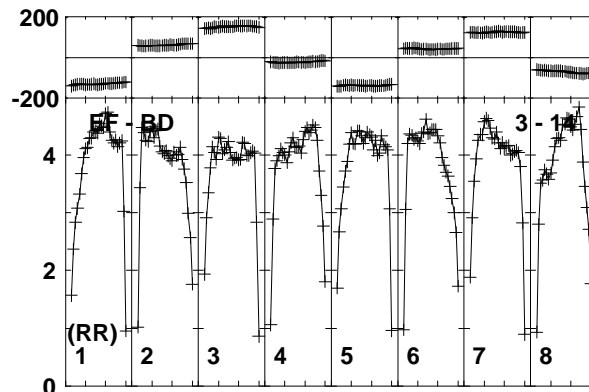
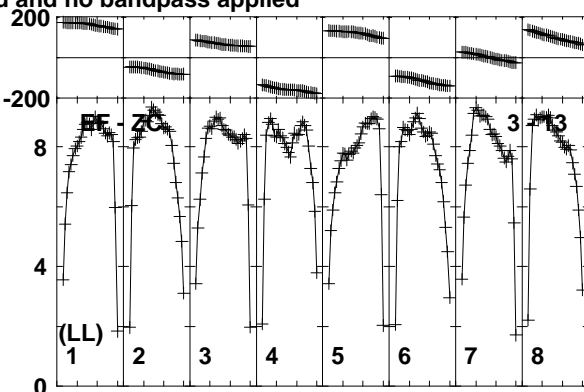
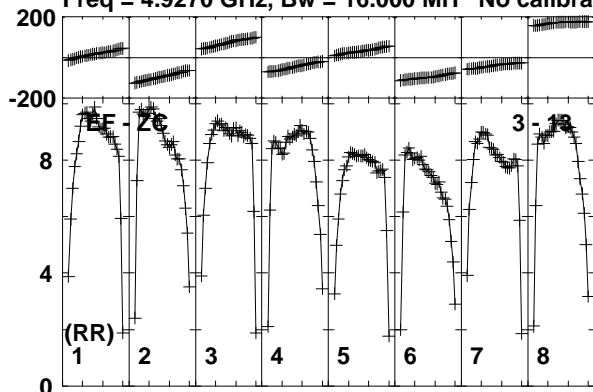

Lower frame: Milli Ampl Jy Top frame: Phas deg  
Vector averaged cross-power spectrum Baseline: EF (03) - ZC (13)  
Timerange: 00/08:25:31 to 00/08:26:29

Plot file version 40 created 19-DEC-2018 17:58:15

AT2018\_RY007C.UVDATA.1

Freq = 4.9270 GHz, Bw = 16.000 MH No calibration applied and no bandpass applied

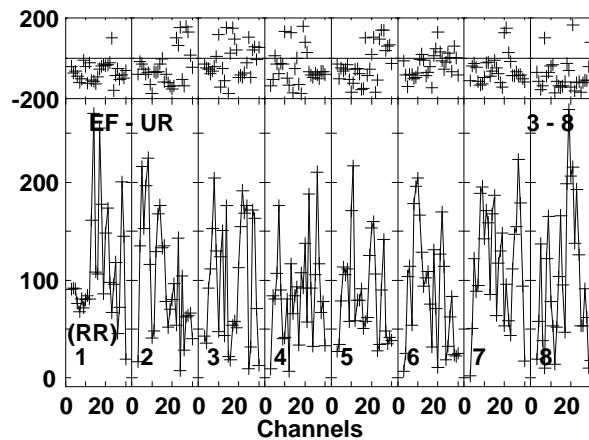
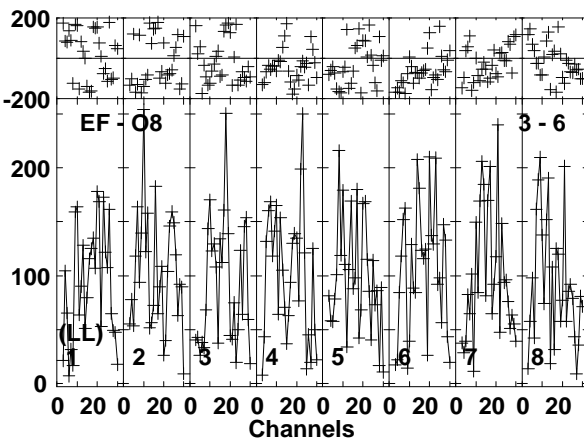
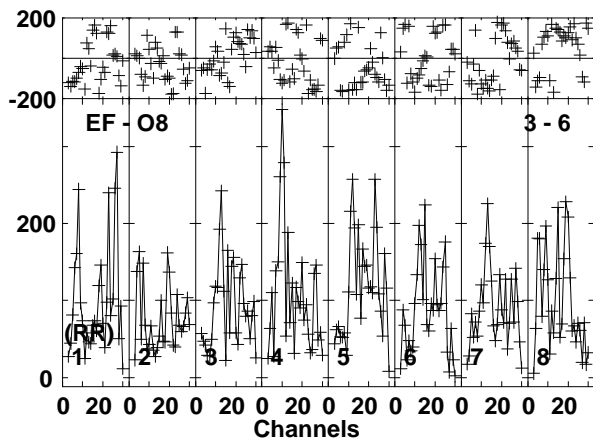
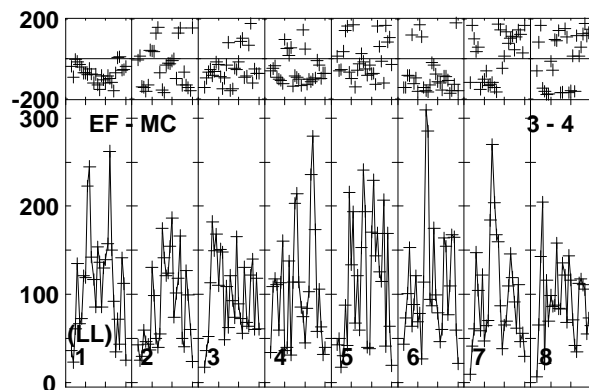
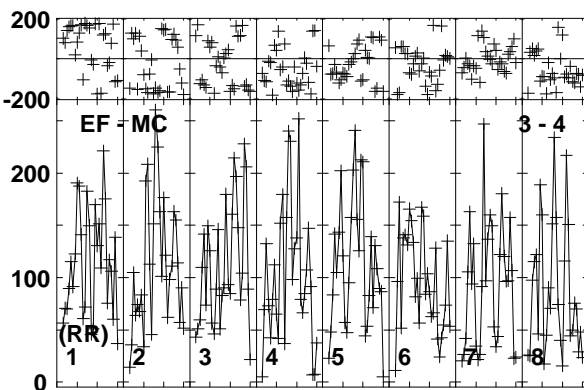
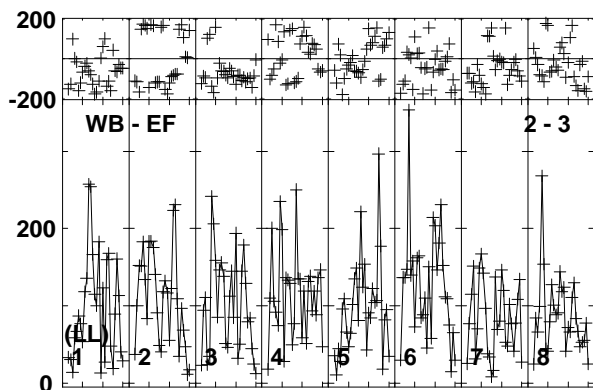
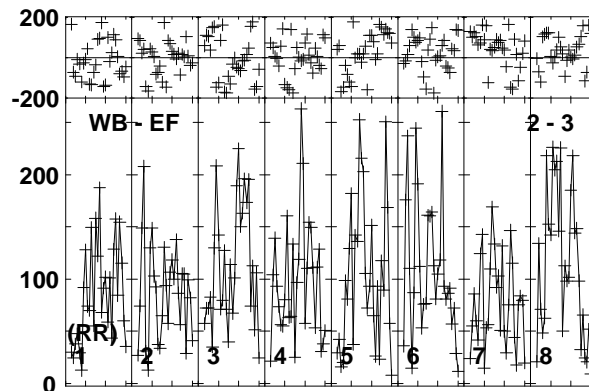
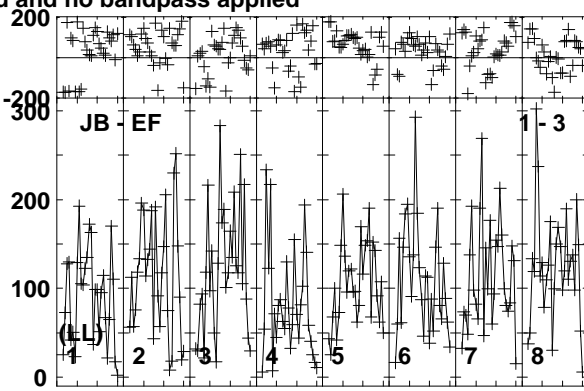
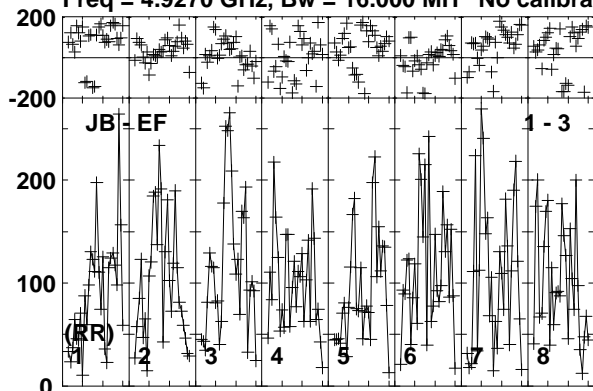

Lower frame: Micro Ampl Jy Top frame: Phas deg  
Vector averaged cross-power spectrum Baseline: JB (01) - EF (03)  
Timerange: 00/08:26:31 to 00/08:29:29

Plot file version 41 created 19-DEC-2018 17:58:16

AT2018\_RY007C.UVDATA.1

Freq = 4.9270 GHz, Bw = 16.000 MH No calibration applied and no bandpass applied

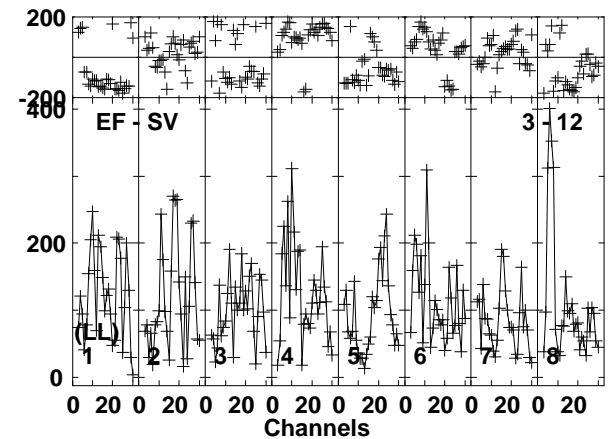
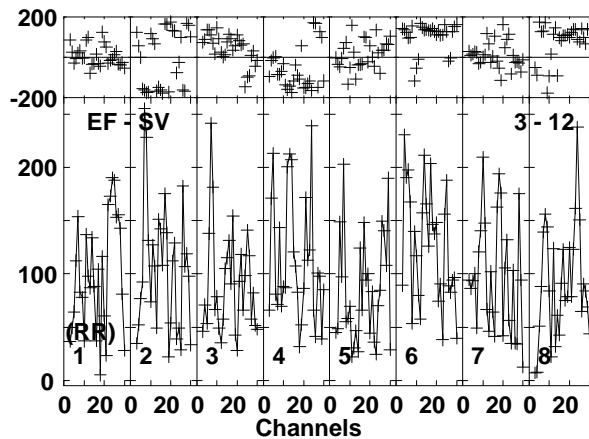
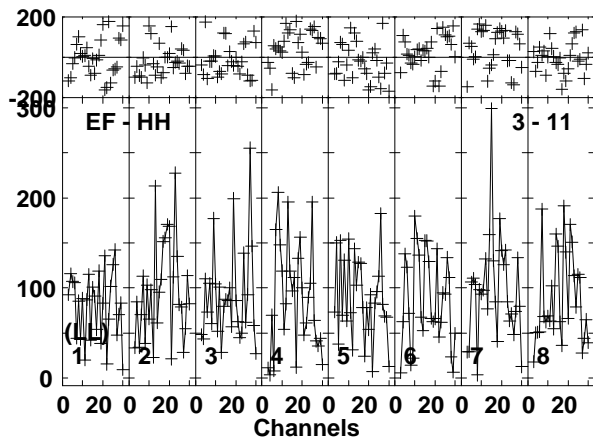
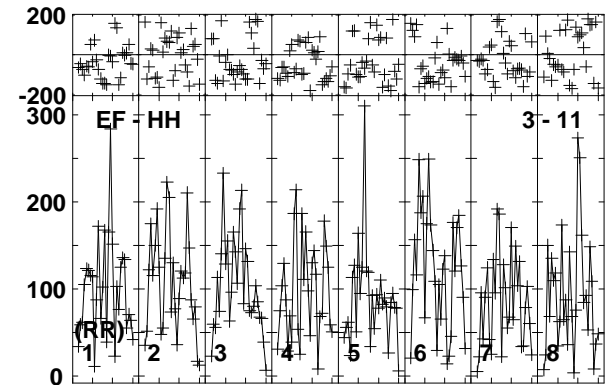
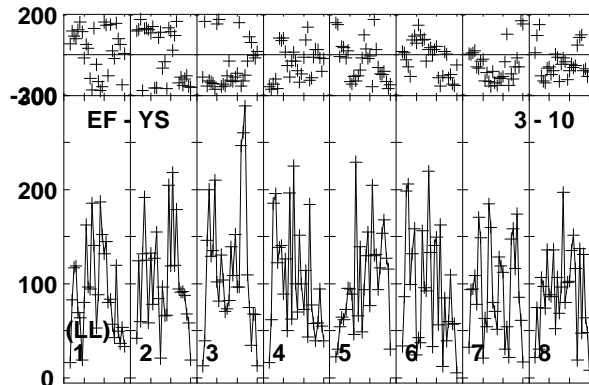
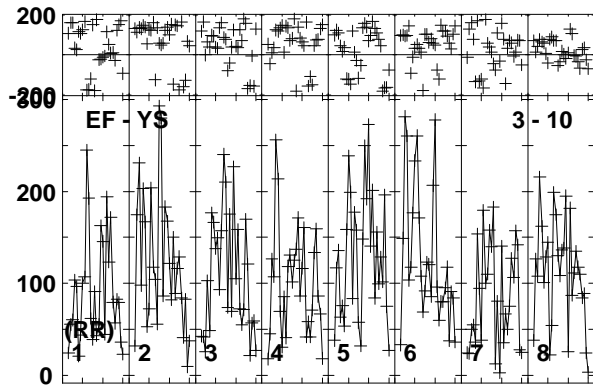
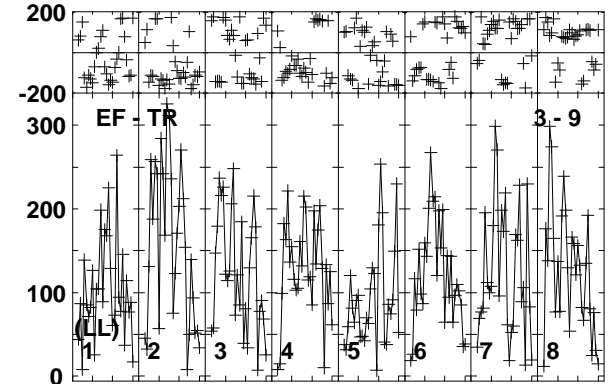
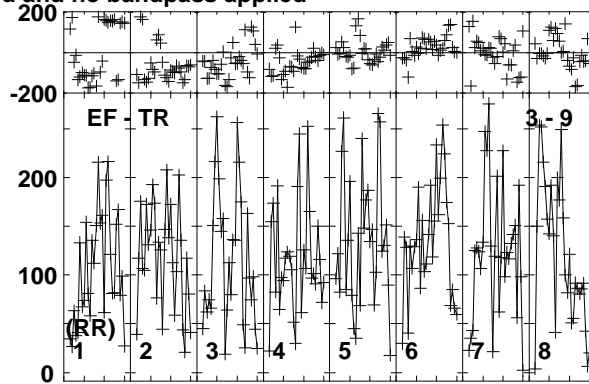
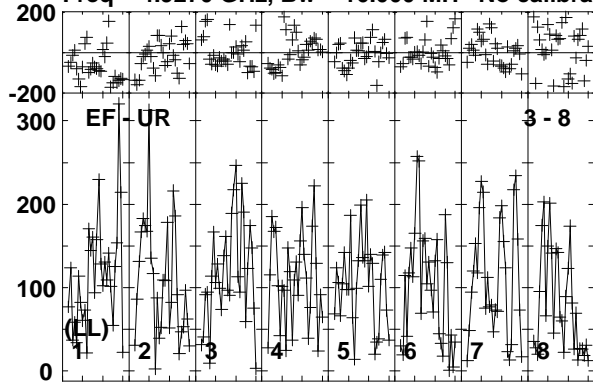

Lower frame: Micro Ampl Jy Top frame: Phas deg  
Vector averaged cross-power spectrum Baseline: EF (03) - UR (08)  
Timerange: 00/08:26:31 to 00/08:29:29

Plot file version 42 created 19-DEC-2018 17:58:16

AT2018\_RY007C.UVDATA.1

Freq = 4.9270 GHz, Bw = 16.000 MH No calibration applied and no bandpass applied

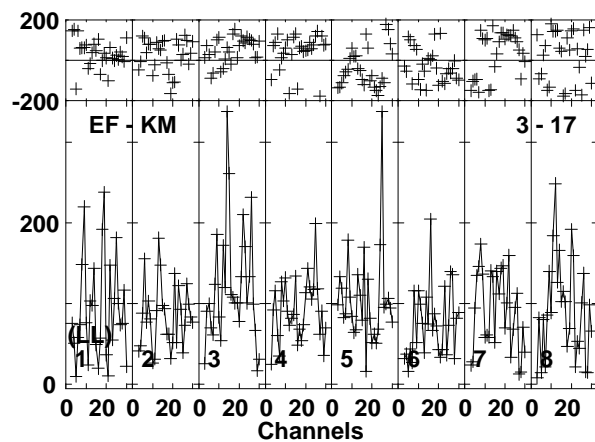
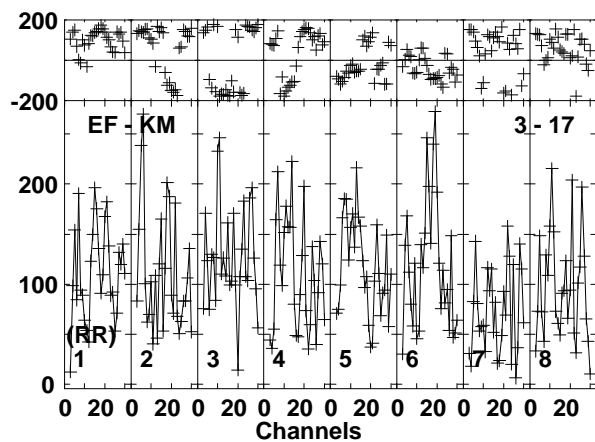
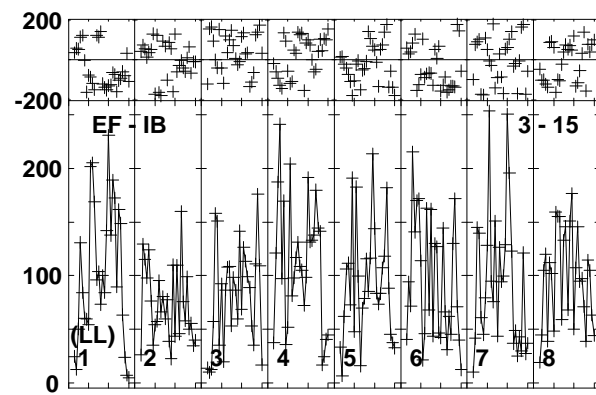
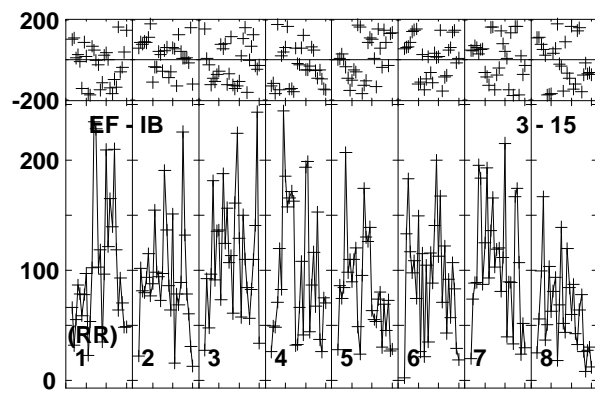
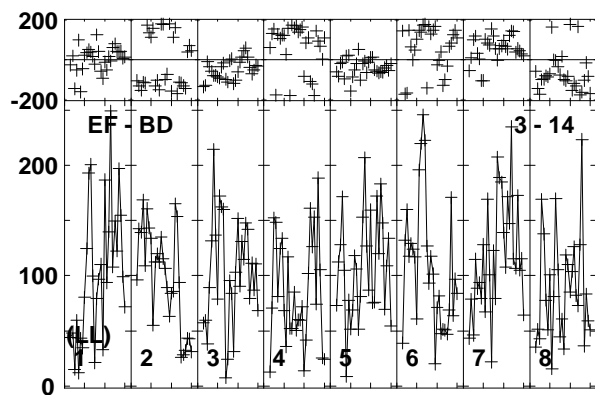
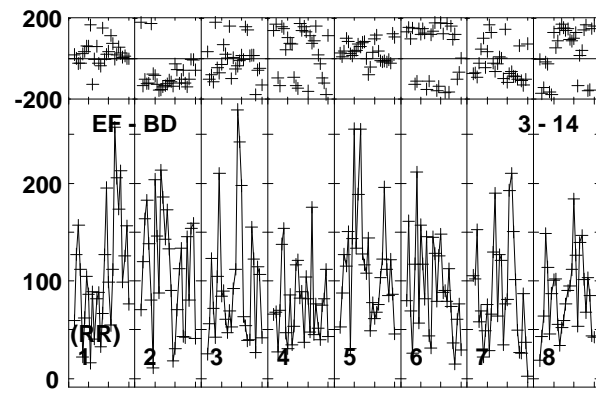
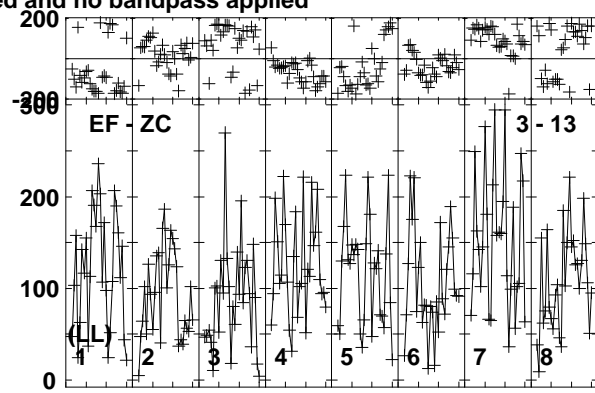
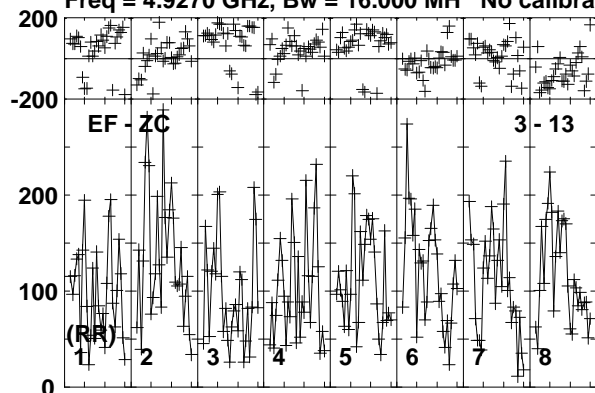

Lower frame: Micro Ampl Jy Top frame: Phas deg  
Vector averaged cross-power spectrum Baseline: EF (03) - ZC (13)  
Timerange: 00/08:26:31 to 00/08:29:29



Plot file version 43 created 19-DEC-2018 17:58:16

J1619+2247 RY007C.UVDATA.1

Freq = 4.9270 GHz, Bw = 16.000 MH No calibration applied and no bandpass applied

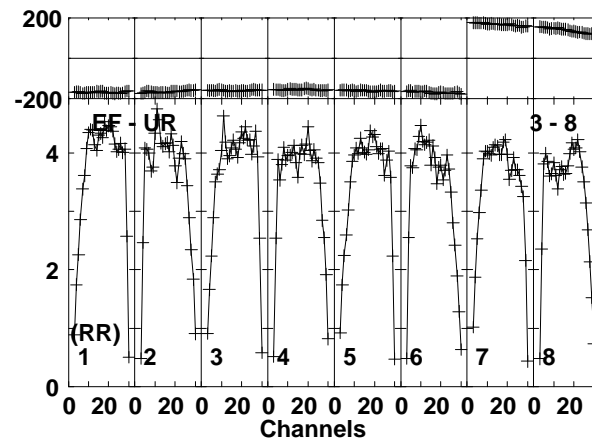
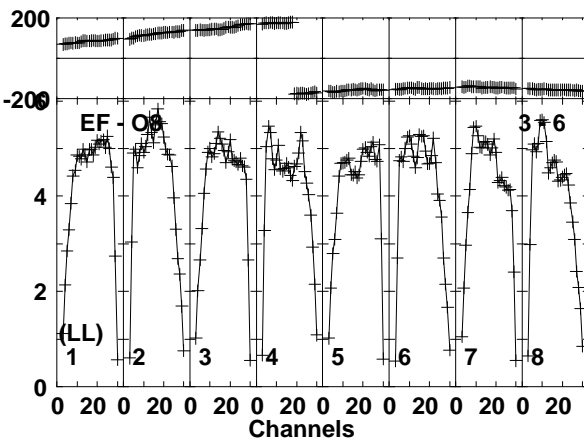
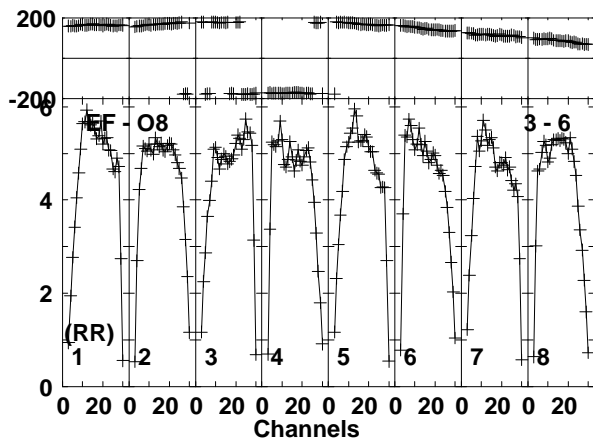
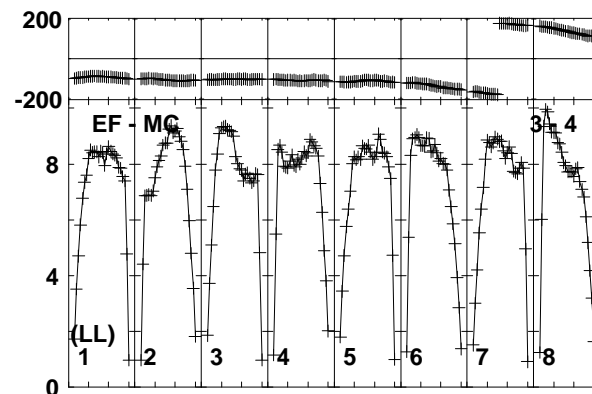
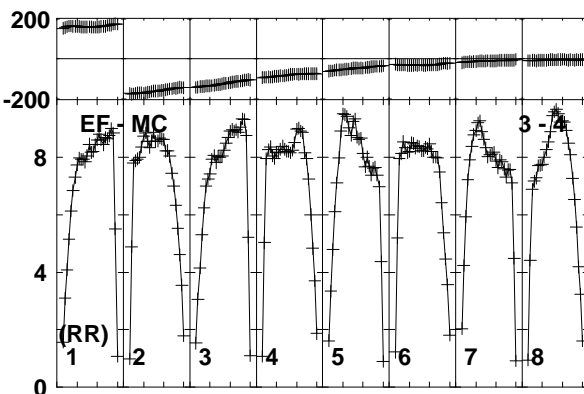
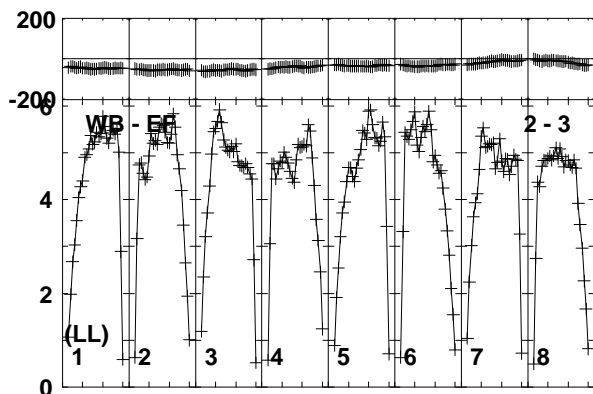
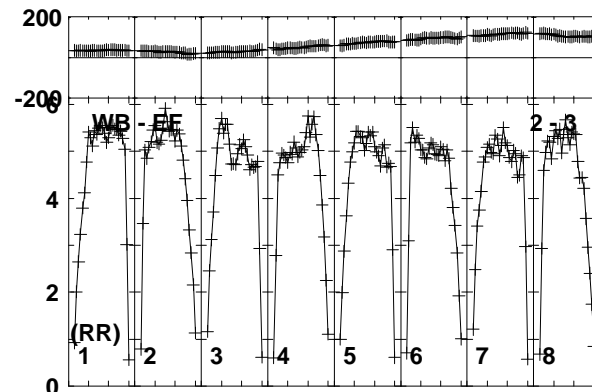
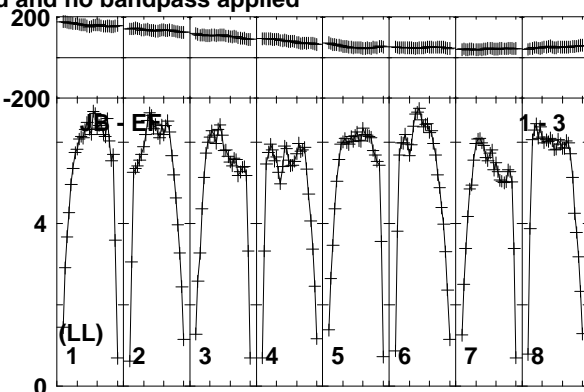
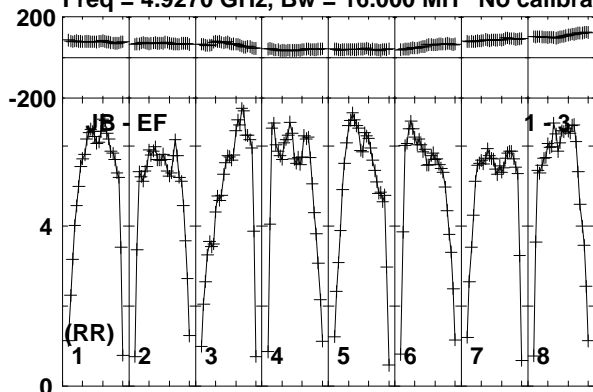

Lower frame: Milli Ampl Jy Top frame: Phas deg  
Vector averaged cross-power spectrum Baseline: JB (01) - EF (03)  
Timerange: 00/08:29:31 to 00/08:30:29

Plot file version 44 created 19-DEC-2018 17:58:16

J1619+2247 RY007C.UVDATA.1

Freq = 4.9270 GHz, Bw = 16.000 MH No calibration applied and no bandpass applied

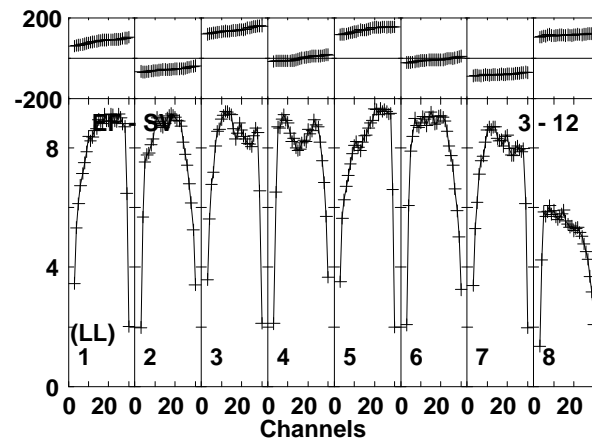
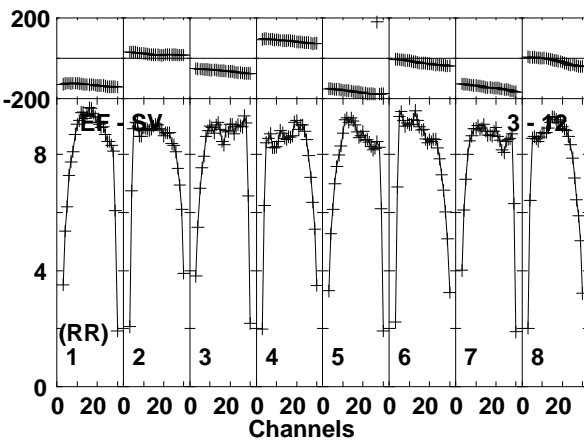
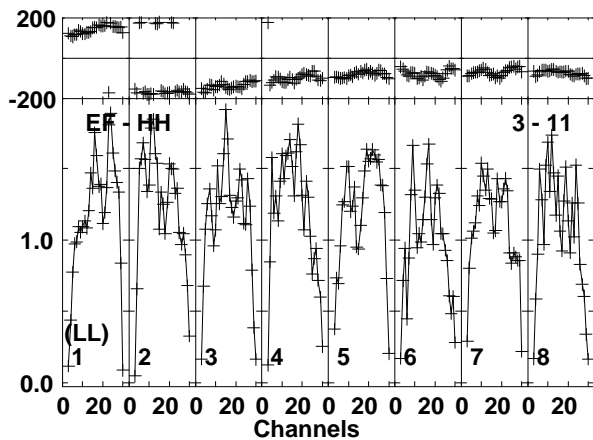
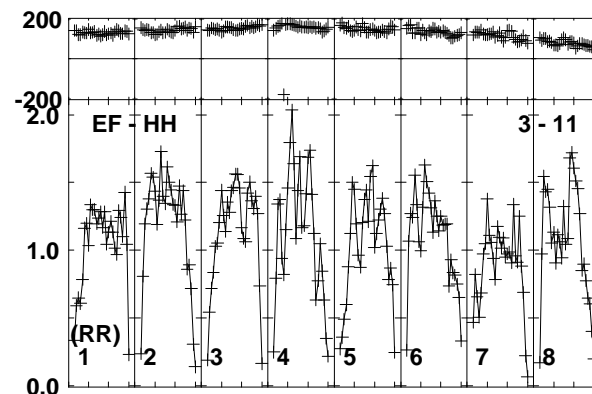
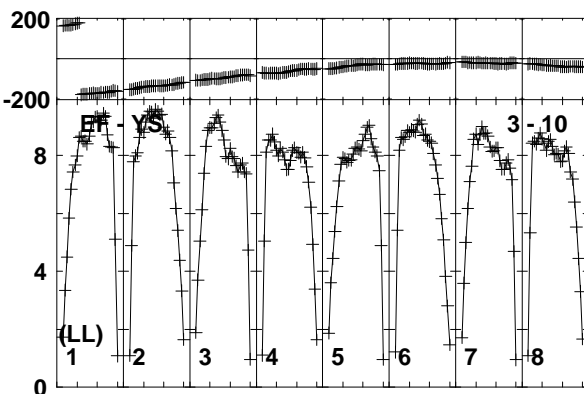
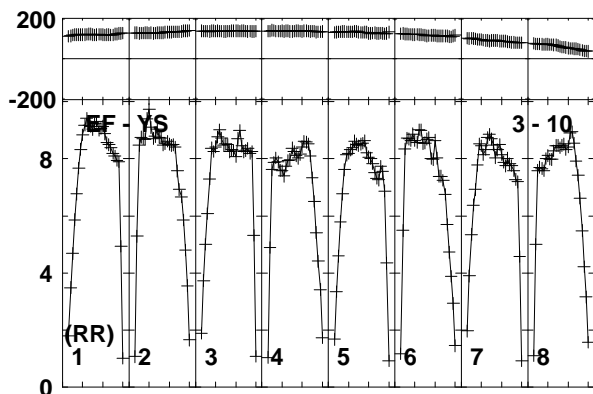
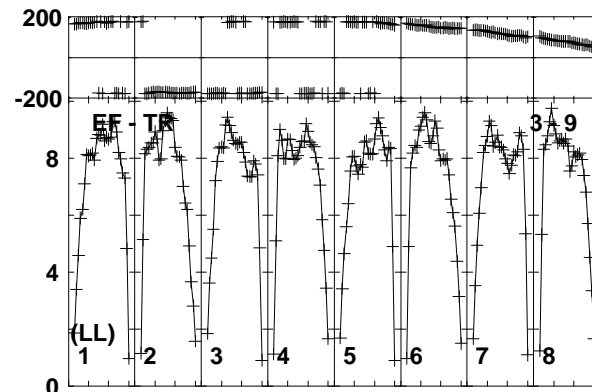
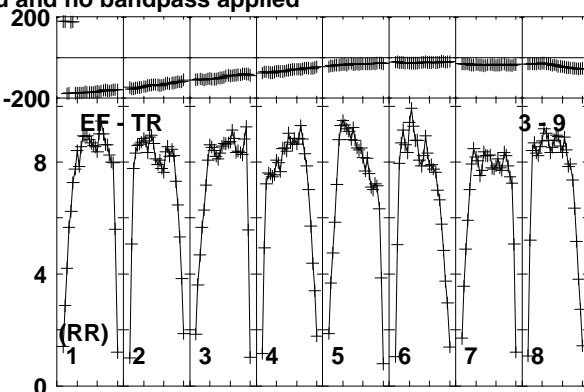
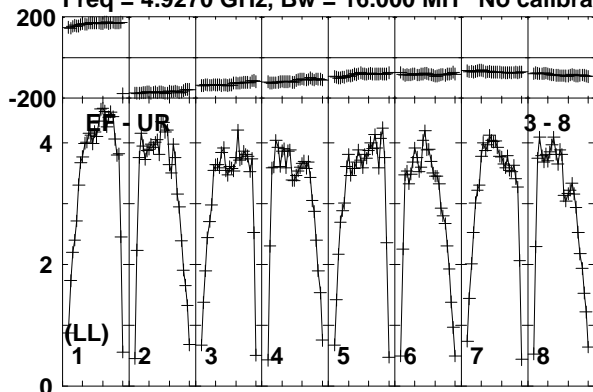

Lower frame: Milli Ampl Jy Top frame: Phas deg  
Vector averaged cross-power spectrum Baseline: EF (03) - UR (08)  
Timerange: 00/08:29:31 to 00/08:30:29

Plot file version 45 created 19-DEC-2018 17:58:16

J1619+2247 RY007C.UVDATA.1

Freq = 4.9270 GHz, Bw = 16.000 MH No calibration applied and no bandpass applied

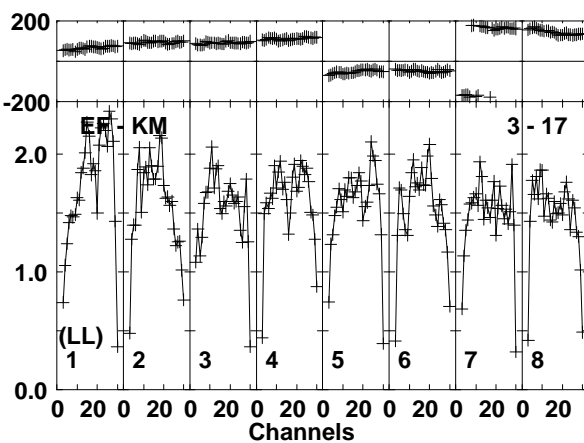
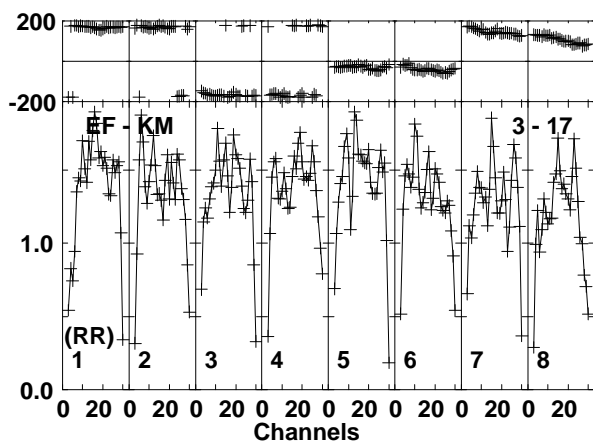
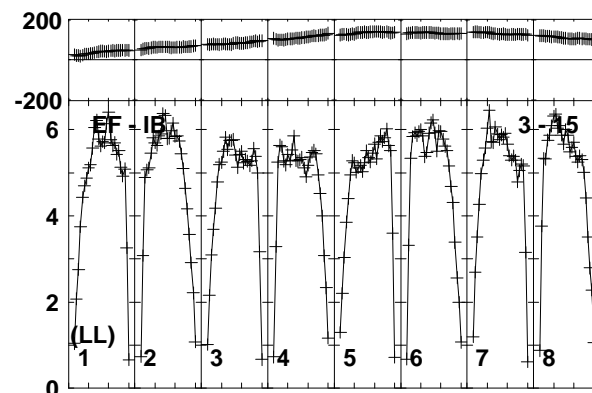
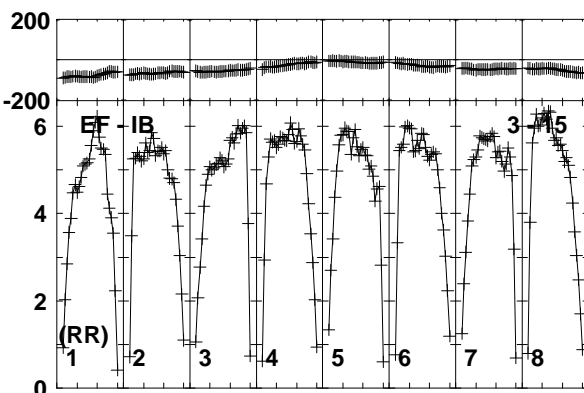
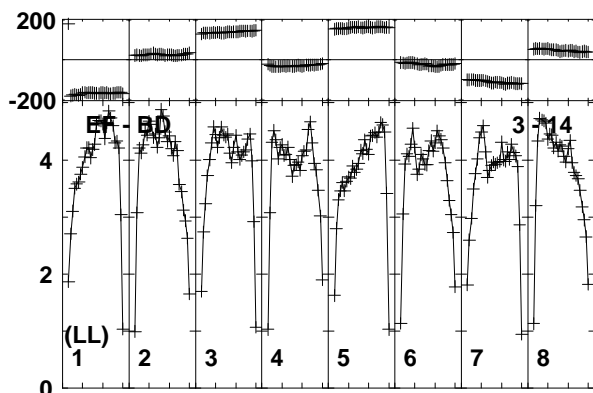
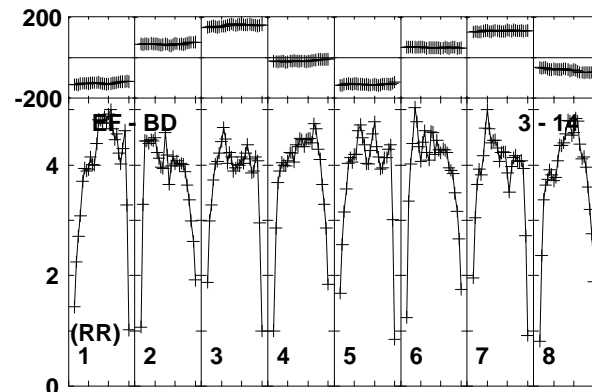
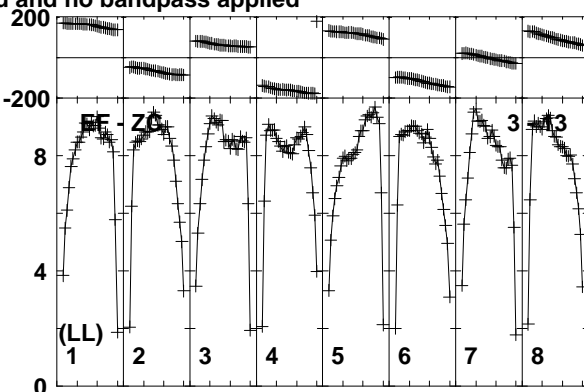
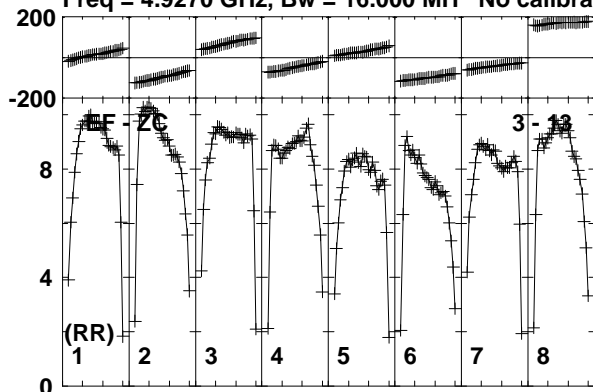

Lower frame: Milli Ampl Jy Top frame: Phas deg  
Vector averaged cross-power spectrum Baseline: EF (03) - ZC (13)  
Timerange: 00/08:29:31 to 00/08:30:29

Plot file version 46 created 19-DEC-2018 17:58:16

AT2018\_RY007C.UVDATA.1

Freq = 4.9270 GHz, Bw = 16.000 MH No calibration applied and no bandpass applied

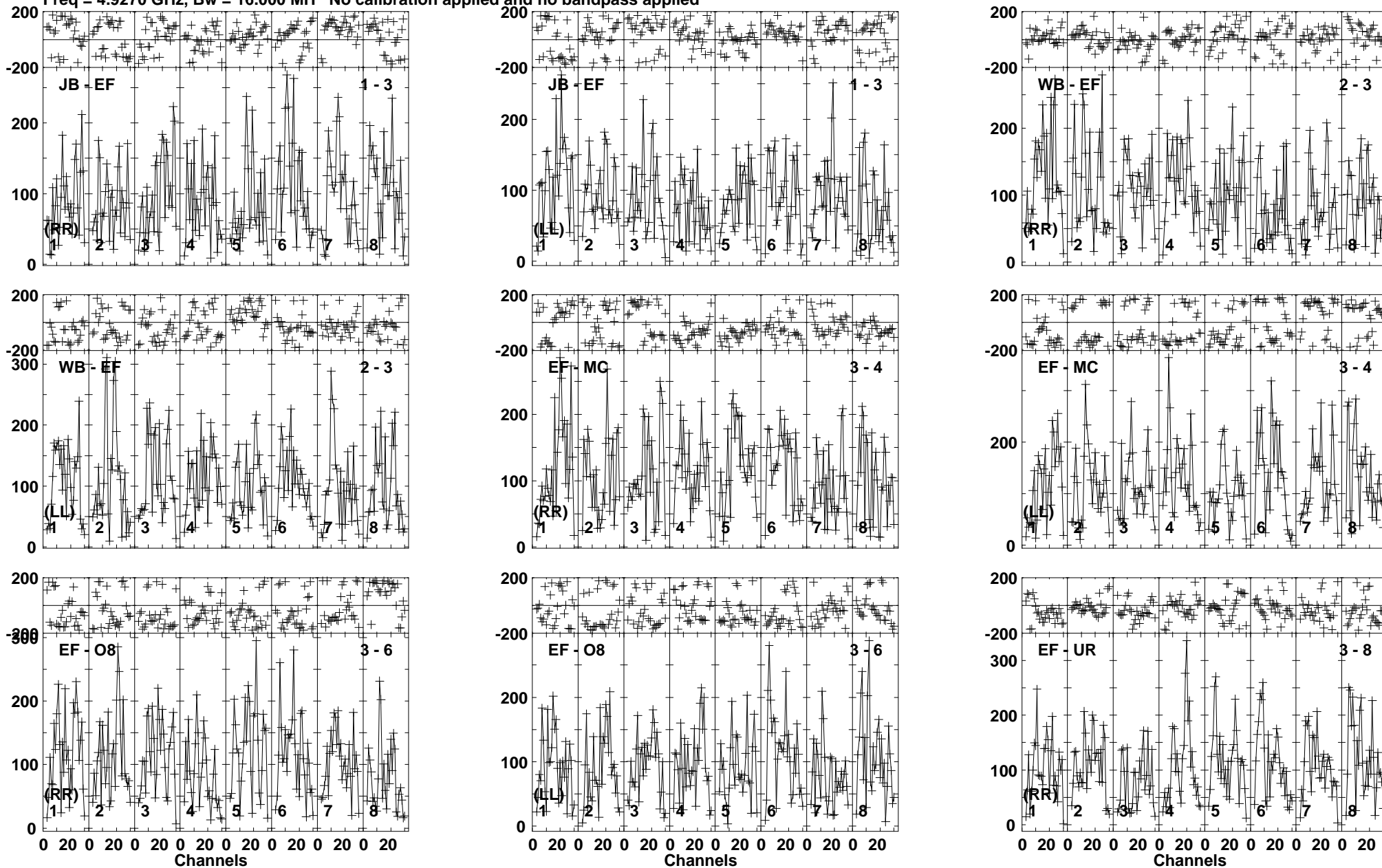

Lower frame: Micro Ampl Jy Top frame: Phas deg  
Vector averaged cross-power spectrum Baseline: JB (01) - EF (03)  
Timerange: 00/08:30:31 to 00/08:33:29

Plot file version 47 created 19-DEC-2018 17:58:16

AT2018\_RY007C.UVDATA.1

Freq = 4.9270 GHz, Bw = 16.000 MH No calibration applied and no bandpass applied

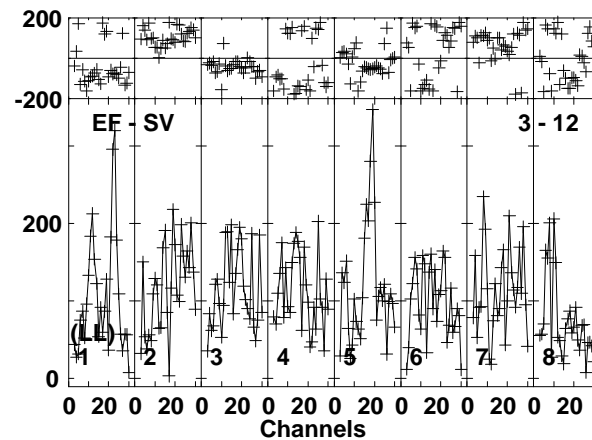
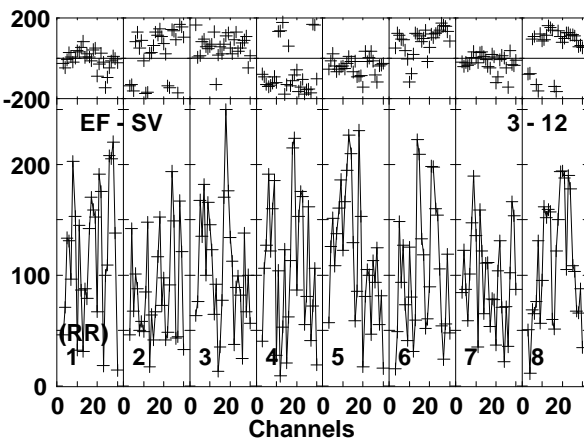
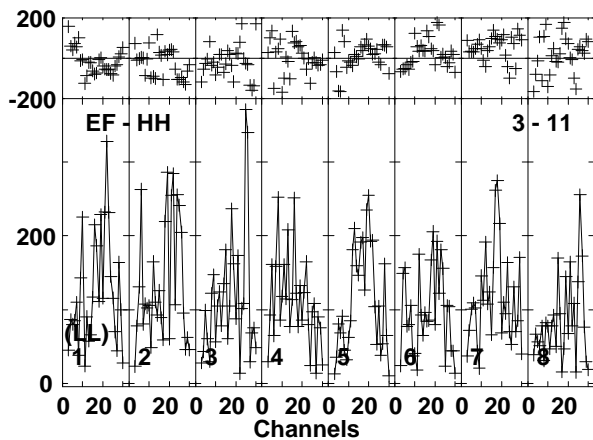
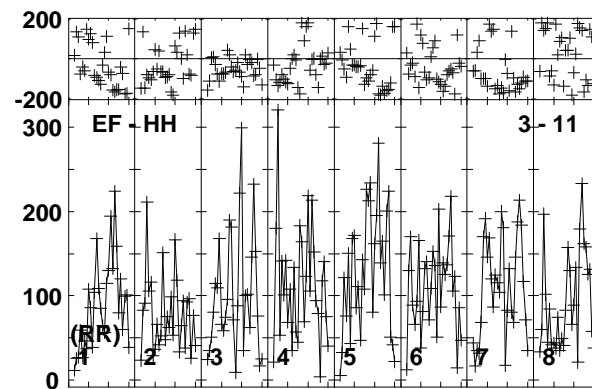
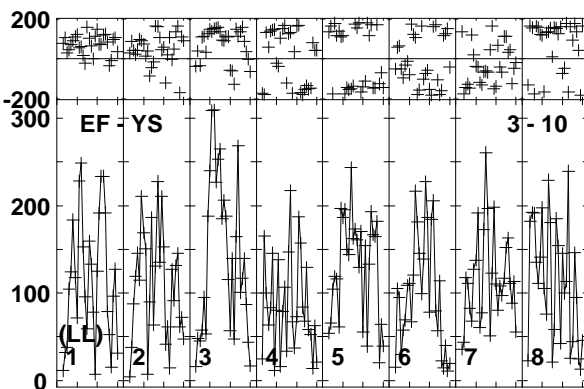
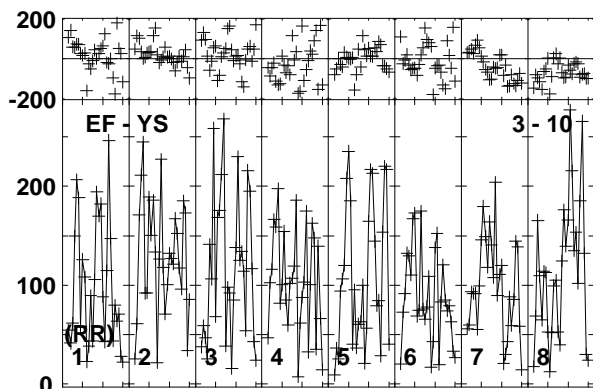
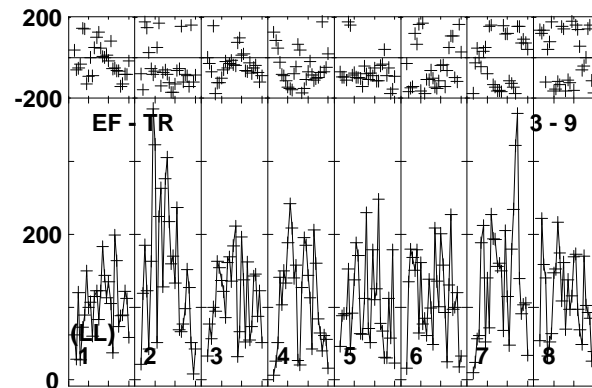
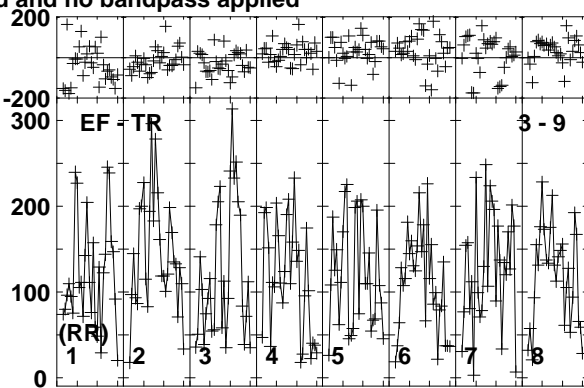
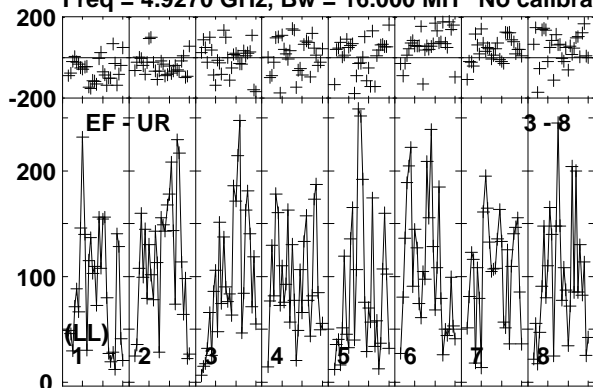

Lower frame: Micro Ampl Jy Top frame: Phas deg  
Vector averaged cross-power spectrum Baseline: EF (03) - UR (08)  
Timerange: 00/08:30:31 to 00/08:33:29

Plot file version 48 created 19-DEC-2018 17:58:16

AT2018\_RY007C.UVDATA.1

Freq = 4.9270 GHz, Bw = 16.000 MH No calibration applied and no bandpass applied

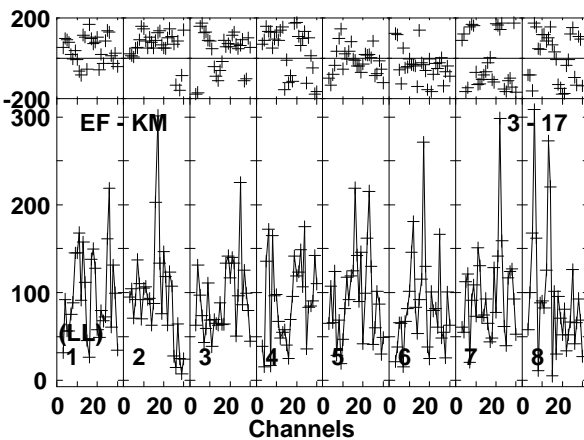
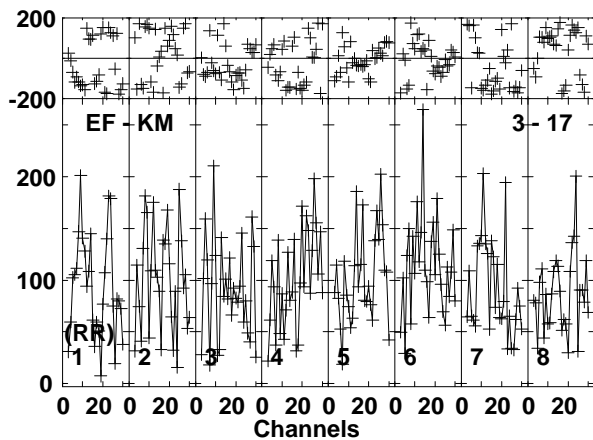
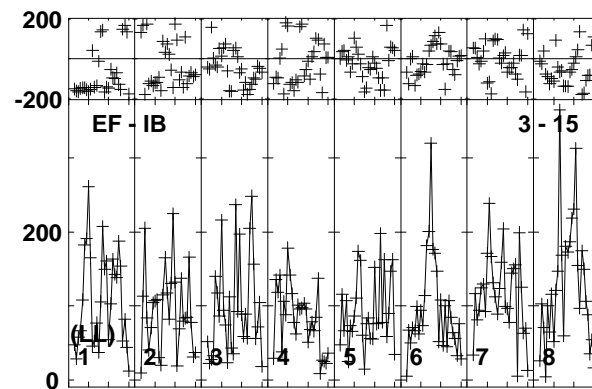
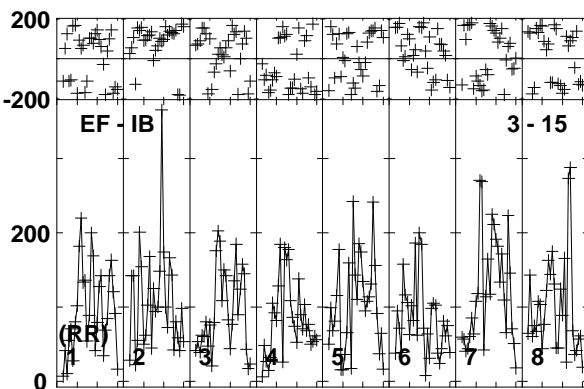
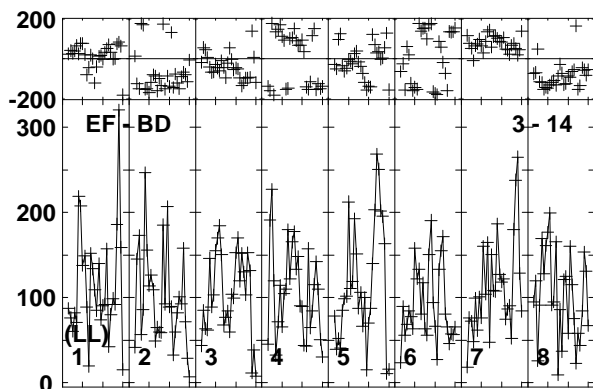
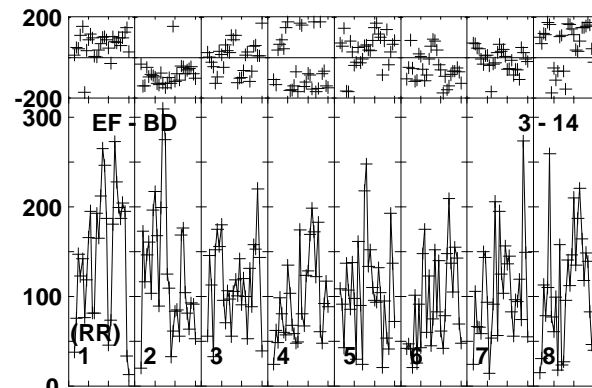
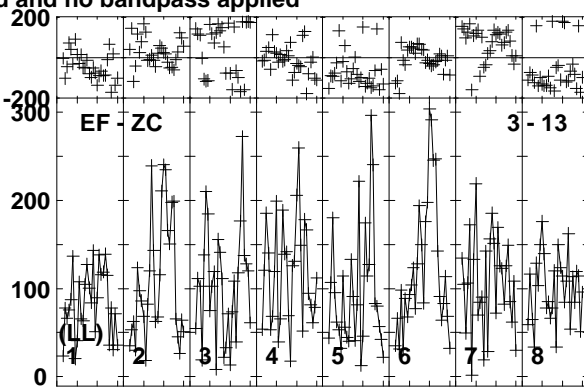
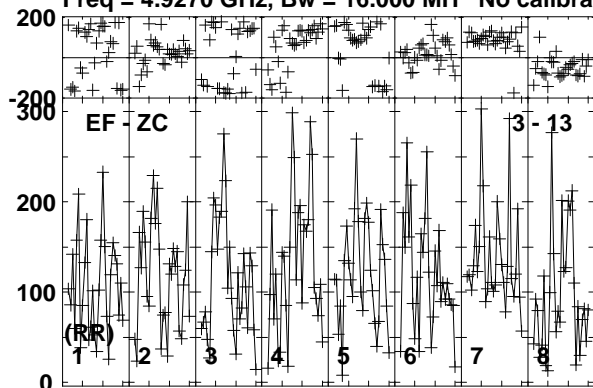

Lower frame: Micro Ampl Jy Top frame: Phas deg  
Vector averaged cross-power spectrum Baseline: EF (03) - ZC (13)  
Timerange: 00/08:30:31 to 00/08:33:29

Plot file version 49 created 19-DEC-2018 17:58:16

J1619+2247 RY007C.UVDATA.1

Freq = 4.9270 GHz, Bw = 16.000 MH No calibration applied and no bandpass applied

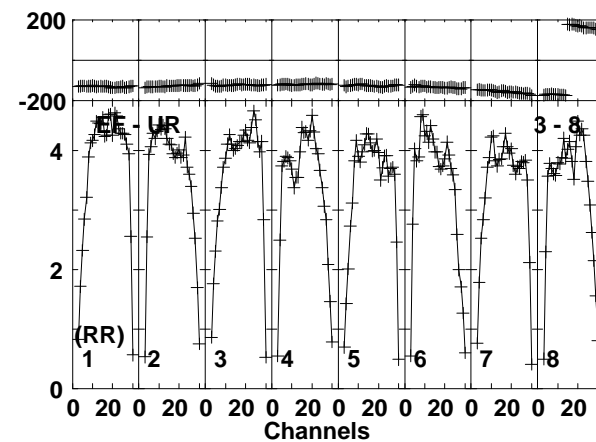
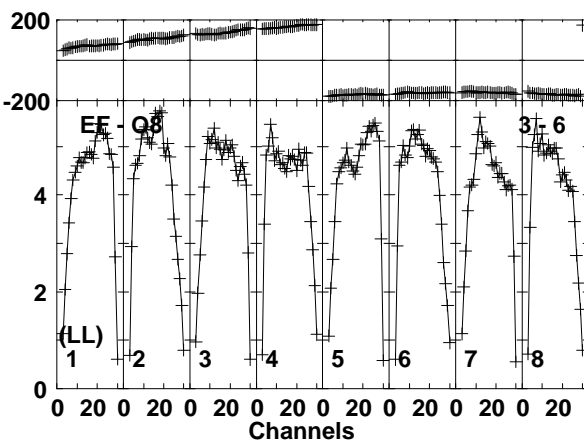
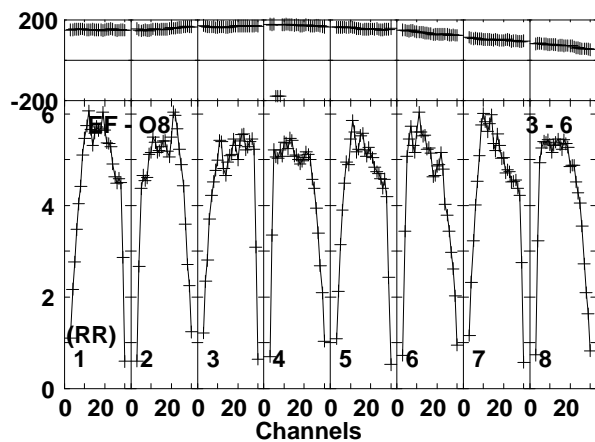
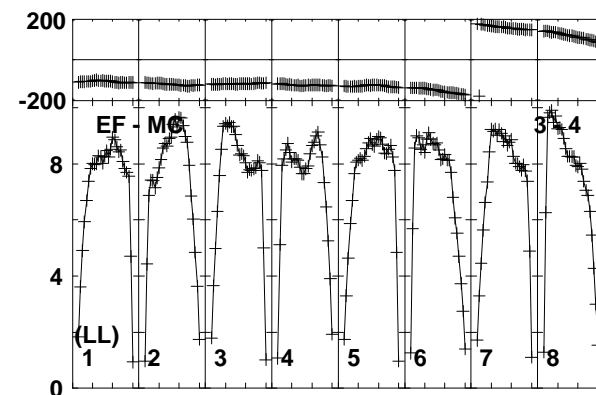
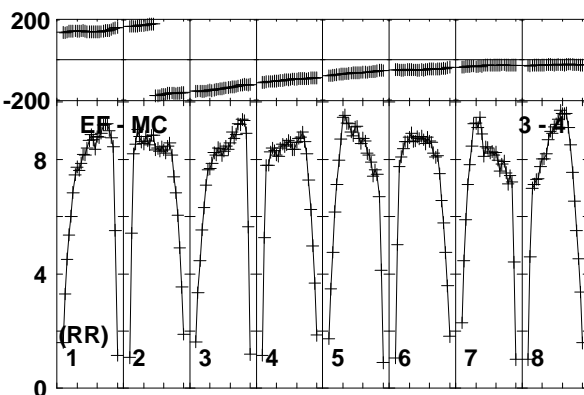
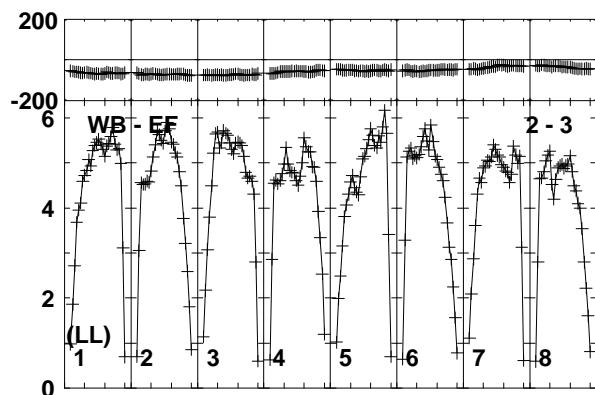
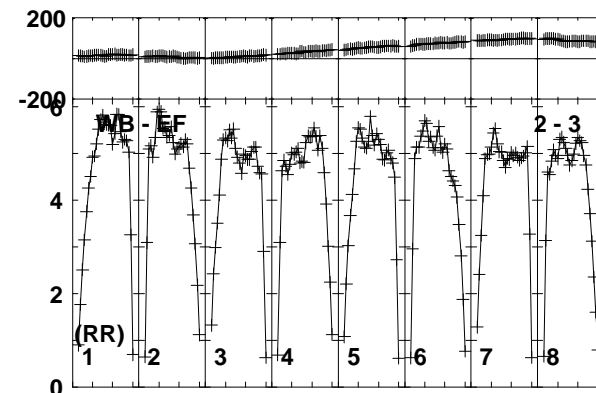
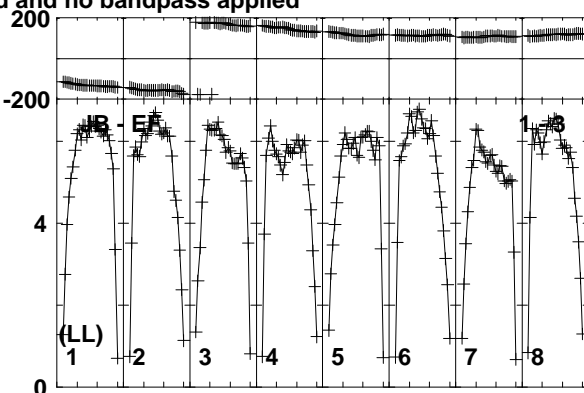
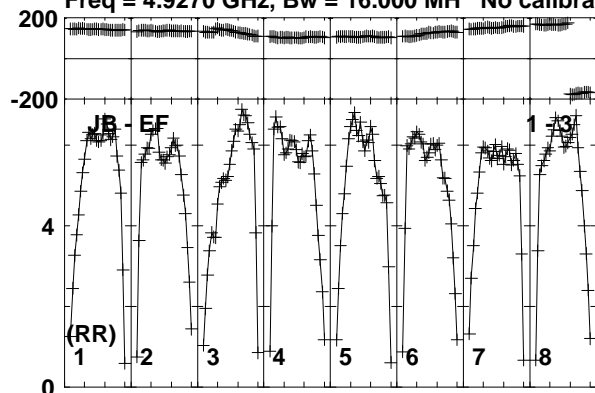

Lower frame: Milli Ampl Jy Top frame: Phas deg  
Vector averaged cross-power spectrum Baseline: JB (01) - EF (03)  
Timerange: 00/08:33:31 to 00/08:34:29

Plot file version 50 created 19-DEC-2018 17:58:16

J1619+2247 RY007C.UVDATA.1

Freq = 4.9270 GHz, Bw = 16.000 MH No calibration applied and no bandpass applied

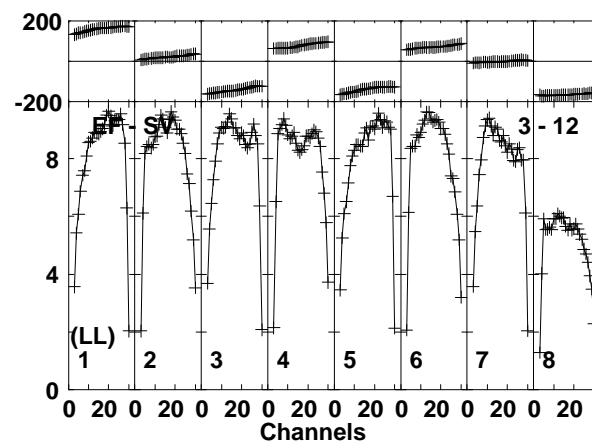
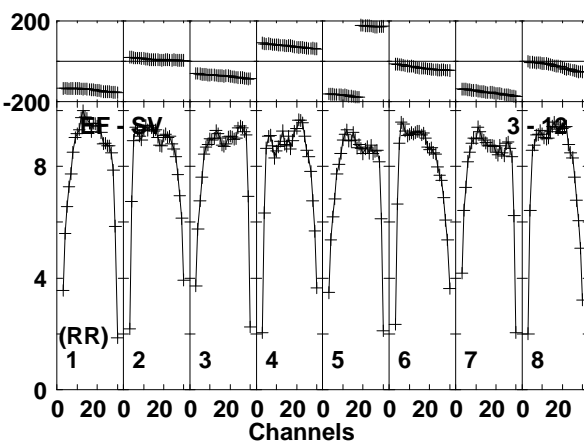
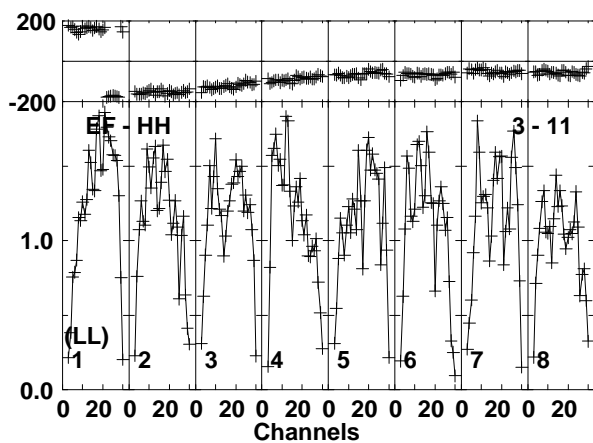
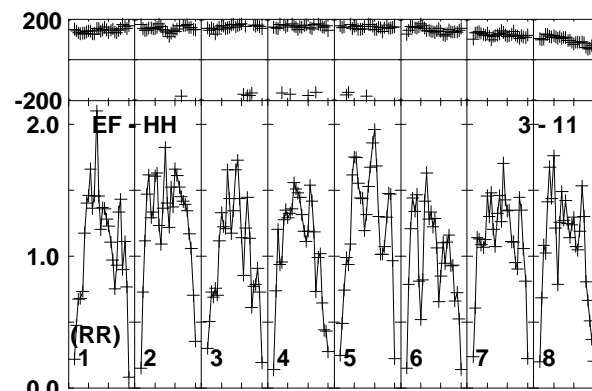
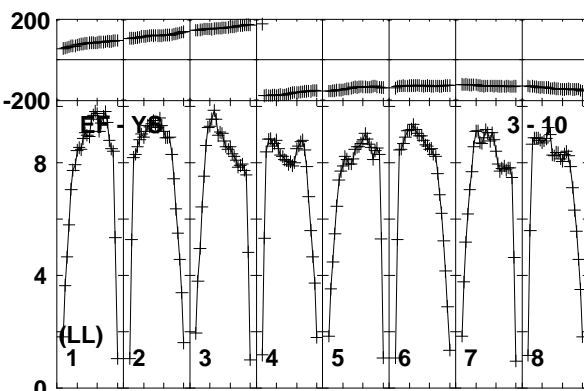
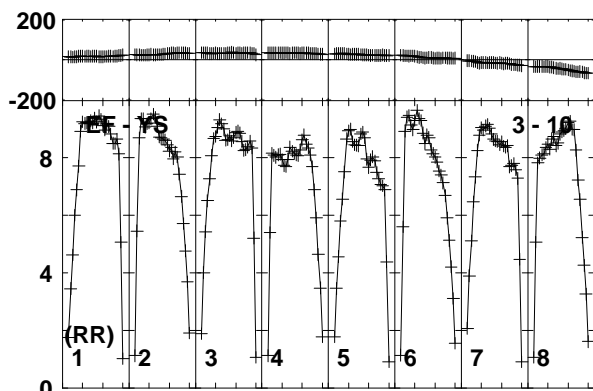
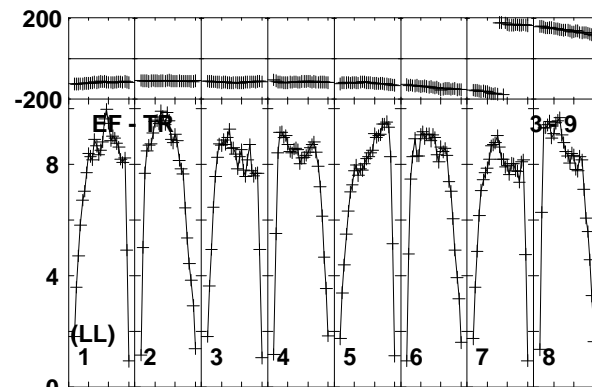
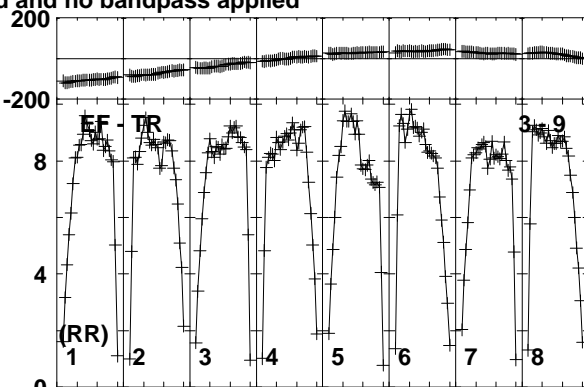
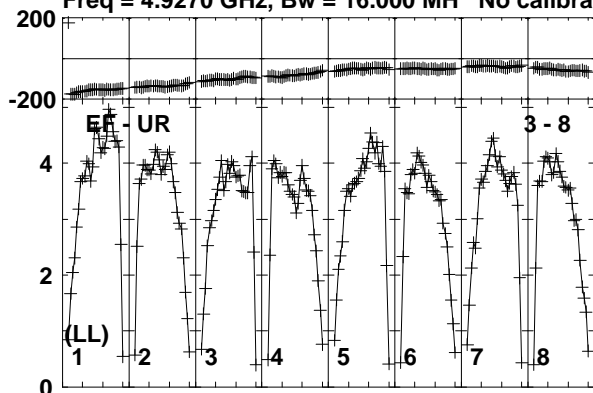

Lower frame: Milli Ampl Jy Top frame: Phas deg  
Vector averaged cross-power spectrum Baseline: EF (03) - UR (08)  
Timerange: 00/08:33:31 to 00/08:34:29



Plot file version 51 created 19-DEC-2018 17:58:16

J1619+2247 RY007C.UVDATA.1

Freq = 4.9270 GHz, Bw = 16.000 MH No calibration applied and no bandpass applied

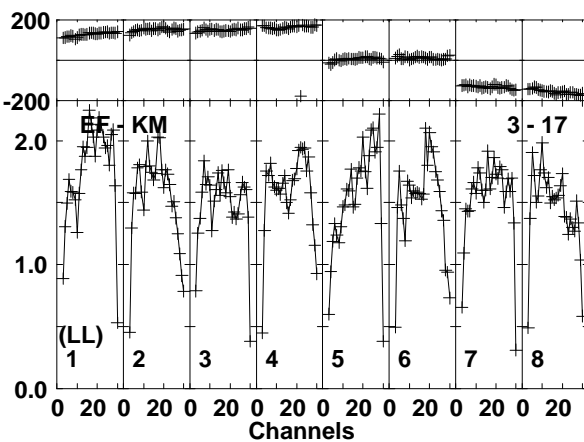
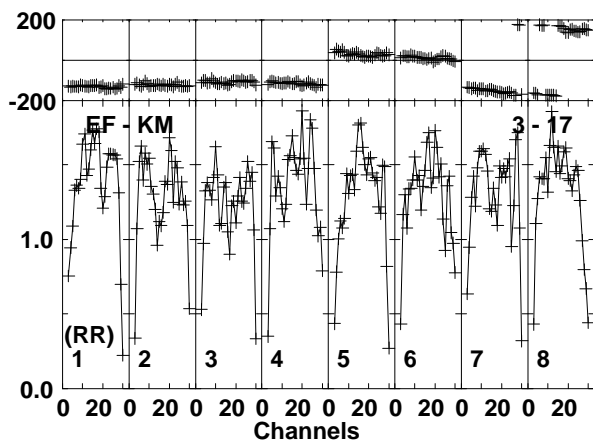
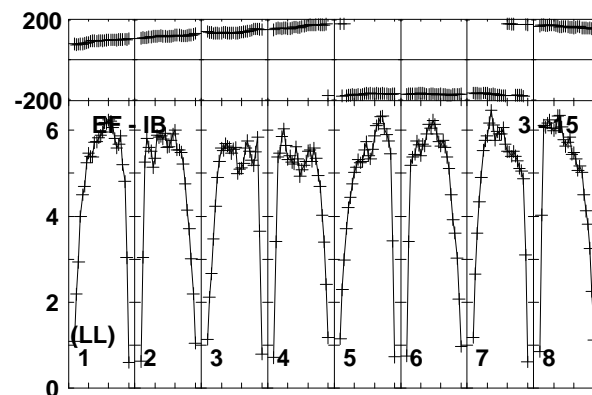
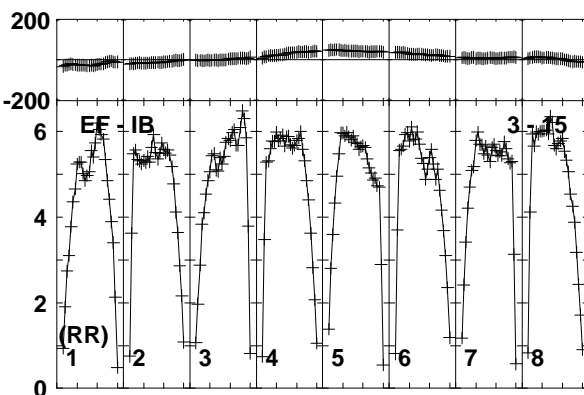
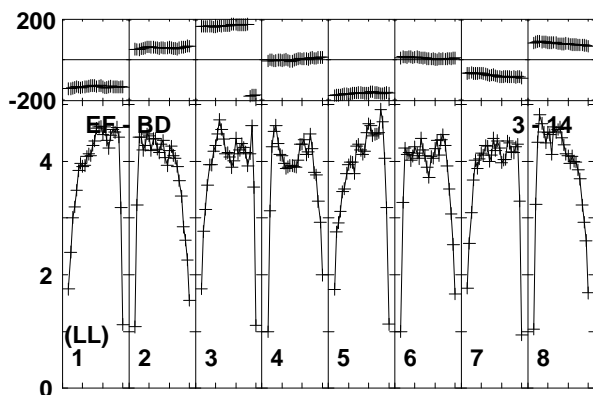
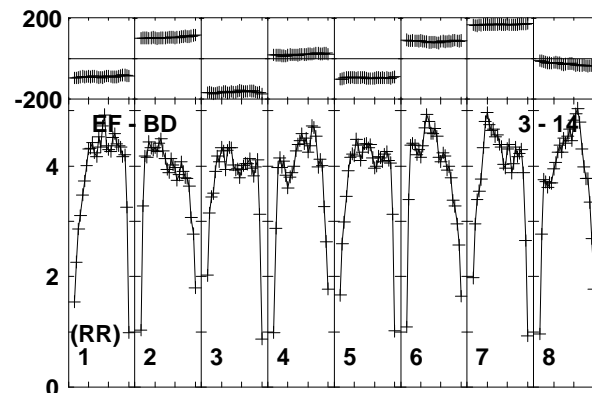
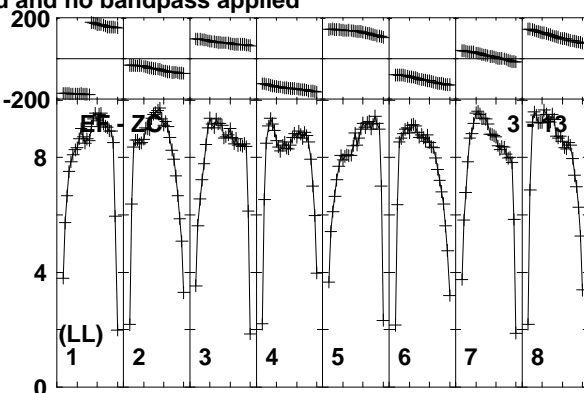
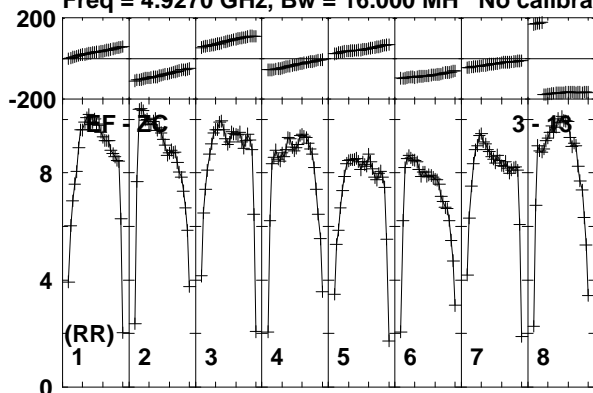

Lower frame: Milli Ampl Jy Top frame: Phas deg  
Vector averaged cross-power spectrum Baseline: EF (03) - ZC (13)  
Timerange: 00/08:33:31 to 00/08:34:29

Plot file version 52 created 19-DEC-2018 17:58:16

VLA1 RY007C.UVDATA.1

Freq = 4.9270 GHz, Bw = 16.000 MH No calibration applied and no bandpass applied

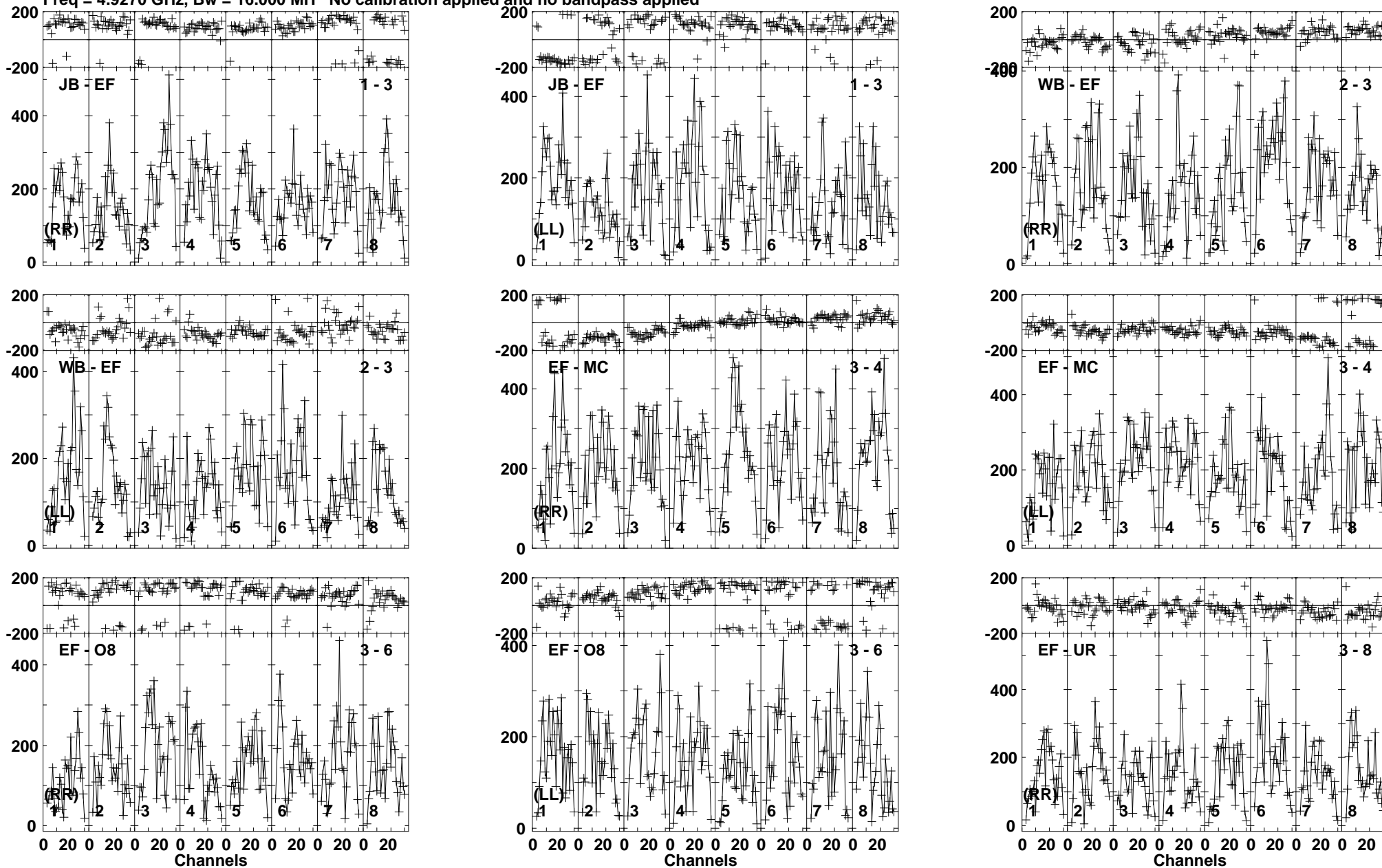

Lower frame: Micro Ampl Jy Top frame: Phas deg  
Vector averaged cross-power spectrum Baseline: JB (01) - EF (03)  
Timerange: 00/08:35:01 to 00/08:36:59

Plot file version 53 created 19-DEC-2018 17:58:16

VLA1 RY007C.UVDATA.1

Freq = 4.9270 GHz, Bw = 16.000 MH No calibration applied and no bandpass applied

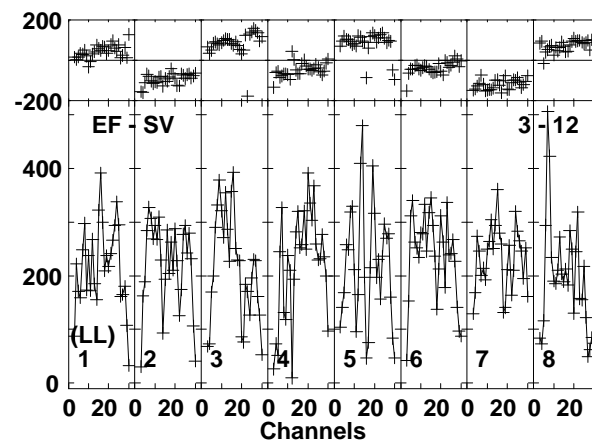
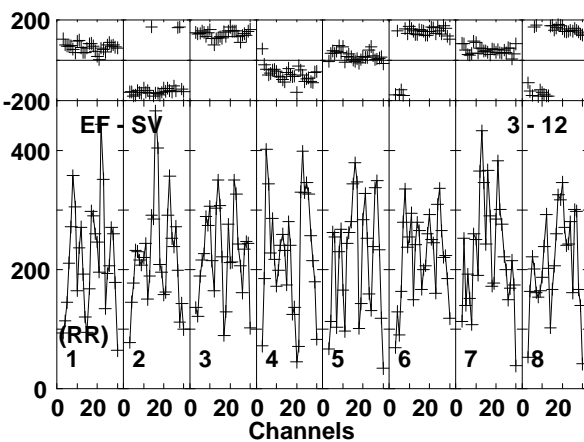
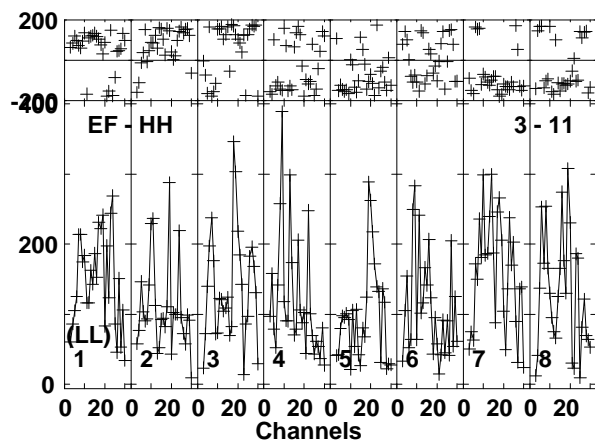
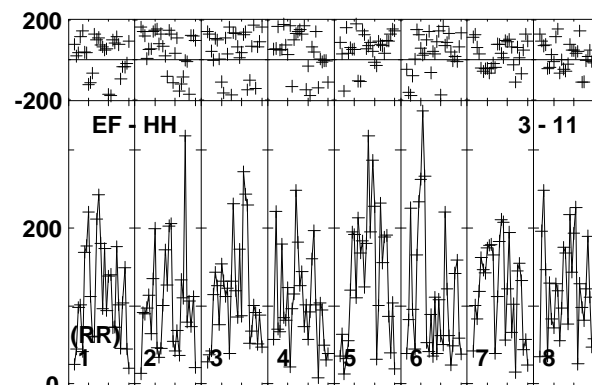
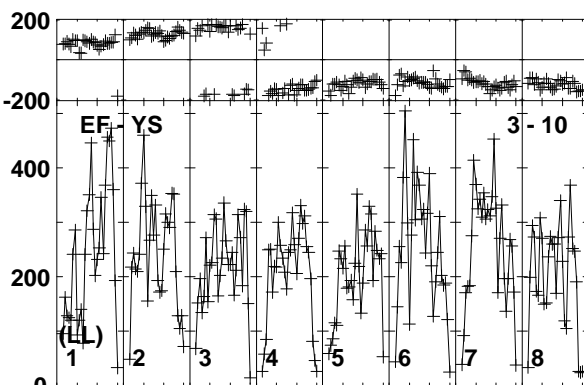
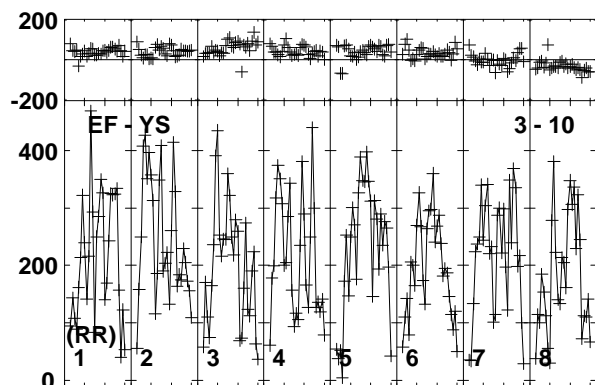
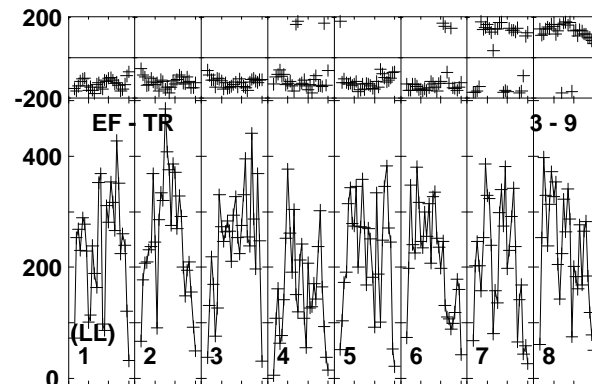
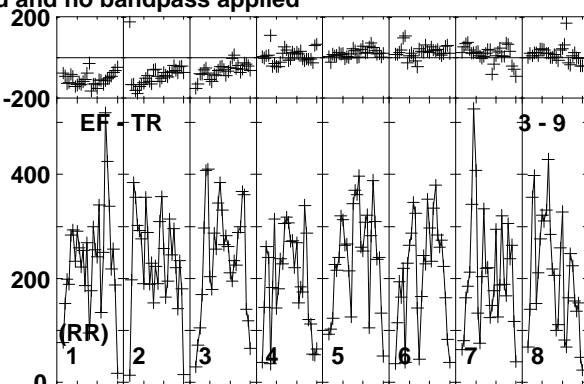
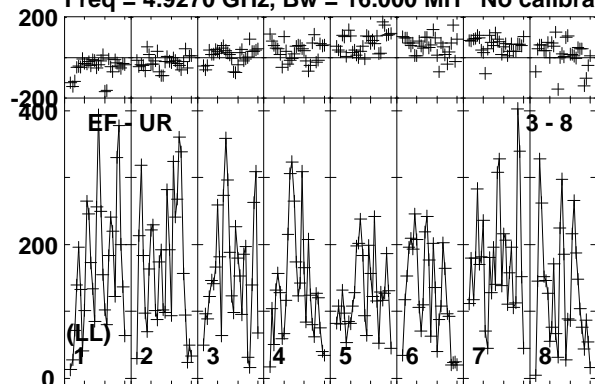

Lower frame: Micro Ampl Jy Top frame: Phas deg  
Vector averaged cross-power spectrum Baseline: EF (03) - UR (08)  
Timerange: 00/08:35:01 to 00/08:36:59

Plot file version 54 created 19-DEC-2018 17:58:16

VLA1 RY007C.UVDATA.1

Freq = 4.9270 GHz, Bw = 16.000 MH No calibration applied and no bandpass applied

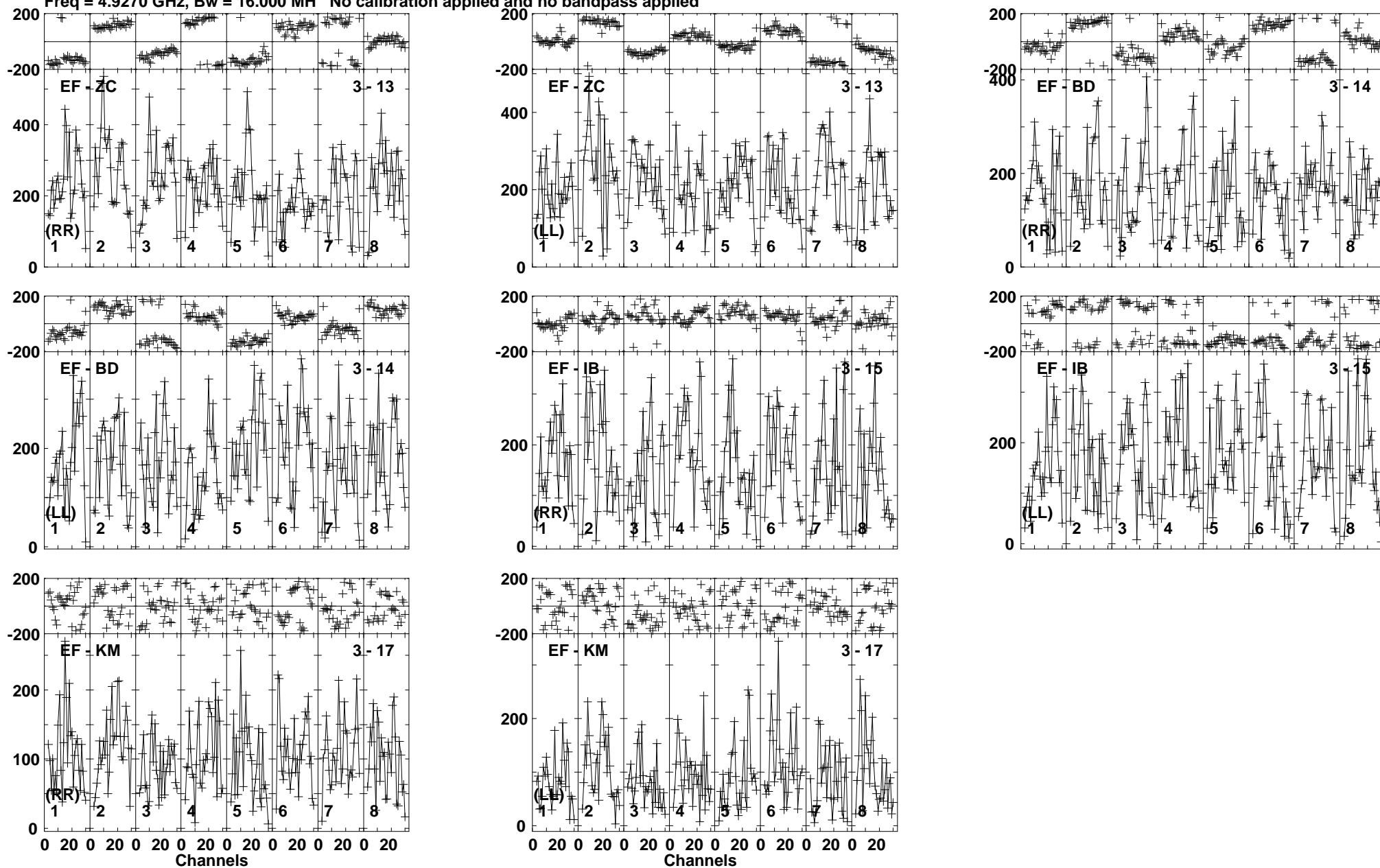

Lower frame: Micro Ampl Jy Top frame: Phas deg  
Vector averaged cross-power spectrum Baseline: EF (03) - ZC (13)  
Timerange: 00/08:35:01 to 00/08:36:59

Plot file version 55 created 19-DEC-2018 17:58:16

J1619+2247 RY007C.UVDATA.1

Freq = 4.9270 GHz, Bw = 16.000 MH No calibration applied and no bandpass applied

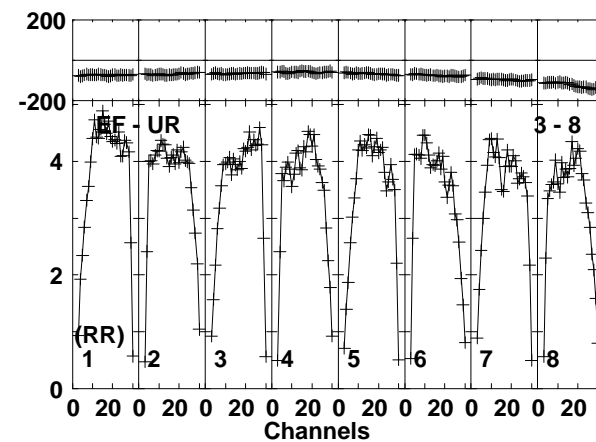
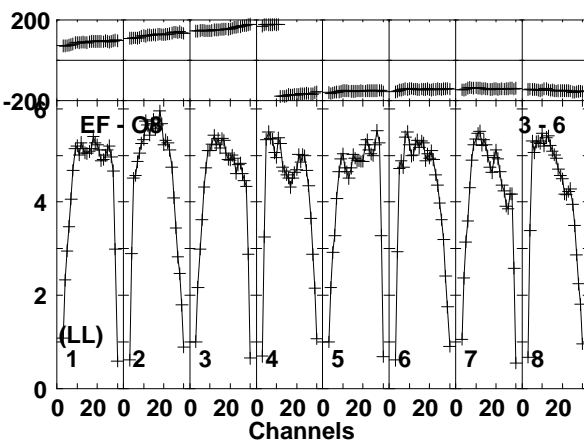
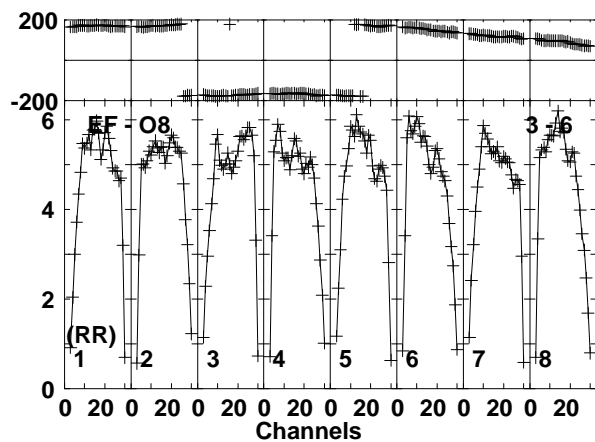
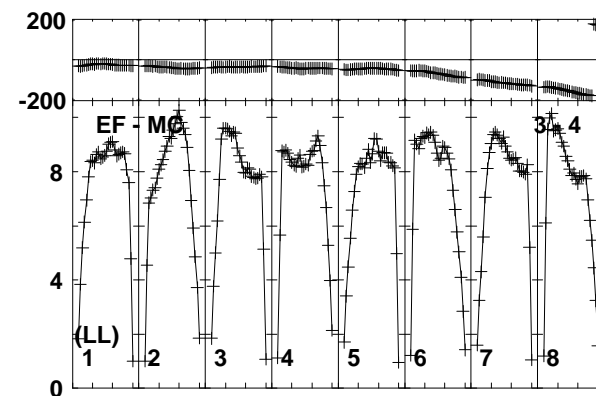
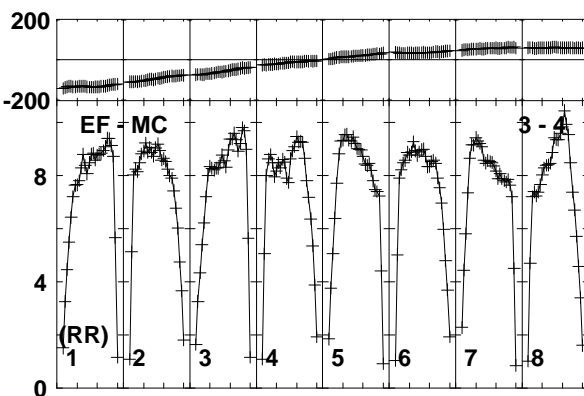
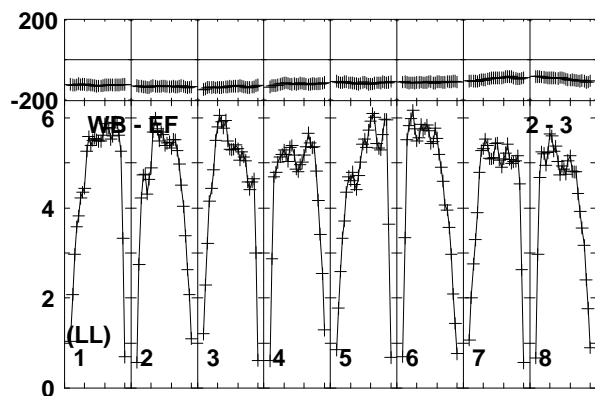
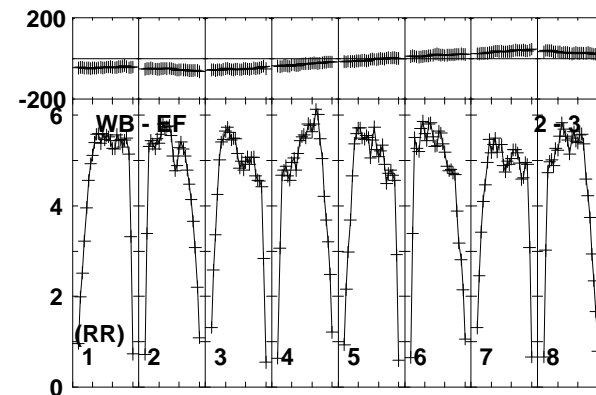
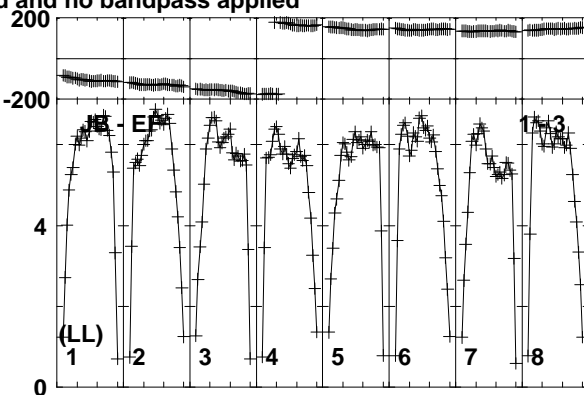
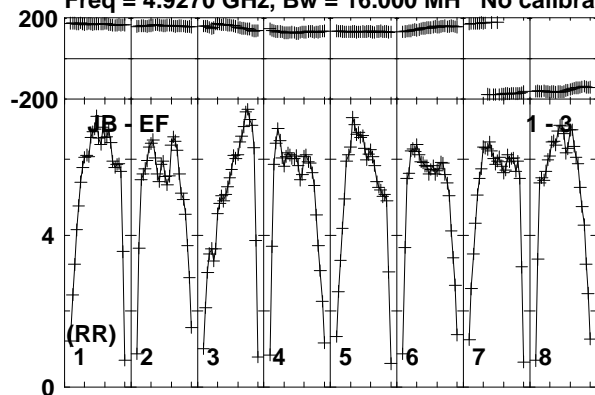

Lower frame: Milli Ampl Jy Top frame: Phas deg  
Vector averaged cross-power spectrum Baseline: JB (01) - EF (03)  
Timerange: 00/08:37:01 to 00/08:37:59

Plot file version 56 created 19-DEC-2018 17:58:16

J1619+2247 RY007C.UVDATA.1

Freq = 4.9270 GHz, Bw = 16.000 MH No calibration applied and no bandpass applied

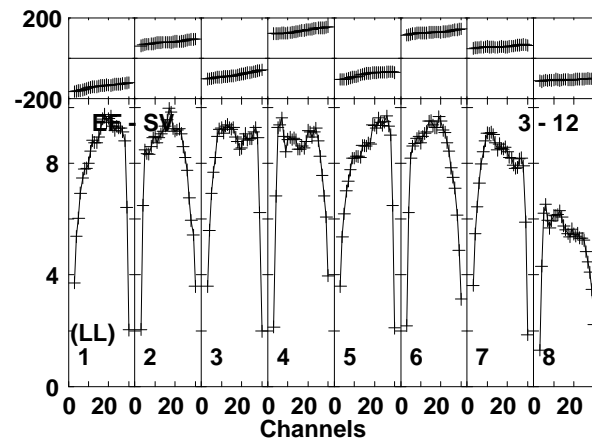
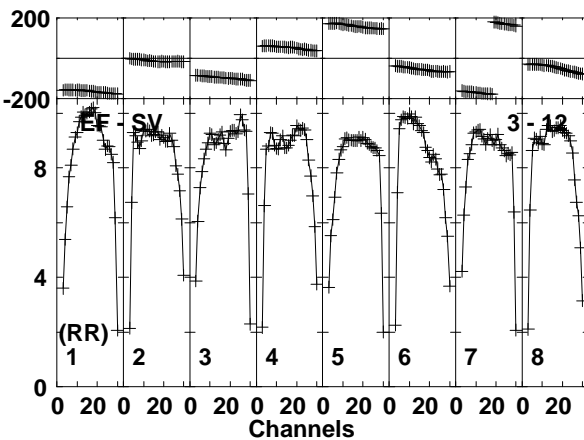
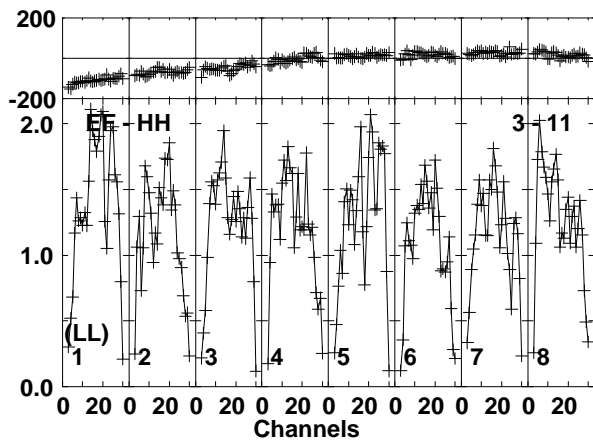
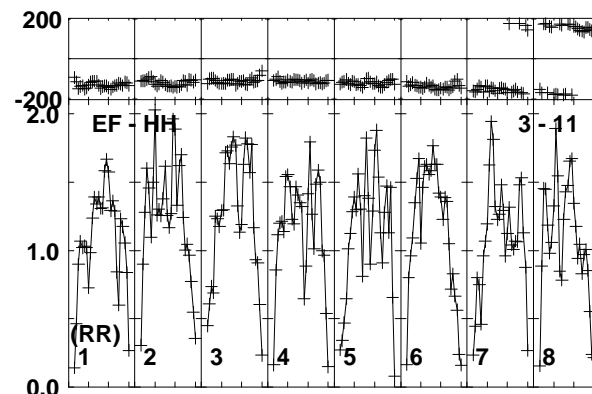
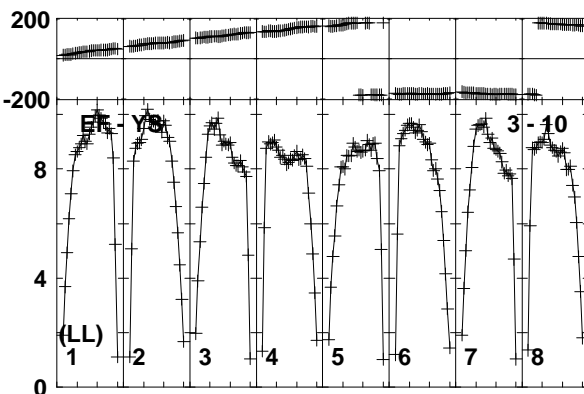
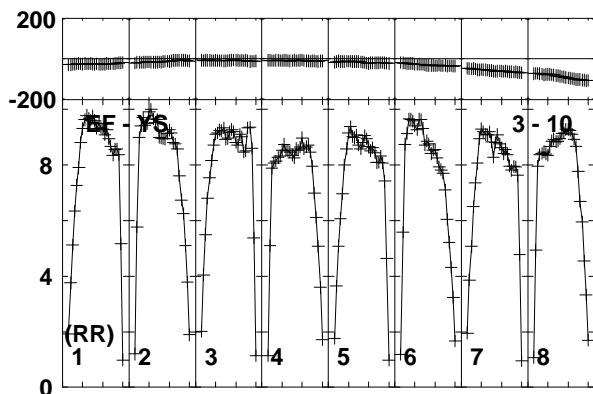
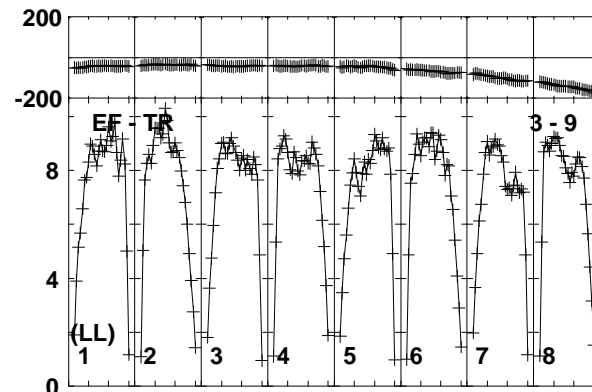
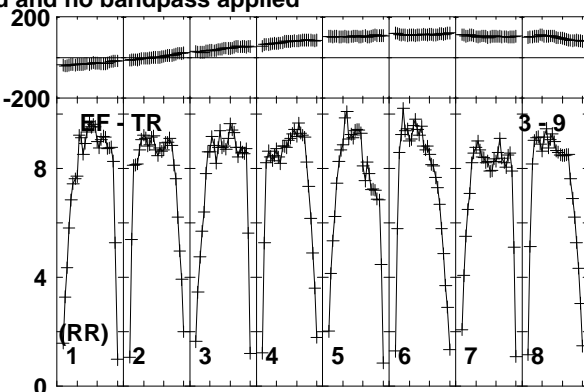
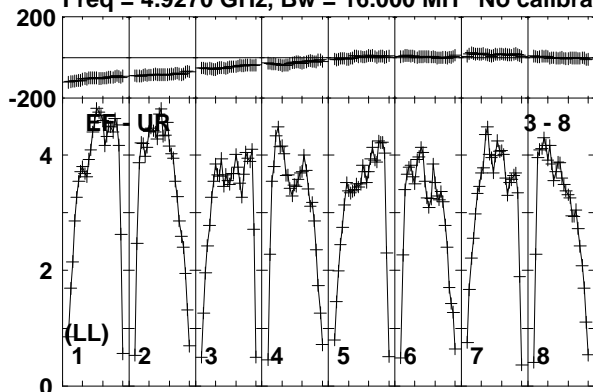

Lower frame: Milli Ampl Jy Top frame: Phas deg  
Vector averaged cross-power spectrum Baseline: EF (03) - UR (08)  
Timerange: 00/08:37:01 to 00/08:37:59

Plot file version 57 created 19-DEC-2018 17:58:16

J1619+2247 RY007C.UVDATA.1

Freq = 4.9270 GHz, Bw = 16.000 MH No calibration applied and no bandpass applied

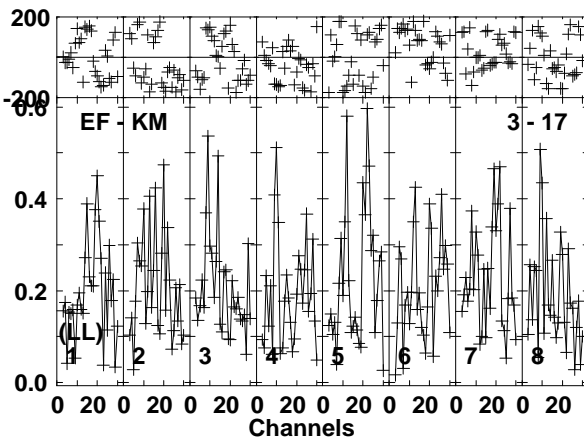
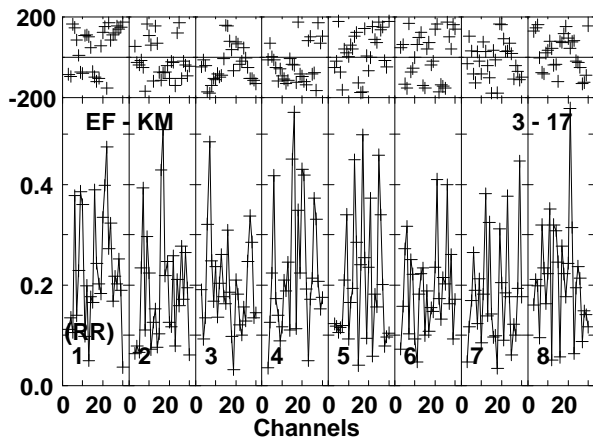
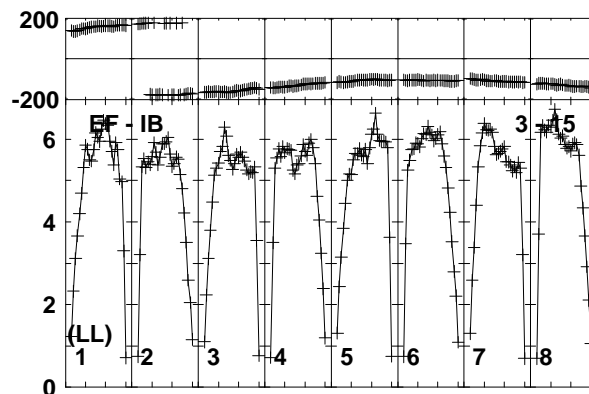
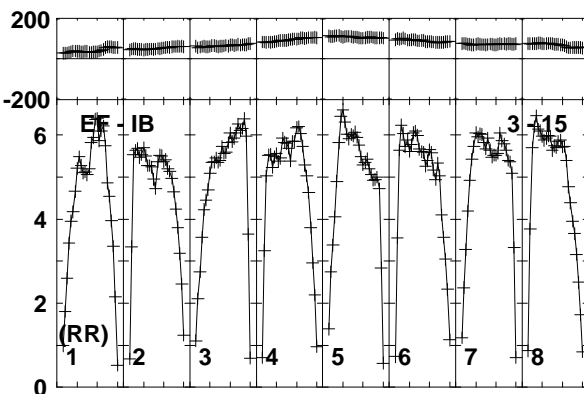
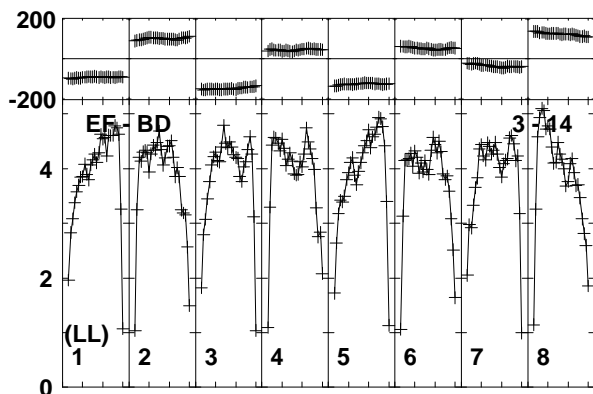
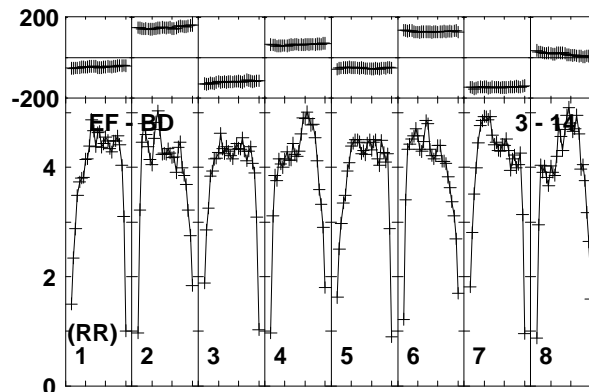
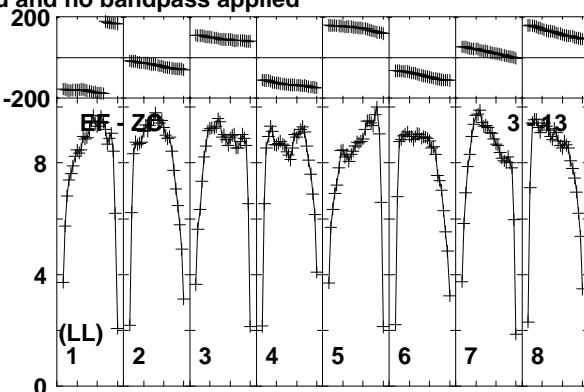
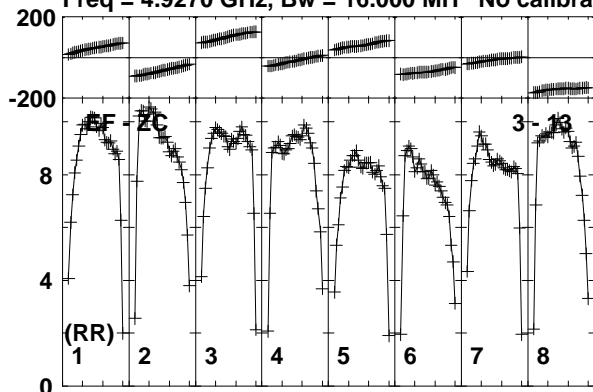

Lower frame: Milli Ampl Jy Top frame: Phas deg  
Vector averaged cross-power spectrum Baseline: EF (03) - ZC (13)  
Timerange: 00/08:37:01 to 00/08:37:59

Plot file version 58 created 19-DEC-2018 17:58:17

AT2018\_RY007C.UVDATA.1

Freq = 4.9270 GHz, Bw = 16.000 MH No calibration applied and no bandpass applied

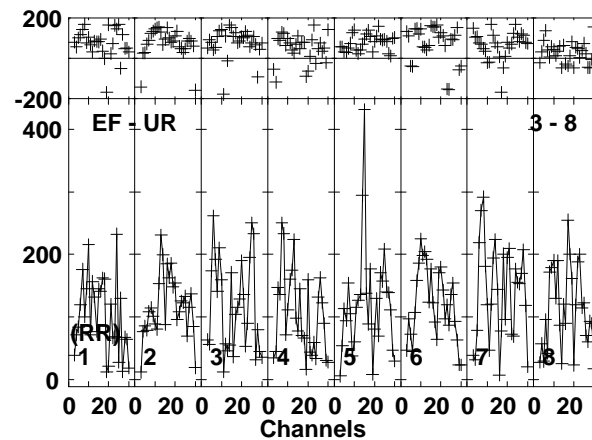
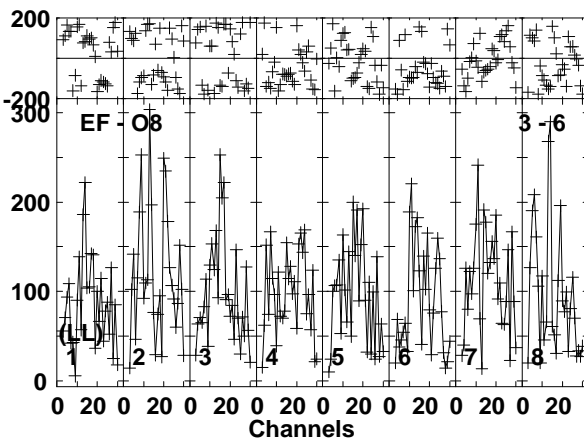
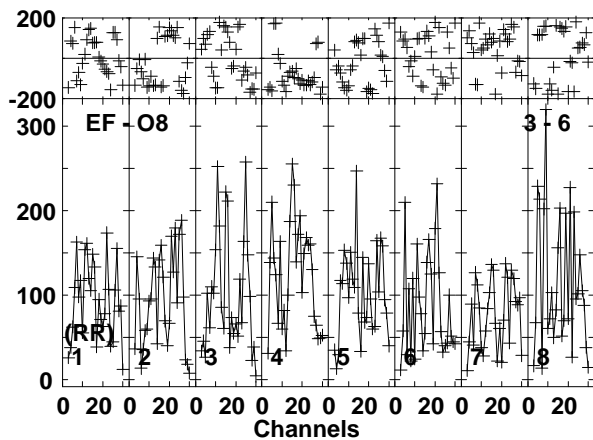
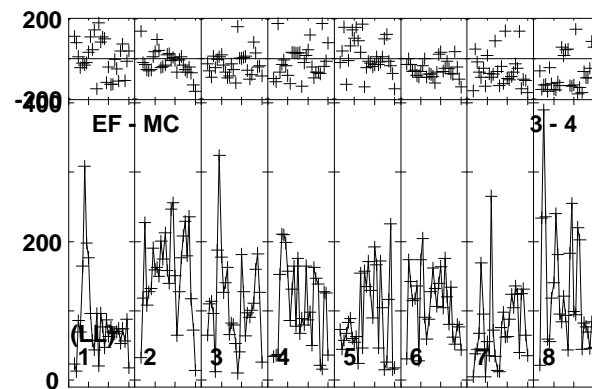
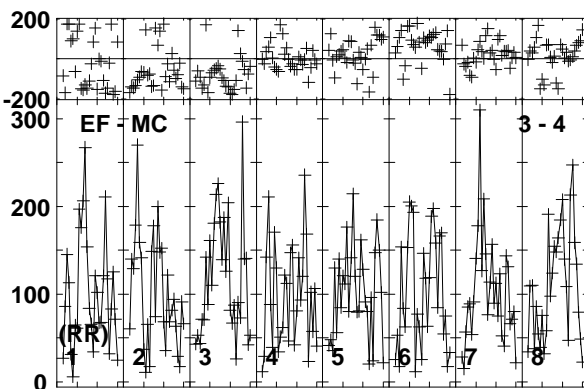
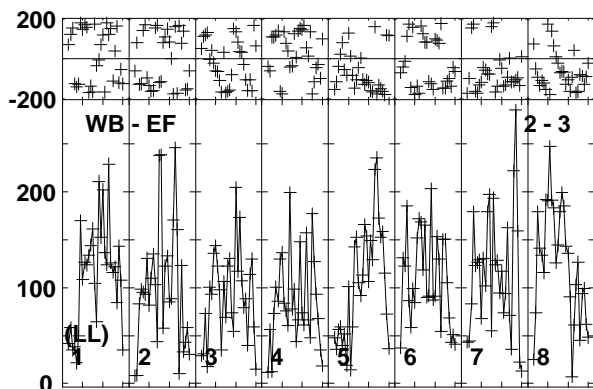
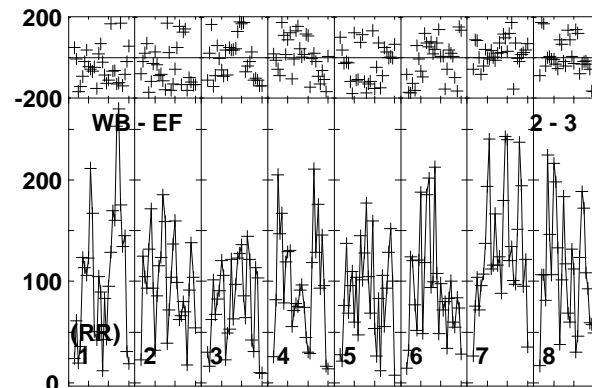
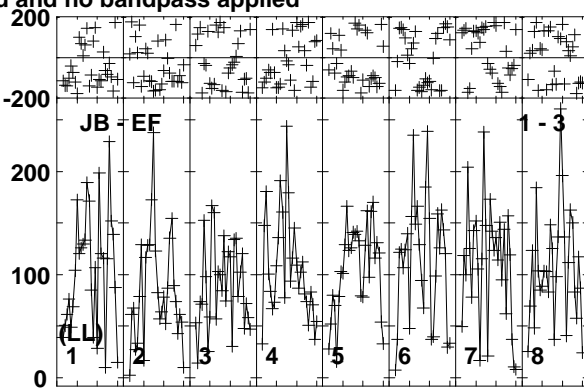
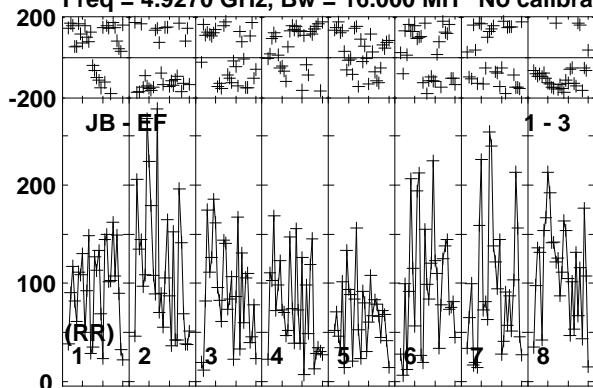

Lower frame: Micro Ampl Jy Top frame: Phas deg  
Vector averaged cross-power spectrum Baseline: JB (01) - EF (03)  
Timerange: 00/08:38:01 to 00/08:40:59



Plot file version 59 created 19-DEC-2018 17:58:17

AT2018\_RY007C.UVDATA.1

Freq = 4.9270 GHz, Bw = 16.000 MH No calibration applied and no bandpass applied

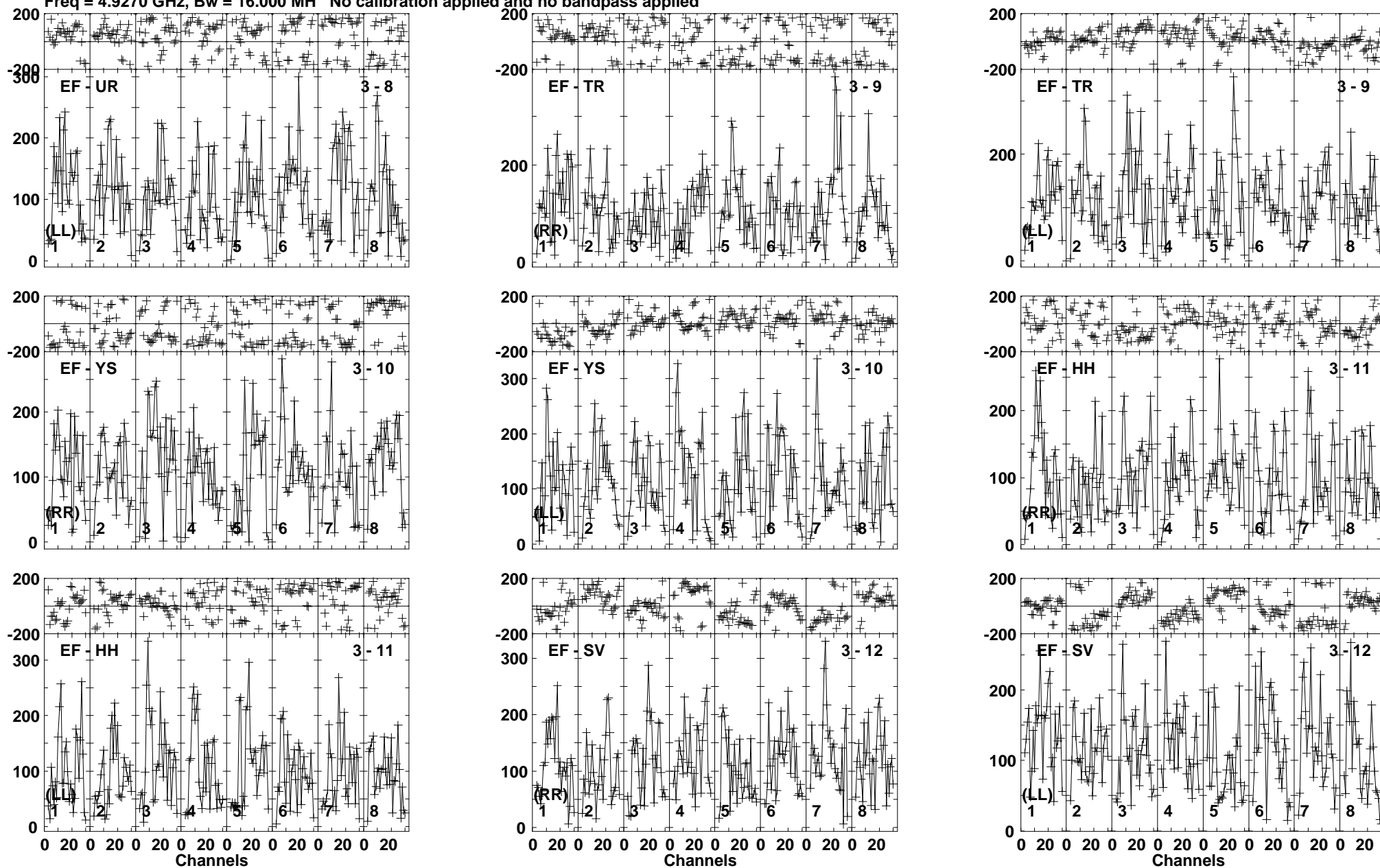

Lower frame: Micro Ampl Jy Top frame: Phas deg  
Vector averaged cross-power spectrum Baseline: EF (03) - UR (08)  
Timerange: 00/08:38:01 to 00/08:40:59

Plot file version 60 created 19-DEC-2018 17:58:17

AT2018\_RY007C.UVDATA.1

Freq = 4.9270 GHz, Bw = 16.000 MH No calibration applied and no bandpass applied

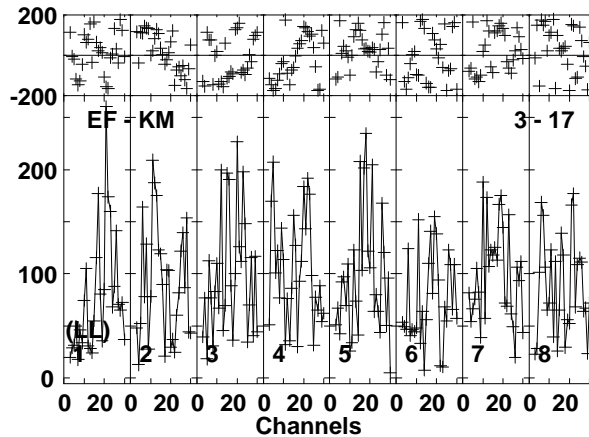
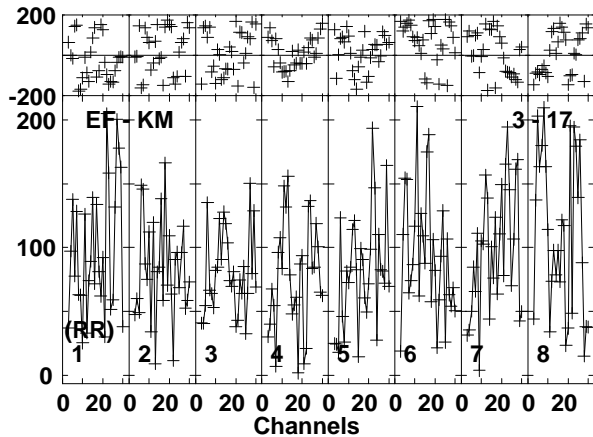
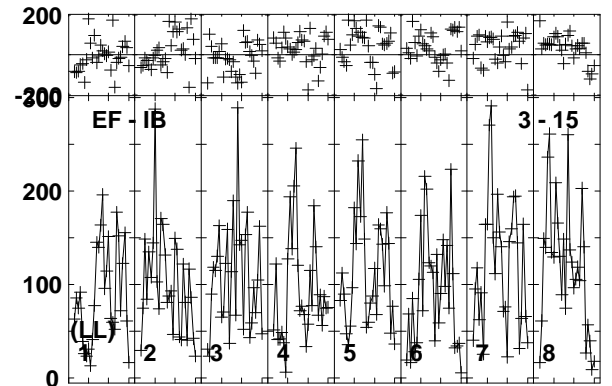
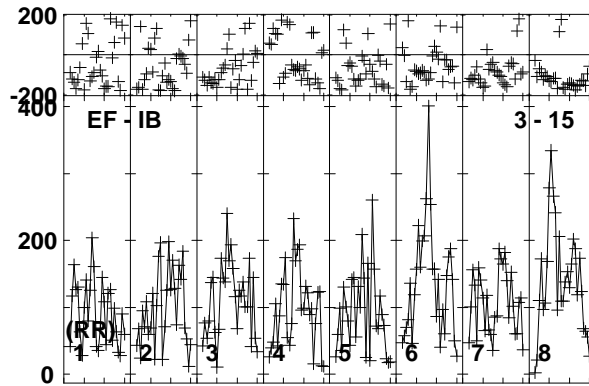
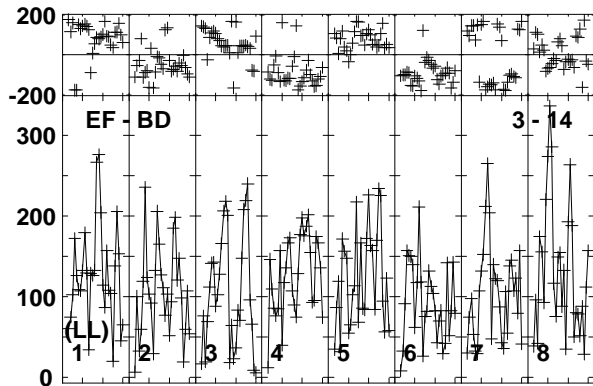
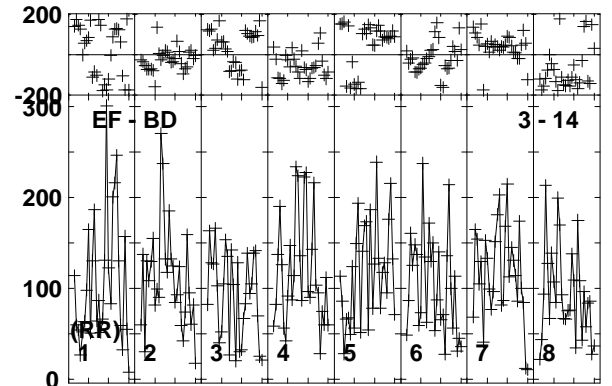
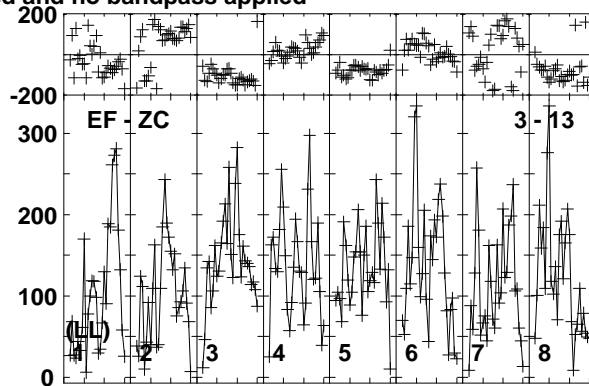
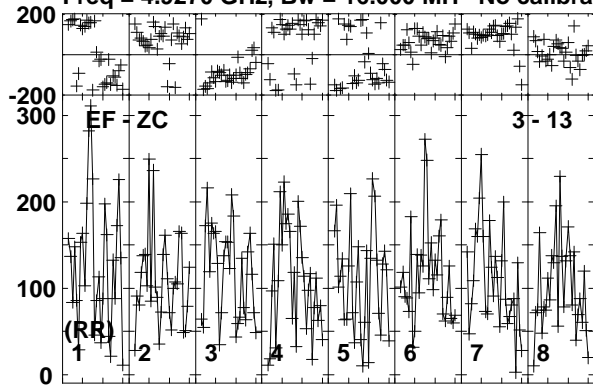

Lower frame: Micro Ampl Jy Top frame: Phas deg  
Vector averaged cross-power spectrum Baseline: EF (03) - ZC (13)  
Timerange: 00/08:38:01 to 00/08:40:59

Plot file version 61 created 19-DEC-2018 17:58:17

J1619+2247 RY007C.UVDATA.1

Freq = 4.9270 GHz, Bw = 16.000 MH No calibration applied and no bandpass applied

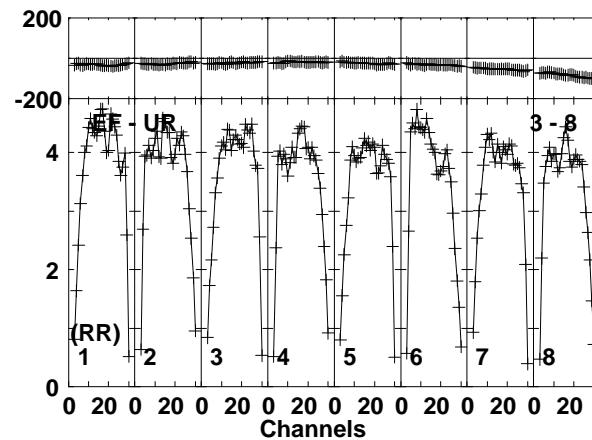
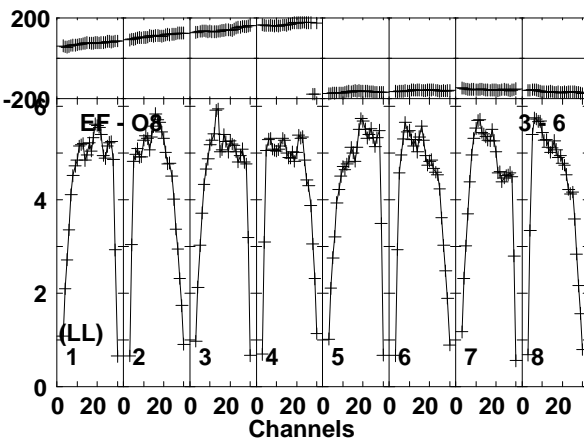
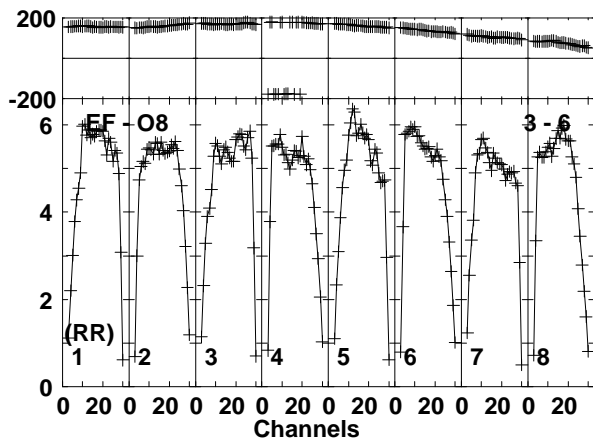
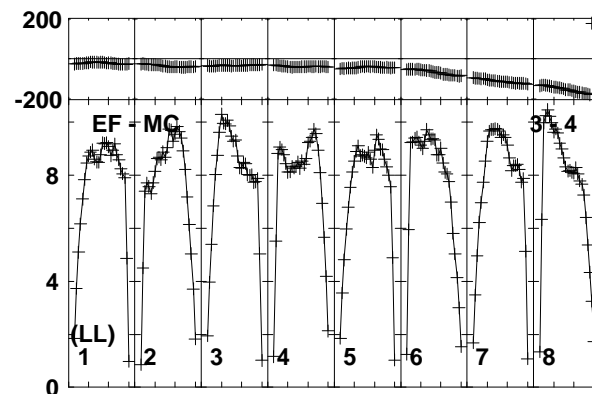
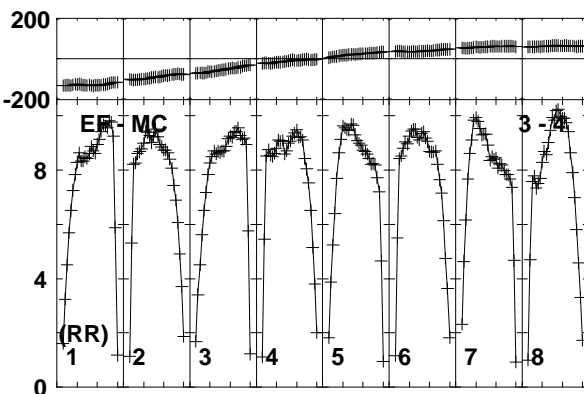
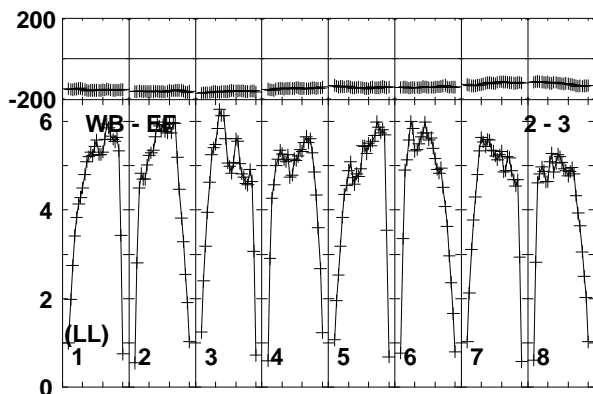
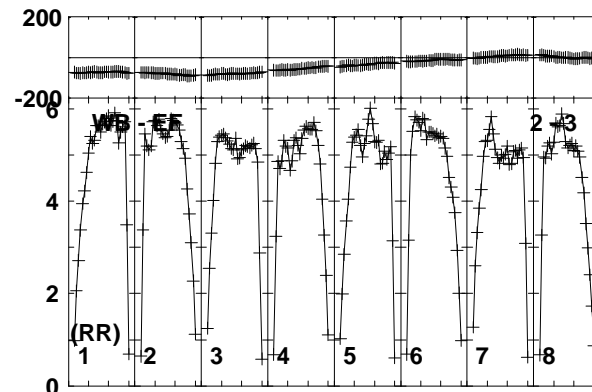
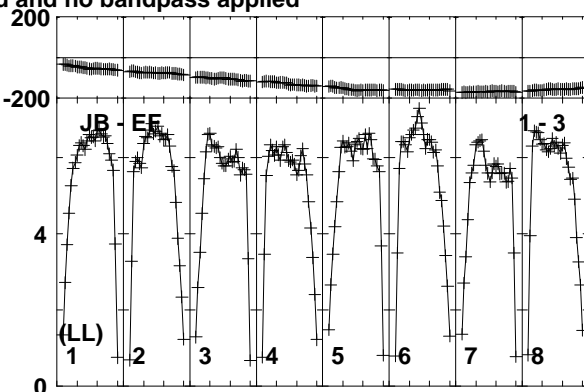
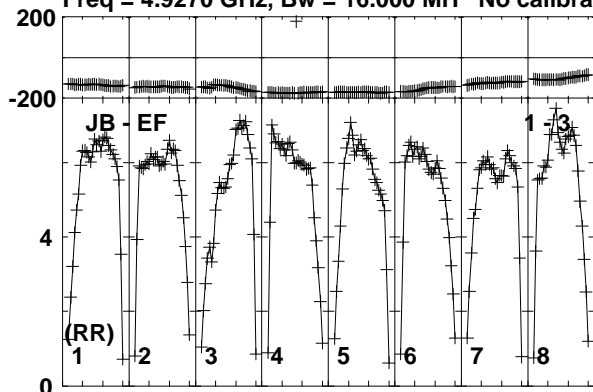

Lower frame: Milli Ampl Jy Top frame: Phas deg  
Vector averaged cross-power spectrum Baseline: JB (01) - EF (03)  
Timerange: 00:08:41:01 to 00:08:41:59

Plot file version 62 created 19-DEC-2018 17:58:17

J1619+2247 RY007C.UVDATA.1

Freq = 4.9270 GHz, Bw = 16.000 MH No calibration applied and no bandpass applied

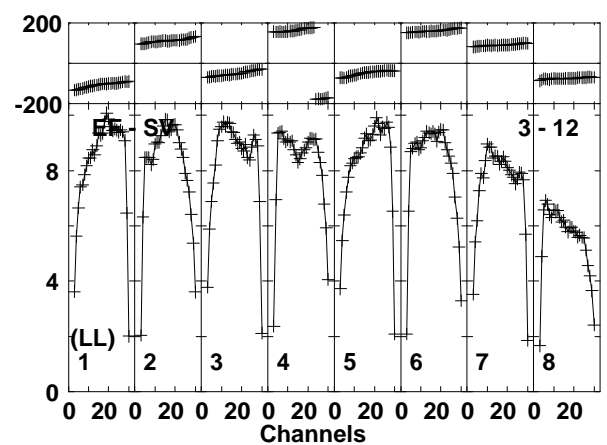
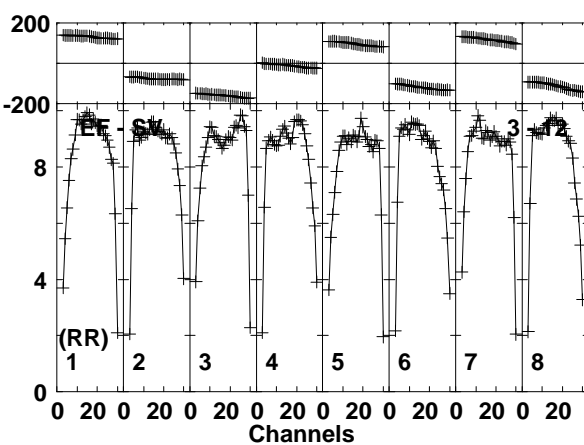
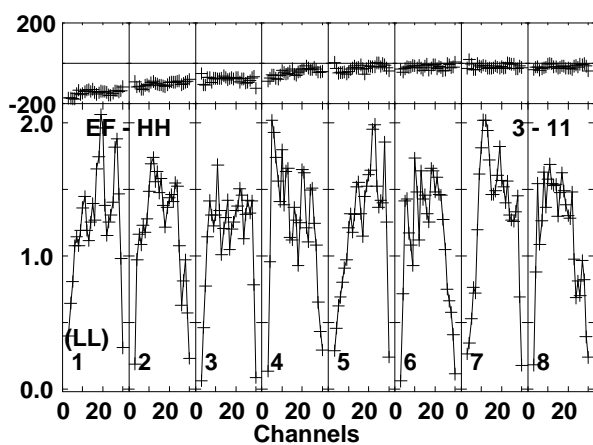
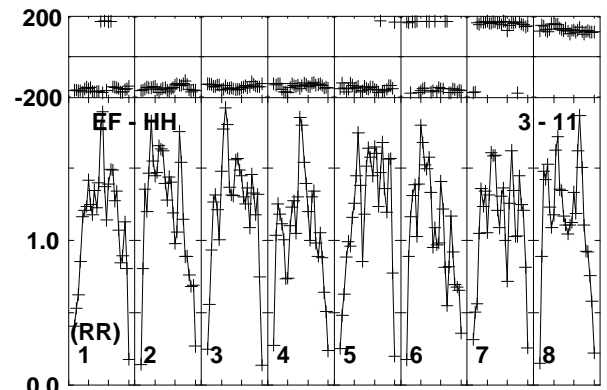
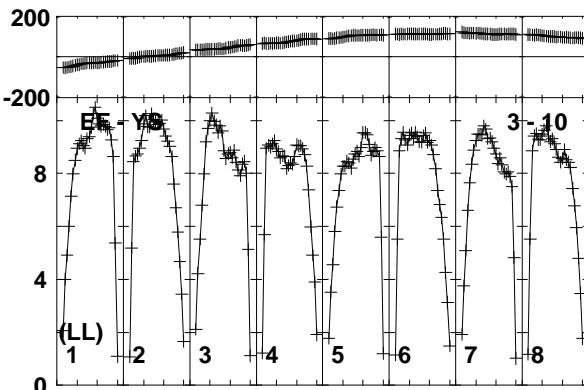
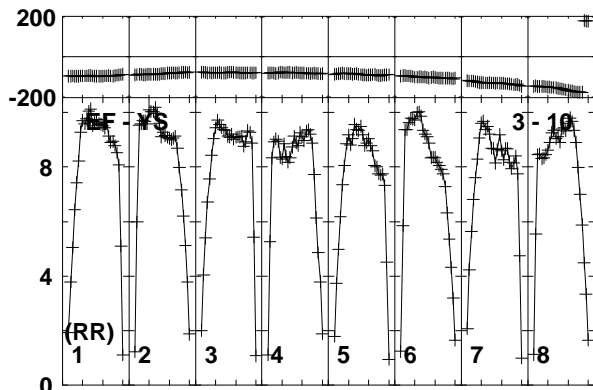
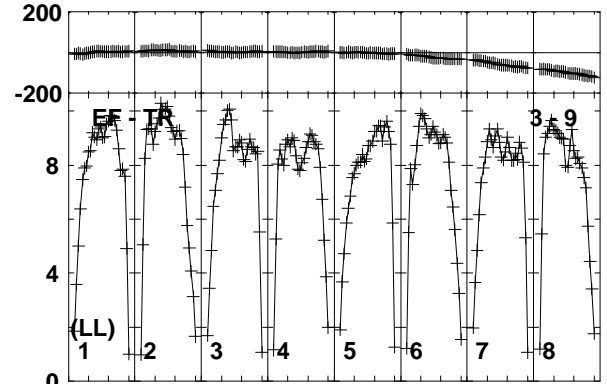
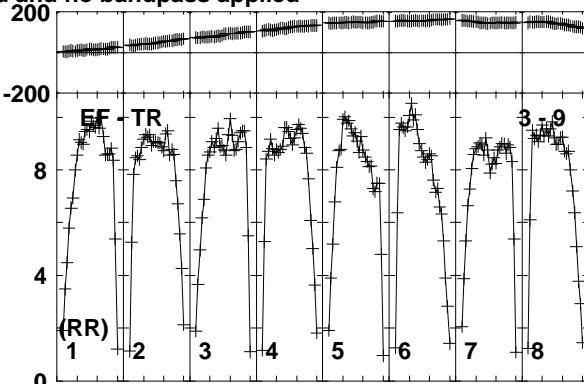
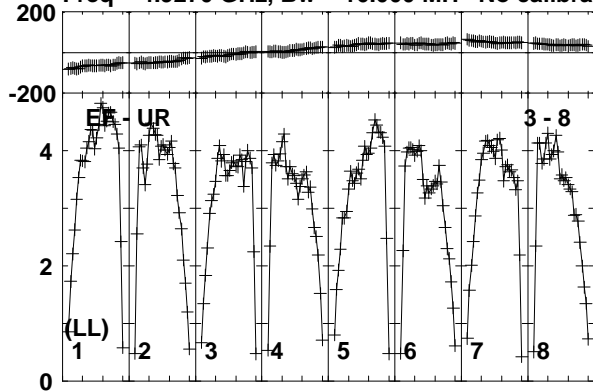

Lower frame: Milli Ampl Jy Top frame: Phas deg  
Vector averaged cross-power spectrum Baseline: EF (03) - UR (08)  
Timerange: 00/08:41:01 to 00/08:41:59

Plot file version 63 created 19-DEC-2018 17:58:17

J1619+2247 RY007C.UVDATA.1

Freq = 4.9270 GHz, Bw = 16.000 MH No calibration applied and no bandpass applied

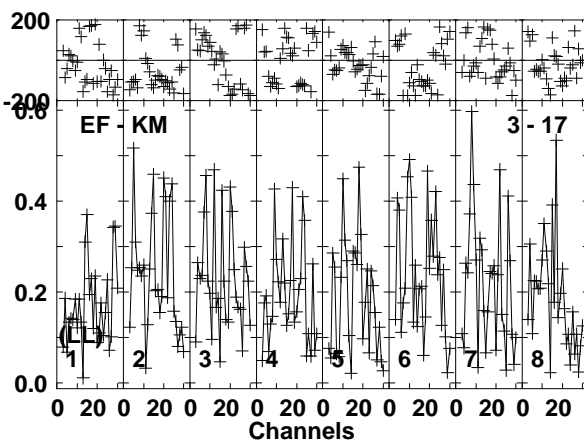
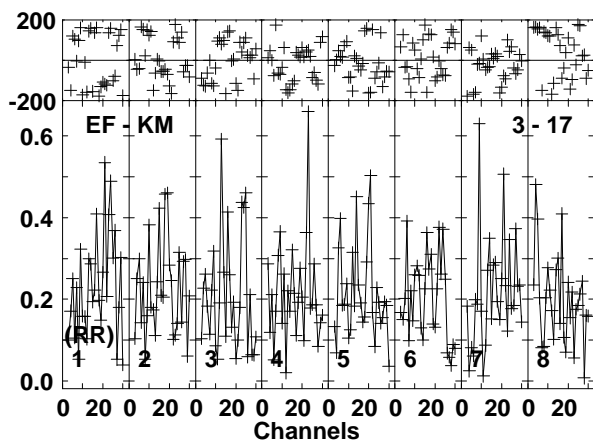
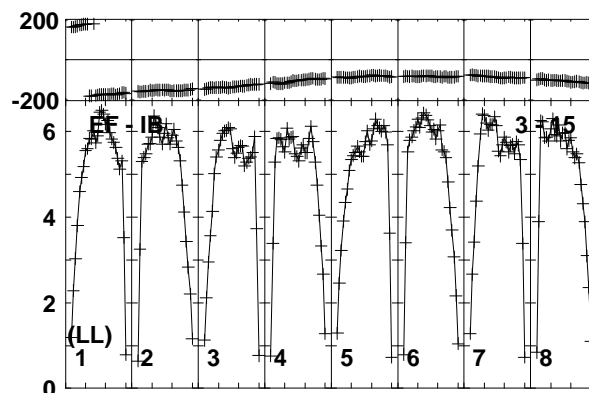
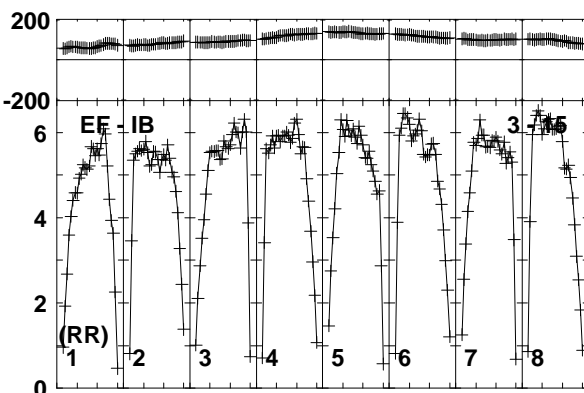
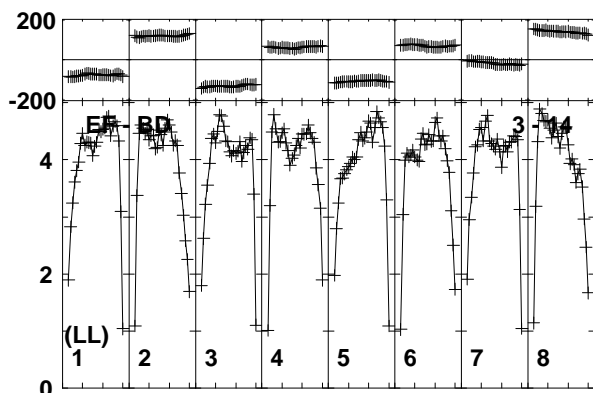
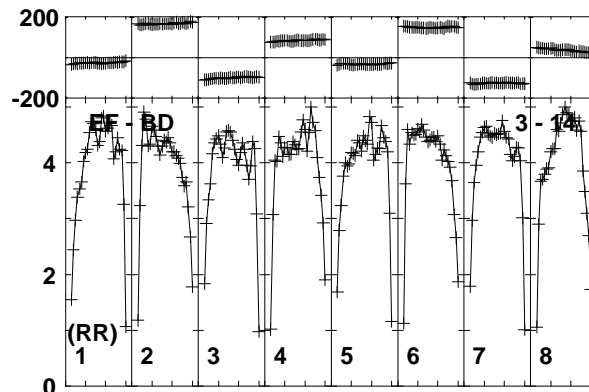
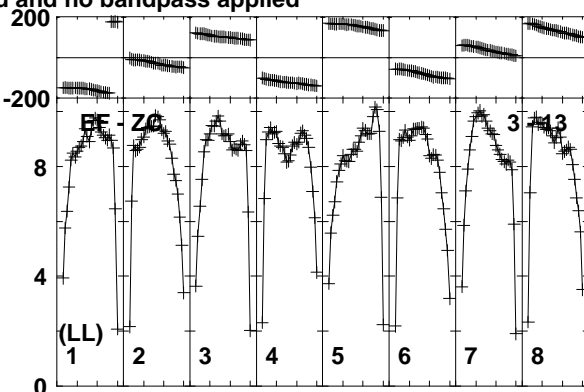
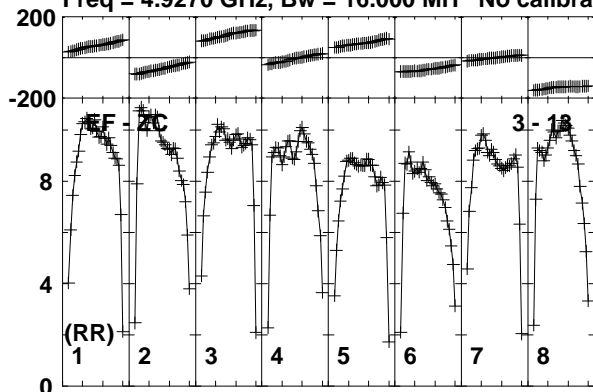

Lower frame: Milli Ampl Jy Top frame: Phas deg  
Vector averaged cross-power spectrum Baseline: EF (03) - ZC (13)  
Timerange: 00/08:41:01 to 00/08:41:59

Plot file version 64 created 19-DEC-2018 17:58:17

AT2018\_RY007C.UVDATA.1

Freq = 4.9270 GHz, Bw = 16.000 MH No calibration applied and no bandpass applied

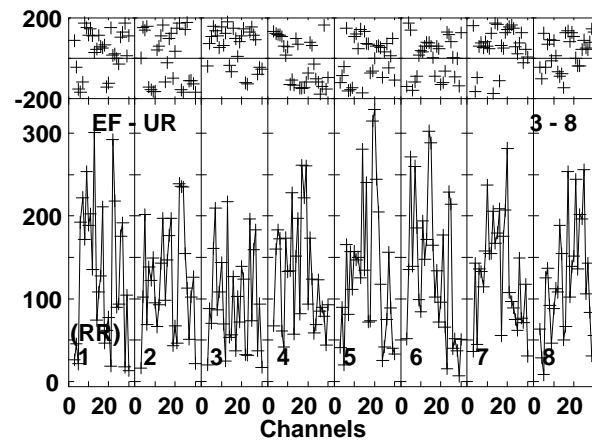
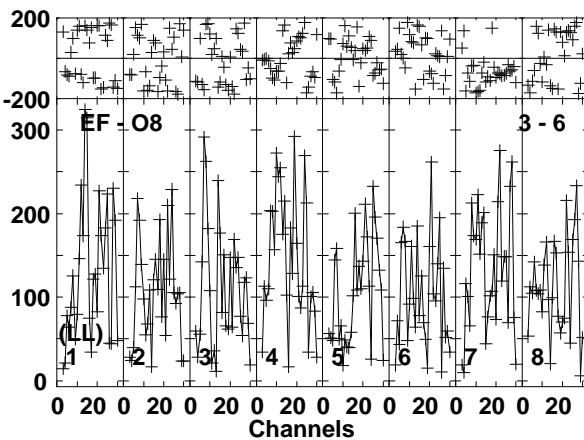
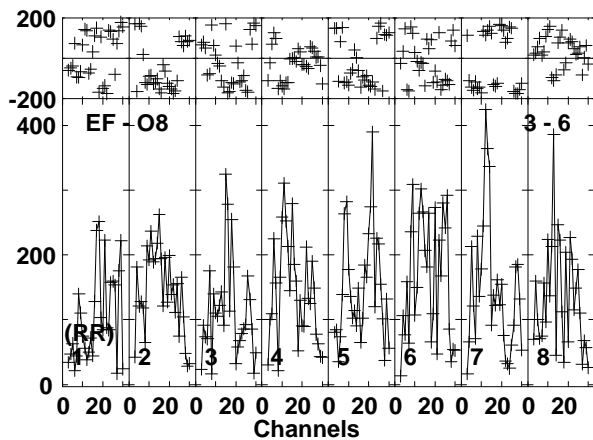
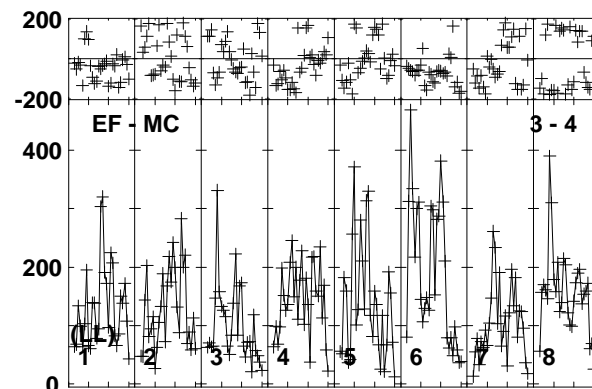
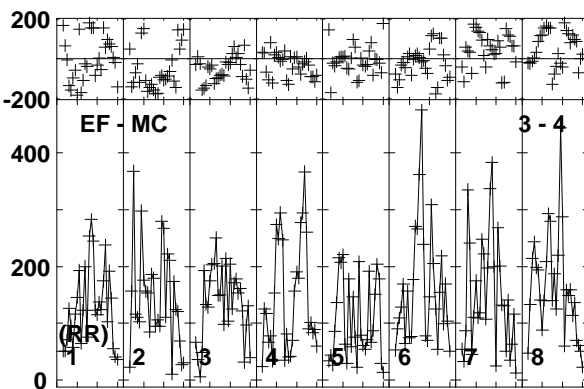
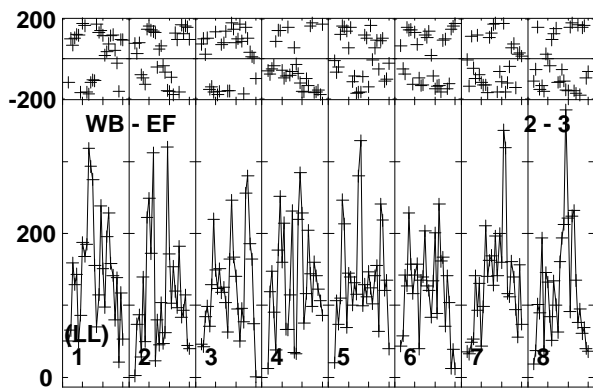
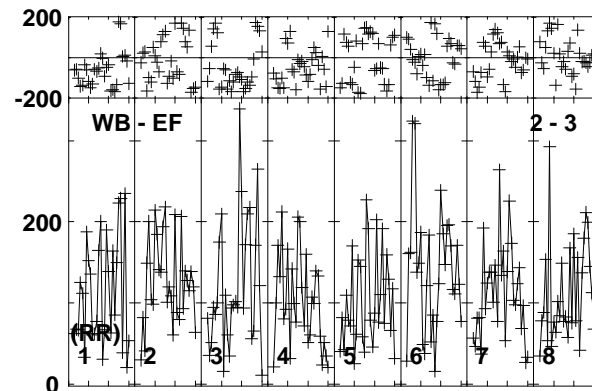
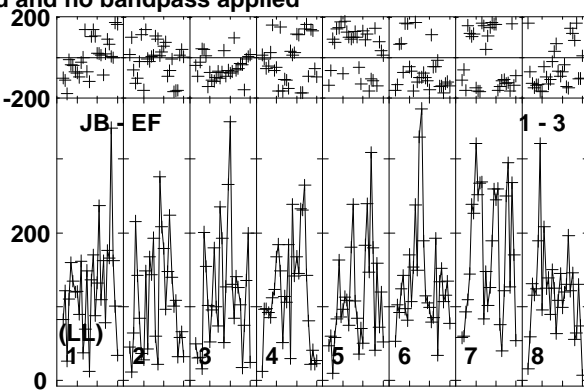
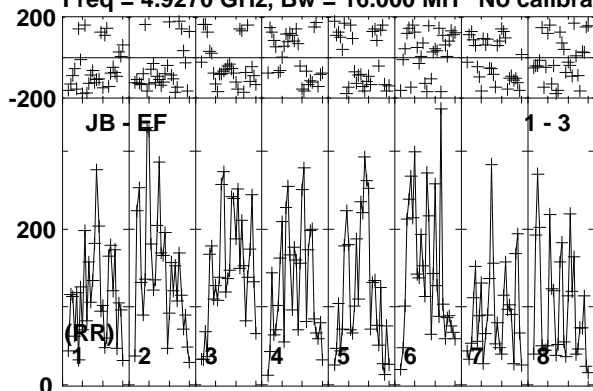

Lower frame: Micro Ampl Jy Top frame: Phas deg  
Vector averaged cross-power spectrum Baseline: JB (01) - EF (03)  
Timerange: 00/08:42:01 to 00/08:43:59

Plot file version 65 created 19-DEC-2018 17:58:17

AT2018\_RY007C.UVDATA.1

Freq = 4.9270 GHz, Bw = 16.000 MH No calibration applied and no bandpass applied

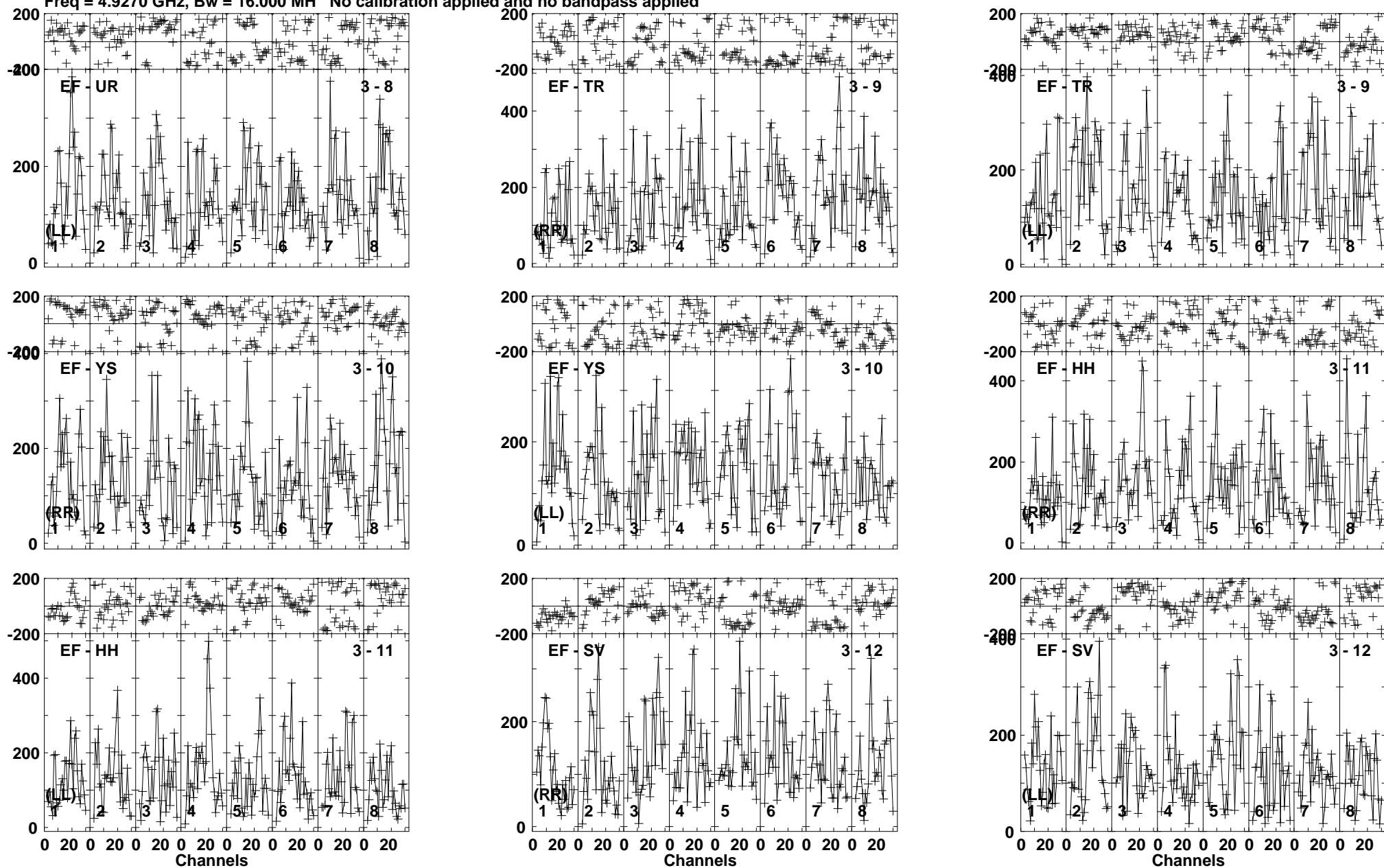

Lower frame: Micro Ampl Jy Top frame: Phas deg  
Vector averaged cross-power spectrum Baseline: EF (03) - UR (08)  
Timerange: 00/08:42:01 to 00/08:43:59

Plot file version 66 created 19-DEC-2018 17:58:17

AT2018\_RY007C.UVDATA.1

Freq = 4.9270 GHz, Bw = 16.000 MH No calibration applied and no bandpass applied

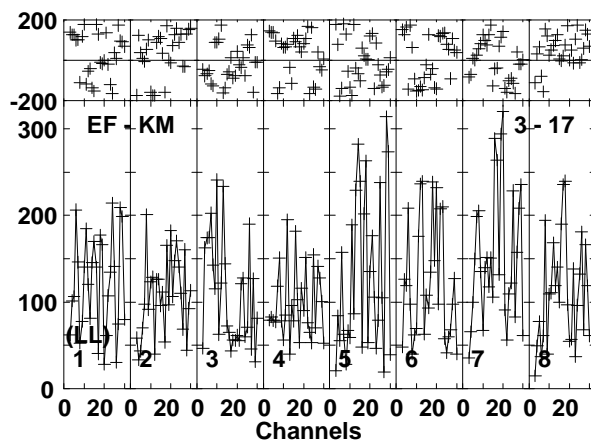
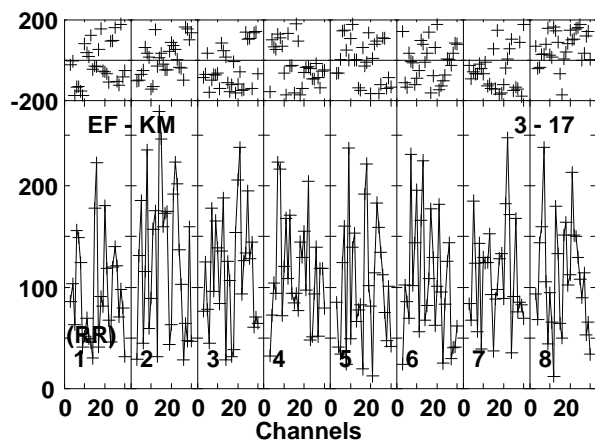
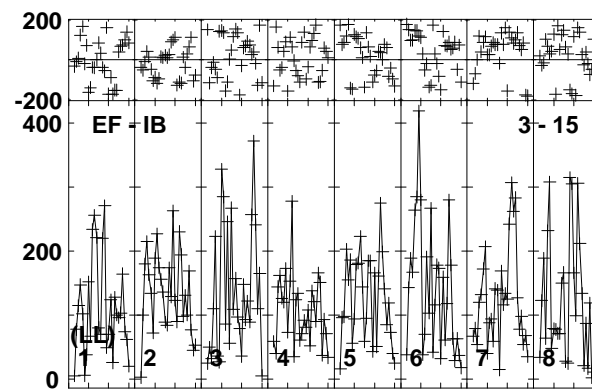
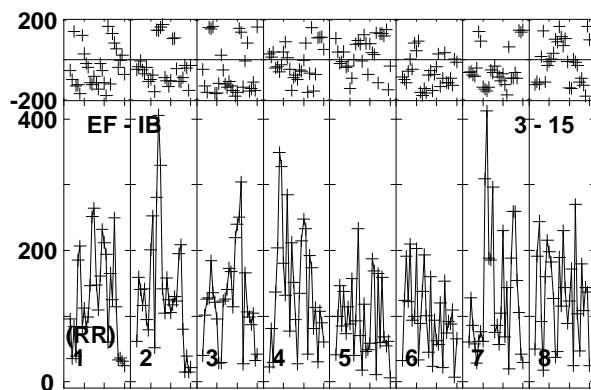
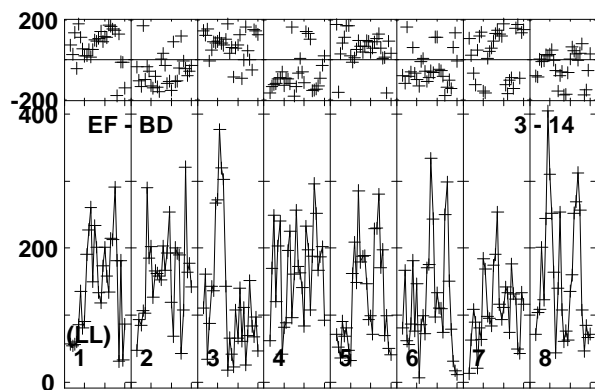
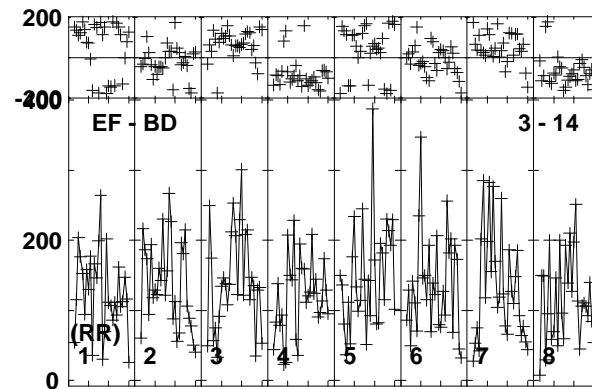
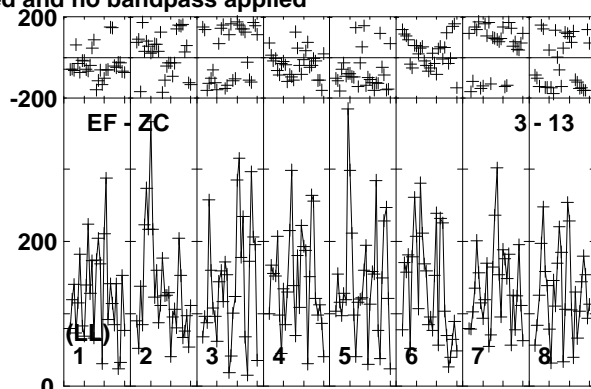
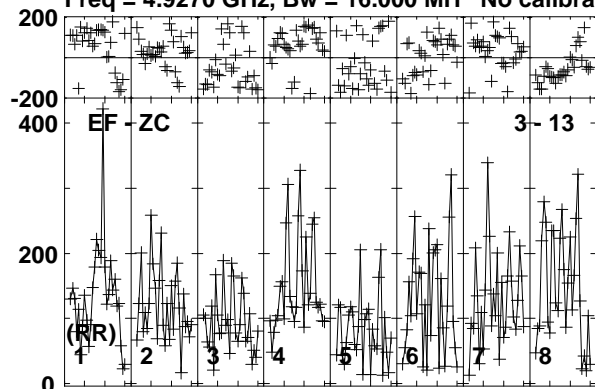

Lower frame: Micro Ampl Jy Top frame: Phas deg  
Vector averaged cross-power spectrum Baseline: EF (03) - ZC (13)  
Timerange: 00/08:42:01 to 00/08:43:59



Plot file version 67 created 19-DEC-2018 17:58:17

VLA2 RY007C.UVDATA.1

Freq = 4.9270 GHz, Bw = 16.000 MH No calibration applied and no bandpass applied

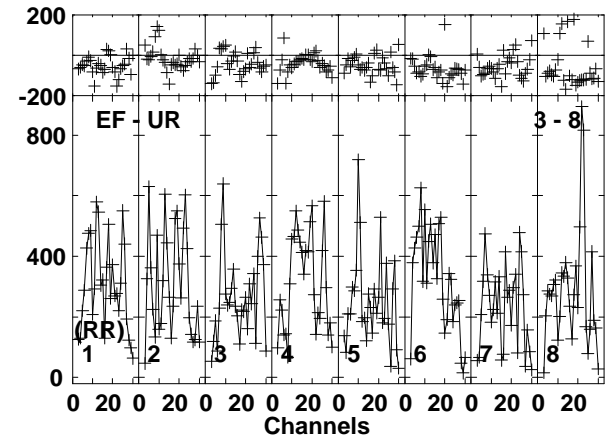
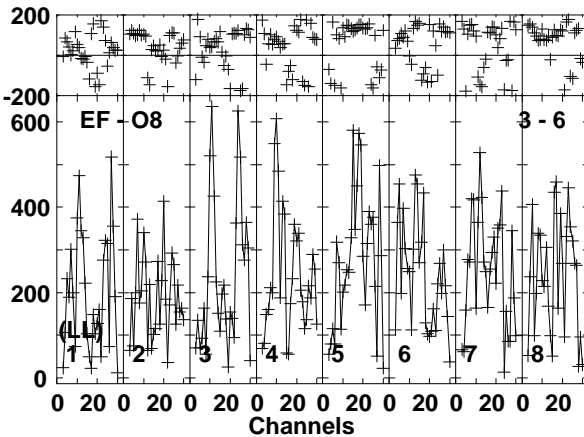
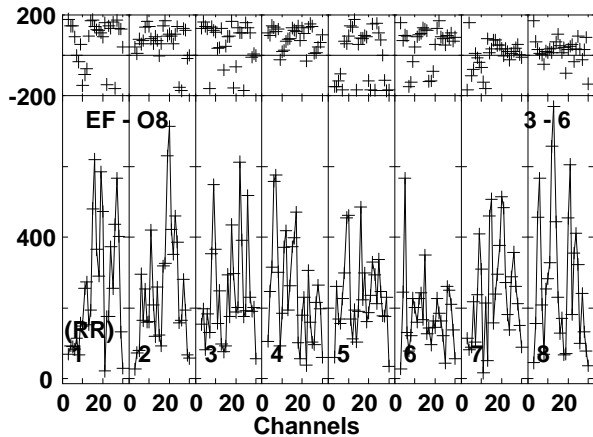
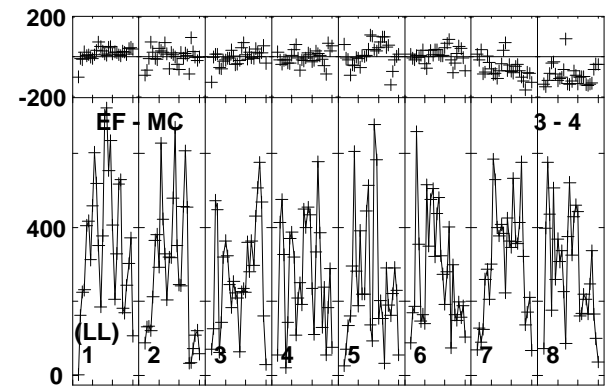
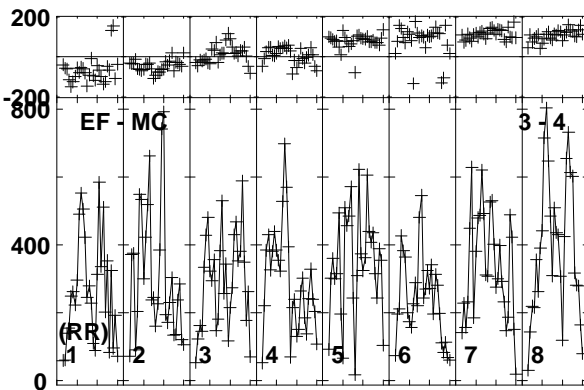
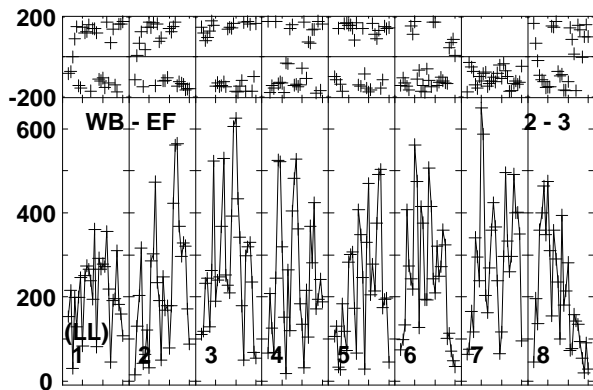
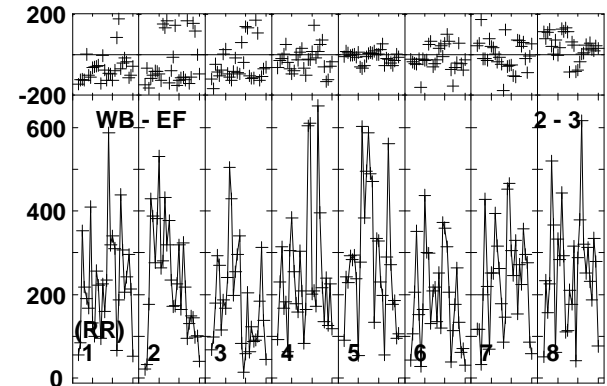
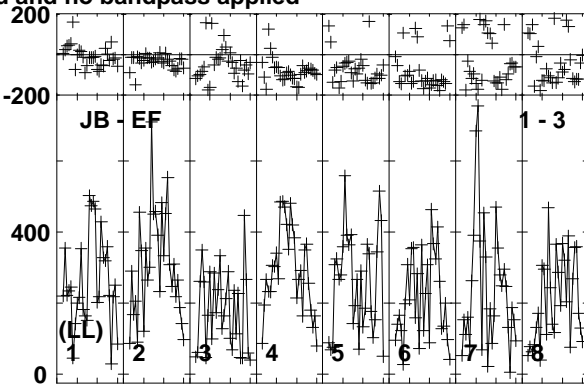
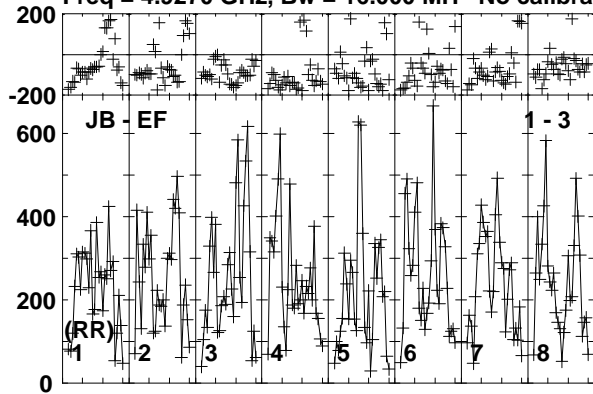

Lower frame: Micro Ampl Jy Top frame: Phas deg  
Vector averaged cross-power spectrum Baseline: JB (01) - EF (03)  
Timerange: 00/08:44:01 to 00/08:44:59

Plot file version 68 created 19-DEC-2018 17:58:17

VLA2\_RY007C.UVDATA.1

Freq = 4.9270 GHz, Bw = 16.000 MH No calibration applied and no bandpass applied

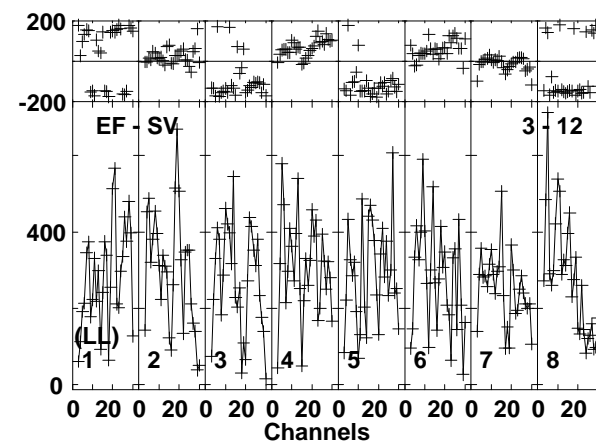
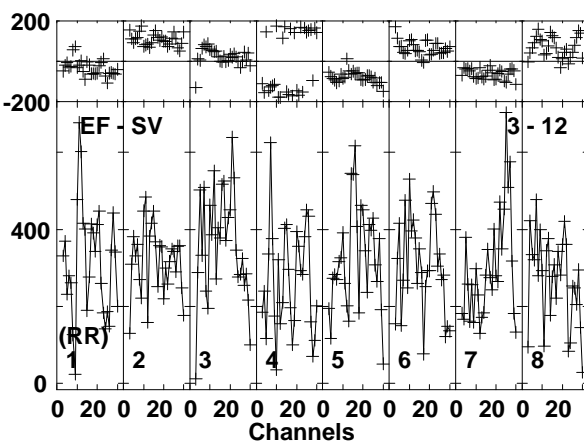
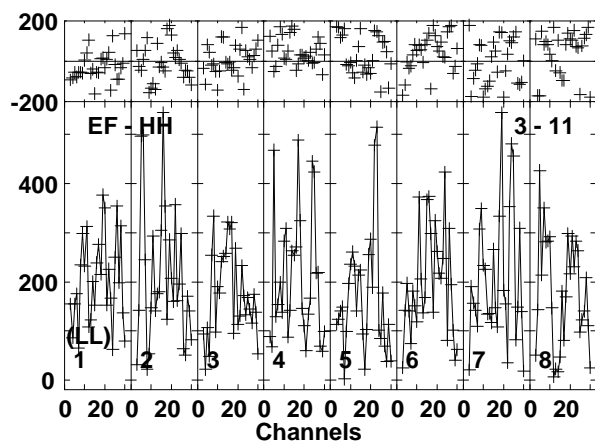
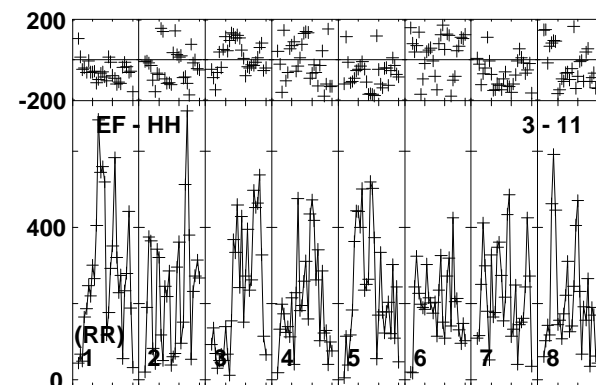
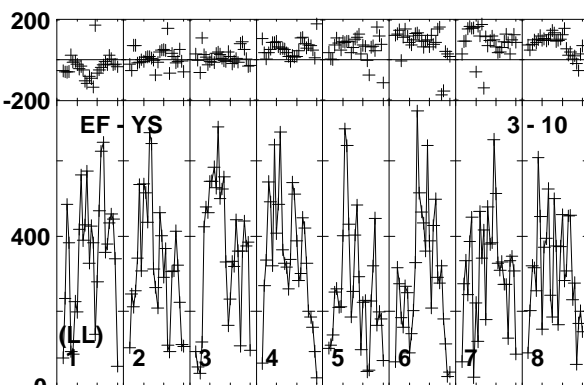
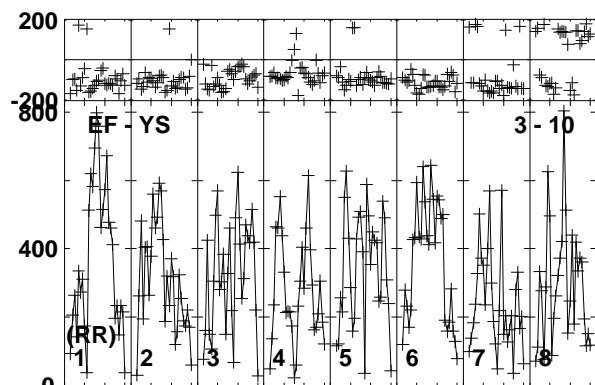
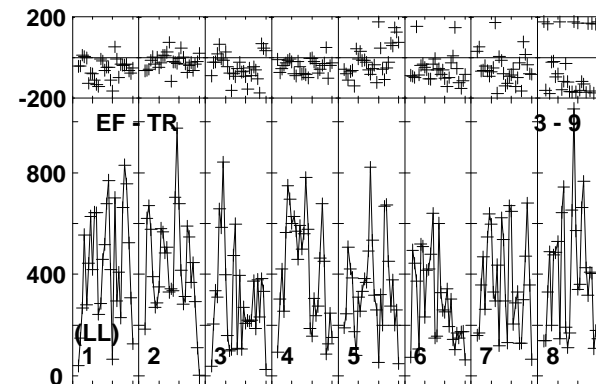
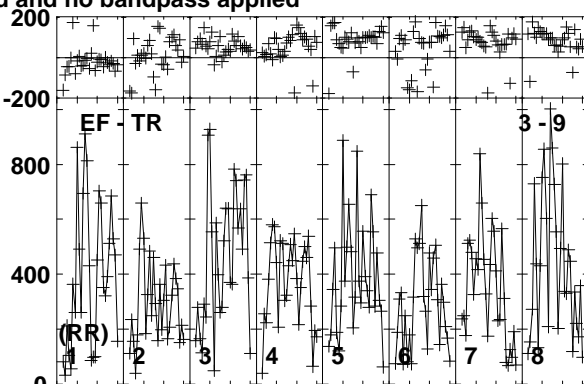
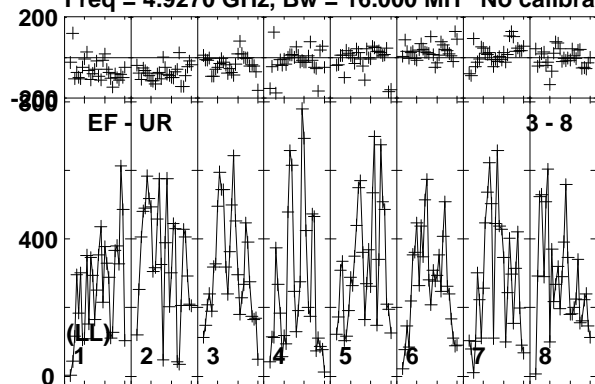

Lower frame: Micro Ampl Jy Top frame: Phas deg  
Vector averaged cross-power spectrum Baseline: EF (03) - UR (08)  
Timerange: 00/08:44:01 to 00/08:44:59

Plot file version 69 created 19-DEC-2018 17:58:17

VLA2\_RY007C.UVDATA.1

Freq = 4.9270 GHz, Bw = 16.000 MH No calibration applied and no bandpass applied

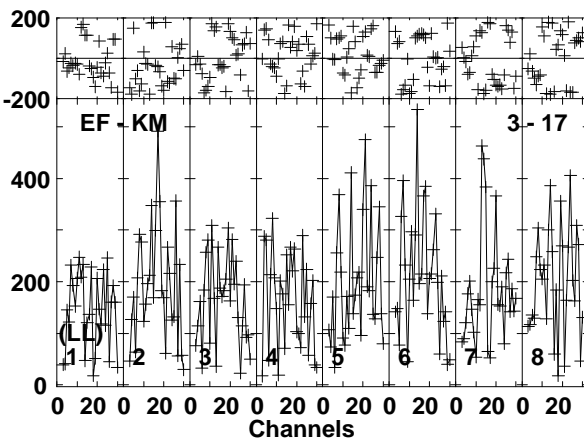
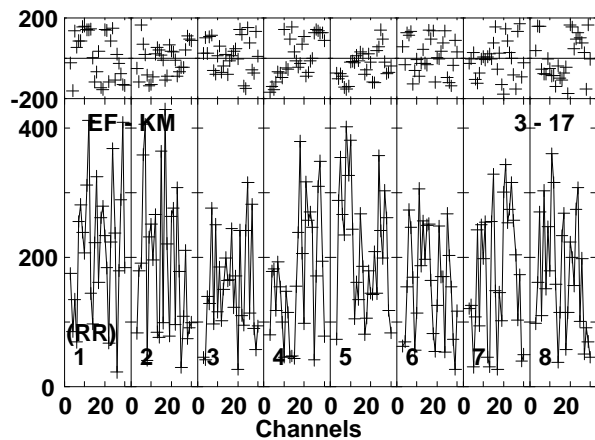
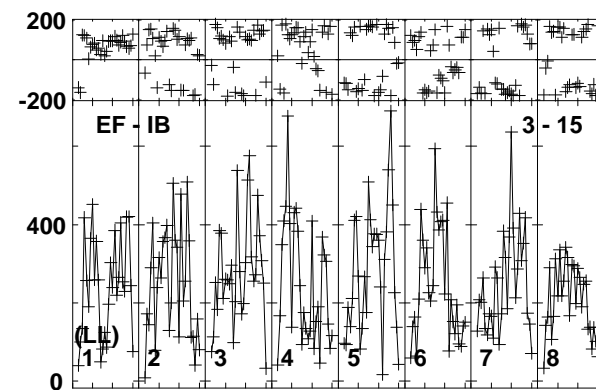
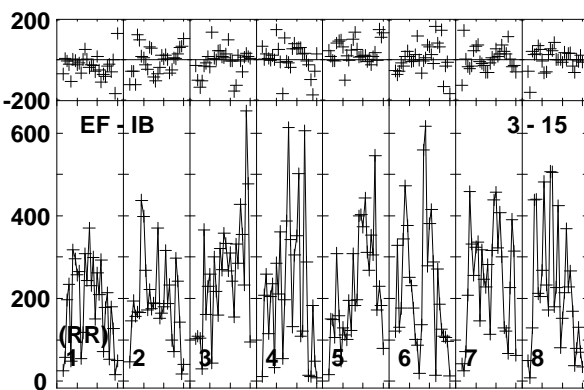
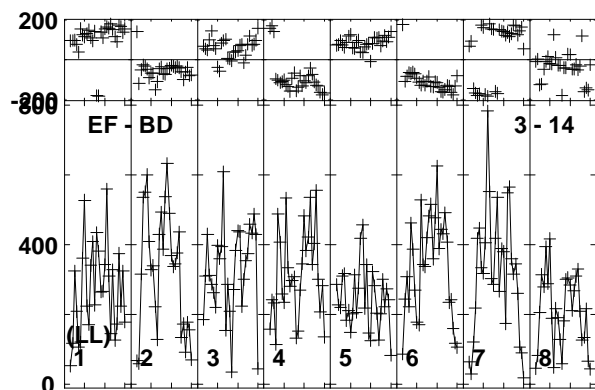
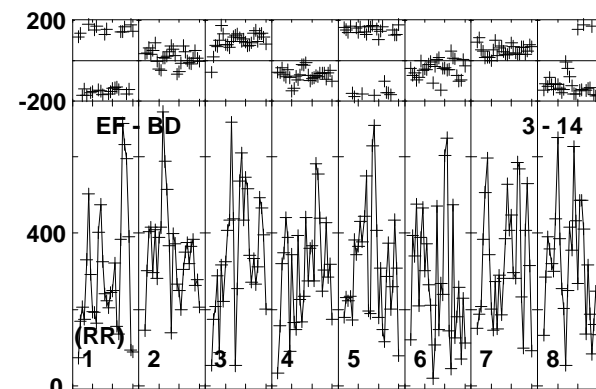
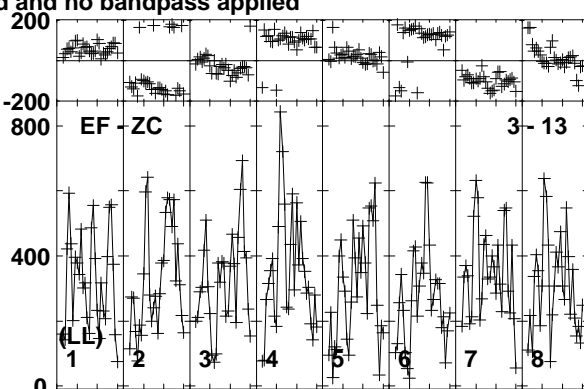
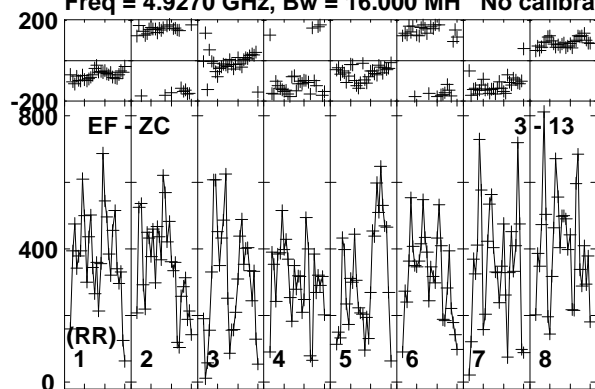

Lower frame: Micro Ampl Jy Top frame: Phas deg  
Vector averaged cross-power spectrum Baseline: EF (03) - ZC (13)  
Timerange: 00/08:44:01 to 00/08:44:59

Plot file version 70 created 19-DEC-2018 17:58:17

J1619+2247 RY007C.UVDATA.1

Freq = 4.9270 GHz, Bw = 16.000 MH No calibration applied and no bandpass applied

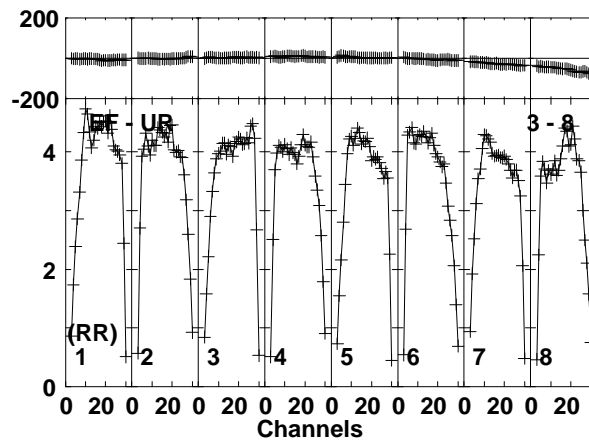
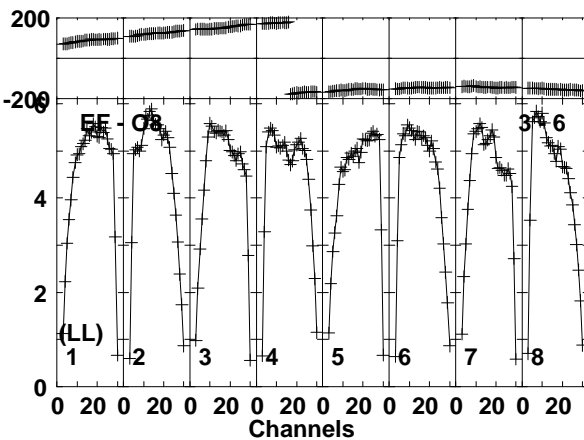
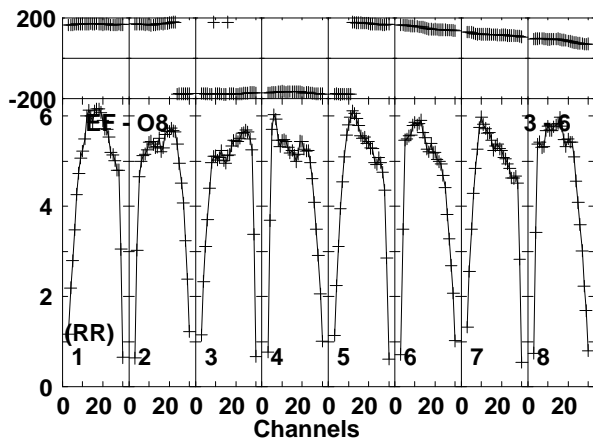
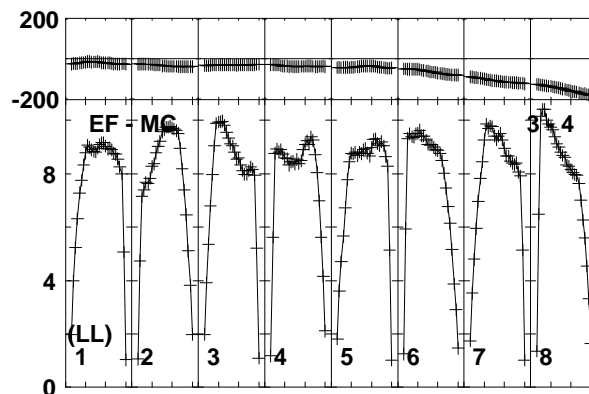
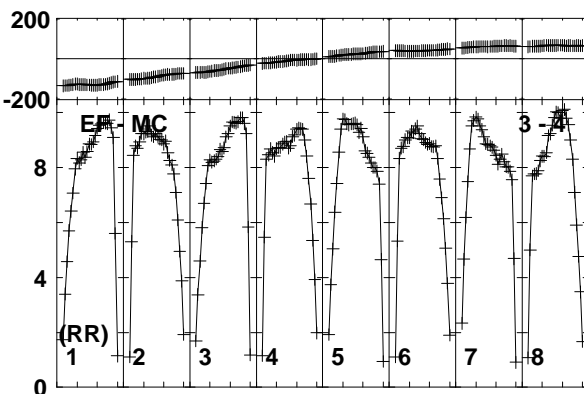
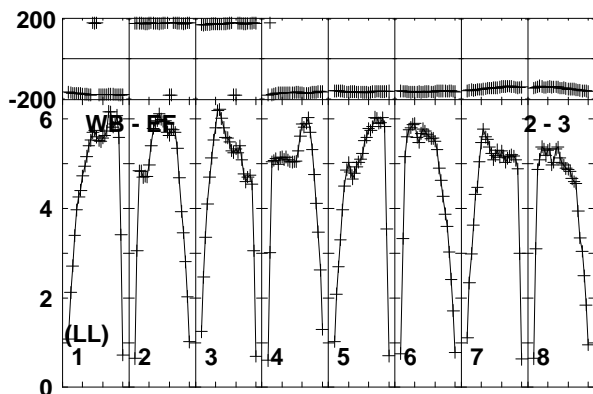
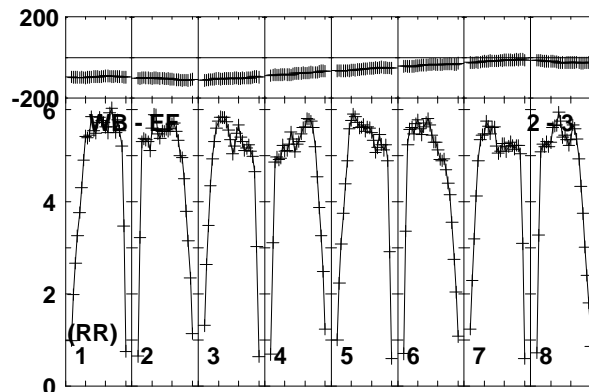
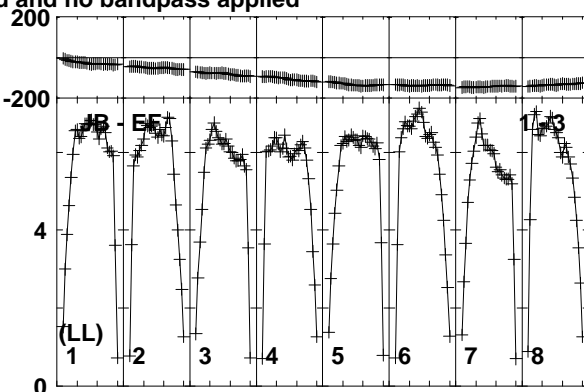
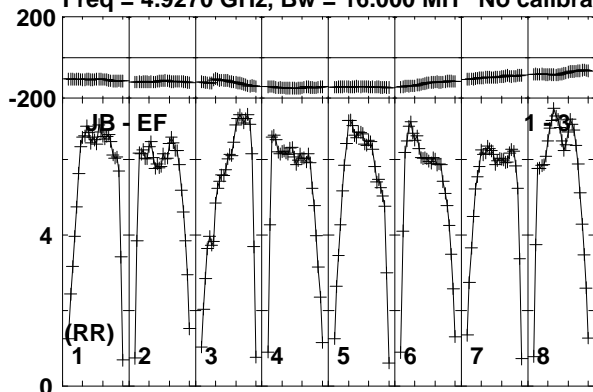

Lower frame: Milli Ampl Jy Top frame: Phas deg  
Vector averaged cross-power spectrum Baseline: JB (01) - EF (03)  
Timerange: 00/08:45:31 to 00/08:46:29

Plot file version 71 created 19-DEC-2018 17:58:17

J1619+2247 RY007C.UVDATA.1

Freq = 4.9270 GHz, Bw = 16.000 MH No calibration applied and no bandpass applied

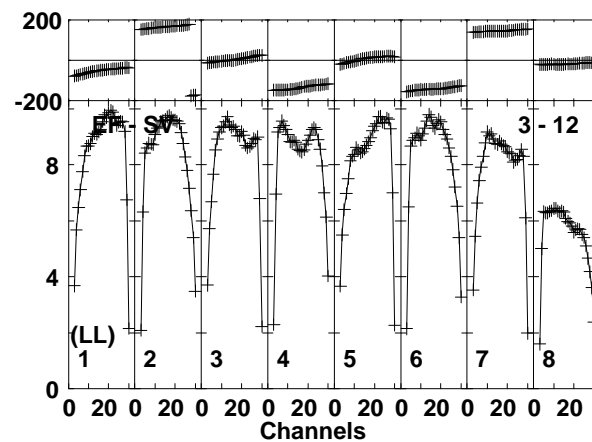
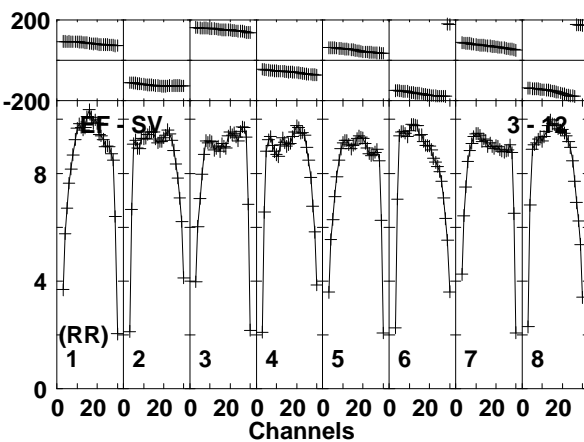
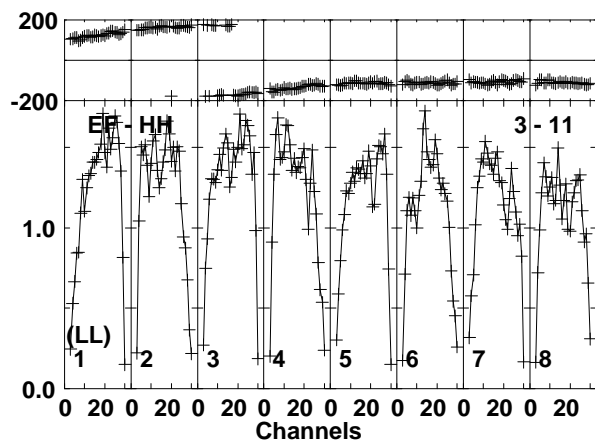
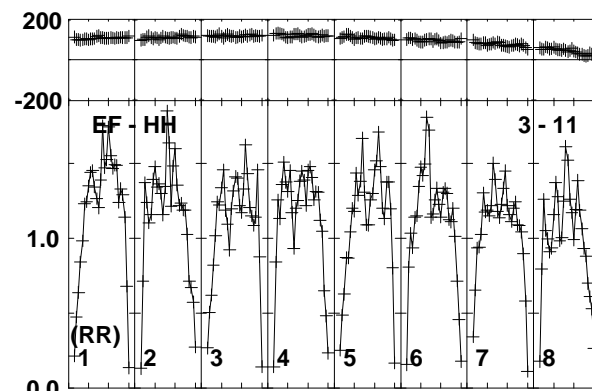
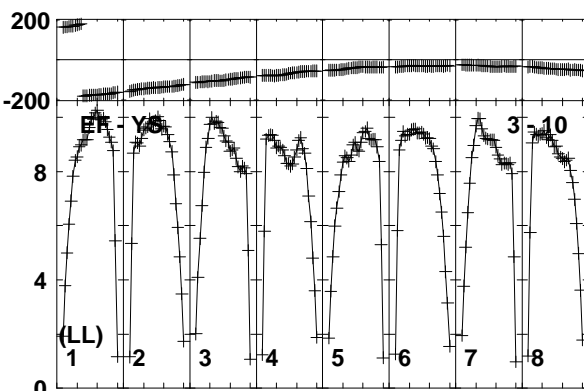
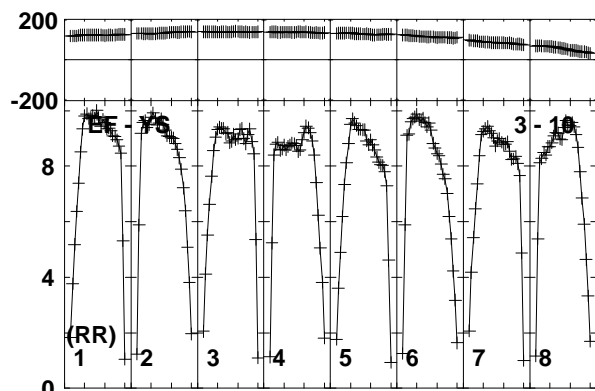
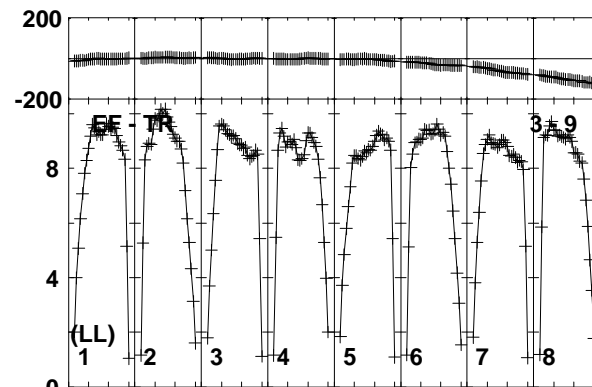
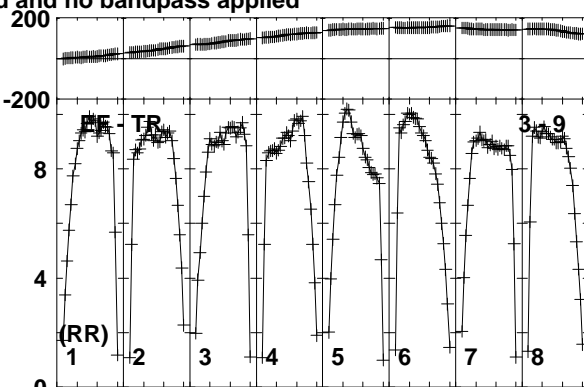
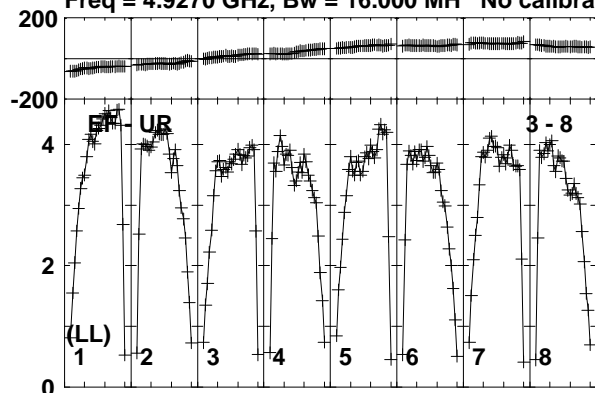

Lower frame: Milli Ampl Jy Top frame: Phas deg  
Vector averaged cross-power spectrum Baseline: EF (03) - UR (08)  
Timerange: 00/08:45:31 to 00/08:46:29

Plot file version 72 created 19-DEC-2018 17:58:17

J1619+2247 RY007C.UVDATA.1

Freq = 4.9270 GHz, Bw = 16.000 MH No calibration applied and no bandpass applied

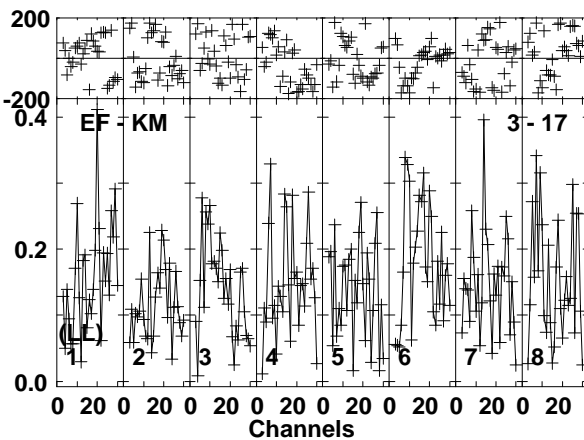
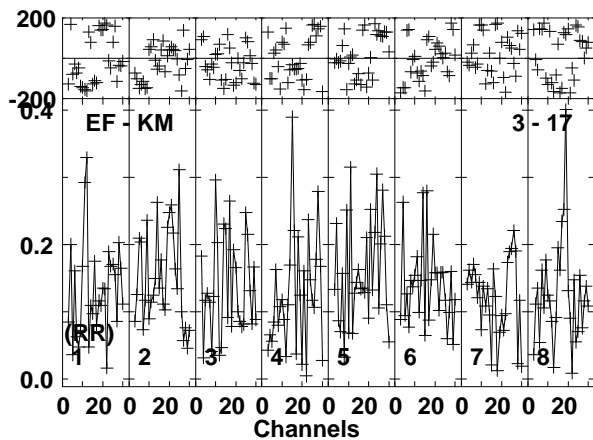
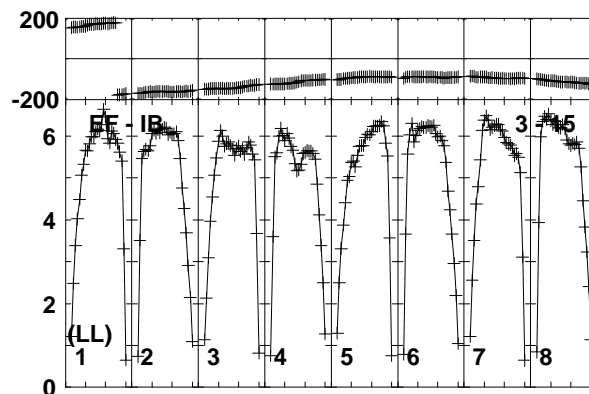
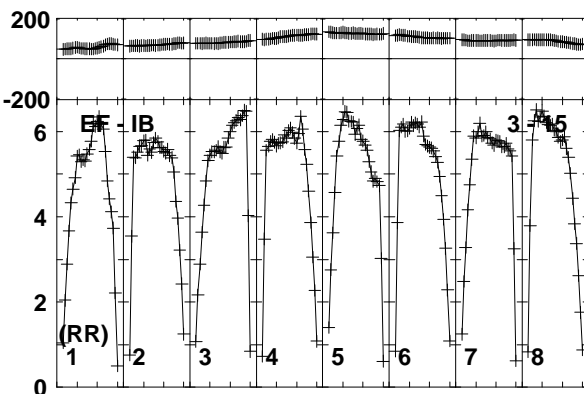
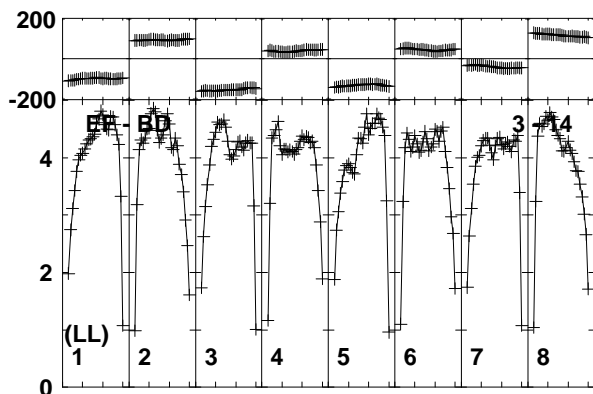
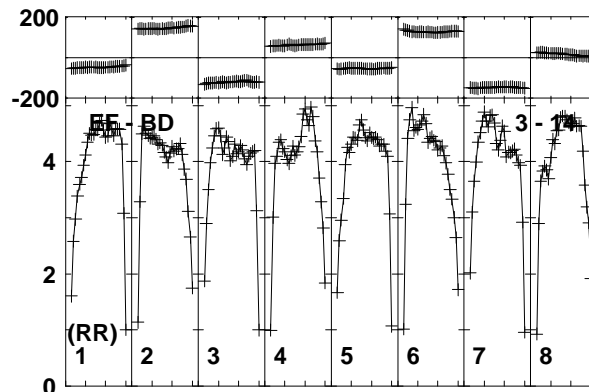
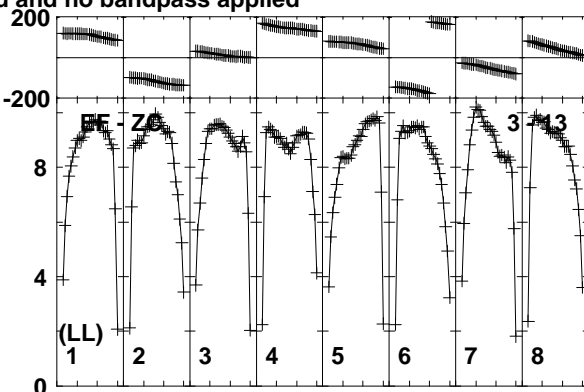
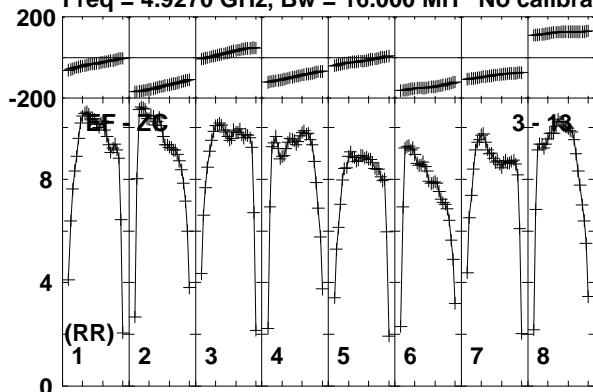

Lower frame: Milli Ampl Jy Top frame: Phas deg  
Vector averaged cross-power spectrum Baseline: EF (03) - ZC (13)  
Timerange: 00/08:45:31 to 00/08:46:29

Plot file version 73 created 19-DEC-2018 17:58:17

AT2018\_RY007C.UVDATA.1

Freq = 4.9270 GHz, Bw = 16.000 MH No calibration applied and no bandpass applied

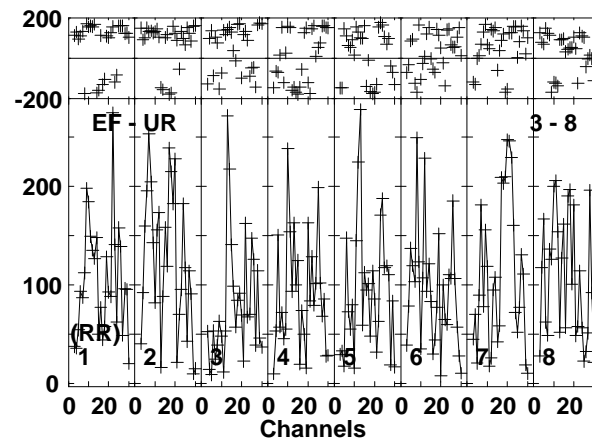
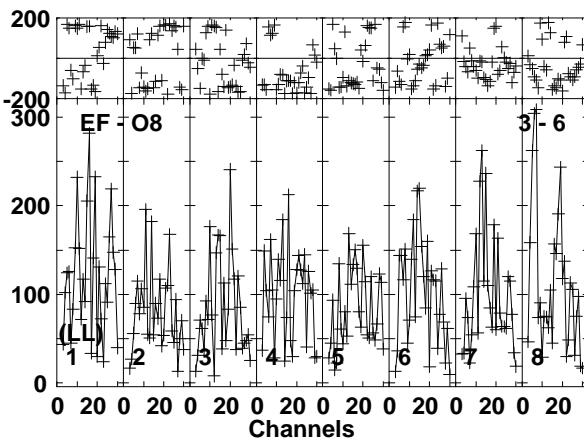
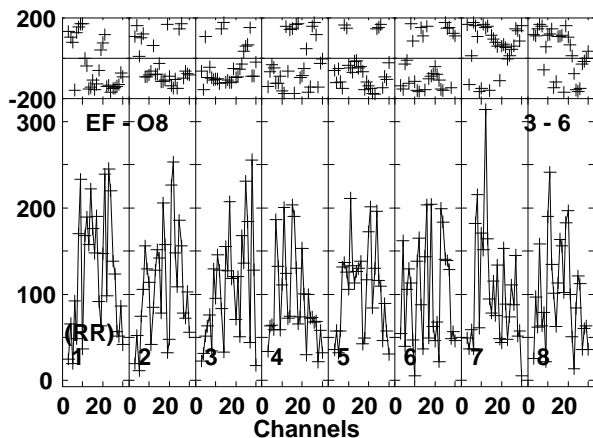
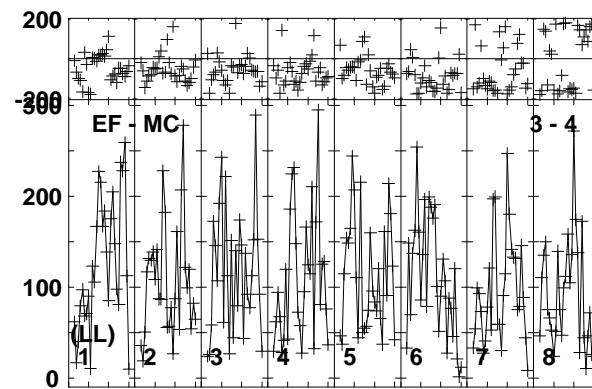
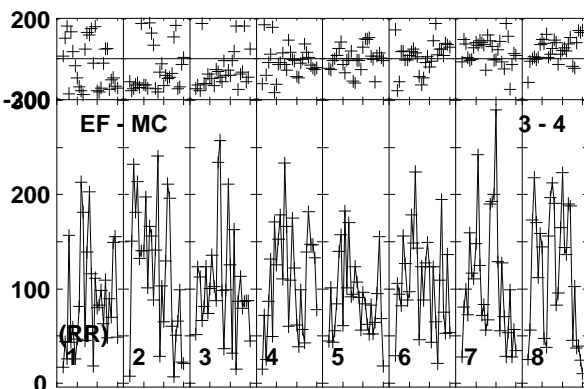
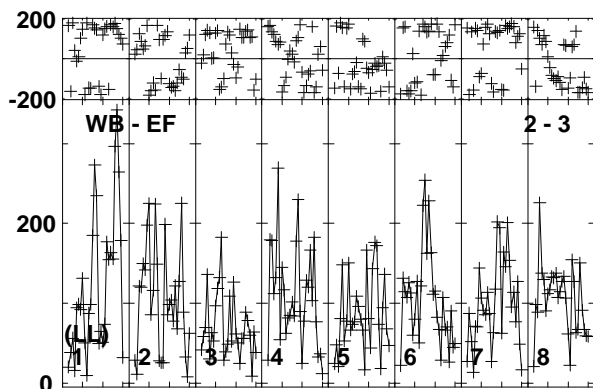
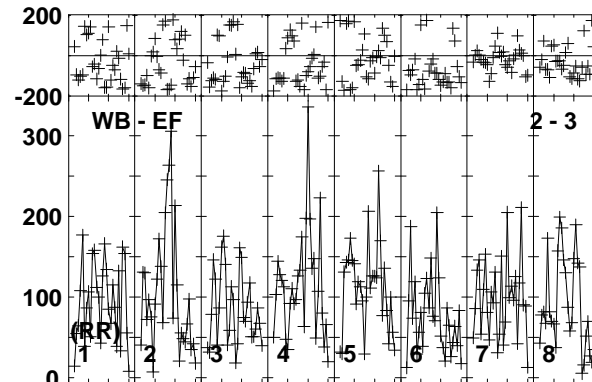
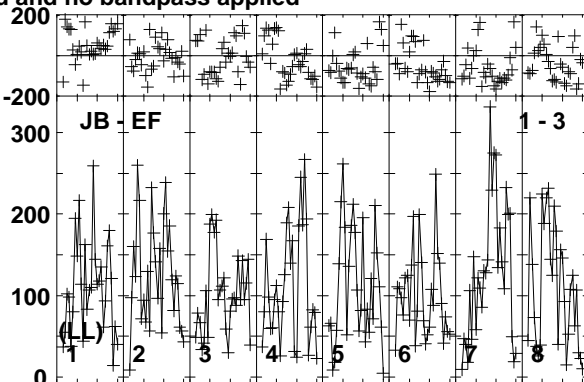
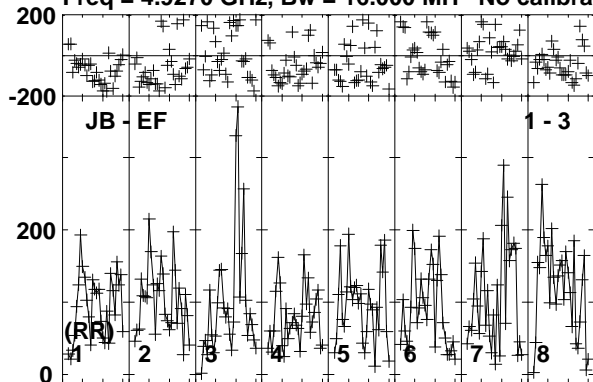

Lower frame: Micro Ampl Jy Top frame: Phas deg  
Vector averaged cross-power spectrum Baseline: JB (01) - EF (03)  
Timerange: 00/08:46:31 to 00/08:49:29

Plot file version 74 created 19-DEC-2018 17:58:17

AT2018\_RY007C.UVDATA.1

Freq = 4.9270 GHz, Bw = 16.000 MH No calibration applied and no bandpass applied

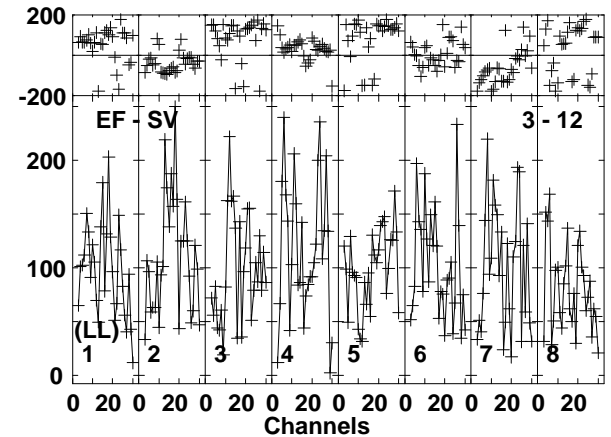
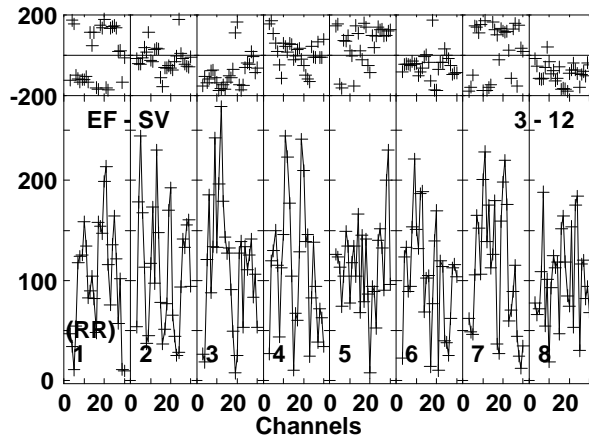
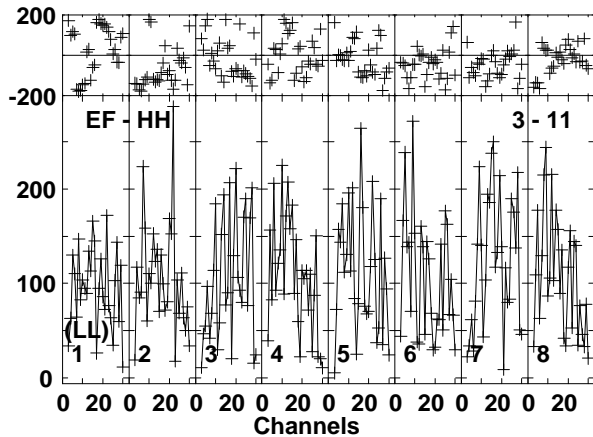
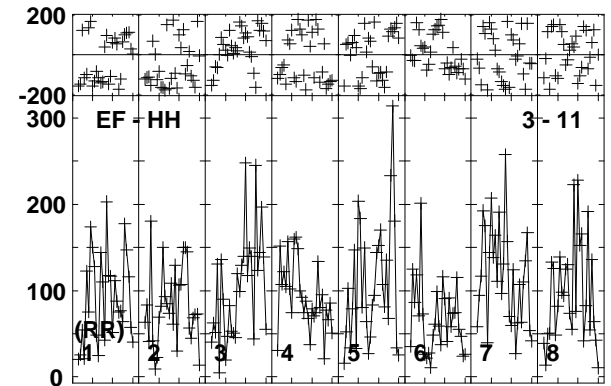
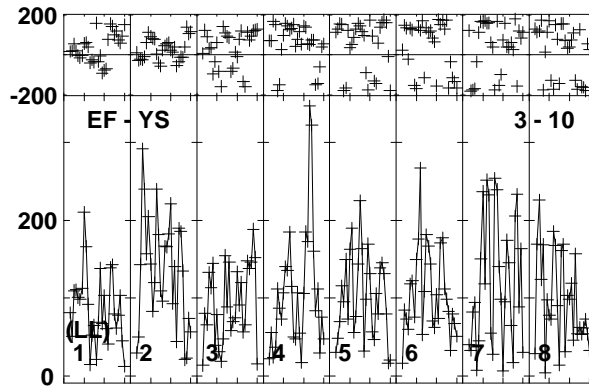
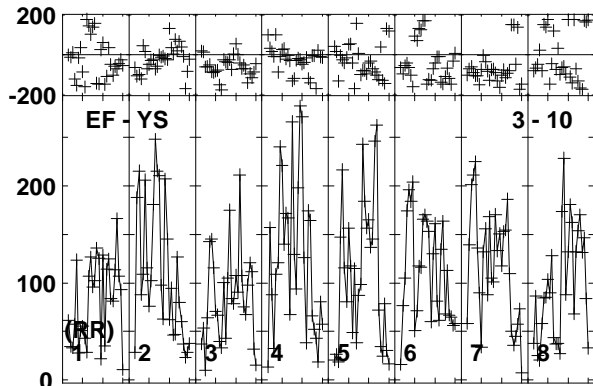
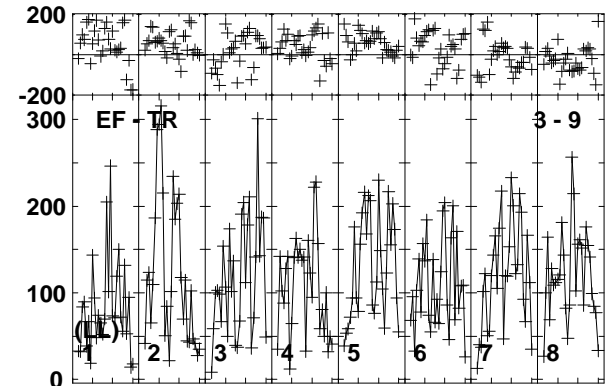
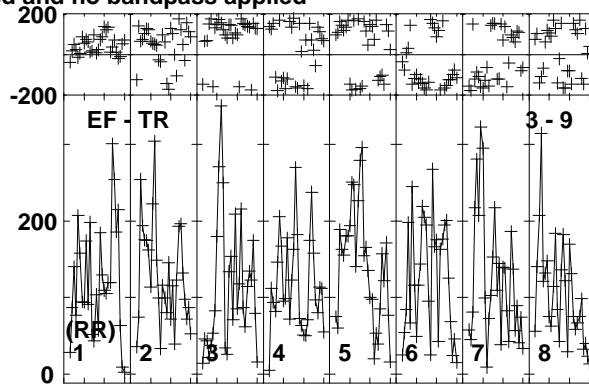
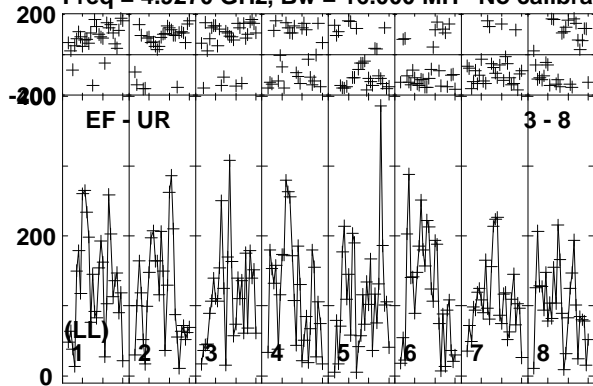

Lower frame: Micro Ampl Jy Top frame: Phas deg  
Vector averaged cross-power spectrum Baseline: EF (03) - UR (08)  
Timerange: 00/08:46:31 to 00/08:49:29



Plot file version 75 created 19-DEC-2018 17:58:17

AT2018\_RY007C.UVDATA.1

Freq = 4.9270 GHz, Bw = 16.000 MH No calibration applied and no bandpass applied

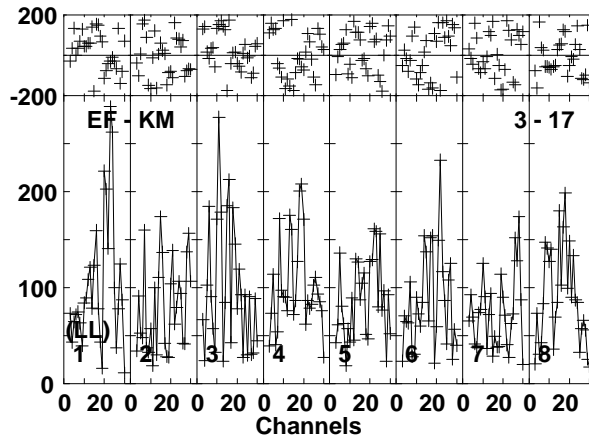
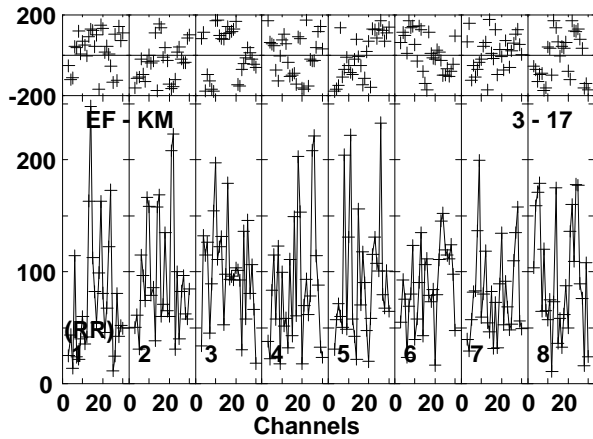
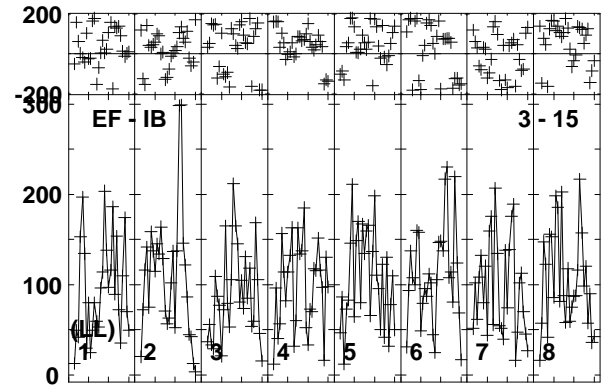
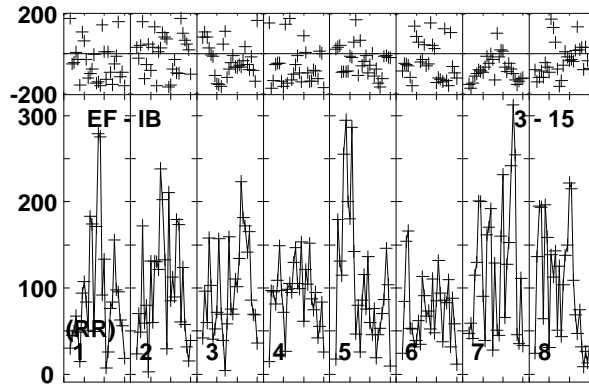
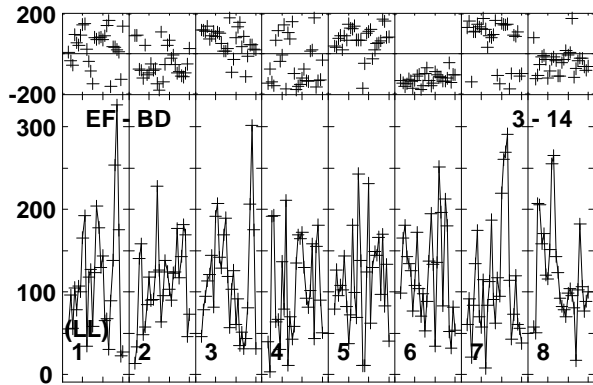
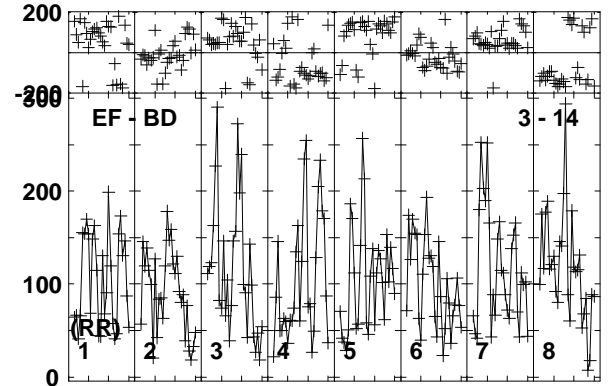
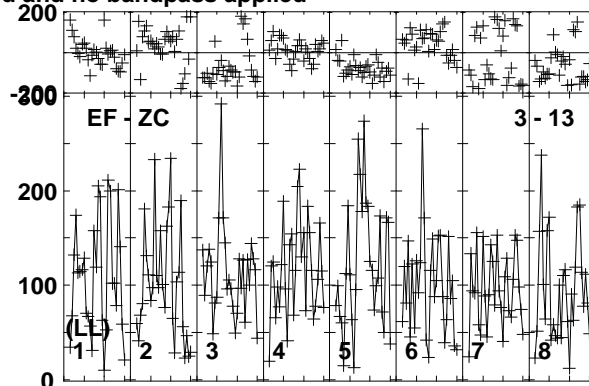
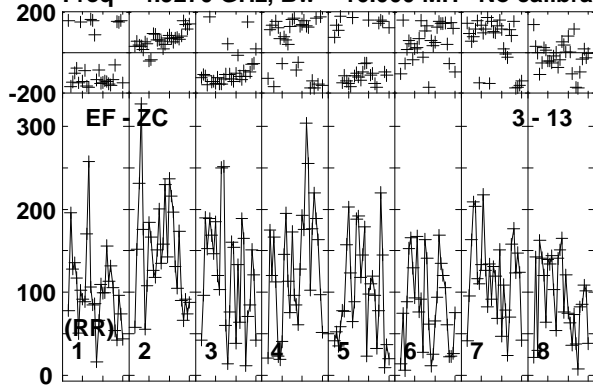

Lower frame: Micro Ampl Jy Top frame: Phas deg  
Vector averaged cross-power spectrum Baseline: EF (03) - ZC (13)  
Timerange: 00/08:46:31 to 00/08:49:29

Plot file version 76 created 19-DEC-2018 17:58:18

J1619+2247 RY007C.UVDATA.1

Freq = 4.9270 GHz, Bw = 16.000 MH No calibration applied and no bandpass applied

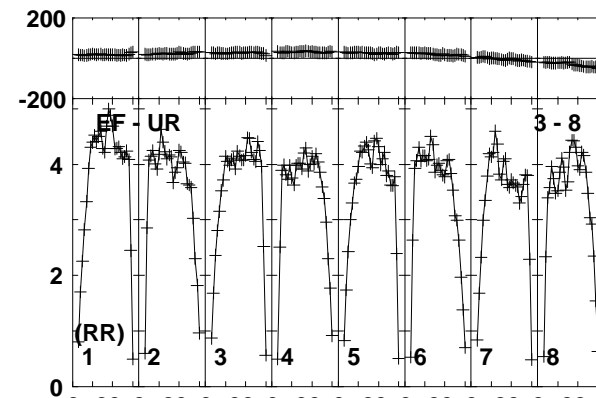
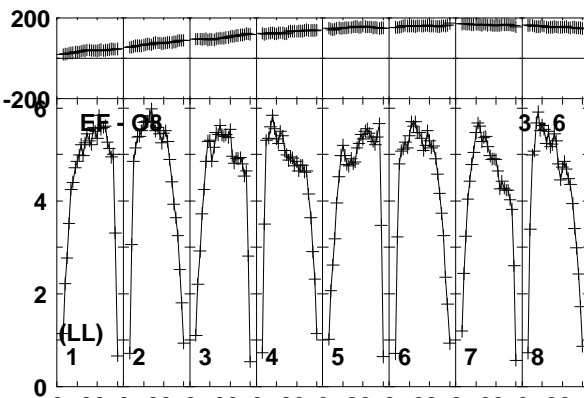
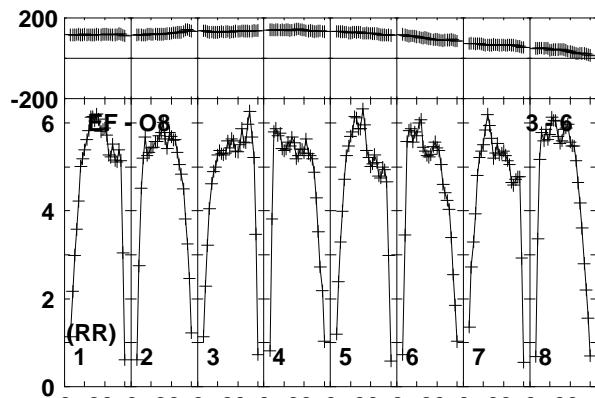
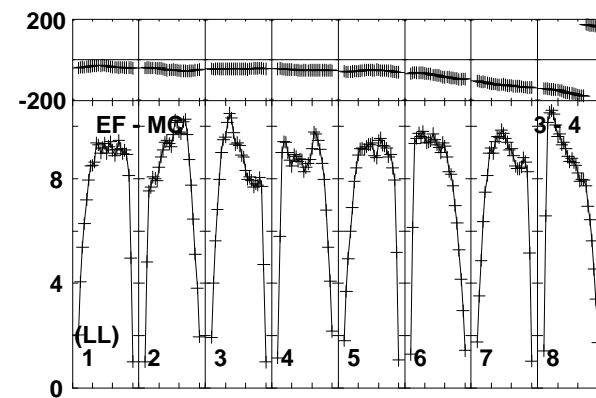
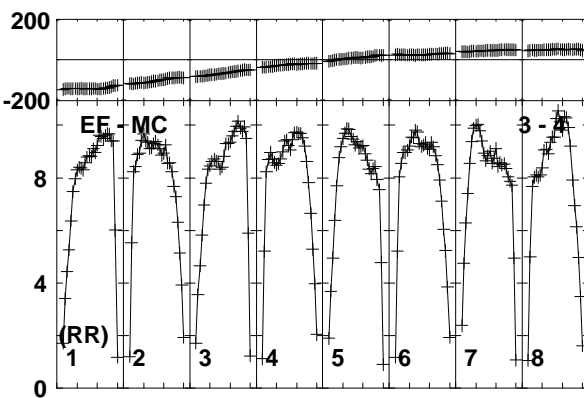
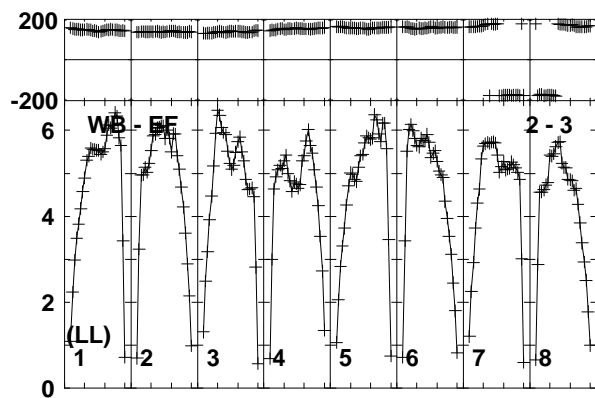
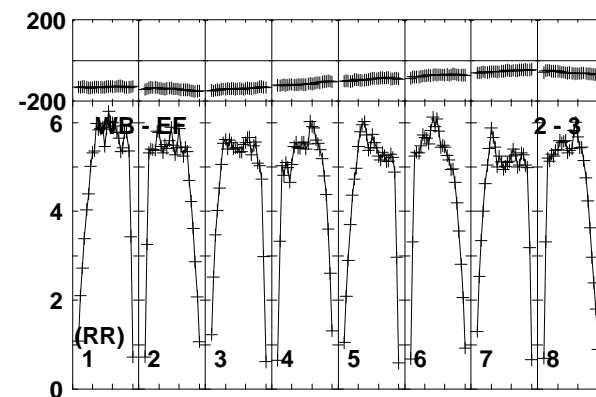
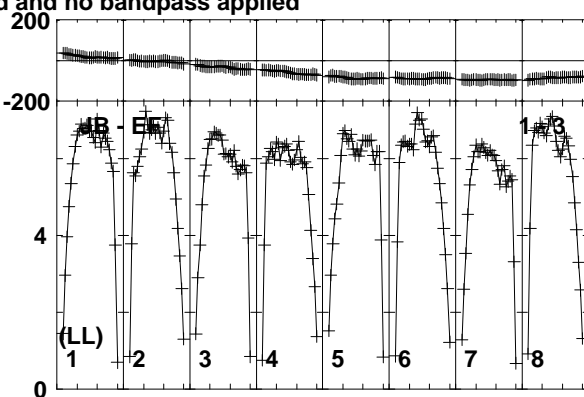
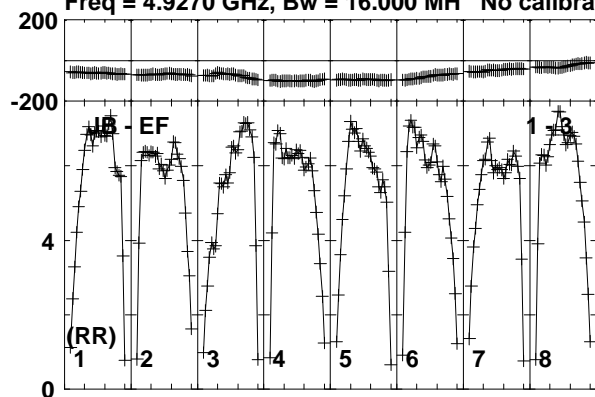

Lower frame: Milli Ampl Jy Top frame: Phas deg  
Vector averaged cross-power spectrum Baseline: JB (01) - EF (03)  
Timerange: 00/08:49:31 to 00/08:50:29

Plot file version 77 created 19-DEC-2018 17:58:18

J1619+2247 RY007C.UVDATA.1

Freq = 4.9270 GHz, Bw = 16.000 MH No calibration applied and no bandpass applied

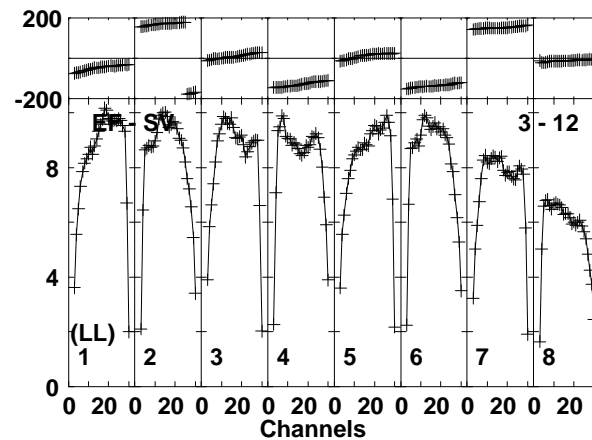
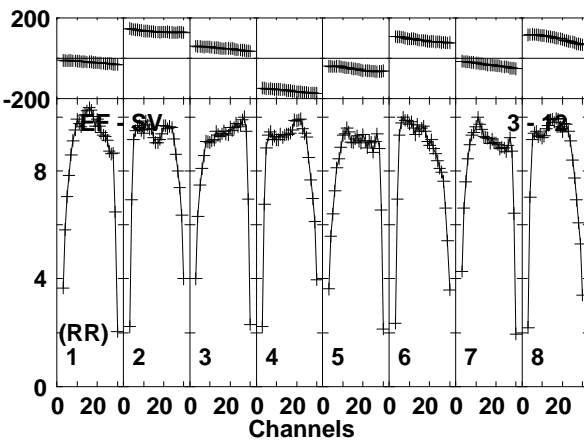
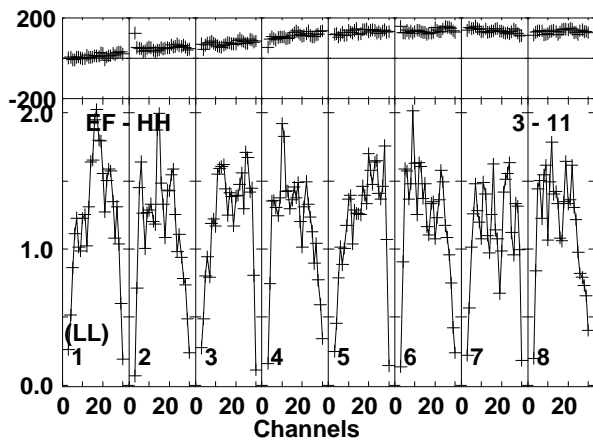
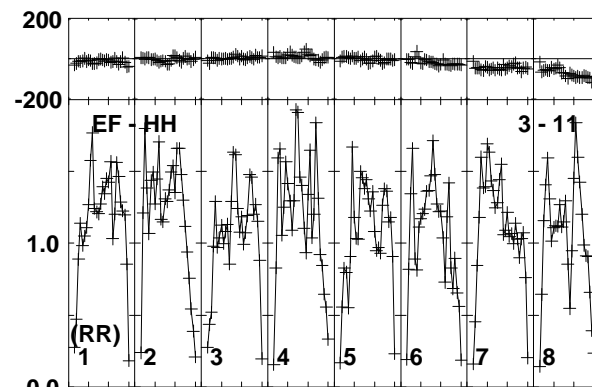
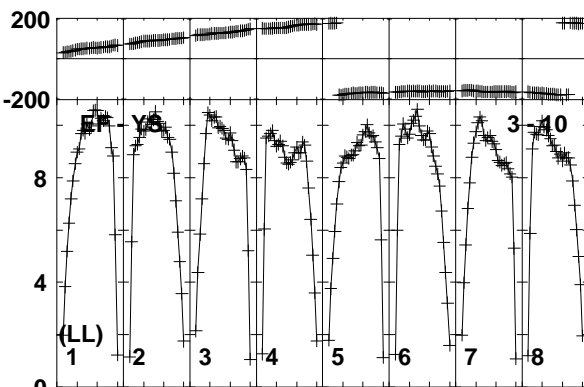
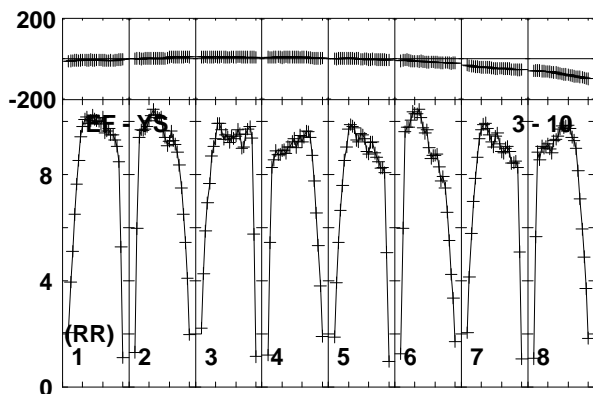
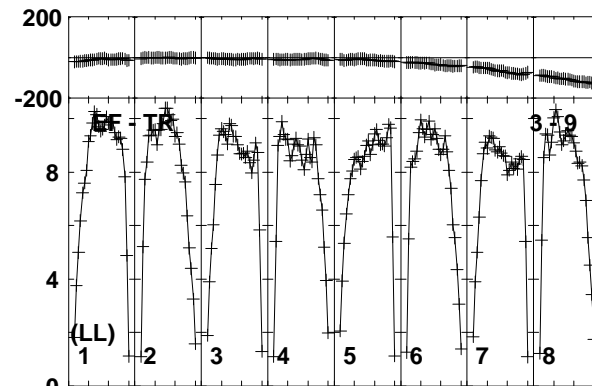
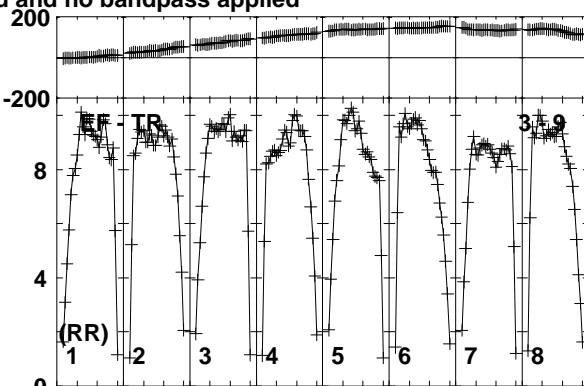
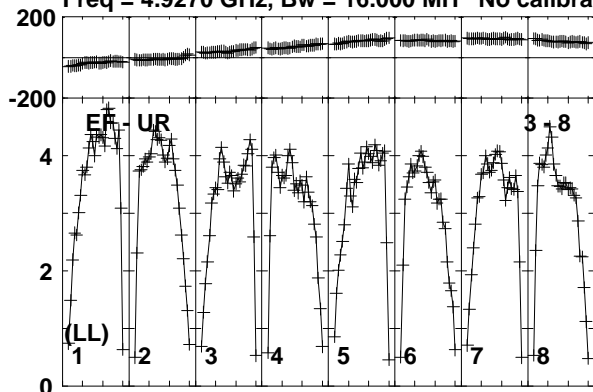

Lower frame: Milli Ampl Jy Top frame: Phas deg  
Vector averaged cross-power spectrum Baseline: EF (03) - UR (08)  
Timerange: 00/08:49:31 to 00/08:50:29

Plot file version 78 created 19-DEC-2018 17:58:18

J1619+2247 RY007C.UVDATA.1

Freq = 4.9270 GHz, Bw = 16.000 MH No calibration applied and no bandpass applied

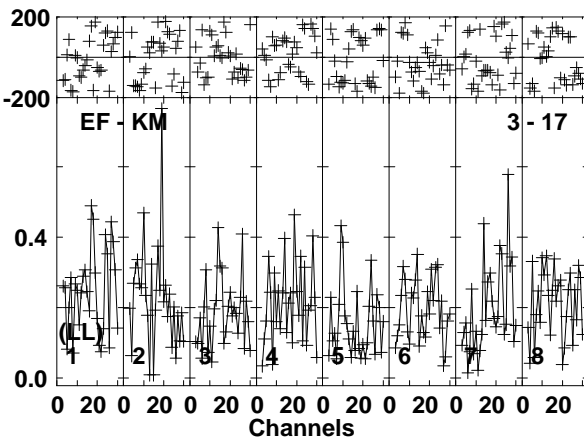
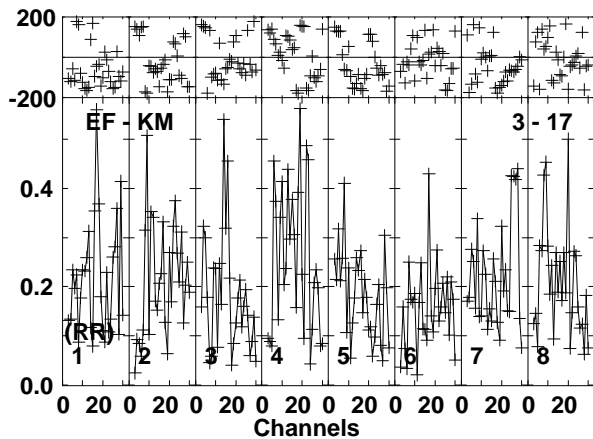
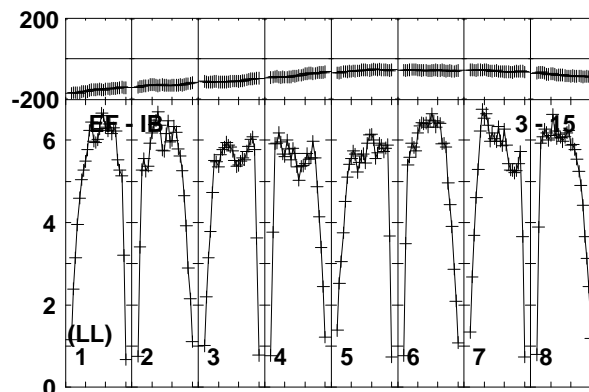
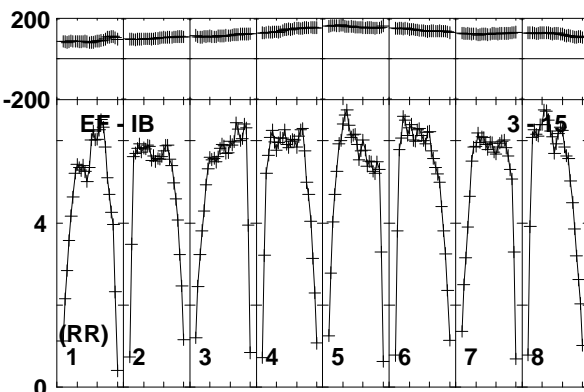
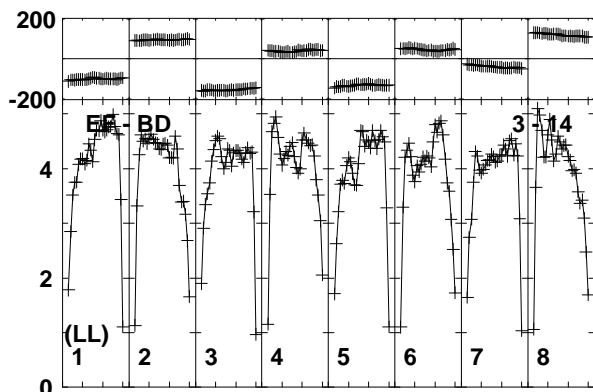
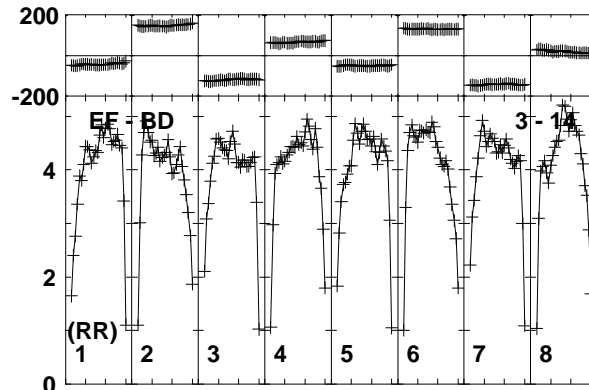
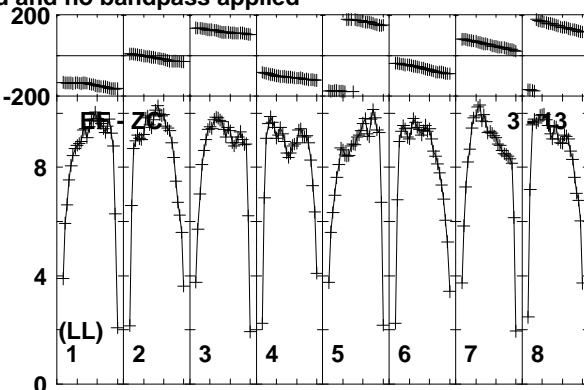
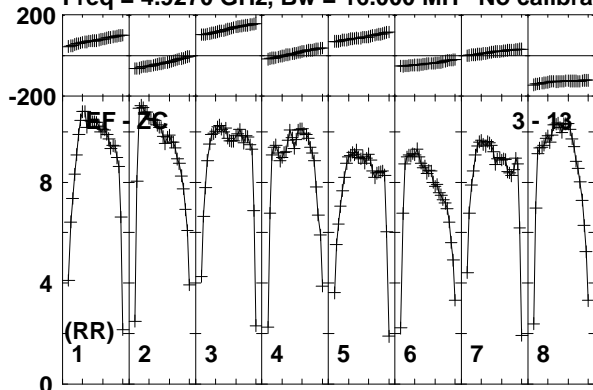

Lower frame: Milli Ampl Jy Top frame: Phas deg  
Vector averaged cross-power spectrum Baseline: EF (03) - ZC (13)  
Timerange: 00/08:49:31 to 00/08:50:29

Plot file version 79 created 19-DEC-2018 17:58:18

AT2018\_RY007C.UVDATA.1

Freq = 4.9270 GHz, Bw = 16.000 MH No calibration applied and no bandpass applied

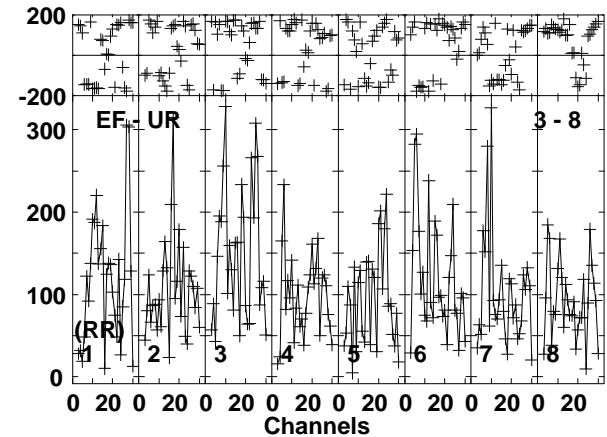
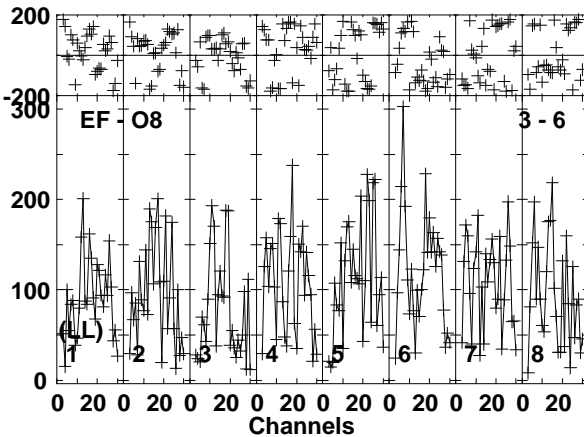
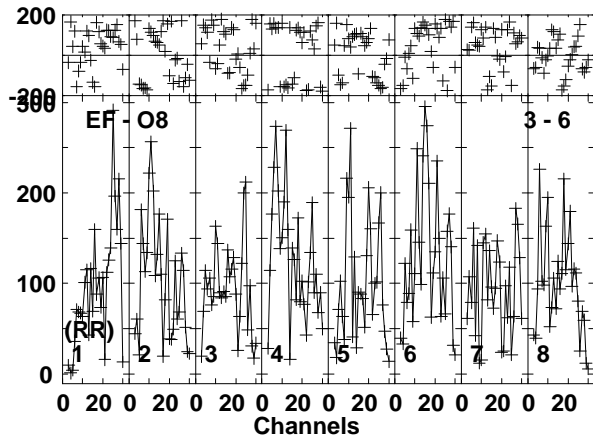
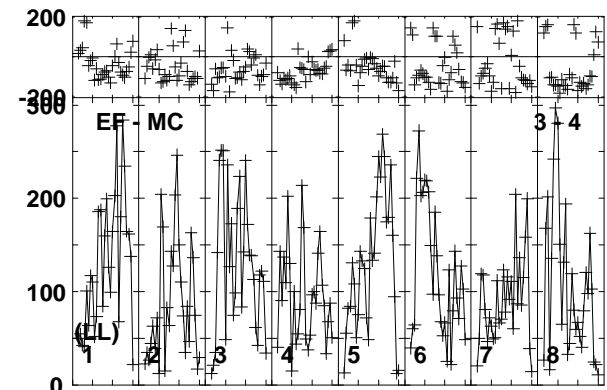
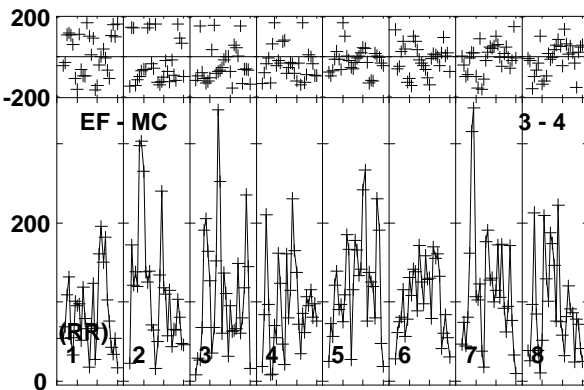
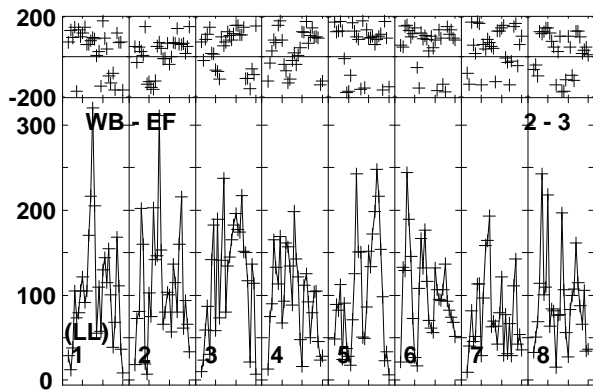
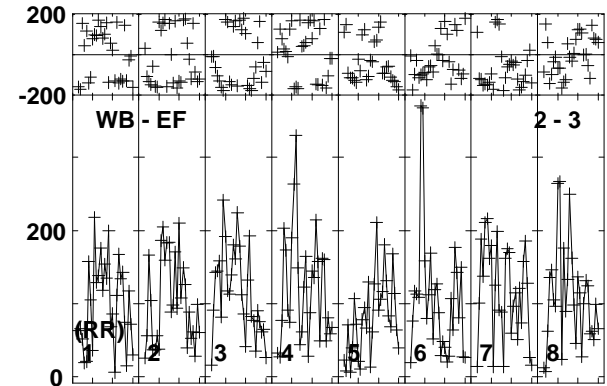
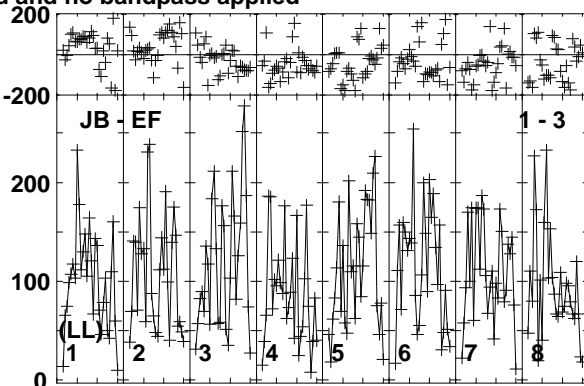
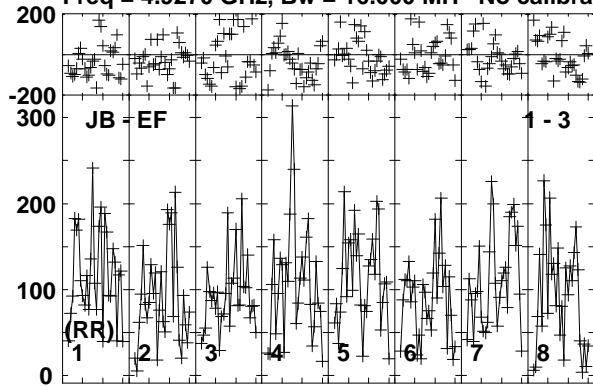

Lower frame: Micro Ampl Jy Top frame: Phas deg  
Vector averaged cross-power spectrum Baseline: JB (01) - EF (03)  
Timerange: 00/08:50:31 to 00/08:53:29

Plot file version 80 created 19-DEC-2018 17:58:18

AT2018\_RY007C.UVDATA.1

Freq = 4.9270 GHz, Bw = 16.000 MH No calibration applied and no bandpass applied

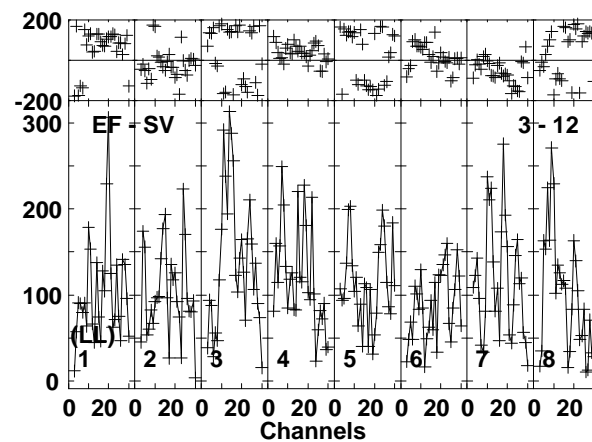
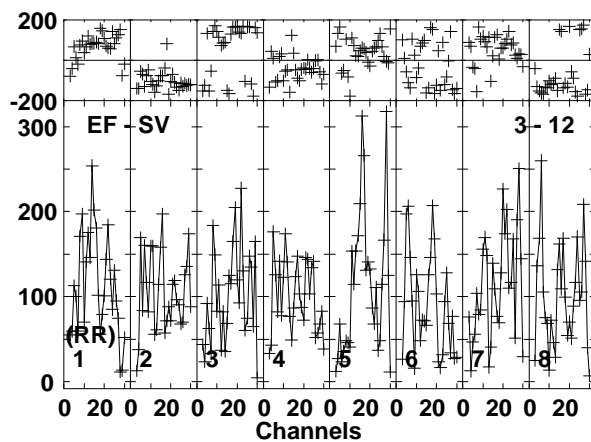
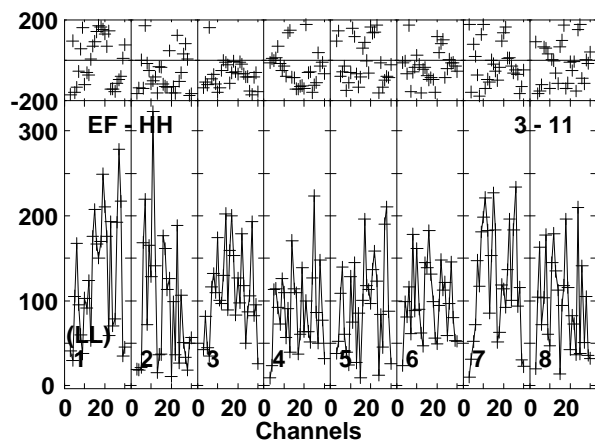
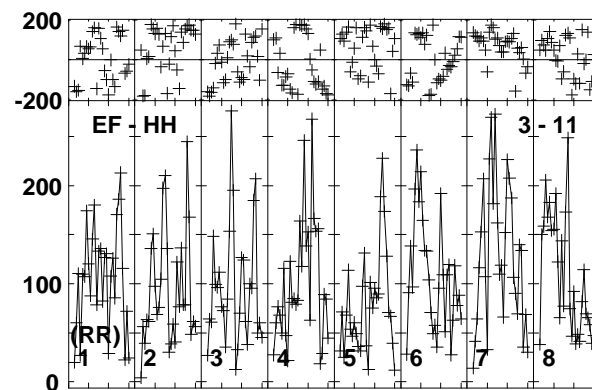
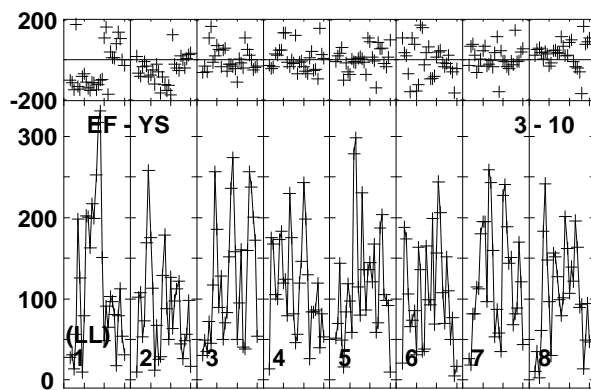
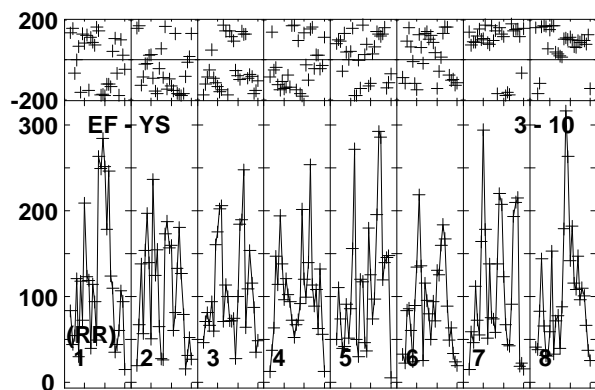
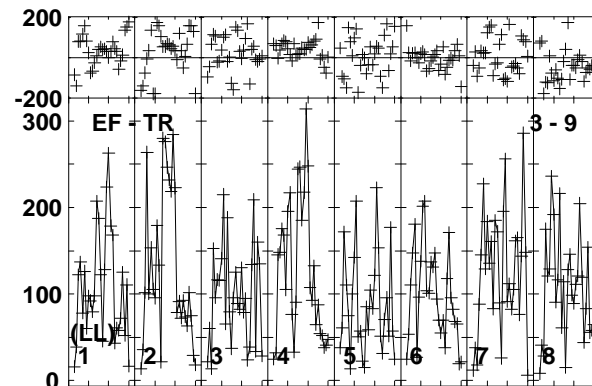
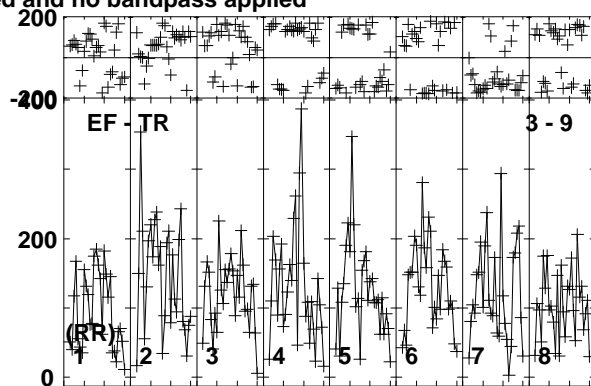
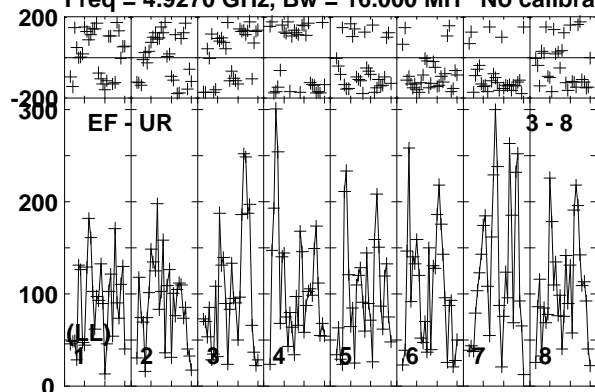

Lower frame: Micro Ampl Jy Top frame: Phas deg  
Vector averaged cross-power spectrum Baseline: EF (03) - UR (08)  
Timerange: 00/08:50:31 to 00/08:53:29

Plot file version 81 created 19-DEC-2018 17:58:18

AT2018\_RY007C.UVDATA.1

Freq = 4.9270 GHz, Bw = 16.000 MH No calibration applied and no bandpass applied

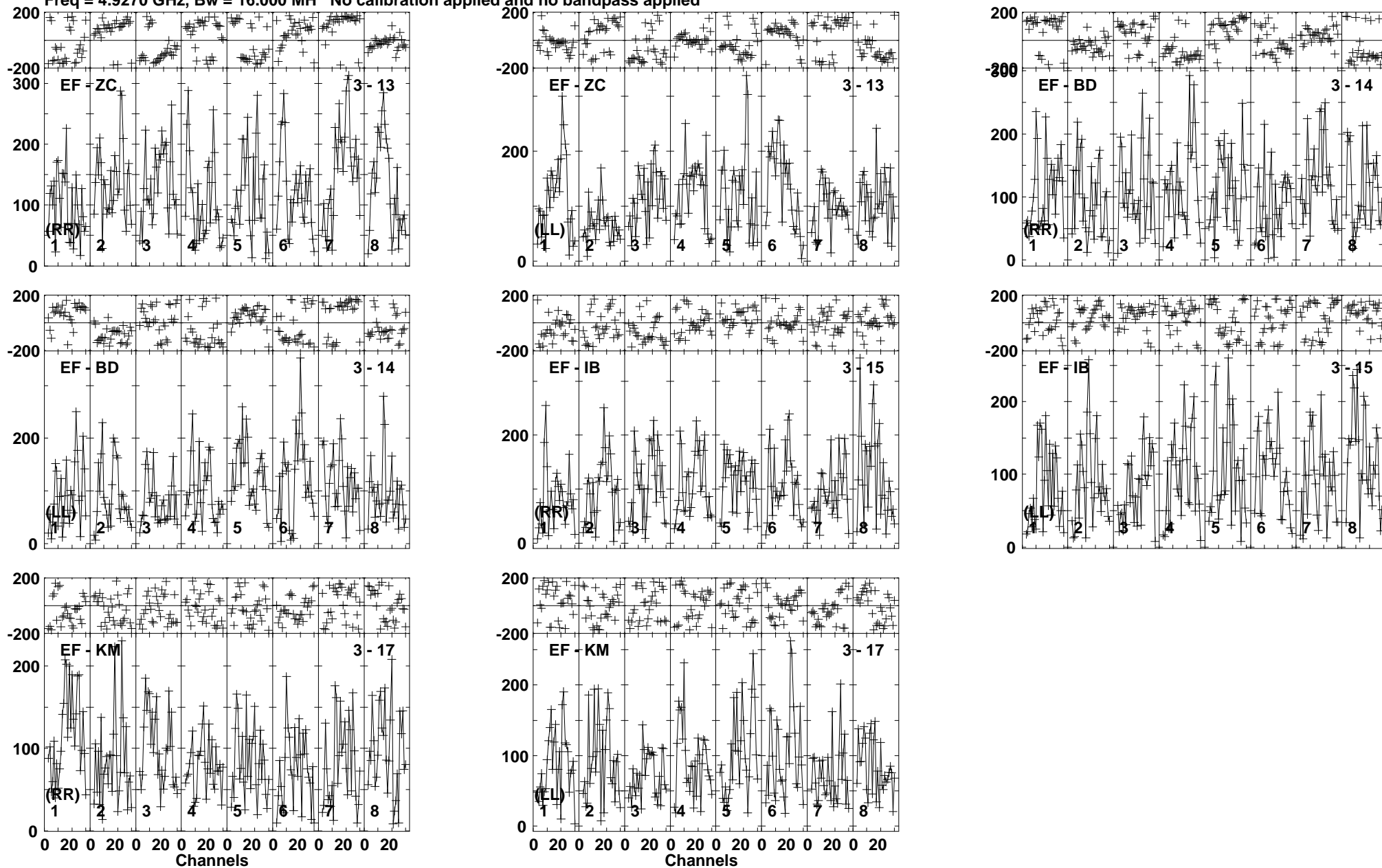

Lower frame: Micro Ampl Jy Top frame: Phas deg  
Vector averaged cross-power spectrum Baseline: EF (03) - ZC (13)  
Timerange: 00/08:50:31 to 00/08:53:29

Plot file version 82 created 19-DEC-2018 17:58:18

J1619+2247 RY007C.UVDATA.1

Freq = 4.9270 GHz, Bw = 16.000 MH No calibration applied and no bandpass applied

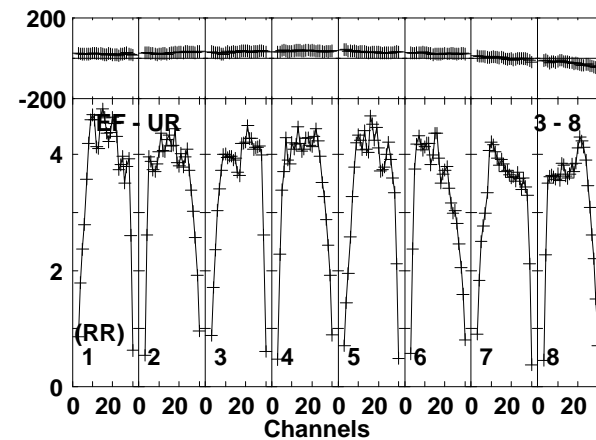
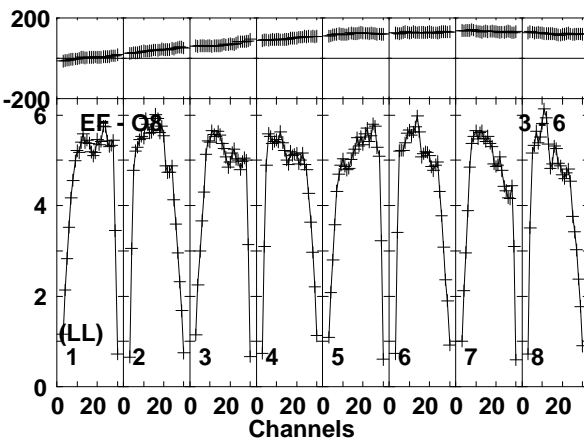
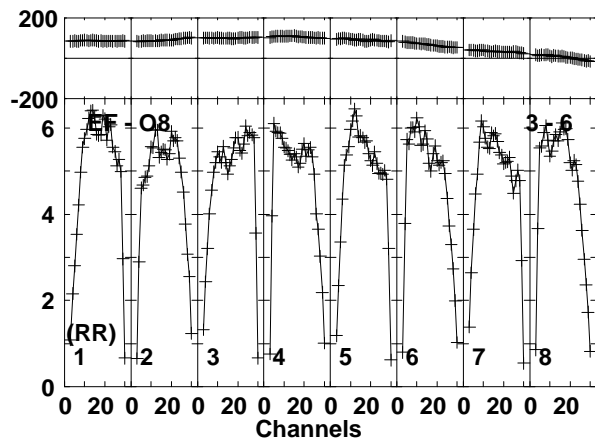
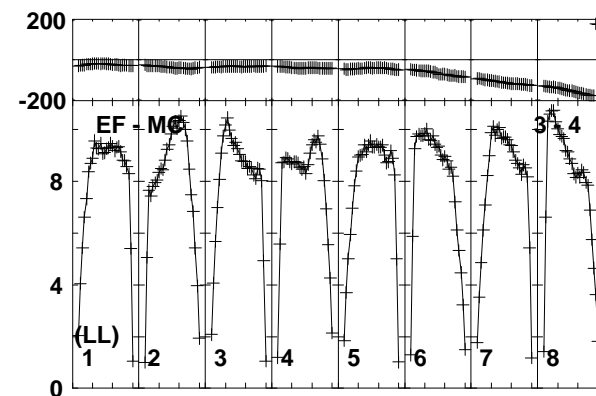
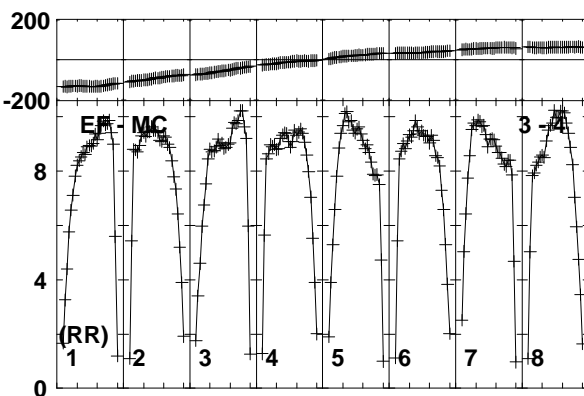
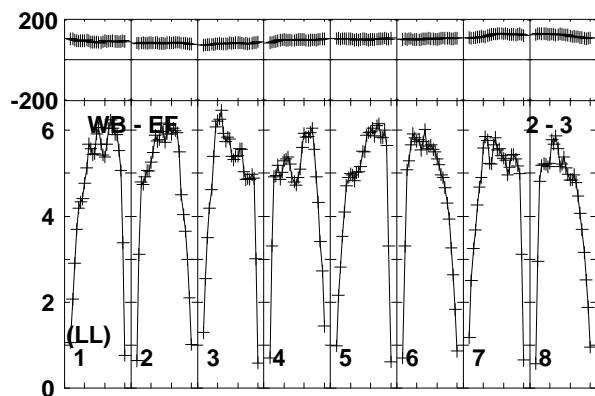
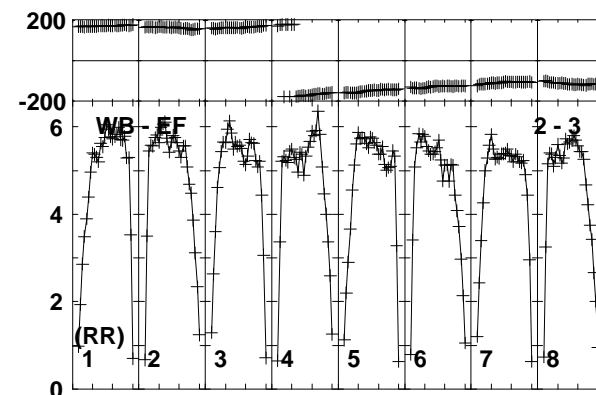
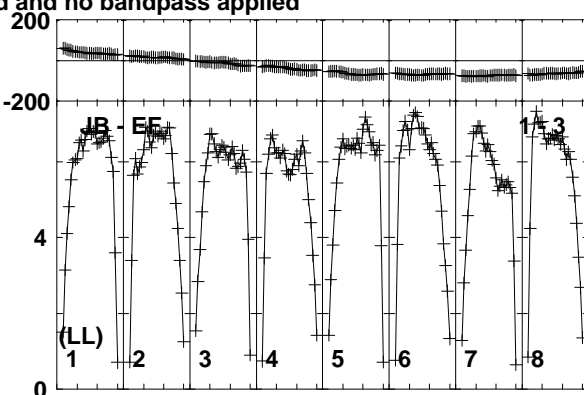
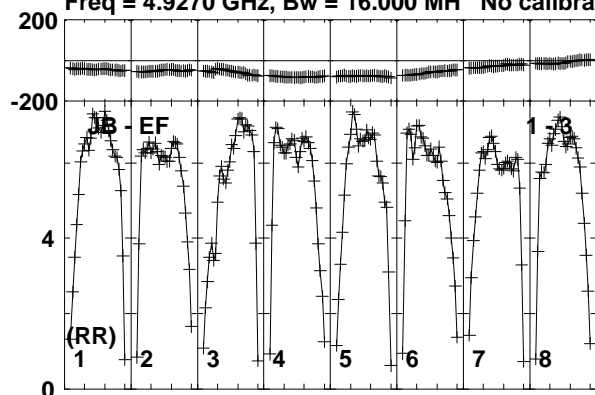

Lower frame: Milli Ampl Jy Top frame: Phas deg  
Vector averaged cross-power spectrum Baseline: JB (01) - EF (03)  
Timerange: 00/08:53:31 to 00/08:54:29



Plot file version 83 created 19-DEC-2018 17:58:18

J1619+2247 RY007C.UVDATA.1

Freq = 4.9270 GHz, Bw = 16.000 MH No calibration applied and no bandpass applied

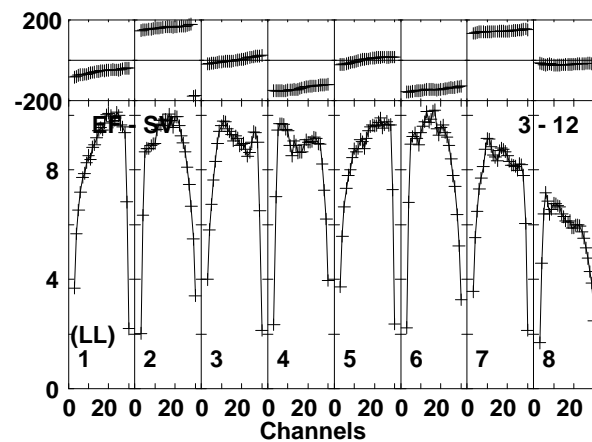
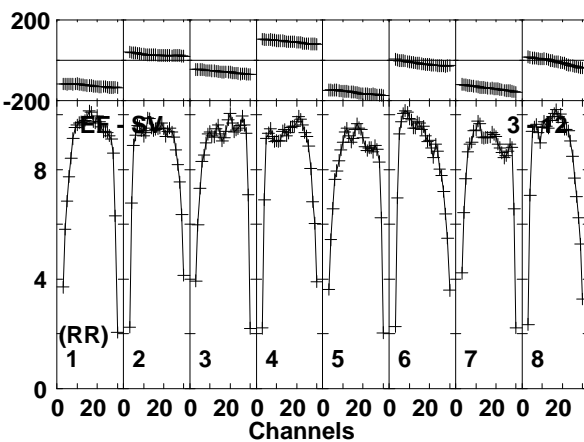
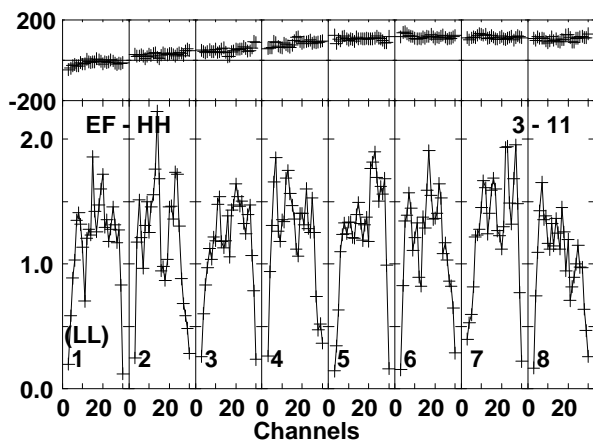
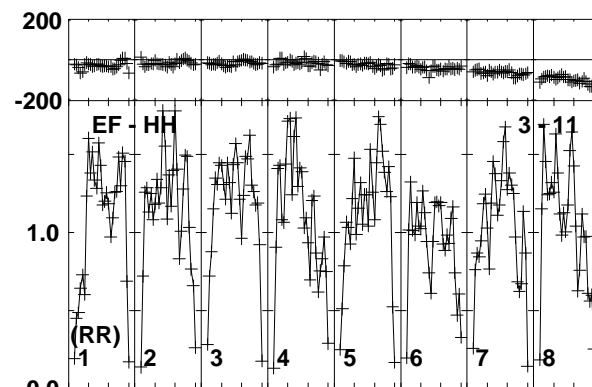
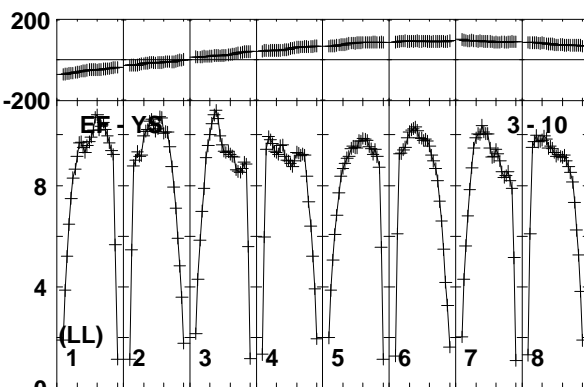
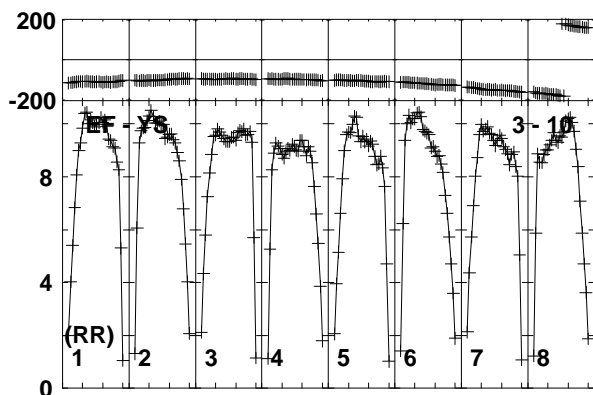
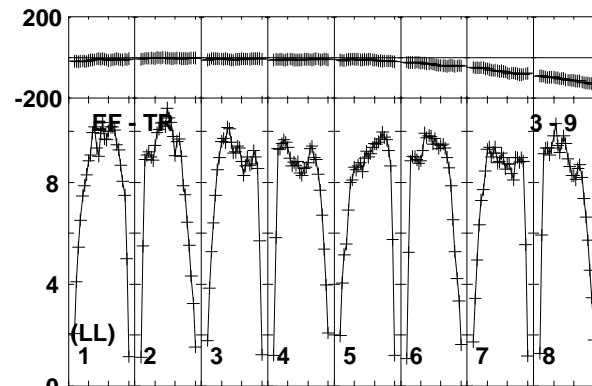
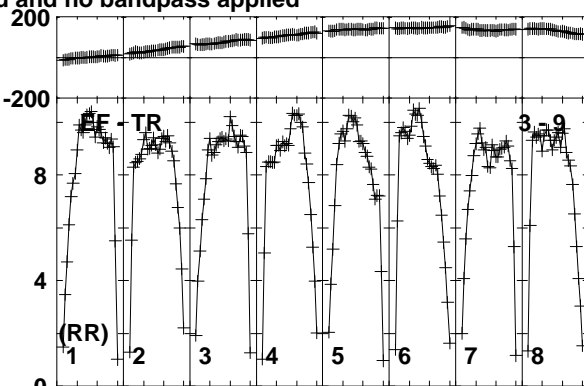
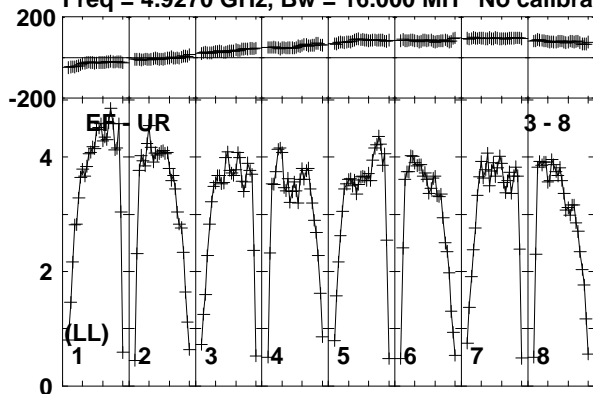

Lower frame: Milli Ampl Jy Top frame: Phas deg  
Vector averaged cross-power spectrum Baseline: EF (03) - UR (08)  
Timerange: 00/08:53:31 to 00/08:54:29

Plot file version 84 created 19-DEC-2018 17:58:18

J1619+2247 RY007C.UVDATA.1

Freq = 4.9270 GHz, Bw = 16.000 MH No calibration applied and no bandpass applied

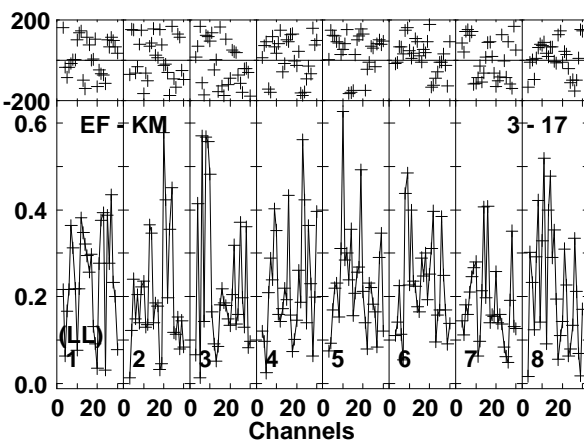
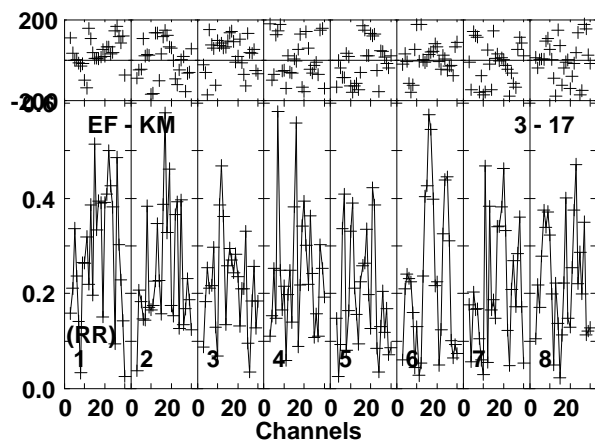
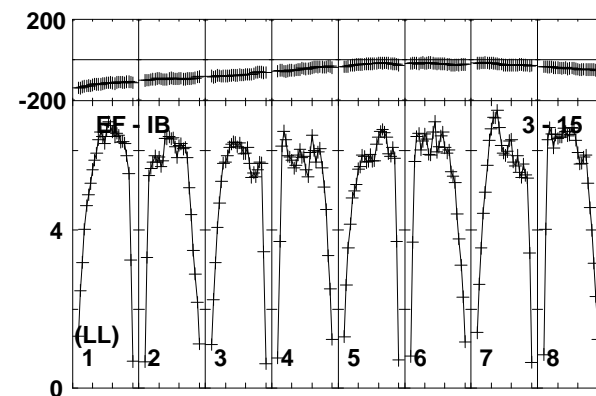
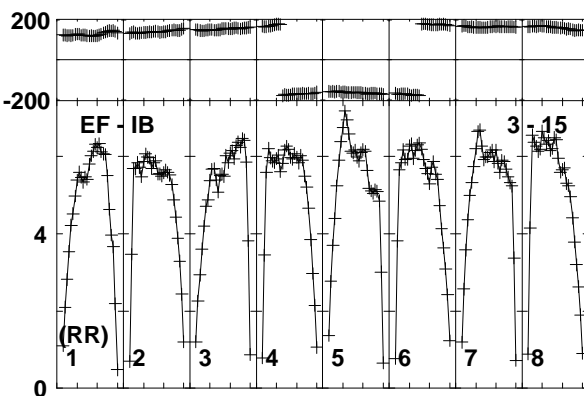
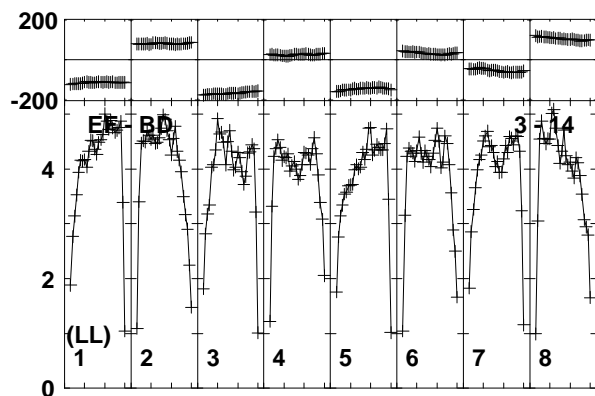
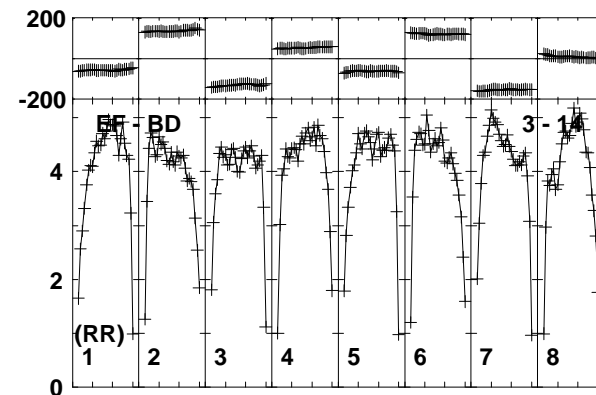
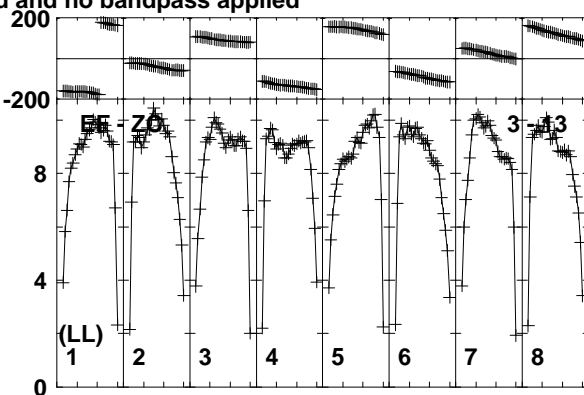
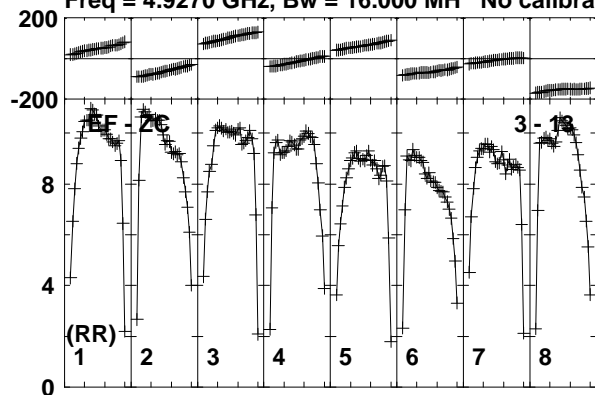

Lower frame: Milli Ampl Jy Top frame: Phas deg  
Vector averaged cross-power spectrum Baseline: EF (03) - ZC (13)  
Timerange: 00/08:53:31 to 00/08:54:29

Plot file version 85 created 19-DEC-2018 17:58:18

VLA1 RY007C.UVDATA.1

Freq = 4.9270 GHz, Bw = 16.000 MH No calibration applied and no bandpass applied

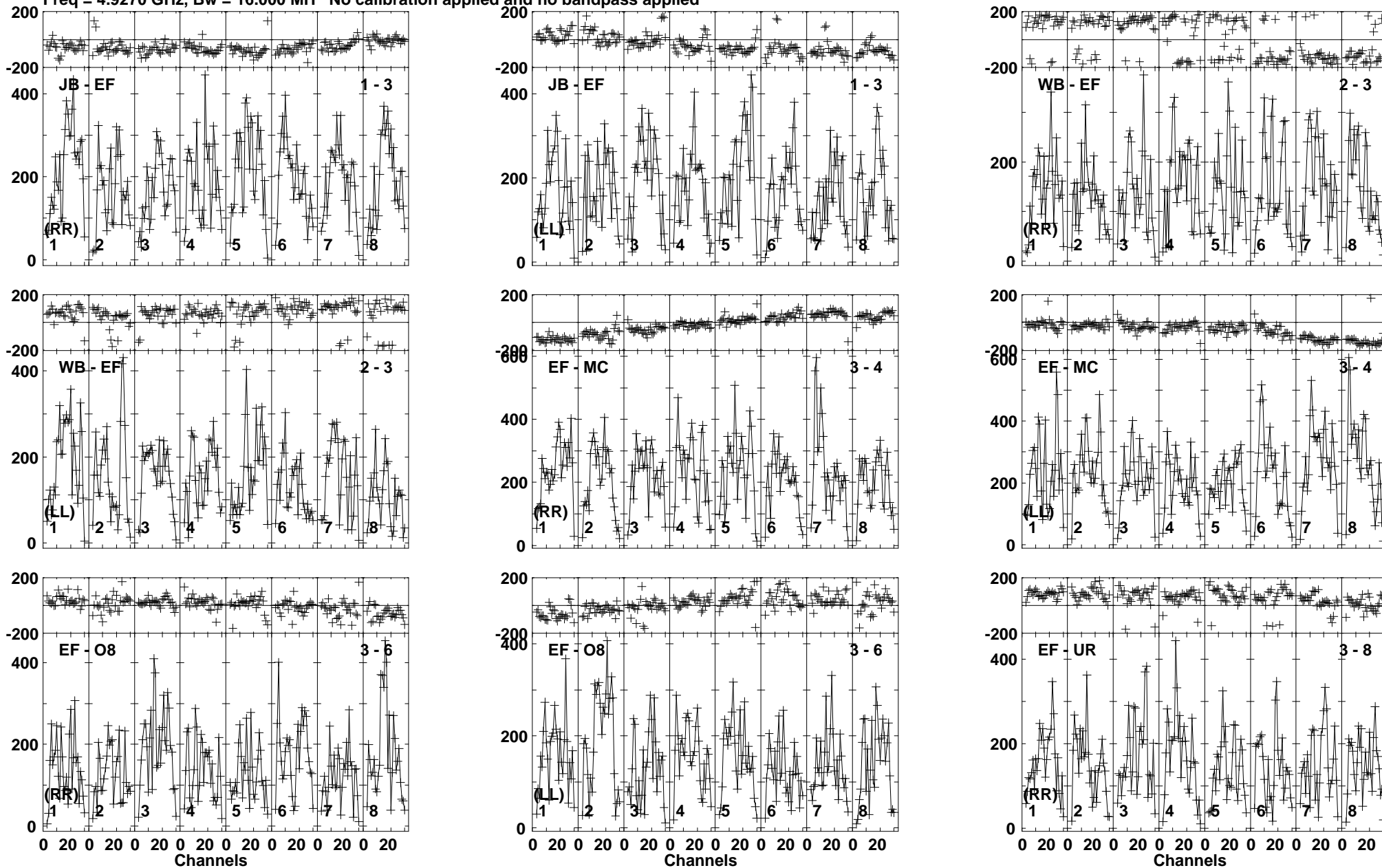

Lower frame: Micro Ampl Jy Top frame: Phas deg  
Vector averaged cross-power spectrum Baseline: JB (01) - EF (03)  
Timerange: 00/08:55:01 to 00/08:56:59

Plot file version 86 created 19-DEC-2018 17:58:18

VLA1 RY007C.UVDATA.1

Freq = 4.9270 GHz, Bw = 16.000 MH No calibration applied and no bandpass applied

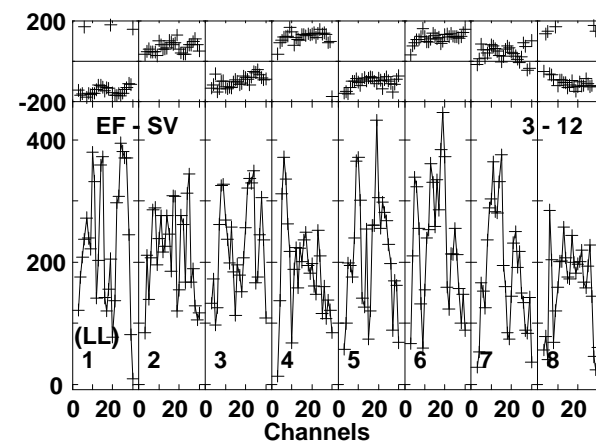
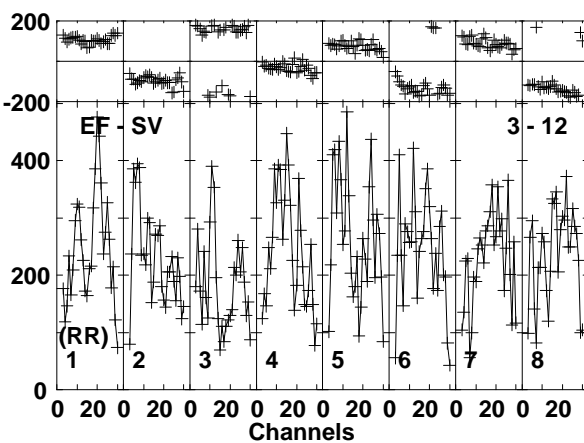
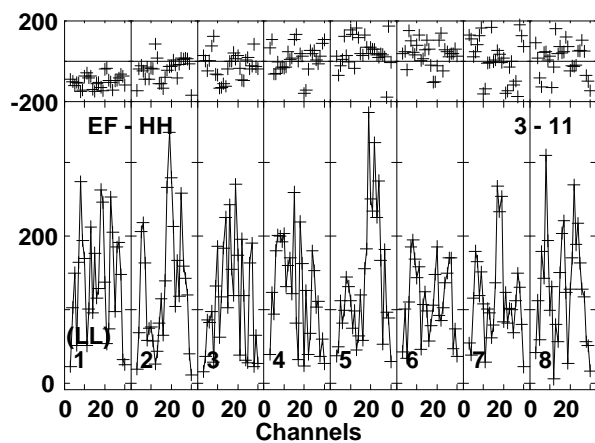
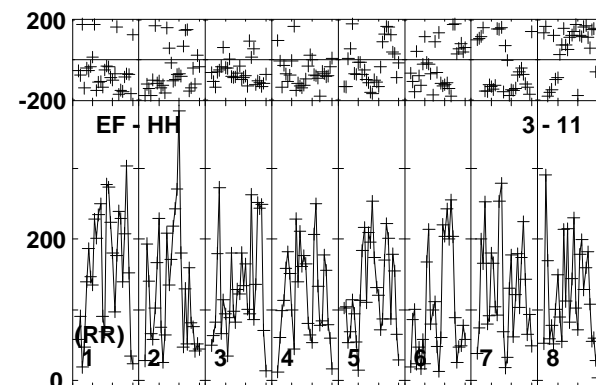
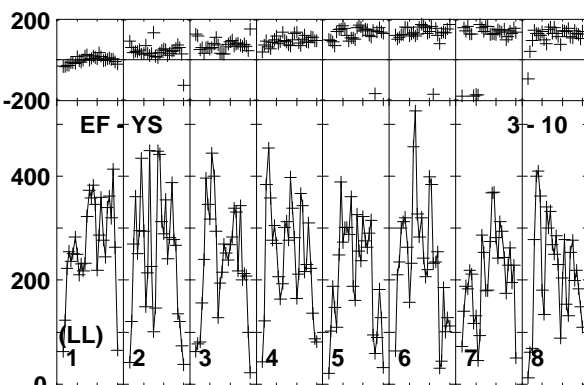
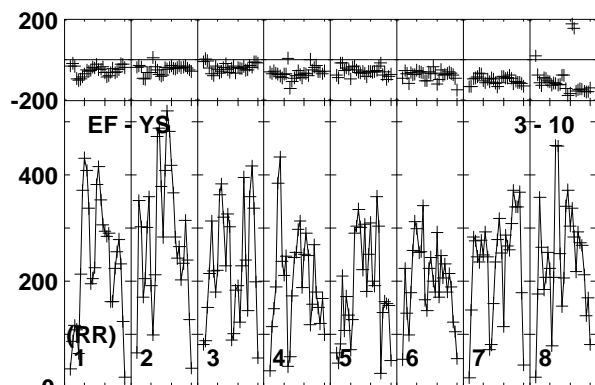
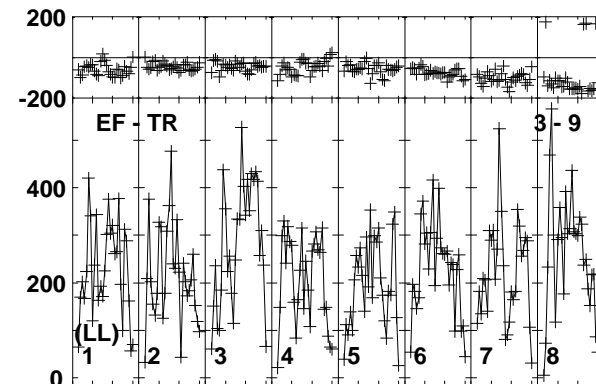
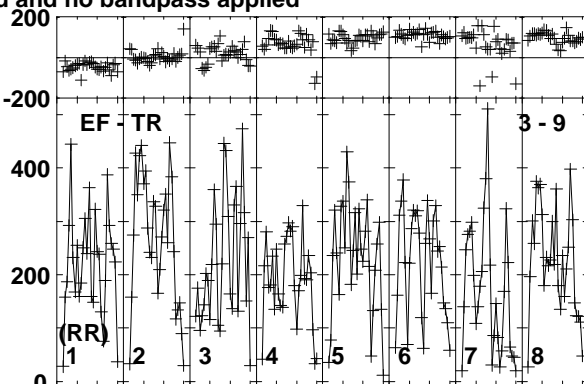
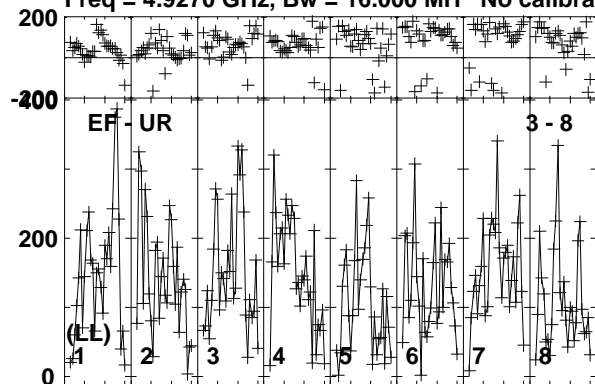

Lower frame: Micro Ampl Jy Top frame: Phas deg  
Vector averaged cross-power spectrum Baseline: EF (03) - UR (08)  
Timerange: 00/08:55:01 to 00/08:56:59

Plot file version 87 created 19-DEC-2018 17:58:18

VLA1 RY007C.UVDATA.1

Freq = 4.9270 GHz, Bw = 16.000 MH No calibration applied and no bandpass applied

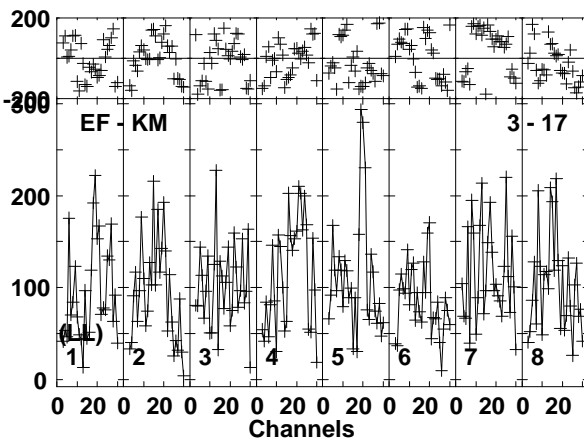
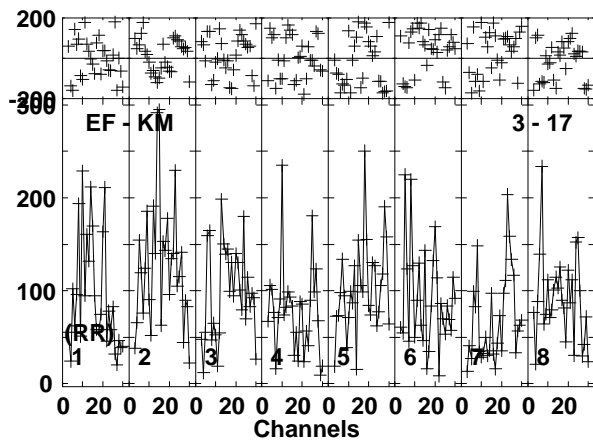
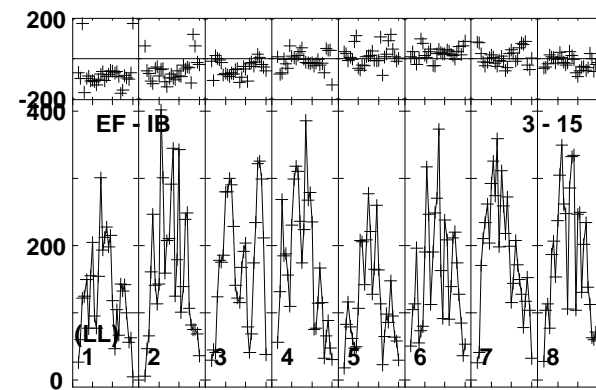
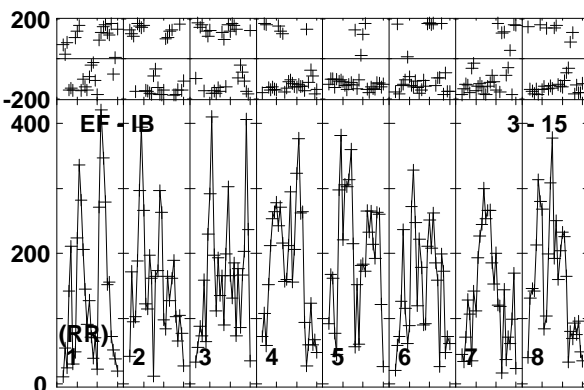
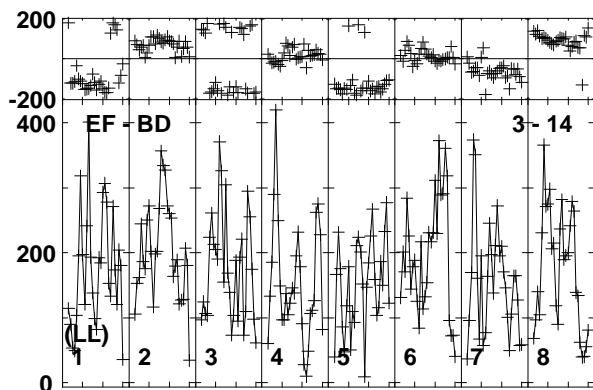
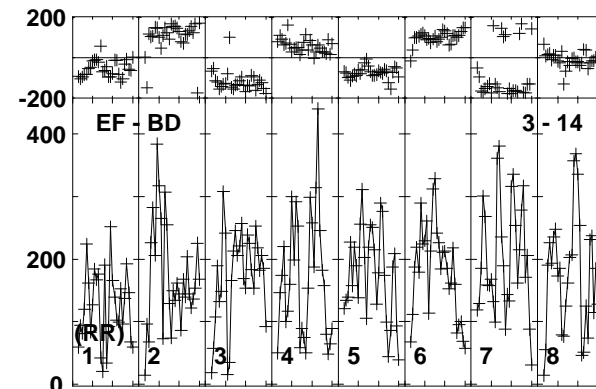
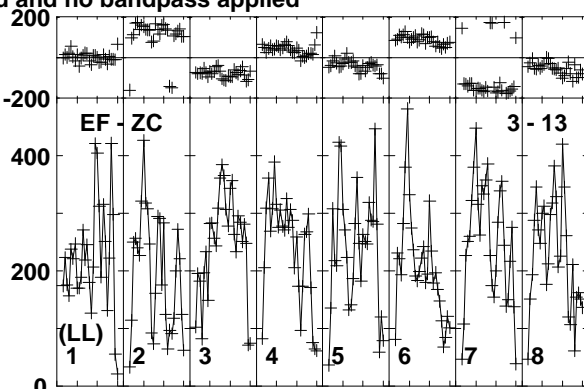
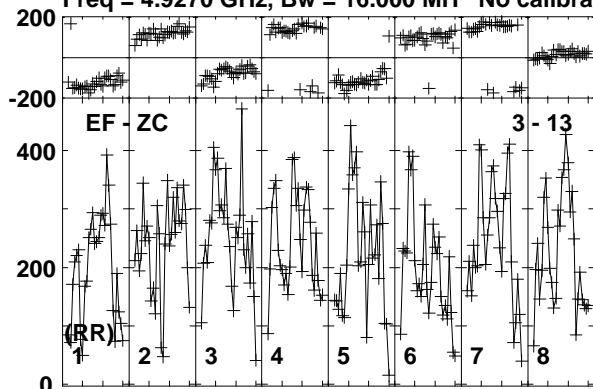

Lower frame: Micro Ampl Jy Top frame: Phas deg  
Vector averaged cross-power spectrum Baseline: EF (03) - ZC (13)  
Timerange: 00/08:55:01 to 00/08:56:59

Plot file version 88 created 19-DEC-2018 17:58:18

J1619+2247 RY007C.UVDATA.1

Freq = 4.9270 GHz, Bw = 16.000 MH No calibration applied and no bandpass applied

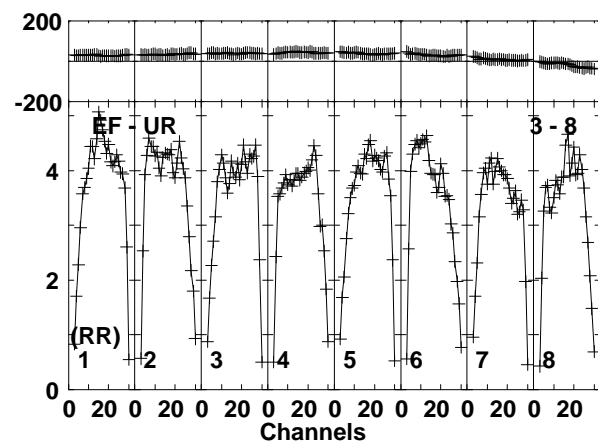
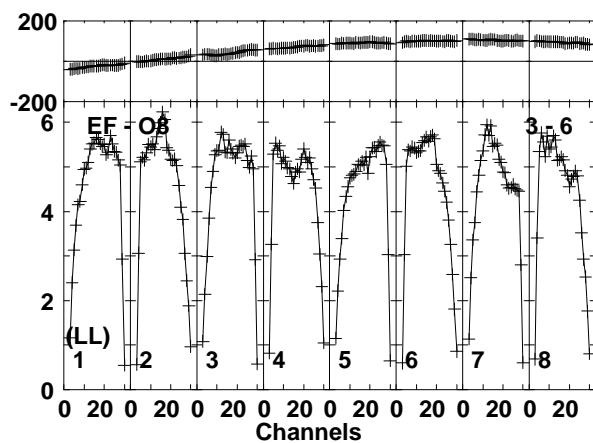
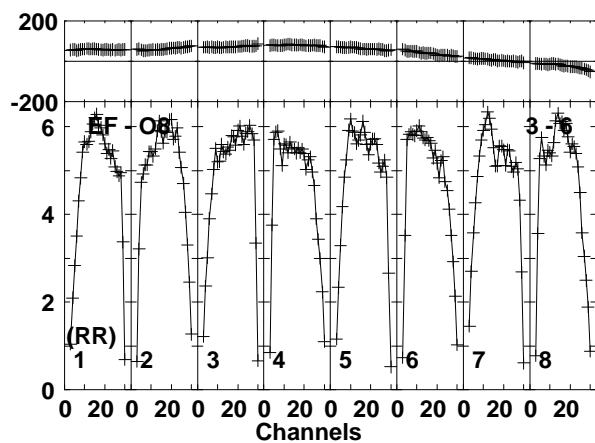
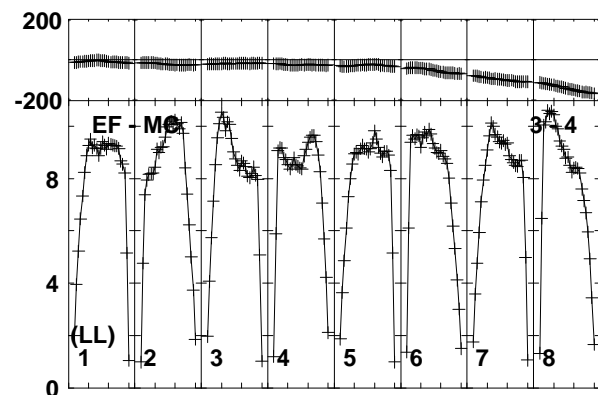
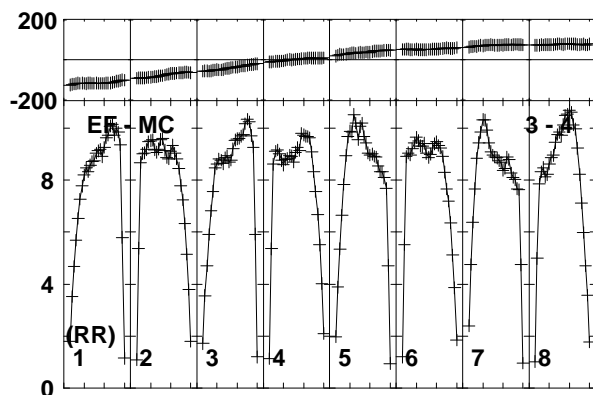
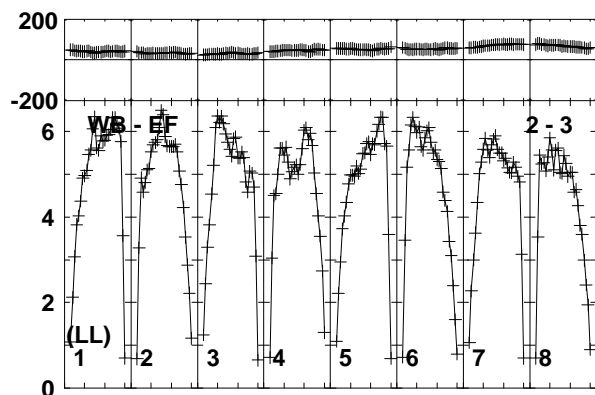
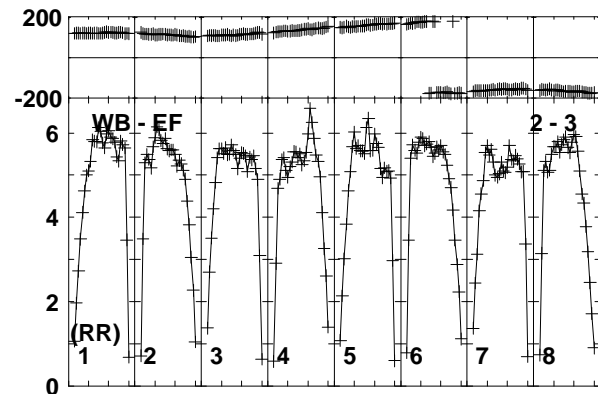
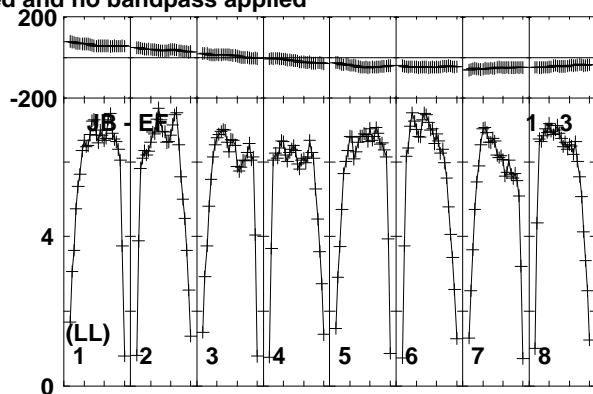
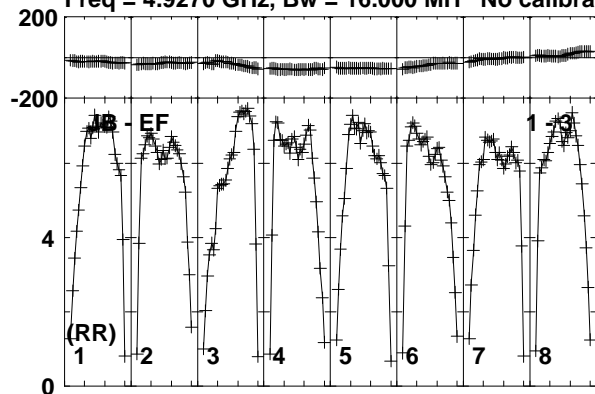

Lower frame: Milli Ampl Jy Top frame: Phas deg  
Vector averaged cross-power spectrum Baseline: JB (01) - EF (03)  
Timerange: 00/08:57:01 to 00/08:57:59

Plot file version 89 created 19-DEC-2018 17:58:18

J1619+2247 RY007C.UVDATA.1

Freq = 4.9270 GHz, Bw = 16.000 MH No calibration applied and no bandpass applied

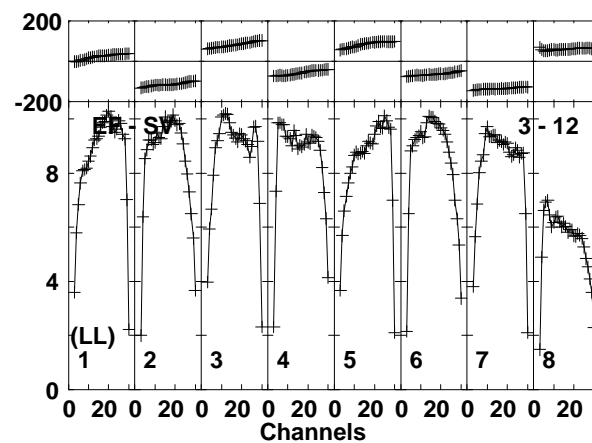
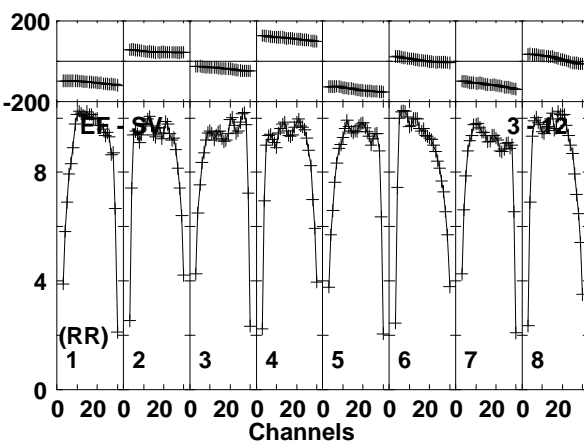
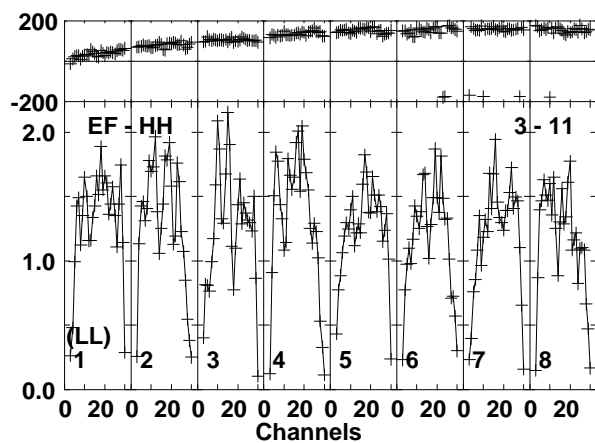
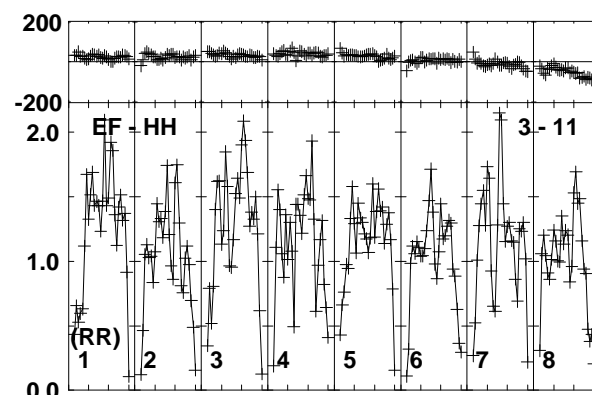
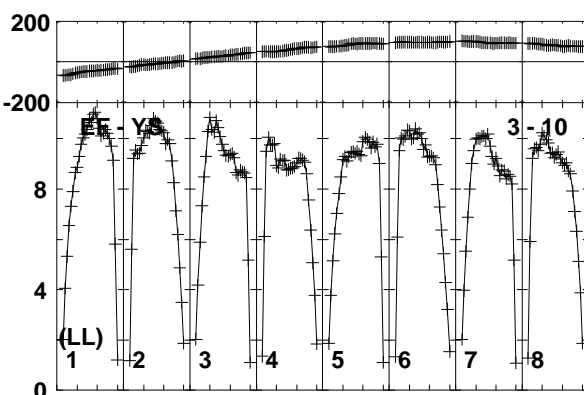
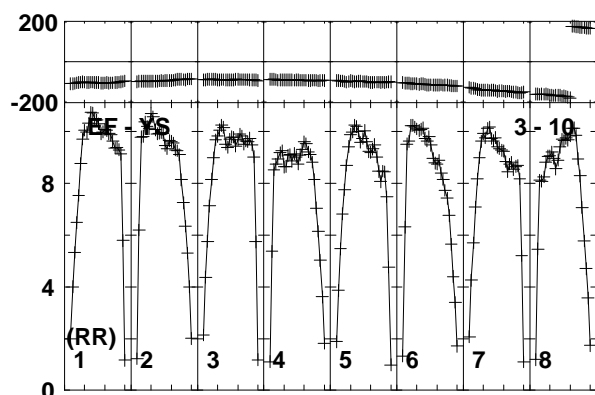
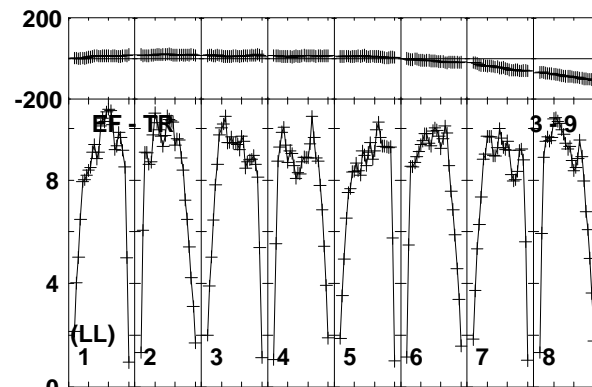
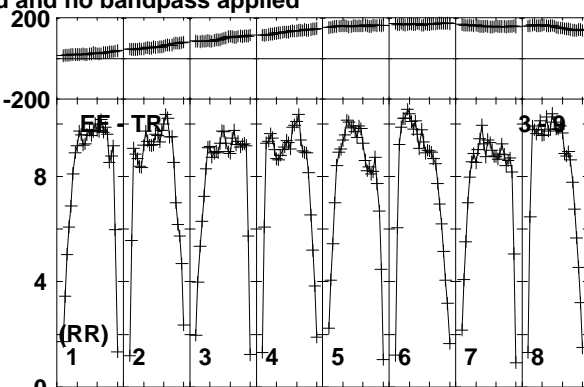
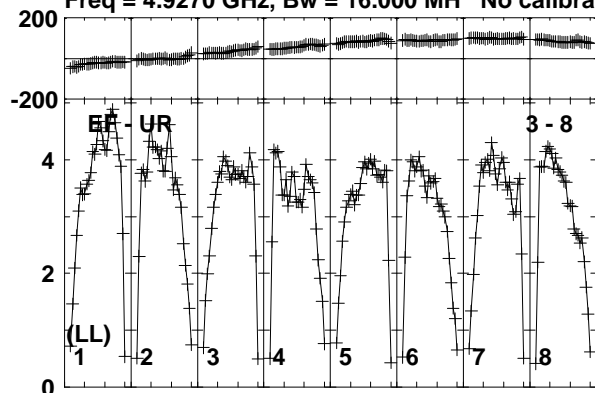

Lower frame: Milli Ampl Jy Top frame: Phas deg  
Vector averaged cross-power spectrum Baseline: EF (03) - UR (08)  
Timerange: 00/08:57:01 to 00/08:57:59

Plot file version 90 created 19-DEC-2018 17:58:18

J1619+2247 RY007C.UVDATA.1

Freq = 4.9270 GHz, Bw = 16.000 MH No calibration applied and no bandpass applied

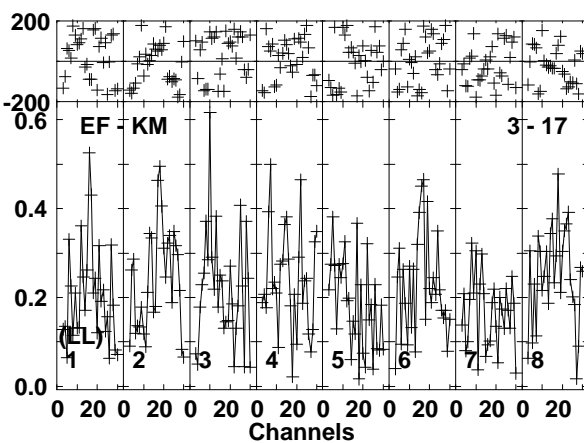
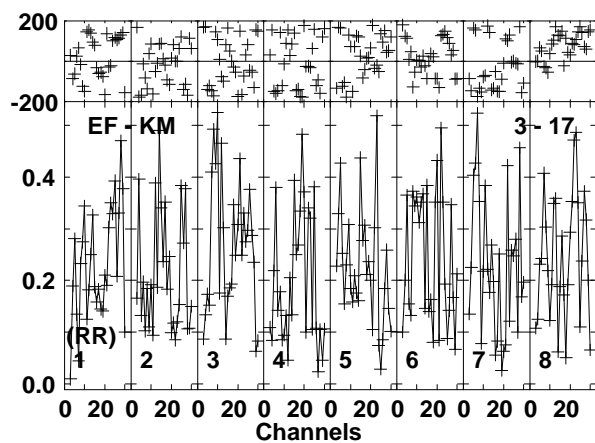
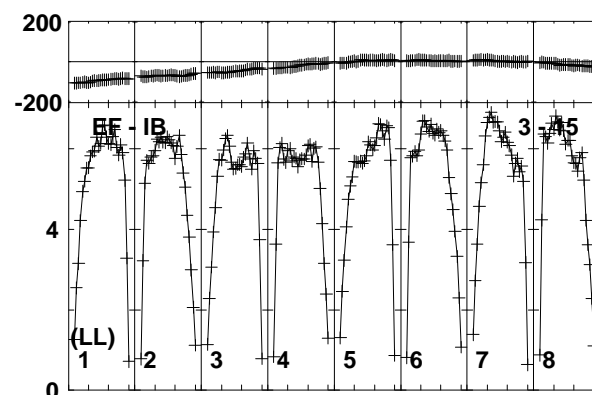
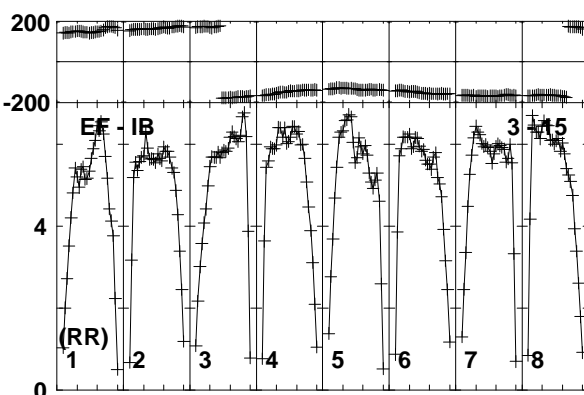
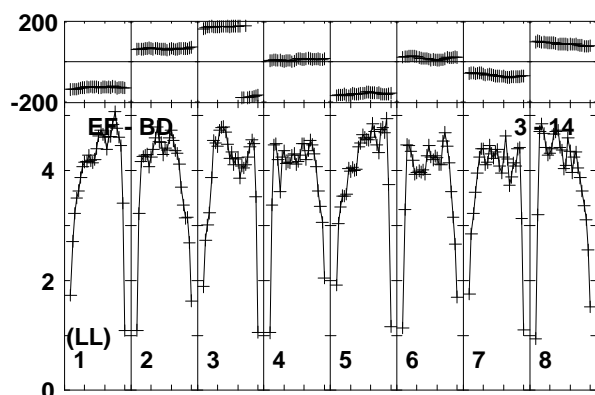
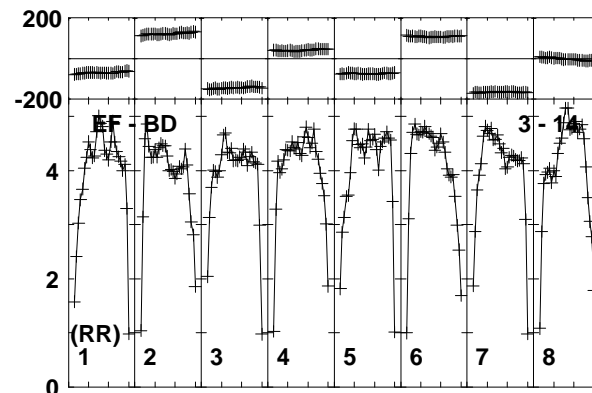
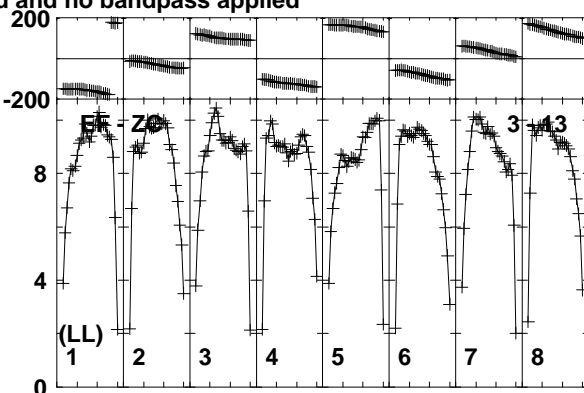
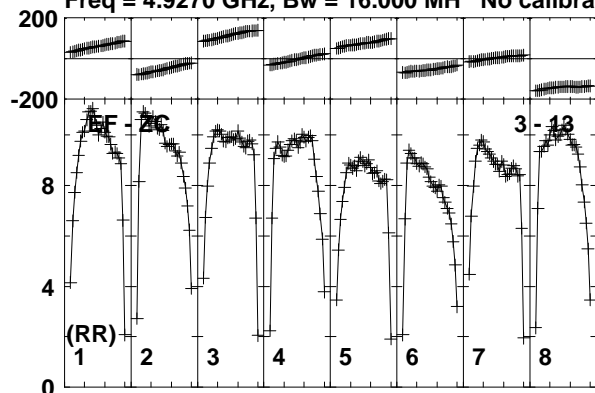

Lower frame: Milli Ampl Jy Top frame: Phas deg  
Vector averaged cross-power spectrum Baseline: EF (03) - ZC (13)  
Timerange: 00/08:57:01 to 00/08:57:59



Plot file version 91 created 19-DEC-2018 17:58:18

AT2018\_RY007C.UVDATA.1

Freq = 4.9270 GHz, Bw = 16.000 MH No calibration applied and no bandpass applied

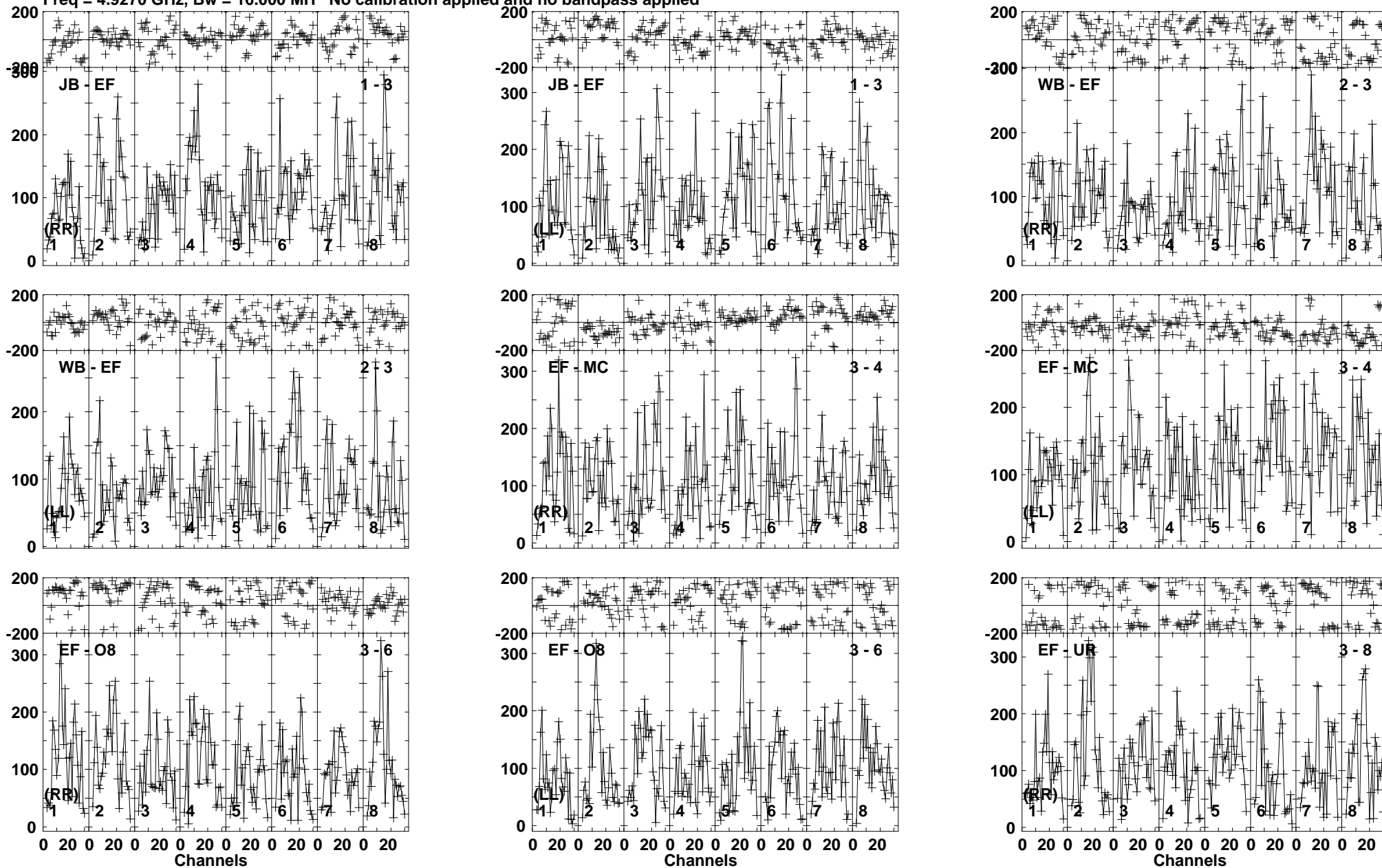

Lower frame: Micro Ampl Jy Top frame: Phas deg  
Vector averaged cross-power spectrum Baseline: JB (01) - EF (03)  
Timerange: 00/08:58:01 to 00/09:00:59

Plot file version 92 created 19-DEC-2018 17:58:19

AT2018\_RY007C.UVDATA.1

Freq = 4.9270 GHz, Bw = 16.000 MH No calibration applied and no bandpass applied

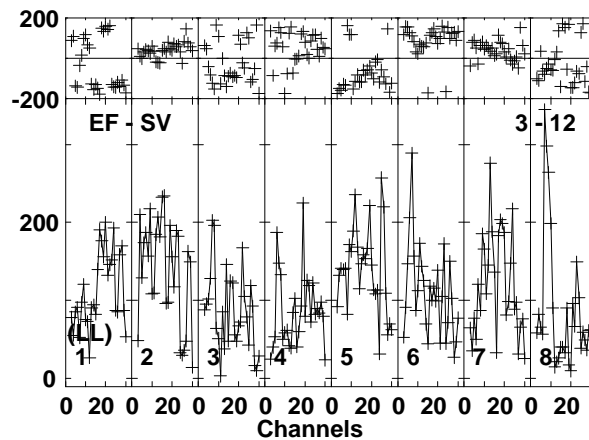
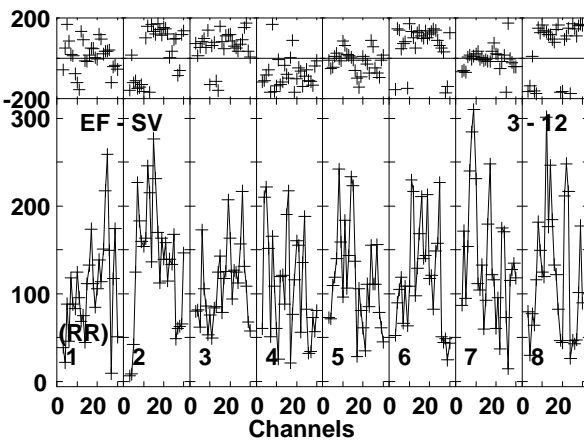
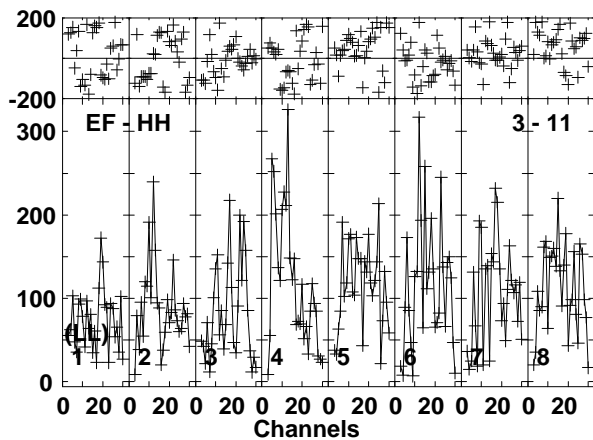
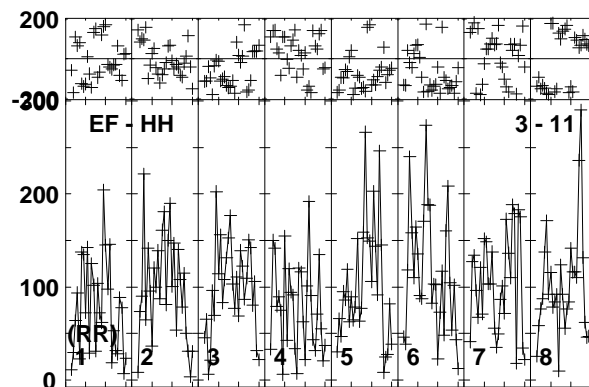
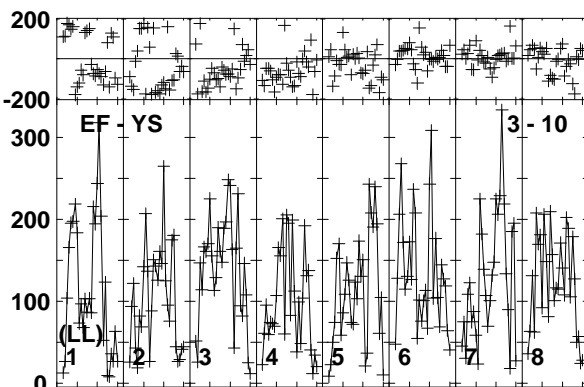
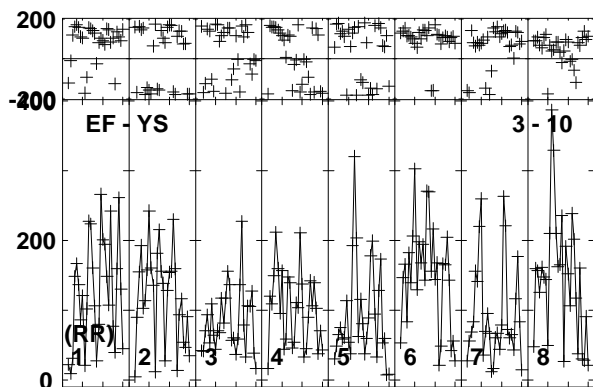
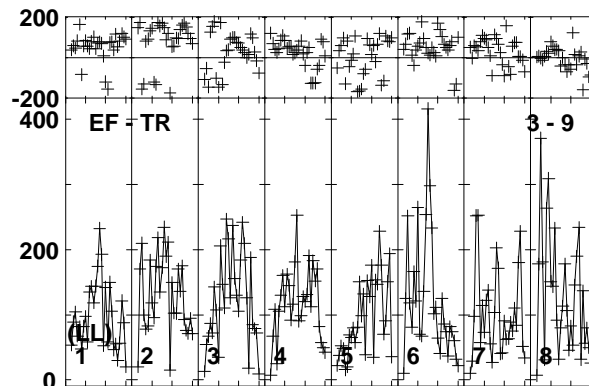
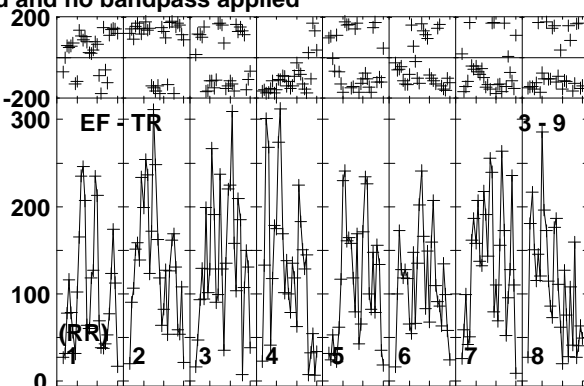
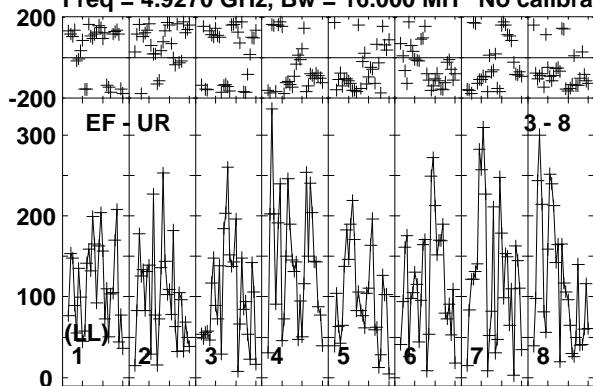

Lower frame: Micro Ampl Jy Top frame: Phas deg  
Vector averaged cross-power spectrum Baseline: EF (03) - UR (08)  
Timerange: 00/08:58:01 to 00/09:00:59

Plot file version 93 created 19-DEC-2018 17:58:19

AT2018\_RY007C.UVDATA.1

Freq = 4.9270 GHz, Bw = 16.000 MH No calibration applied and no bandpass applied

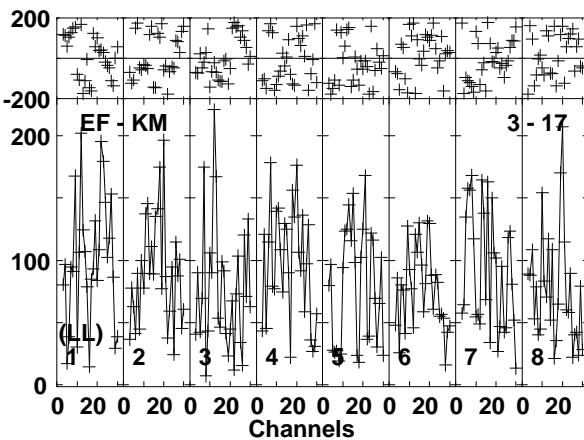
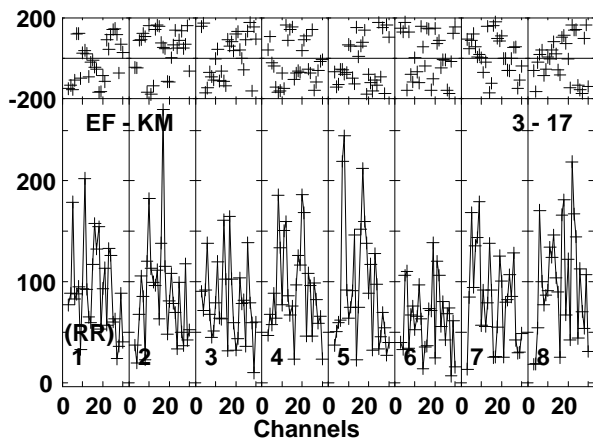
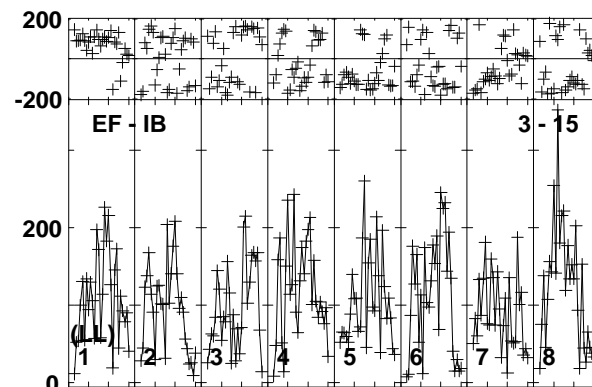
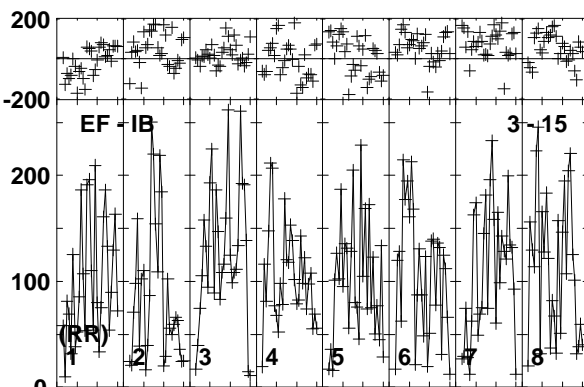
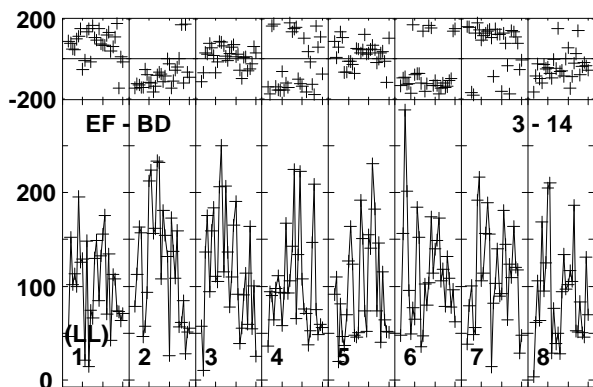
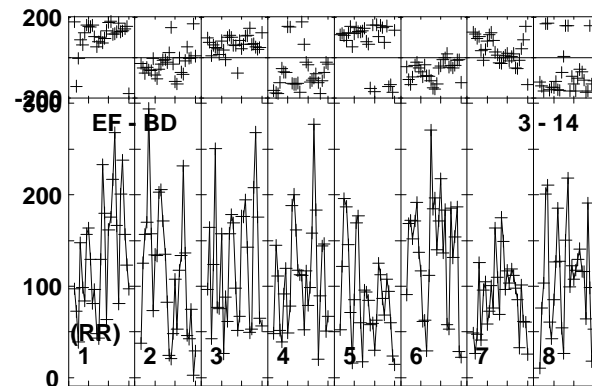
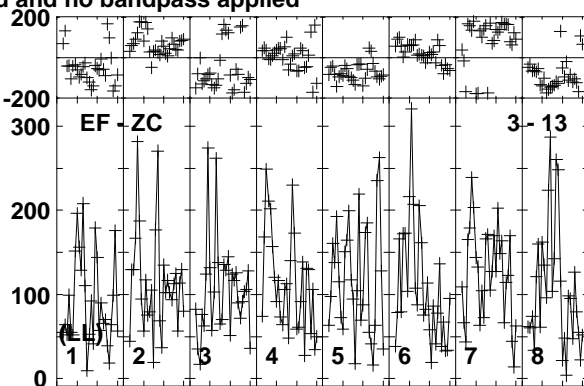
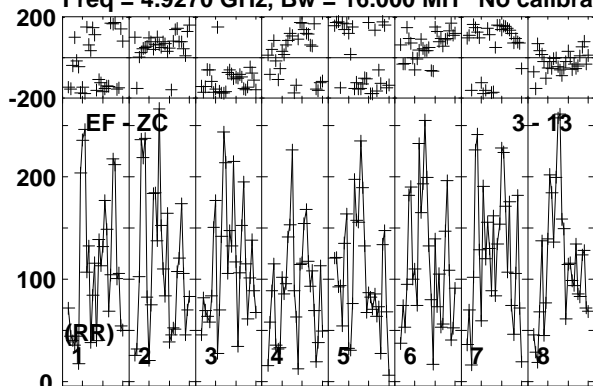

Lower frame: Micro Ampl Jy Top frame: Phas deg  
Vector averaged cross-power spectrum Baseline: EF (03) - ZC (13)  
Timerange: 00/08:58:01 to 00/09:00:59

Plot file version 94 created 19-DEC-2018 17:58:19

J1619+2247 RY007C.UVDATA.1

Freq = 4.9270 GHz, Bw = 16.000 MH No calibration applied and no bandpass applied

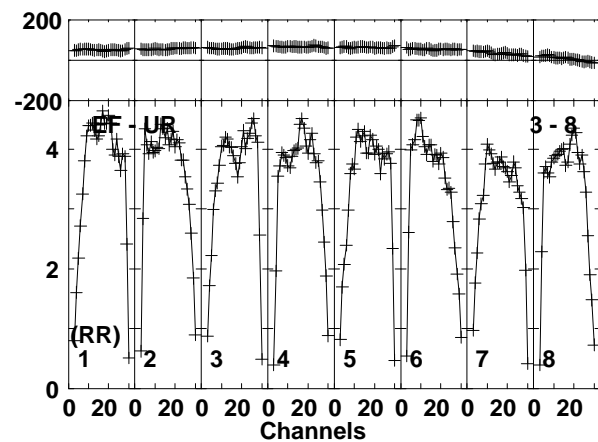
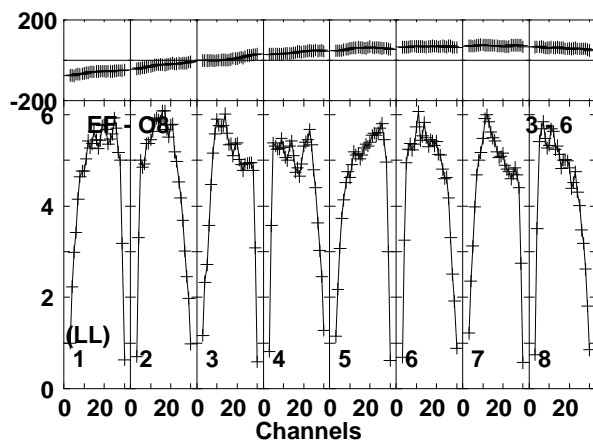
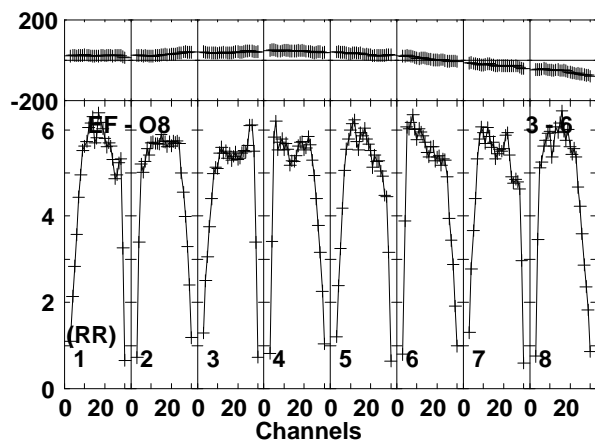
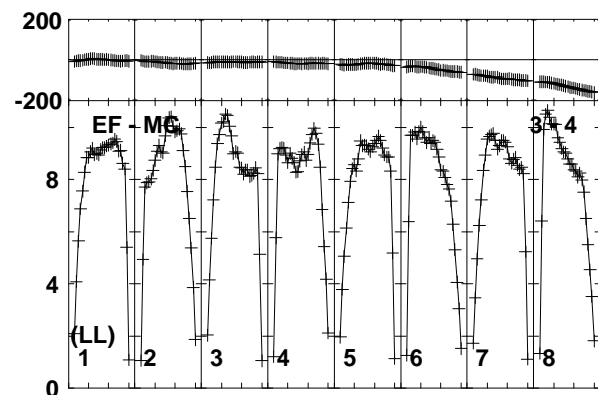
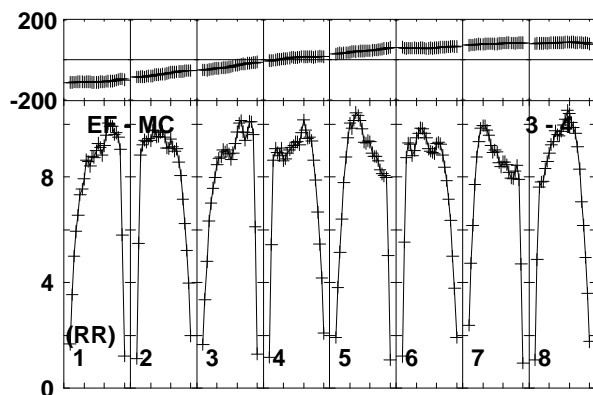
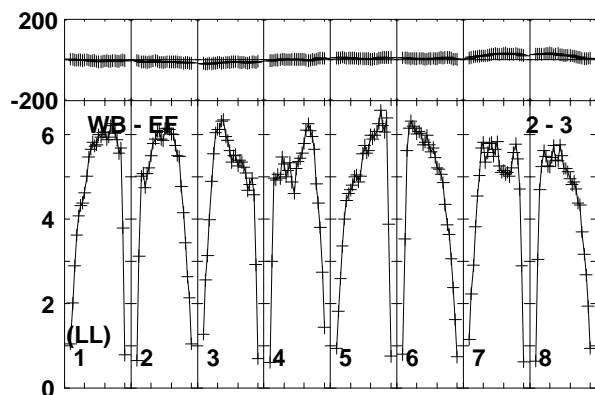
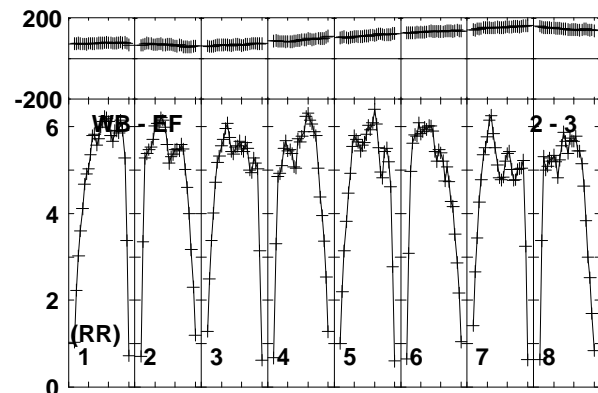
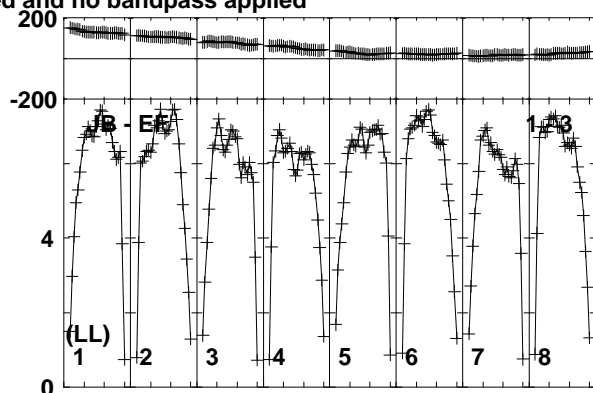
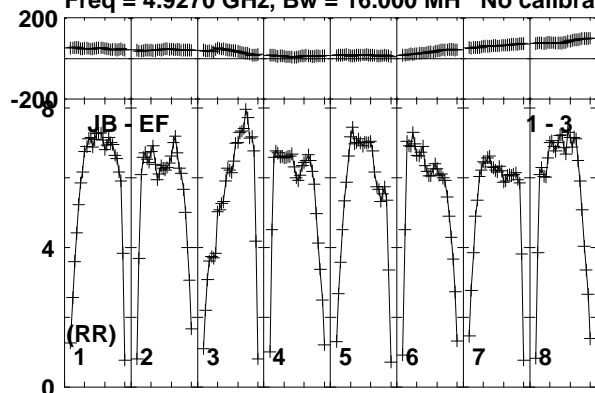

Lower frame: Milli Ampl Jy Top frame: Phas deg  
Vector averaged cross-power spectrum Baseline: JB (01) - EF (03)  
Timerange: 00/09:01:01 to 00/09:01:59

Plot file version 95 created 19-DEC-2018 17:58:19

J1619+2247 RY007C.UVDATA.1

Freq = 4.9270 GHz, Bw = 16.000 MH No calibration applied and no bandpass applied

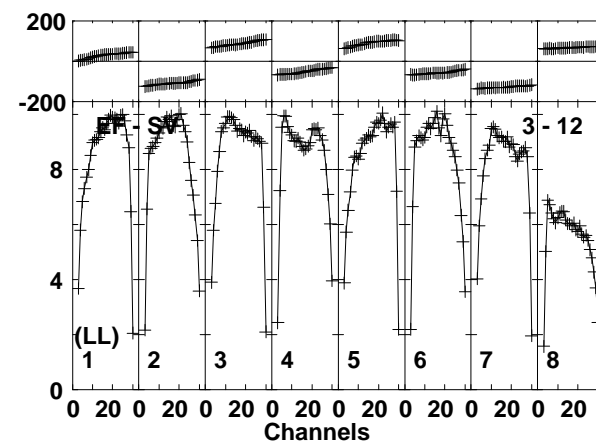
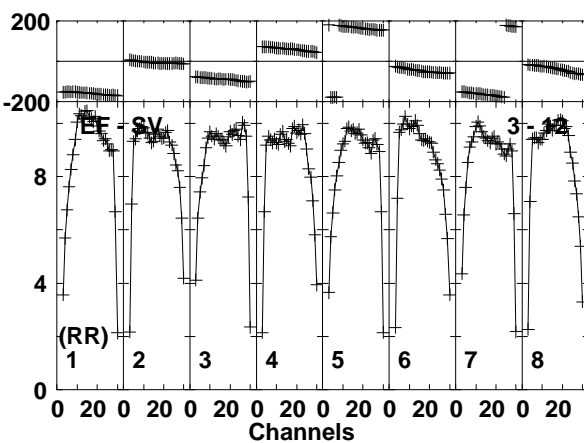
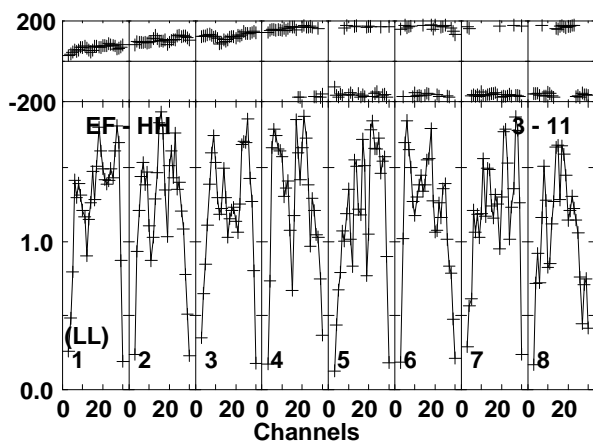
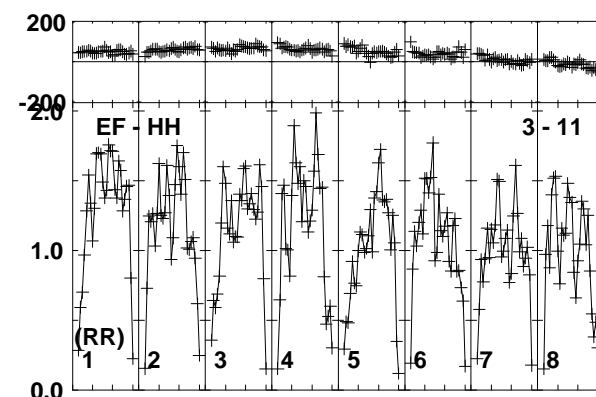
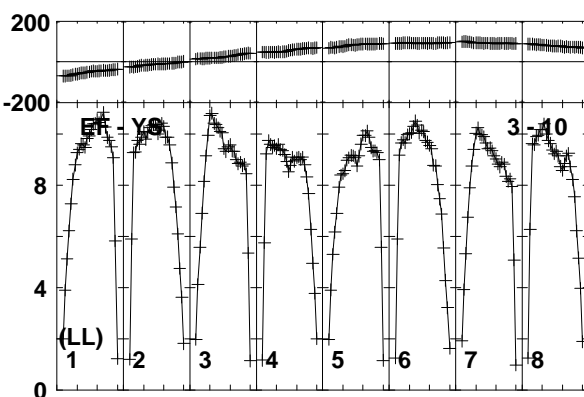
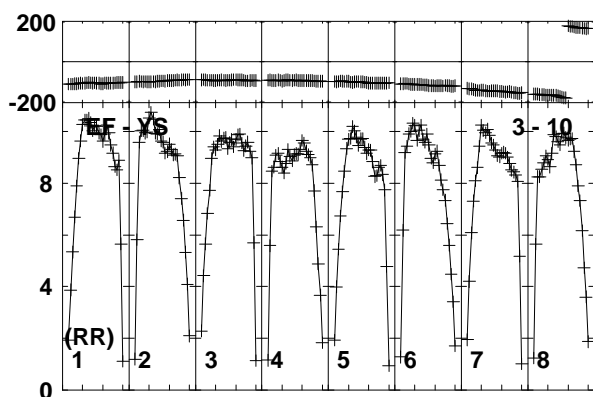
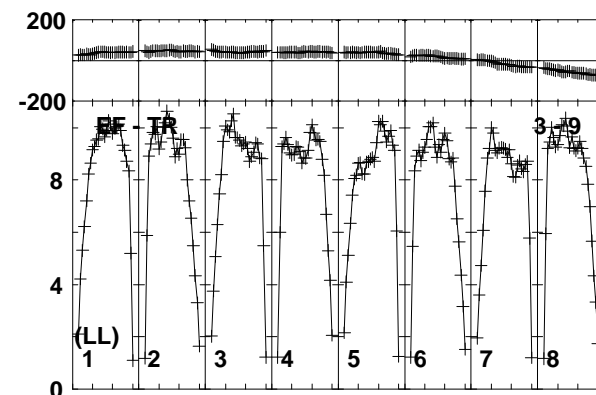
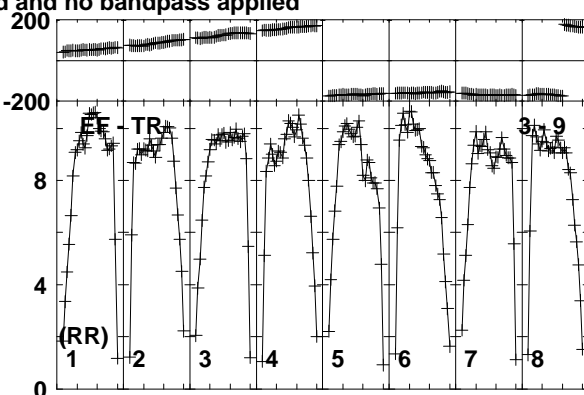
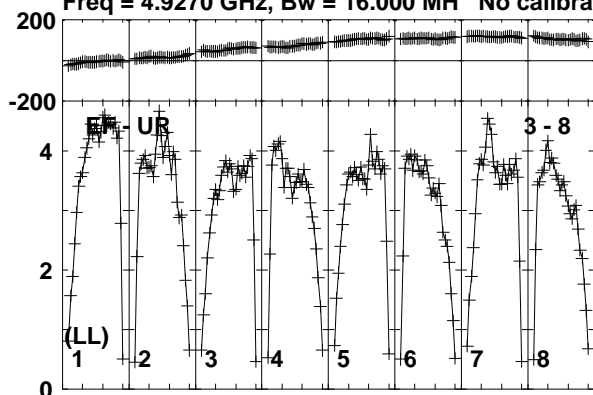

Lower frame: Milli Ampl Jy Top frame: Phas deg  
Vector averaged cross-power spectrum Baseline: EF (03) - UR (08)  
Timerange: 00/09:01:01 to 00/09:01:59

Plot file version 96 created 19-DEC-2018 17:58:19

J1619+2247 RY007C.UVDATA.1

Freq = 4.9270 GHz, Bw = 16.000 MH No calibration applied and no bandpass applied

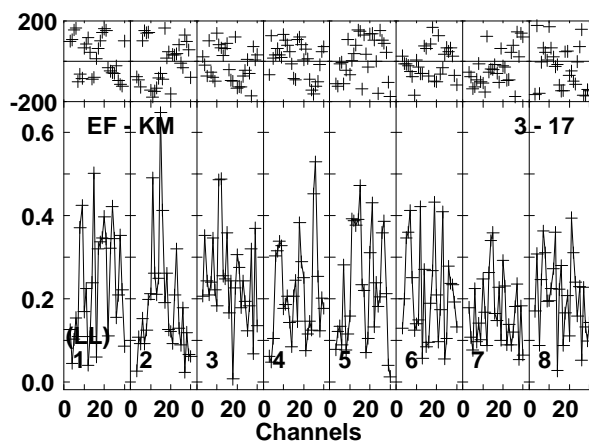
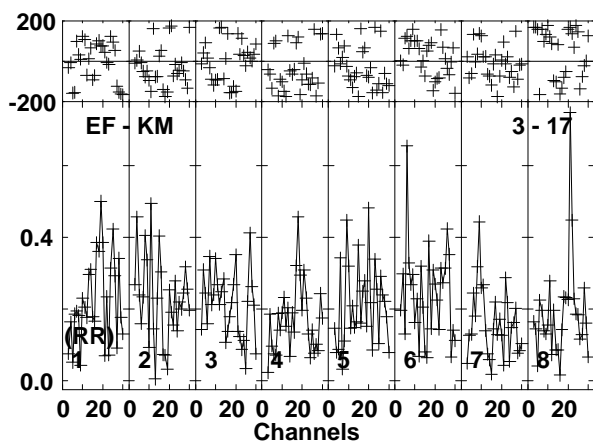
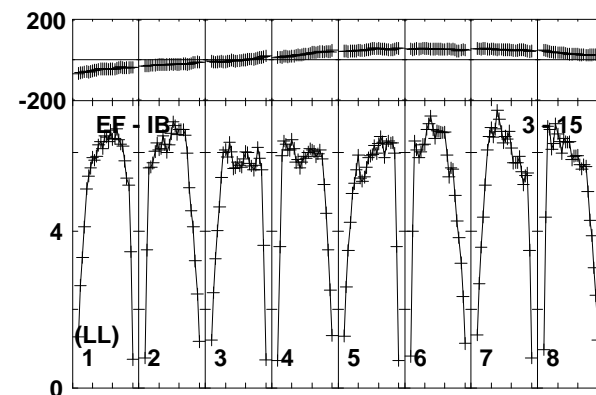
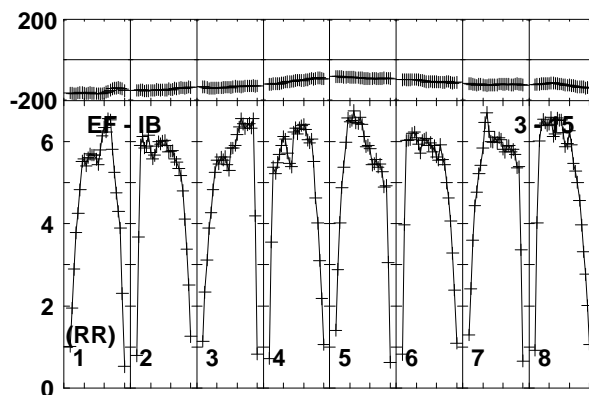
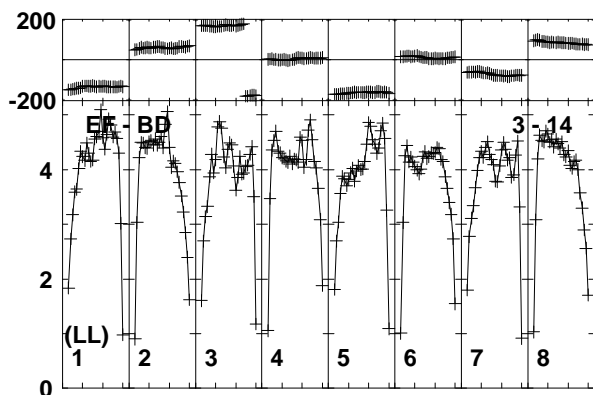
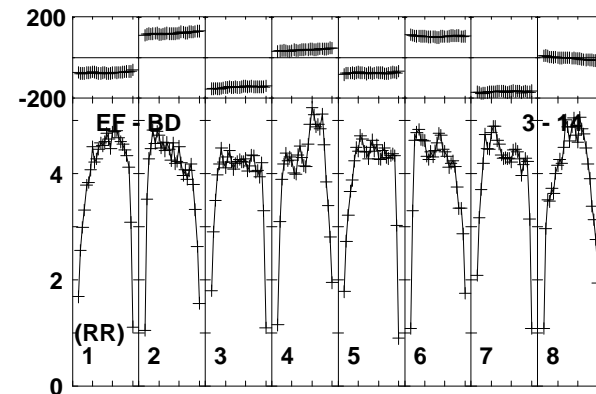
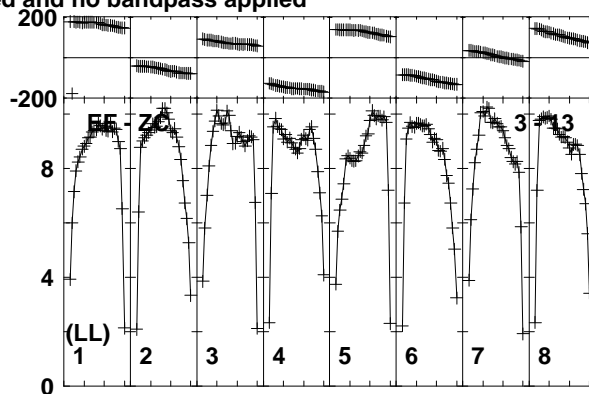
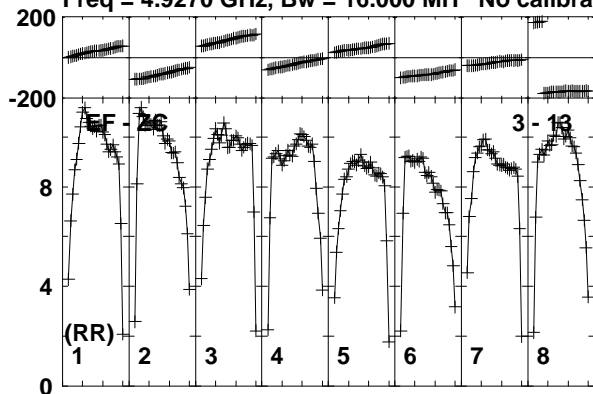

Lower frame: Milli Ampl Jy Top frame: Phas deg  
Vector averaged cross-power spectrum Baseline: EF (03) - ZC (13)  
Timerange: 00/09:01:01 to 00/09:01:59

Plot file version 97 created 19-DEC-2018 17:58:19

AT2018\_RY007C.UVDATA.1

Freq = 4.9270 GHz, Bw = 16.000 MH No calibration applied and no bandpass applied

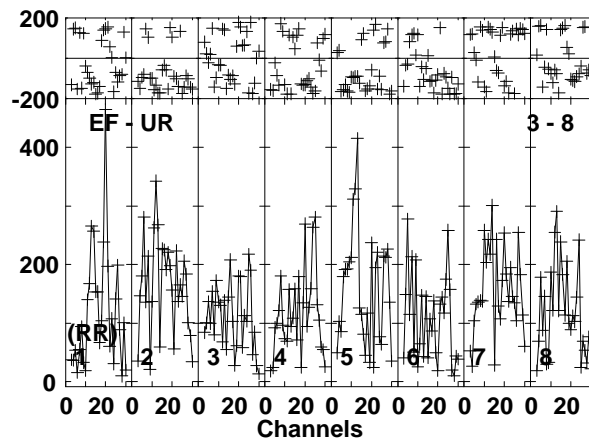
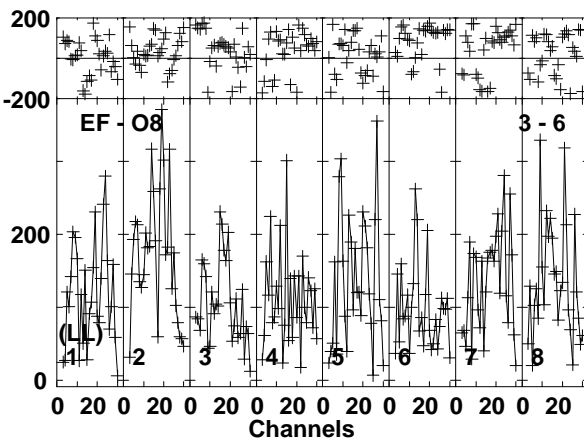
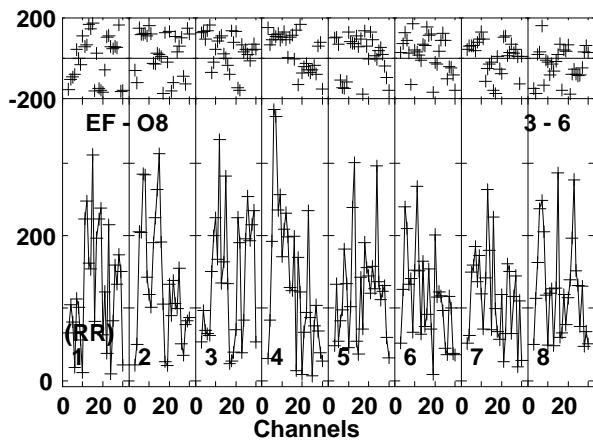
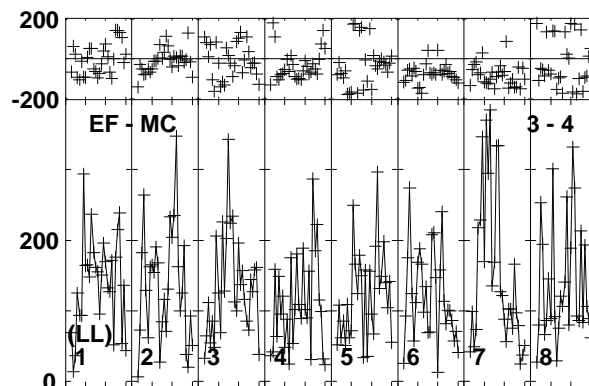
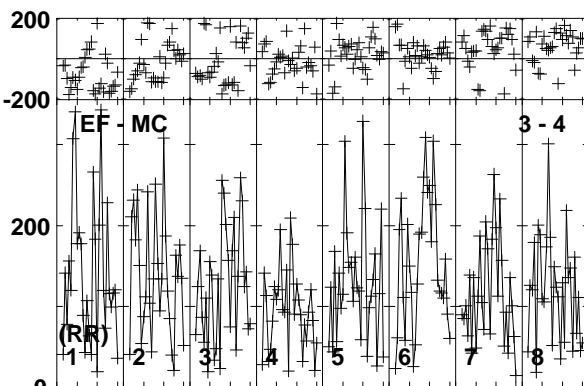
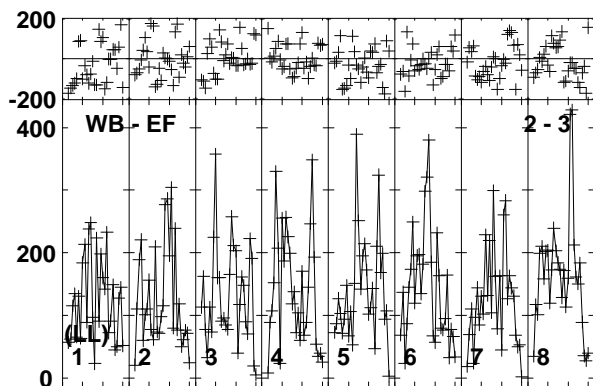
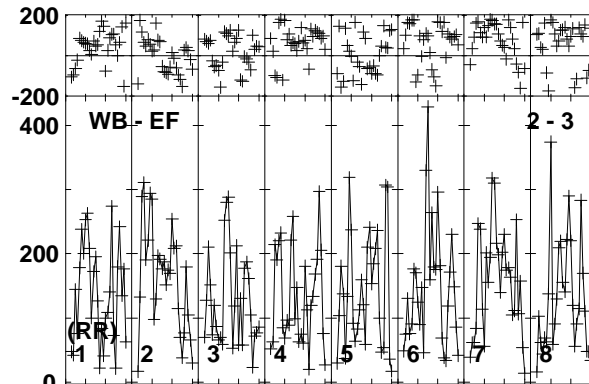
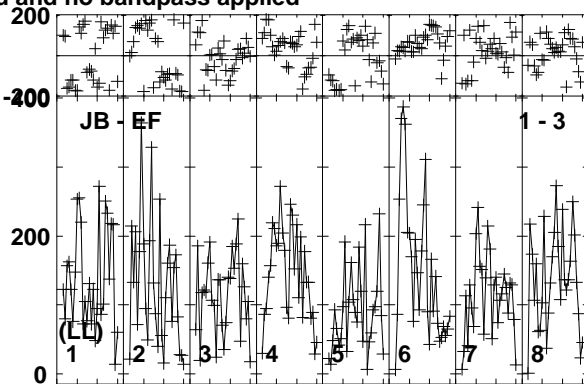
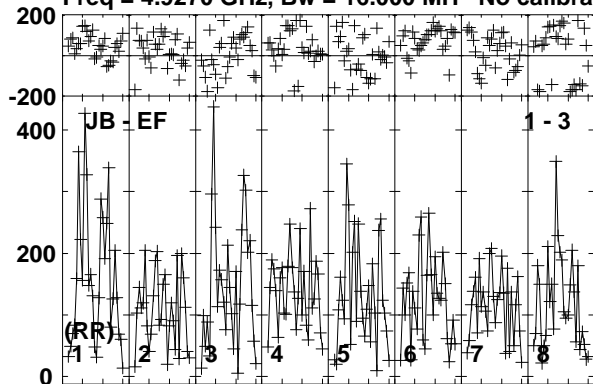

Lower frame: Micro Ampl Jy Top frame: Phas deg  
Vector averaged cross-power spectrum Baseline: JB (01) - EF (03)  
Timerange: 00/09:02:01 to 00/09:03:59

Plot file version 98 created 19-DEC-2018 17:58:19

AT2018\_RY007C.UVDATA.1

Freq = 4.9270 GHz, Bw = 16.000 MH No calibration applied and no bandpass applied

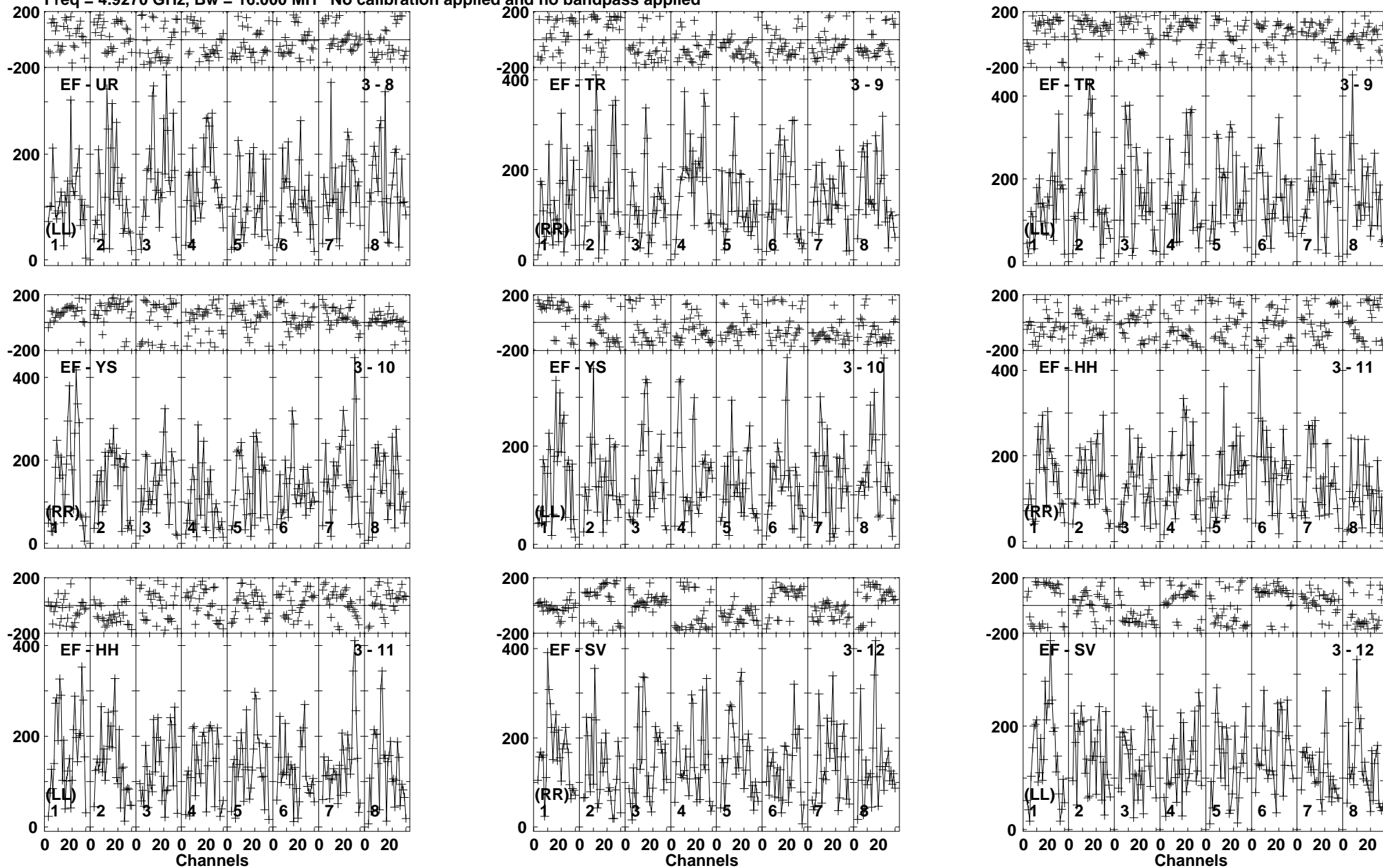

Lower frame: Micro Ampl Jy Top frame: Phas deg  
Vector averaged cross-power spectrum Baseline: EF (03) - UR (08)  
Timerange: 00/09:02:01 to 00/09:03:59



Plot file version 99 created 19-DEC-2018 17:58:19  
 AT2018\_RY007C.UVDATA.1  
 Freq = 4.9270 GHz, Bw = 16.000 MH No calibration applied and no bandpass applied

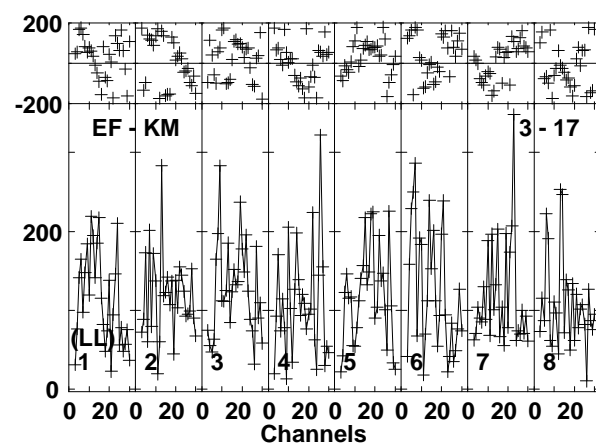
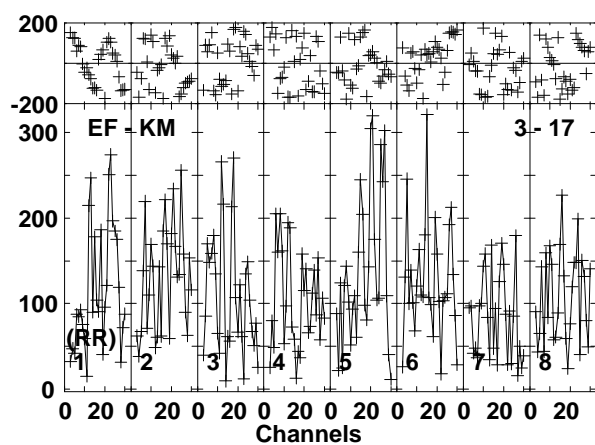
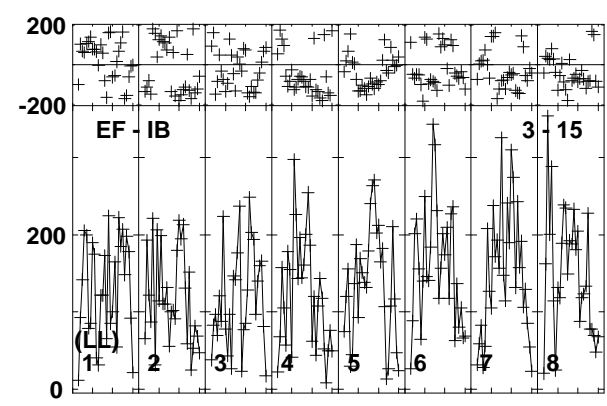
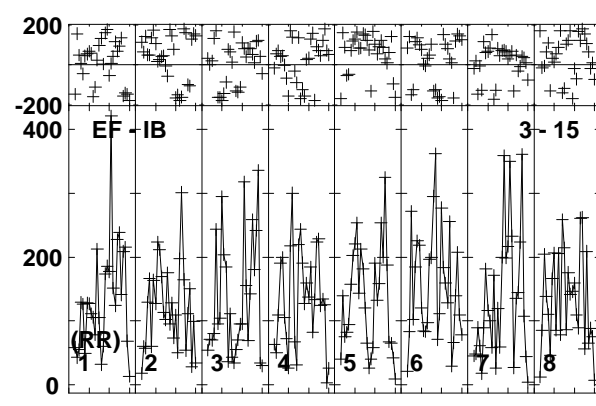
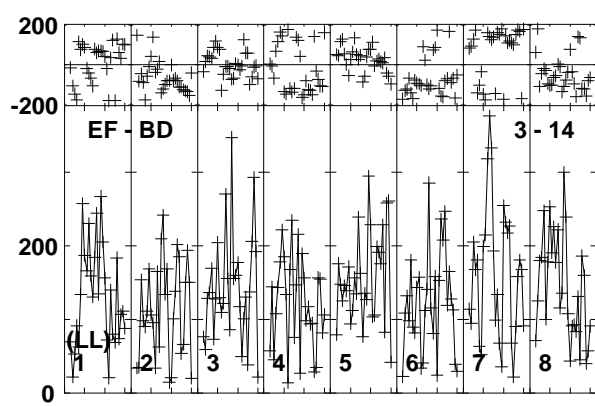
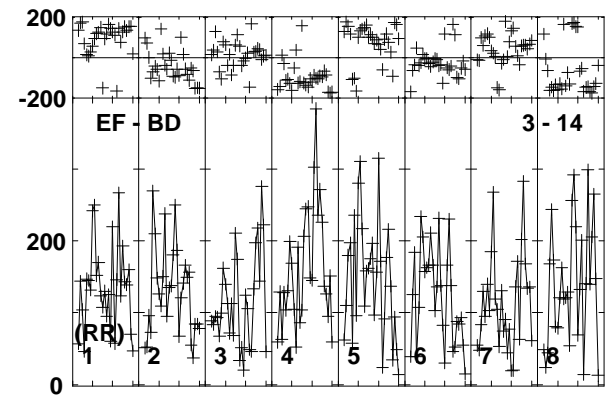
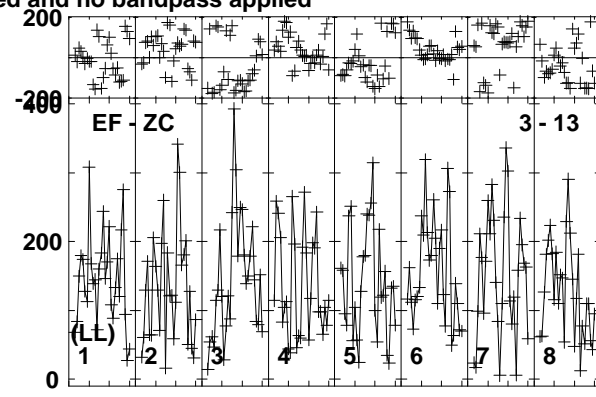
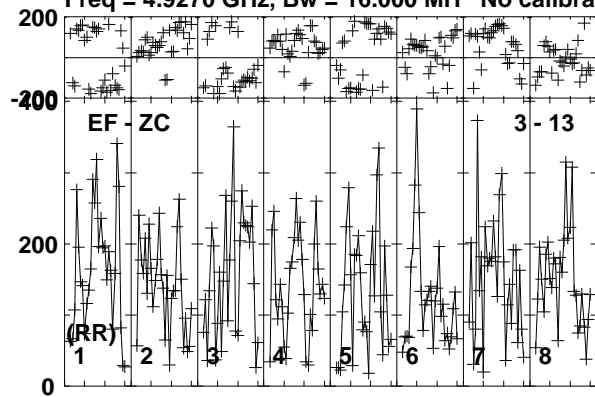

Lower frame: Micro Ampl Jy Top frame: Phas deg  
 Vector averaged cross-power spectrum Baseline: EF (03) - ZC (13)  
 Timerange: 00/09:02:01 to 00/09:03:59

Plot file version 100 created 19-DEC-2018 17:58:19

VLA2 RY007C.UVDATA.1

Freq = 4.9270 GHz, Bw = 16.000 MH No calibration applied and no bandpass applied

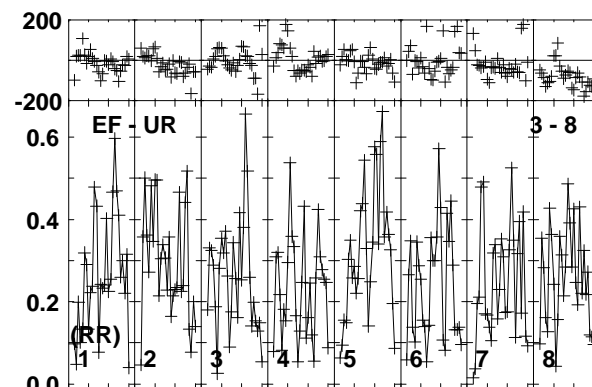
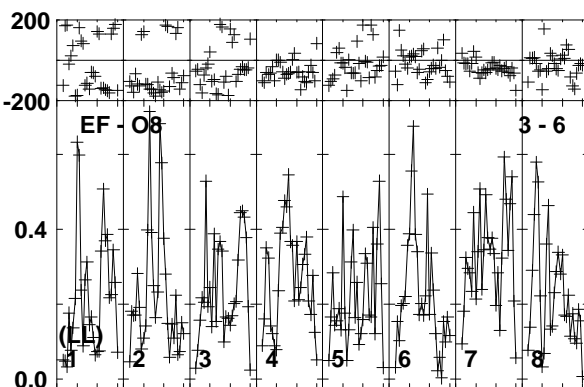
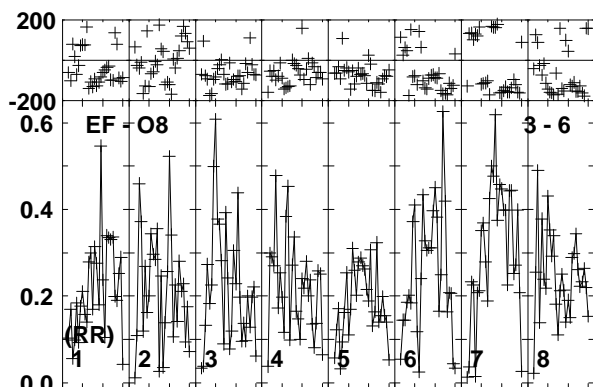
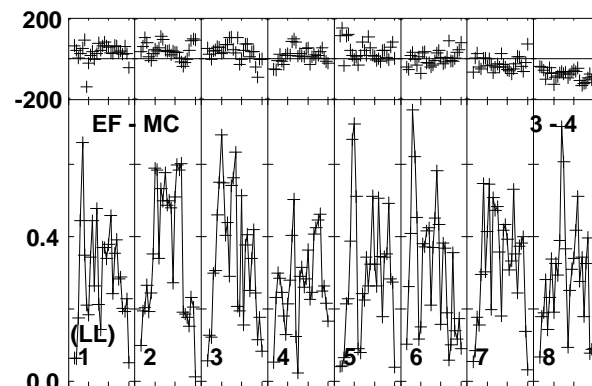
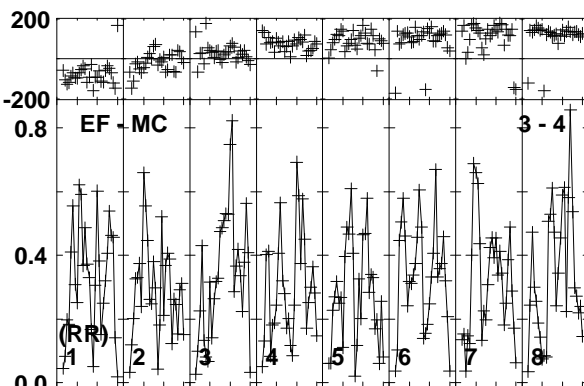
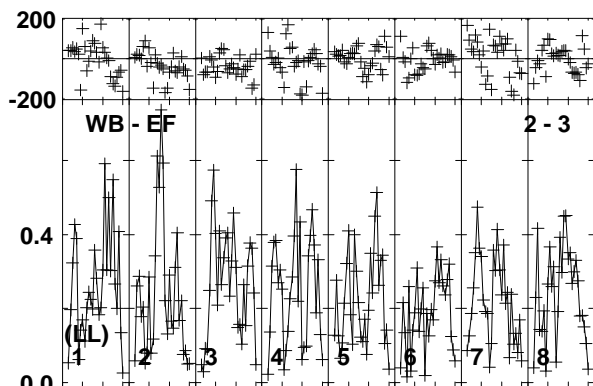
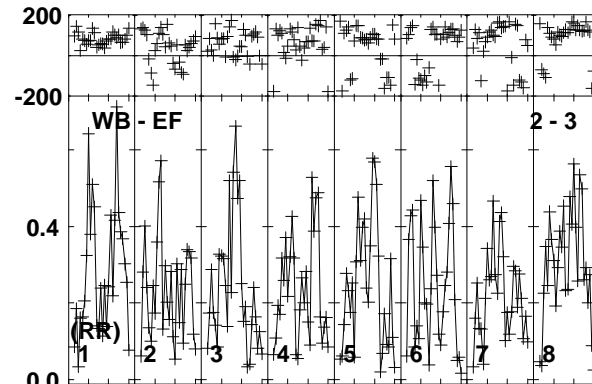
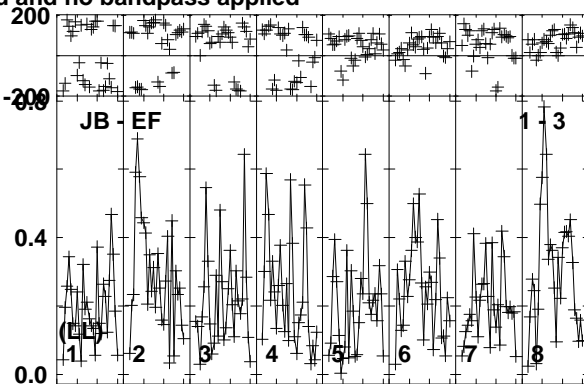
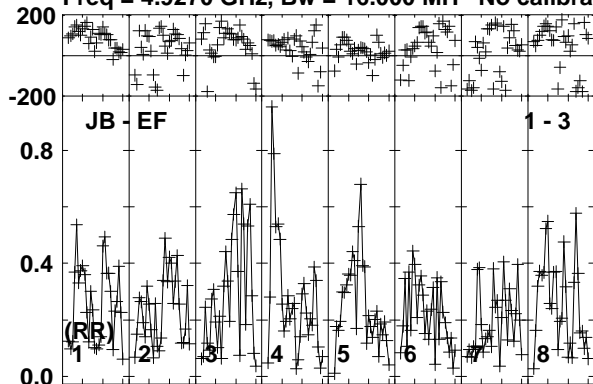

Lower frame: Milli Ampl Jy Top frame: Phas deg  
Vector averaged cross-power spectrum Baseline: JB (01) - EF (03)  
Timerange: 00/09:04:01 to 00/09:04:59

Plot file version 101 created 19-DEC-2018 17:58:19  
VLA2\_RY007C.UVDATA.1

Freq = 4.9270 GHz, Bw = 16.000 MH No calibration applied and no bandpass applied

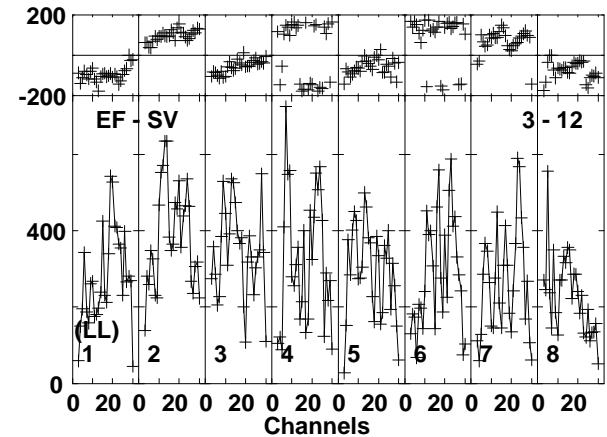
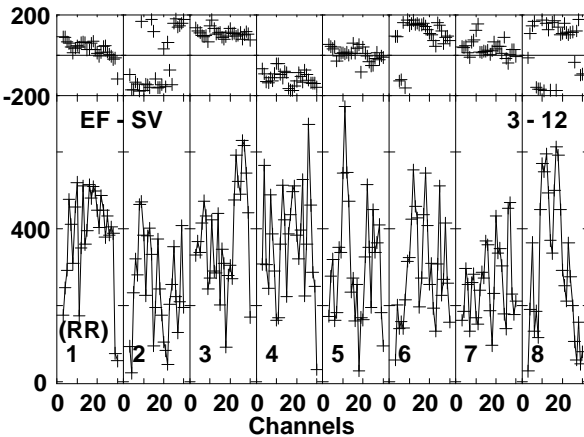
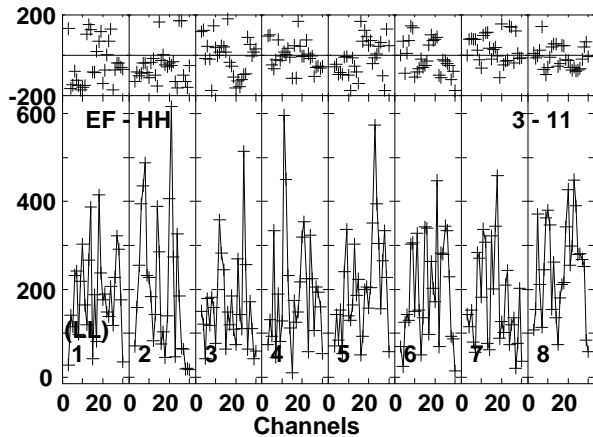
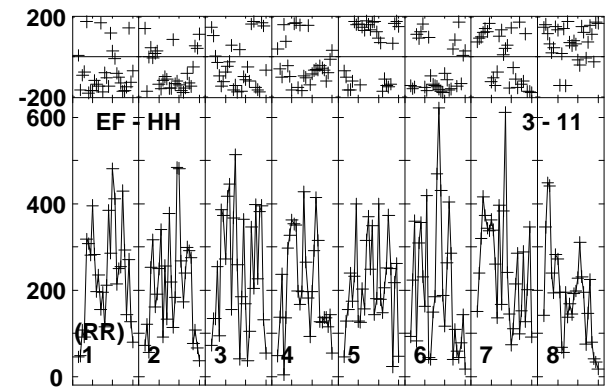
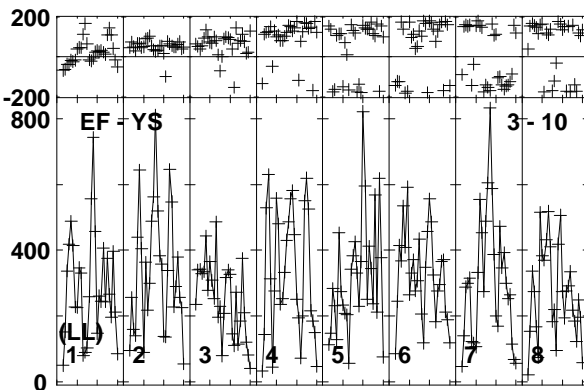
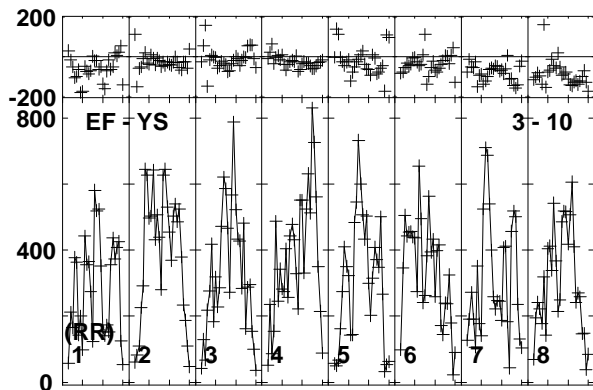
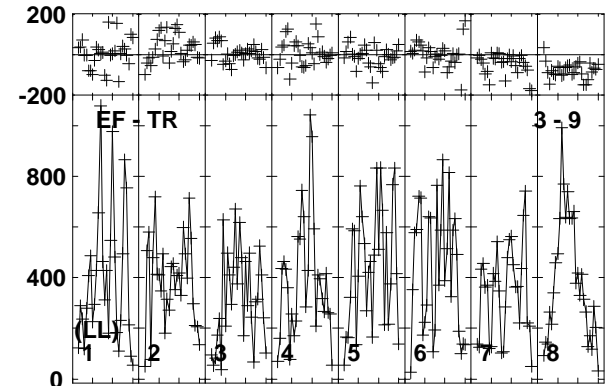
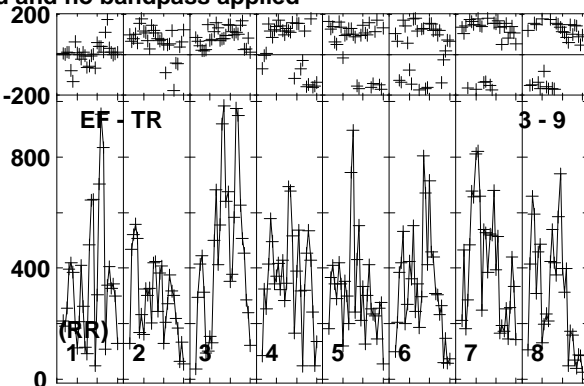
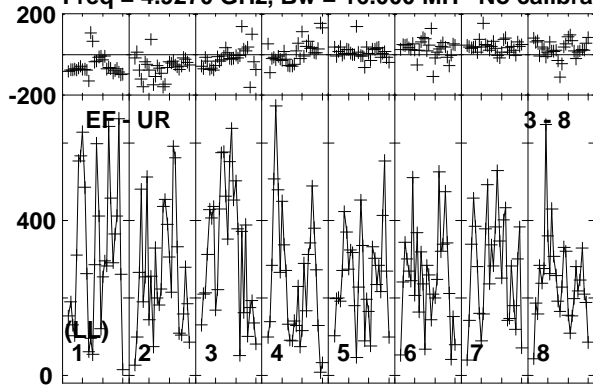

Lower frame: Micro Ampl Jy Top frame: Phas deg  
Vector averaged cross-power spectrum Baseline: EF (03) - UR (08)  
Timerange: 00/09:04:01 to 00/09:04:59

Plot file version 102 created 19-DEC-2018 17:58:19

VLA2 RY007C.UVDATA.1

Freq = 4.9270 GHz, Bw = 16.000 MH No calibration applied and no bandpass applied

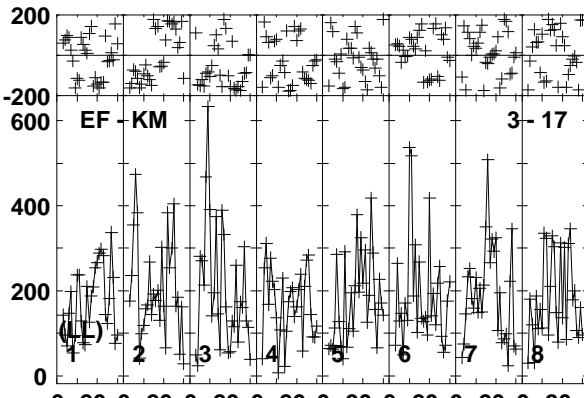
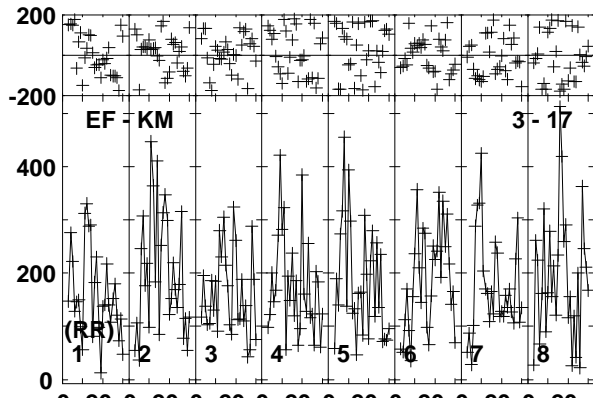
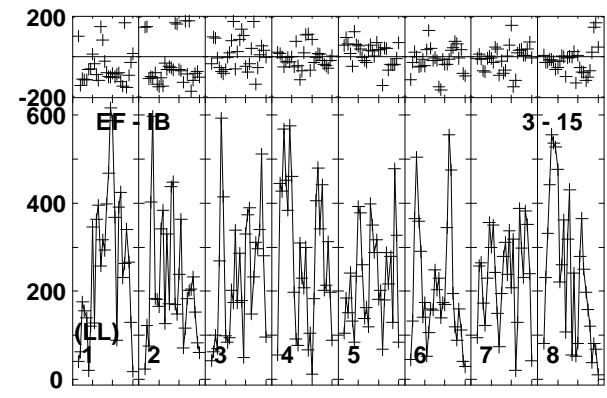
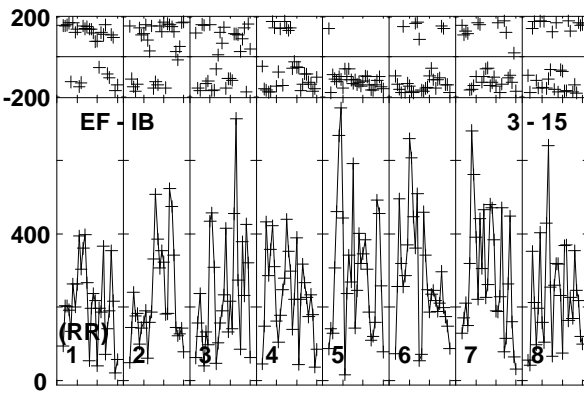
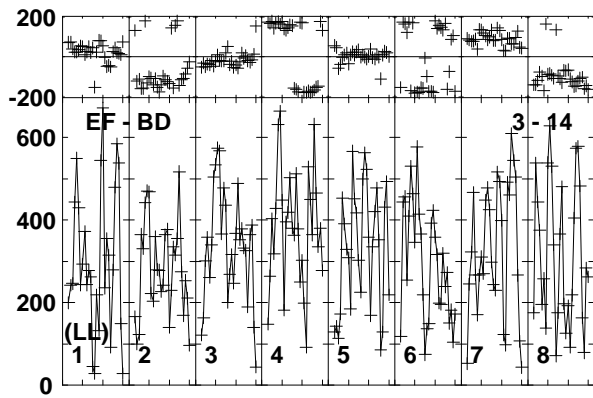
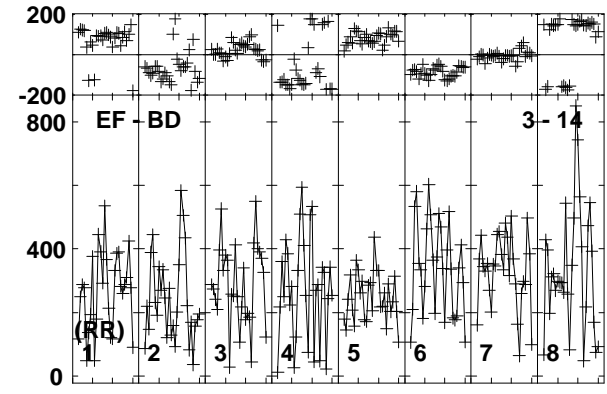
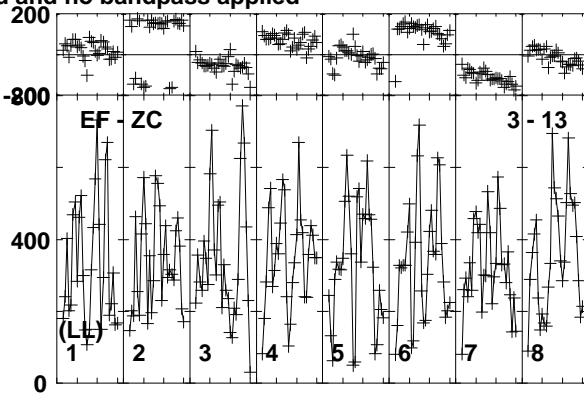
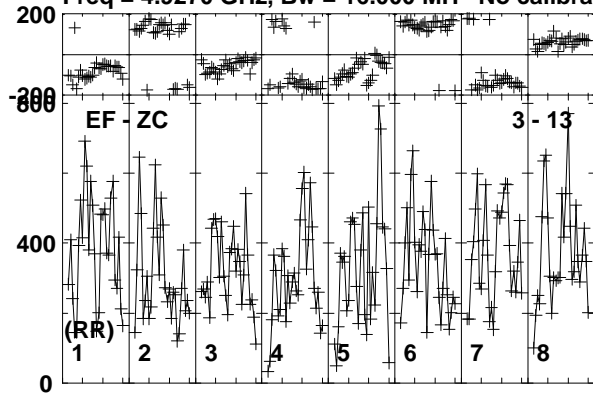

Lower frame: Micro Ampl Jy Top frame: Phas deg  
Vector averaged cross-power spectrum Baseline: EF (03) - ZC (13)  
Timerange: 00/09:04:01 to 00/09:04:59

Plot file version 103 created 19-DEC-2018 17:58:19

J1619+2247 RY007C.UVDATA.1

Freq = 4.9270 GHz, Bw = 16.000 MH No calibration applied and no bandpass applied

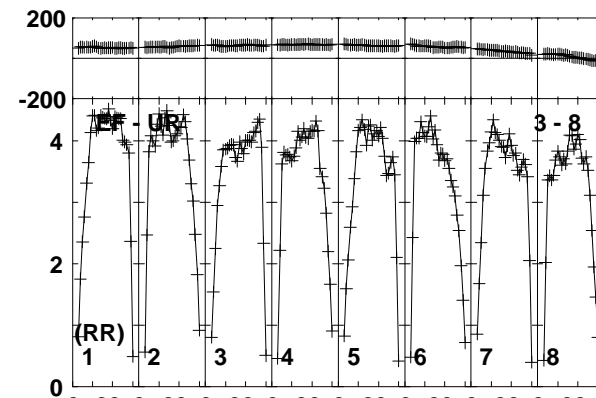
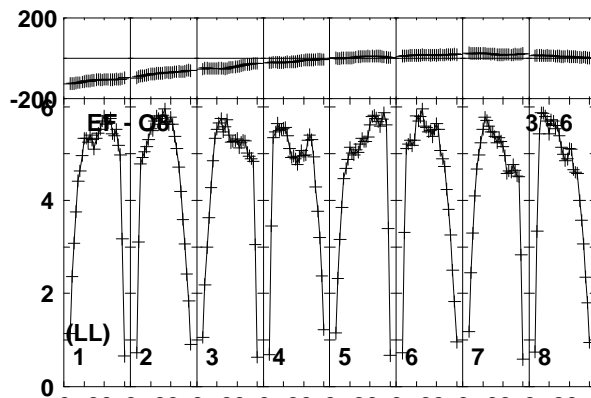
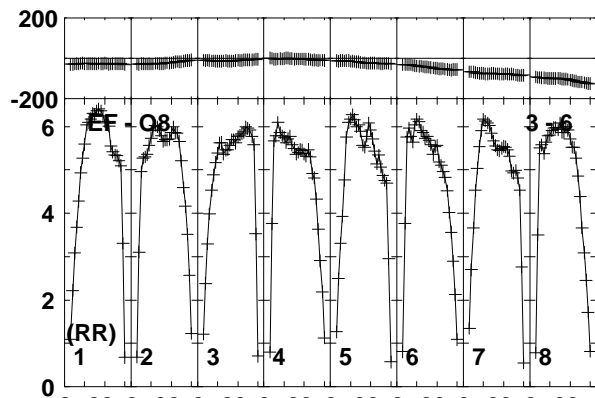
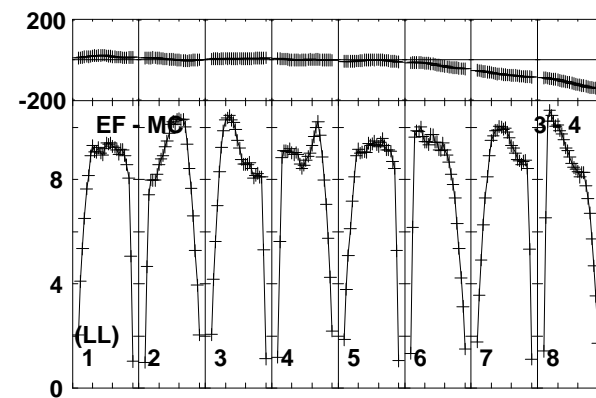
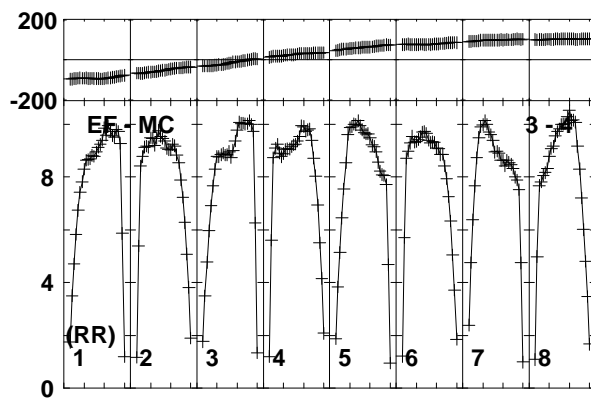
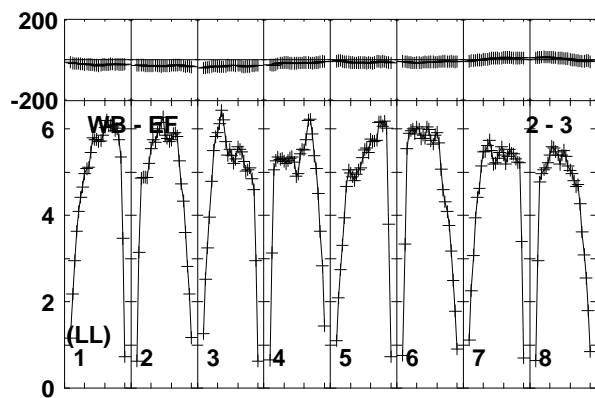
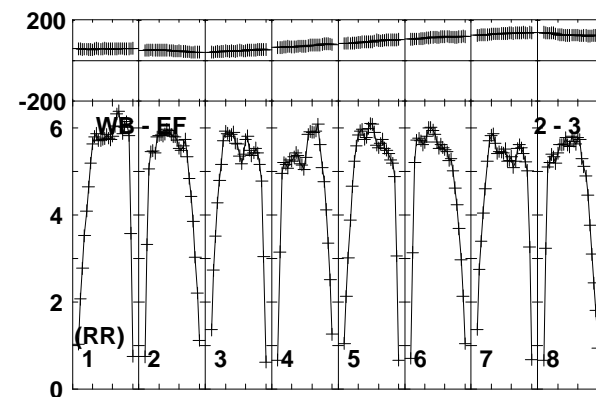
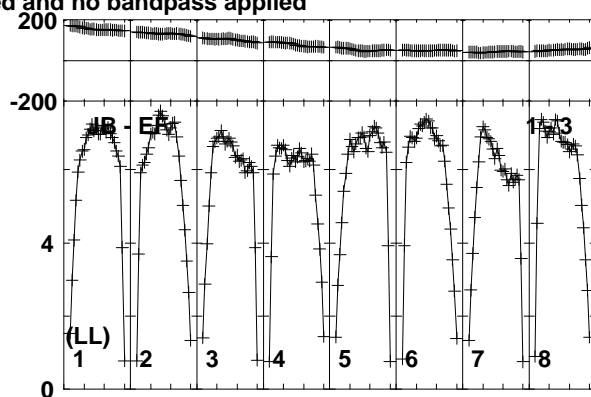
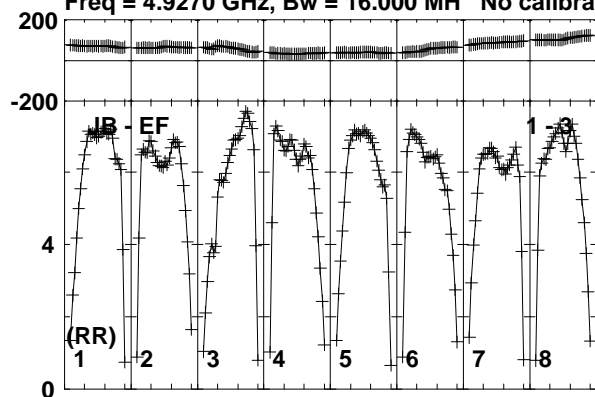

Lower frame: Milli Ampl Jy Top frame: Phas deg  
Vector averaged cross-power spectrum Baseline: JB (01) - EF (03)  
Timerange: 00/09:05:31 to 00/09:06:29

Plot file version 104 created 19-DEC-2018 17:58:19

J1619+2247 RY007C.UVDATA.1

Freq = 4.9270 GHz, Bw = 16.000 MH No calibration applied and no bandpass applied

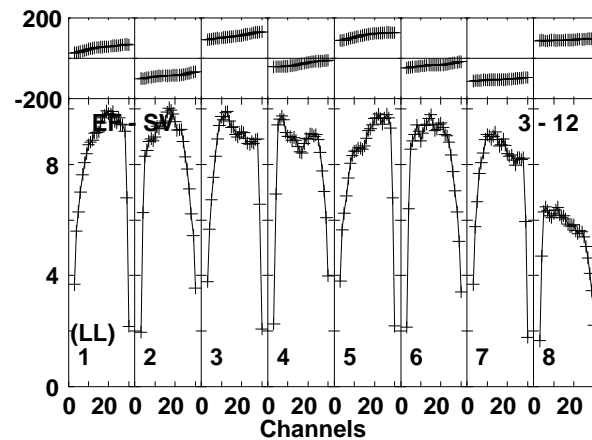
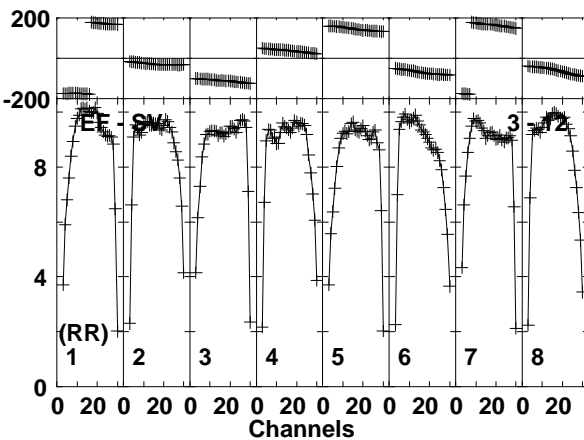
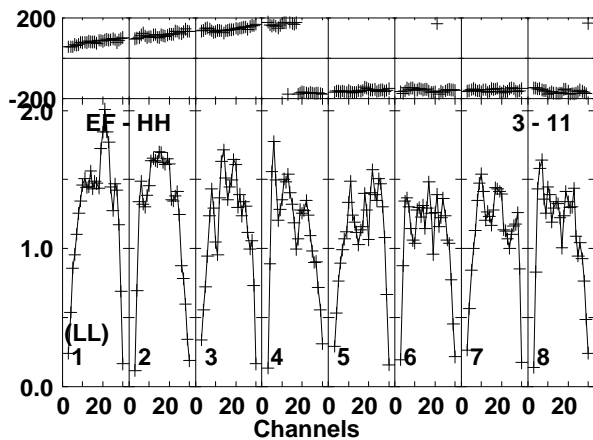
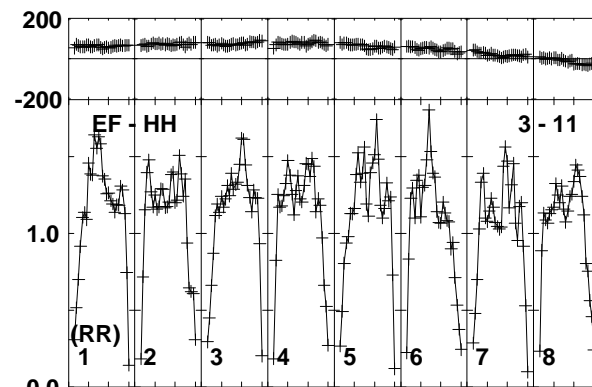
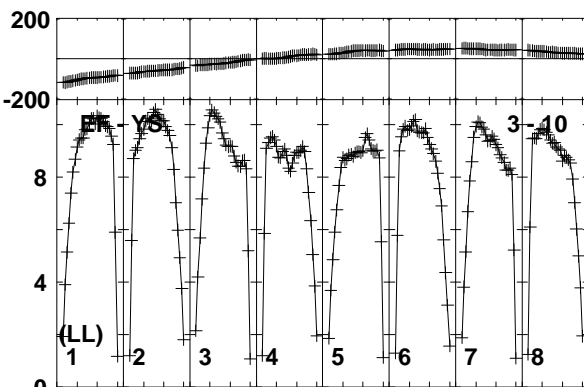
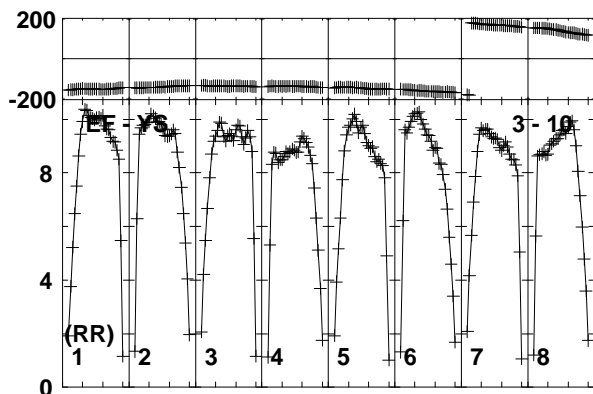
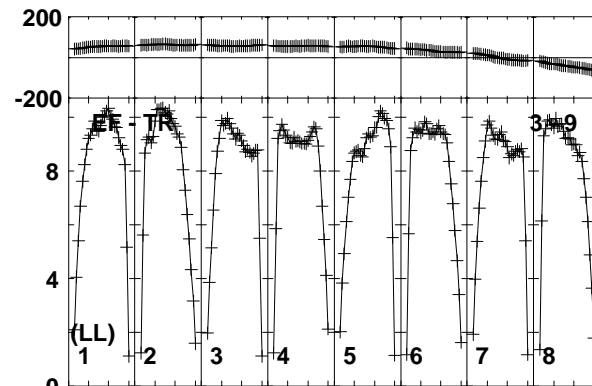
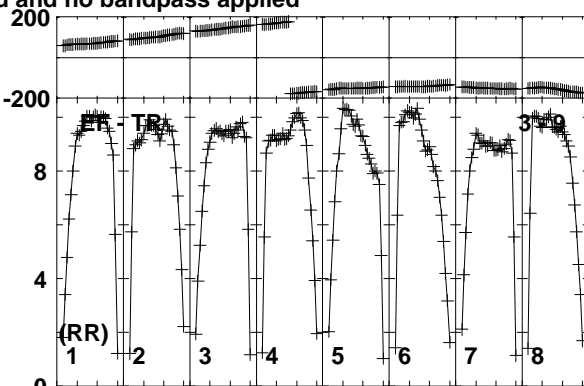
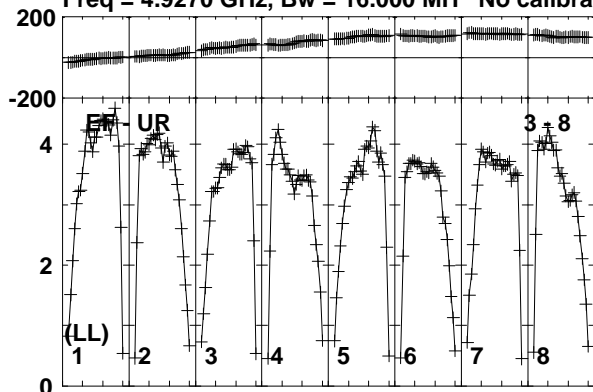

Lower frame: Milli Ampl Jy Top frame: Phas deg  
Vector averaged cross-power spectrum Baseline: EF (03) - UR (08)  
Timerange: 00/09:05:31 to 00/09:06:29

Plot file version 105 created 19-DEC-2018 17:58:19

J1619+2247 RY007C.UVDATA.1

Freq = 4.9270 GHz, Bw = 16.000 MH No calibration applied and no bandpass applied

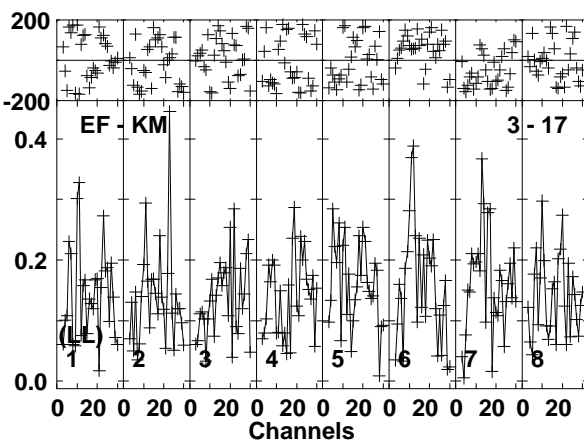
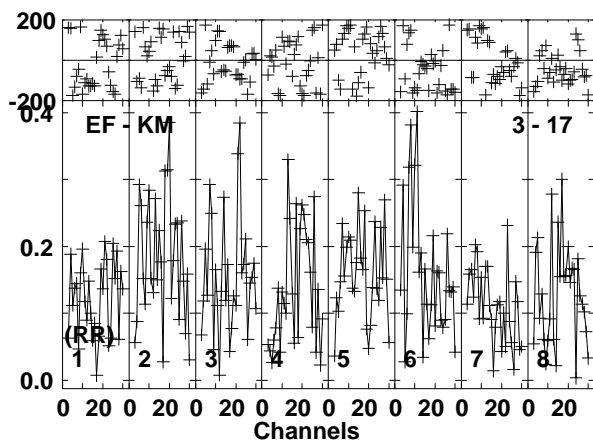
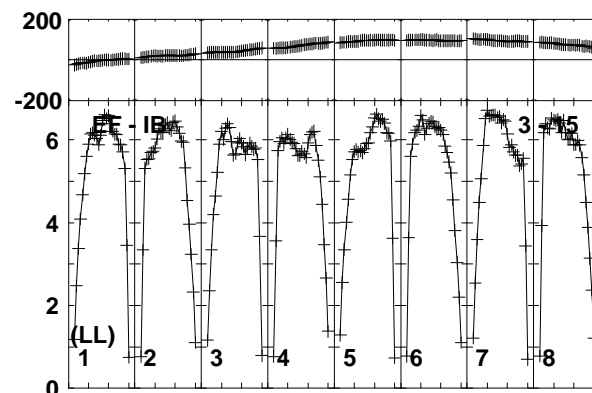
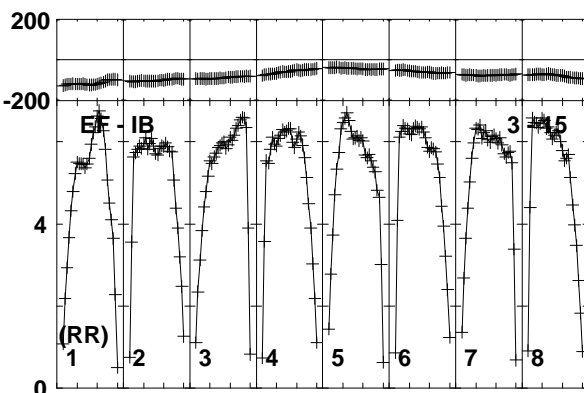
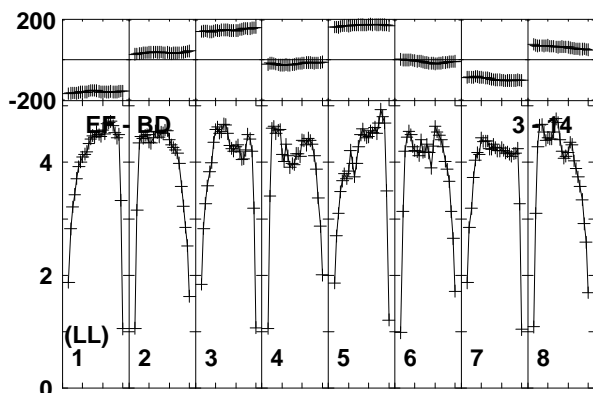
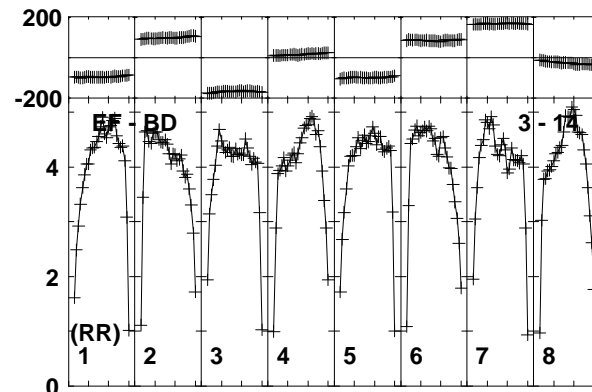
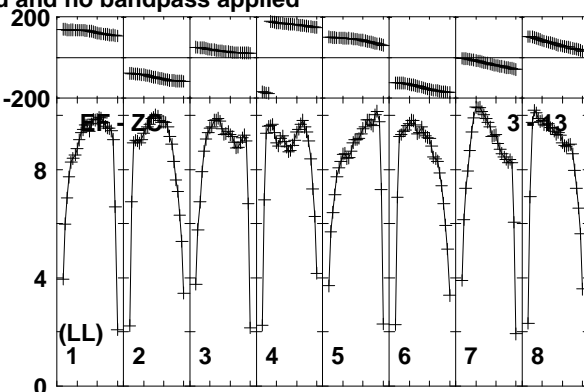
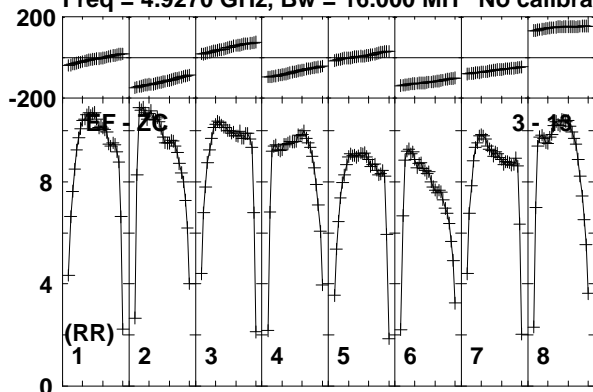

Lower frame: Milli Ampl Jy Top frame: Phas deg  
Vector averaged cross-power spectrum Baseline: EF (03) - ZC (13)  
Timerange: 00/09:05:31 to 00/09:06:29

Plot file version 106 created 19-DEC-2018 17:58:19

AT2018\_RY007C.UVDATA.1

Freq = 4.9270 GHz, Bw = 16.000 MH No calibration applied and no bandpass applied

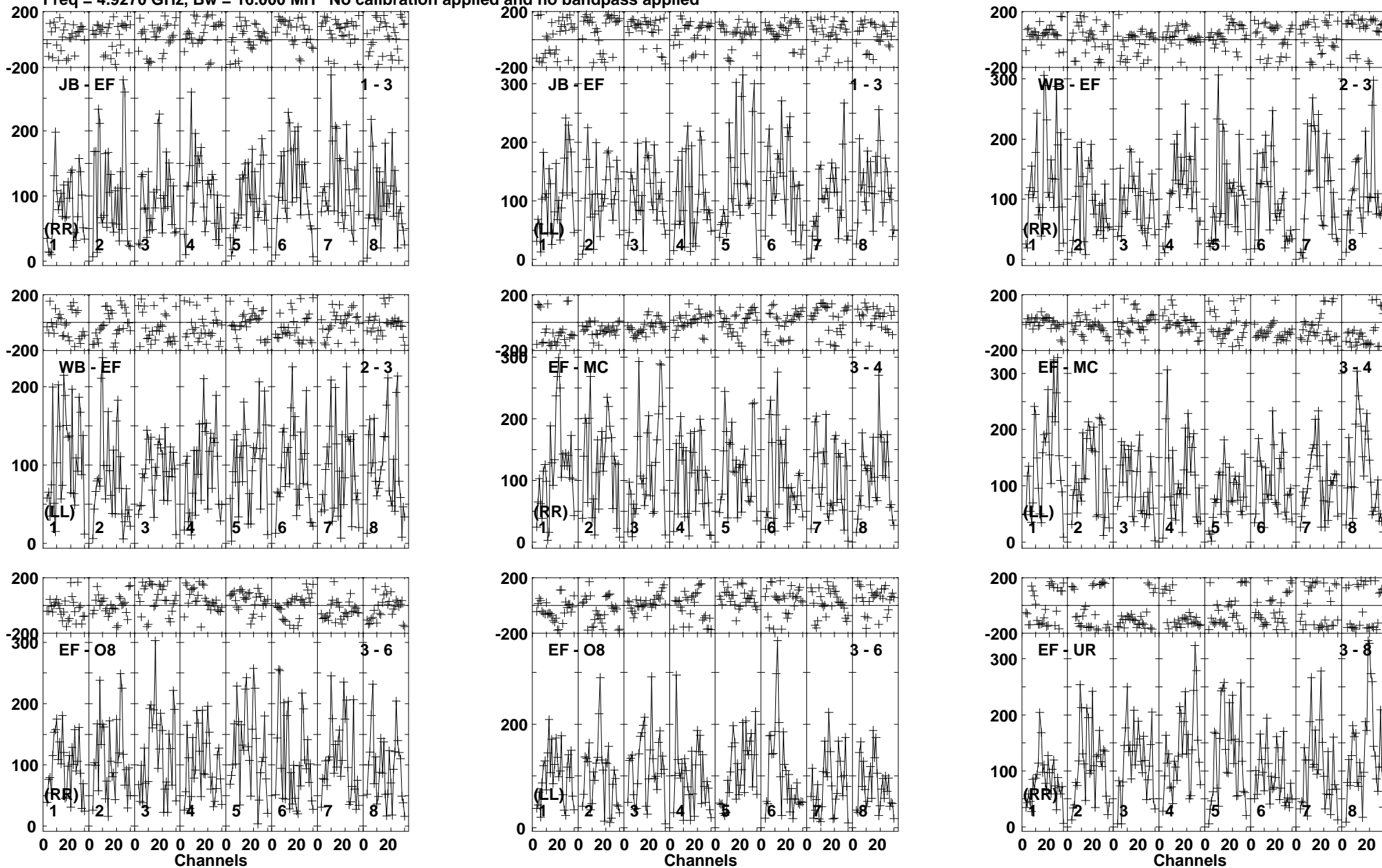

Lower frame: Micro Ampl Jy Top frame: Phas deg  
Vector averaged cross-power spectrum Baseline: JB (01) - EF (03)  
Timerange: 00/09:06:31 to 00/09:09:29



Plot file version 107 created 19-DEC-2018 17:58:19

AT2018\_RY007C.UVDATA.1

Freq = 4.9270 GHz, Bw = 16.000 MH No calibration applied and no bandpass applied

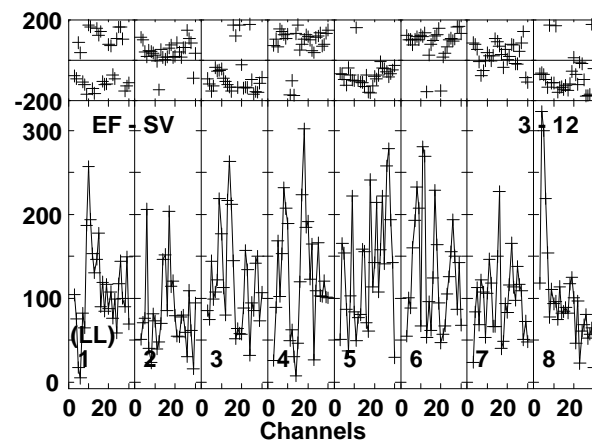
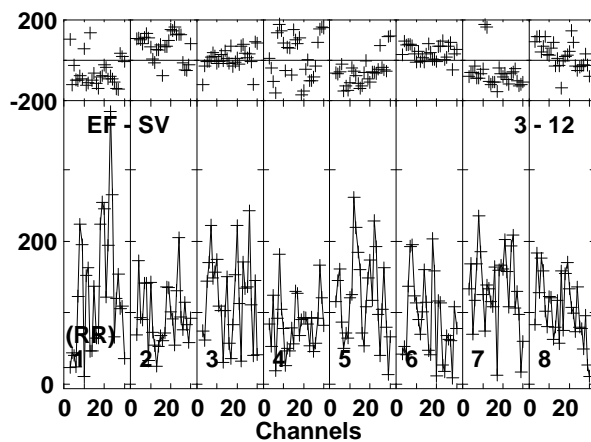
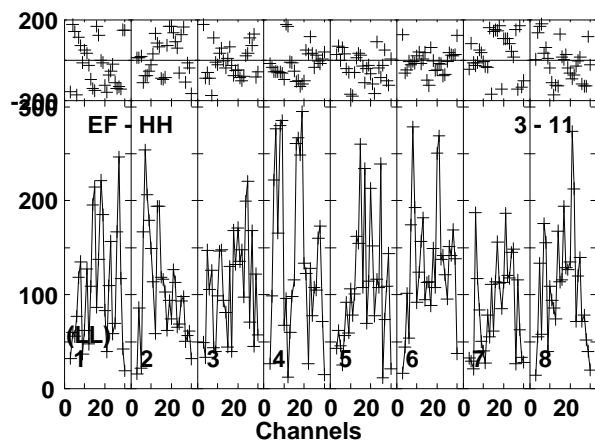
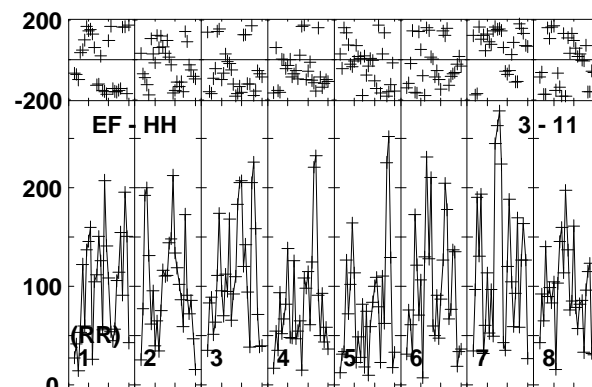
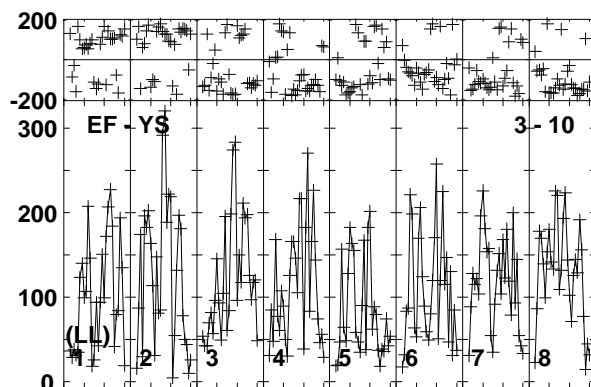
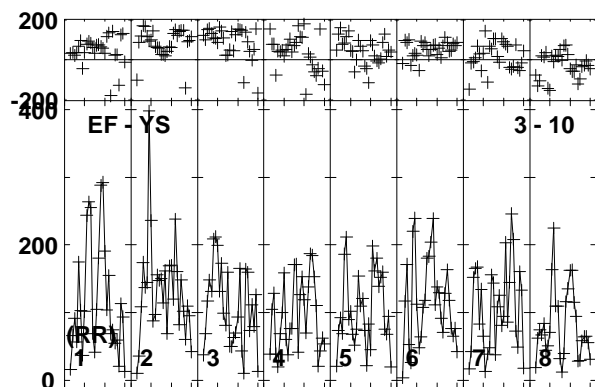
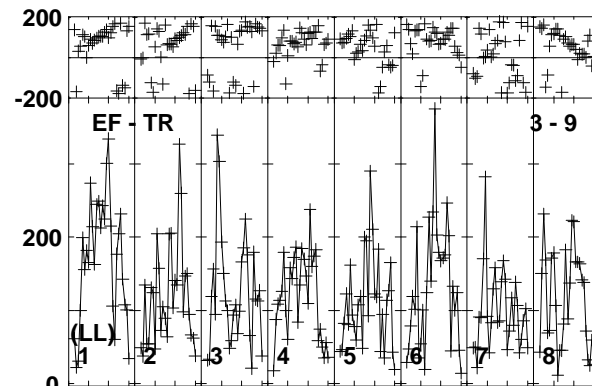
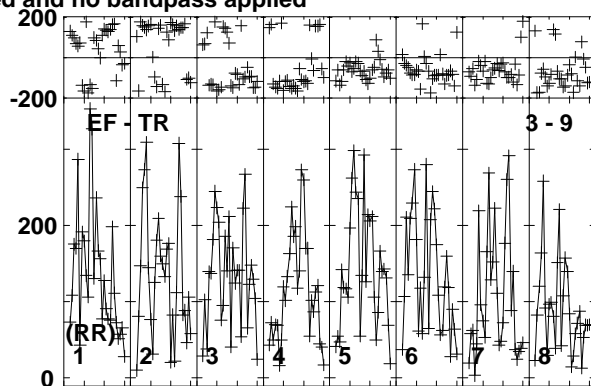
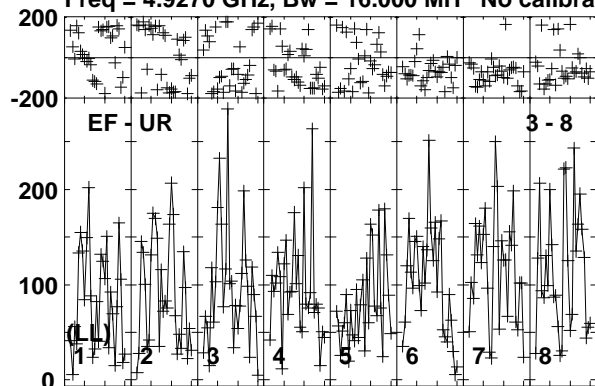

Lower frame: Micro Ampl Jy Top frame: Phas deg  
Vector averaged cross-power spectrum Baseline: EF (03) - UR (08)  
Timerange: 00/09:06:31 to 00/09:09:29

Plot file version 108 created 19-DEC-2018 17:58:19  
AT2018\_RY007C.UVDATA.1

Freq = 4.9270 GHz, Bw = 16.000 MH No calibration applied and no bandpass applied

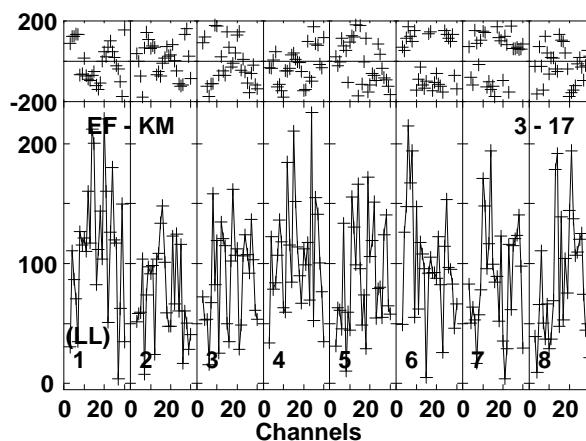
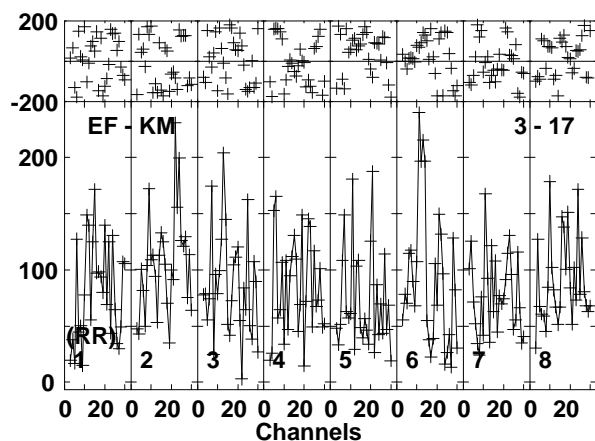
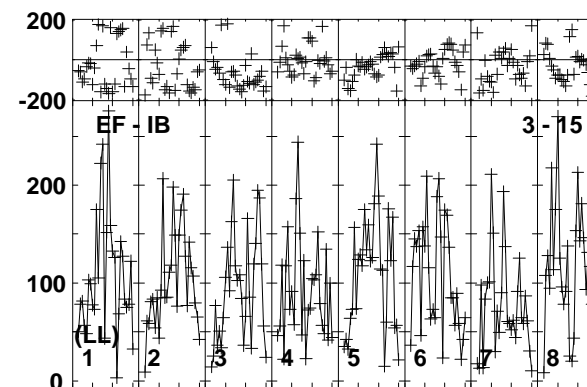
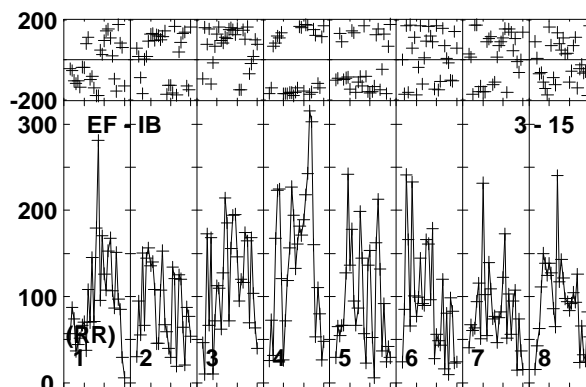
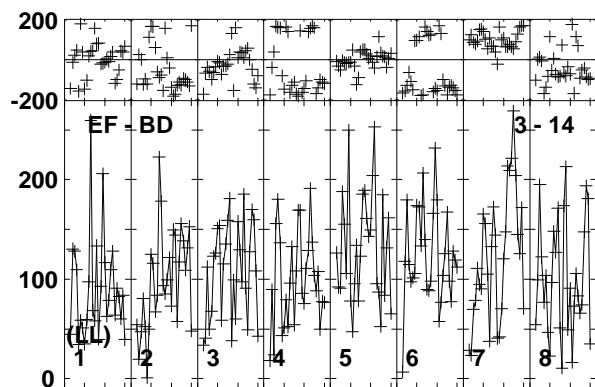
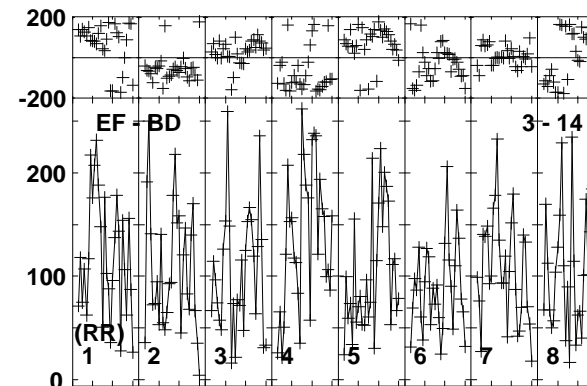
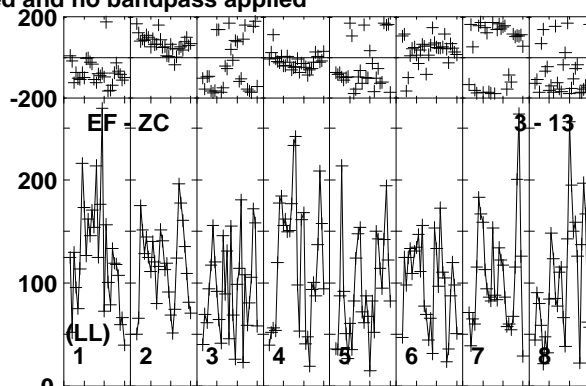
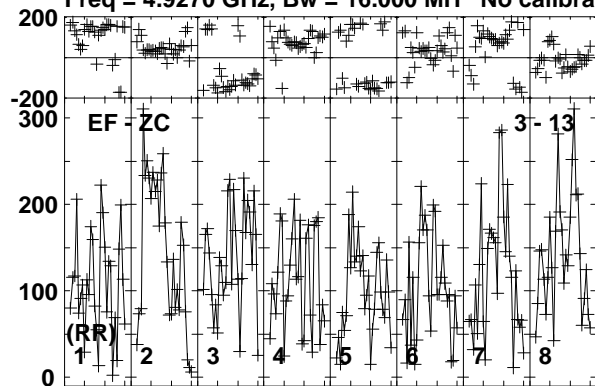

Lower frame: Micro Ampl Jy Top frame: Phas deg  
Vector averaged cross-power spectrum Baseline: EF (03) - ZC (13)  
Timerange: 00/09:06:31 to 00/09:09:29

Plot file version 109 created 19-DEC-2018 17:58:20

J1619+2247 RY007C.UVDATA.1

Freq = 4.9270 GHz, Bw = 16.000 MH No calibration applied and no bandpass applied

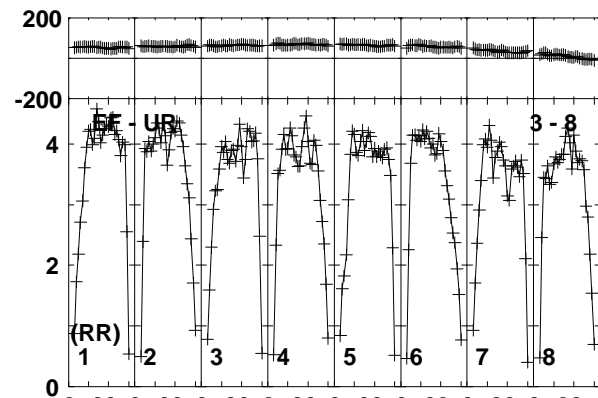
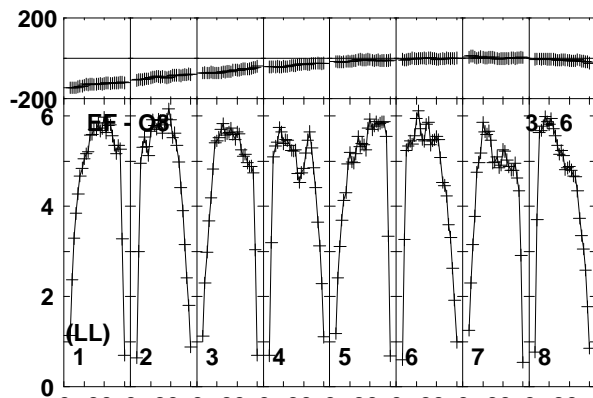
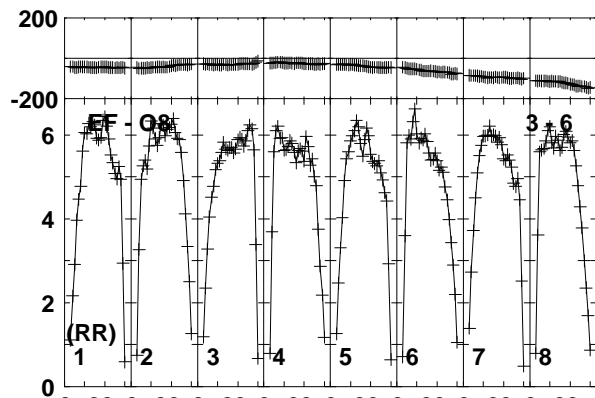
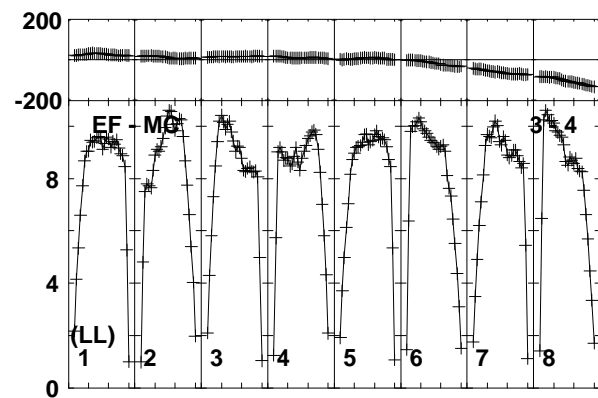
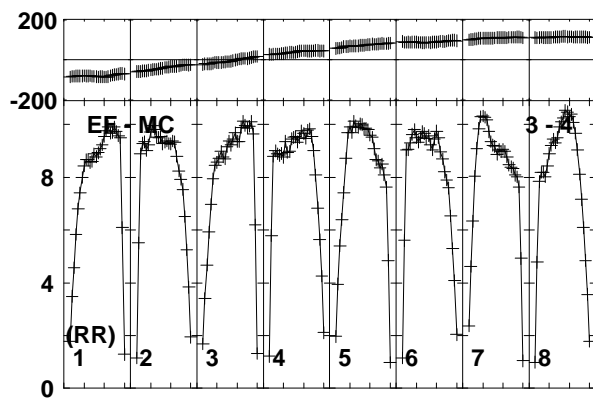
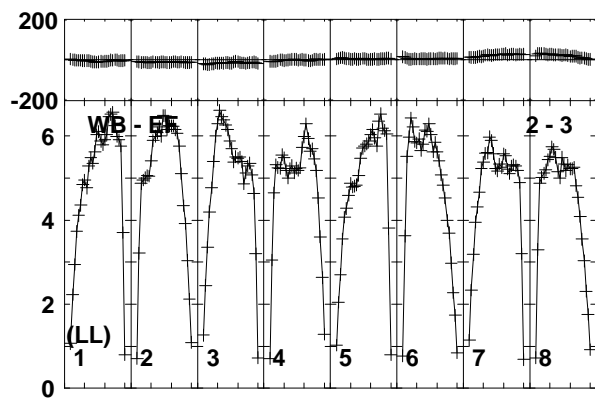
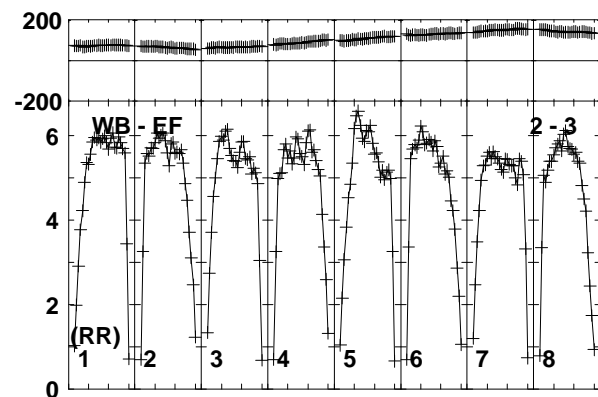
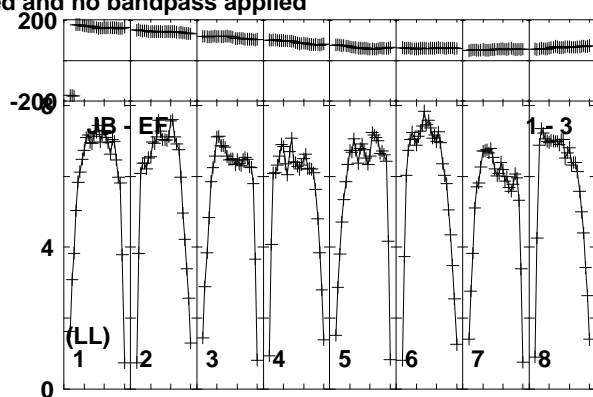
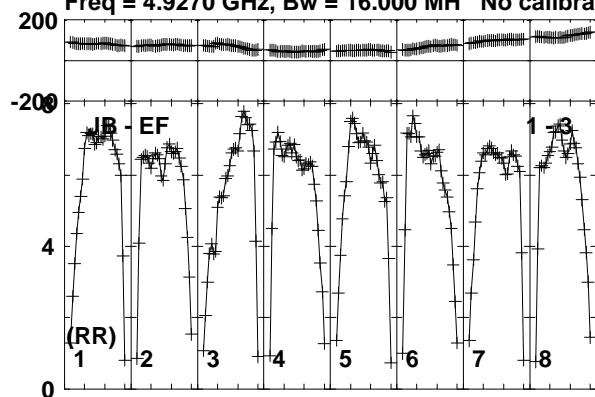

Lower frame: Milli Ampl Jy Top frame: Phas deg  
Vector averaged cross-power spectrum Baseline: JB (01) - EF (03)  
Timerange: 00/09:09:31 to 00/09:10:29

Plot file version 110 created 19-DEC-2018 17:58:20

J1619+2247 RY007C.UVDATA.1

Freq = 4.9270 GHz, Bw = 16.000 MH No calibration applied and no bandpass applied

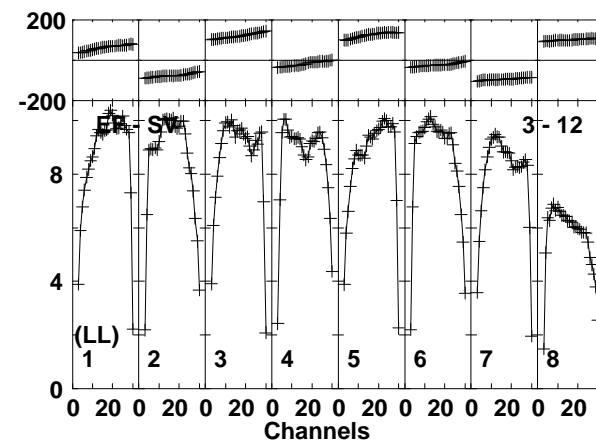
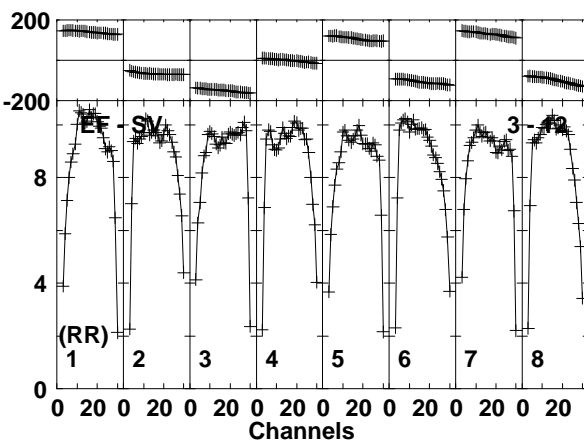
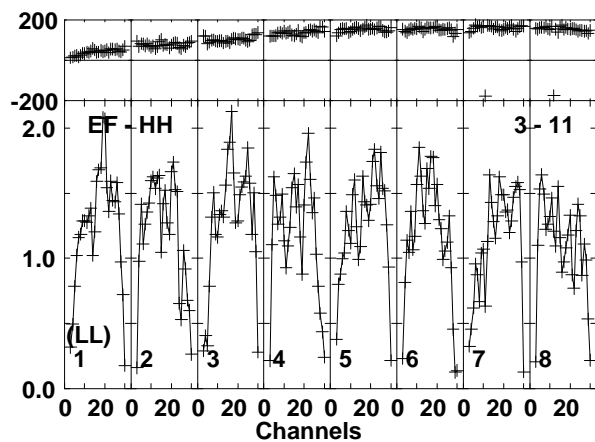
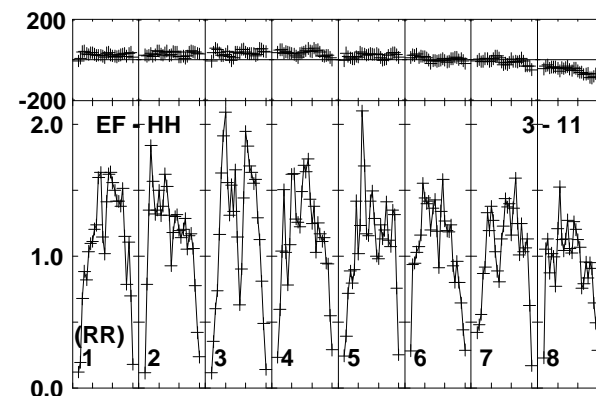
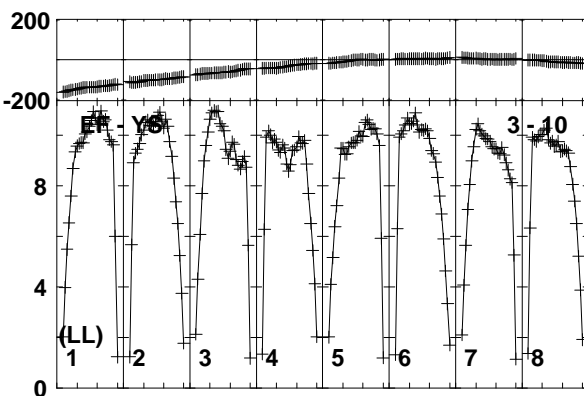
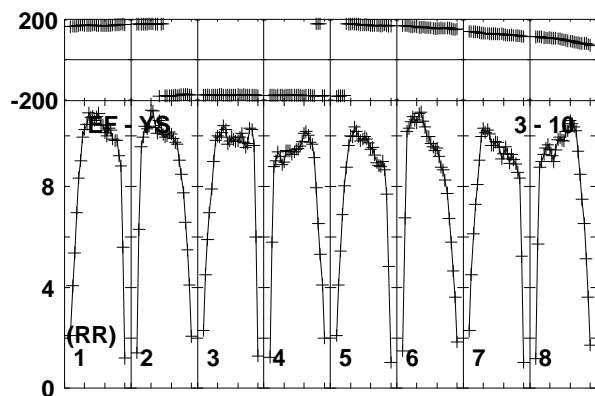
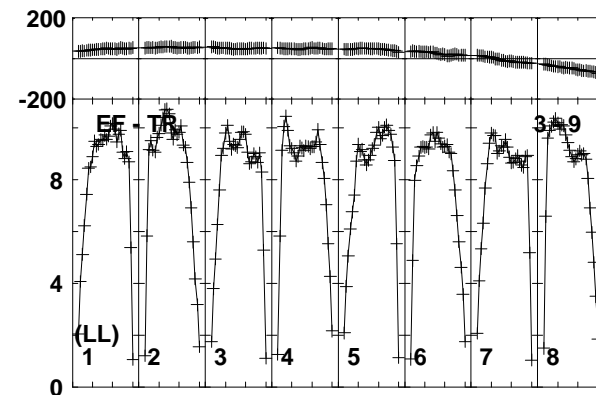
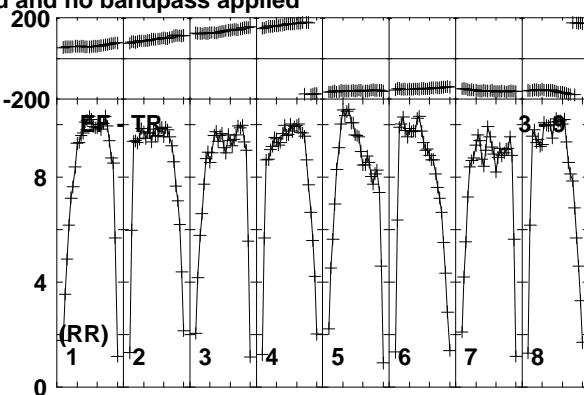
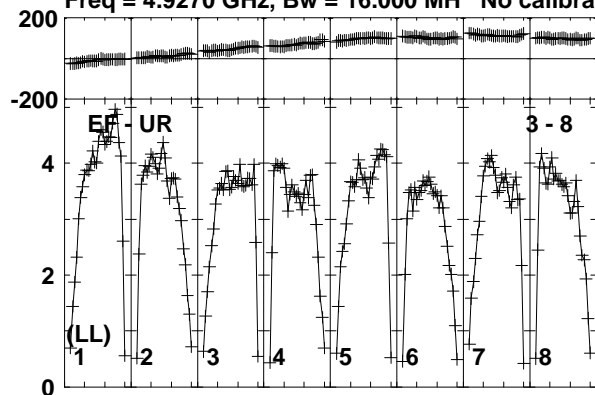

Lower frame: Milli Ampl Jy Top frame: Phas deg  
Vector averaged cross-power spectrum Baseline: EF (03) - UR (08)  
Timerange: 00/09:09:31 to 00/09:10:29

Plot file version 111 created 19-DEC-2018 17:58:20

J1619+2247 RY007C.UVDATA.1

Freq = 4.9270 GHz, Bw = 16.000 MH No calibration applied and no bandpass applied

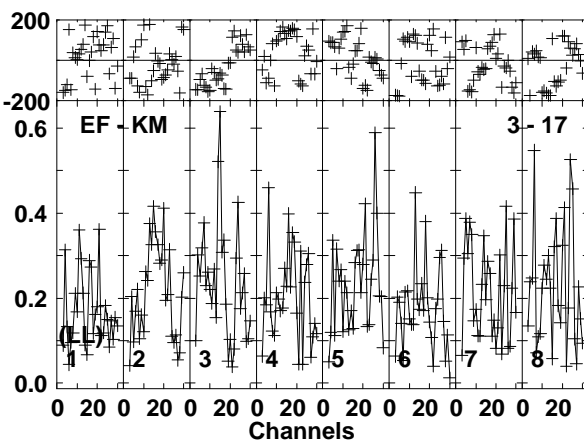
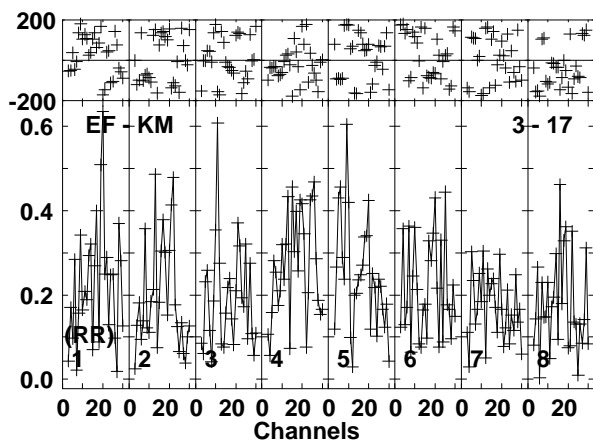
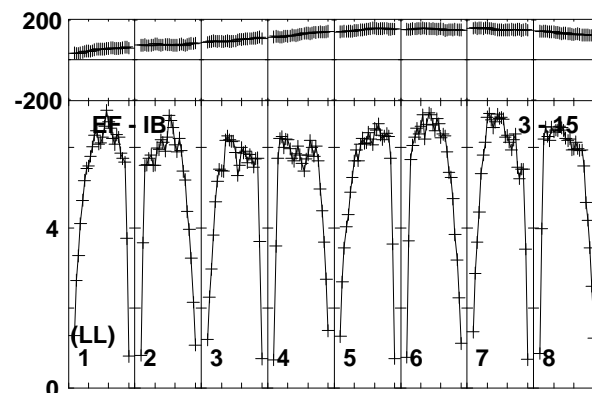
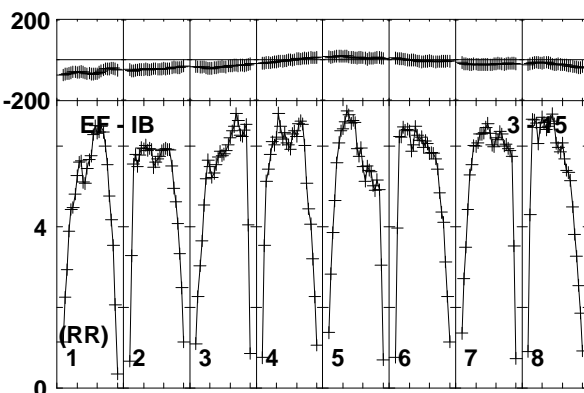
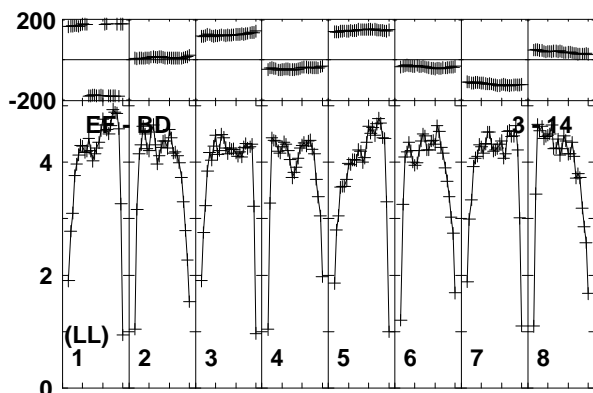
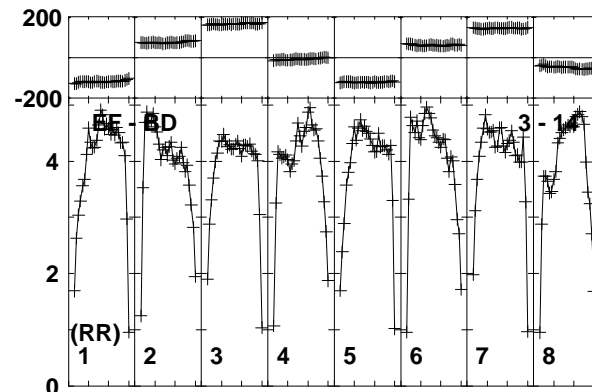
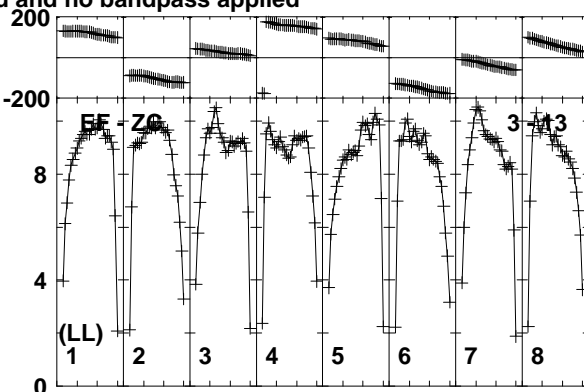
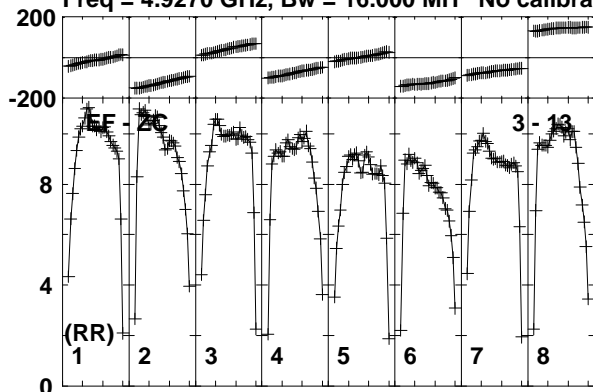

Lower frame: Milli Ampl Jy Top frame: Phas deg  
Vector averaged cross-power spectrum Baseline: EF (03) - ZC (13)  
Timerange: 00/09:09:31 to 00/09:10:29

Plot file version 112 created 19-DEC-2018 17:58:20  
AT2018\_RY007C.UVDATA.1

Freq = 4.9270 GHz, Bw = 16.000 MH No calibration applied and no bandpass applied

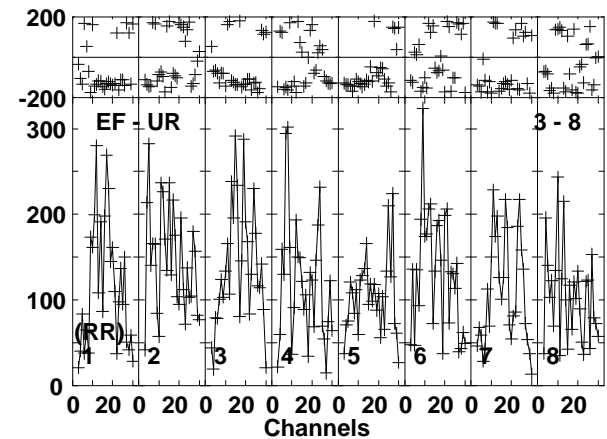
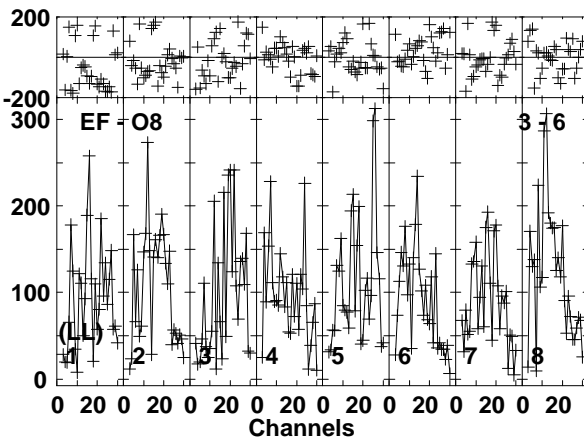
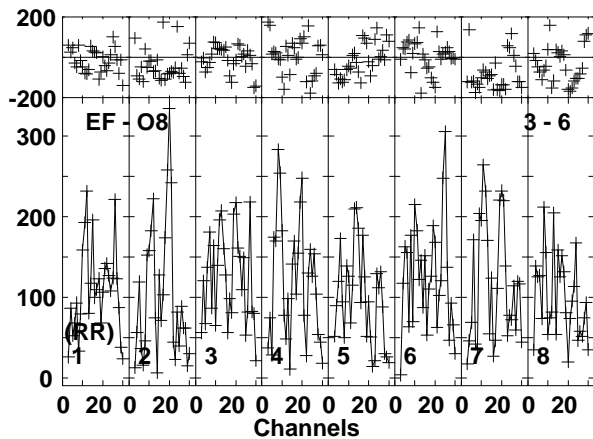
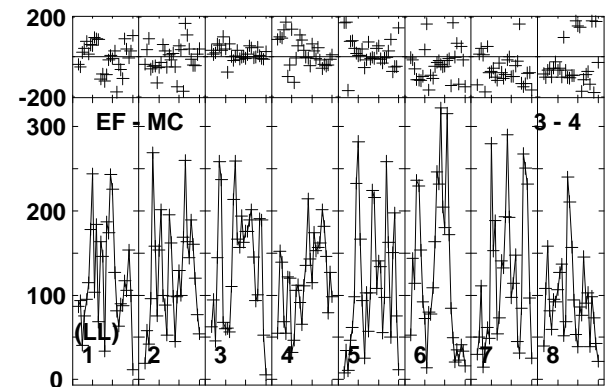
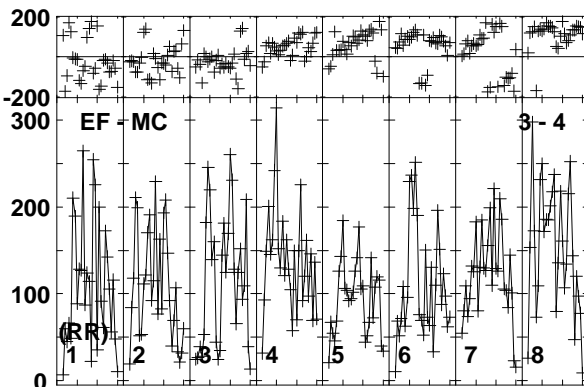
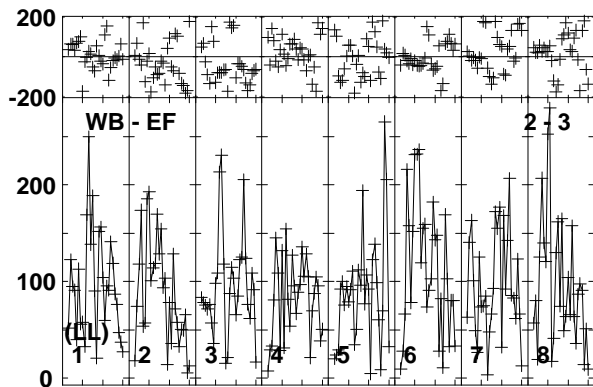
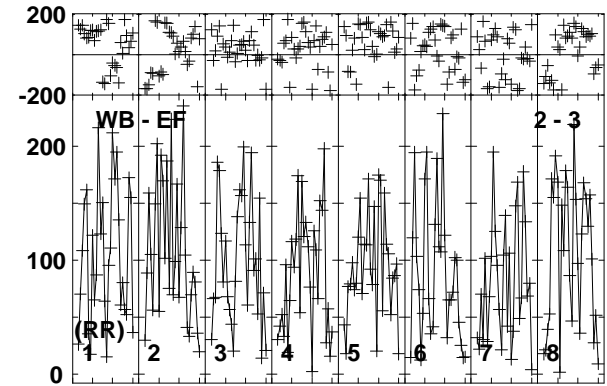
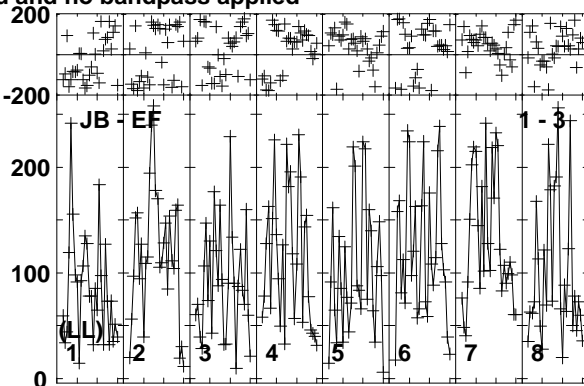
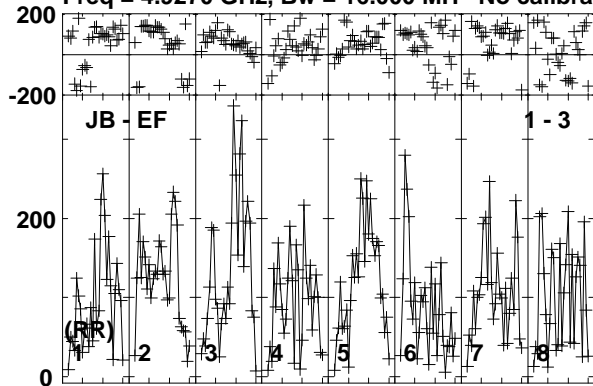

Lower frame: Micro Ampl Jy Top frame: Phas deg  
Vector averaged cross-power spectrum Baseline: JB (01) - EF (03)  
Timerange: 00/09:10:31 to 00/09:13:29

Plot file version 113 created 19-DEC-2018 17:58:20

AT2018\_RY007C.UVDATA.1

Freq = 4.9270 GHz, Bw = 16.000 MH No calibration applied and no bandpass applied

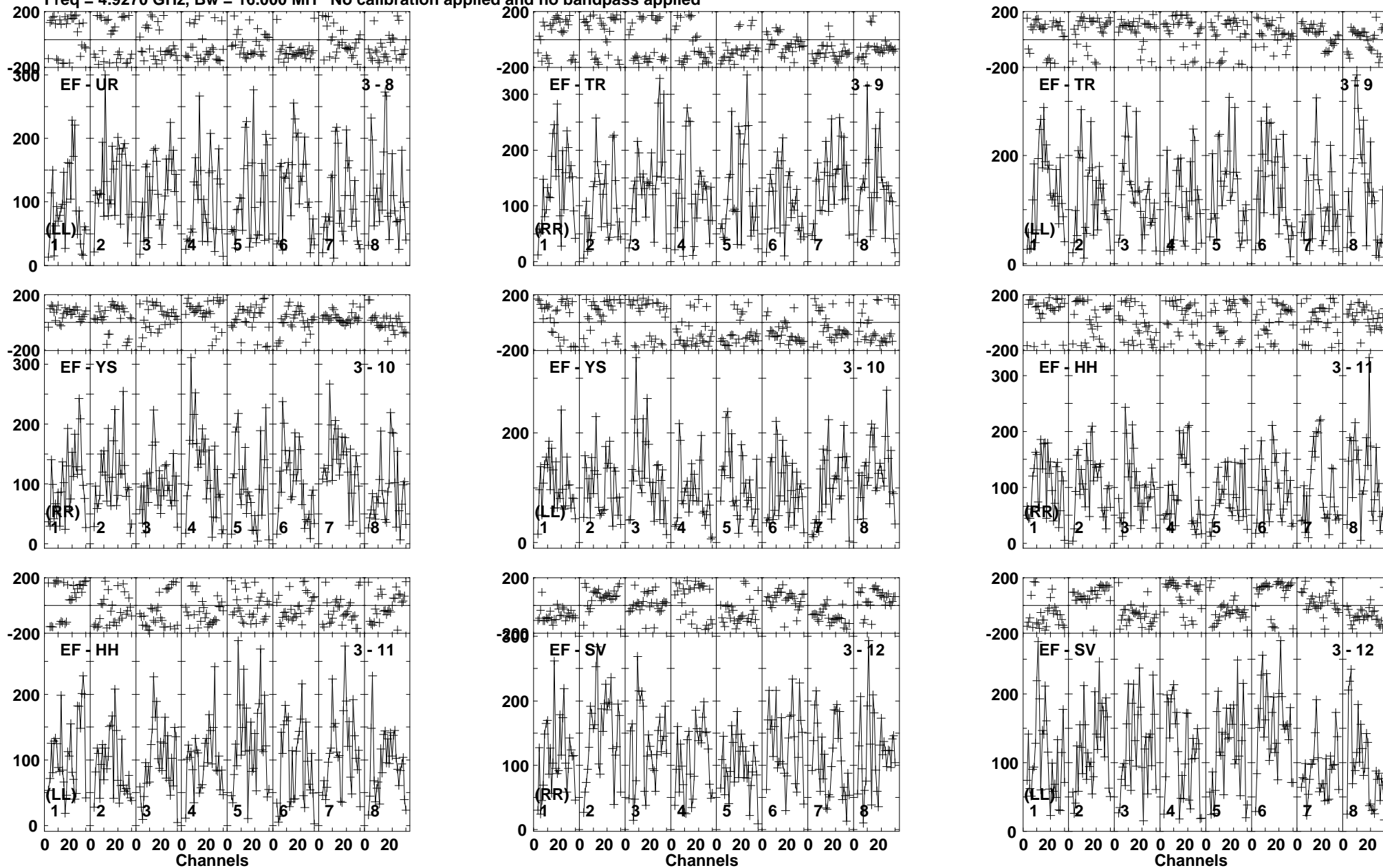

Lower frame: Micro Ampl Jy Top frame: Phas deg  
Vector averaged cross-power spectrum Baseline: EF (03) - UR (08)  
Timerange: 00/09:10:31 to 00/09:13:29

Plot file version 114 created 19-DEC-2018 17:58:20

AT2018\_RY007C.UVDATA.1

Freq = 4.9270 GHz, Bw = 16.000 MH No calibration applied and no bandpass applied

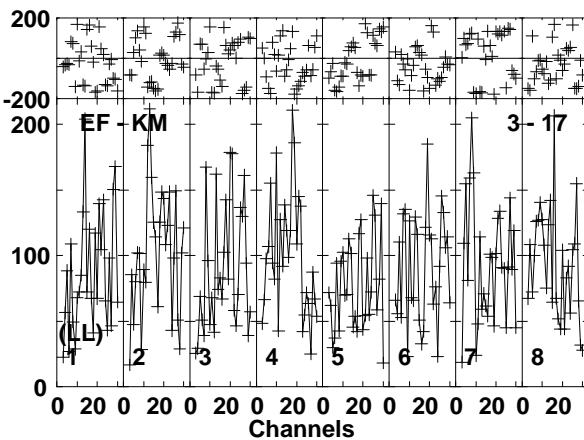
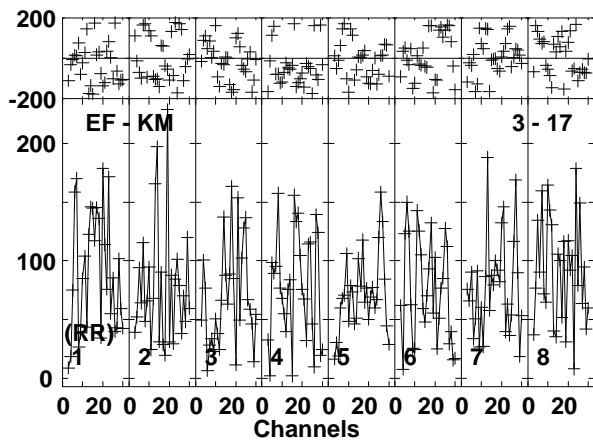
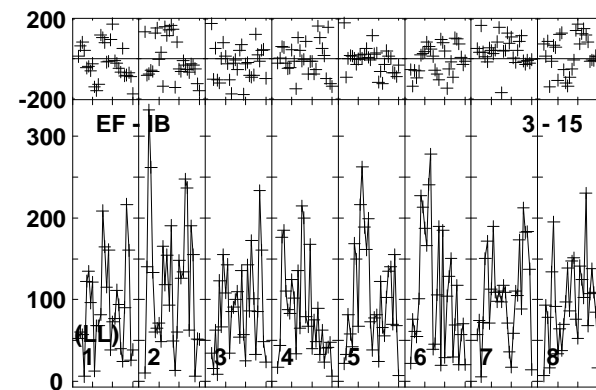
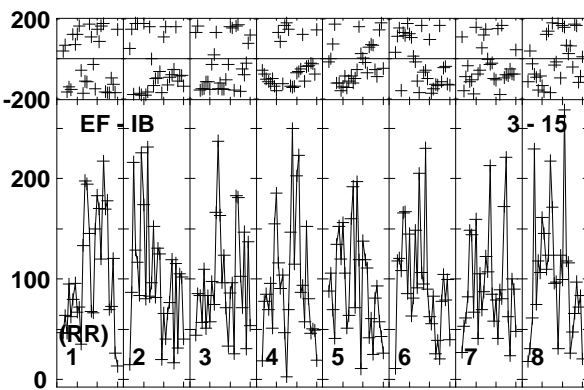
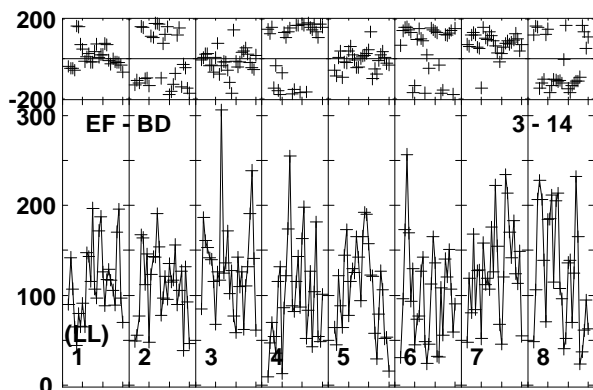
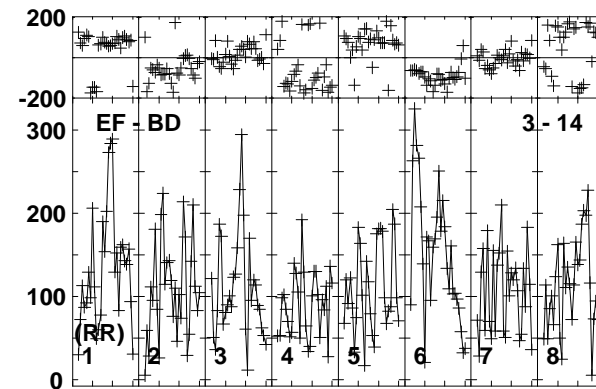
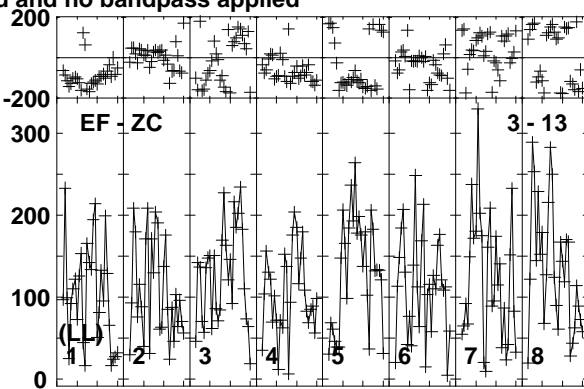
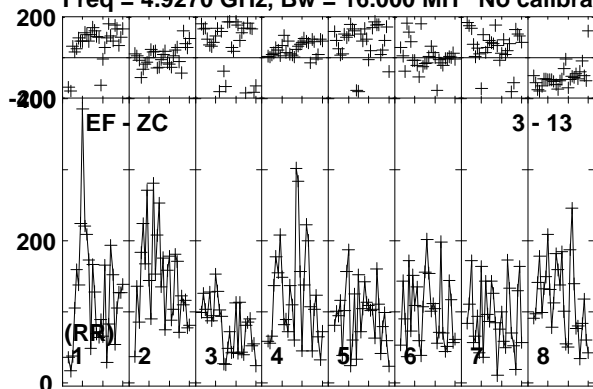

Lower frame: Micro Ampl Jy Top frame: Phas deg  
Vector averaged cross-power spectrum Baseline: EF (03) - ZC (13)  
Timerange: 00/09:10:31 to 00/09:13:29



Plot file version 115 created 19-DEC-2018 17:58:20

J1619+2247 RY007C.UVDATA.1

Freq = 4.9270 GHz, Bw = 16.000 MH No calibration applied and no bandpass applied

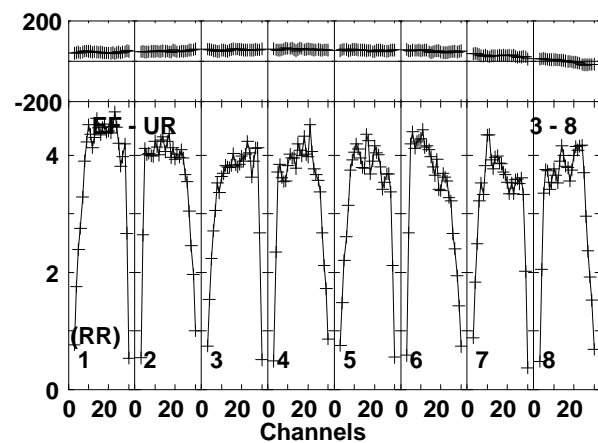
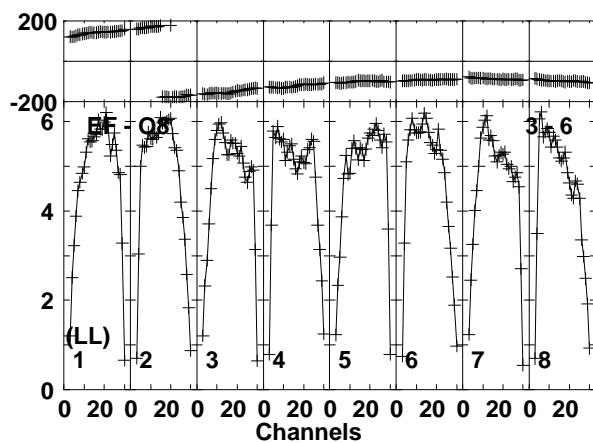
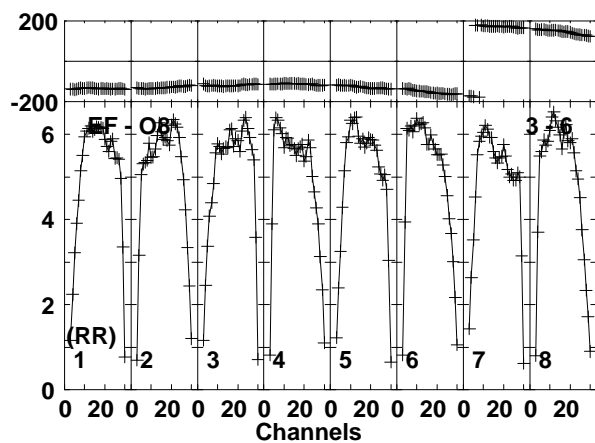
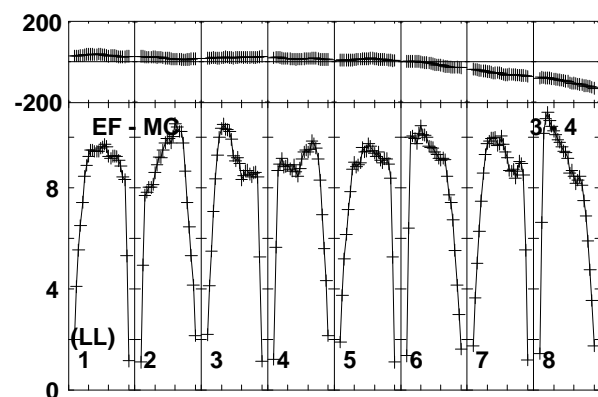
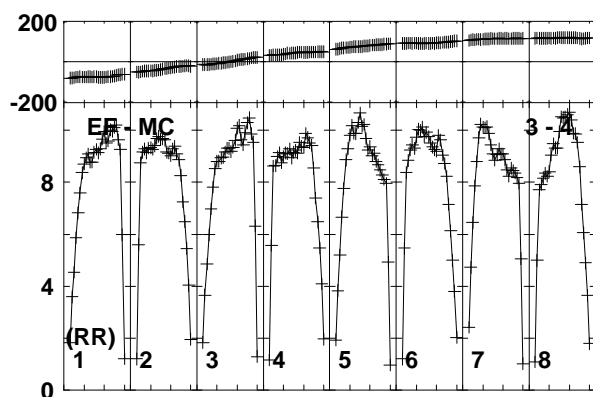
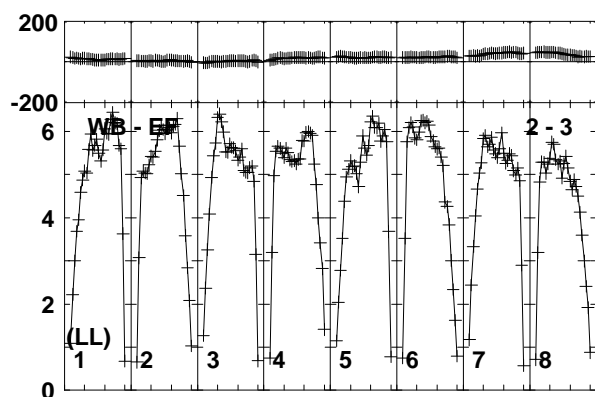
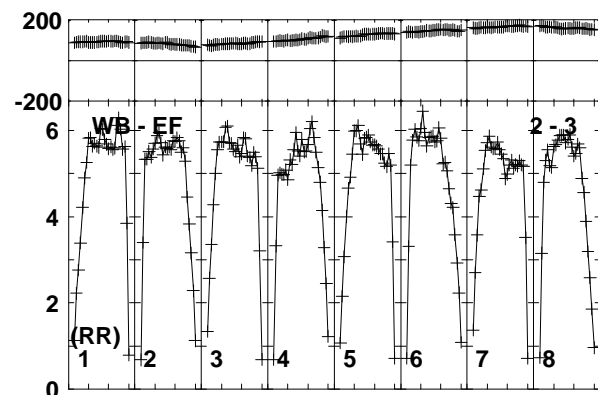
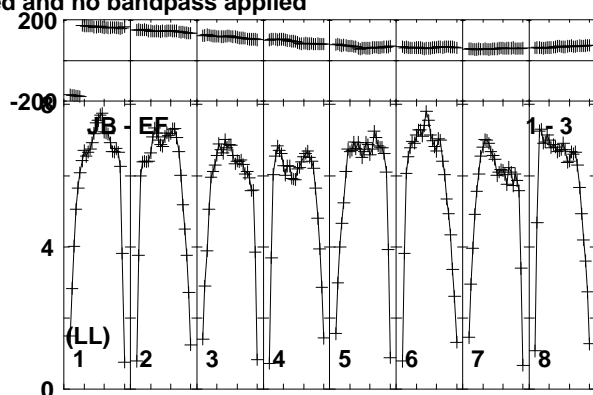
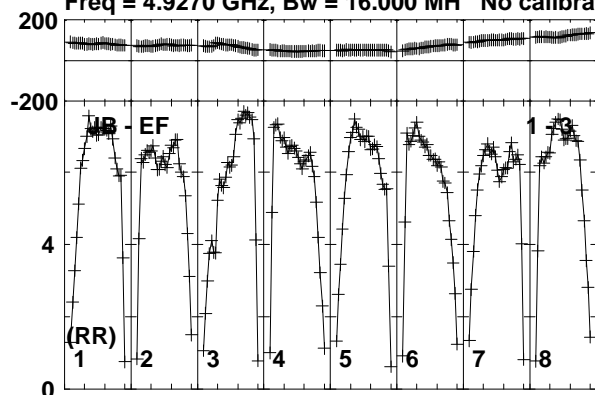

Lower frame: Milli Ampl Jy Top frame: Phas deg  
Vector averaged cross-power spectrum Baseline: JB (01) - EF (03)  
Timerange: 00/09:13:31 to 00/09:14:29

Plot file version 116 created 19-DEC-2018 17:58:20

J1619+2247 RY007C.UVDATA.1

Freq = 4.9270 GHz, Bw = 16.000 MH No calibration applied and no bandpass applied

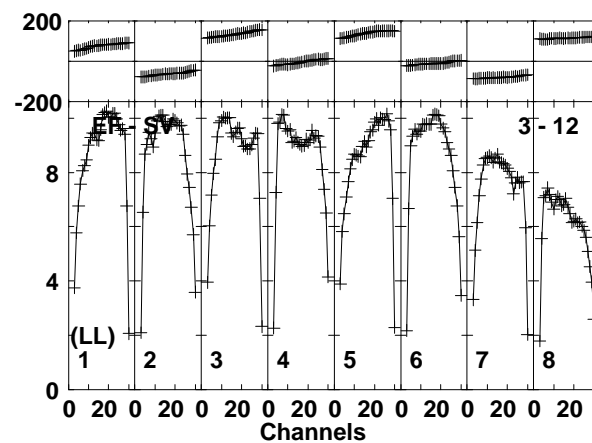
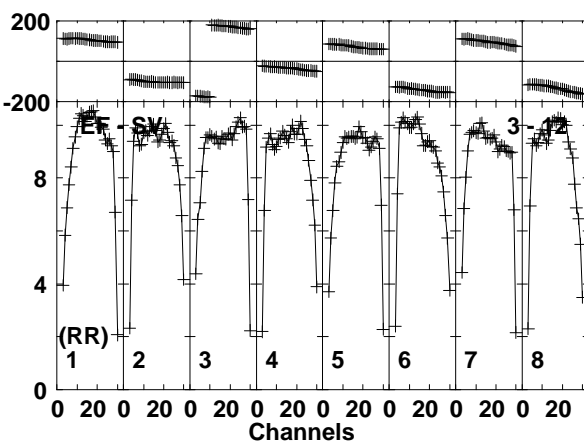
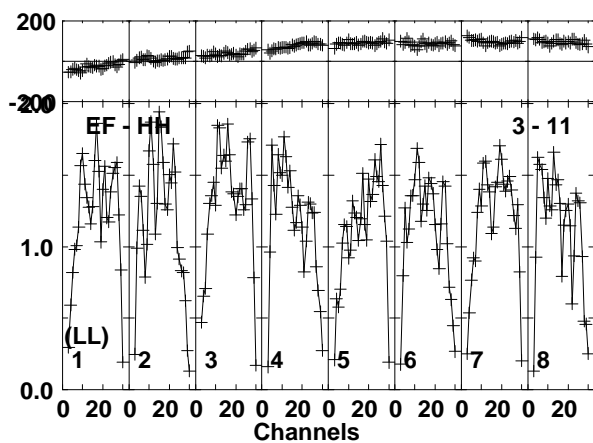
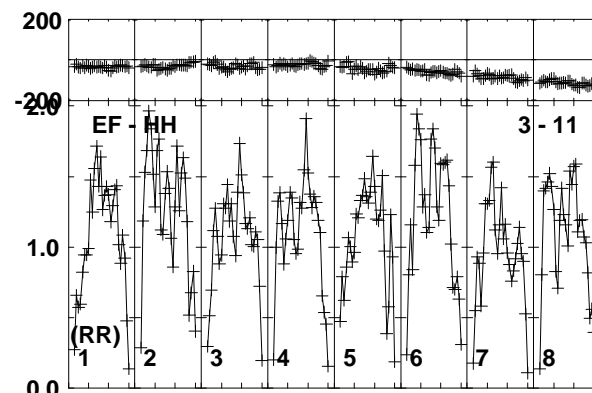
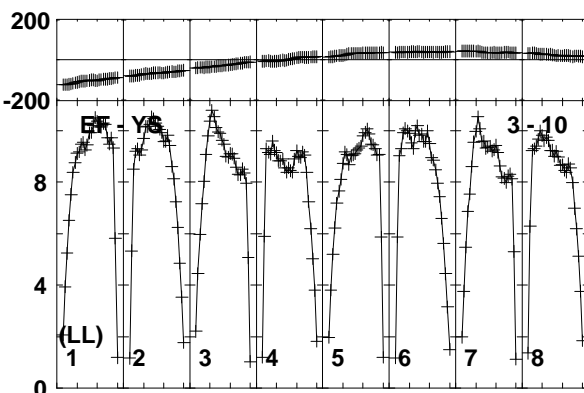
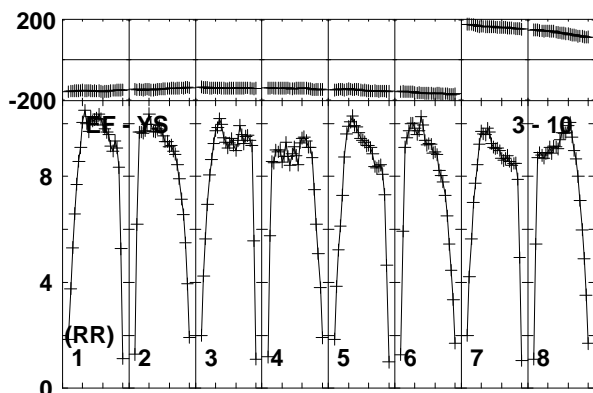
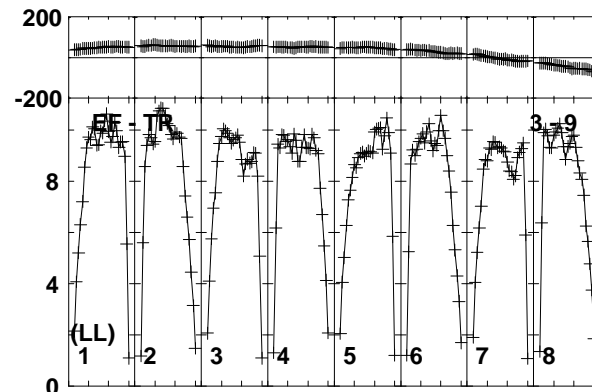
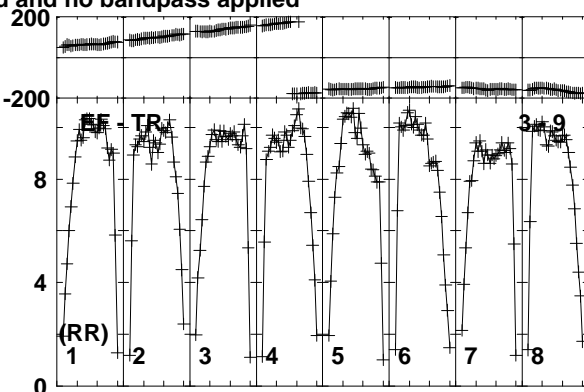
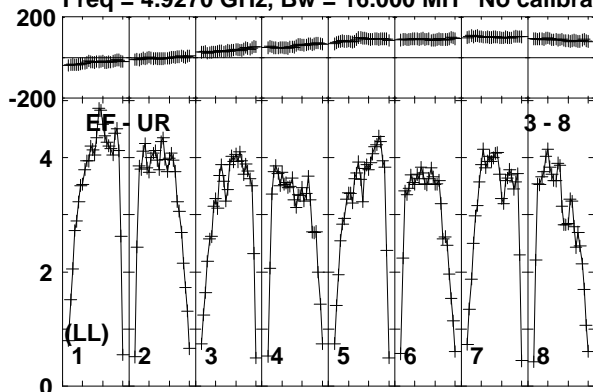

Lower frame: Milli Ampl Jy Top frame: Phas deg  
Vector averaged cross-power spectrum Baseline: EF (03) - UR (08)  
Timerange: 00/09:13:31 to 00/09:14:29

Plot file version 117 created 19-DEC-2018 17:58:20

J1619+2247 RY007C.UVDATA.1

Freq = 4.9270 GHz, Bw = 16.000 MH No calibration applied and no bandpass applied

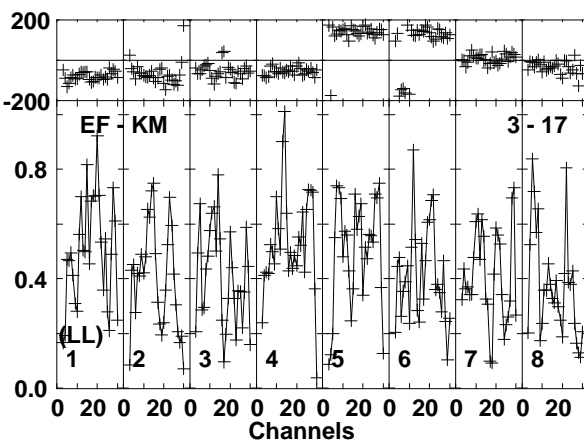
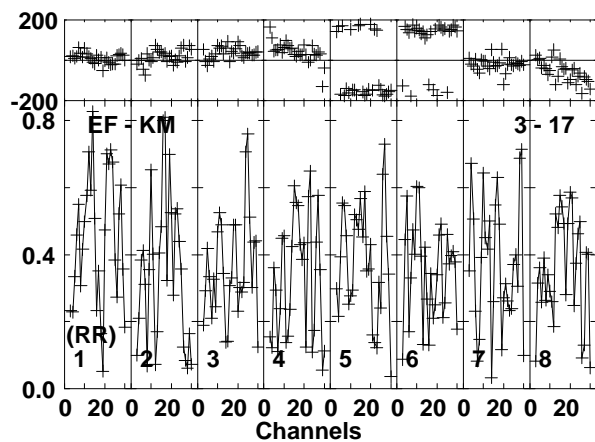
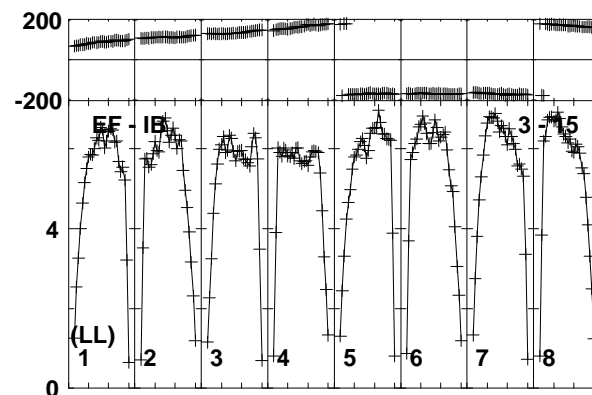
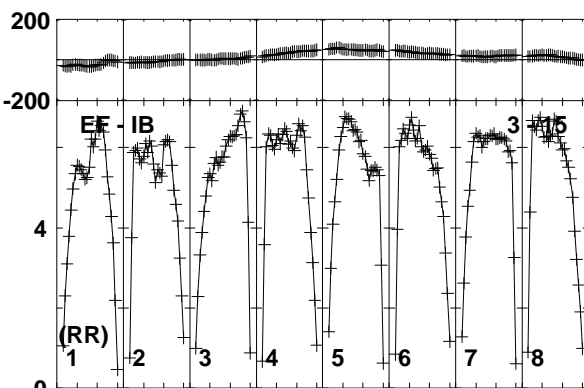
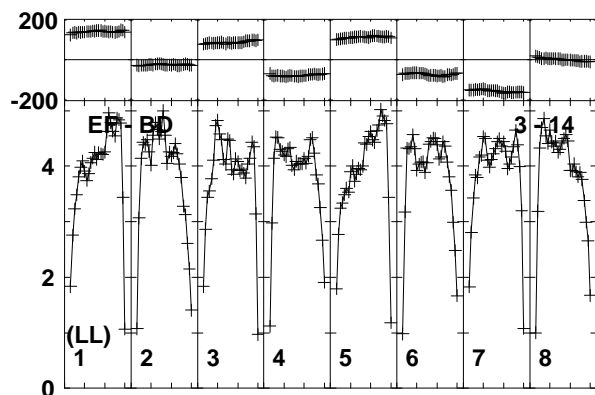
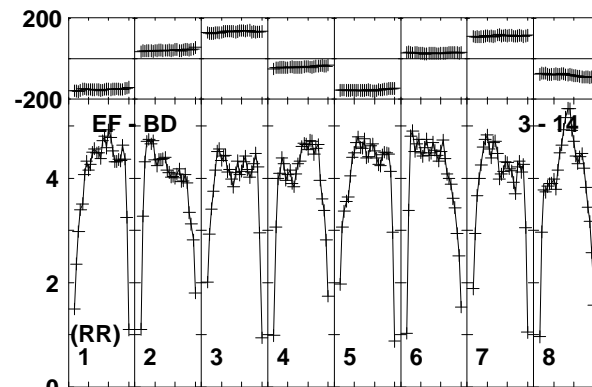
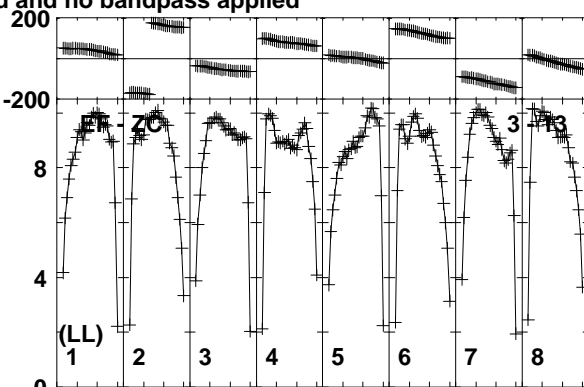
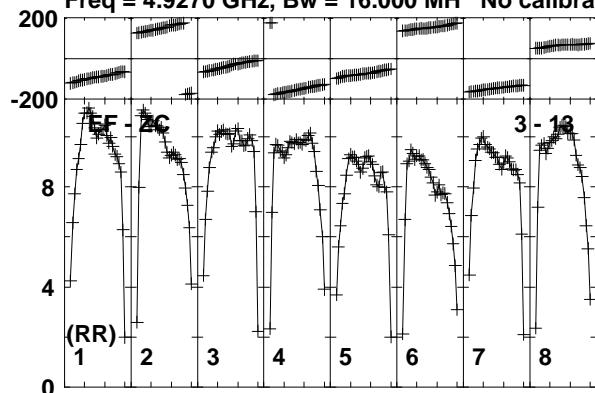

Lower frame: Milli Ampl Jy Top frame: Phas deg  
Vector averaged cross-power spectrum Baseline: EF (03) - ZC (13)  
Timerange: 00/09:13:31 to 00/09:14:29

Plot file version 118 created 19-DEC-2018 17:58:20

VLA1 RY007C.UVDATA.1

Freq = 4.9270 GHz, Bw = 16.000 MH No calibration applied and no bandpass applied

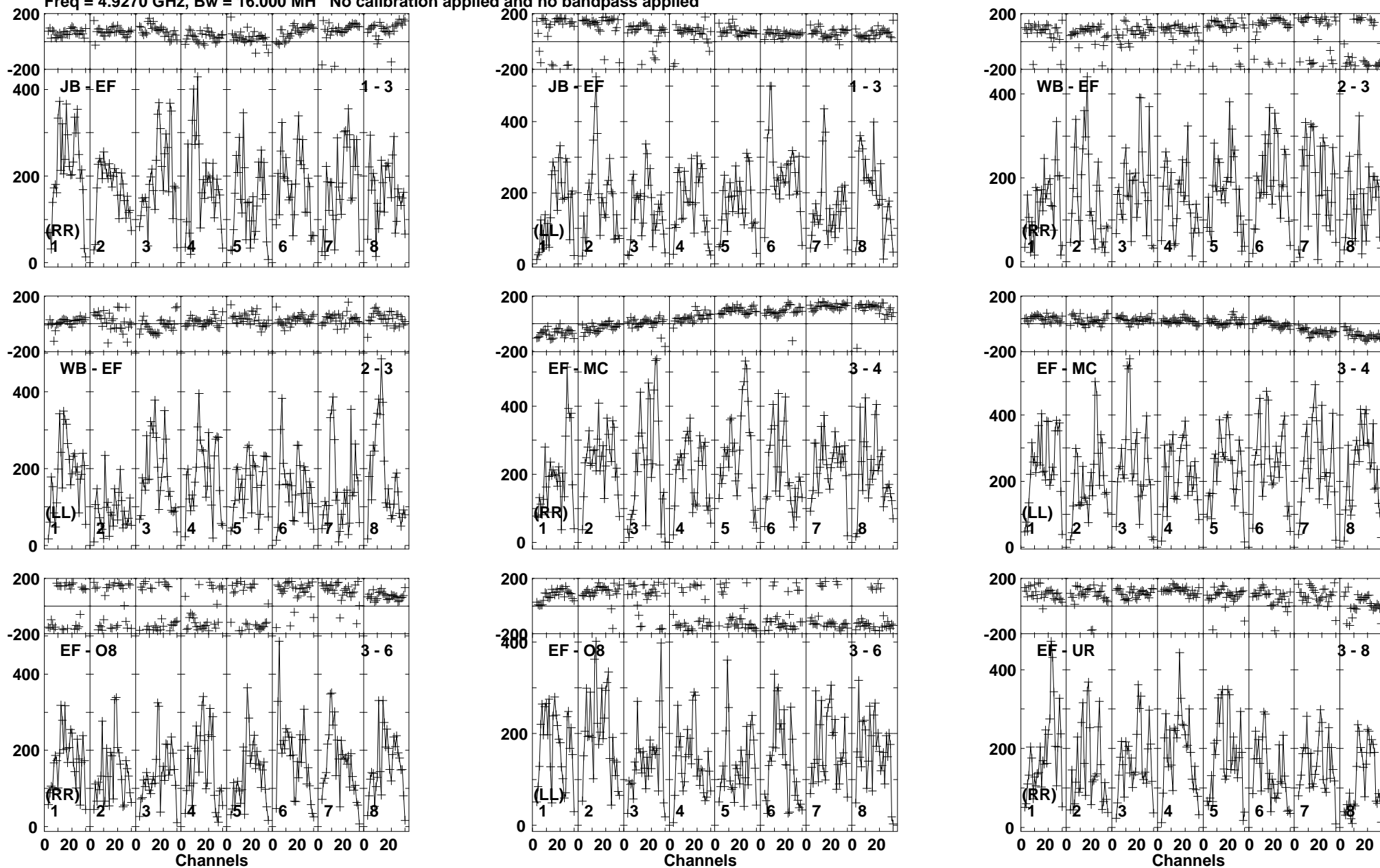

Lower frame: Micro Ampl Jy Top frame: Phas deg  
Vector averaged cross-power spectrum Baseline: JB (01) - EF (03)  
Timerange: 00/09:15:01 to 00/09:16:59

Plot file version 119 created 19-DEC-2018 17:58:20

VLA1 RY007C.UVDATA.1

Freq = 4.9270 GHz, Bw = 16.000 MH No calibration applied and no bandpass applied

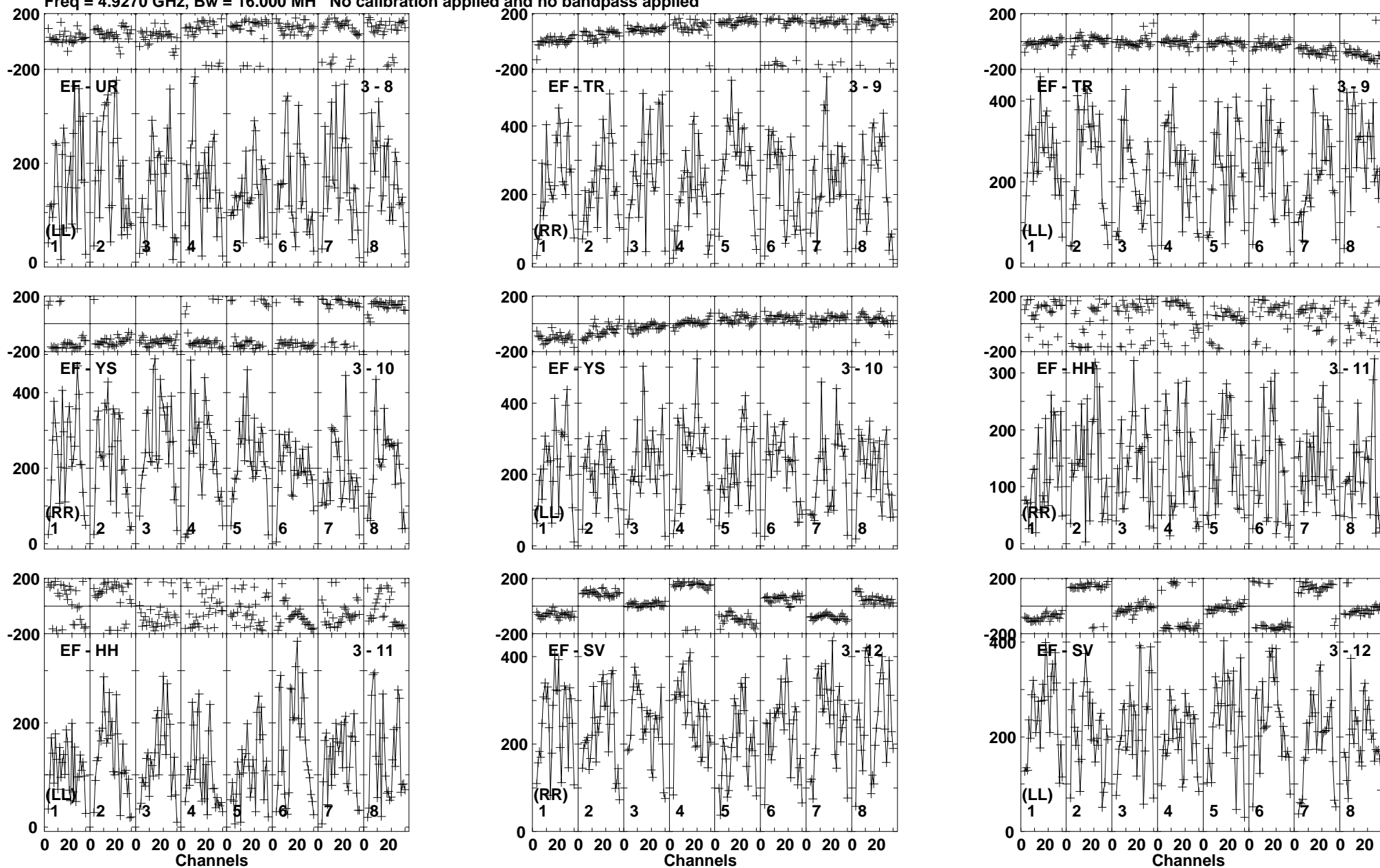

Lower frame: Micro Ampl Jy Top frame: Phas deg  
Vector averaged cross-power spectrum Baseline: EF (03) - UR (08)  
Timerange: 00/09:15:01 to 00/09:16:59

Plot file version 120 created 19-DEC-2018 17:58:20

VLA1 RY007C.UVDATA.1

Freq = 4.9270 GHz, Bw = 16.000 MH No calibration applied and no bandpass applied

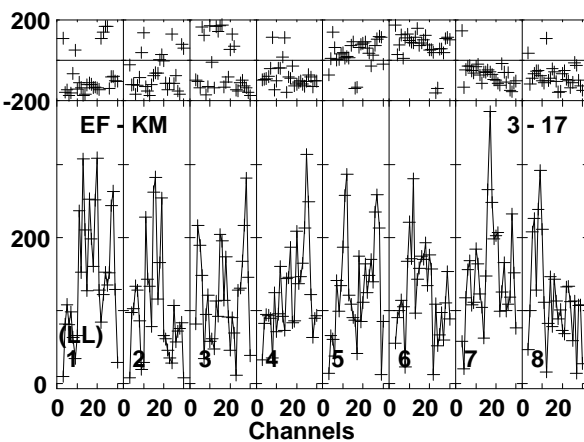
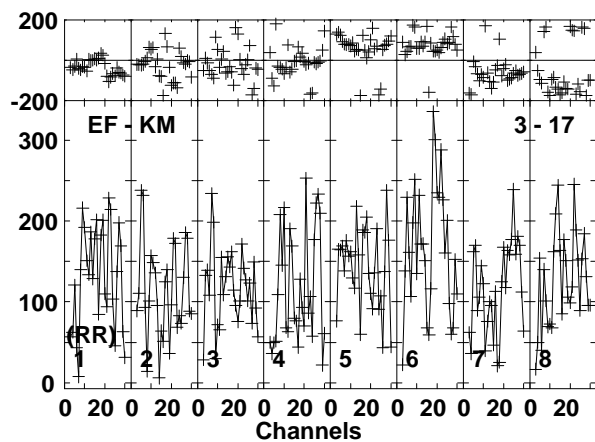
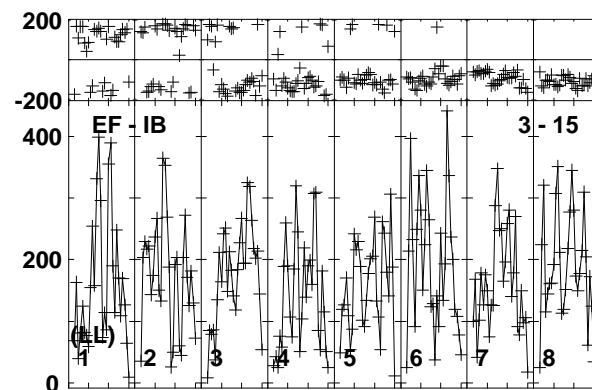
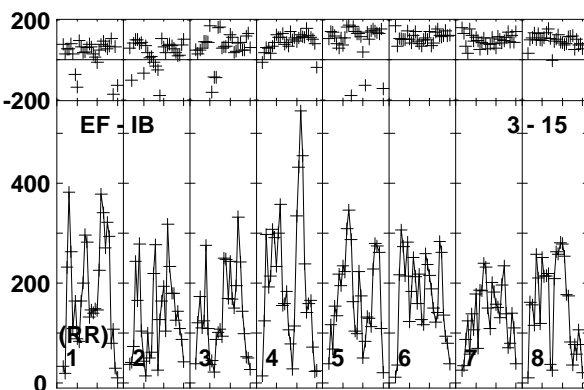
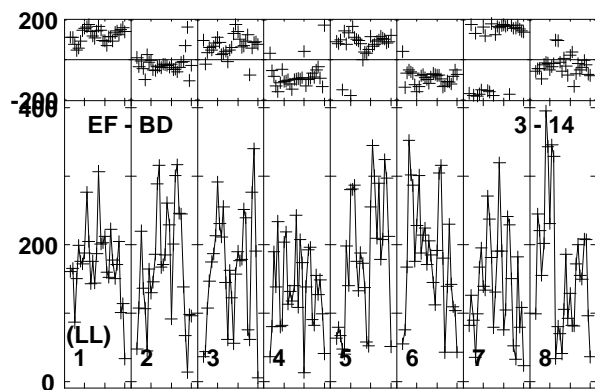
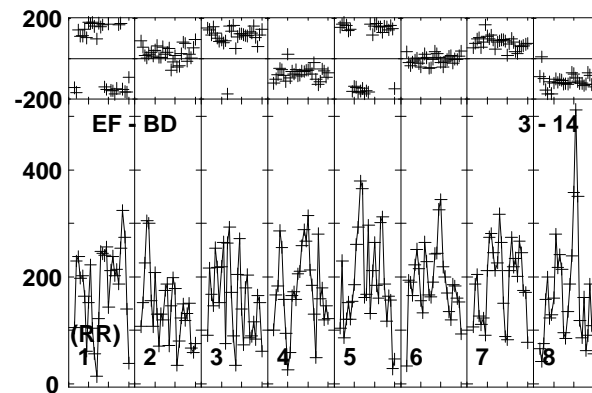
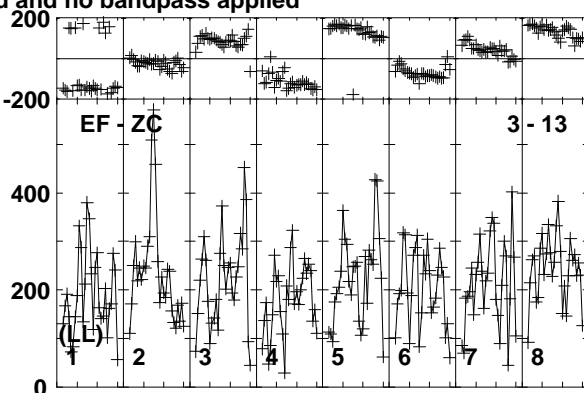
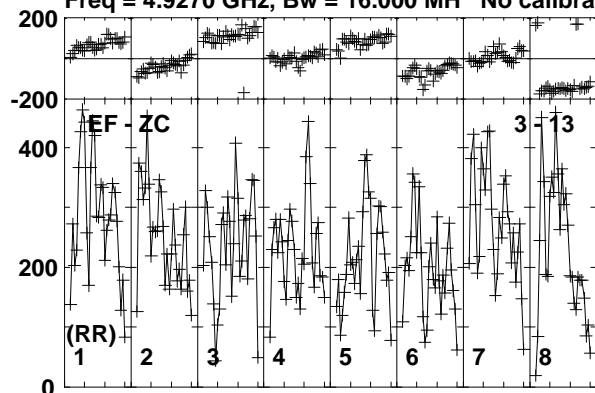

Lower frame: Micro Ampl Jy Top frame: Phas deg  
Vector averaged cross-power spectrum Baseline: EF (03) - ZC (13)  
Timerange: 00/09:15:01 to 00/09:16:59

Plot file version 121 created 19-DEC-2018 17:58:20

J1619+2247 RY007C.UVDATA.1

Freq = 4.9270 GHz, Bw = 16.000 MH No calibration applied and no bandpass applied

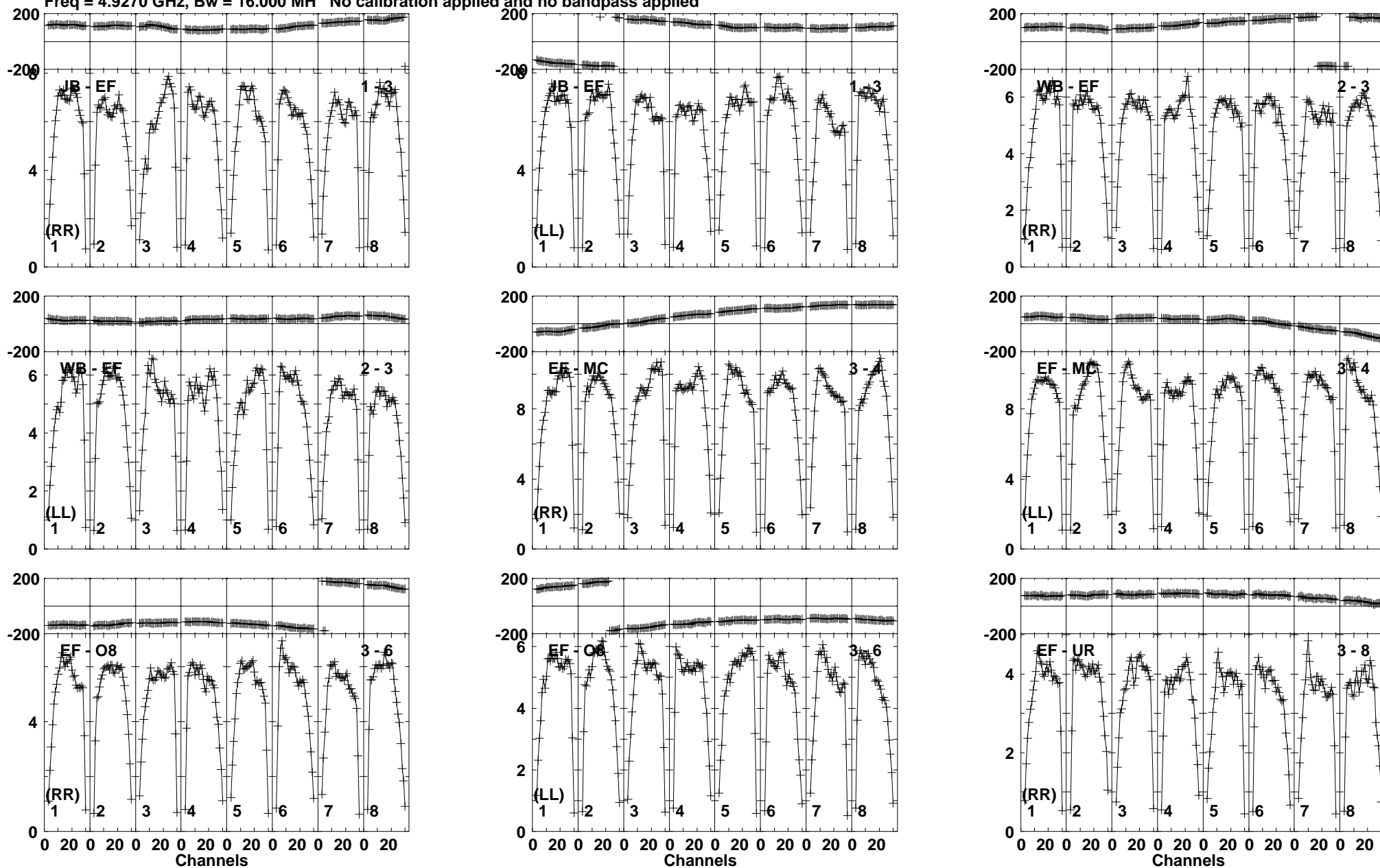

Lower frame: Milli Ampl Jy Top frame: Phas deg  
Vector averaged cross-power spectrum Baseline: JB (01) - EF (03)  
Timerange: 00/09:17:01 to 00/09:17:59

Plot file version 122 created 19-DEC-2018 17:58:20

J1619+2247 RY007C.UVDATA.1

Freq = 4.9270 GHz, Bw = 16.000 MH No calibration applied and no bandpass applied

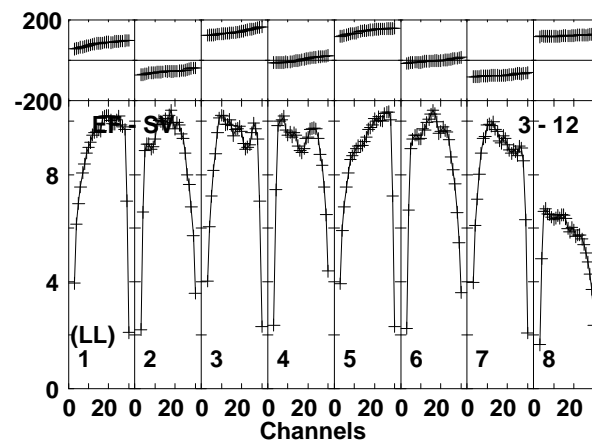
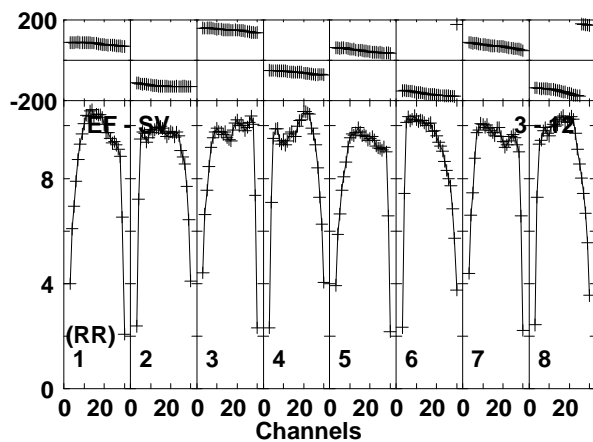
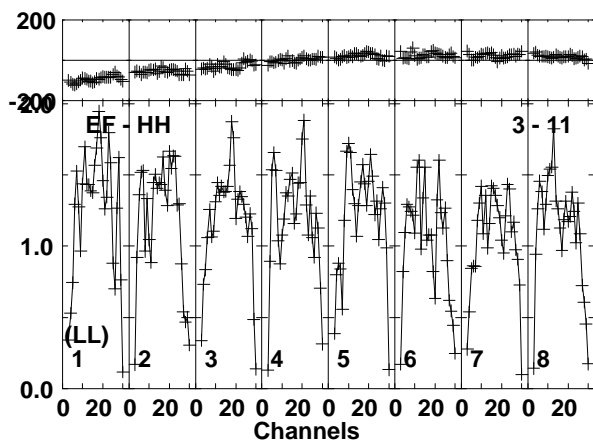
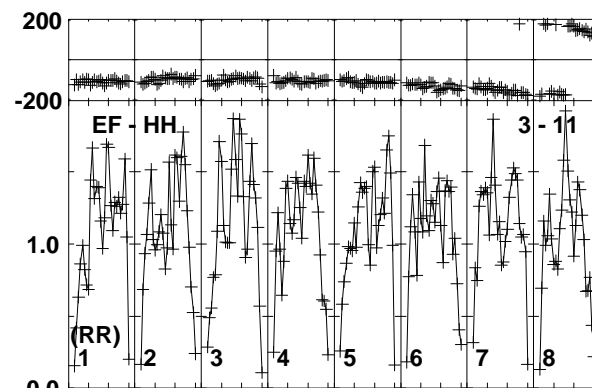
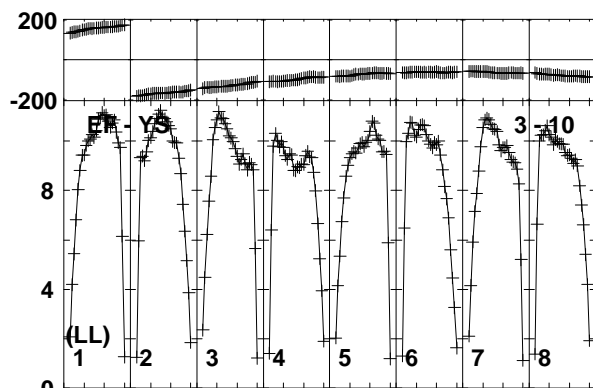
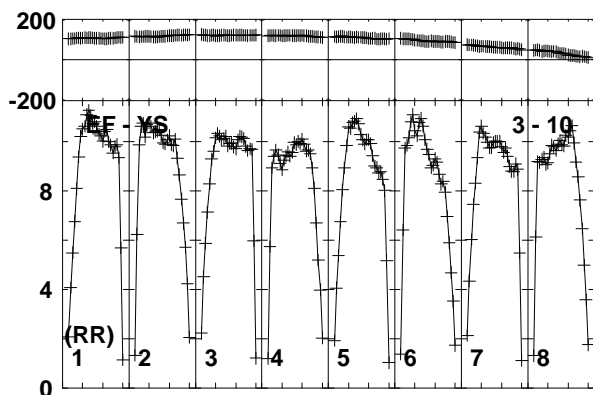
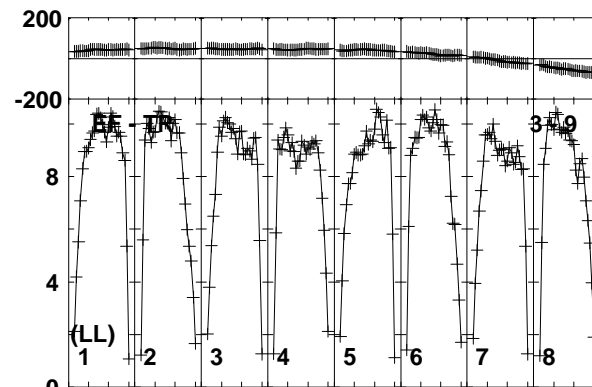
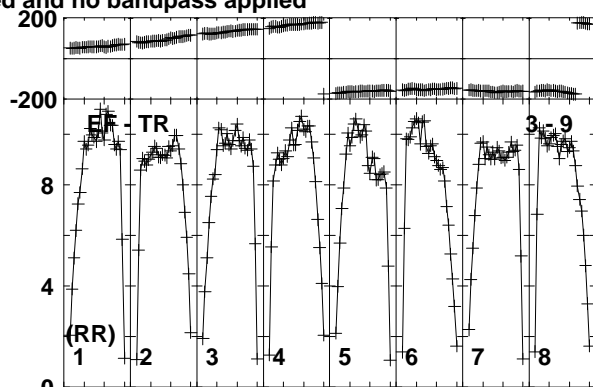
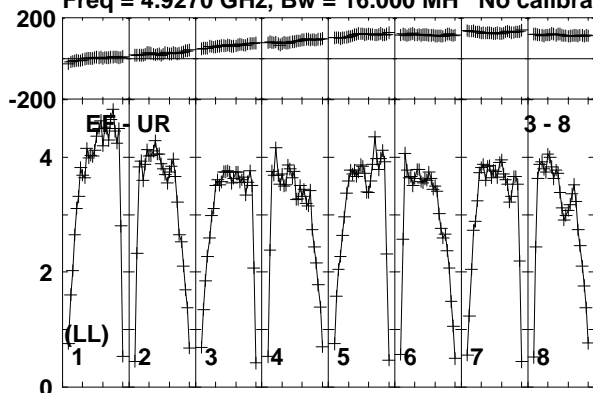

Lower frame: Milli Ampl Jy Top frame: Phas deg  
Vector averaged cross-power spectrum Baseline: EF (03) - UR (08)  
Timerange: 00/09:17:01 to 00/09:17:59



Plot file version 123 created 19-DEC-2018 17:58:20

J1619+2247 RY007C.UVDATA.1

Freq = 4.9270 GHz, Bw = 16.000 MH No calibration applied and no bandpass applied

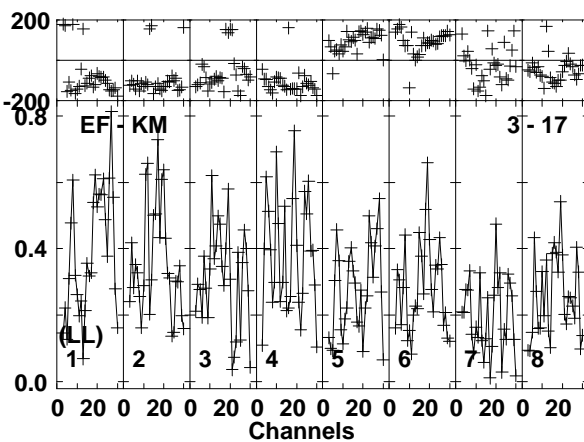
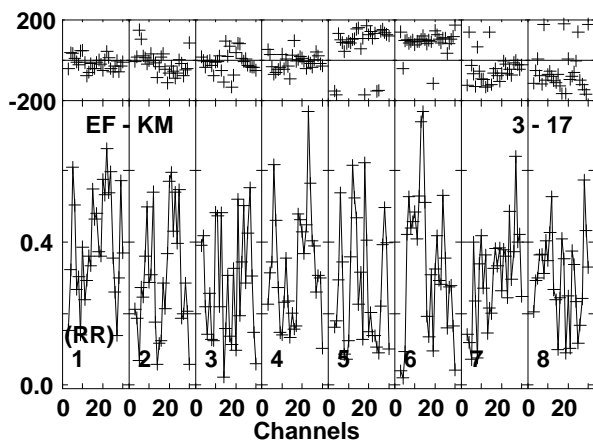
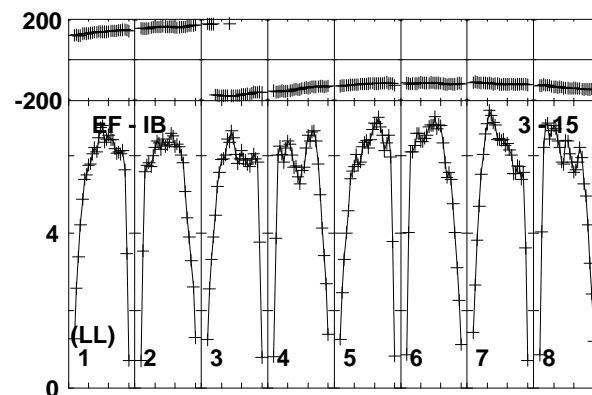
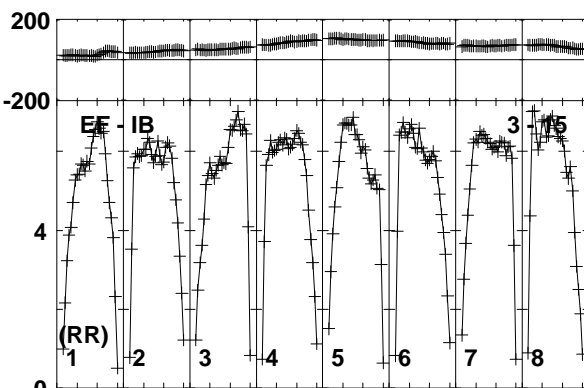
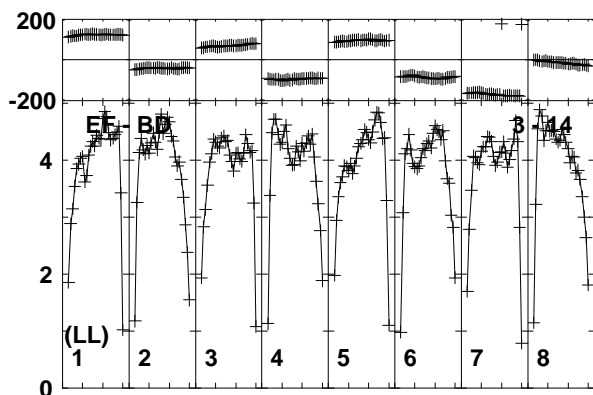
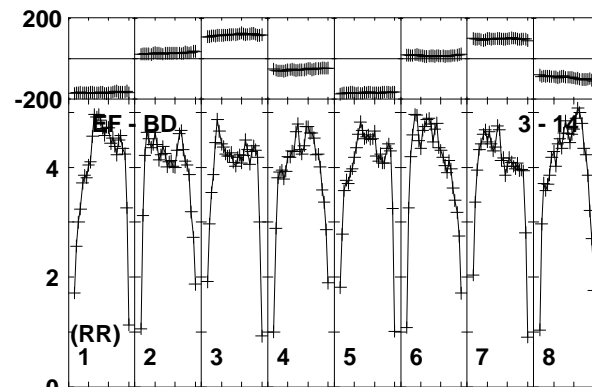
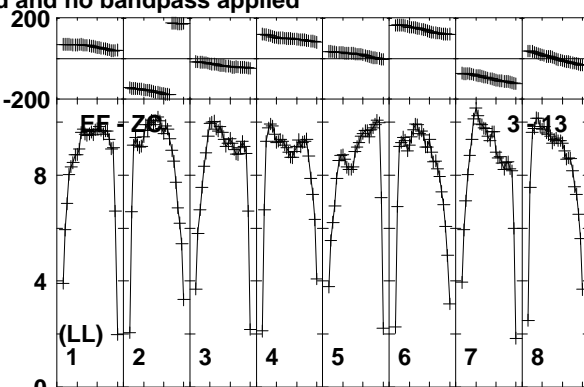
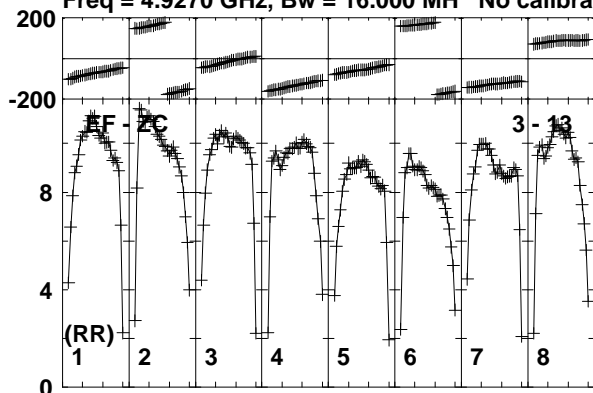

Lower frame: Milli Ampl Jy Top frame: Phas deg

Vector averaged cross-power spectrum Baseline: EF (03) - ZC (13)

Timerange: 00/09:17:01 to 00/09:17:59

Plot file version 124 created 19-DEC-2018 17:58:20

AT2018\_RY007C.UVDATA.1

Freq = 4.9270 GHz, Bw = 16.000 MH No calibration applied and no bandpass applied

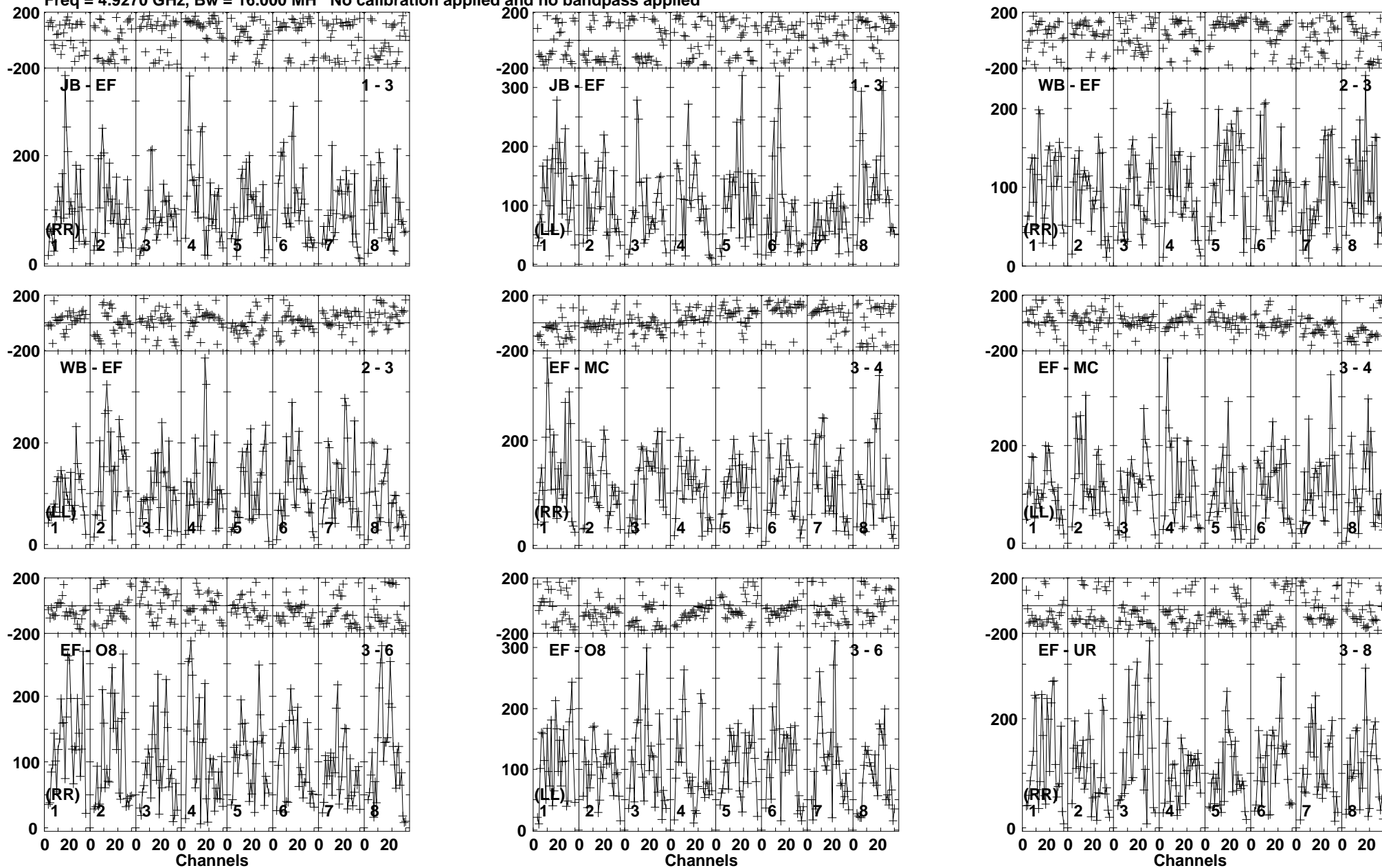

Lower frame: Micro Ampl Jy Top frame: Phas deg  
Vector averaged cross-power spectrum Baseline: JB (01) - EF (03)  
Timerange: 00/09:18:01 to 00/09:20:59

Plot file version 125 created 19-DEC-2018 17:58:21

AT2018\_RY007C.UVDATA.1

Freq = 4.9270 GHz, Bw = 16.000 MH No calibration applied and no bandpass applied

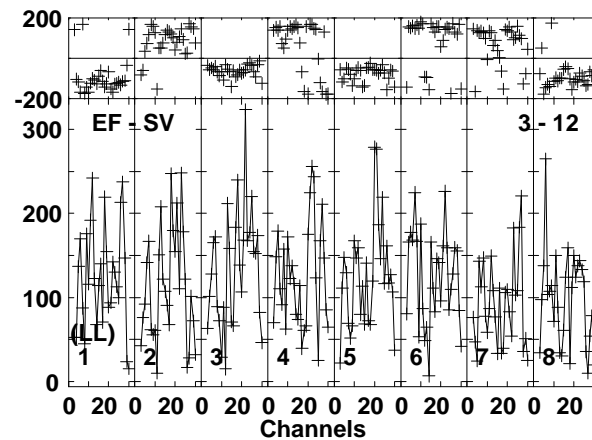
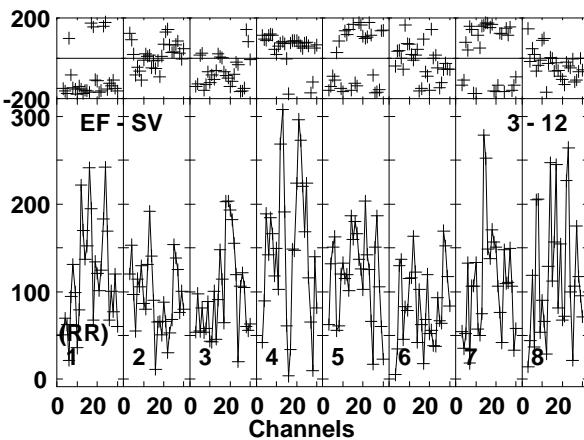
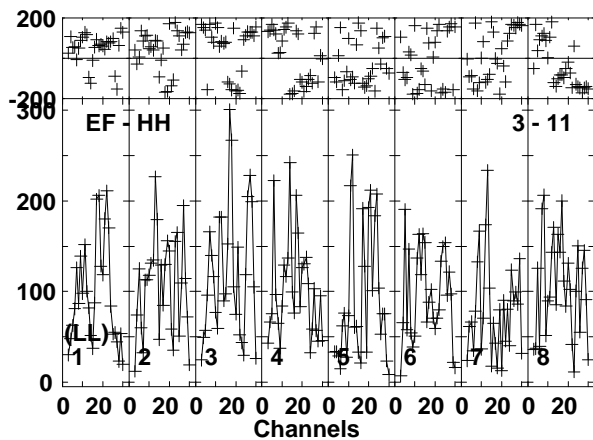
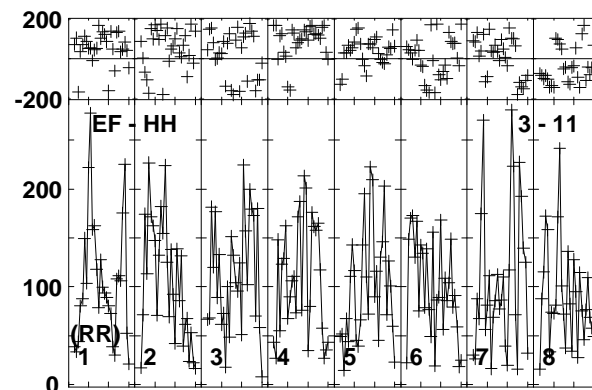
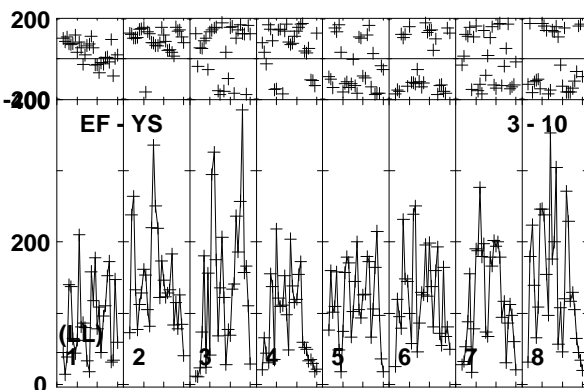
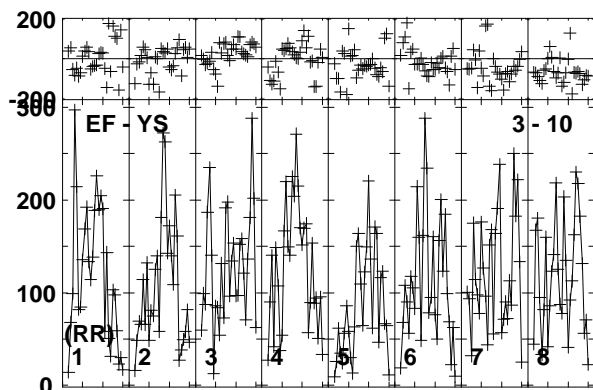
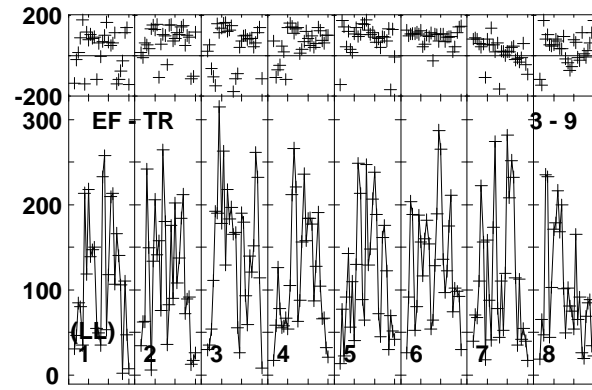
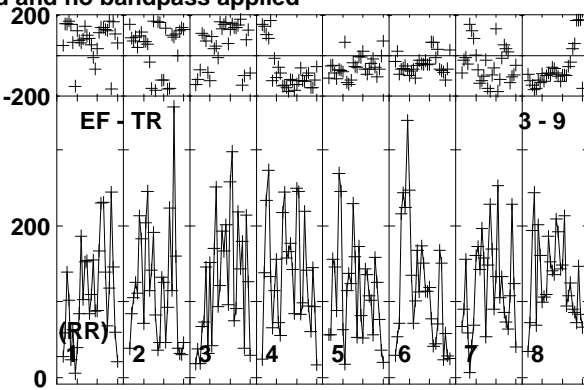
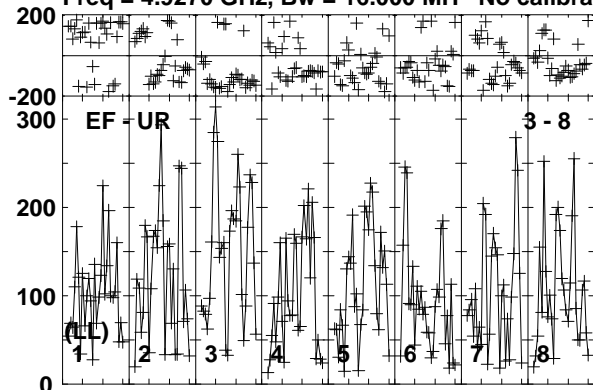

Lower frame: Micro Ampl Jy Top frame: Phas deg  
Vector averaged cross-power spectrum Baseline: EF (03) - UR (08)  
Timerange: 00/09:18:01 to 00/09:20:59

Plot file version 126 created 19-DEC-2018 17:58:21  
AT2018\_RY007C.UVDATA.1

Freq = 4.9270 GHz, Bw = 16.000 MH No calibration applied and no bandpass applied

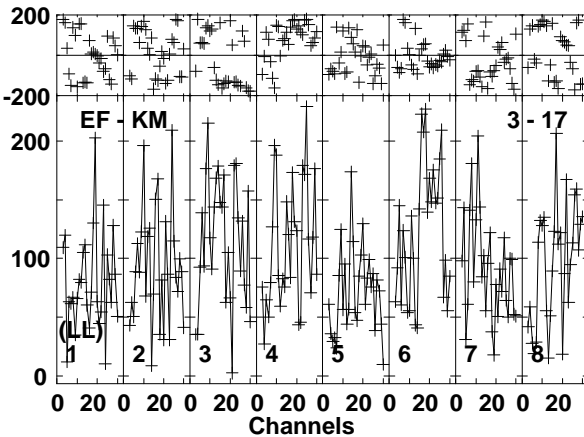
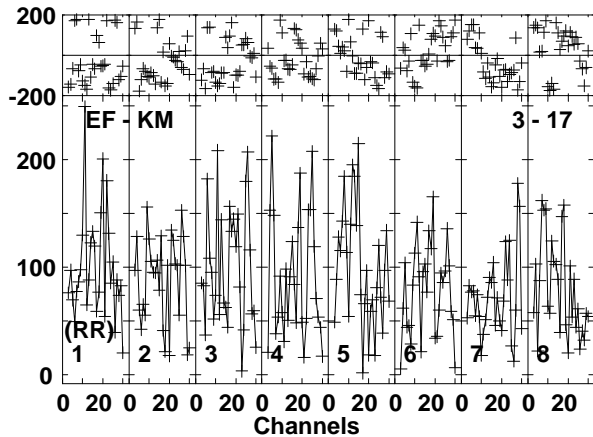
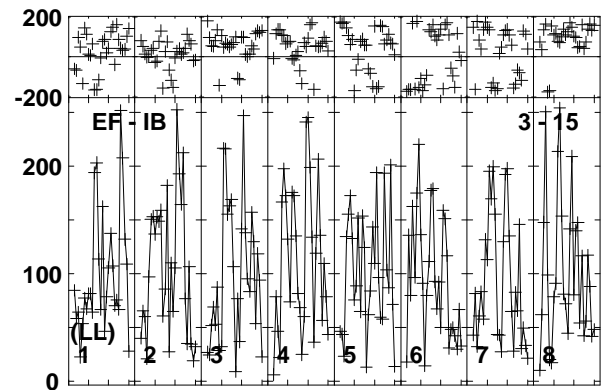
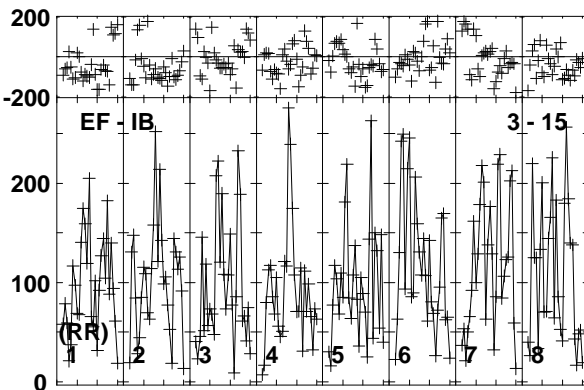
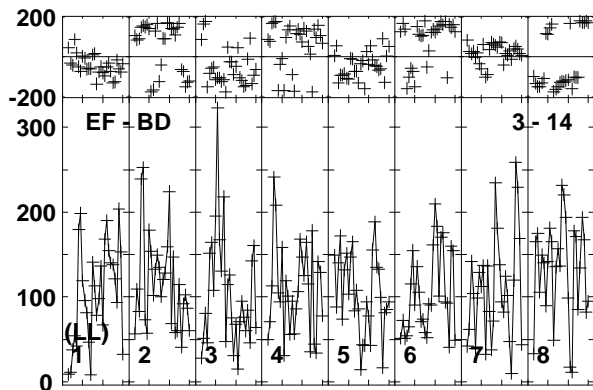
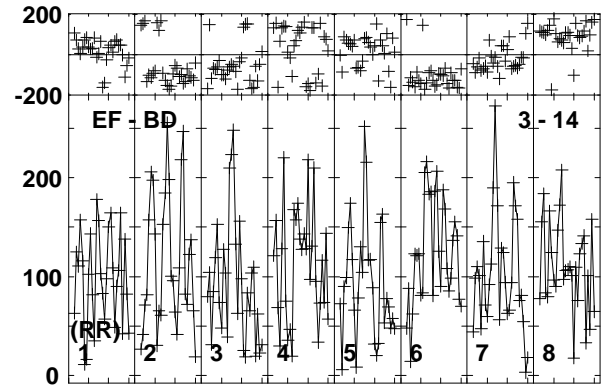
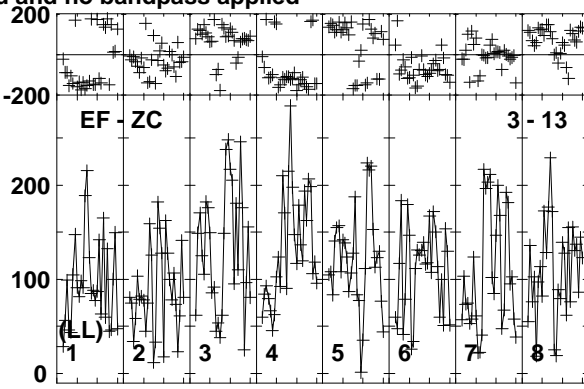
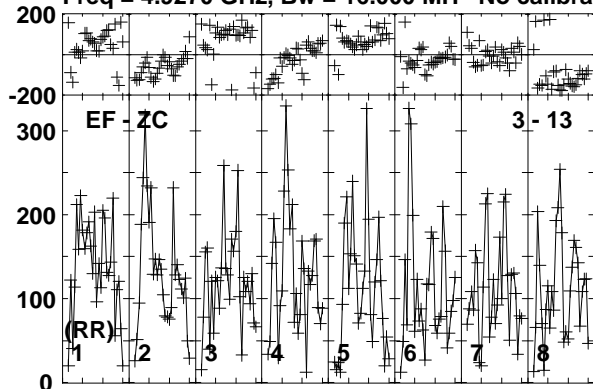

Lower frame: Micro Ampl Jy Top frame: Phas deg  
Vector averaged cross-power spectrum Baseline: EF (03) - ZC (13)  
Timerange: 00/09:18:01 to 00/09:20:59

Plot file version 127 created 19-DEC-2018 17:58:21

J1619+2247 RY007C.UVDATA.1

Freq = 4.9270 GHz, Bw = 16.000 MH No calibration applied and no bandpass applied

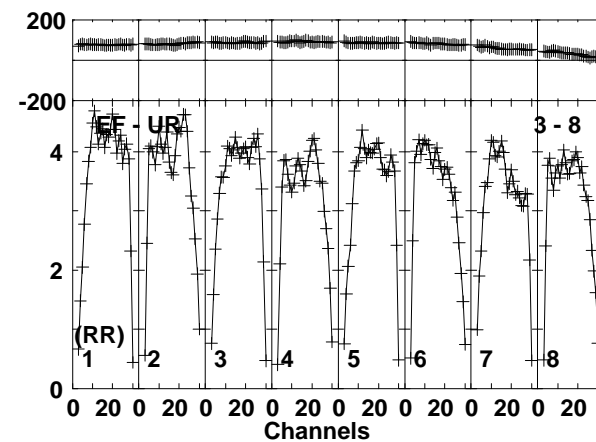
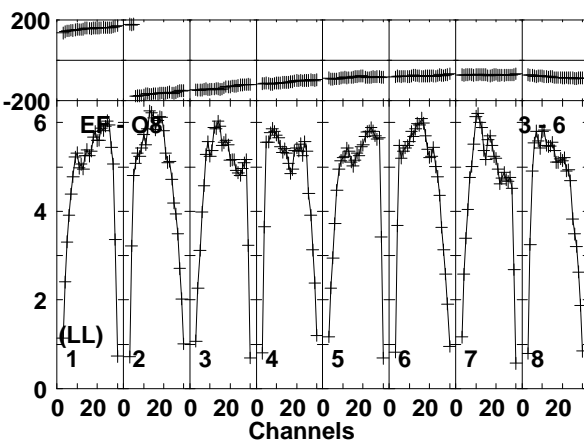
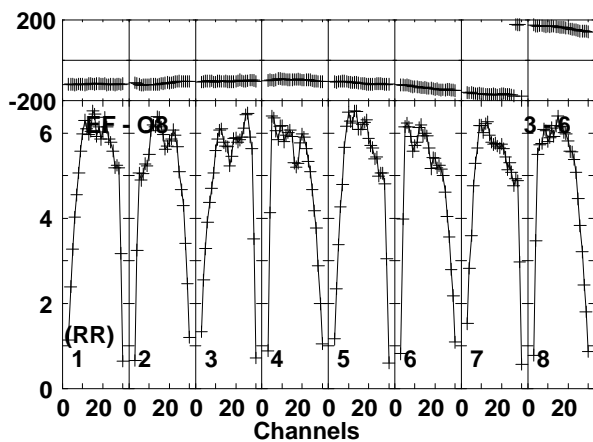
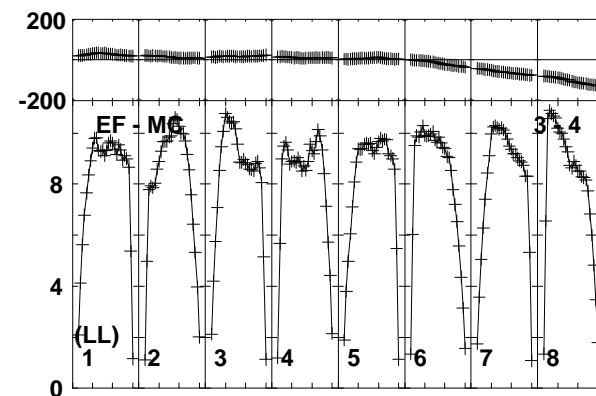
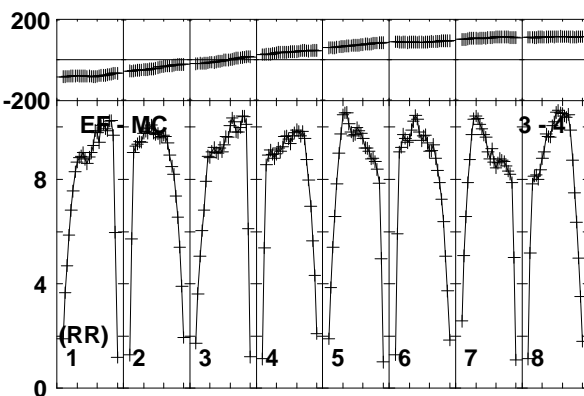
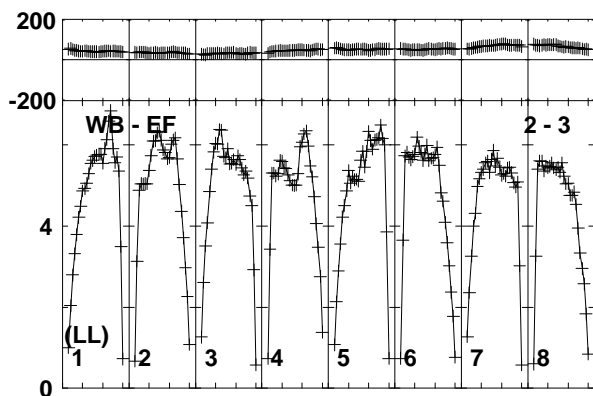
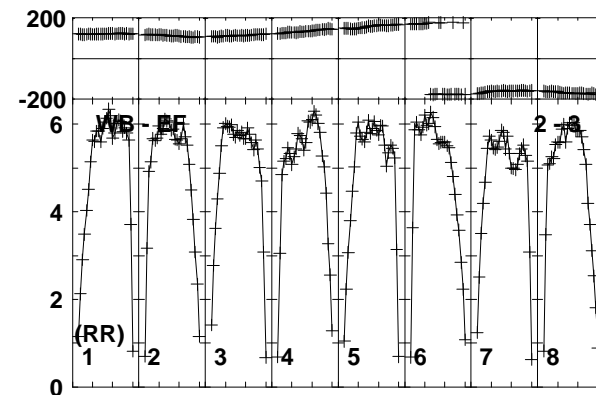
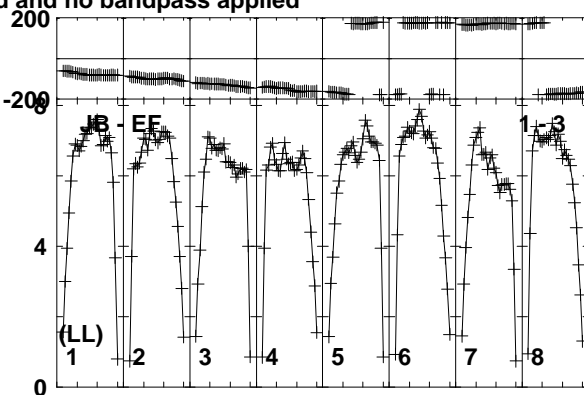
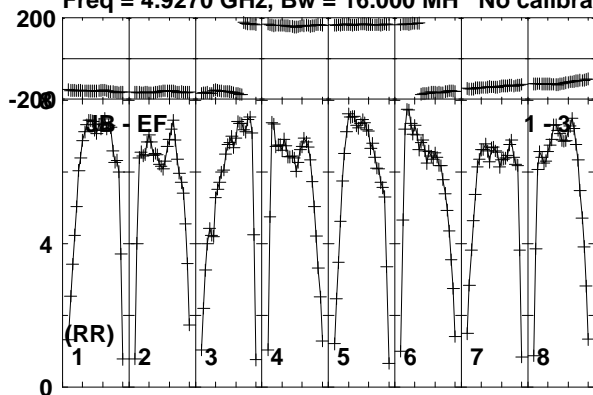

Lower frame: Milli Ampl Jy Top frame: Phas deg  
Vector averaged cross-power spectrum Baseline: JB (01) - EF (03)  
Timerange: 00/09:21:01 to 00/09:21:59

Plot file version 128 created 19-DEC-2018 17:58:21

J1619+2247 RY007C.UVDATA.1

Freq = 4.9270 GHz, Bw = 16.000 MH No calibration applied and no bandpass applied

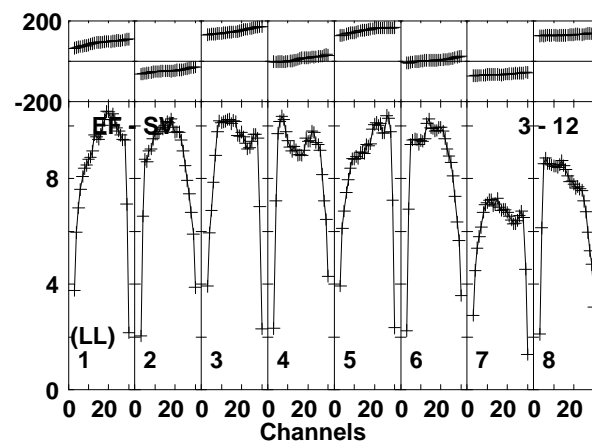
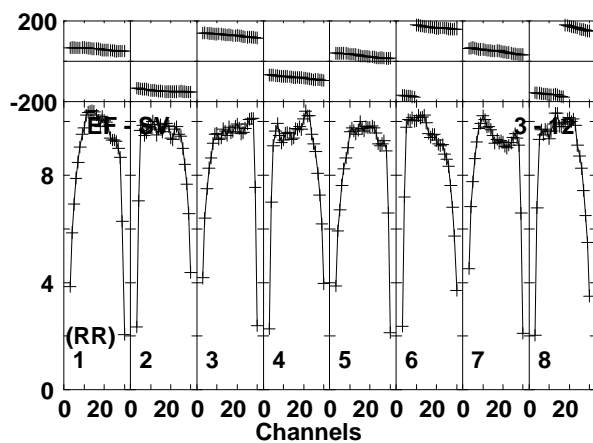
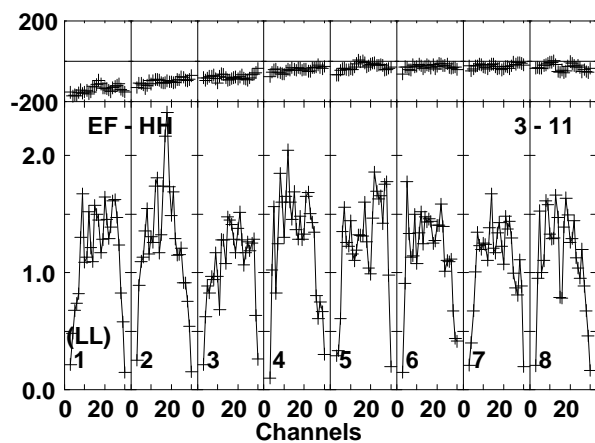
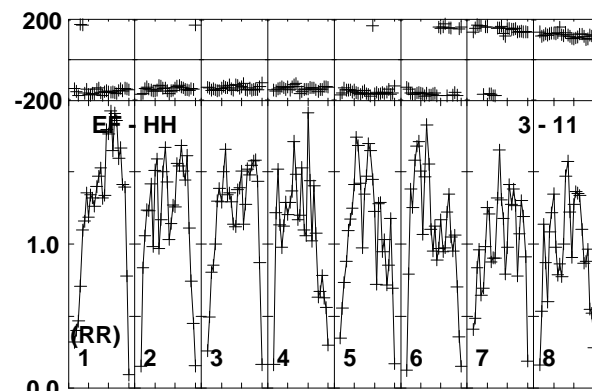
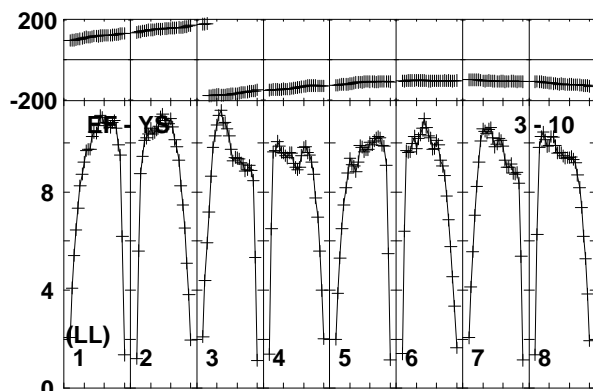
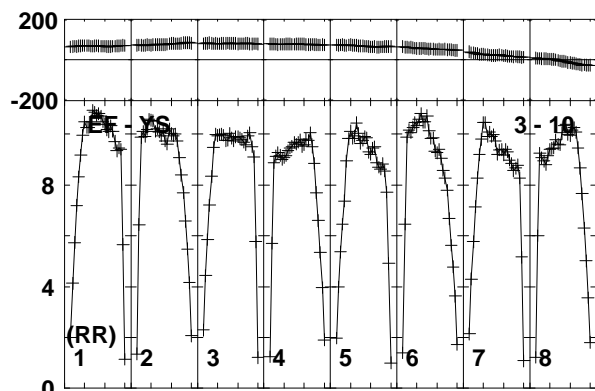
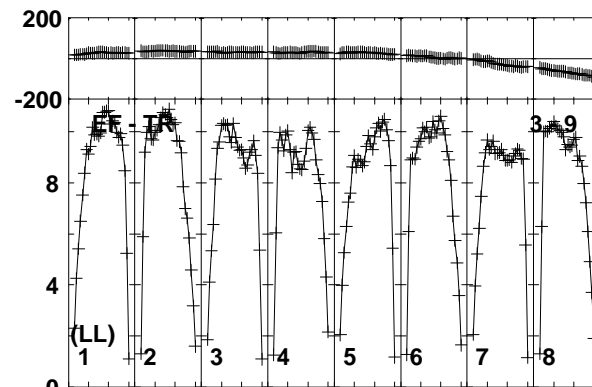
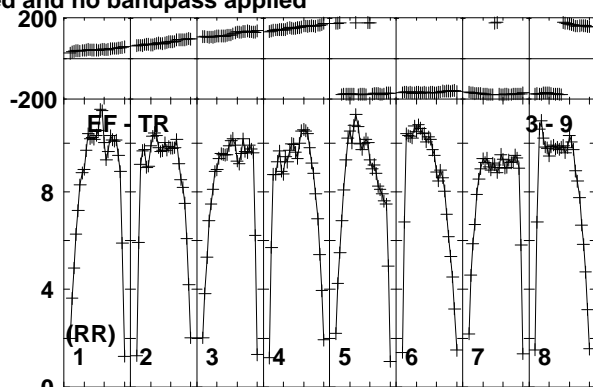
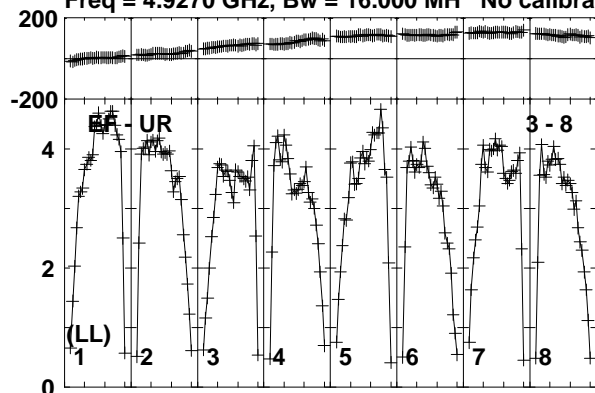

Lower frame: Milli Ampl Jy Top frame: Phas deg  
Vector averaged cross-power spectrum Baseline: EF (03) - UR (08)  
Timerange: 00/09:21:01 to 00/09:21:59

Plot file version 129 created 19-DEC-2018 17:58:21

J1619+2247 RY007C.UVDATA.1

Freq = 4.9270 GHz, Bw = 16.000 MH No calibration applied and no bandpass applied

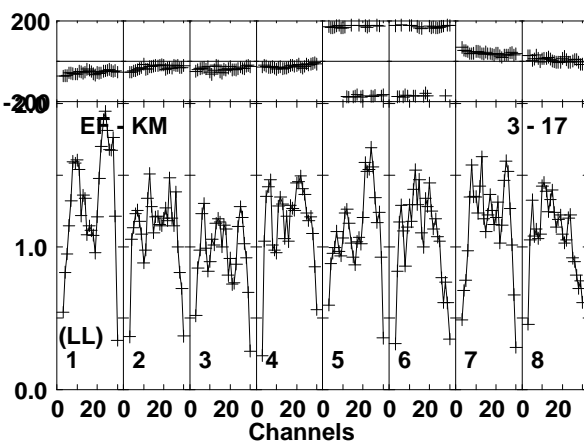
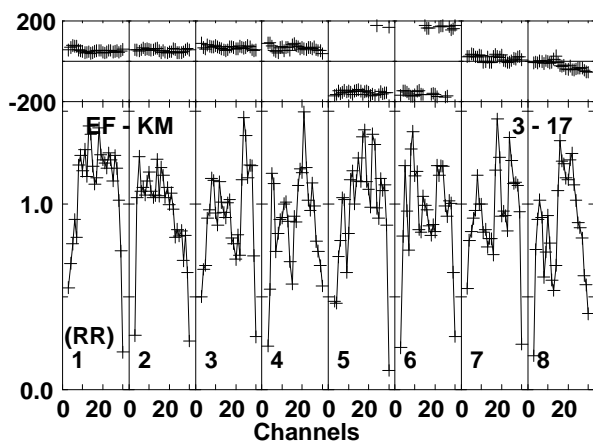
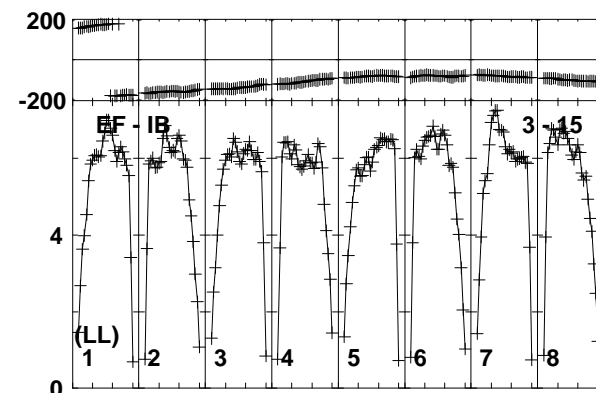
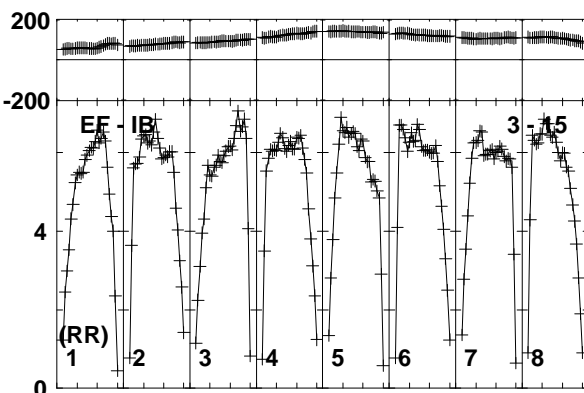
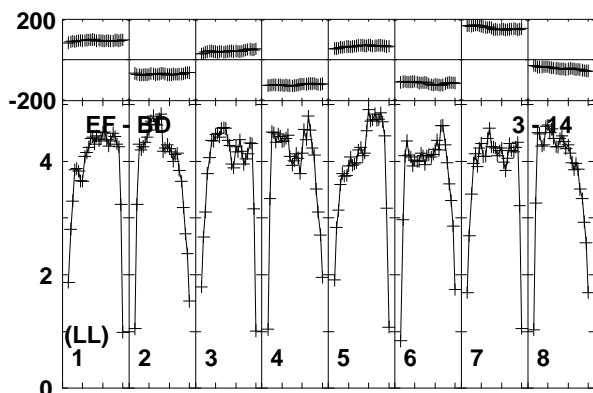
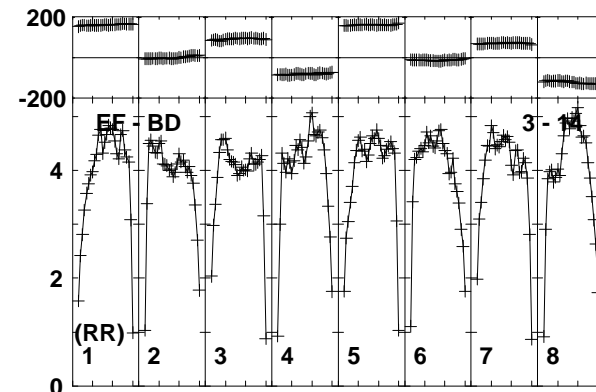
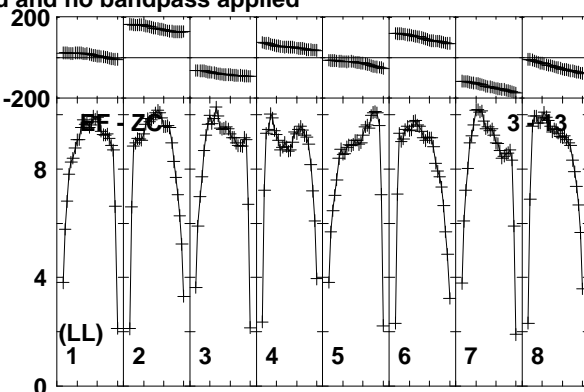
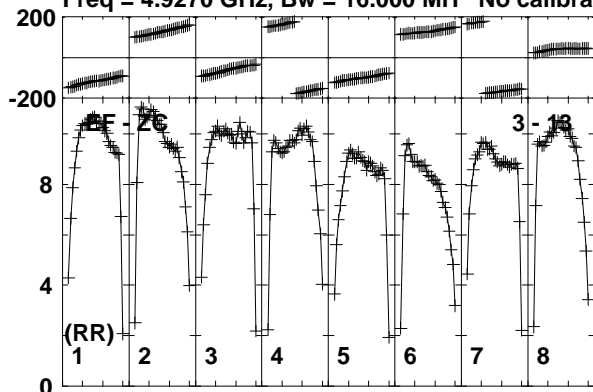

Lower frame: Milli Ampl Jy Top frame: Phas deg  
Vector averaged cross-power spectrum Baseline: EF (03) - ZC (13)  
Timerange: 00/09:21:01 to 00/09:21:59

Plot file version 130 created 19-DEC-2018 17:58:21  
AT2018\_RY007C.UVDATA.1

Freq = 4.9270 GHz, Bw = 16.000 MH No calibration applied and no bandpass applied

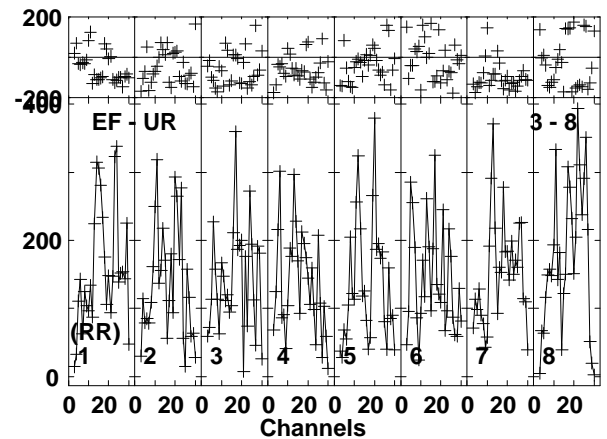
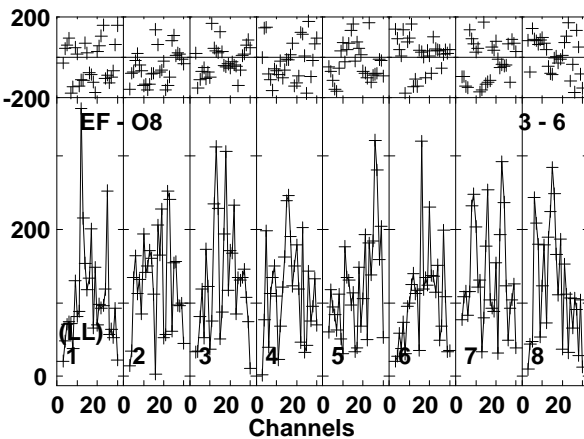
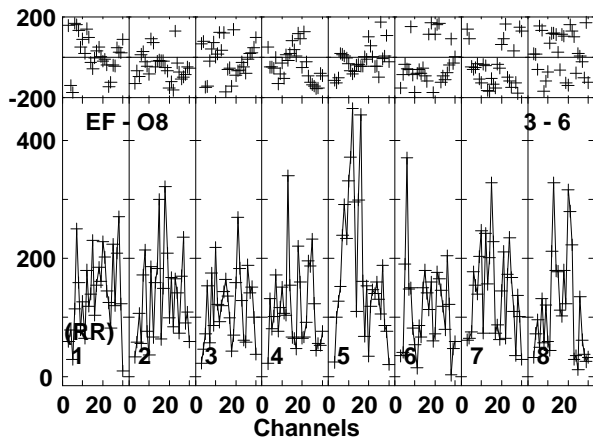
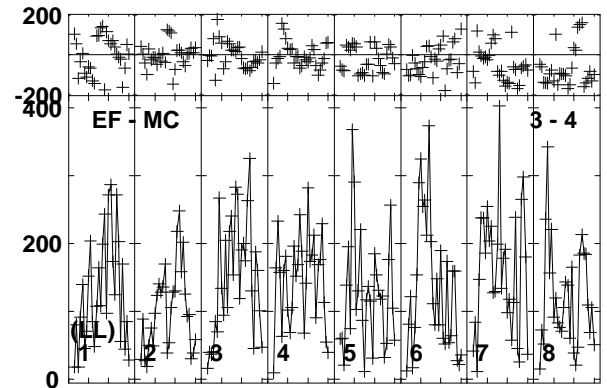
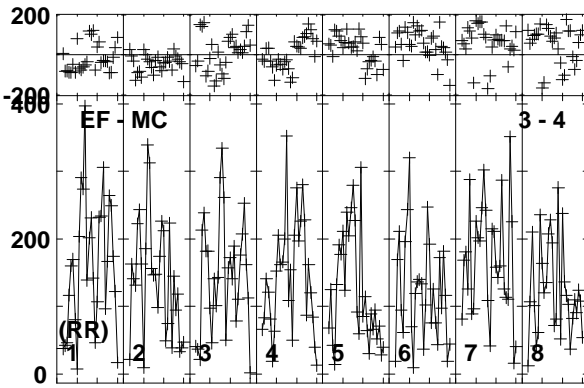
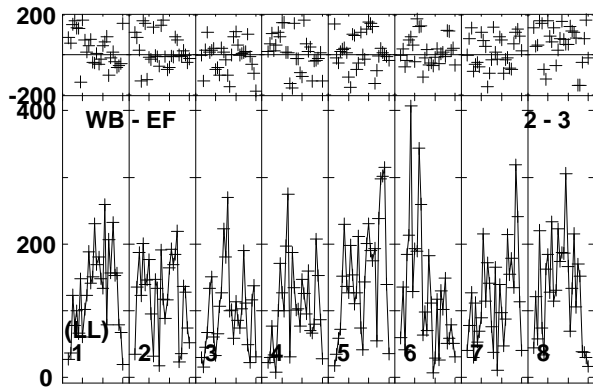
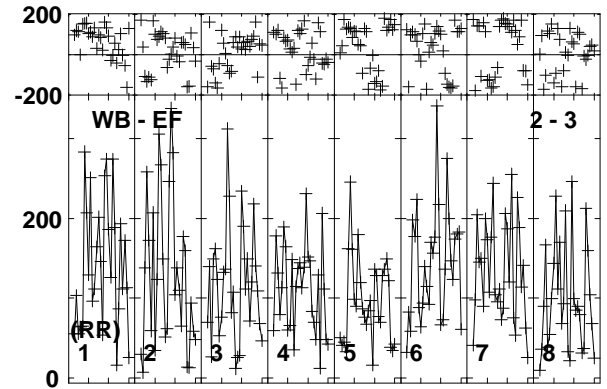
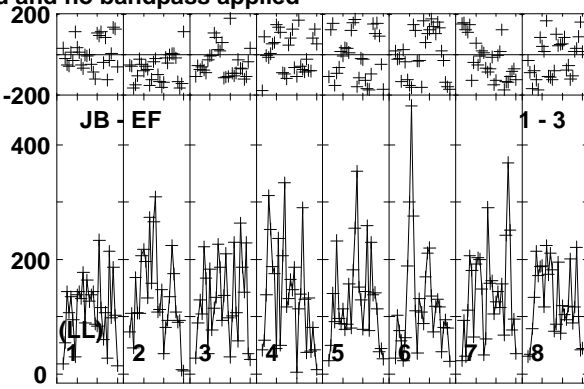
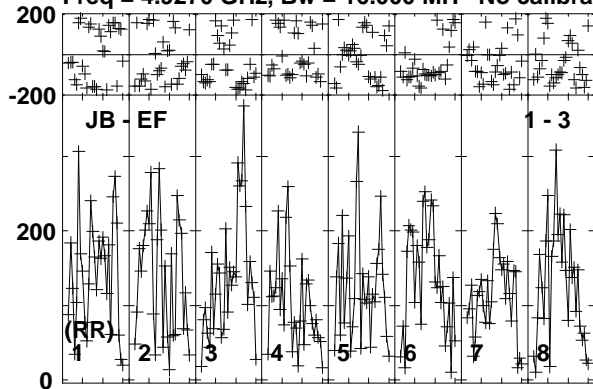

Lower frame: Micro Ampl Jy Top frame: Phas deg  
Vector averaged cross-power spectrum Baseline: JB (01) - EF (03)  
Timerange: 00/09:22:01 to 00/09:23:59



Plot file version 131 created 19-DEC-2018 17:58:21

AT2018\_RY007C.UVDATA.1

Freq = 4.9270 GHz, Bw = 16.000 MH No calibration applied and no bandpass applied

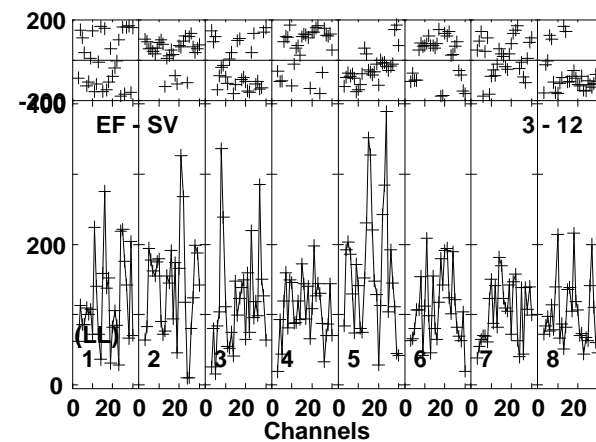
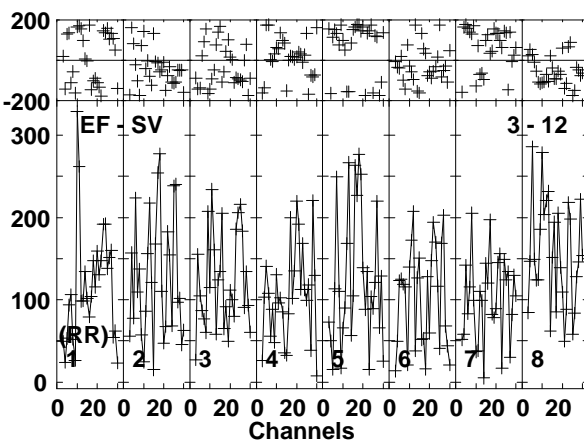
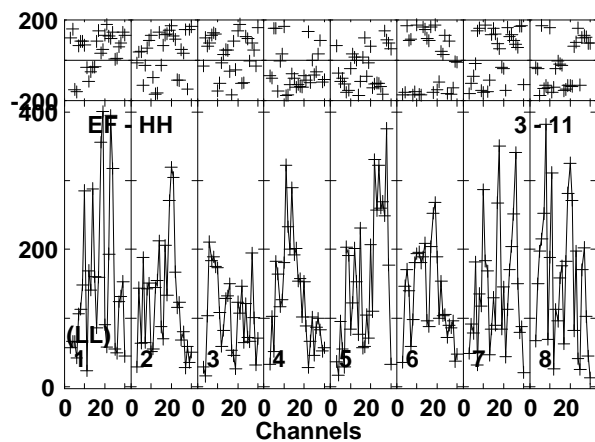
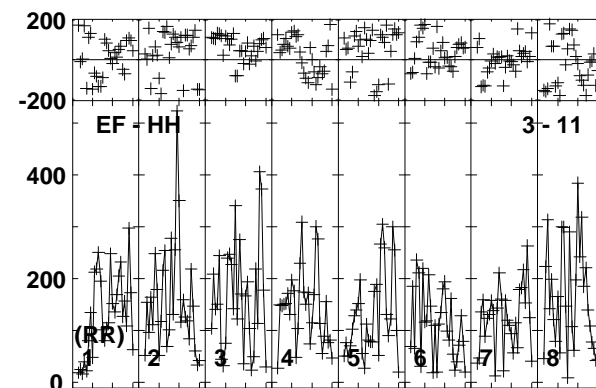
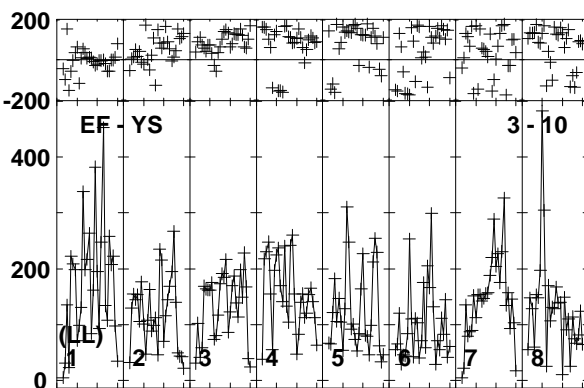
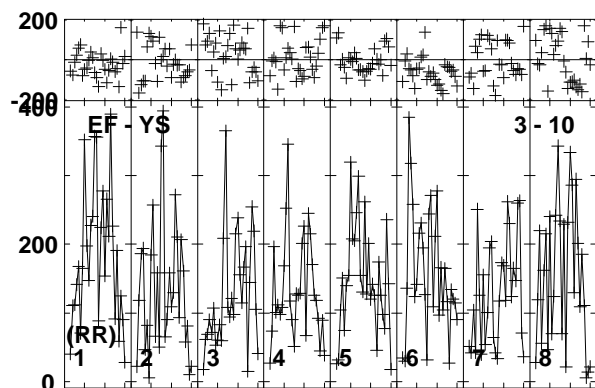
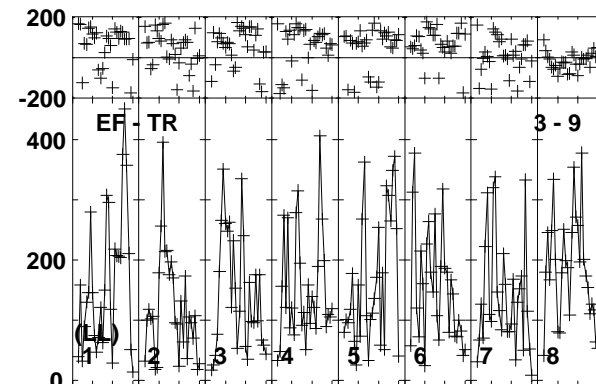
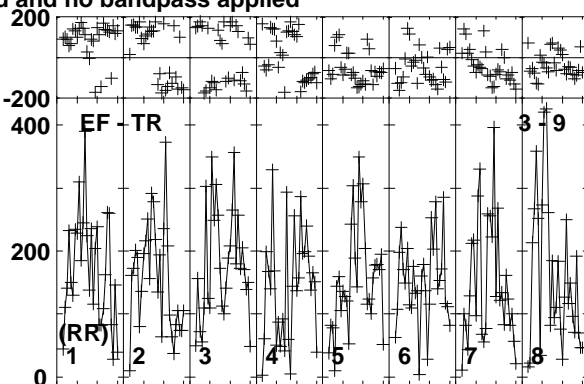
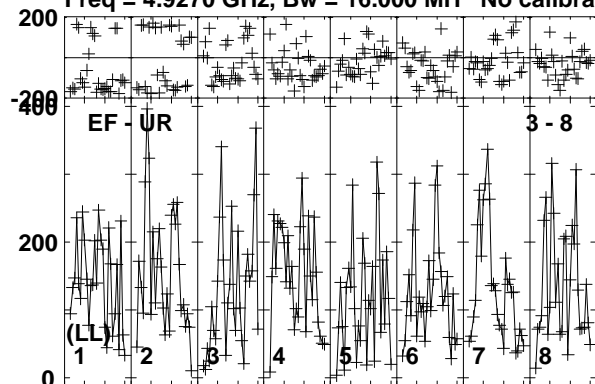

Lower frame: Micro Ampl Jy Top frame: Phas deg  
Vector averaged cross-power spectrum Baseline: EF (03) - UR (08)  
Timerange: 00/09:22:01 to 00/09:23:59

Plot file version 132 created 19-DEC-2018 17:58:21

AT2018\_RY007C.UVDATA.1

Freq = 4.9270 GHz, Bw = 16.000 MH No calibration applied and no bandpass applied

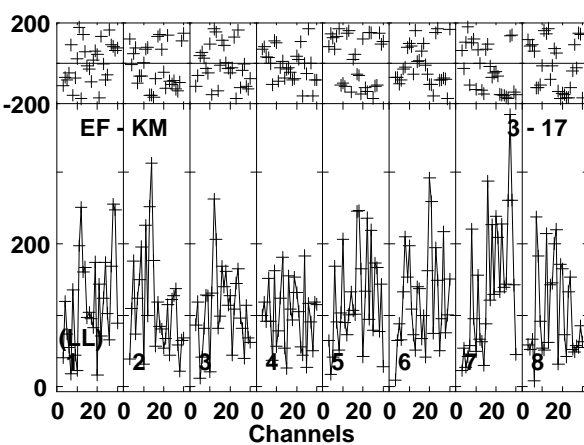
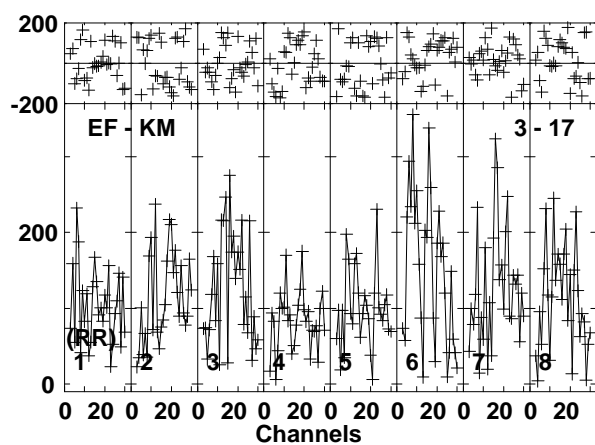
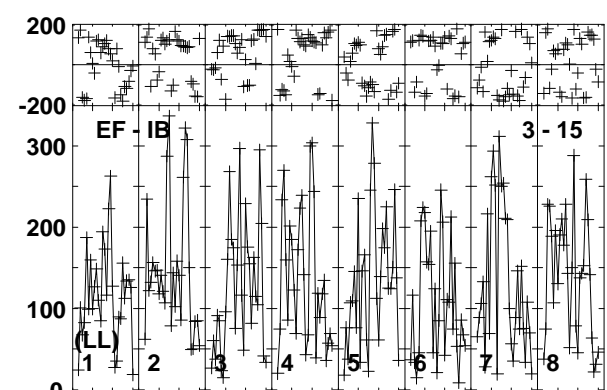
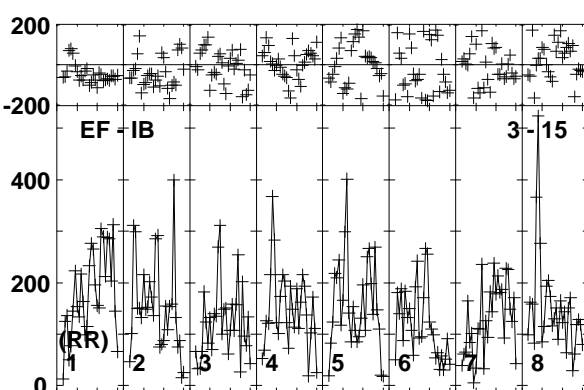
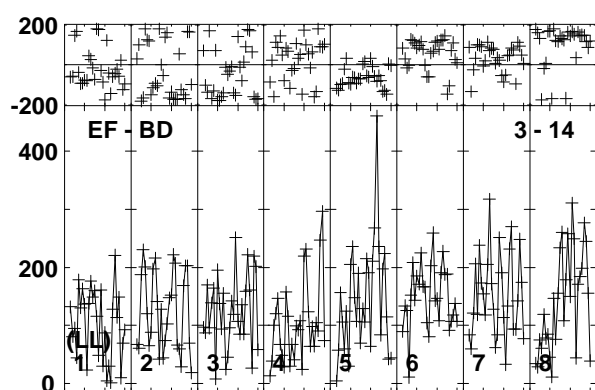
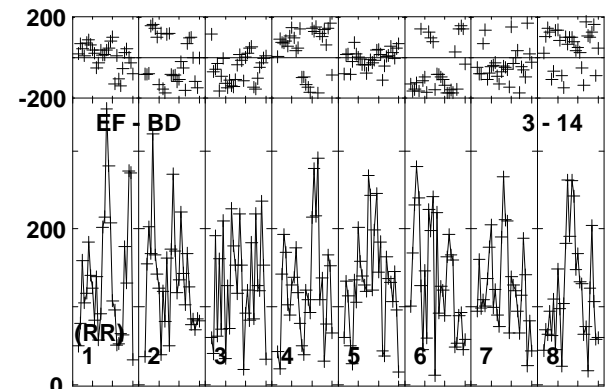
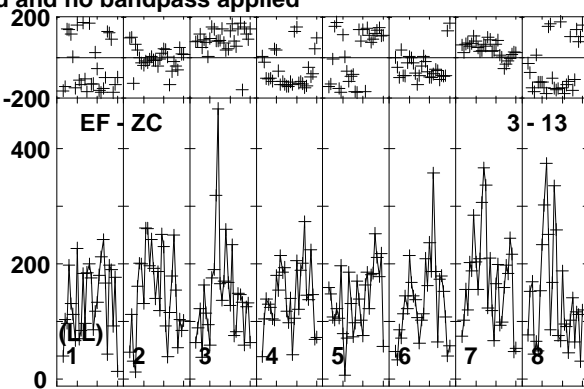
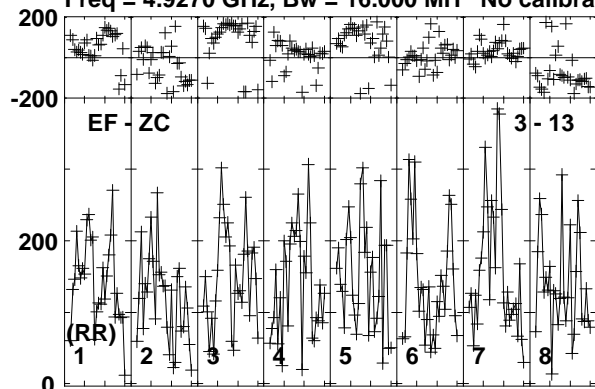

Lower frame: Micro Ampl Jy Top frame: Phas deg  
Vector averaged cross-power spectrum Baseline: EF (03) - ZC (13)  
Timerange: 00/09:22:01 to 00/09:23:59

Plot file version 133 created 19-DEC-2018 17:58:21

VLA2 RY007C.UVDATA.1

Freq = 4.9270 GHz, Bw = 16.000 MH No calibration applied and no bandpass applied

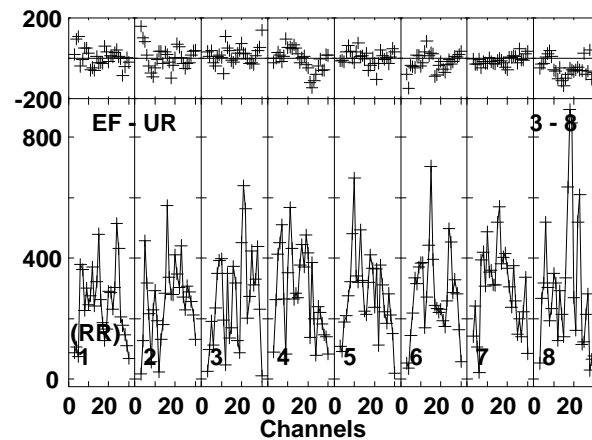
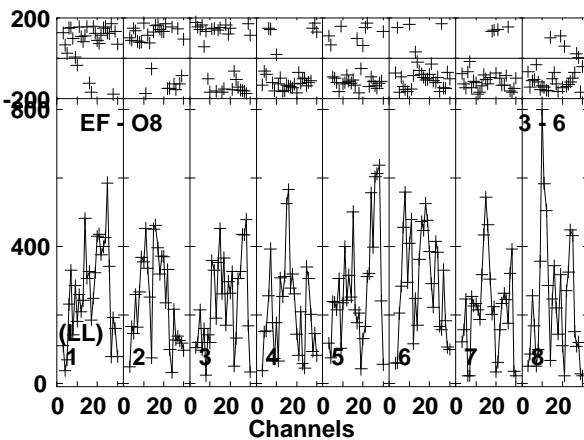
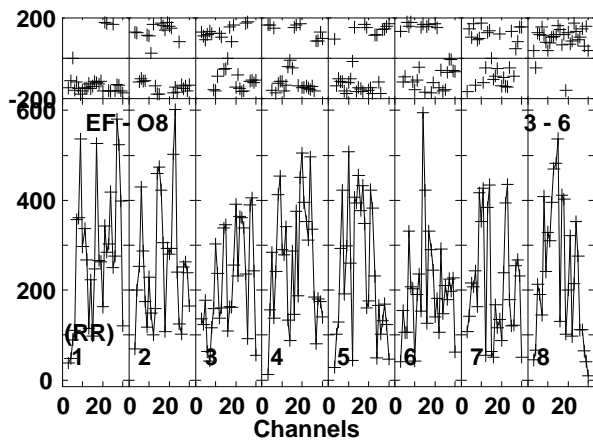
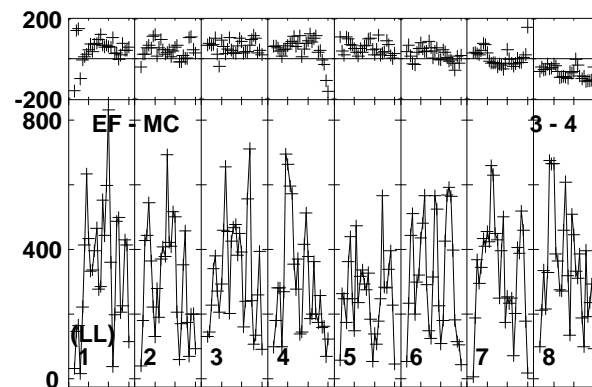
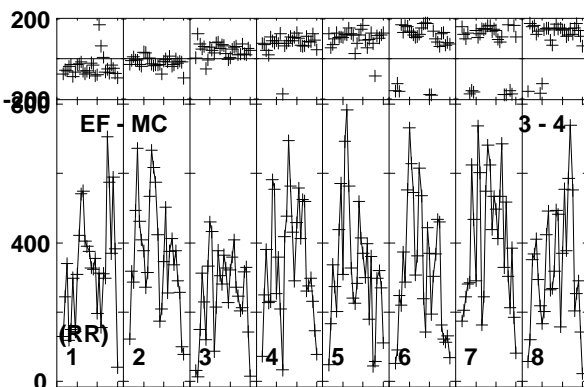
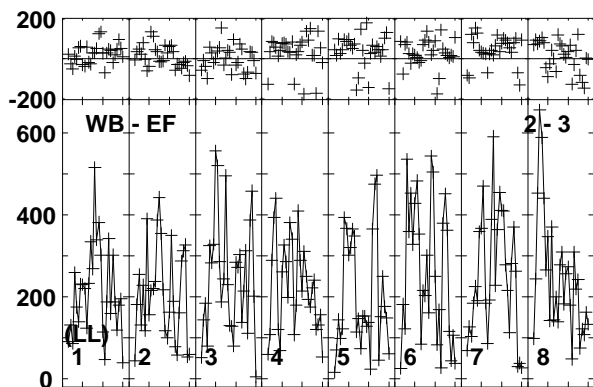
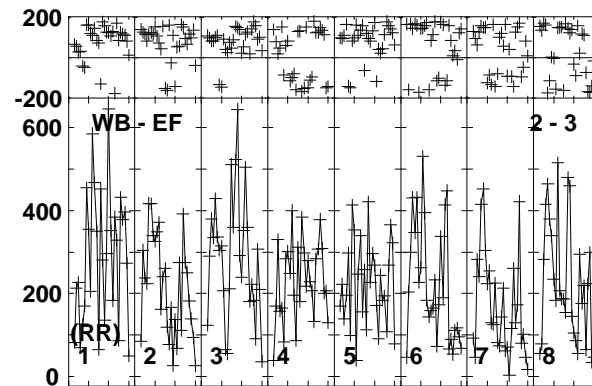
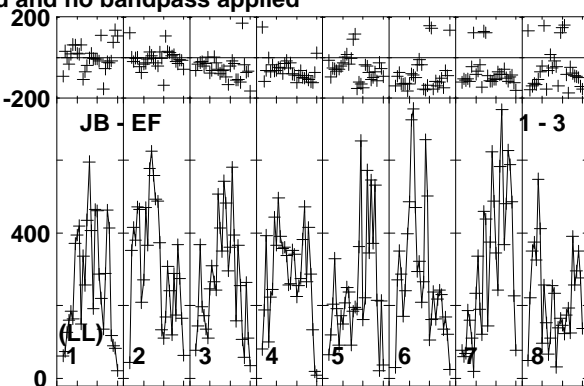
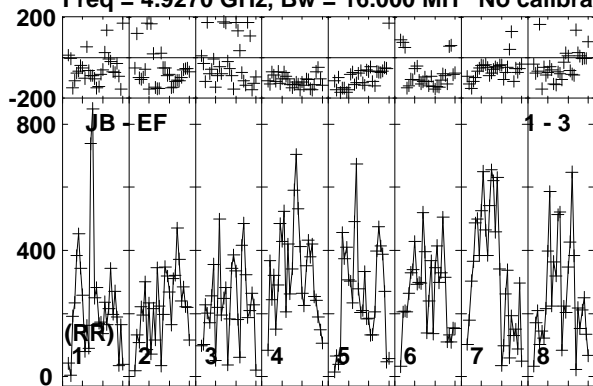

Lower frame: Micro Ampl Jy Top frame: Phas deg  
Vector averaged cross-power spectrum Baseline: JB (01) - EF (03)  
Timerange: 00/09:24:01 to 00/09:24:59

Plot file version 134 created 19-DEC-2018 17:58:21

VLA2 RY007C.UVDATA.1

Freq = 4.9270 GHz, Bw = 16.000 MH No calibration applied and no bandpass applied

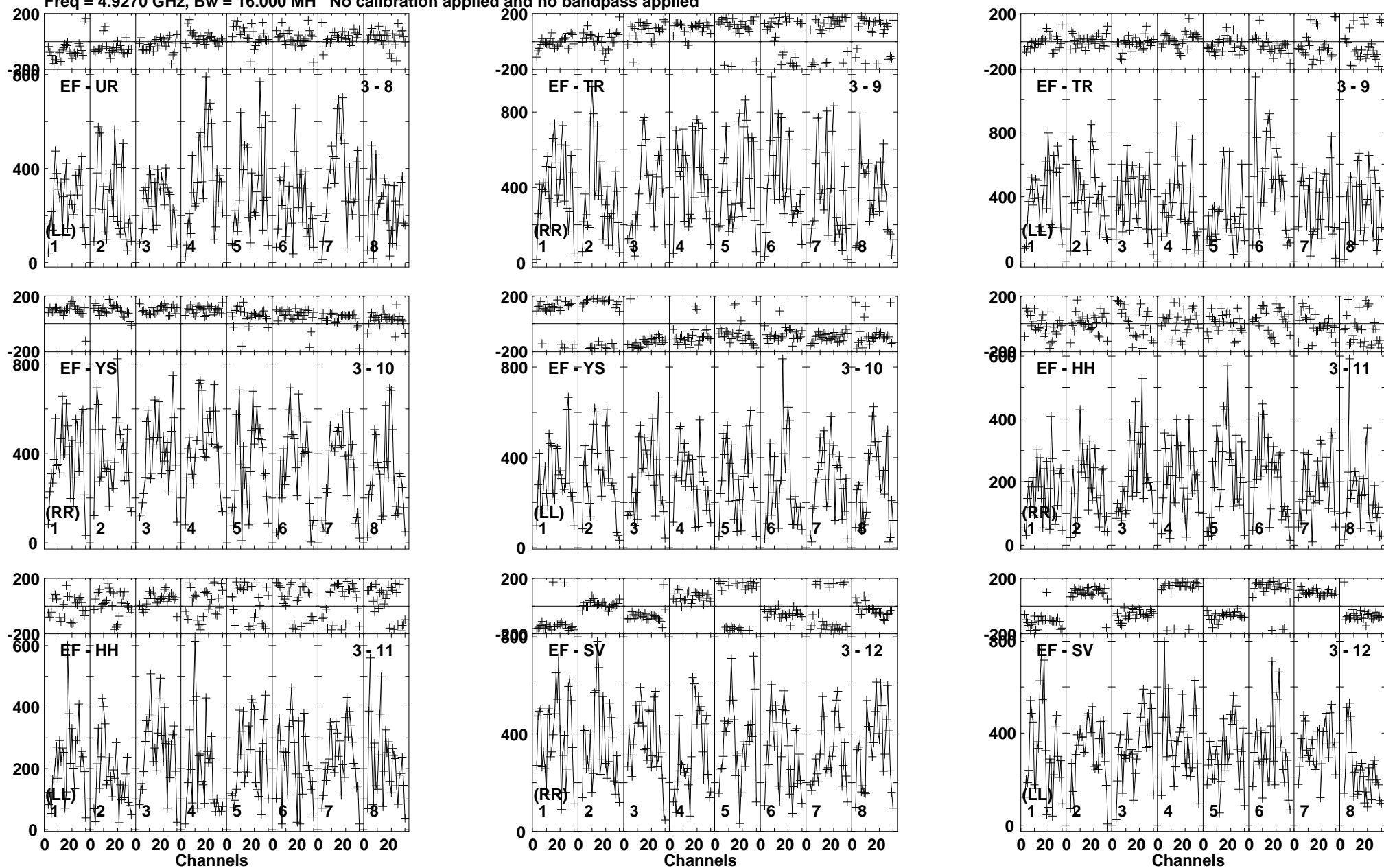

Lower frame: Micro Ampl Jy Top frame: Phas deg  
Vector averaged cross-power spectrum Baseline: EF (03) - UR (08)  
Timerange: 00/09:24:01 to 00/09:24:59

Plot file version 135 created 19-DEC-2018 17:58:21

VLA2 RY007C.UVDATA.1

Freq = 4.9270 GHz, Bw = 16.000 MH No calibration applied and no bandpass applied

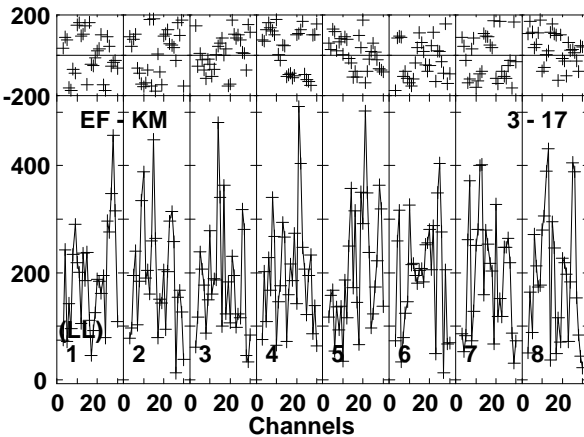
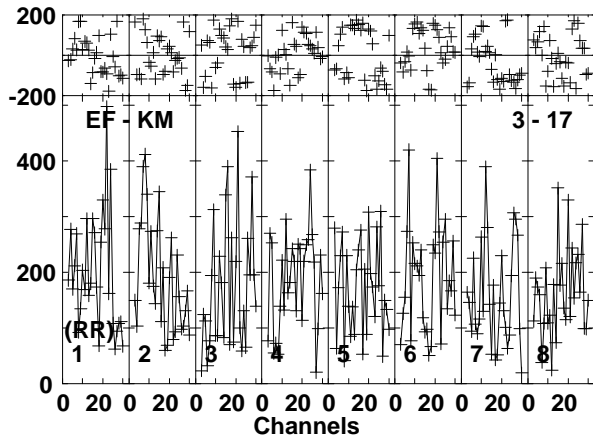
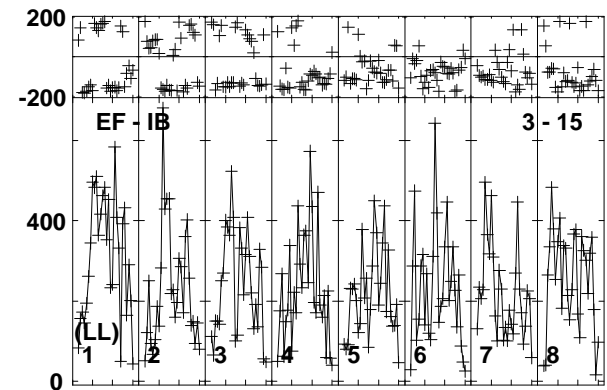
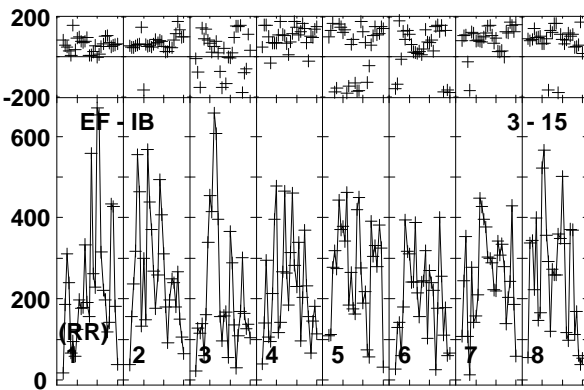
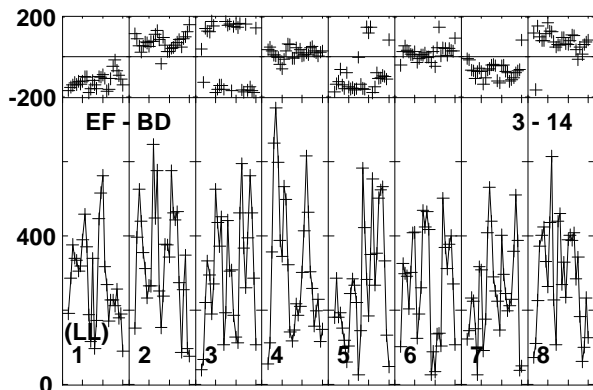
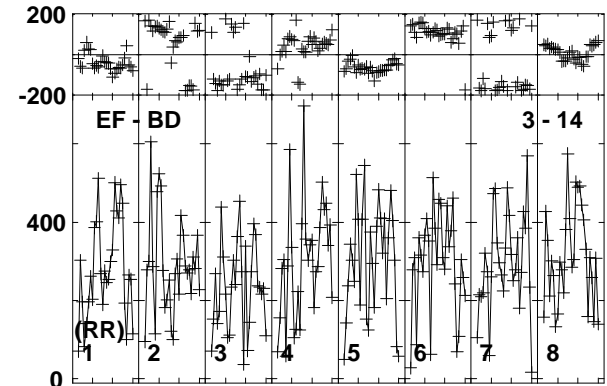
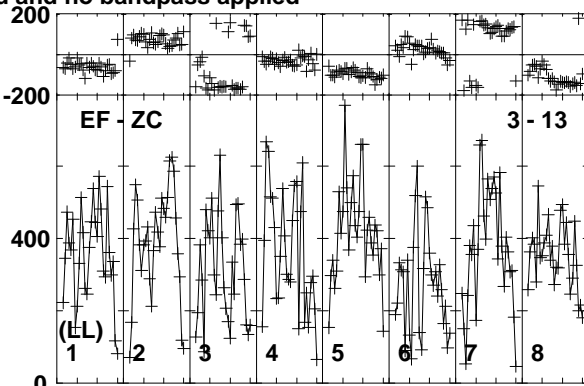
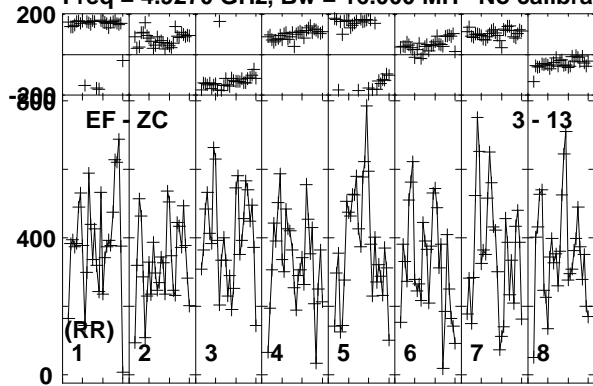

Lower frame: Micro Ampl Jy Top frame: Phas deg  
Vector averaged cross-power spectrum Baseline: EF (03) - ZC (13)  
Timerange: 00/09:24:01 to 00/09:24:59

Plot file version 136 created 19-DEC-2018 17:58:21

J1619+2247 RY007C.UVDATA.1

Freq = 4.9270 GHz, Bw = 16.000 MH No calibration applied and no bandpass applied

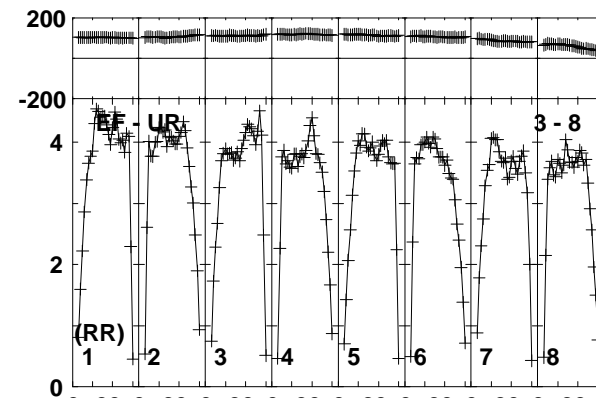
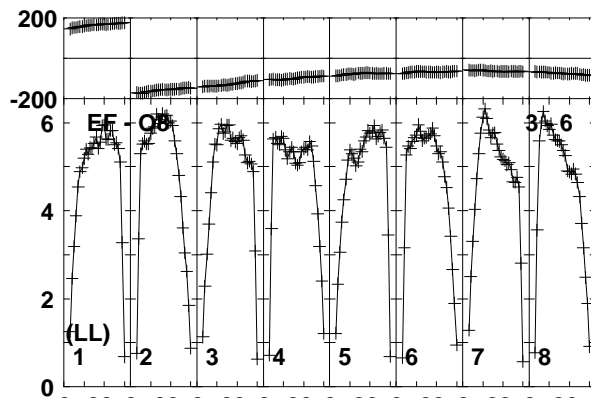
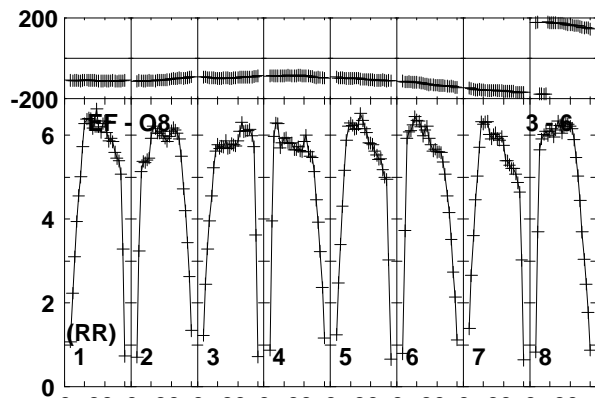
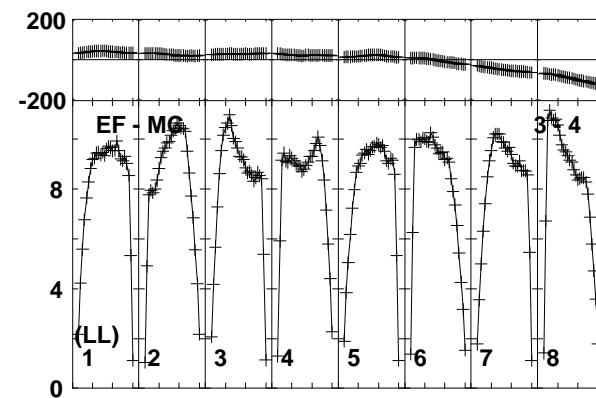
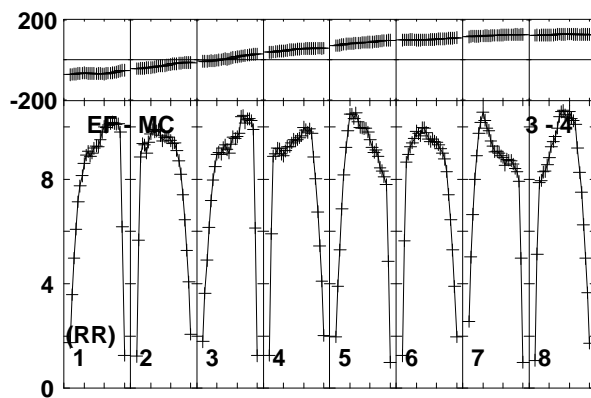
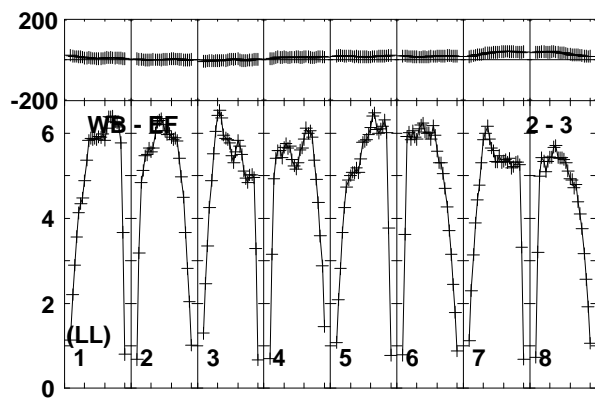
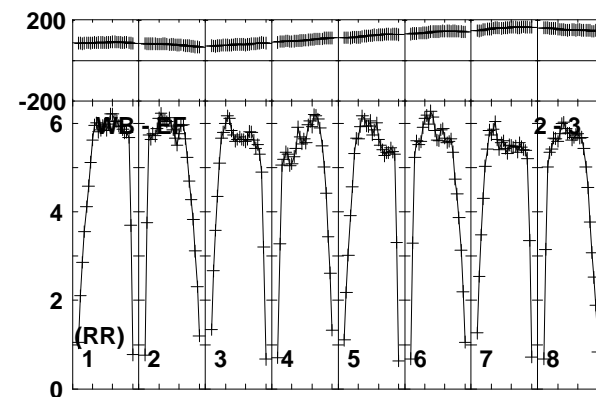
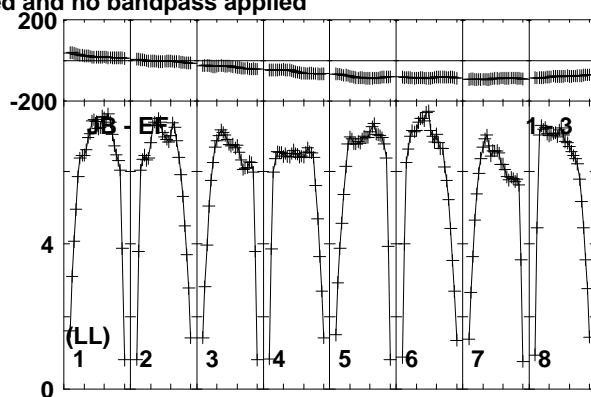
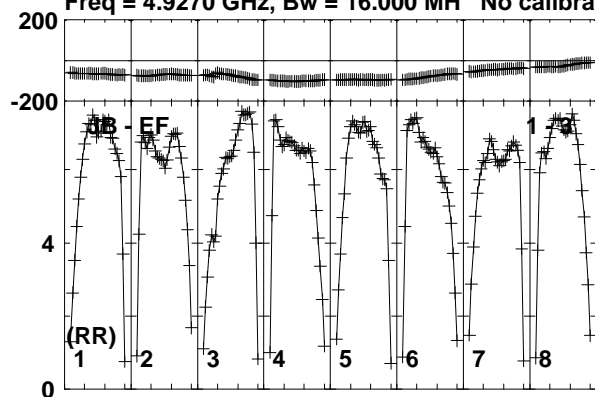

Lower frame: Milli Ampl Jy Top frame: Phas deg  
Vector averaged cross-power spectrum Baseline: JB (01) - EF (03)  
Timerange: 00/09:25:31 to 00/09:26:29

Plot file version 137 created 19-DEC-2018 17:58:21

J1619+2247 RY007C.UVDATA.1

Freq = 4.9270 GHz, Bw = 16.000 MH No calibration applied and no bandpass applied

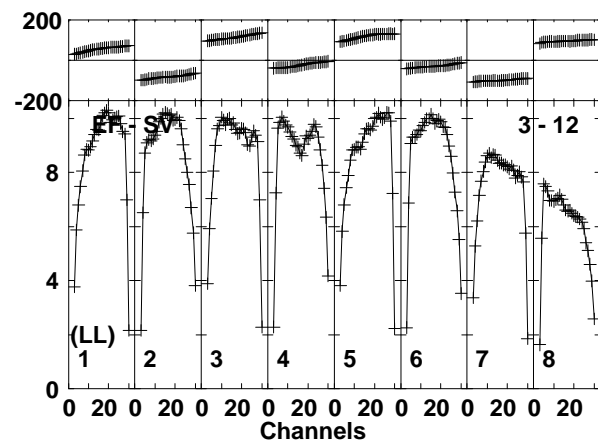
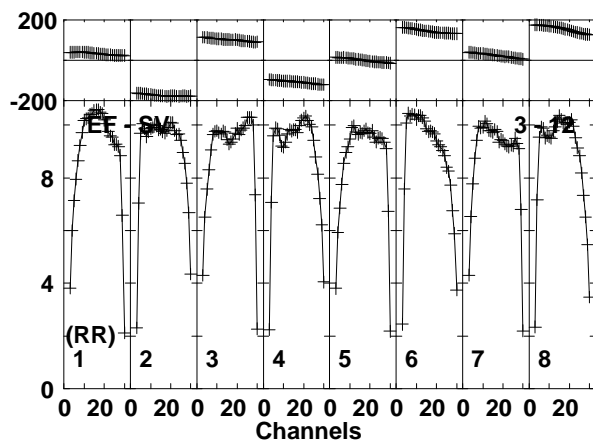
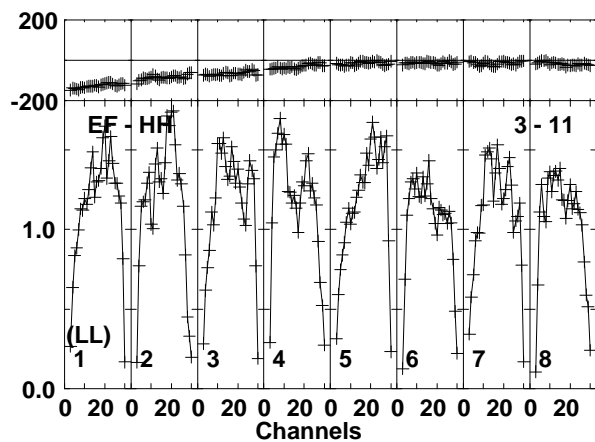
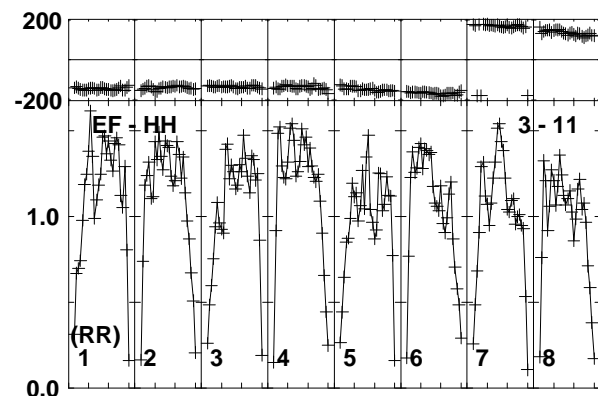
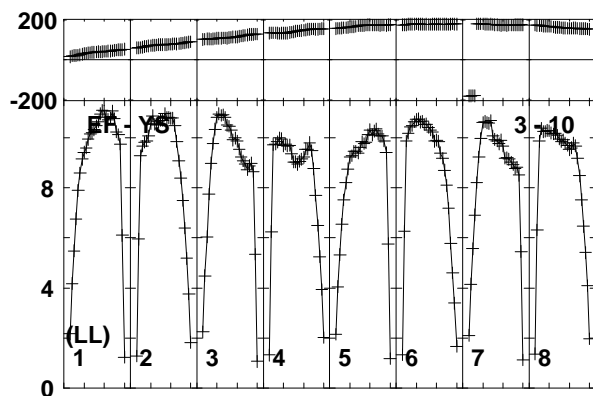
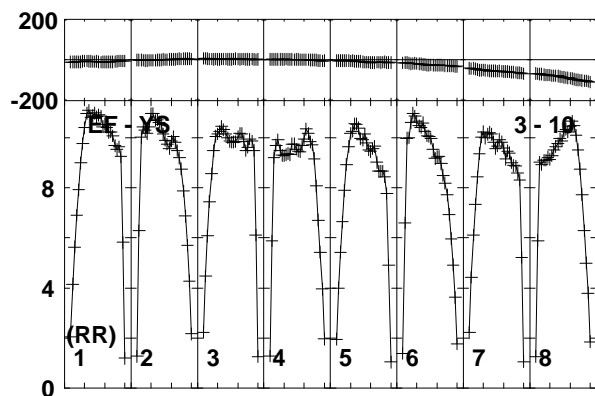
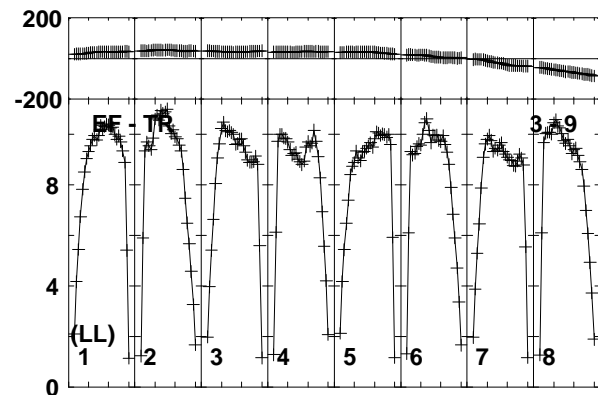
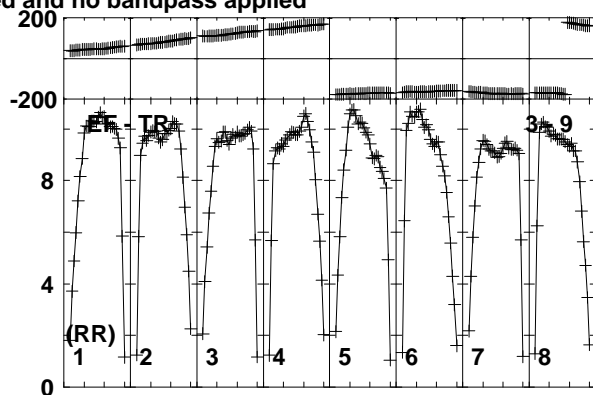
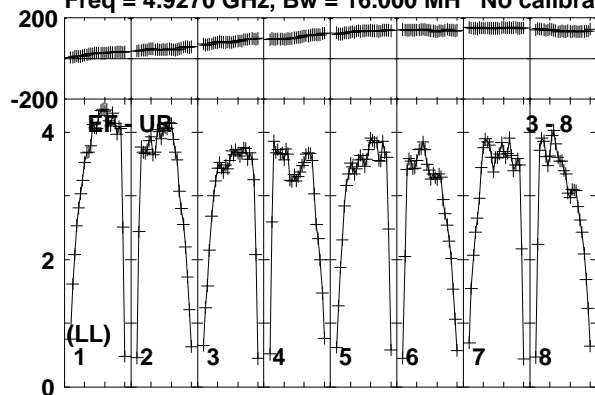

Lower frame: Milli Ampl Jy Top frame: Phas deg  
Vector averaged cross-power spectrum Baseline: EF (03) - UR (08)  
Timerange: 00/09:25:31 to 00/09:26:29

Plot file version 138 created 19-DEC-2018 17:58:21

J1619+2247 RY007C.UVDATA.1

Freq = 4.9270 GHz, Bw = 16.000 MH No calibration applied and no bandpass applied

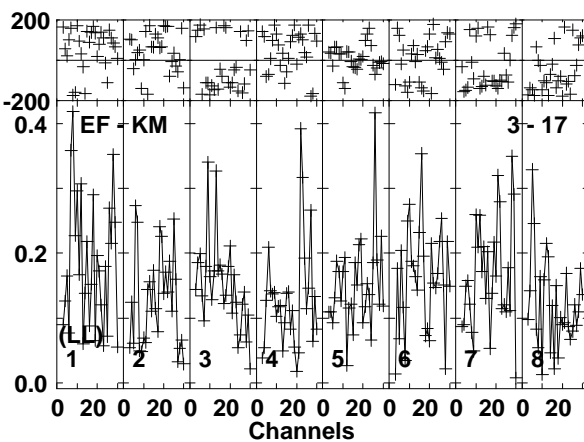
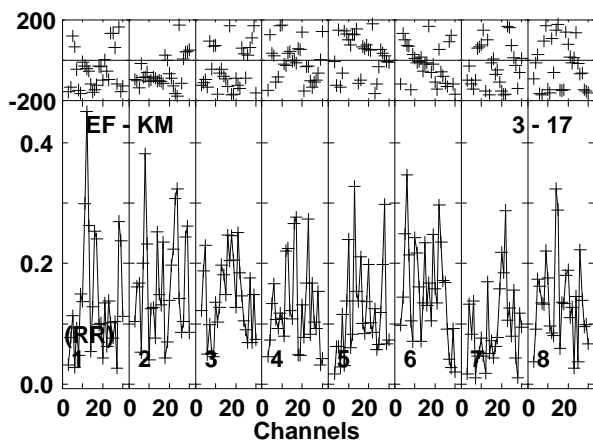
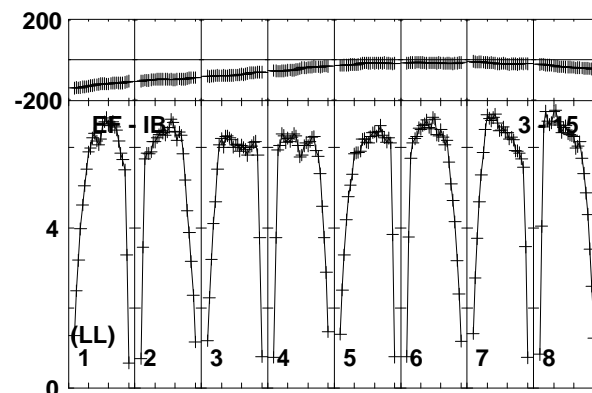
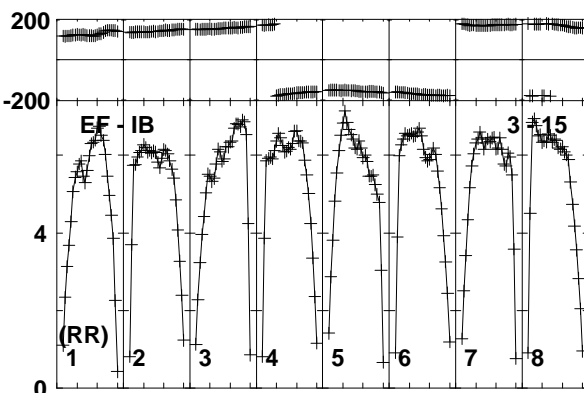
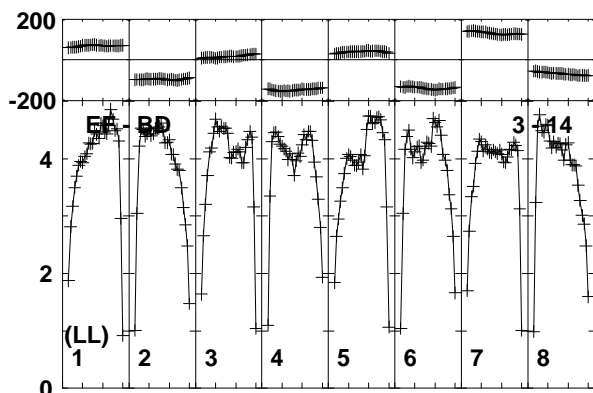
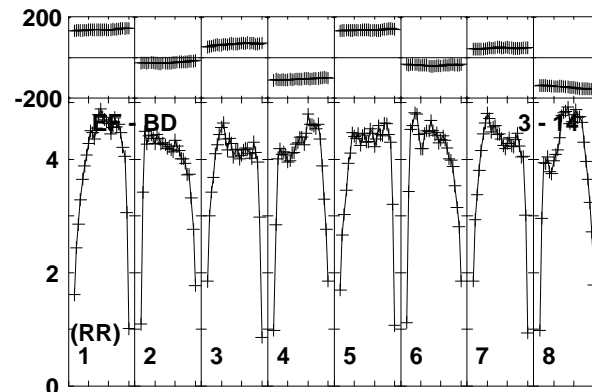
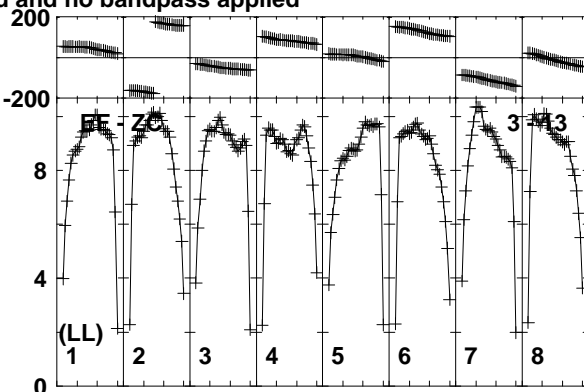
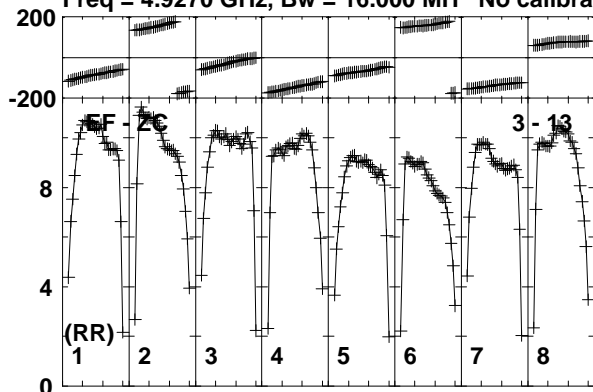

Lower frame: Milli Ampl Jy Top frame: Phas deg  
Vector averaged cross-power spectrum Baseline: EF (03) - ZC (13)  
Timerange: 00/09:25:31 to 00/09:26:29



Plot file version 139 created 19-DEC-2018 17:58:21

AT2018\_RY007C.UVDATA.1

Freq = 4.9270 GHz, Bw = 16.000 MH No calibration applied and no bandpass applied

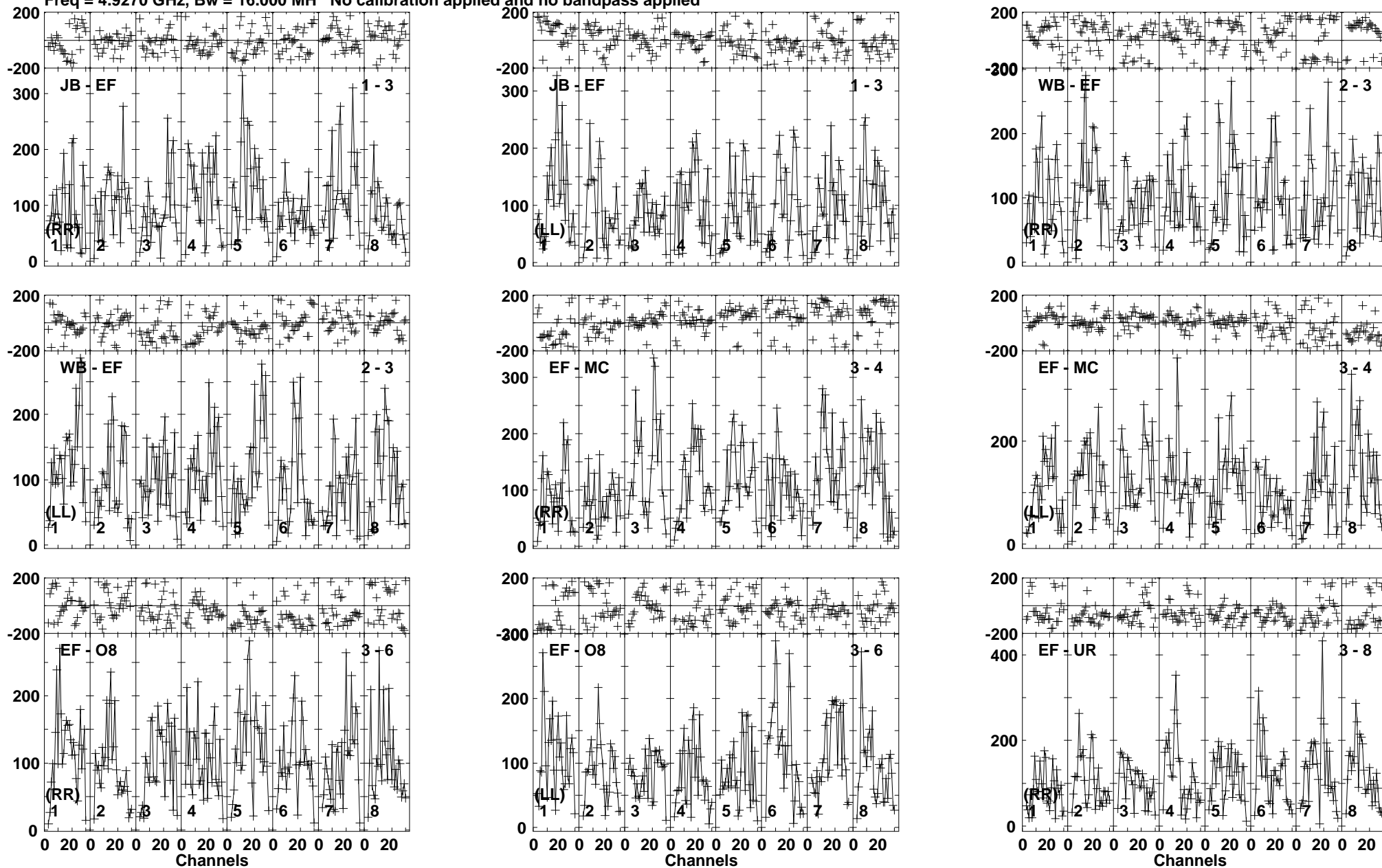

Lower frame: Micro Ampl Jy Top frame: Phas deg  
Vector averaged cross-power spectrum Baseline: JB (01) - EF (03)  
Timerange: 00/09:26:31 to 00/09:29:29

Plot file version 140 created 19-DEC-2018 17:58:21

AT2018\_RY007C.UVDATA.1

Freq = 4.9270 GHz, Bw = 16.000 MH No calibration applied and no bandpass applied

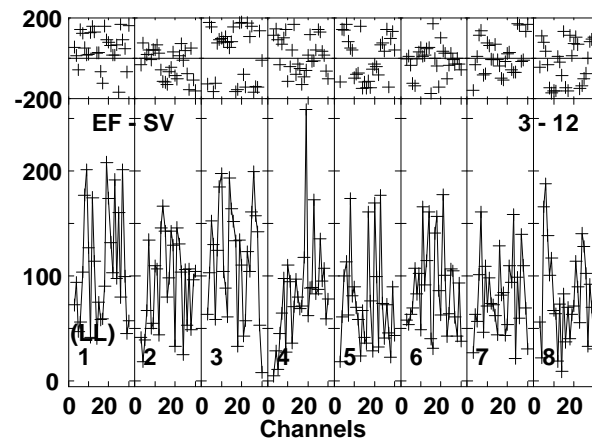
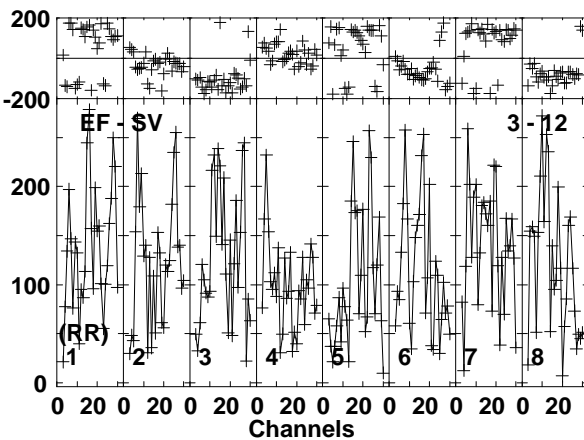
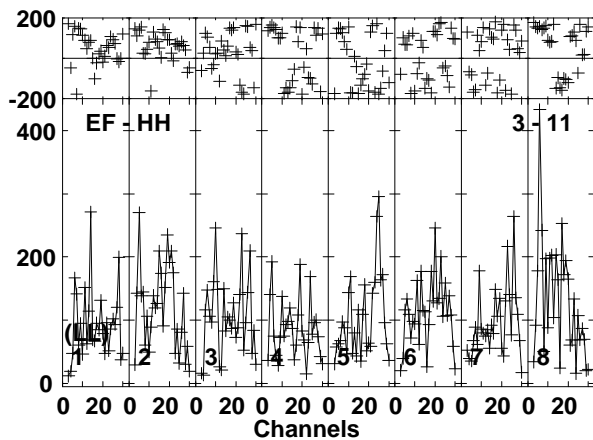
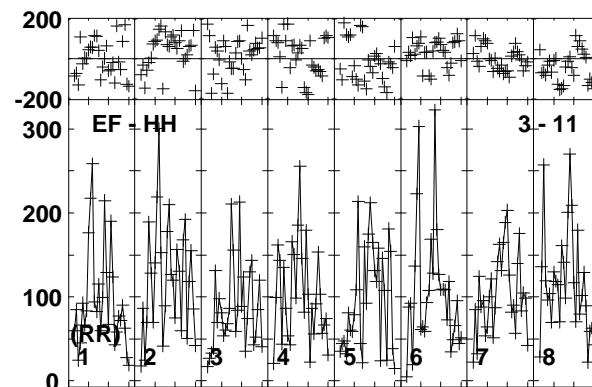
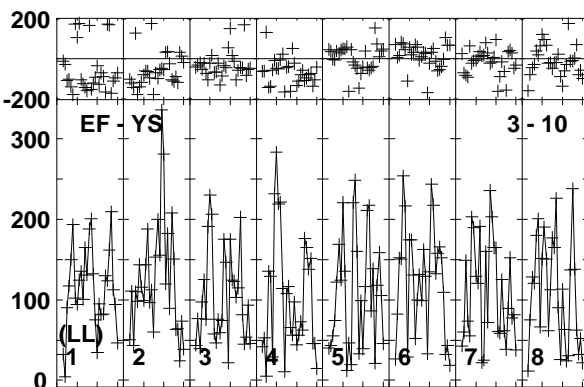
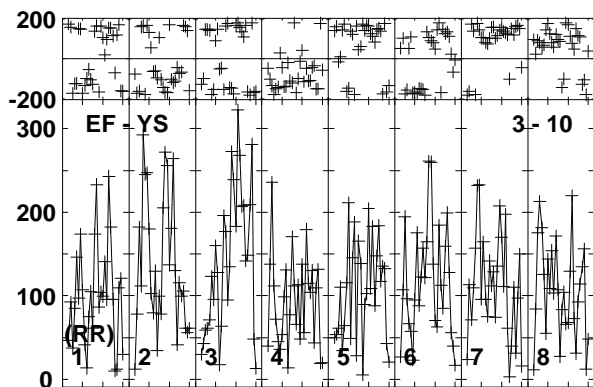
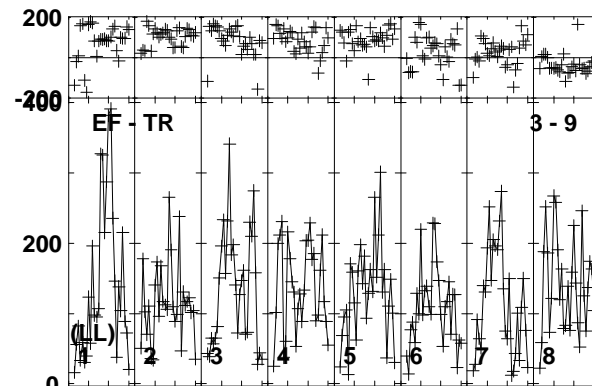
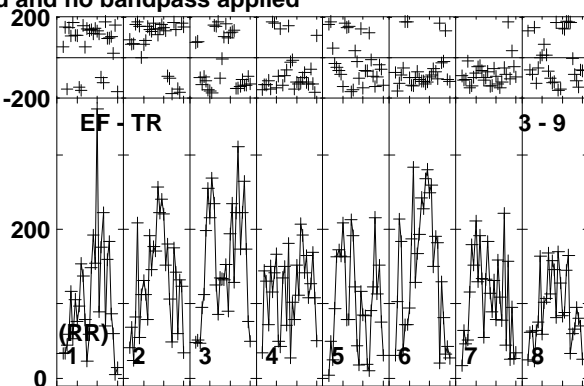
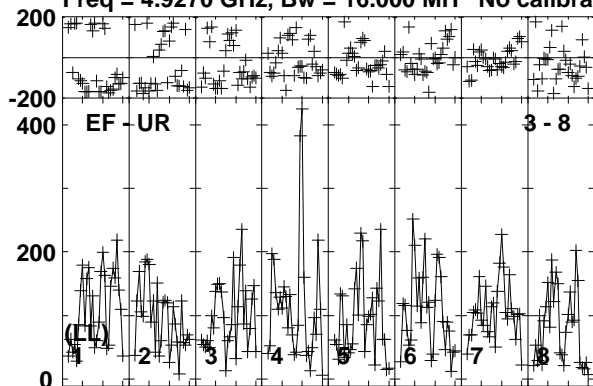

Lower frame: Micro Ampl Jy Top frame: Phas deg  
Vector averaged cross-power spectrum Baseline: EF (03) - UR (08)  
Timerange: 00/09:26:31 to 00/09:29:29

Plot file version 141 created 19-DEC-2018 17:58:21

AT2018\_RY007C.UVDATA.1

Freq = 4.9270 GHz, Bw = 16.000 MH No calibration applied and no bandpass applied

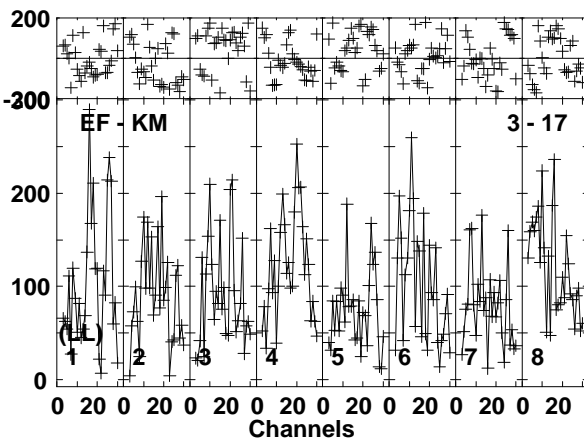
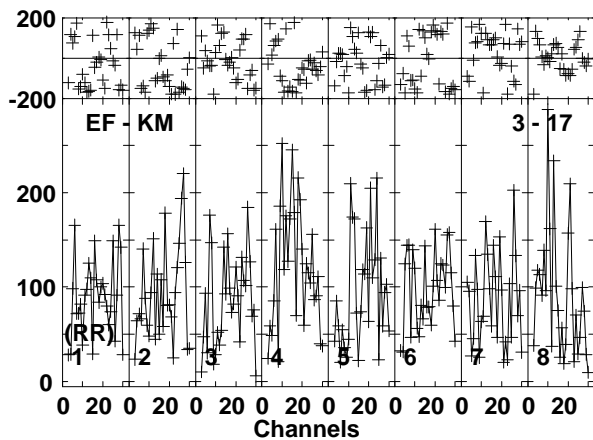
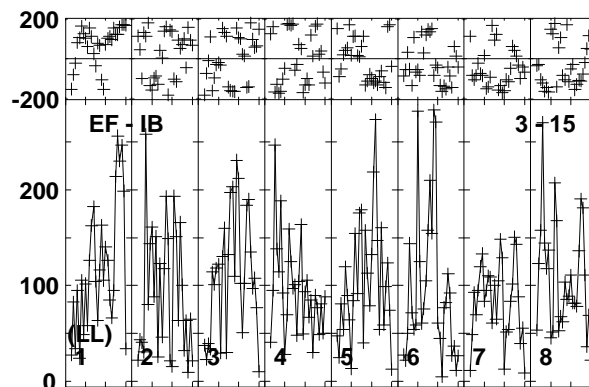
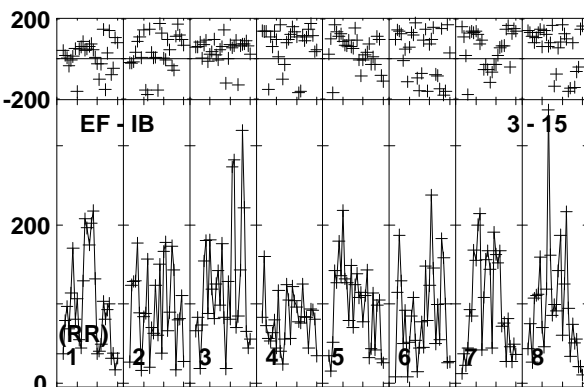
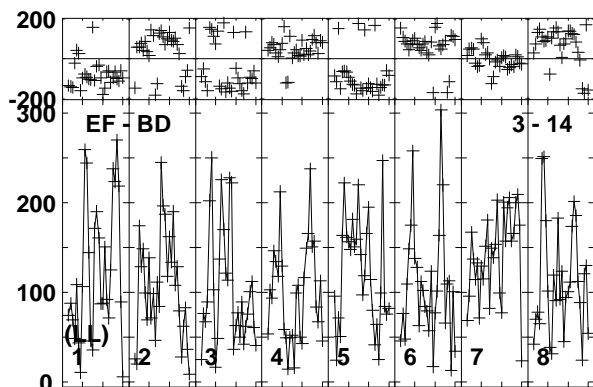
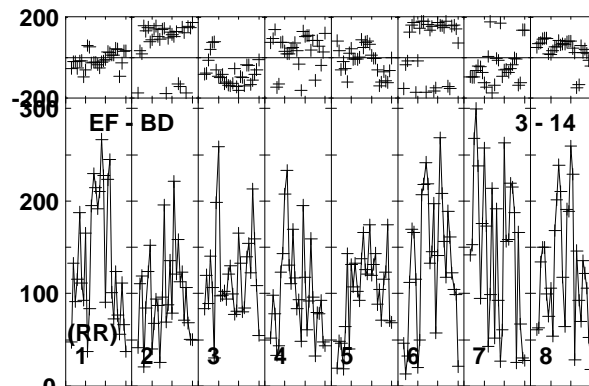
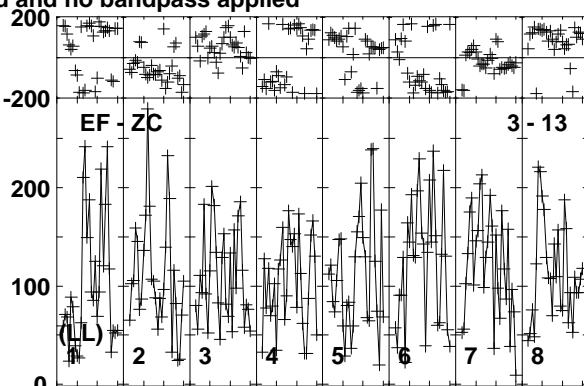
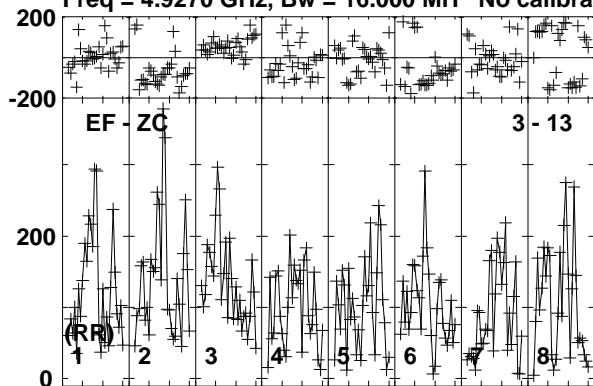

Lower frame: Micro Ampl Jy Top frame: Phas deg  
Vector averaged cross-power spectrum Baseline: EF (03) - ZC (13)  
Timerange: 00/09:26:31 to 00/09:29:29

Plot file version 142 created 19-DEC-2018 17:58:21

J1619+2247 RY007C.UVDATA.1

Freq = 4.9270 GHz, Bw = 16.000 MH No calibration applied and no bandpass applied

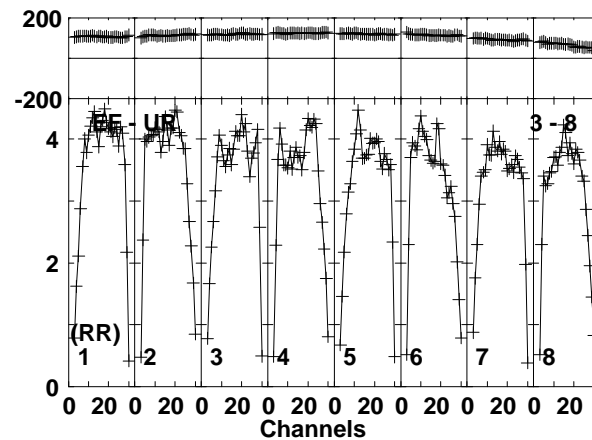
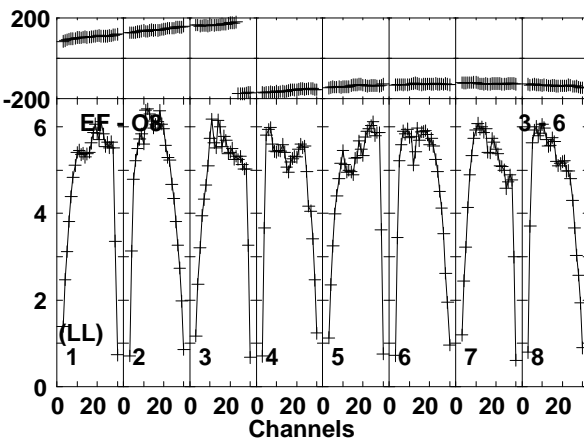
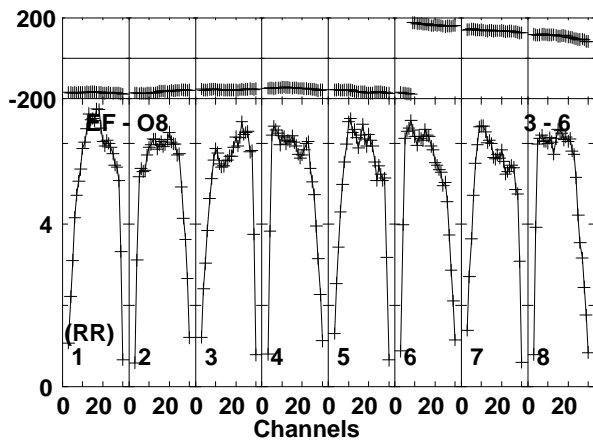
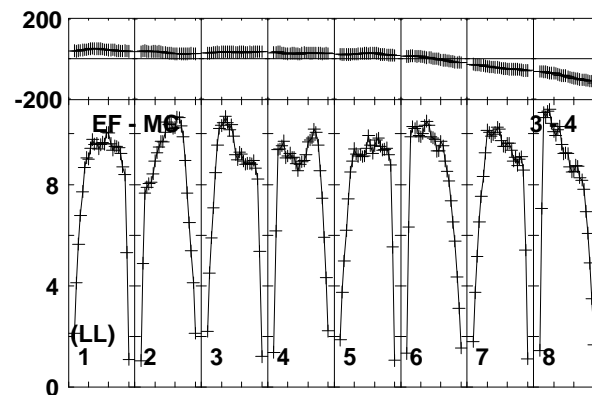
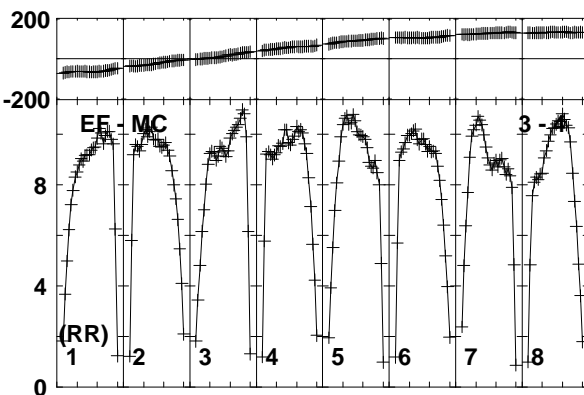
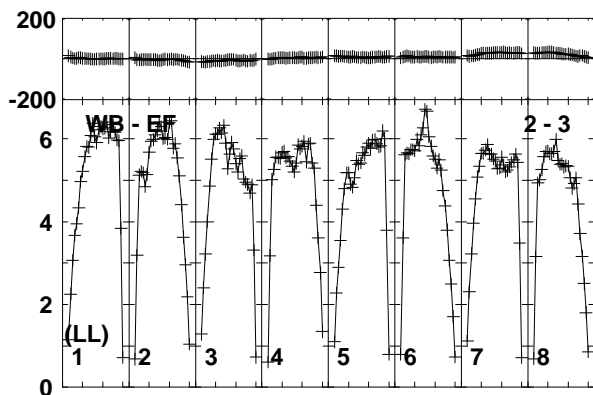
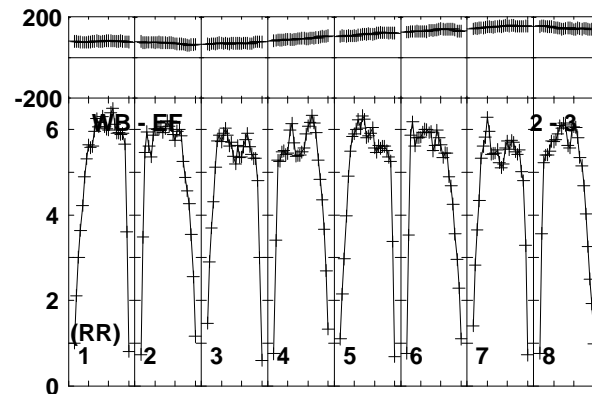
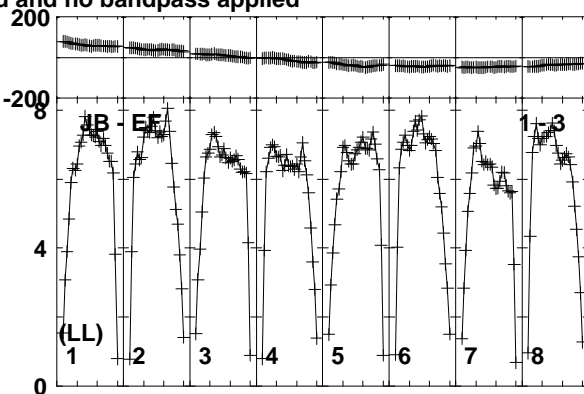
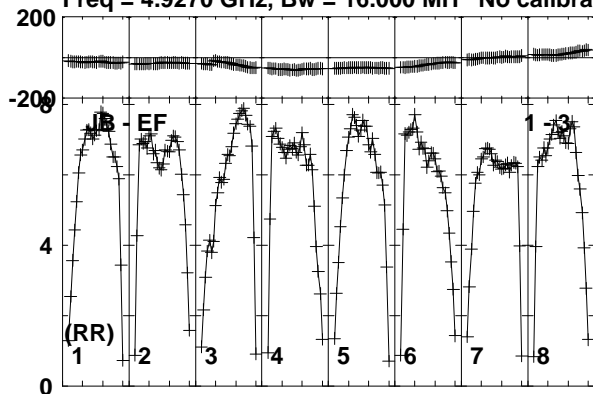

Lower frame: Milli Ampl Jy Top frame: Phas deg  
Vector averaged cross-power spectrum Baseline: JB (01) - EF (03)  
Timerange: 00/09:29:31 to 00/09:30:29

Plot file version 143 created 19-DEC-2018 17:58:22

J1619+2247 RY007C.UVDATA.1

Freq = 4.9270 GHz, Bw = 16.000 MH No calibration applied and no bandpass applied

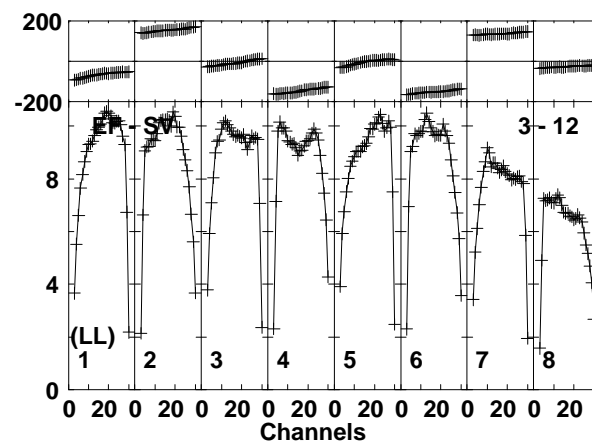
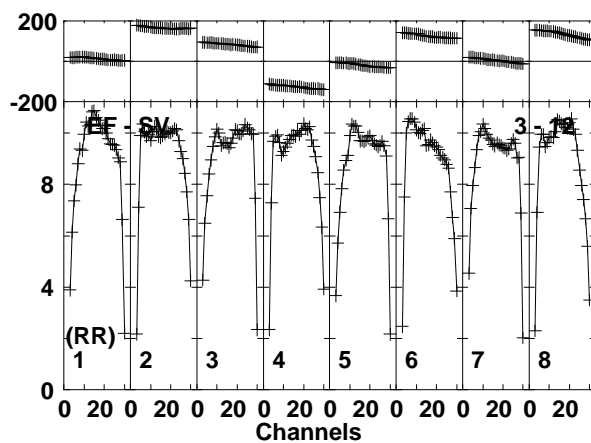
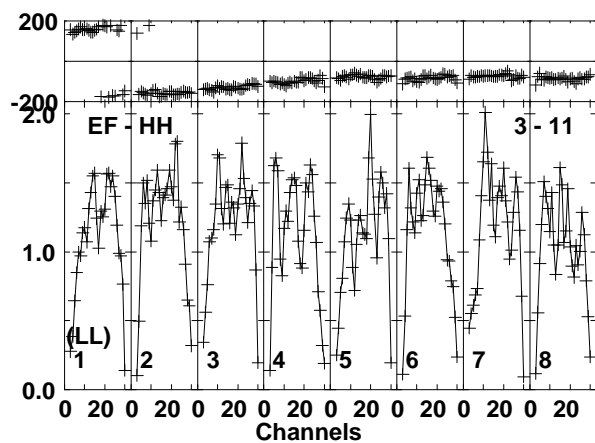
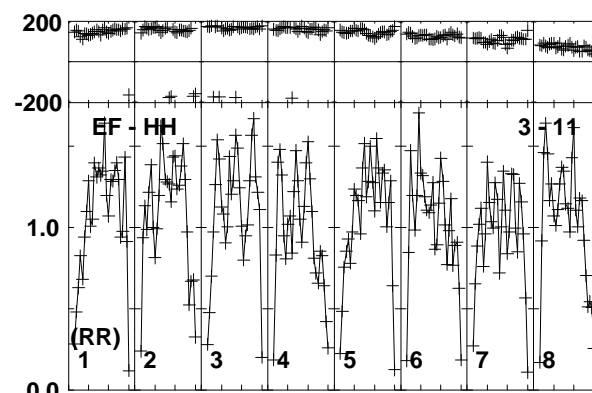
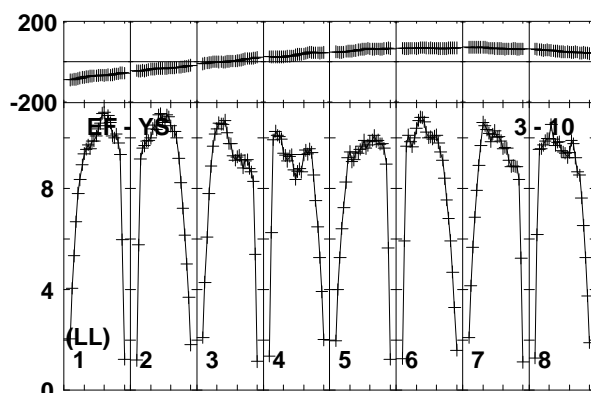
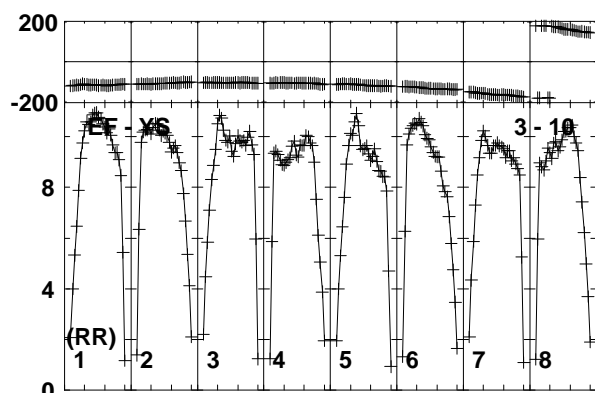
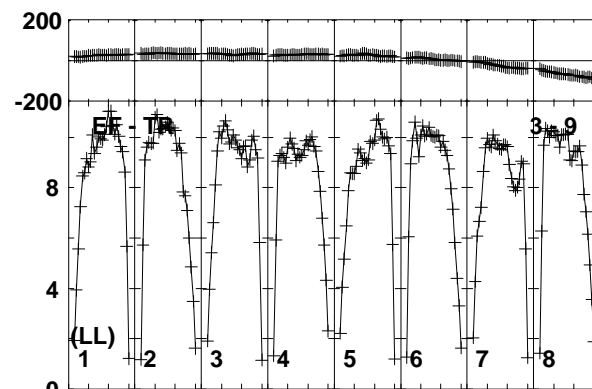
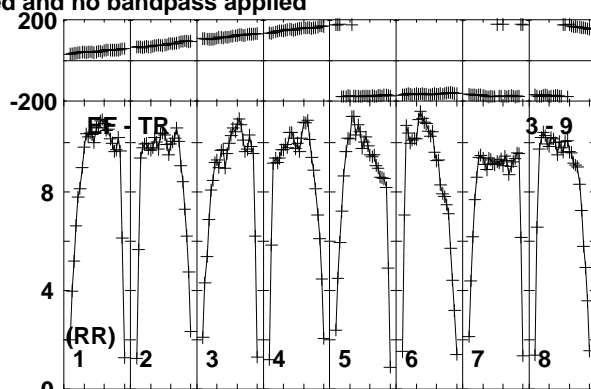
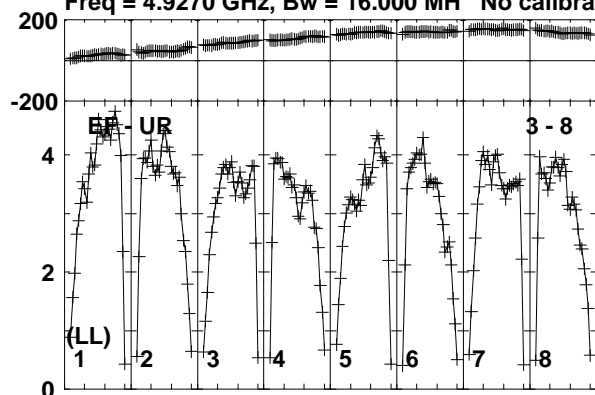

Lower frame: Milli Ampl Jy Top frame: Phas deg  
Vector averaged cross-power spectrum Baseline: EF (03) - UR (08)  
Timerange: 00/09:29:31 to 00/09:30:29

Plot file version 144 created 19-DEC-2018 17:58:22

J1619+2247 RY007C.UVDATA.1

Freq = 4.9270 GHz, Bw = 16.000 MH No calibration applied and no bandpass applied

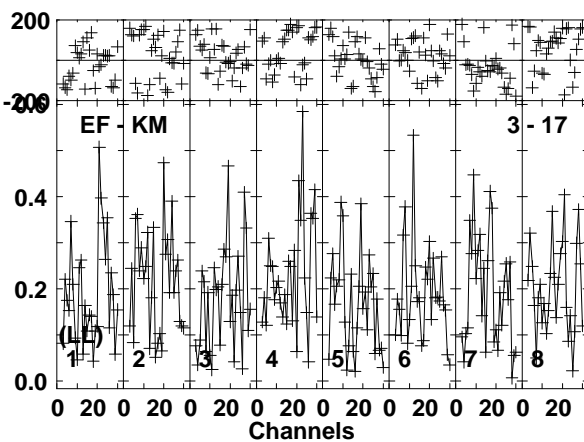
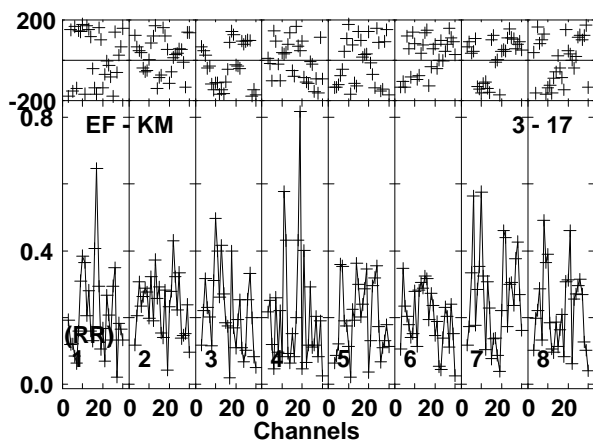
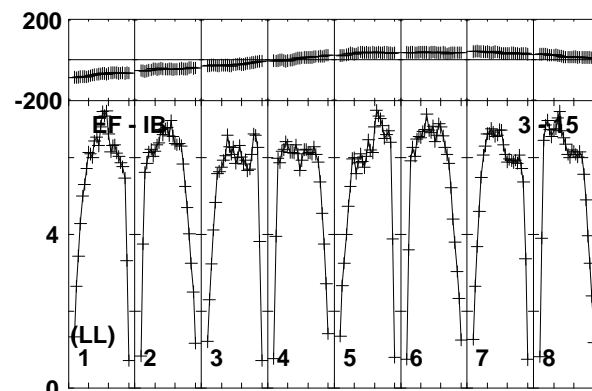
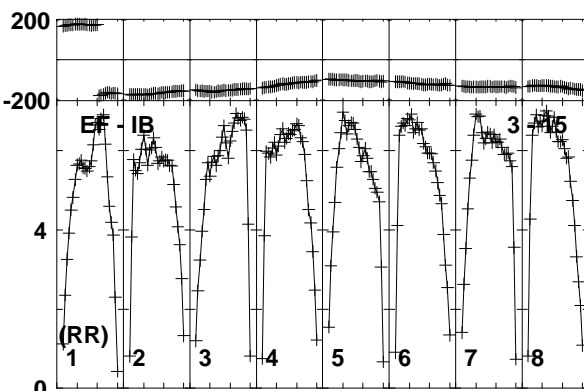
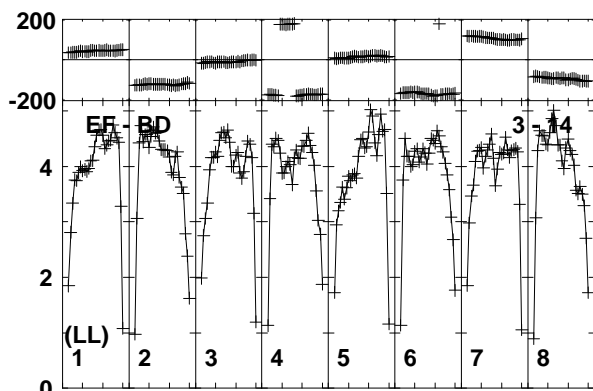
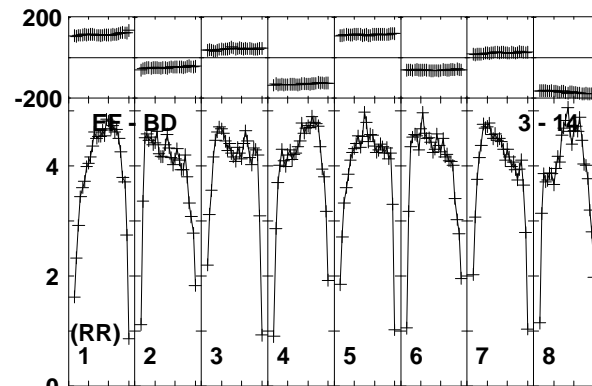
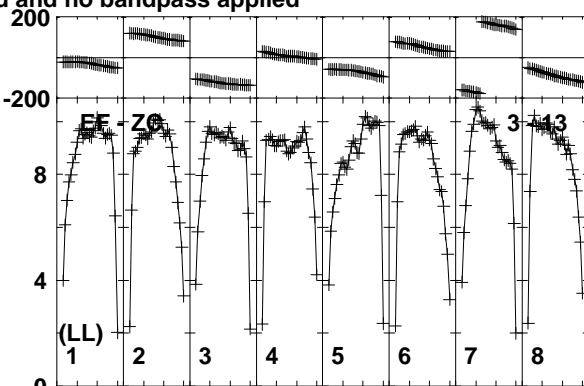
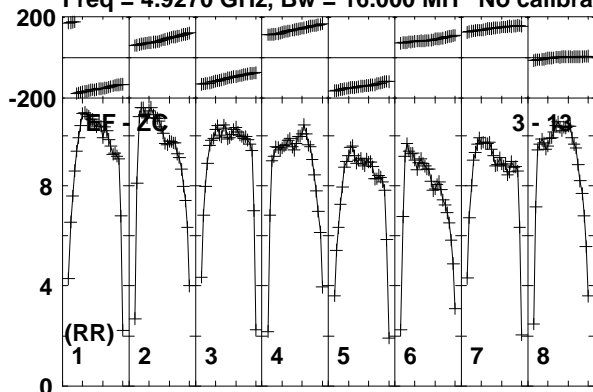

Lower frame: Milli Ampl Jy Top frame: Phas deg  
Vector averaged cross-power spectrum Baseline: EF (03) - ZC (13)  
Timerange: 00/09:29:31 to 00/09:30:29

Plot file version 145 created 19-DEC-2018 17:58:22

AT2018\_RY007C.UVDATA.1

Freq = 4.9270 GHz, Bw = 16.000 MH No calibration applied and no bandpass applied

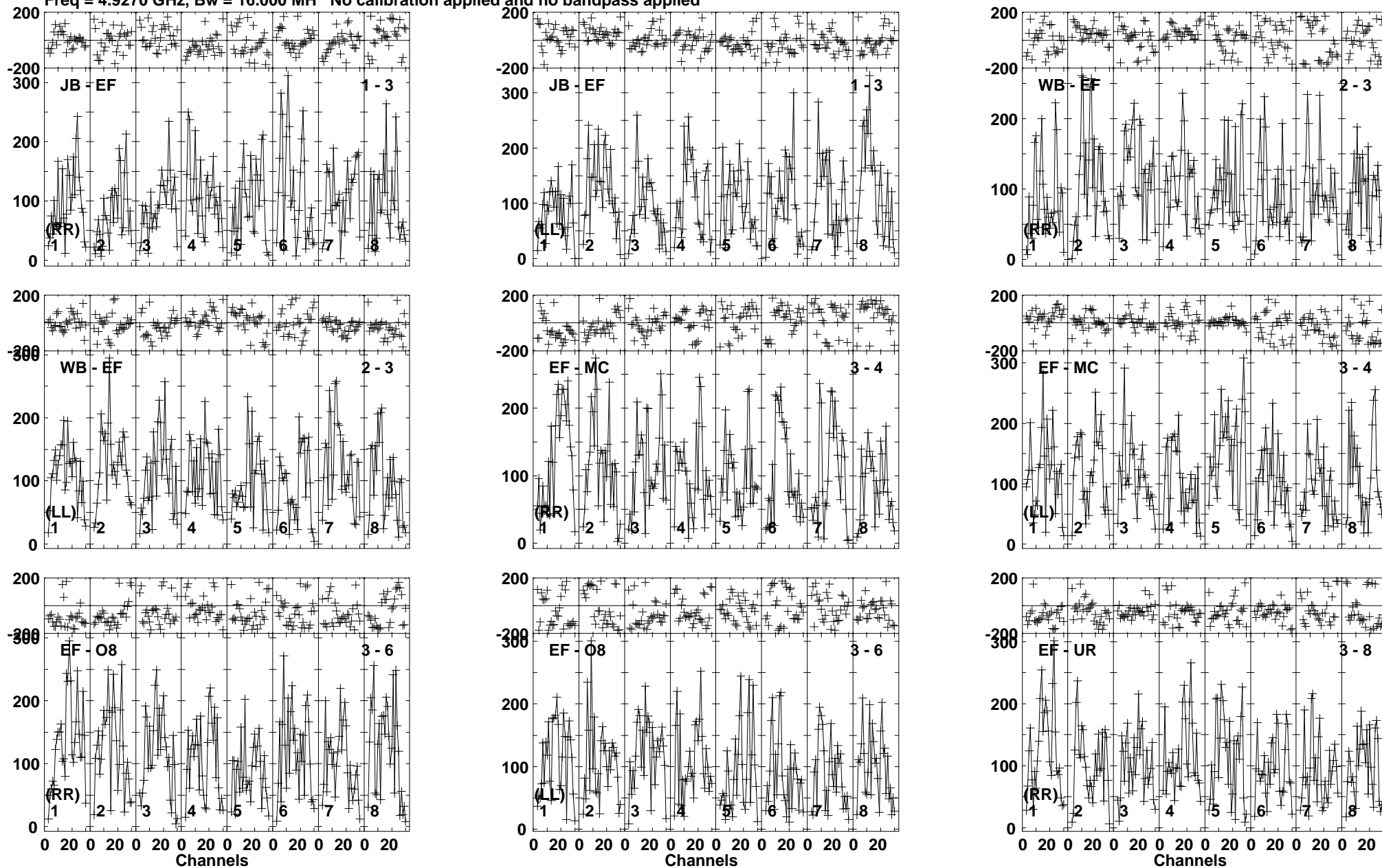

Lower frame: Micro Ampl Jy Top frame: Phas deg  
Vector averaged cross-power spectrum Baseline: JB (01) - EF (03)  
Timerange: 00/09:30:31 to 00/09:33:29

Plot file version 146 created 19-DEC-2018 17:58:22

AT2018\_RY007C.UVDATA.1

Freq = 4.9270 GHz, Bw = 16.000 MH No calibration applied and no bandpass applied

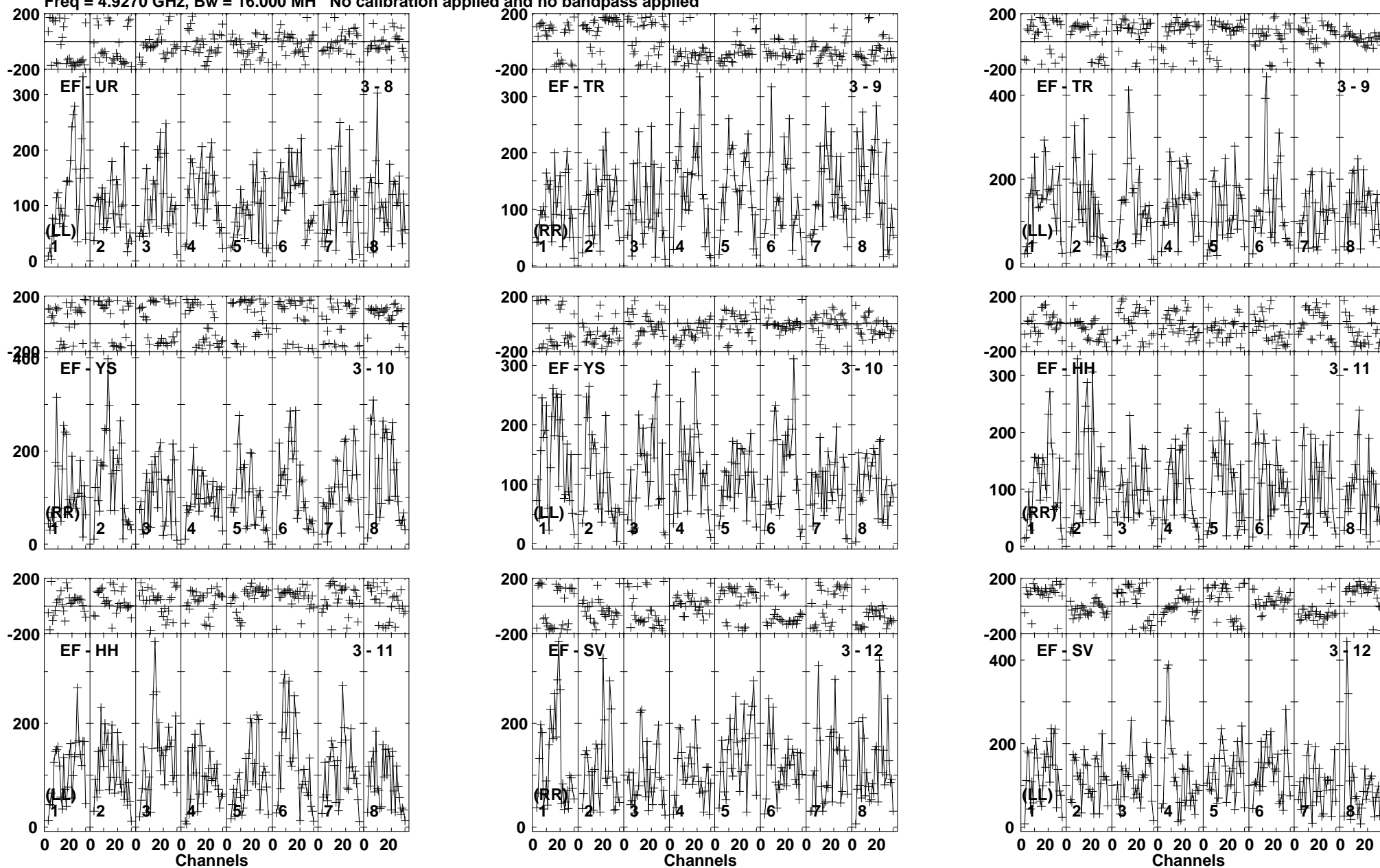

Lower frame: Micro Ampl Jy Top frame: Phas deg  
Vector averaged cross-power spectrum Baseline: EF (03) - UR (08)  
Timerange: 00/09:30:31 to 00/09:33:29



Plot file version 147 created 19-DEC-2018 17:58:22

AT2018\_RY007C.UVDATA.1

Freq = 4.9270 GHz, Bw = 16.000 MH No calibration applied and no bandpass applied

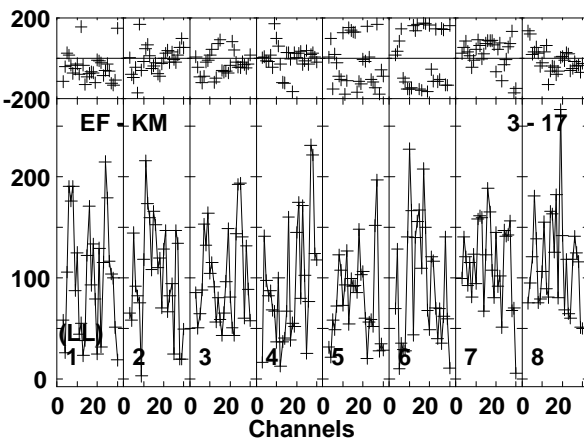
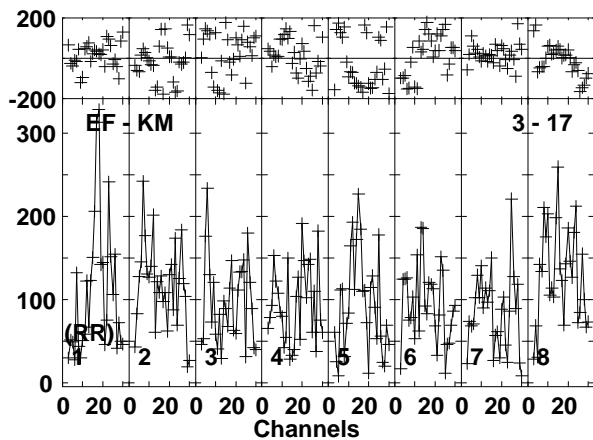
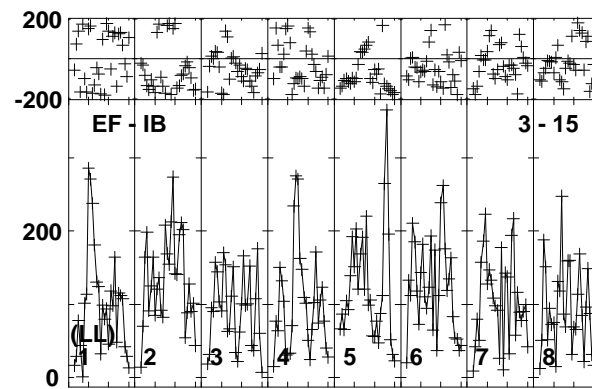
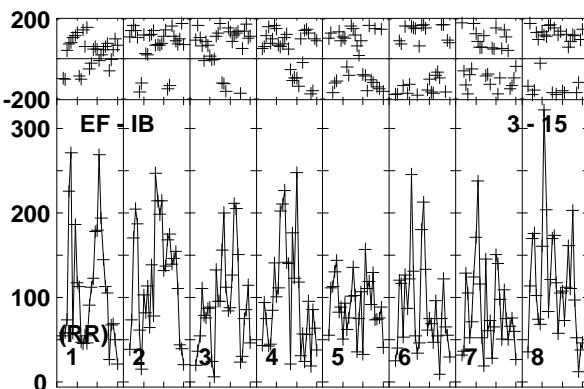
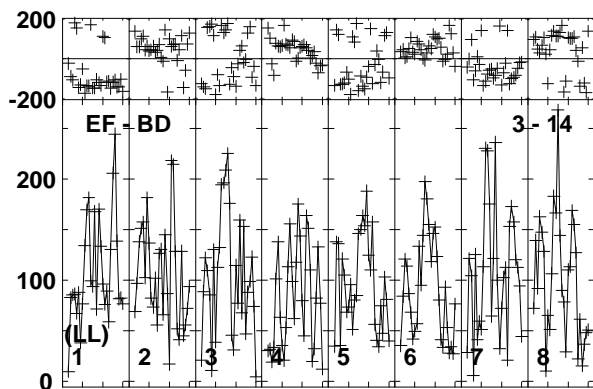
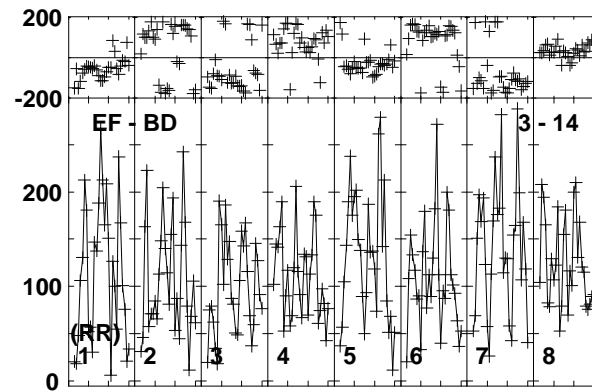
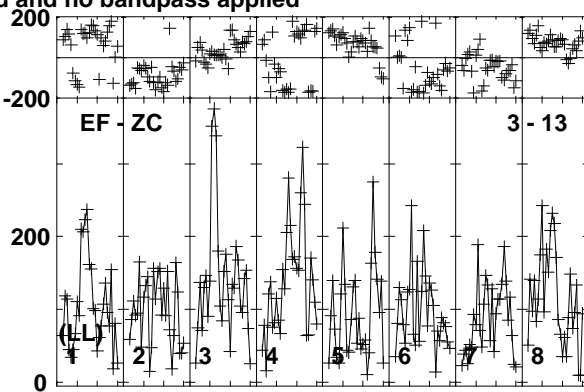
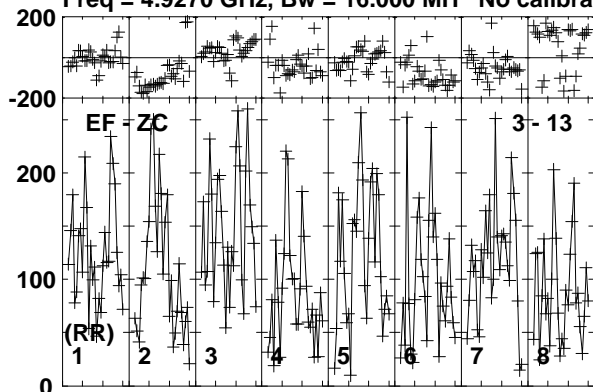

Lower frame: Micro Ampl Jy Top frame: Phas deg  
Vector averaged cross-power spectrum Baseline: EF (03) - ZC (13)  
Timerange: 00/09:30:31 to 00/09:33:29

Plot file version 148 created 19-DEC-2018 17:58:22

J1619+2247 RY007C.UVDATA.1

Freq = 4.9270 GHz, Bw = 16.000 MH No calibration applied and no bandpass applied

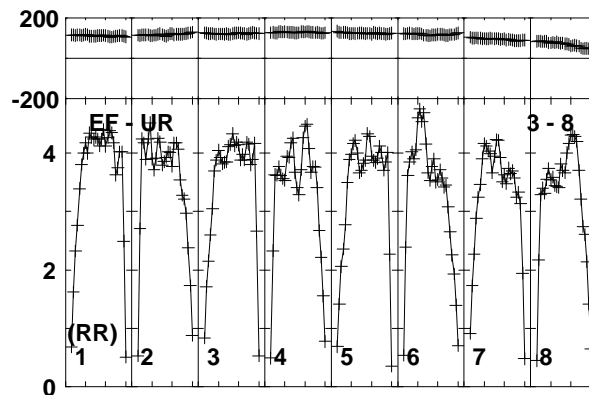
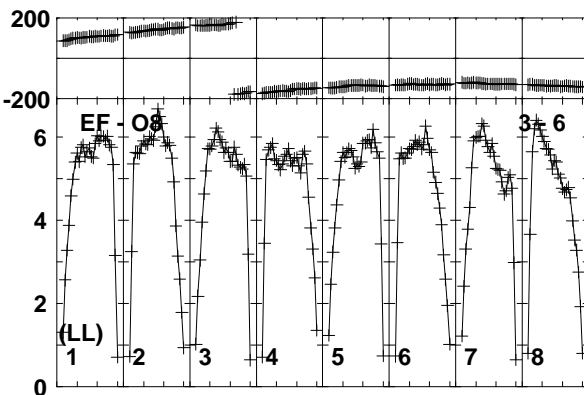
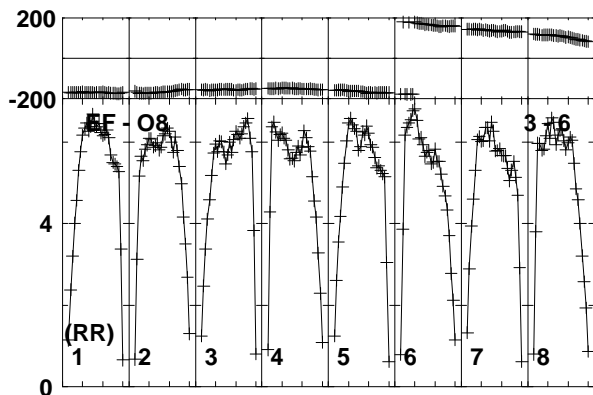
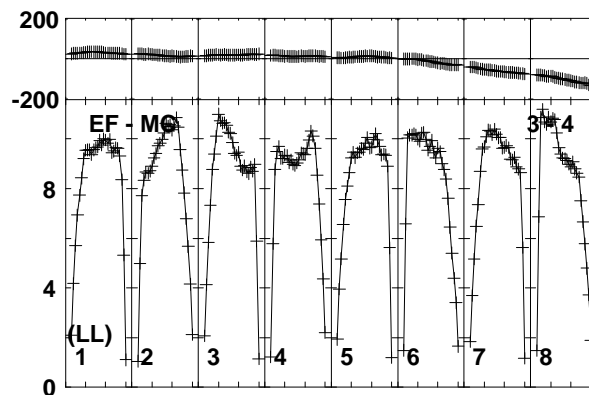
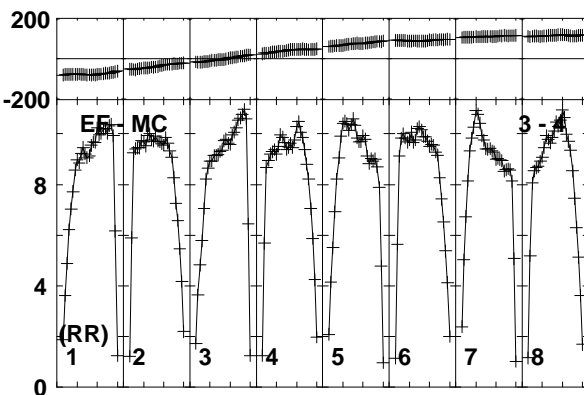
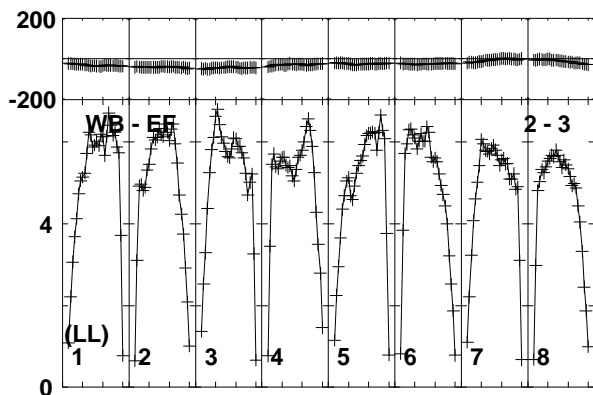
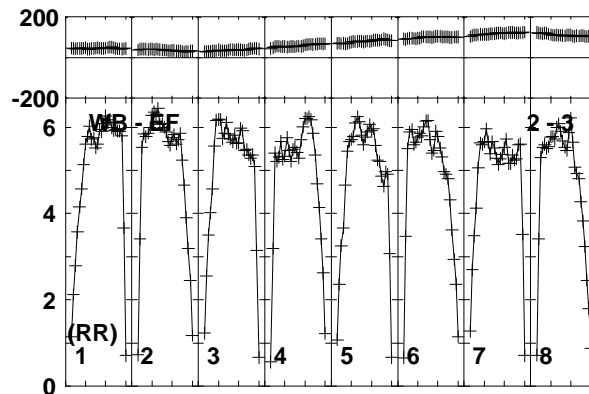
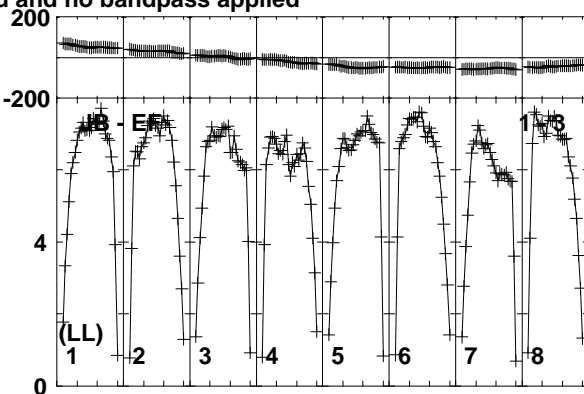
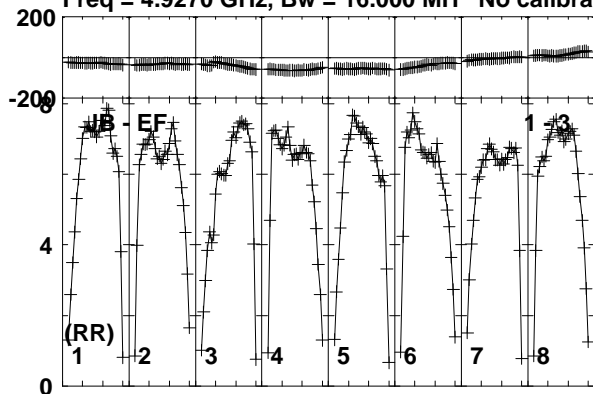

Lower frame: Milli Ampl Jy Top frame: Phas deg  
Vector averaged cross-power spectrum Baseline: JB (01) - EF (03)  
Timerange: 00/09:33:31 to 00/09:34:29

Plot file version 149 created 19-DEC-2018 17:58:22

J1619+2247 RY007C.UVDATA.1

Freq = 4.9270 GHz, Bw = 16.000 MH No calibration applied and no bandpass applied

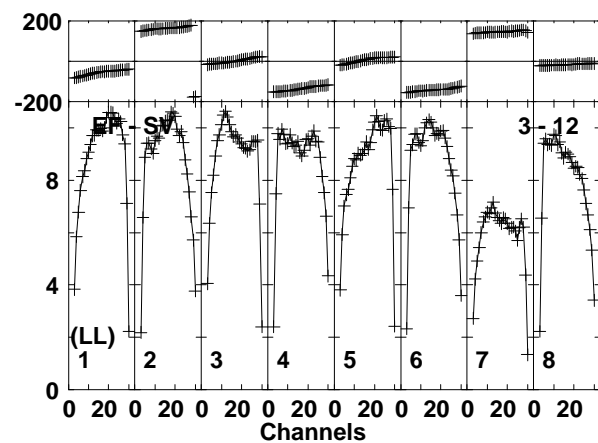
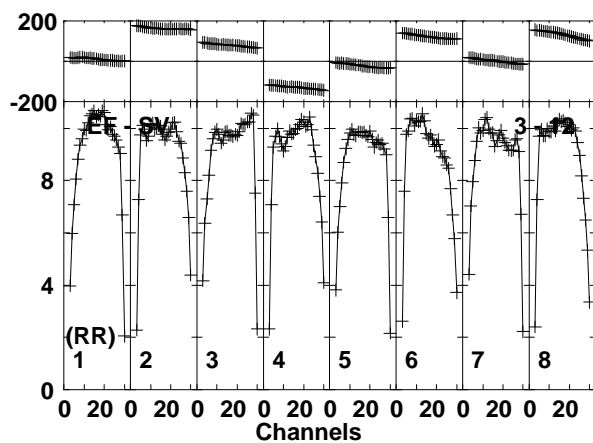
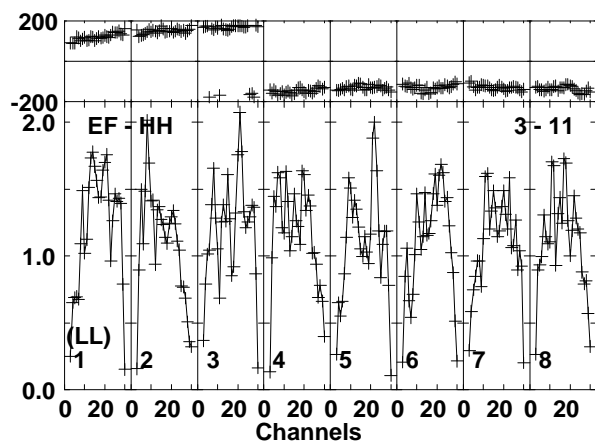
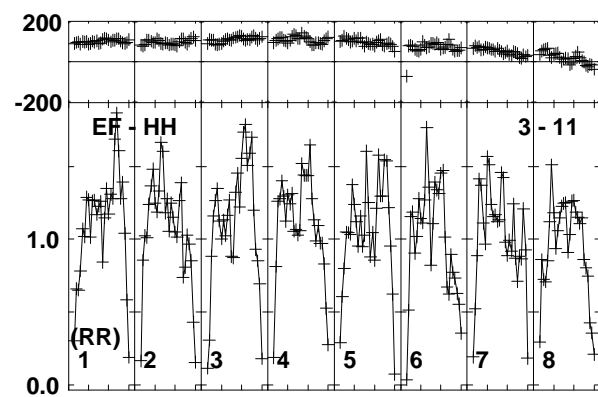
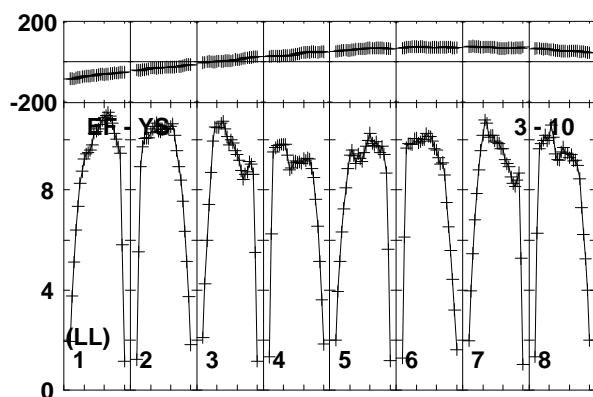
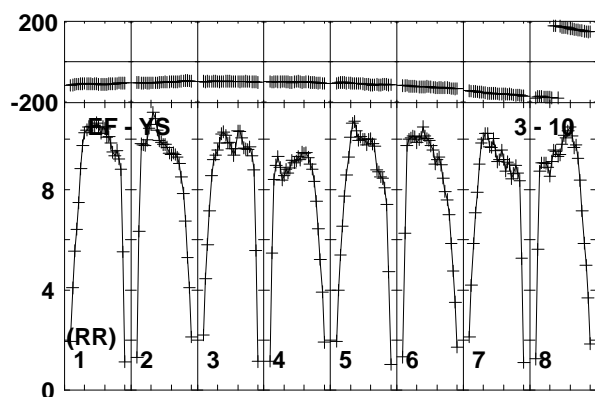
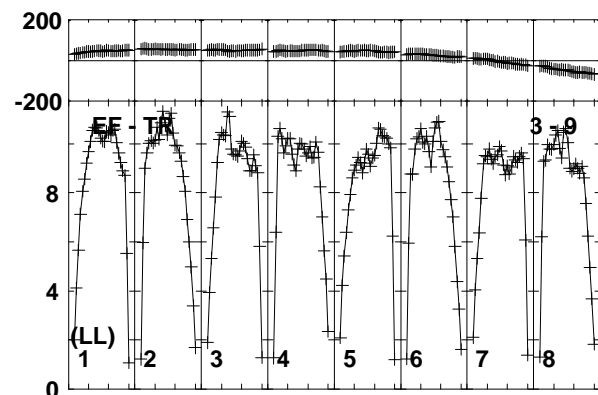
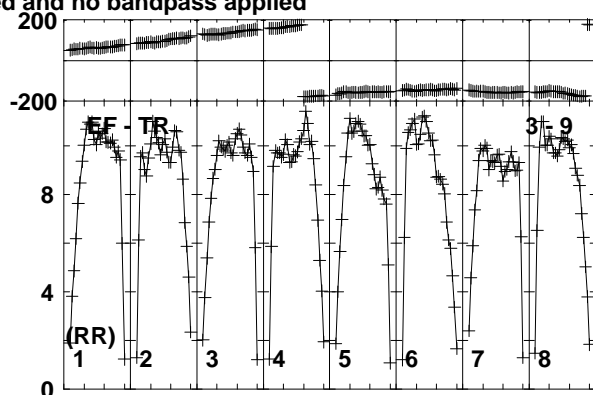
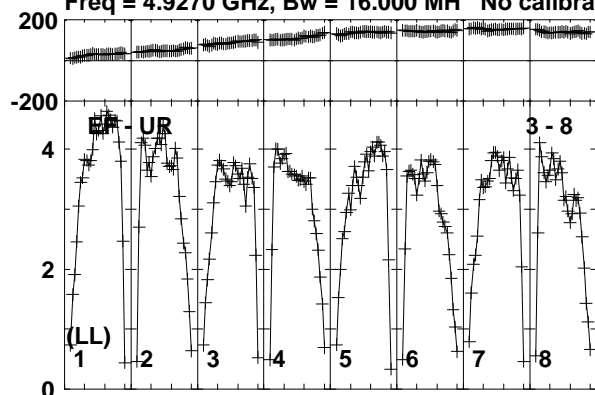

Lower frame: Milli Ampl Jy Top frame: Phas deg  
Vector averaged cross-power spectrum Baseline: EF (03) - UR (08)  
Timerange: 00/09:33:31 to 00/09:34:29

Plot file version 150 created 19-DEC-2018 17:58:22

J1619+2247 RY007C.UVDATA.1

Freq = 4.9270 GHz, Bw = 16.000 MH No calibration applied and no bandpass applied

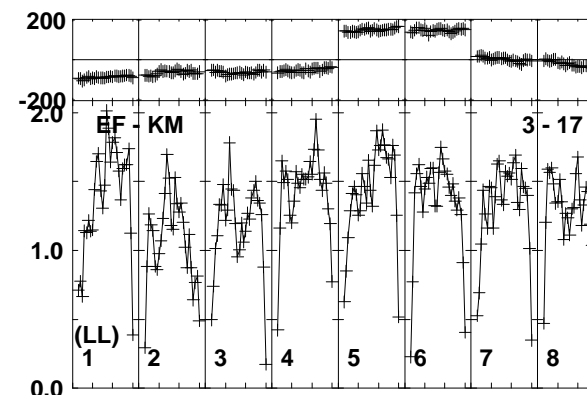
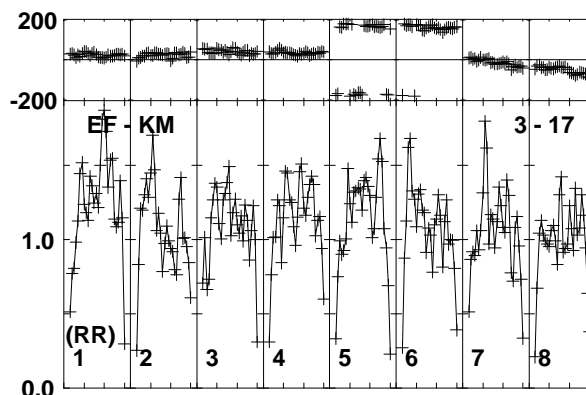
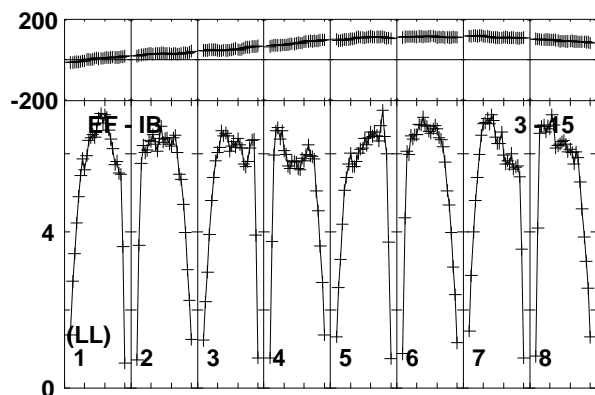
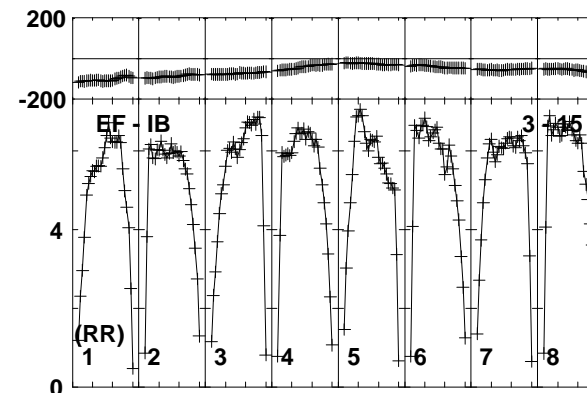
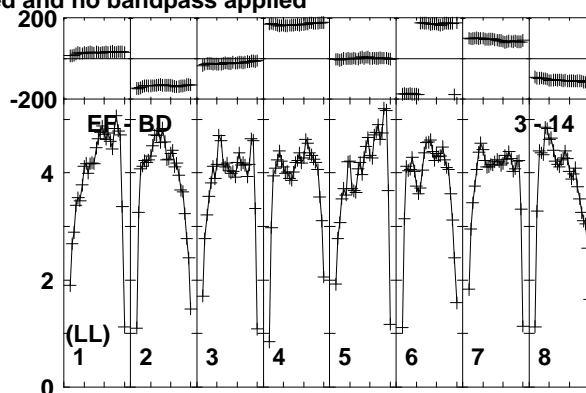
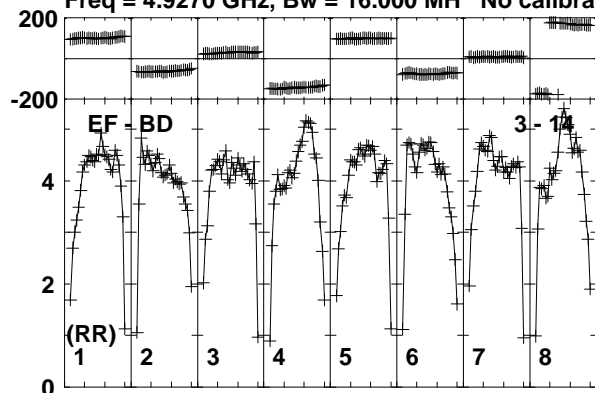

Lower frame: Milli Ampl Jy Top frame: Phas deg  
Vector averaged cross-power spectrum Baseline: EF (03) - BD (14)  
Timerange: 00/09:33:31 to 00/09:34:29

Plot file version 151 created 19-DEC-2018 17:58:22

VLA1 RY007C.UVDATA.1

Freq = 4.9270 GHz, Bw = 16.000 MH No calibration applied and no bandpass applied

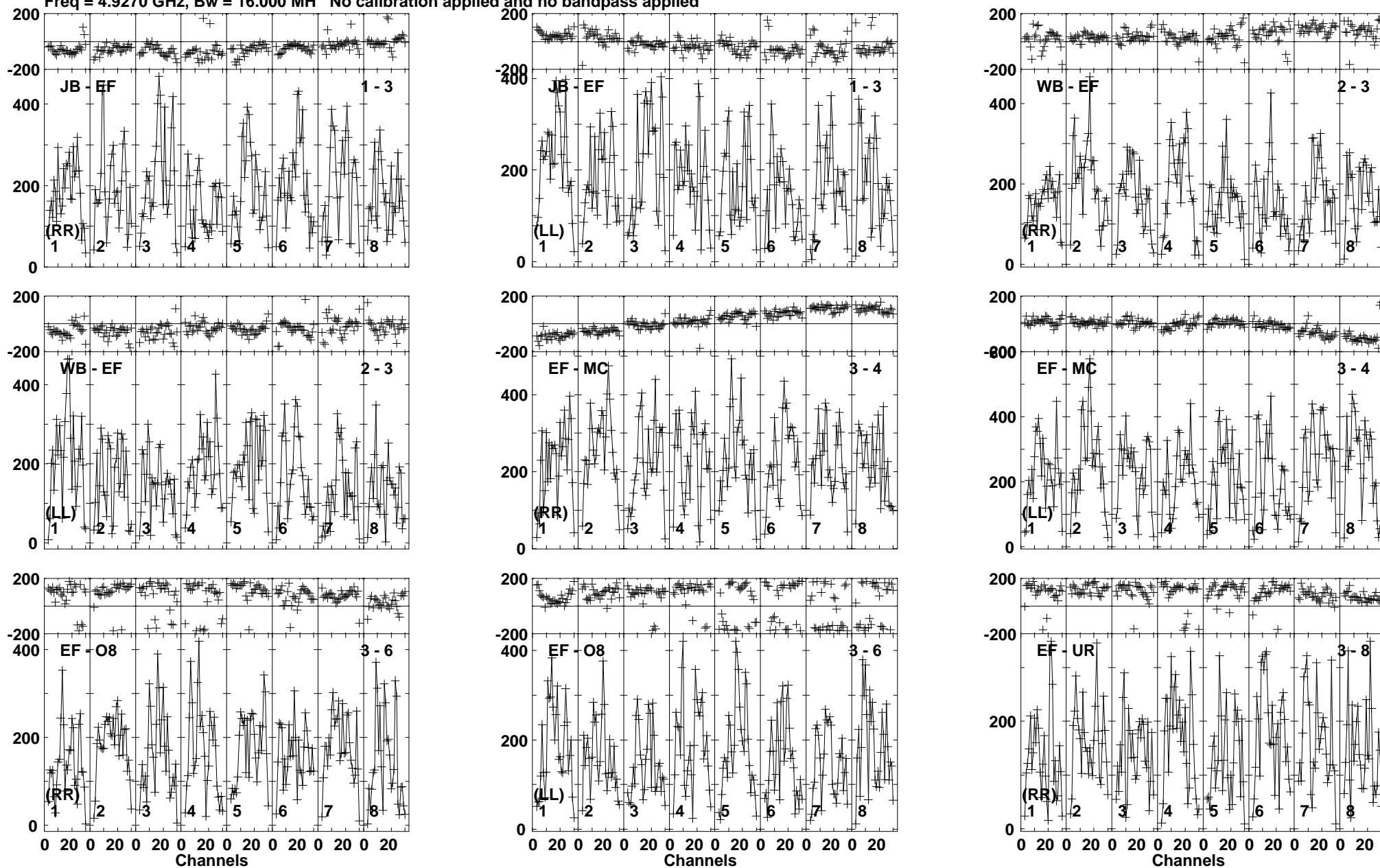

Lower frame: Micro Ampl Jy Top frame: Phas deg  
Vector averaged cross-power spectrum Baseline: JB (01) - EF (03)  
Timerange: 00/09:35:01 to 00/09:36:59

Plot file version 152 created 19-DEC-2018 17:58:22

VLA1 RY007C.UVDATA.1

Freq = 4.9270 GHz, Bw = 16.000 MH No calibration applied and no bandpass applied

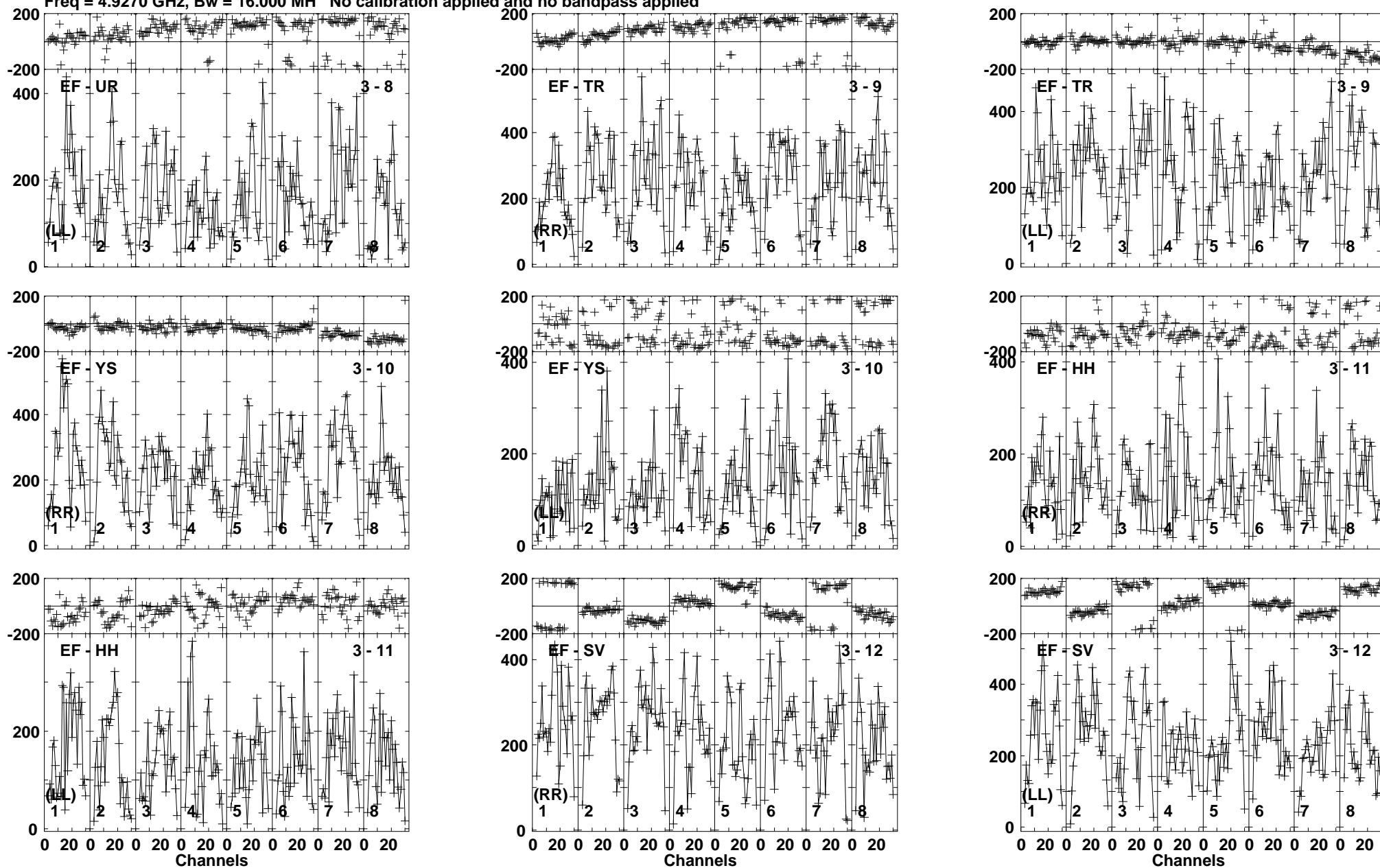

Lower frame: Micro Ampl Jy Top frame: Phas deg  
Vector averaged cross-power spectrum Baseline: EF (03) - UR (08)  
Timerange: 00/09:35:01 to 00/09:36:59

Plot file version 153 created 19-DEC-2018 17:58:22

VLA1 RY007C.UVDATA.1

Freq = 4.9270 GHz, Bw = 16.000 MH No calibration applied and no bandpass applied

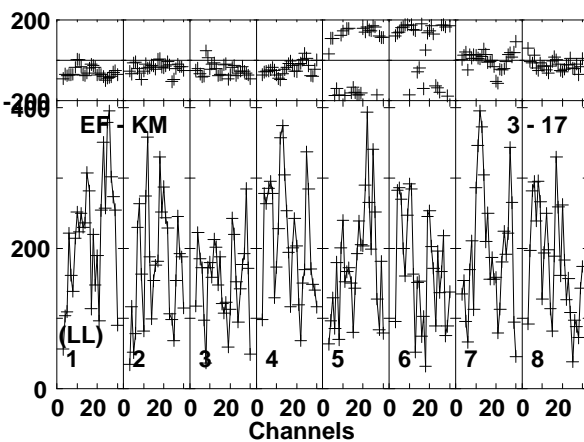
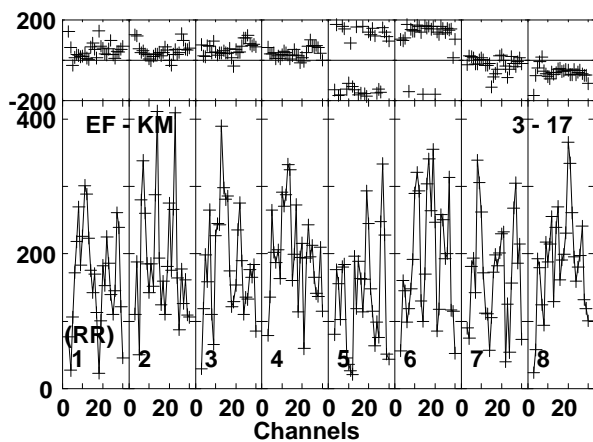
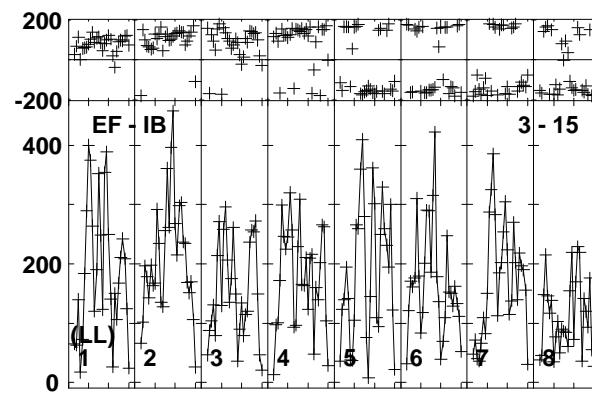
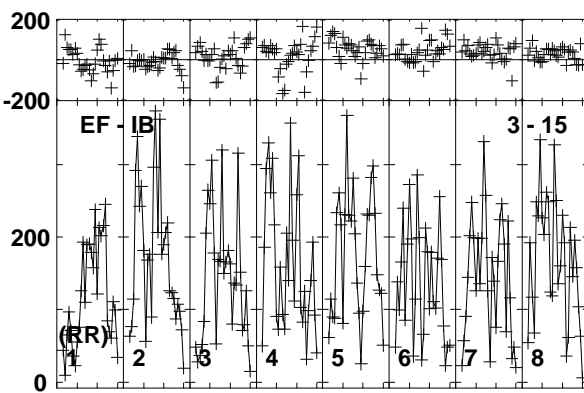
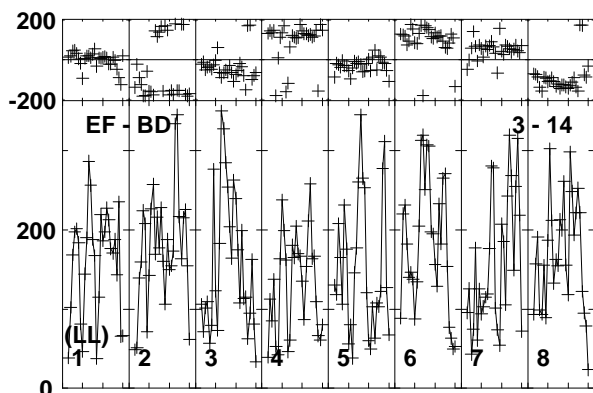
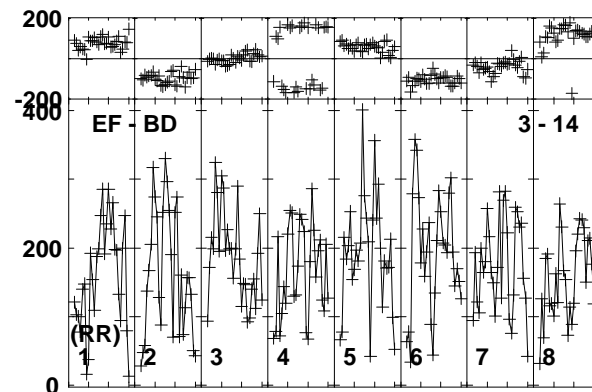
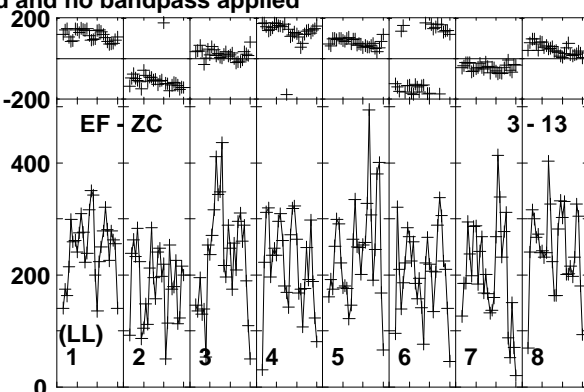
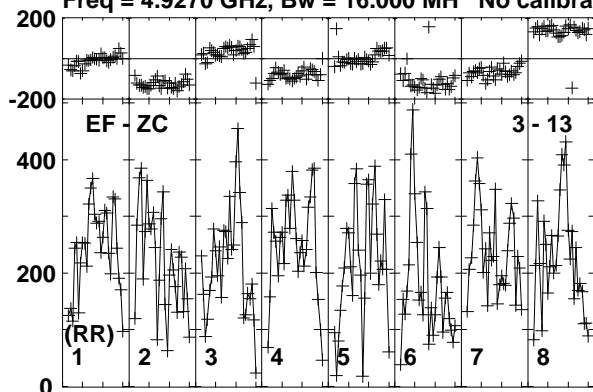

Lower frame: Micro Ampl Jy Top frame: Phas deg  
Vector averaged cross-power spectrum Baseline: EF (03) - ZC (13)  
Timerange: 00/09:35:01 to 00/09:36:59

Plot file version 154 created 19-DEC-2018 17:58:22

J1619+2247 RY007C.UVDATA.1

Freq = 4.9270 GHz, Bw = 16.000 MH No calibration applied and no bandpass applied

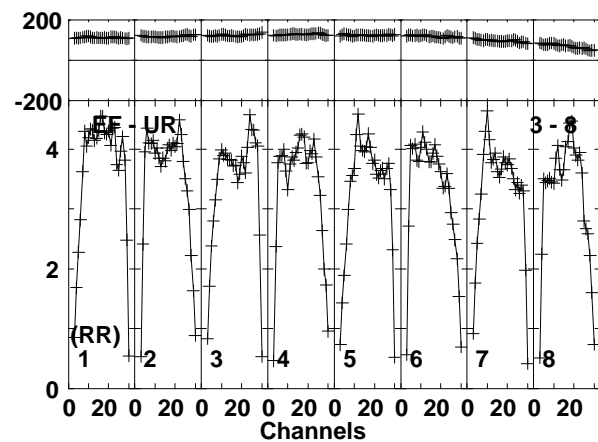
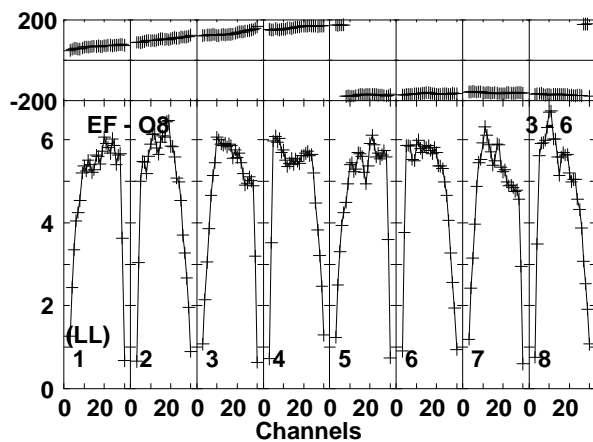
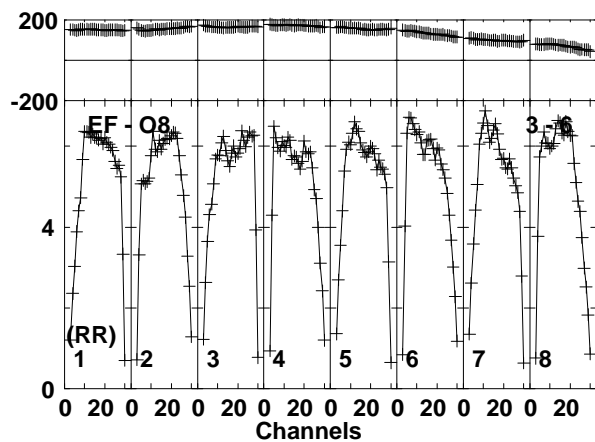
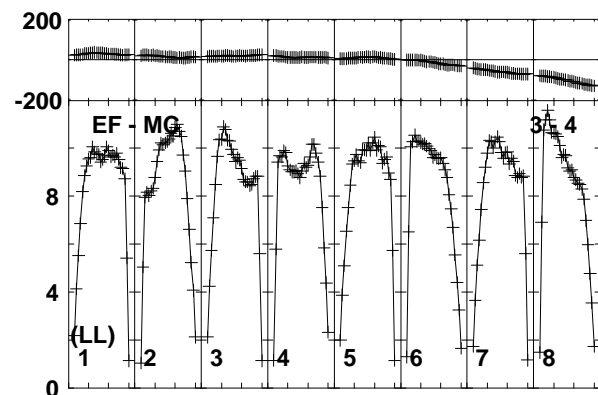
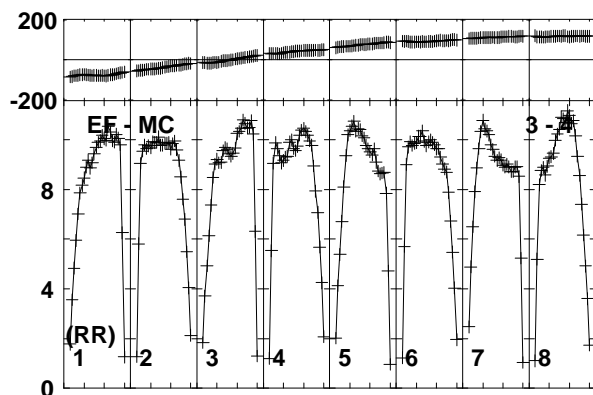
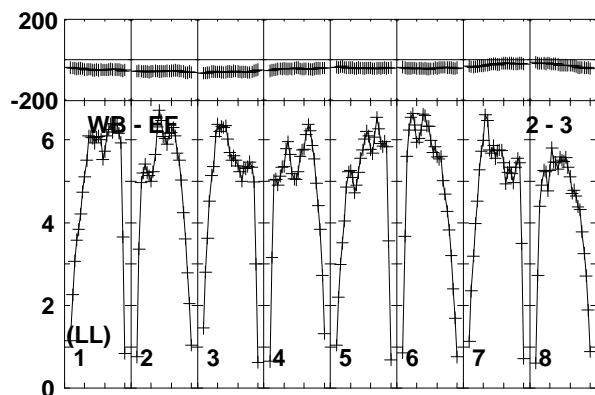
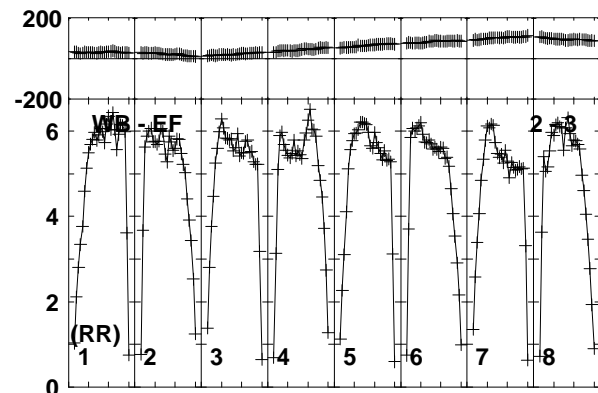
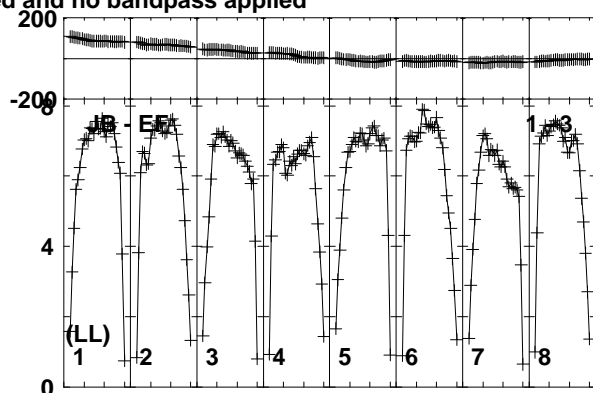
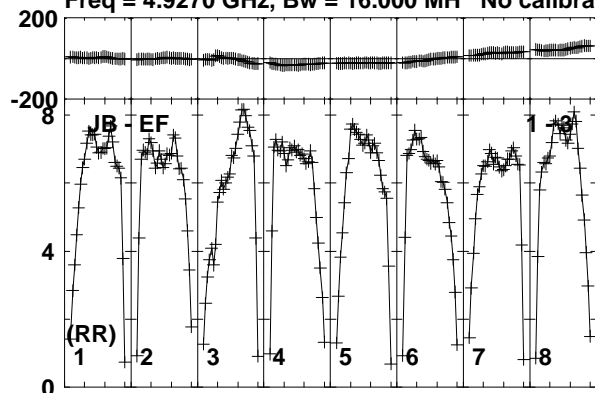

Lower frame: Milli Ampl Jy Top frame: Phas deg  
Vector averaged cross-power spectrum Baseline: JB (01) - EF (03)  
Timerange: 00/09:37:01 to 00/09:37:59



Plot file version 155 created 19-DEC-2018 17:58:22

J1619+2247 RY007C.UVDATA.1

Freq = 4.9270 GHz, Bw = 16.000 MH No calibration applied and no bandpass applied

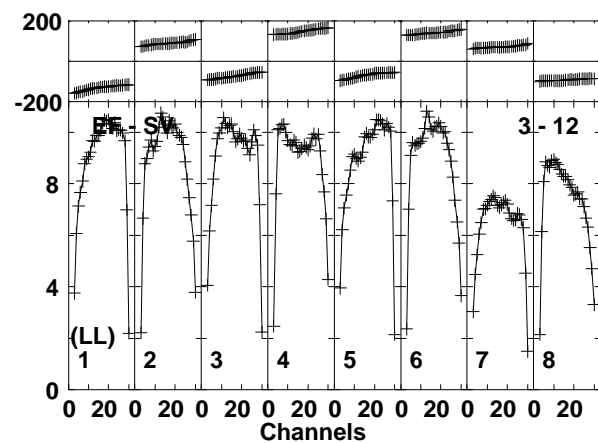
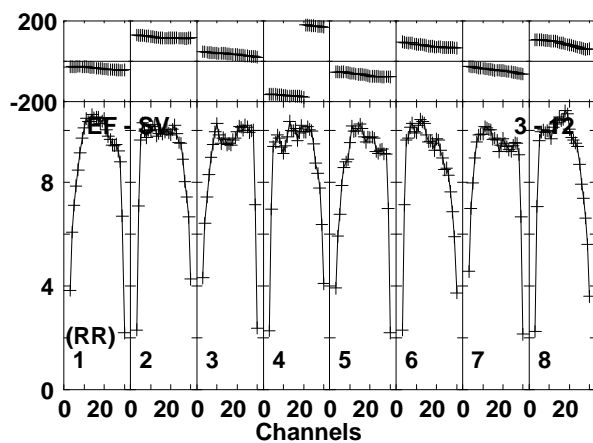
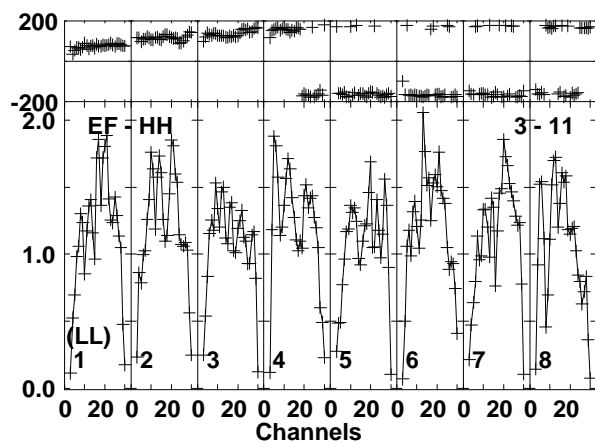
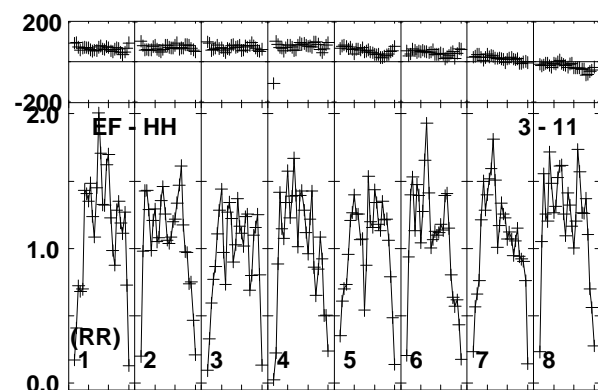
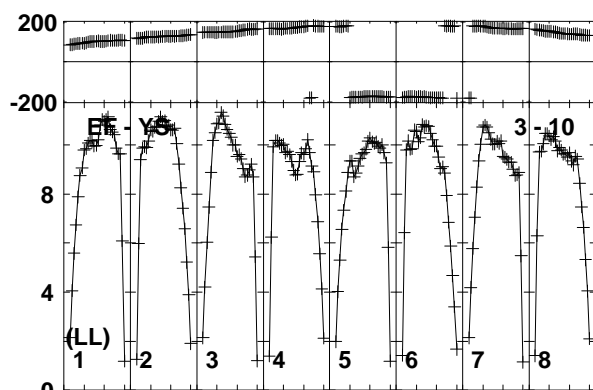
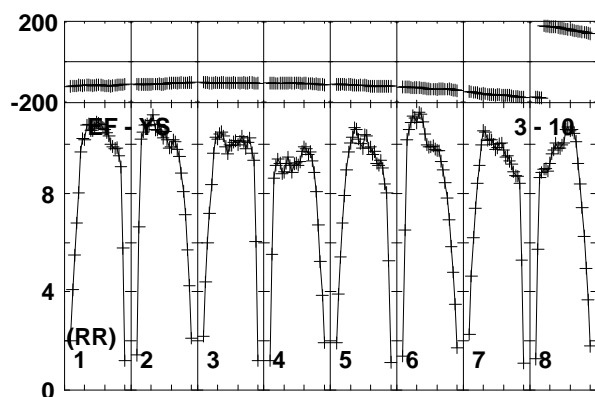
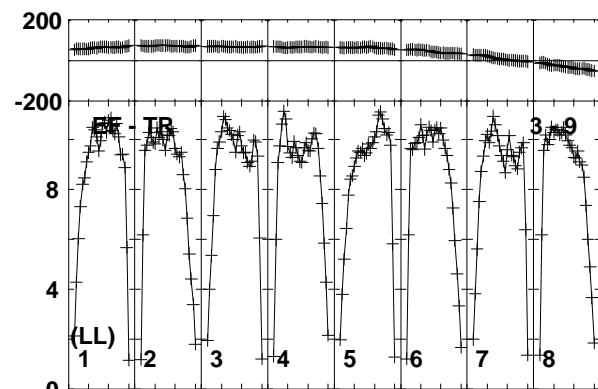
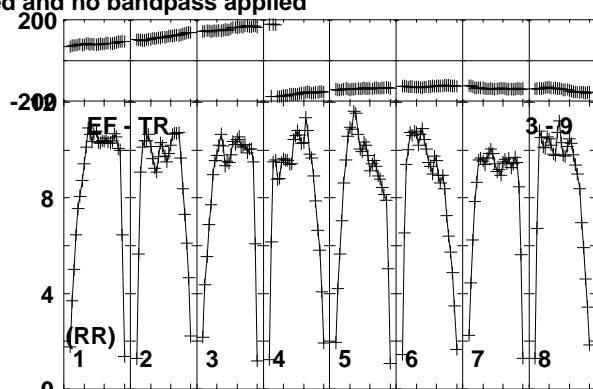
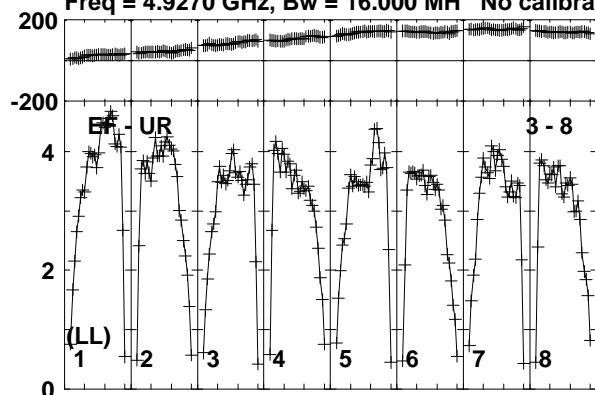

Lower frame: Milli Ampl Jy Top frame: Phas deg  
Vector averaged cross-power spectrum Baseline: EF (03) - UR (08)  
Timerange: 00/09:37:01 to 00/09:37:59

Plot file version 156 created 19-DEC-2018 17:58:22

J1619+2247 RY007C.UVDATA.1

Freq = 4.9270 GHz, Bw = 16.000 MH No calibration applied and no bandpass applied

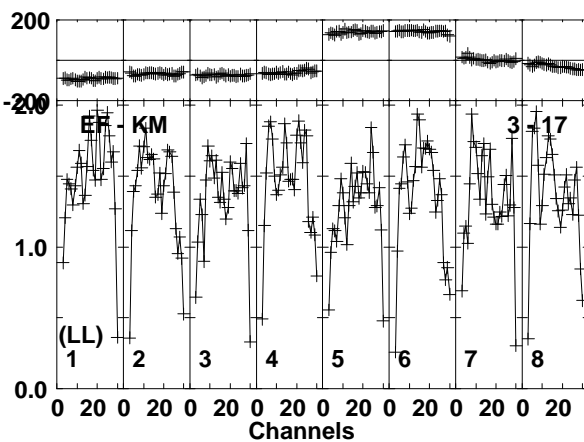
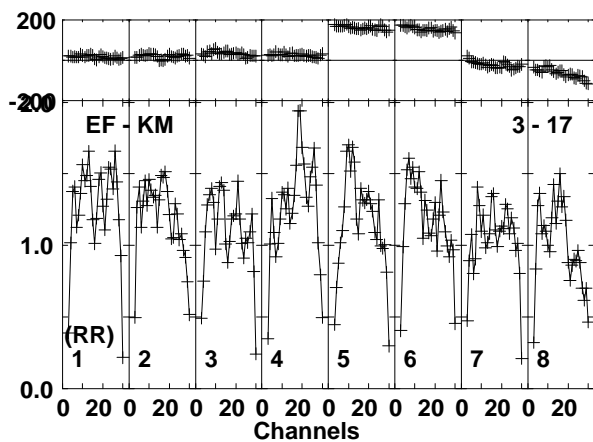
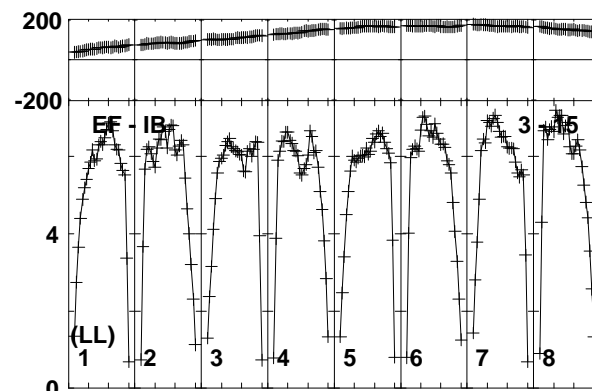
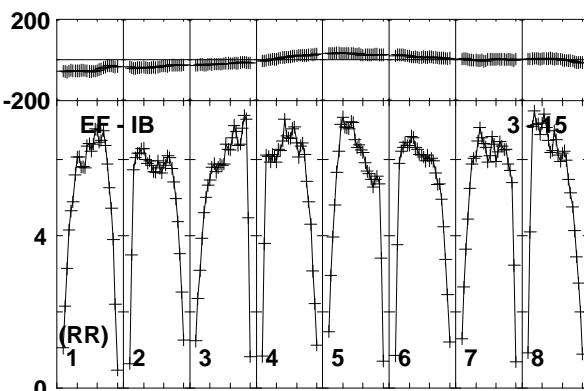
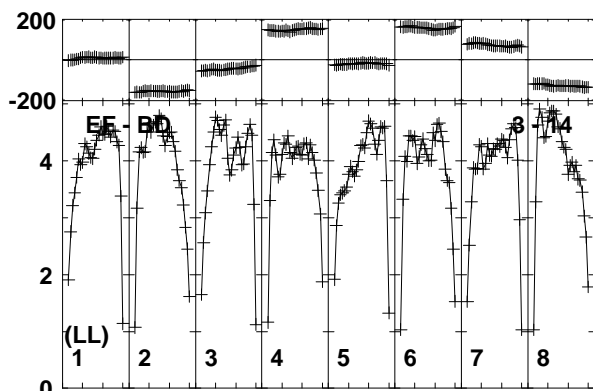
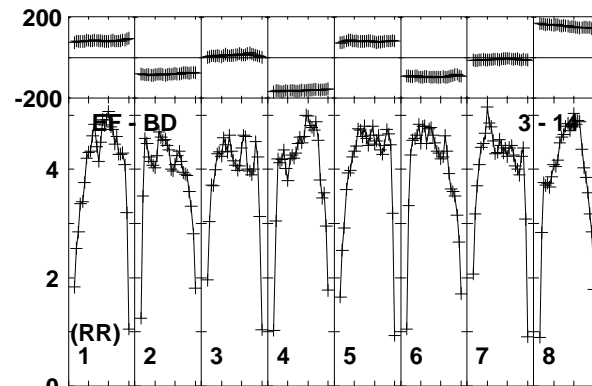
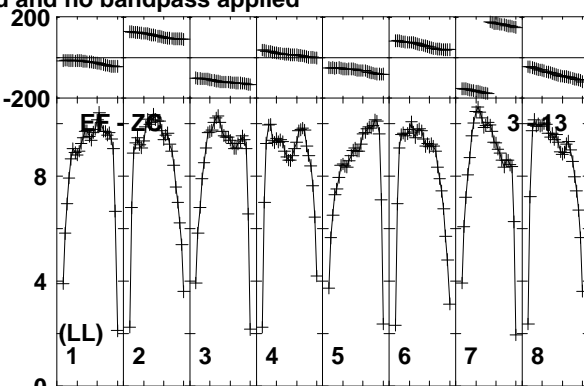
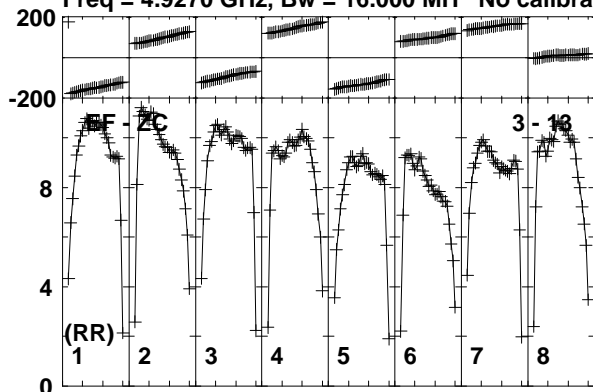

Lower frame: Milli Ampl Jy Top frame: Phas deg  
Vector averaged cross-power spectrum Baseline: EF (03) - ZC (13)  
Timerange: 00/09:37:01 to 00/09:37:59

Plot file version 157 created 19-DEC-2018 17:58:22

AT2018\_RY007C.UVDATA.1

Freq = 4.9270 GHz, Bw = 16.000 MH No calibration applied and no bandpass applied

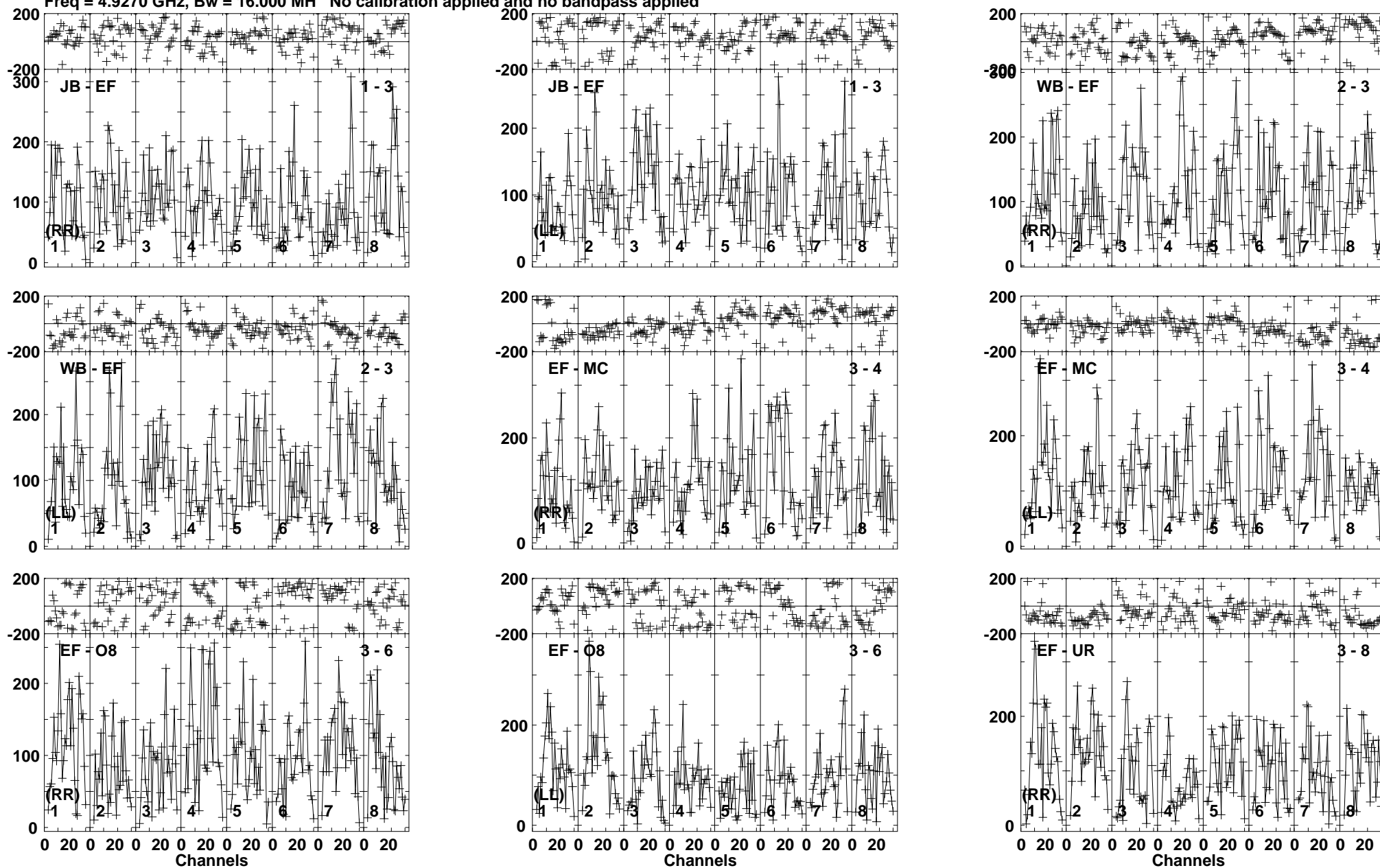

Lower frame: Micro Ampl Jy Top frame: Phas deg  
Vector averaged cross-power spectrum Baseline: JB (01) - EF (03)  
Timerange: 00/09:38:01 to 00/09:40:59

Plot file version 158 created 19-DEC-2018 17:58:22

AT2018\_RY007C.UVDATA.1

Freq = 4.9270 GHz, Bw = 16.000 MH No calibration applied and no bandpass applied

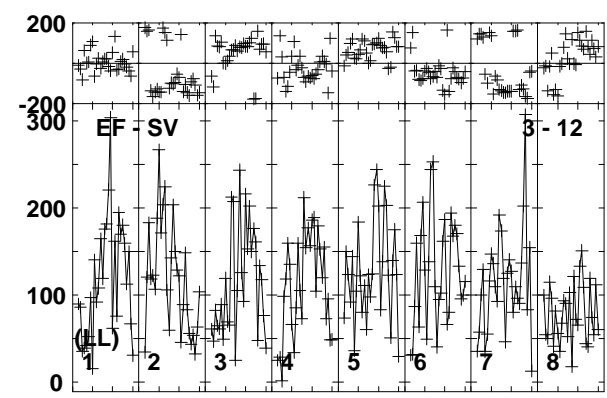
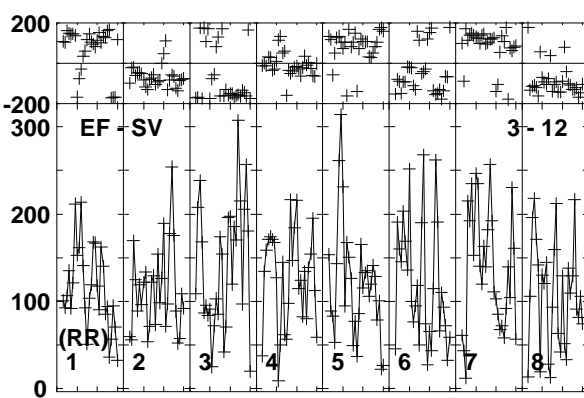
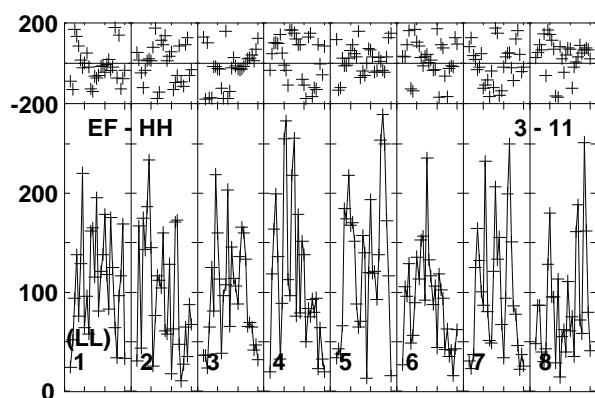
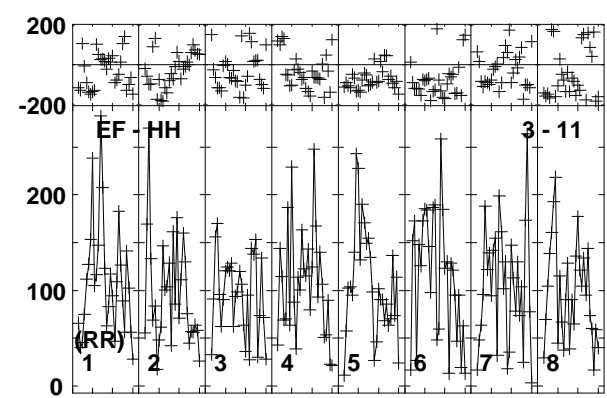
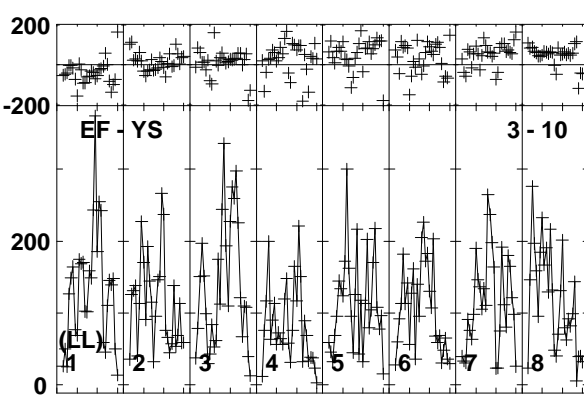
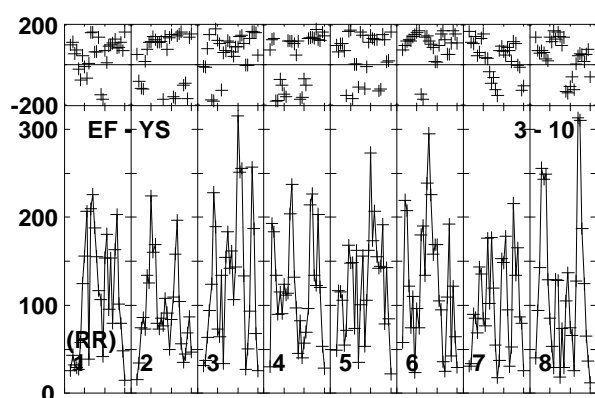
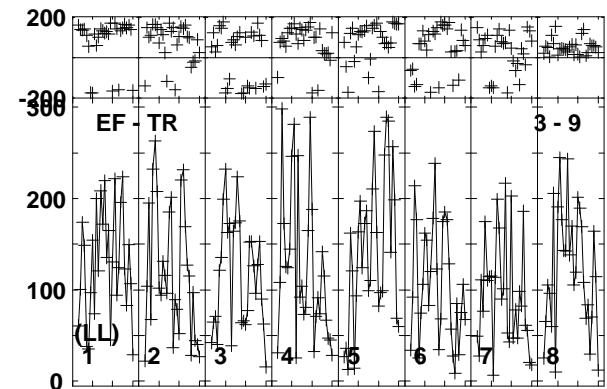
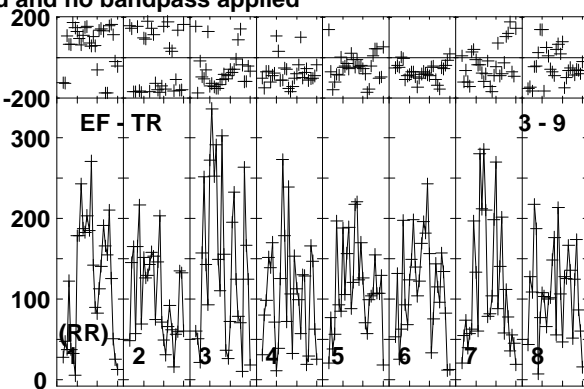
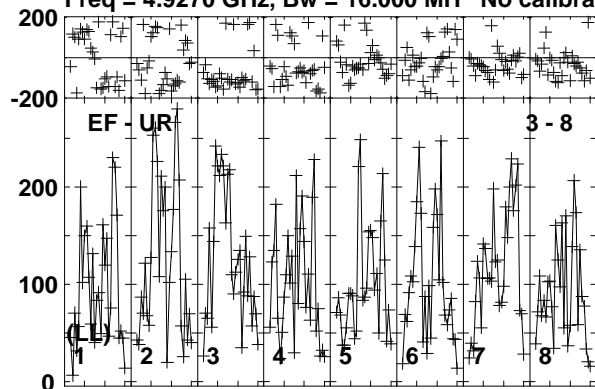

Lower frame: Micro Ampl Jy Top frame: Phas deg  
Vector averaged cross-power spectrum Baseline: EF (03) - UR (08)  
Timerange: 00/09:38:01 to 00/09:40:59

Plot file version 159 created 19-DEC-2018 17:58:23

AT2018\_RY007C.UVDATA.1

Freq = 4.9270 GHz, Bw = 16.000 MH No calibration applied and no bandpass applied

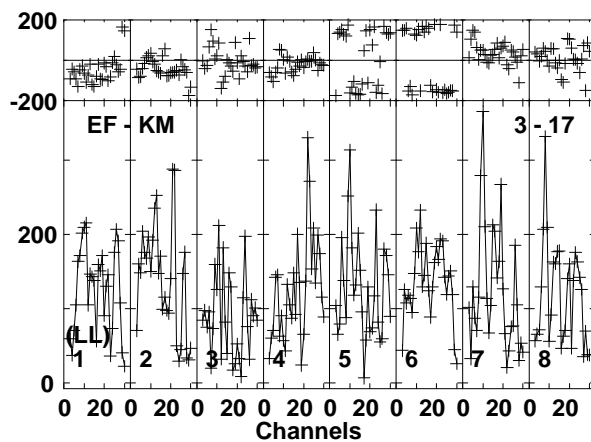
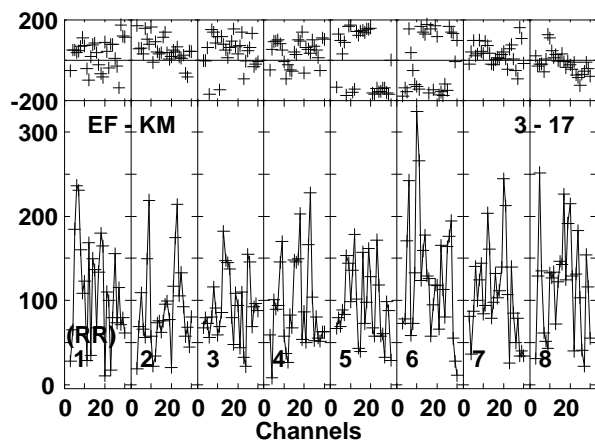
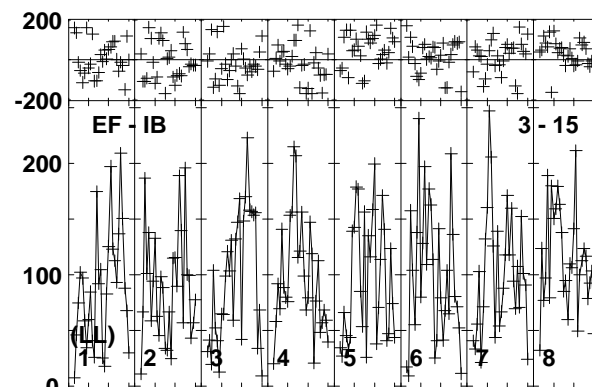
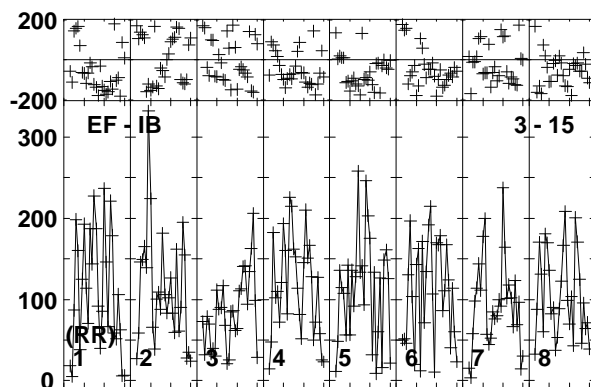
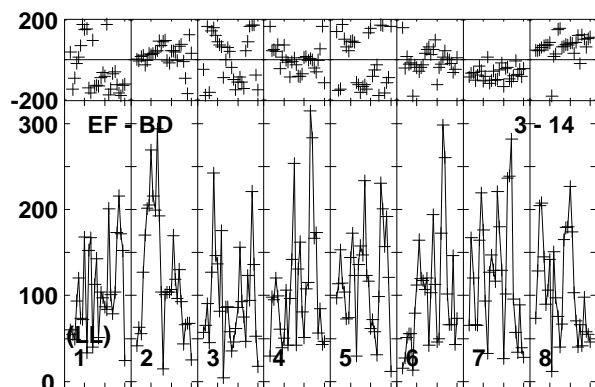
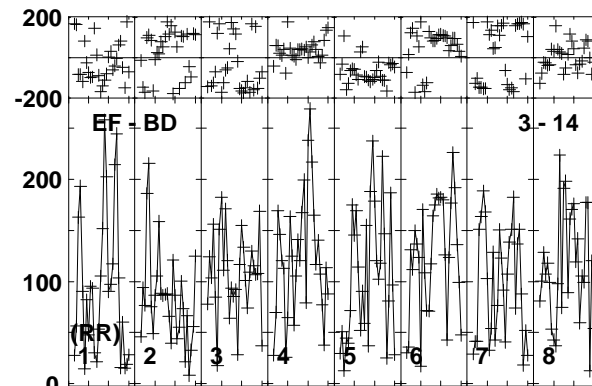
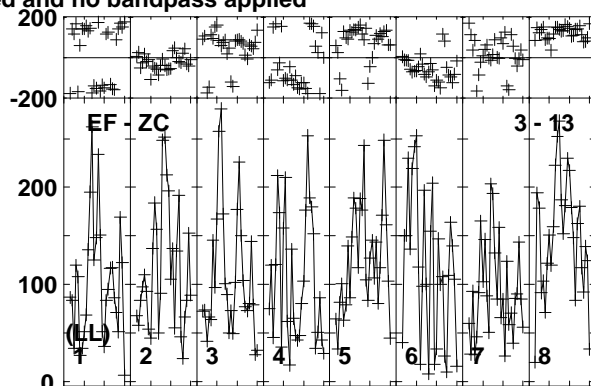
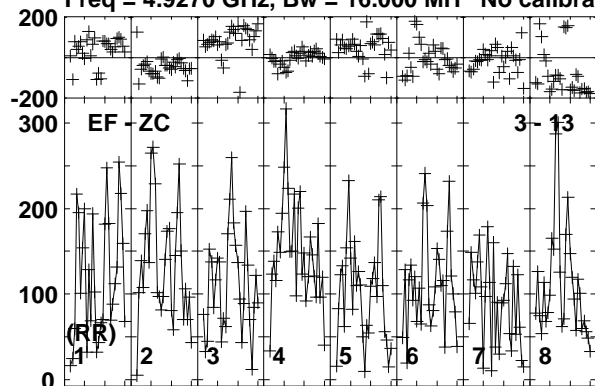

Lower frame: Micro Ampl Jy Top frame: Phas deg  
Vector averaged cross-power spectrum Baseline: EF (03) - ZC (13)  
Timerange: 00/09:38:01 to 00/09:40:59

Plot file version 160 created 19-DEC-2018 17:58:23

J1619+2247 RY007C.UVDATA.1

Freq = 4.9270 GHz, Bw = 16.000 MH No calibration applied and no bandpass applied

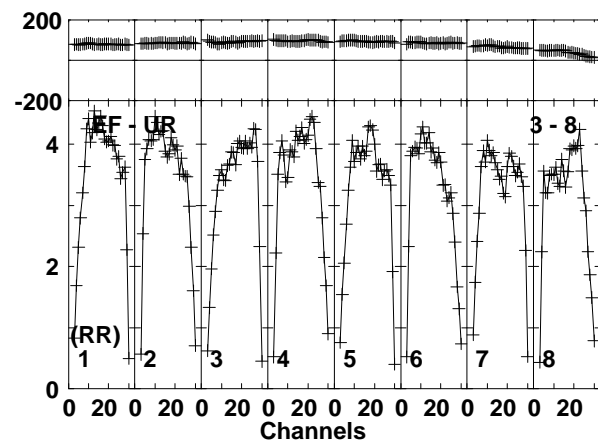
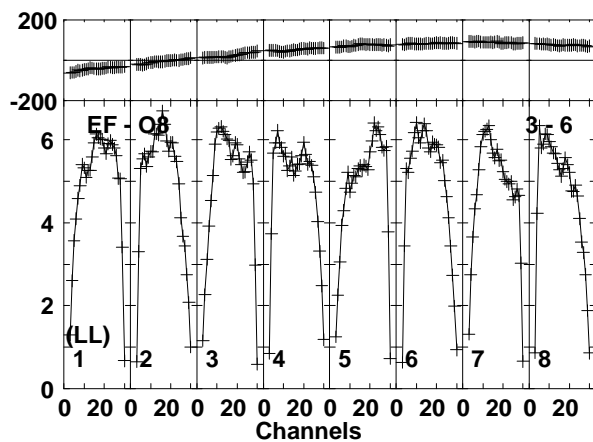
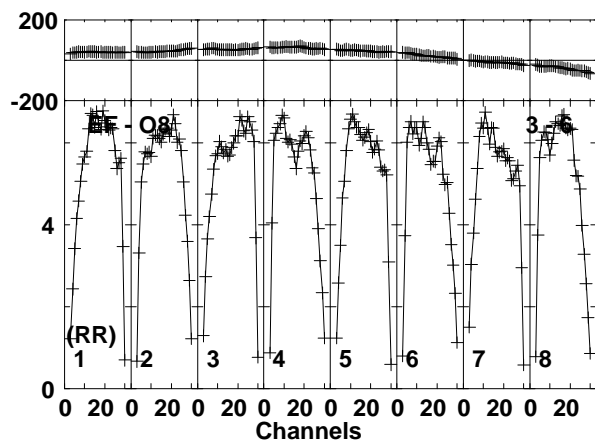
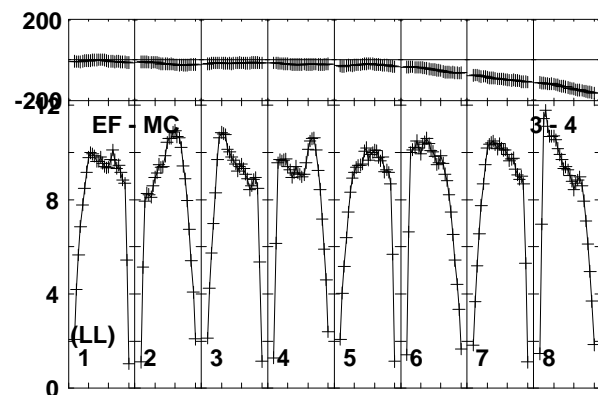
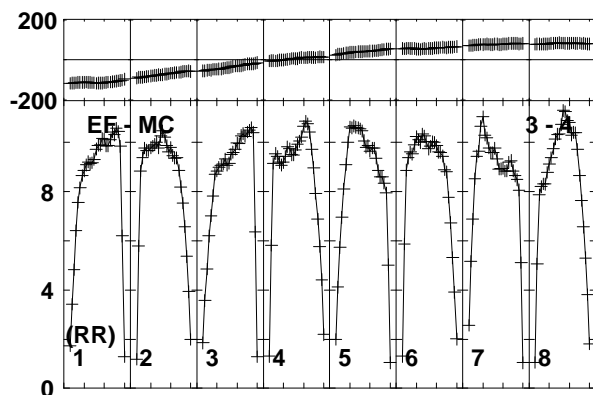
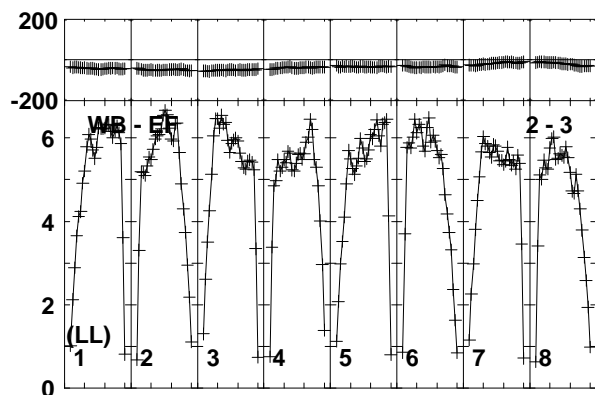
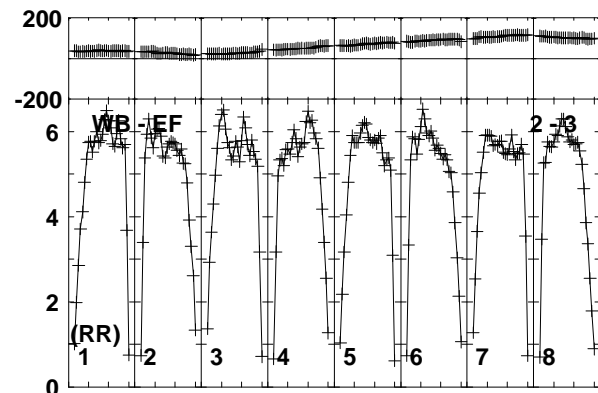
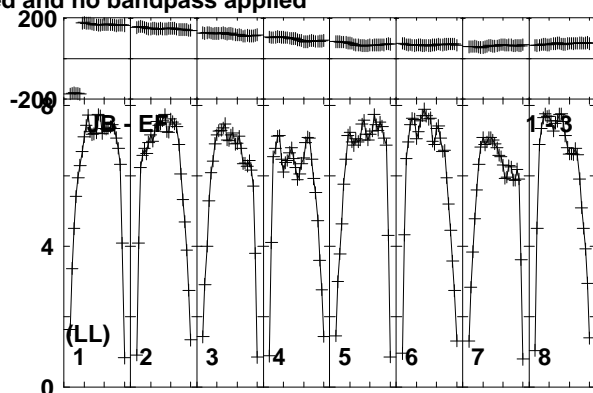
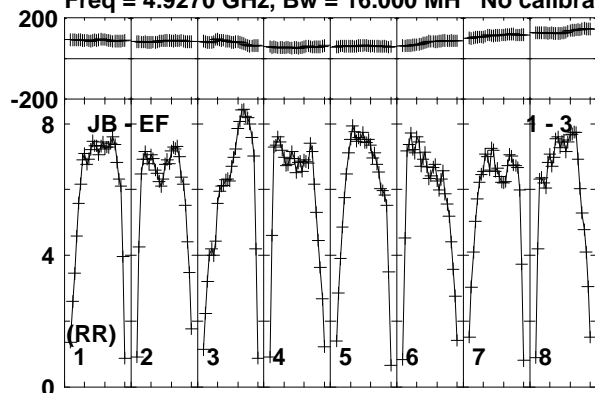

Lower frame: Milli Ampl Jy Top frame: Phas deg  
Vector averaged cross-power spectrum Baseline: JB (01) - EF (03)  
Timerange: 00/09:41:01 to 00/09:41:59

Plot file version 161 created 19-DEC-2018 17:58:23

J1619+2247 RY007C.UVDATA.1

Freq = 4.9270 GHz, Bw = 16.000 MH No calibration applied and no bandpass applied

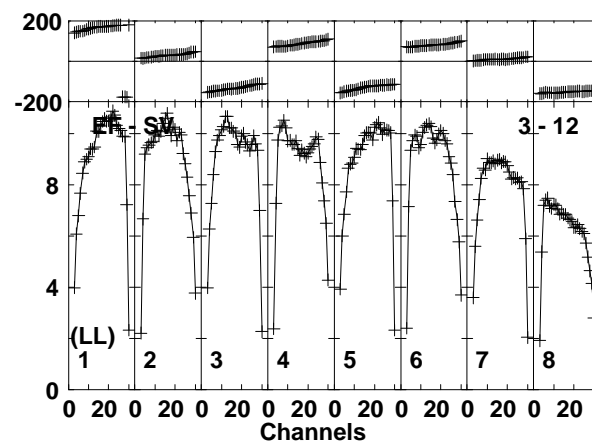
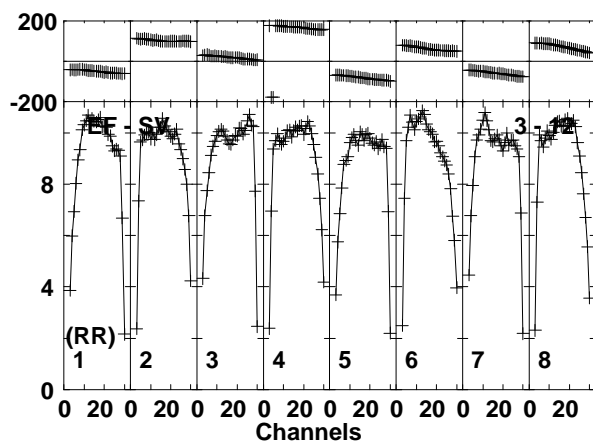
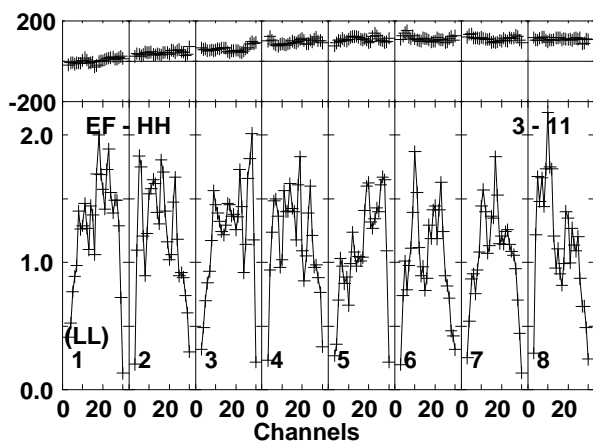
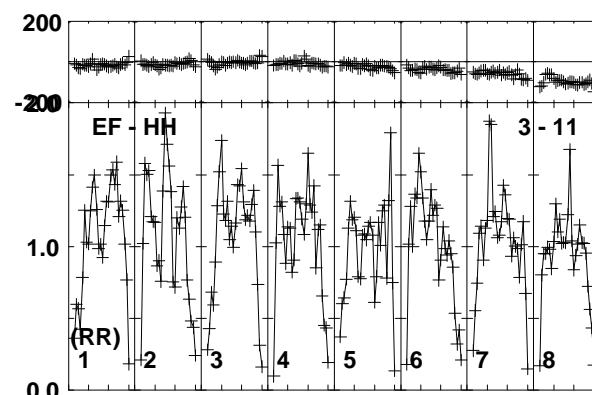
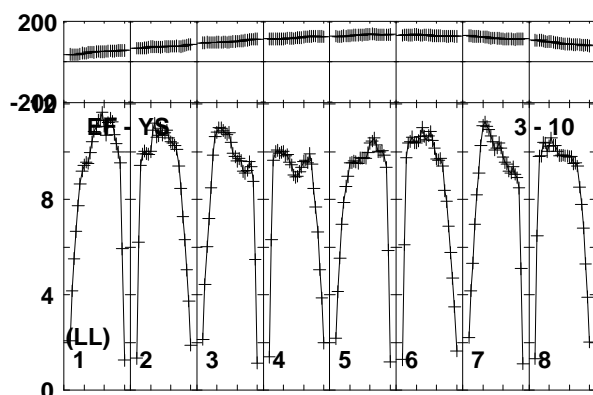
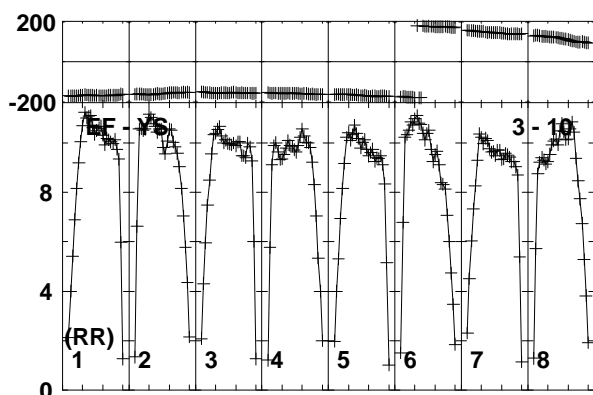
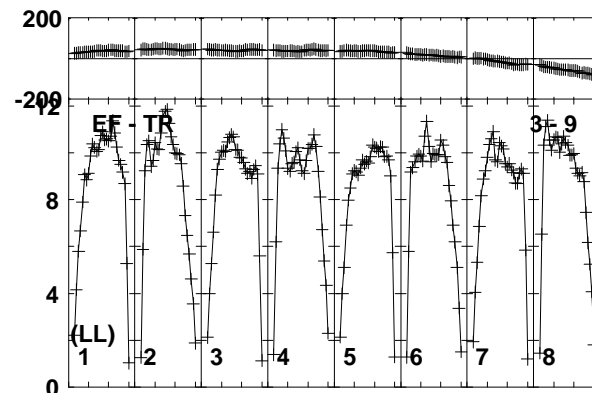
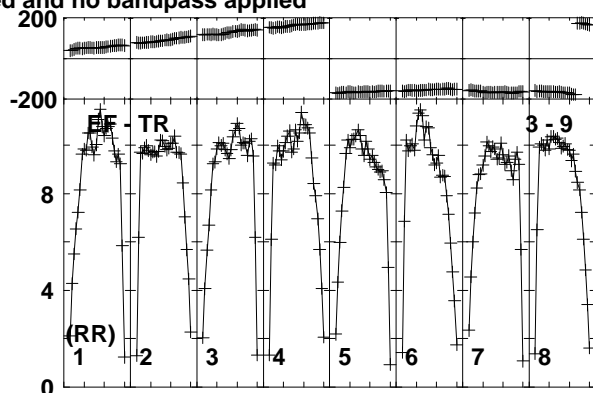
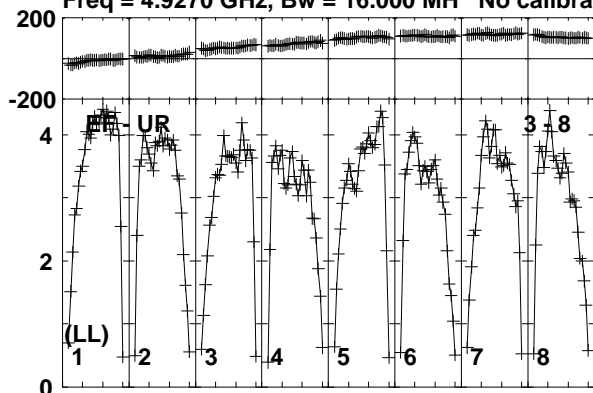

Lower frame: Milli Ampl Jy Top frame: Phas deg  
Vector averaged cross-power spectrum Baseline: EF (03) - UR (08)  
Timerange: 00/09:41:01 to 00/09:41:59

Plot file version 162 created 19-DEC-2018 17:58:23

J1619+2247 RY007C.UVDATA.1

Freq = 4.9270 GHz, Bw = 16.000 MH No calibration applied and no bandpass applied

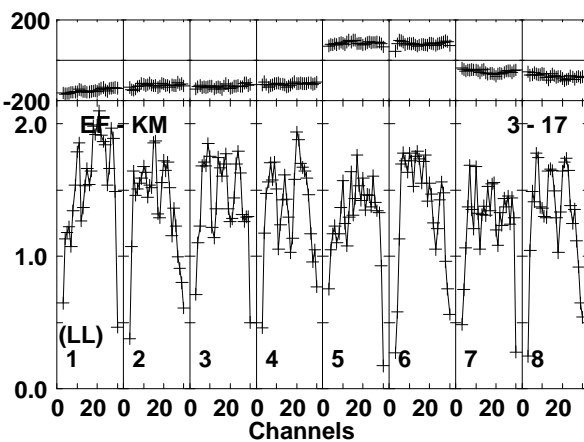
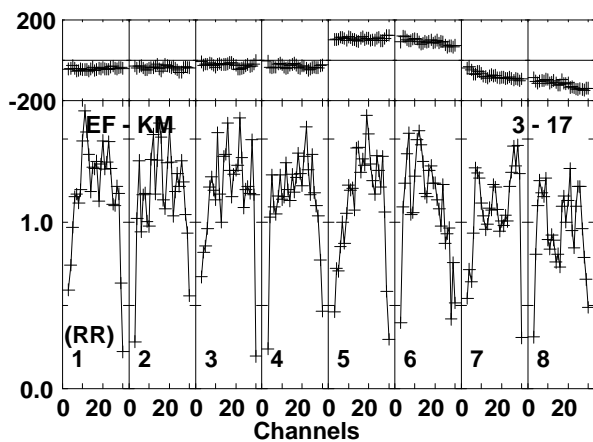
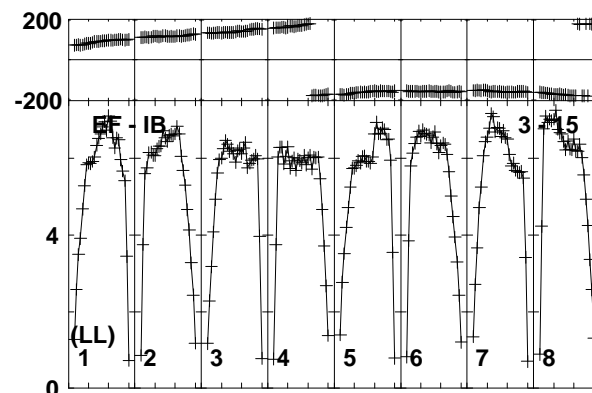
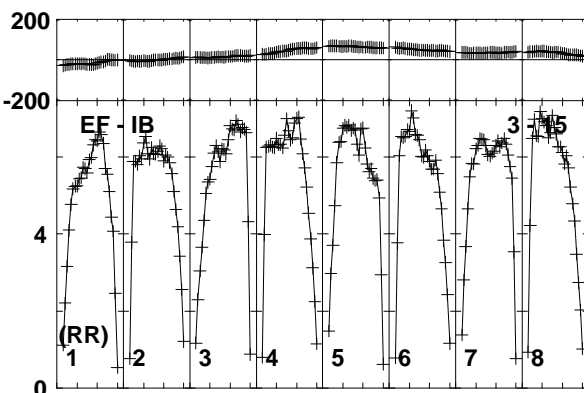
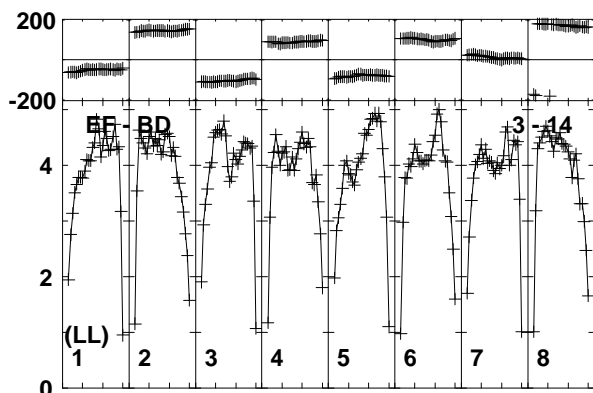
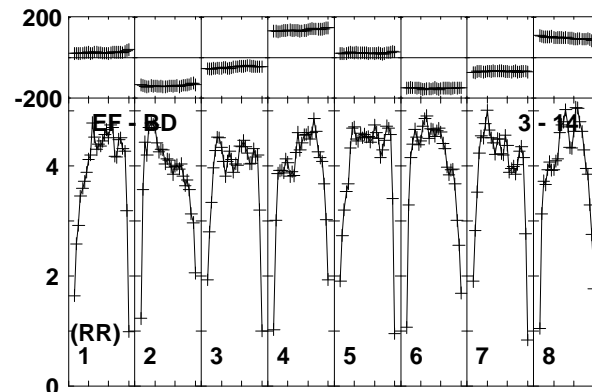
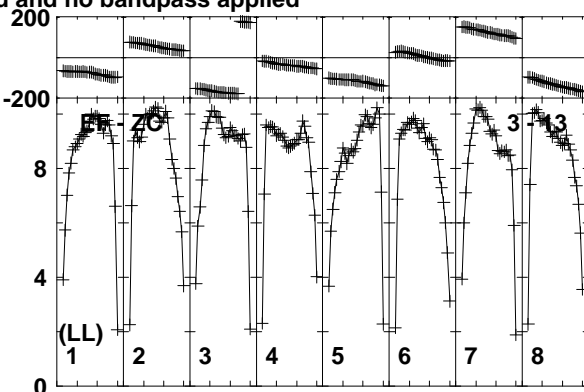
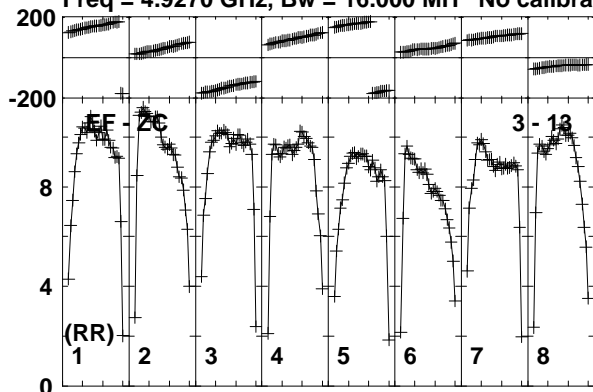

Lower frame: Milli Ampl Jy Top frame: Phas deg  
Vector averaged cross-power spectrum Baseline: EF (03) - ZC (13)  
Timerange: 00/09:41:01 to 00/09:41:59



Plot file version 163 created 19-DEC-2018 17:58:23

AT2018\_RY007C.UVDATA.1

Freq = 4.9270 GHz, Bw = 16.000 MH No calibration applied and no bandpass applied

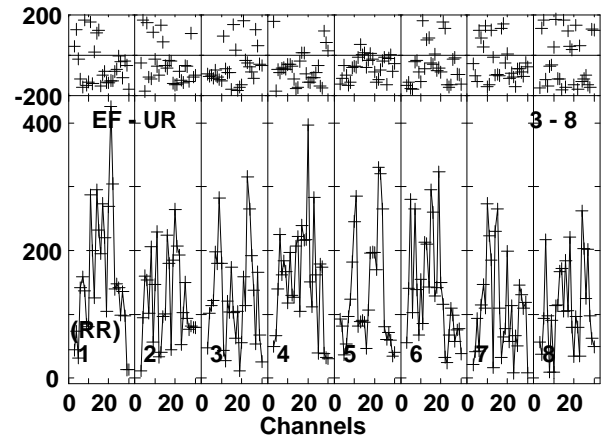
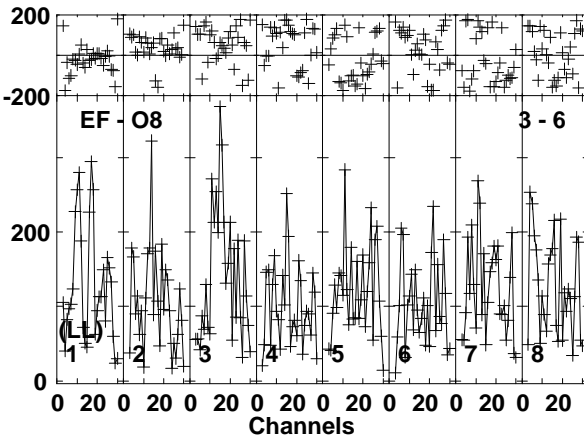
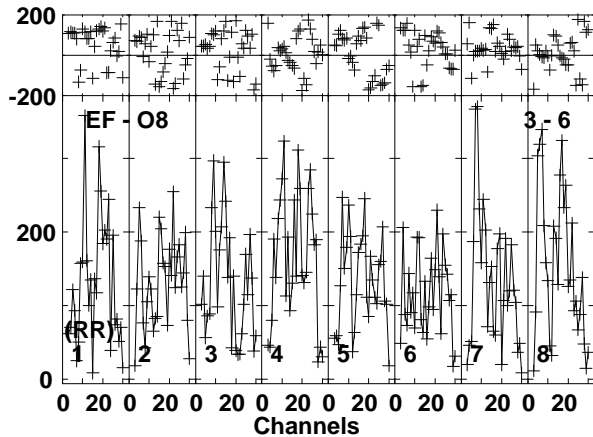
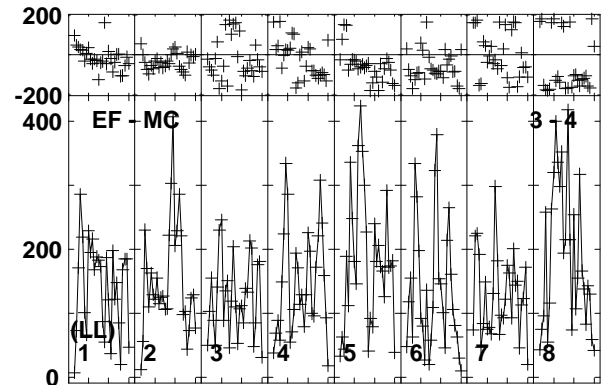
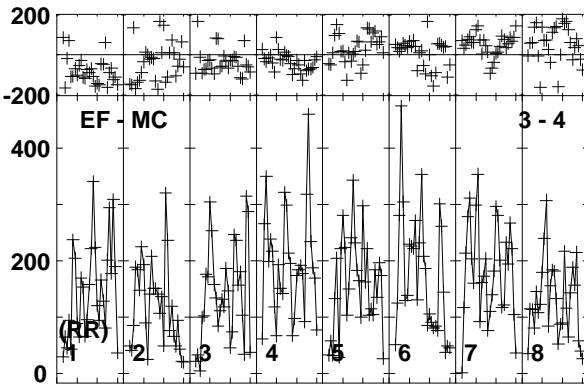
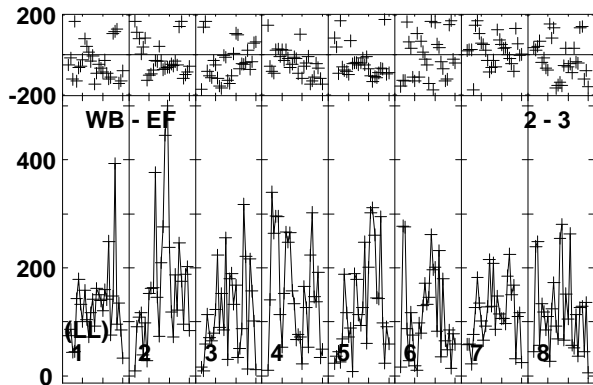
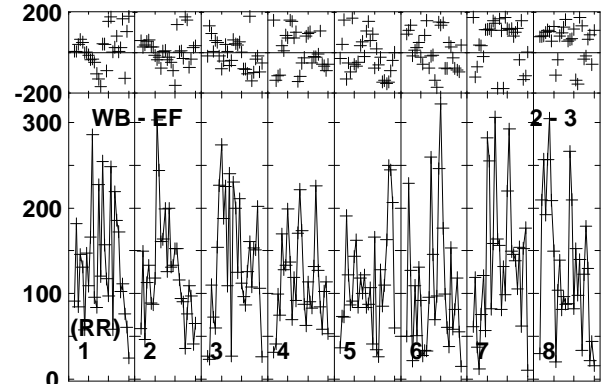
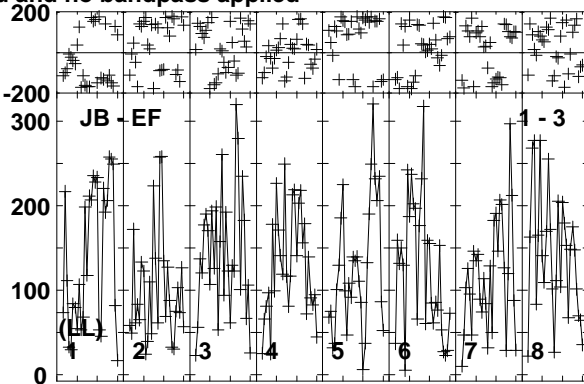
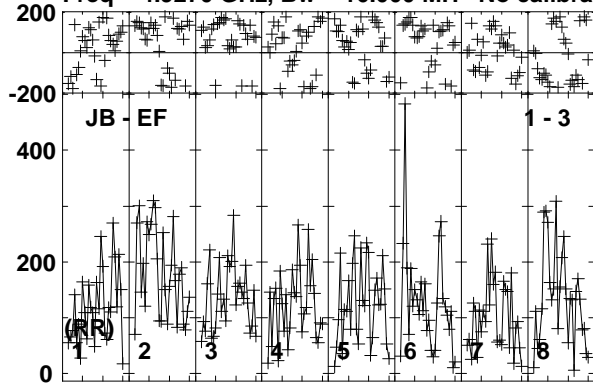

Lower frame: Micro Ampl Jy Top frame: Phas deg  
Vector averaged cross-power spectrum Baseline: JB (01) - EF (03)  
Timerange: 00/09:42:01 to 00/09:43:59

Plot file version 164 created 19-DEC-2018 17:58:23

AT2018\_RY007C.UVDATA.1

Freq = 4.9270 GHz, Bw = 16.000 MH No calibration applied and no bandpass applied

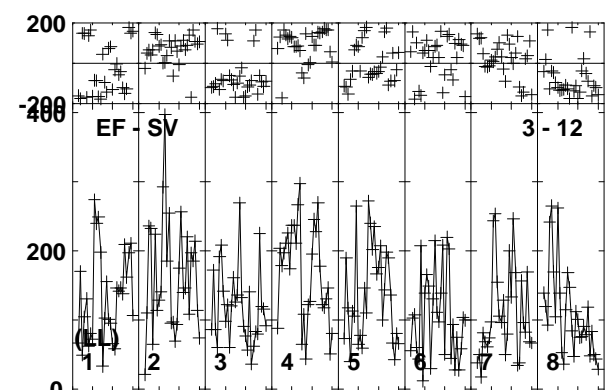
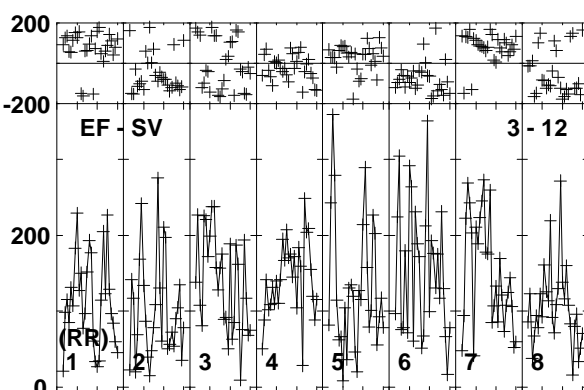
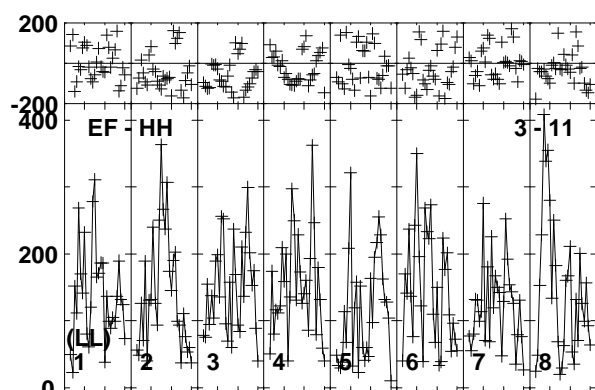
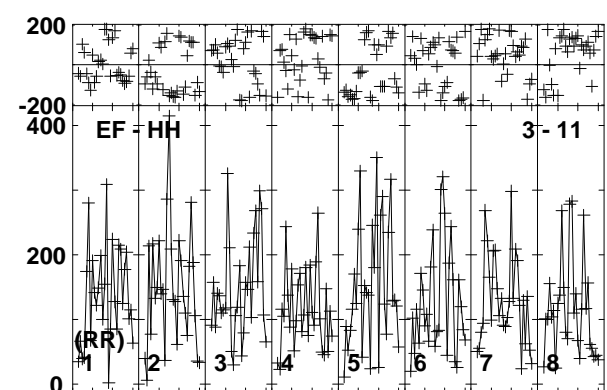
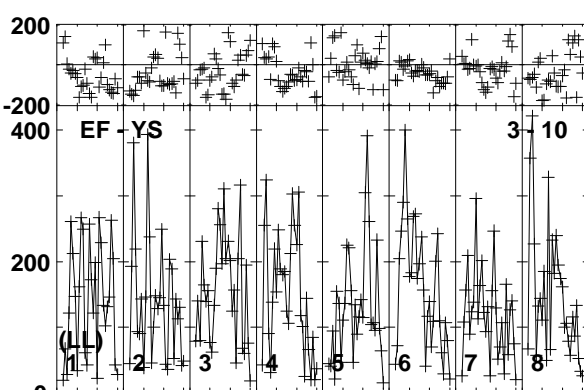
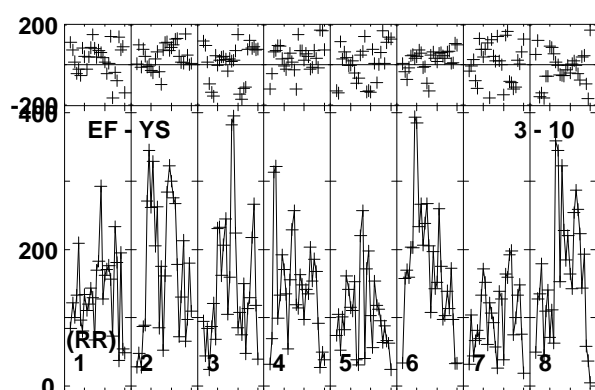
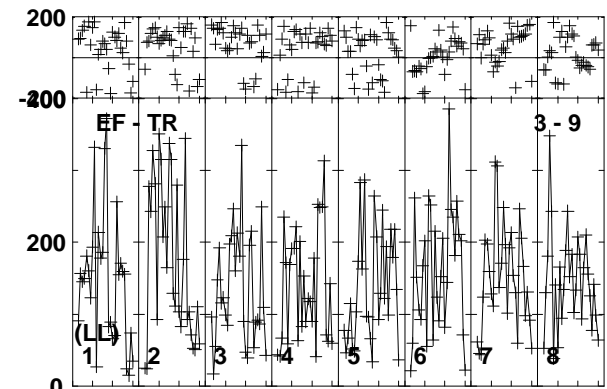
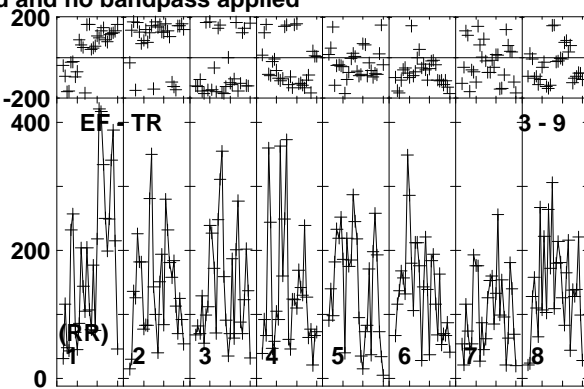
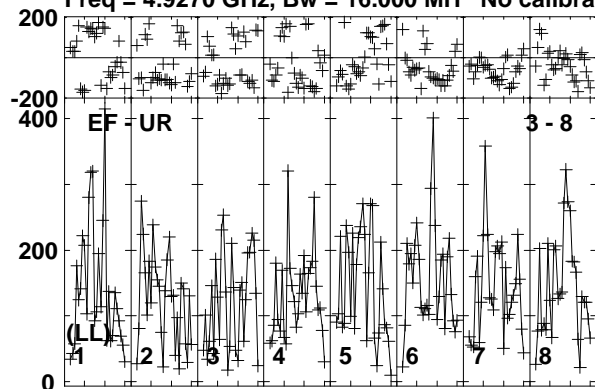

Lower frame: Micro Ampl Jy Top frame: Phas deg  
Vector averaged cross-power spectrum Baseline: EF (03) - UR (08)  
Timerange: 00/09:42:01 to 00/09:43:59

Plot file version 165 created 19-DEC-2018 17:58:23

AT2018\_RY007C.UVDATA.1

Freq = 4.9270 GHz, Bw = 16.000 MH No calibration applied and no bandpass applied

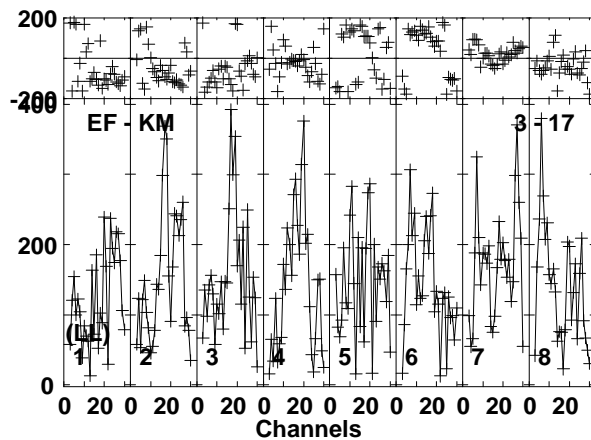
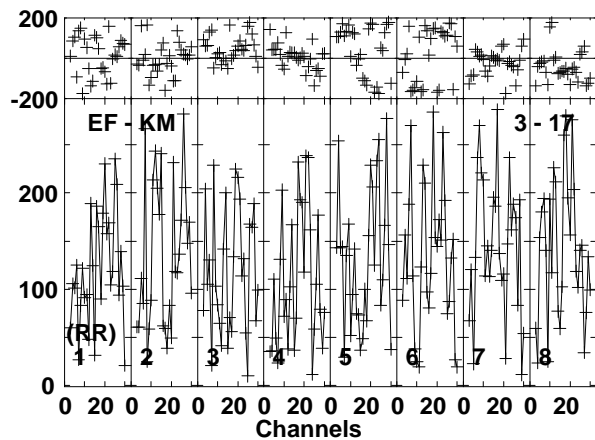
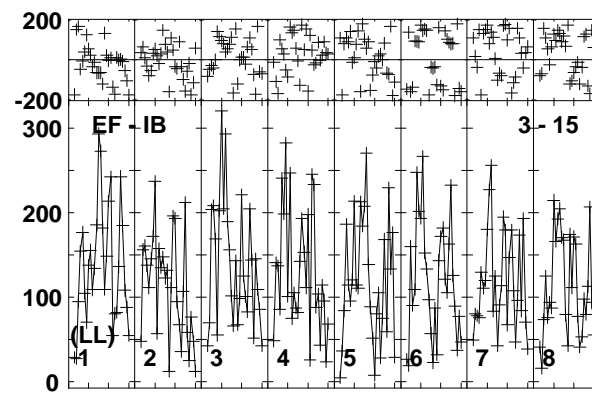
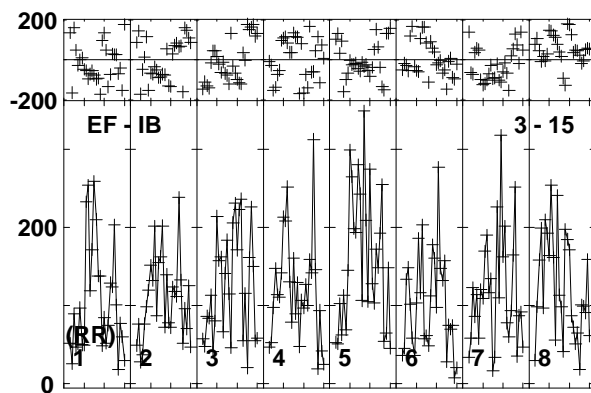
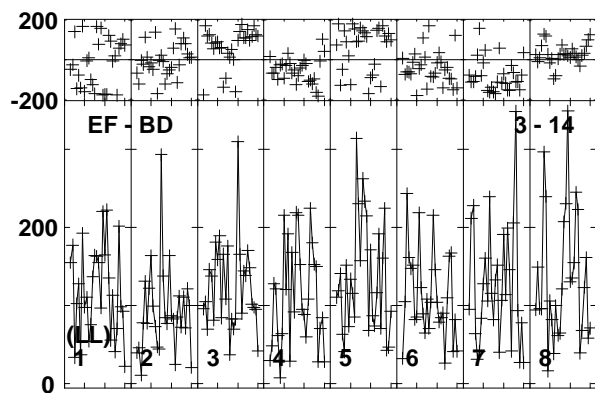
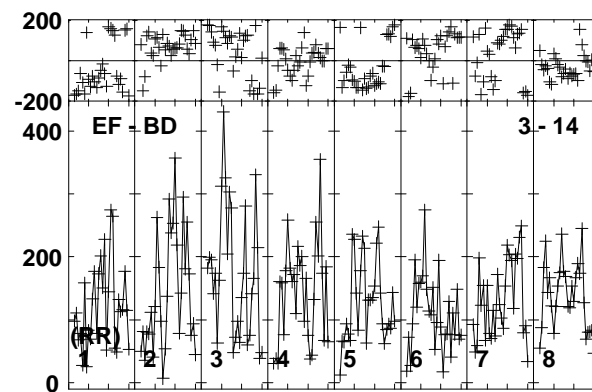
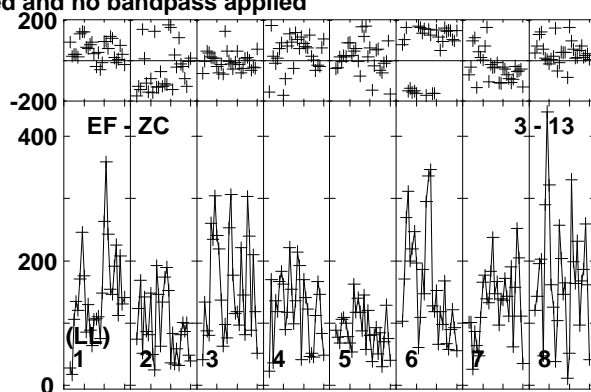
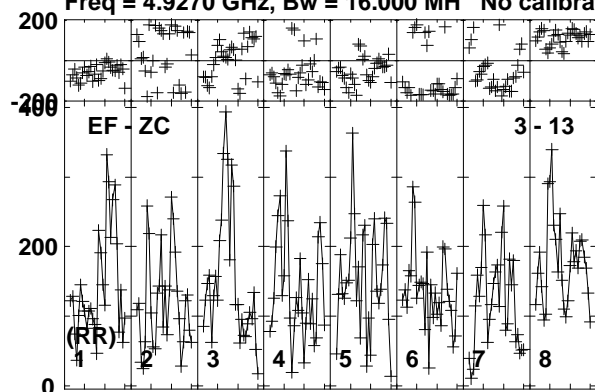

Lower frame: Micro Ampl Jy Top frame: Phas deg  
Vector averaged cross-power spectrum Baseline: EF (03) - ZC (13)  
Timerange: 00/09:42:01 to 00/09:43:59

Plot file version 166 created 19-DEC-2018 17:58:23

VLA2 RY007C.UVDATA.1

Freq = 4.9270 GHz, Bw = 16.000 MH No calibration applied and no bandpass applied

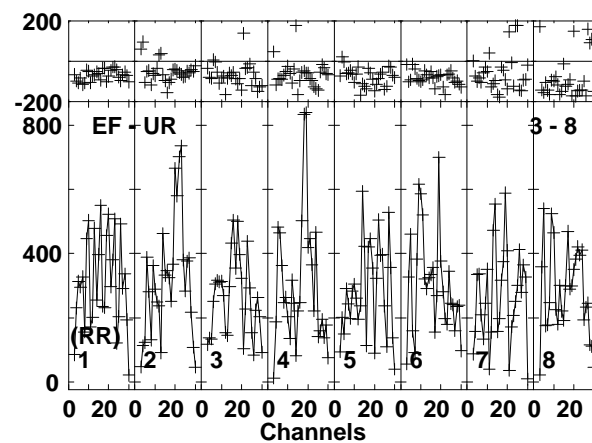
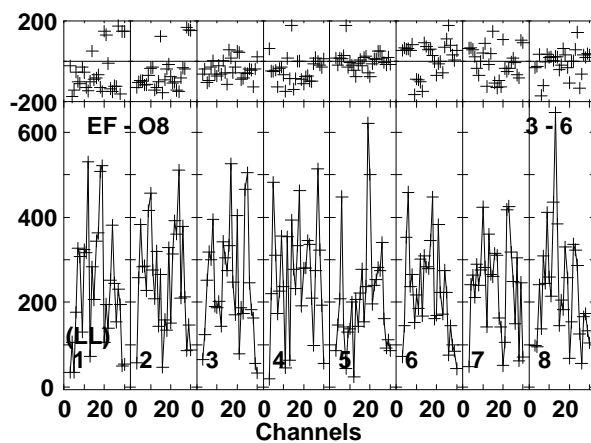
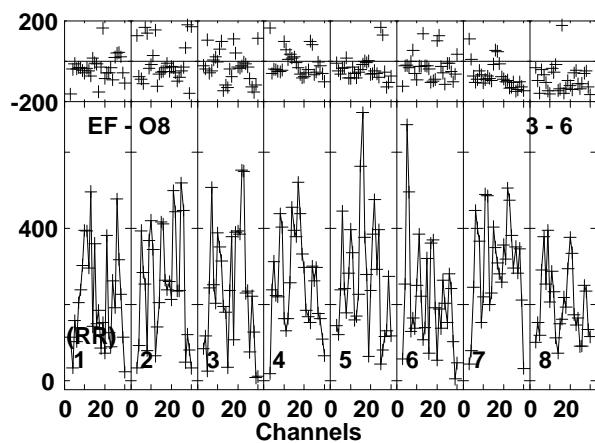
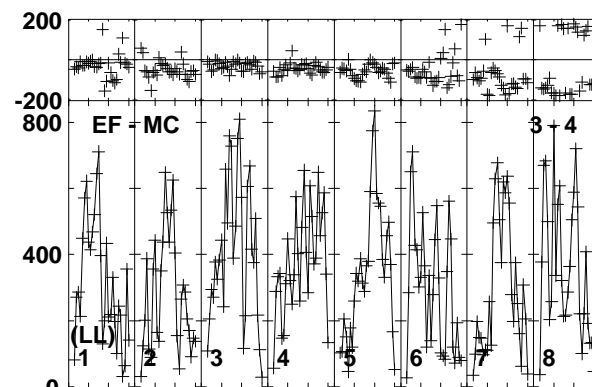
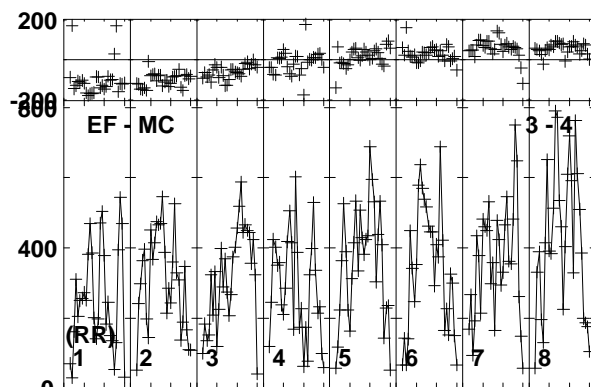
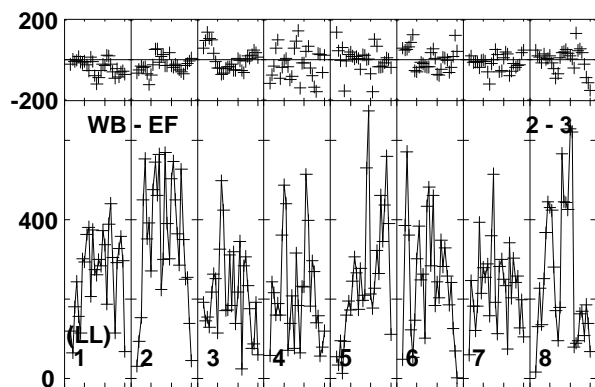
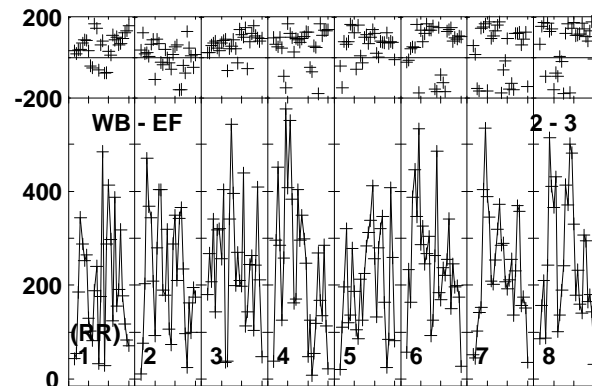
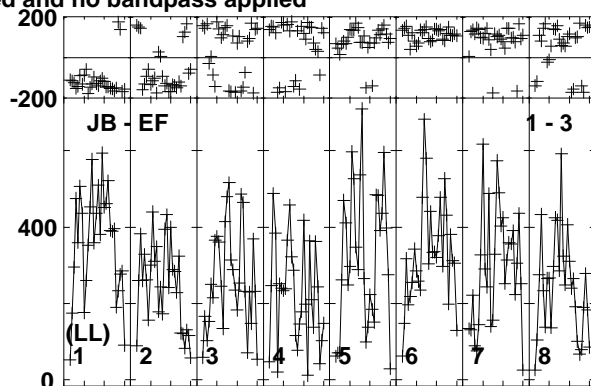
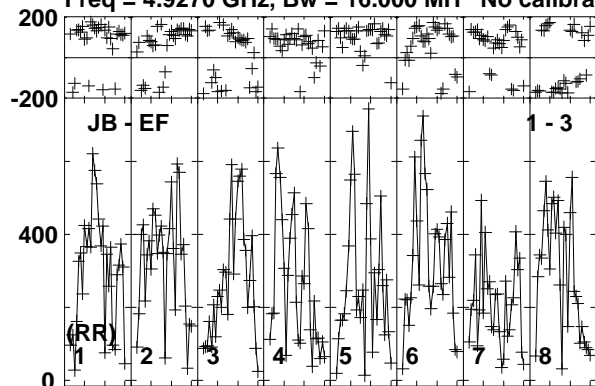

Lower frame: Micro Ampl Jy Top frame: Phas deg  
Vector averaged cross-power spectrum Baseline: JB (01) - EF (03)  
Timerange: 00/09:44:01 to 00/09:44:59

Plot file version 167 created 19-DEC-2018 17:58:23

VLA2 RY007C.UVDATA.1

Freq = 4.9270 GHz, Bw = 16.000 MH No calibration applied and no bandpass applied

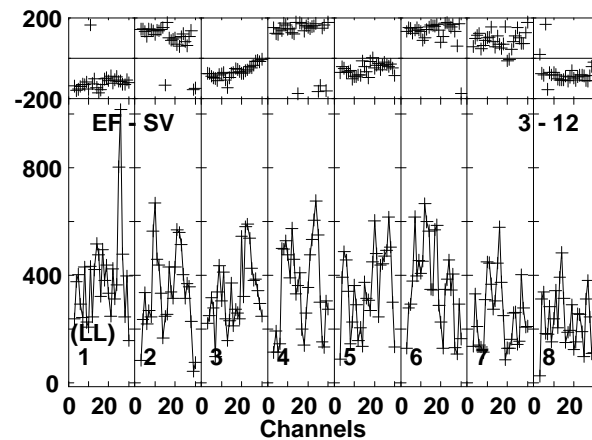
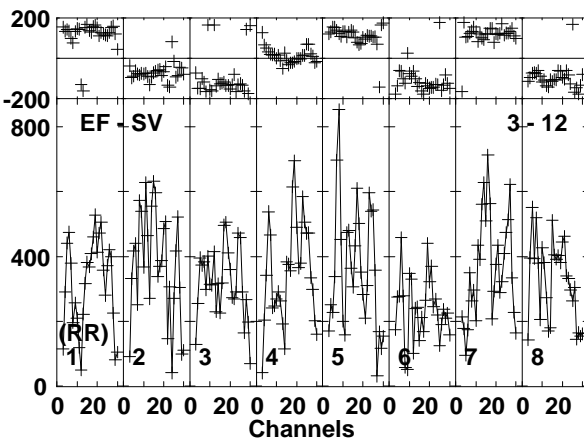
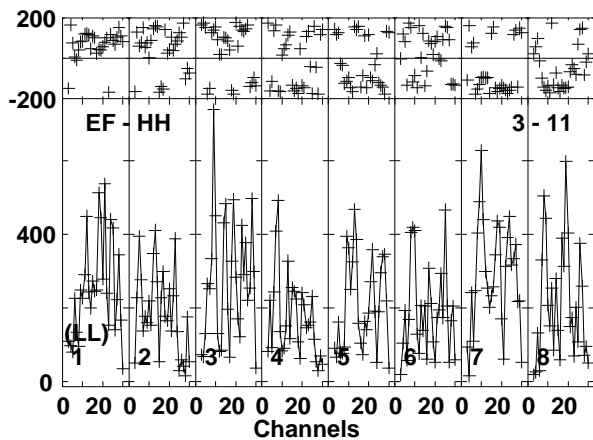
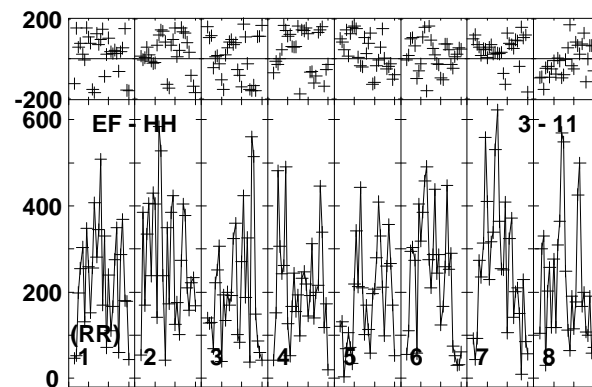
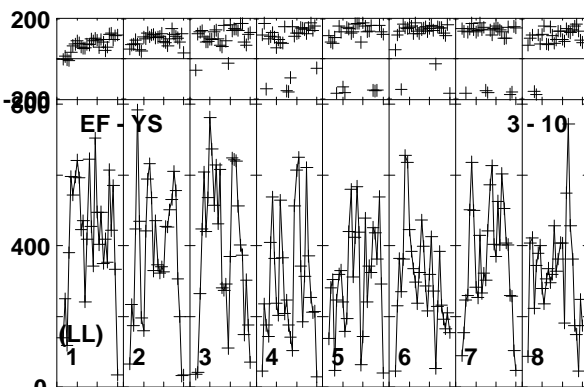
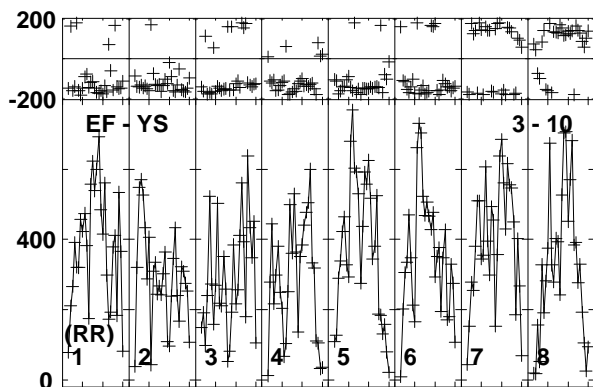
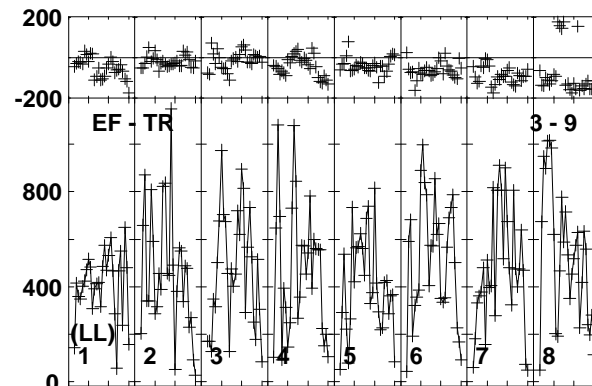
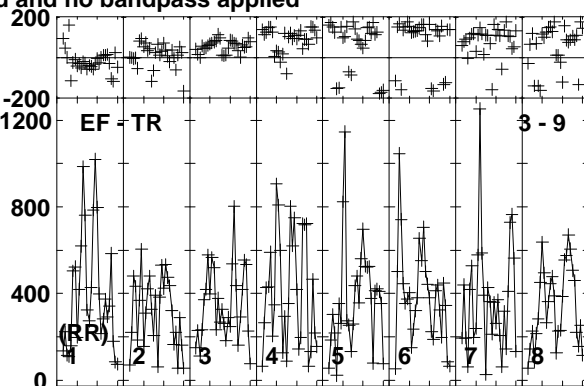
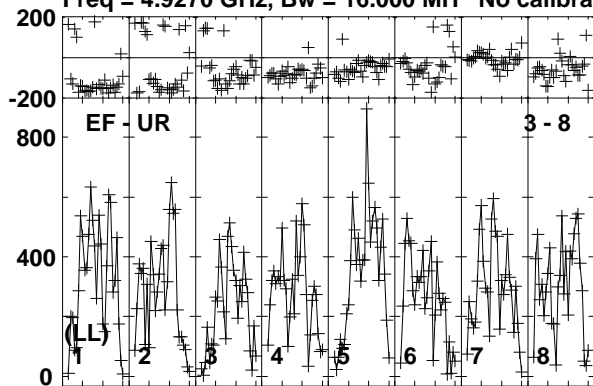

Lower frame: Micro Ampl Jy Top frame: Phas deg  
Vector averaged cross-power spectrum Baseline: EF (03) - UR (08)  
Timerange: 00/09:44:01 to 00/09:44:59

Plot file version 168 created 19-DEC-2018 17:58:23

VLA2 RY007C.UVDATA.1

Freq = 4.9270 GHz, Bw = 16.000 MH No calibration applied and no bandpass applied

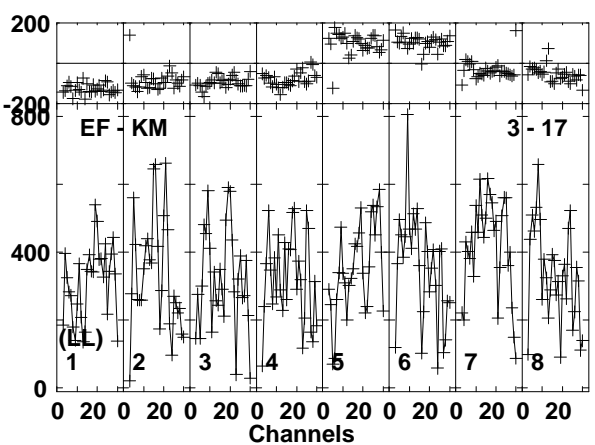
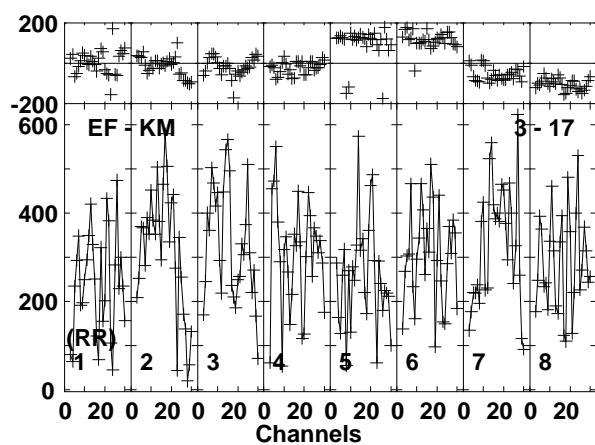
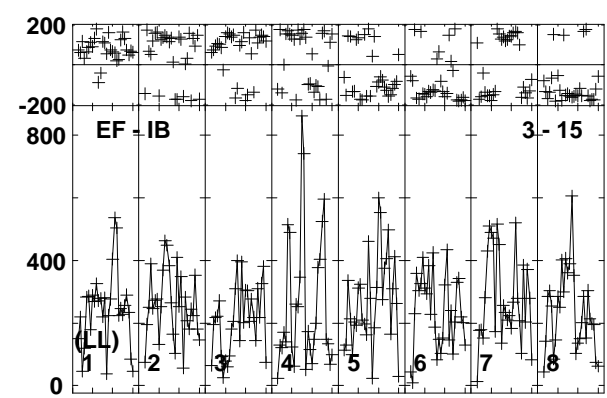
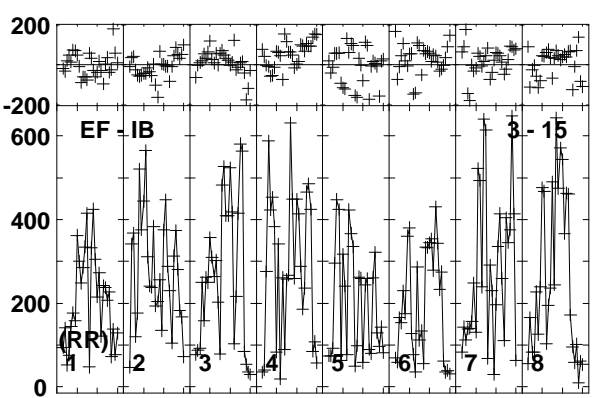
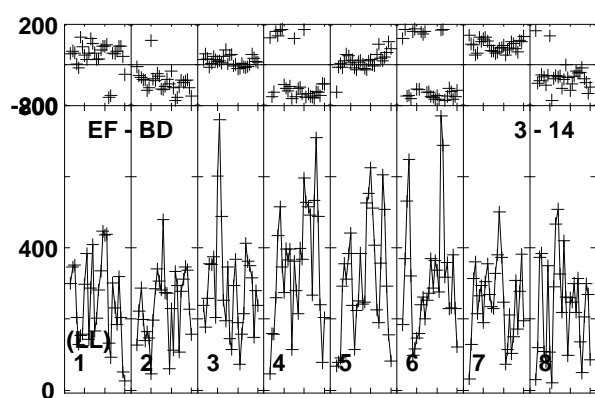
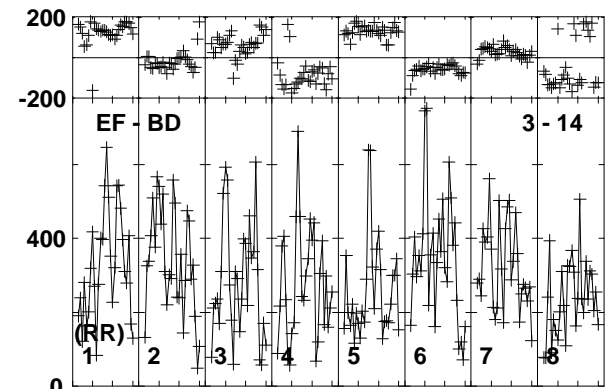
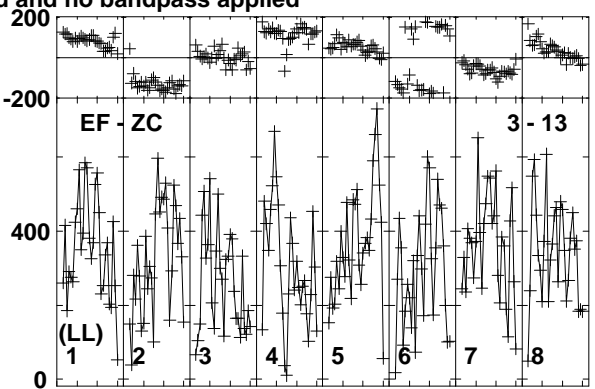
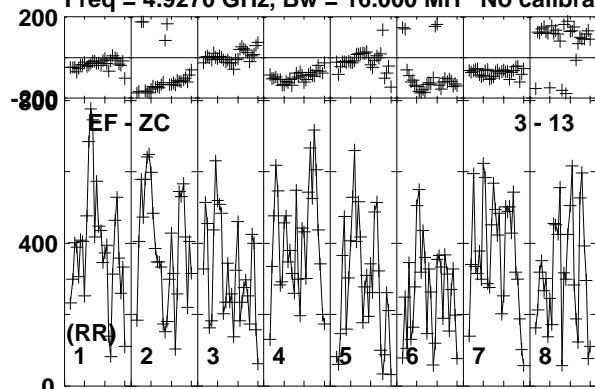

Lower frame: Micro Ampl Jy Top frame: Phas deg  
Vector averaged cross-power spectrum Baseline: EF (03) - ZC (13)  
Timerange: 00/09:44:01 to 00/09:44:59

Plot file version 169 created 19-DEC-2018 17:58:23

J1619+2247 RY007C.UVDATA.1

Freq = 4.9270 GHz, Bw = 16.000 MH No calibration applied and no bandpass applied

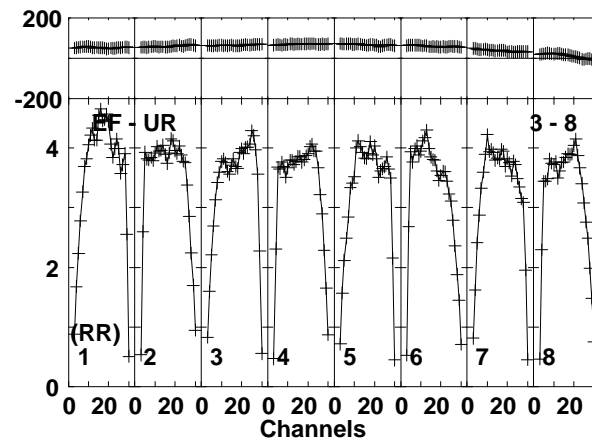
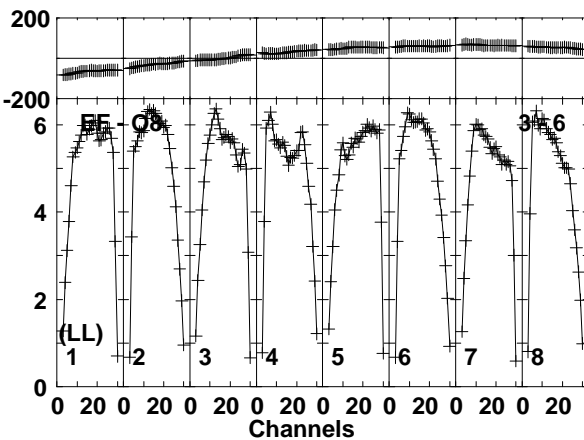
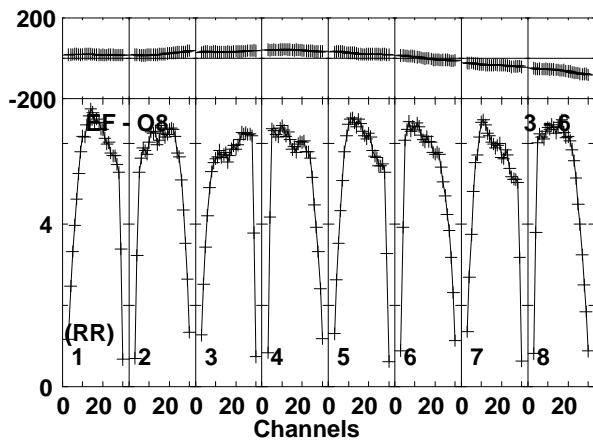
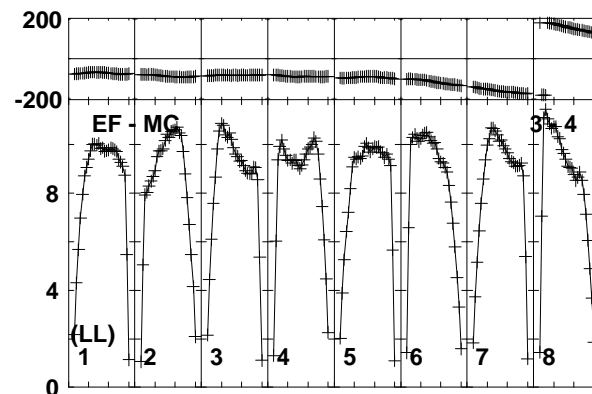
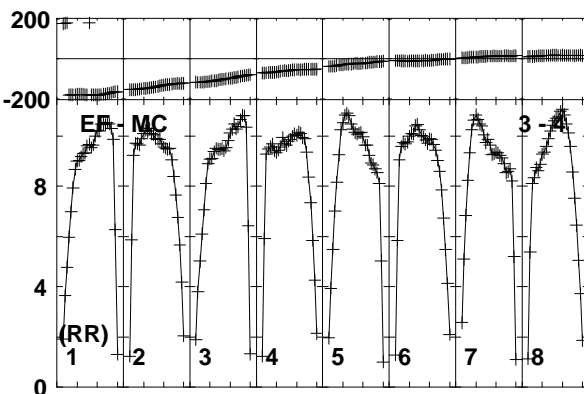
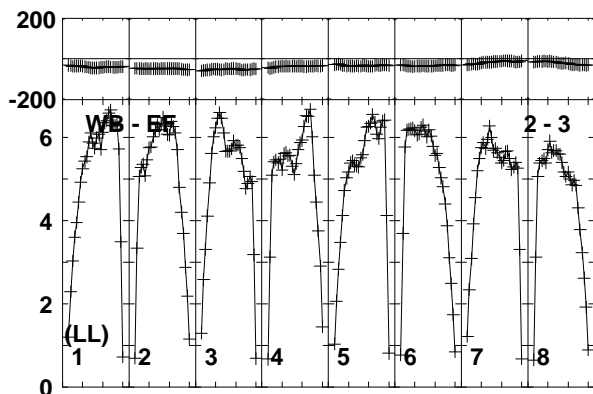
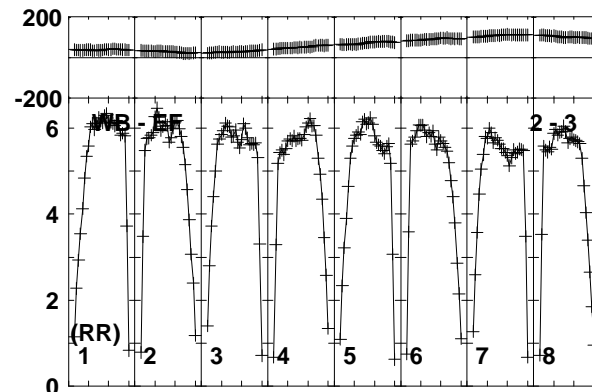
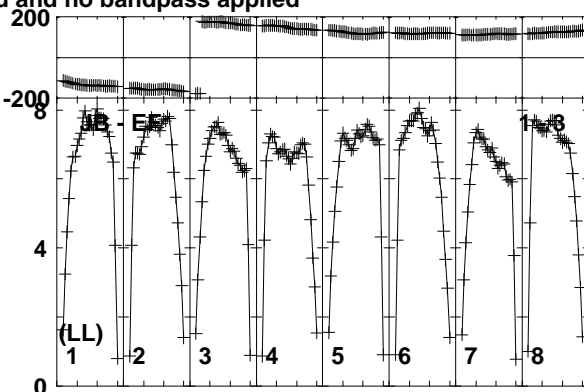
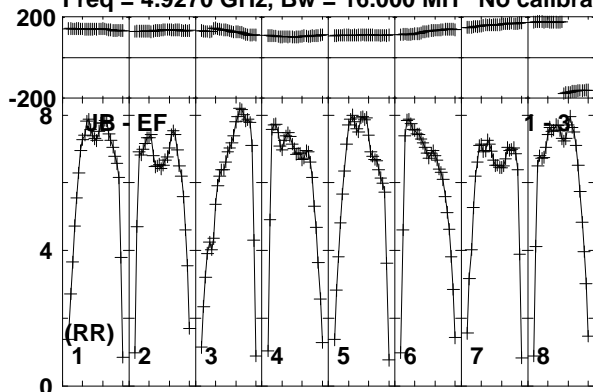

Lower frame: Milli Ampl Jy Top frame: Phas deg  
Vector averaged cross-power spectrum Baseline: JB (01) - EF (03)  
Timerange: 00/09:45:31 to 00/09:46:29

Plot file version 170 created 19-DEC-2018 17:58:23

J1619+2247 RY007C.UVDATA.1

Freq = 4.9270 GHz, Bw = 16.000 MH No calibration applied and no bandpass applied

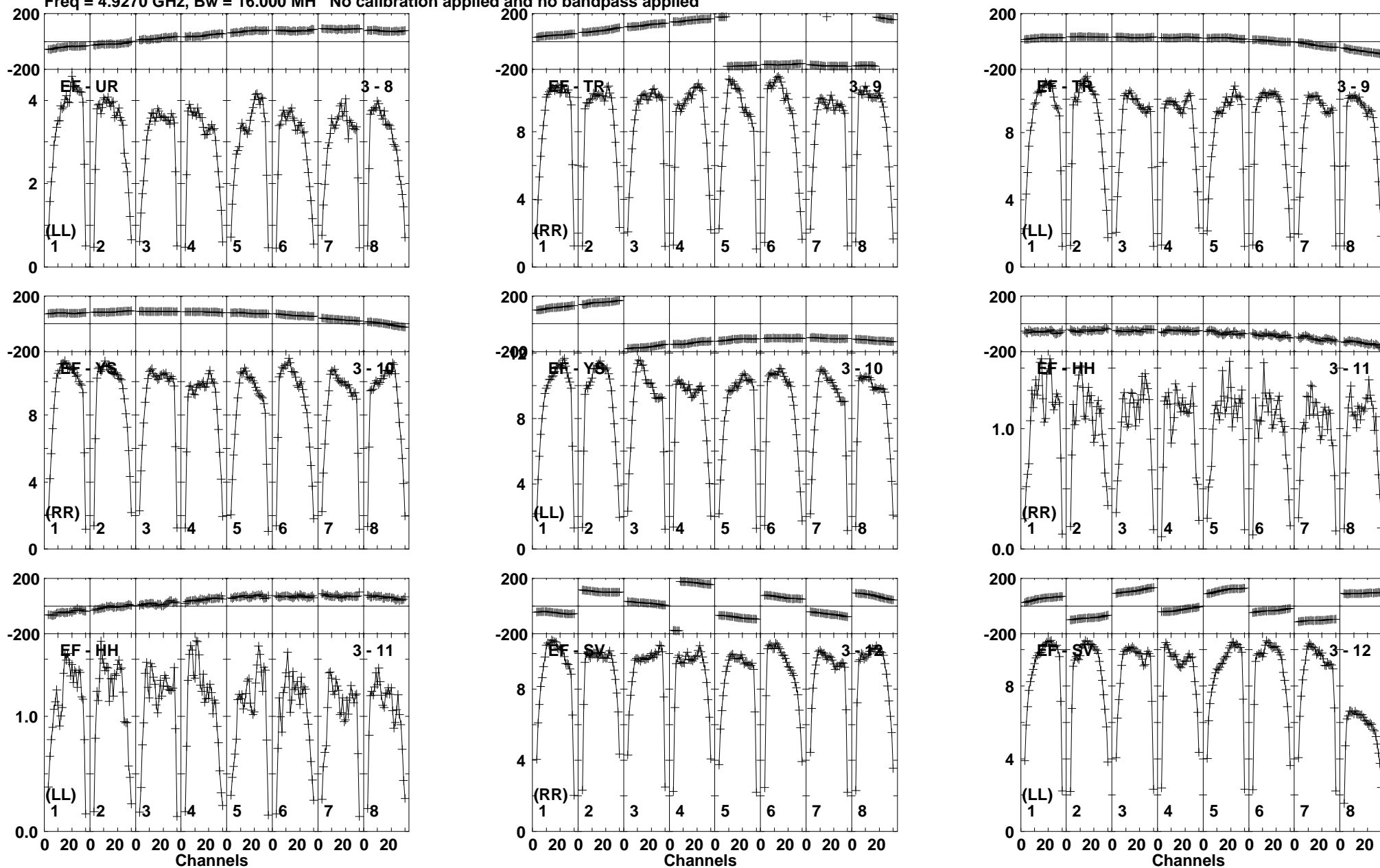

Lower frame: Milli Ampl Jy Top frame: Phas deg  
Vector averaged cross-power spectrum Baseline: EF (03) - UR (08)  
Timerange: 00/09:45:31 to 00/09:46:29



Plot file version 171 created 19-DEC-2018 17:58:23

J1619+2247 RY007C.UVDATA.1

Freq = 4.9270 GHz, Bw = 16.000 MH No calibration applied and no bandpass applied

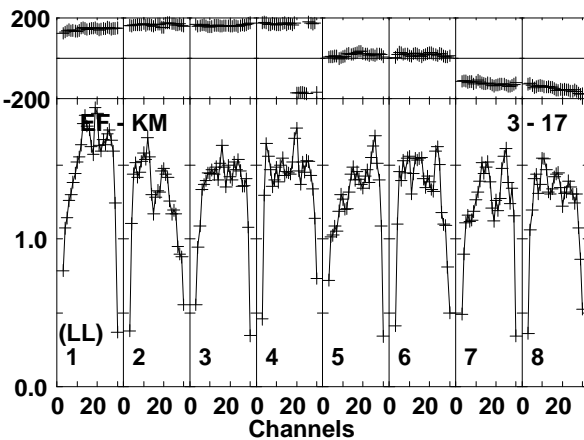
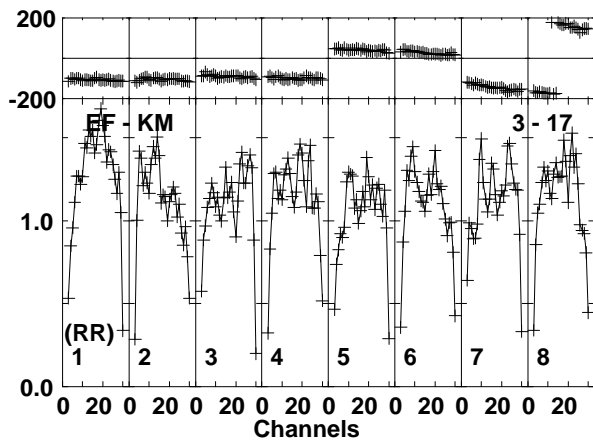
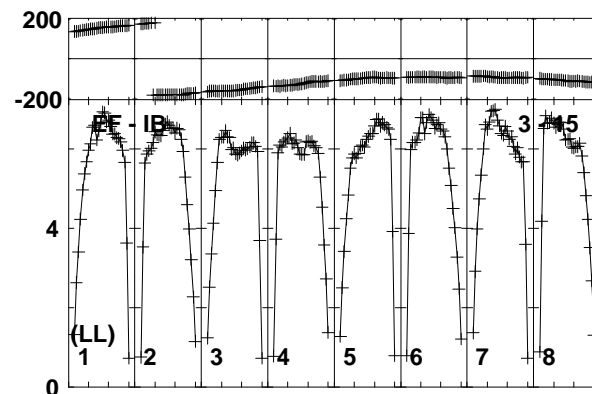
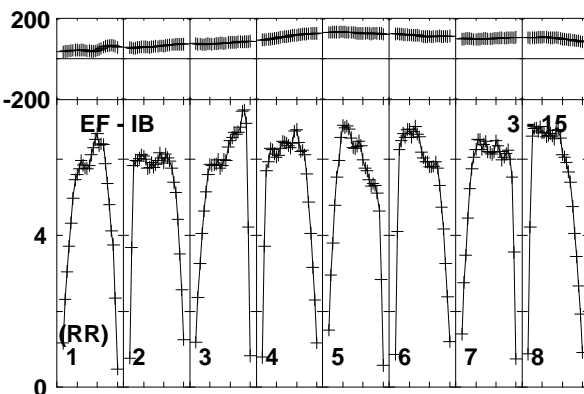
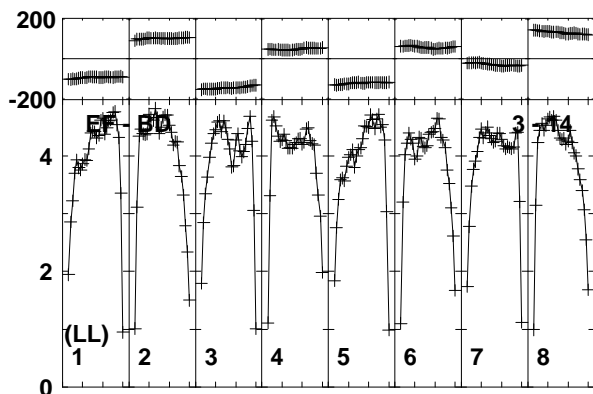
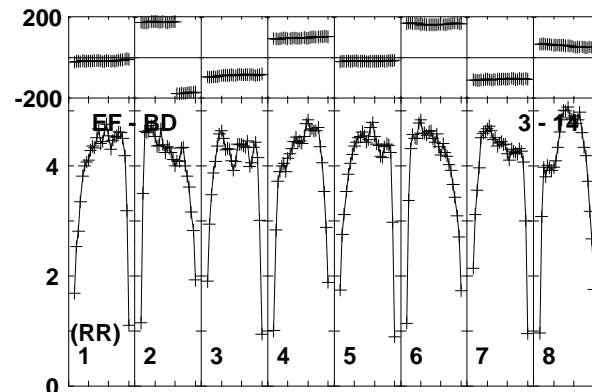
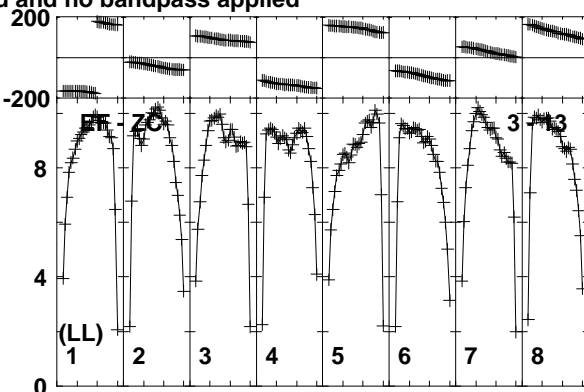
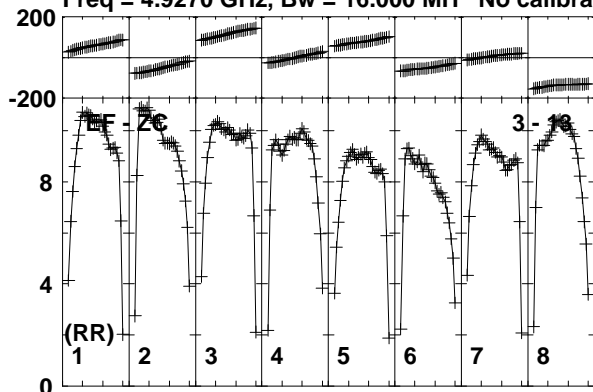

Lower frame: Milli Ampl Jy Top frame: Phas deg  
Vector averaged cross-power spectrum Baseline: EF (03) - ZC (13)  
Timerange: 00/09:45:31 to 00/09:46:29

Plot file version 172 created 19-DEC-2018 17:58:23

AT2018\_RY007C.UVDATA.1

Freq = 4.9270 GHz, Bw = 16.000 MH No calibration applied and no bandpass applied

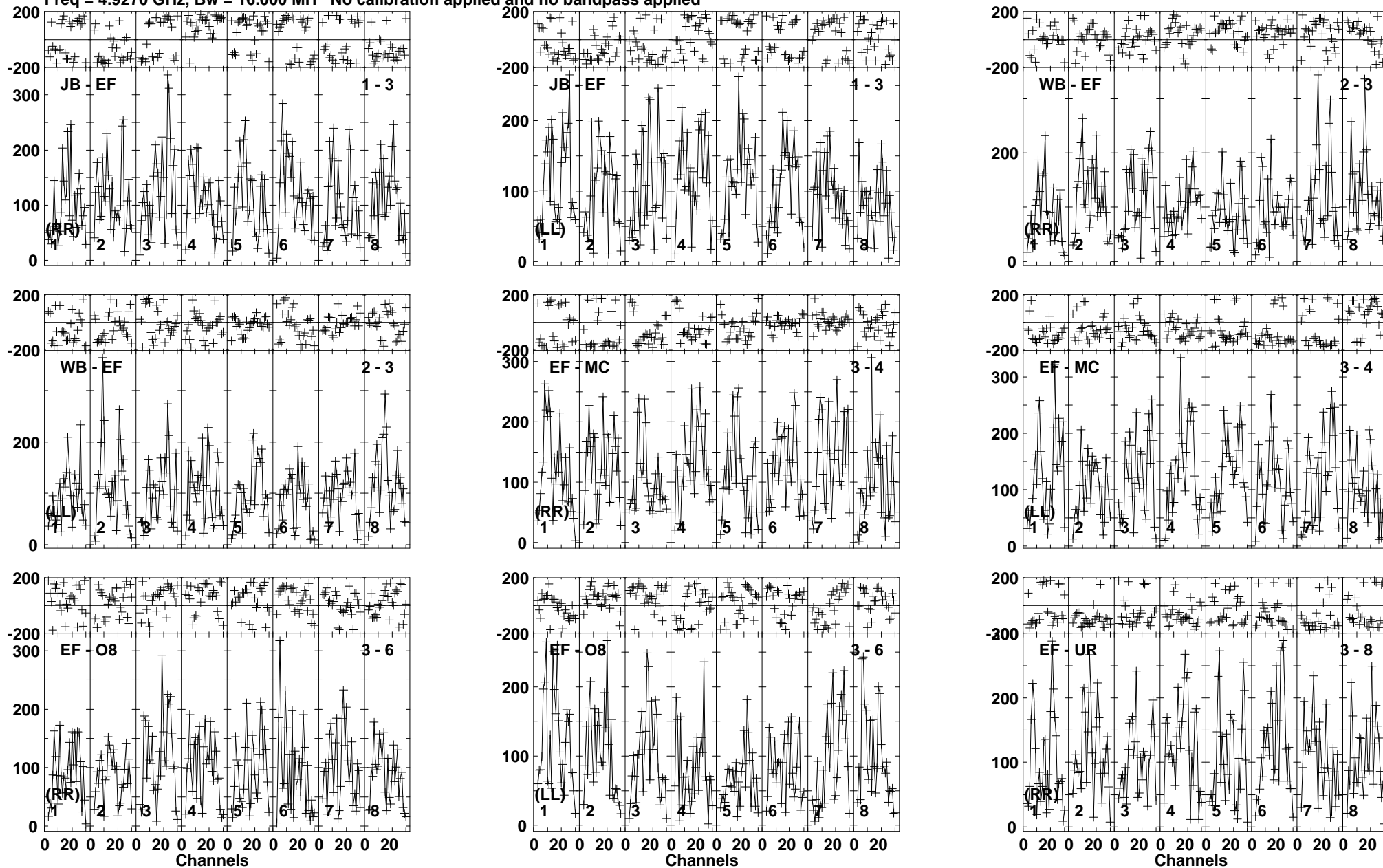

Lower frame: Micro Ampl Jy Top frame: Phas deg  
Vector averaged cross-power spectrum Baseline: JB (01) - EF (03)  
Timerange: 00/09:46:31 to 00/09:49:29

Plot file version 173 created 19-DEC-2018 17:58:23

AT2018\_RY007C.UVDATA.1

Freq = 4.9270 GHz, Bw = 16.000 MH No calibration applied and no bandpass applied

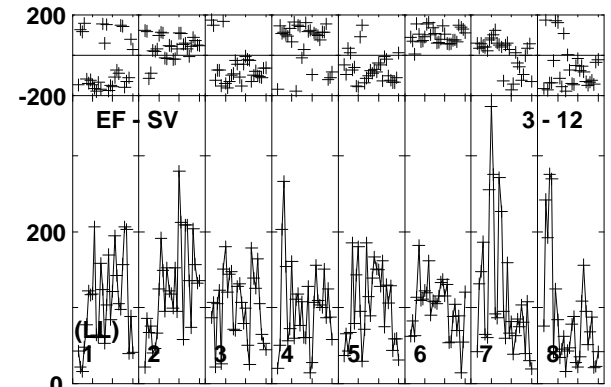
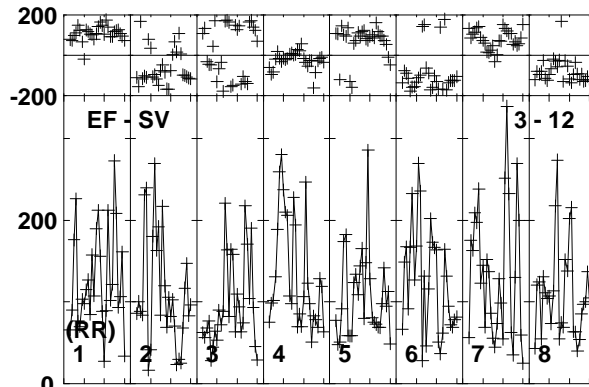
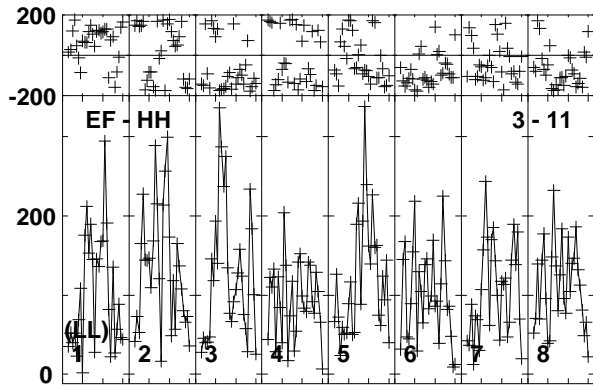
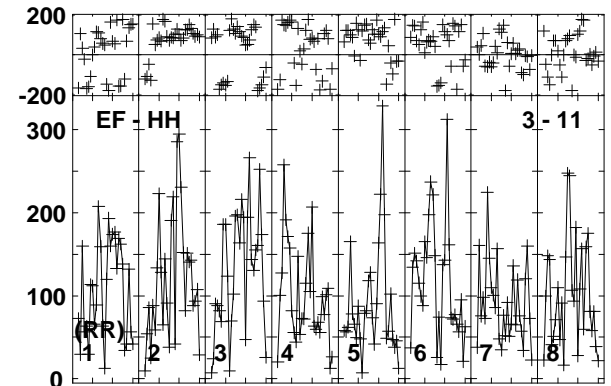
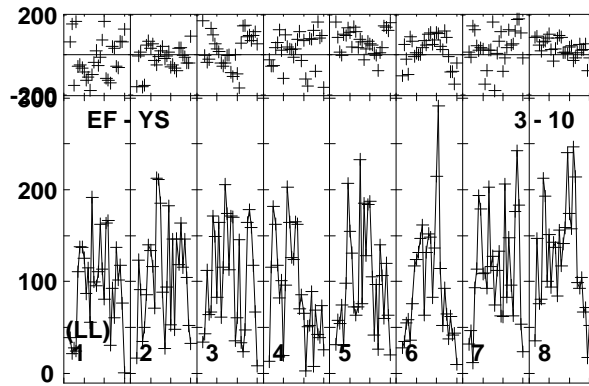
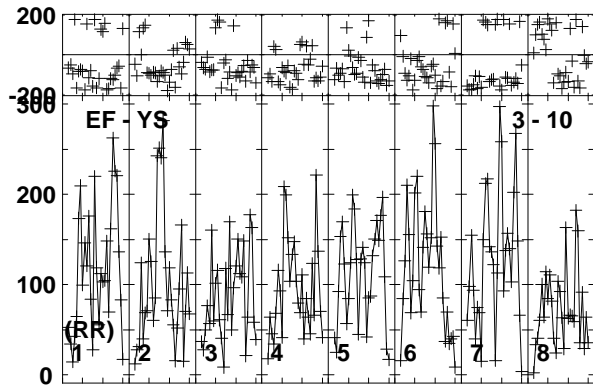
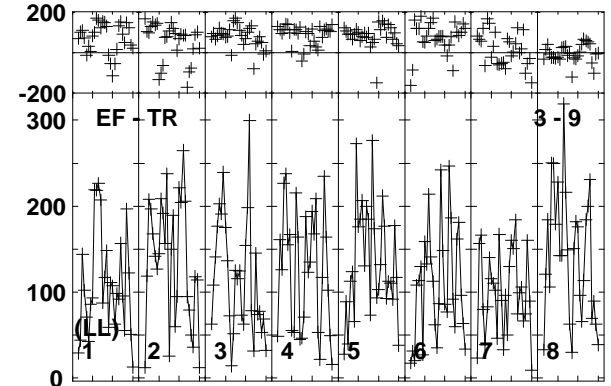
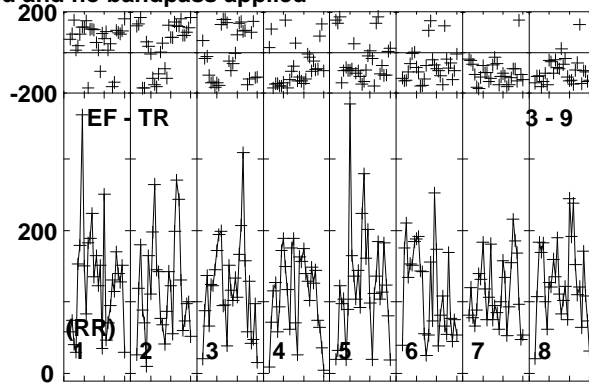
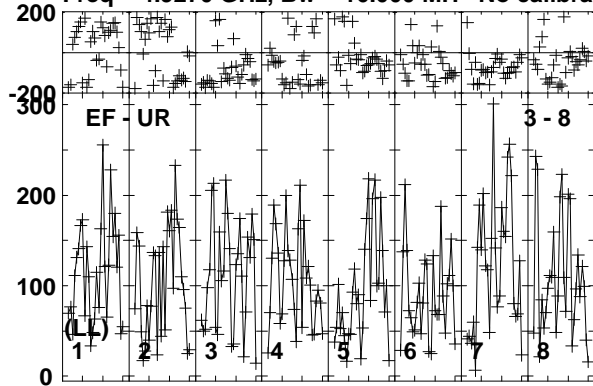

Lower frame: Micro Ampl Jy Top frame: Phas deg  
Vector averaged cross-power spectrum Baseline: EF (03) - UR (08)  
Timerange: 00/09:46:31 to 00/09:49:29

Plot file version 174 created 19-DEC-2018 17:58:23

AT2018\_RY007C.UVDATA.1

Freq = 4.9270 GHz, Bw = 16.000 MH No calibration applied and no bandpass applied

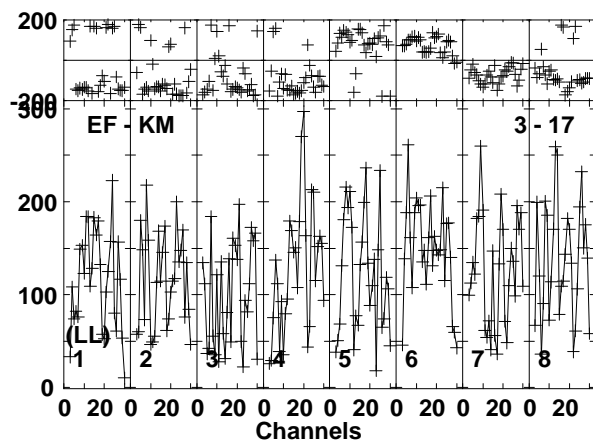
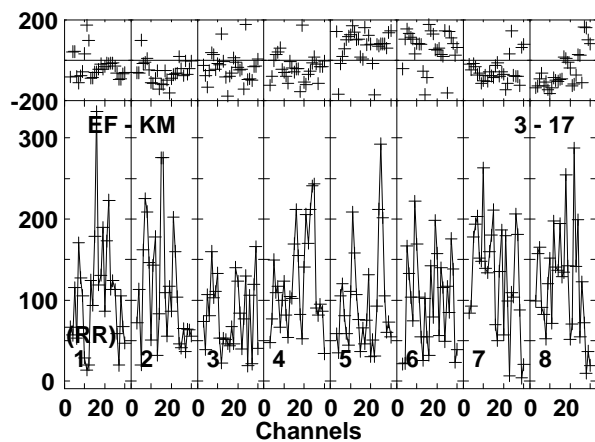
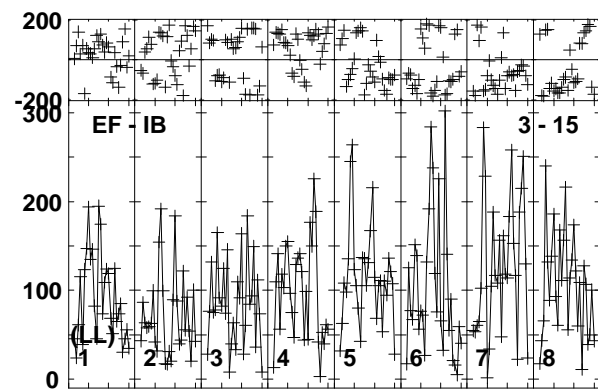
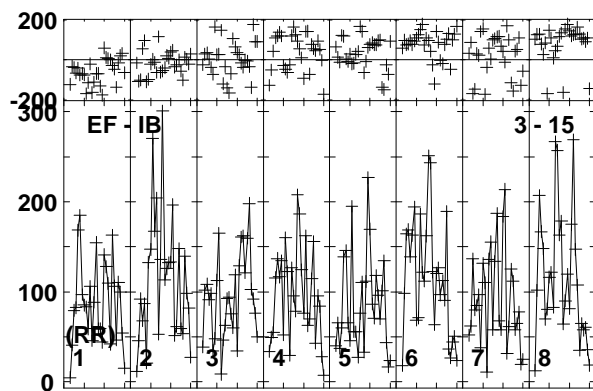
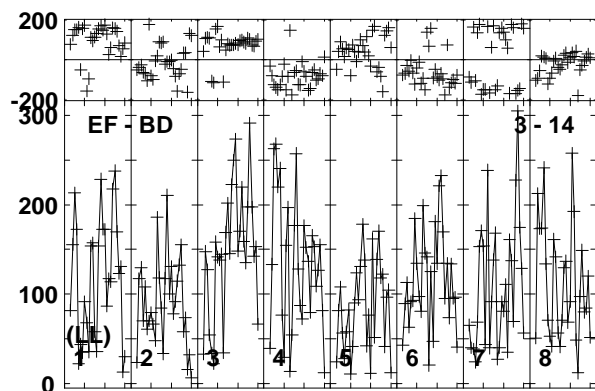
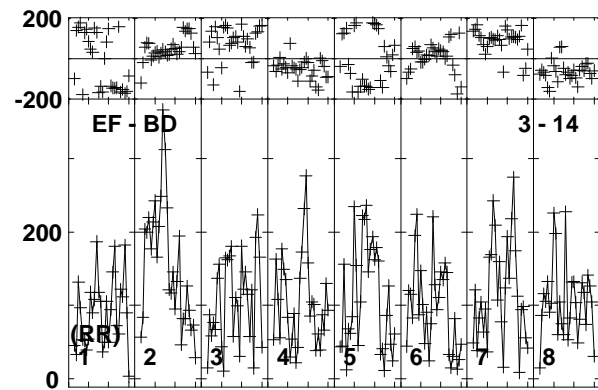
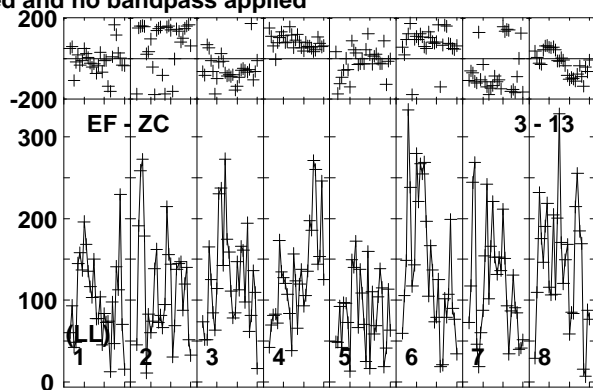
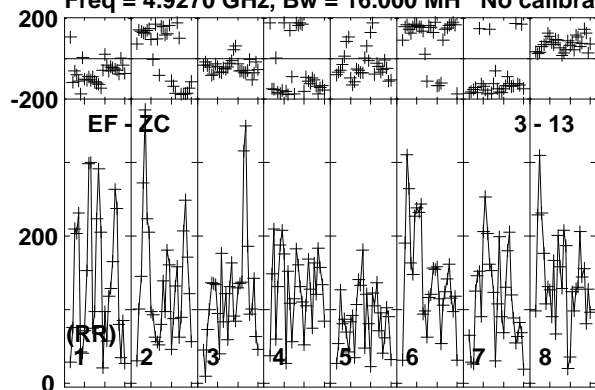

Lower frame: Micro Ampl Jy Top frame: Phas deg  
Vector averaged cross-power spectrum Baseline: EF (03) - ZC (13)  
Timerange: 00/09:46:31 to 00/09:49:29

Plot file version 175 created 19-DEC-2018 17:58:23

J1619+2247 RY007C.UVDATA.1

Freq = 4.9270 GHz, Bw = 16.000 MH No calibration applied and no bandpass applied

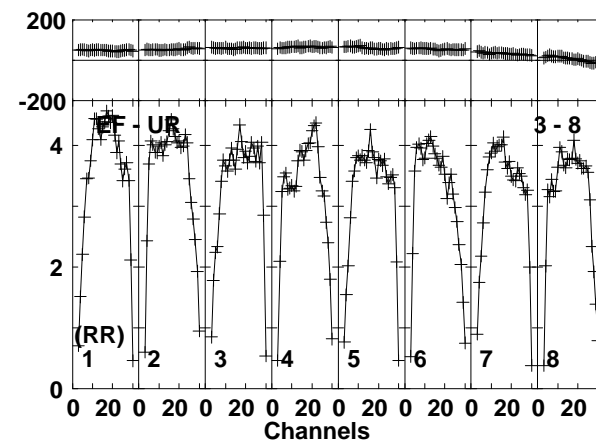
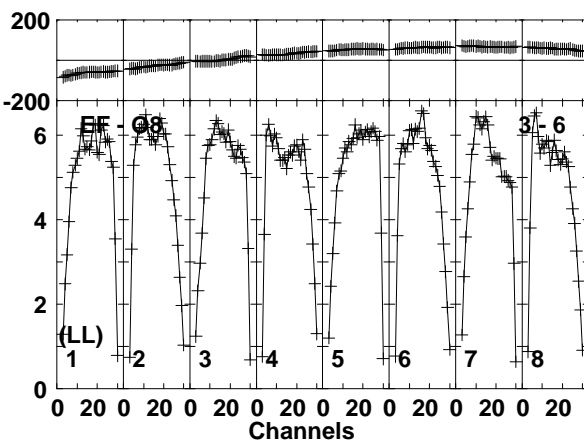
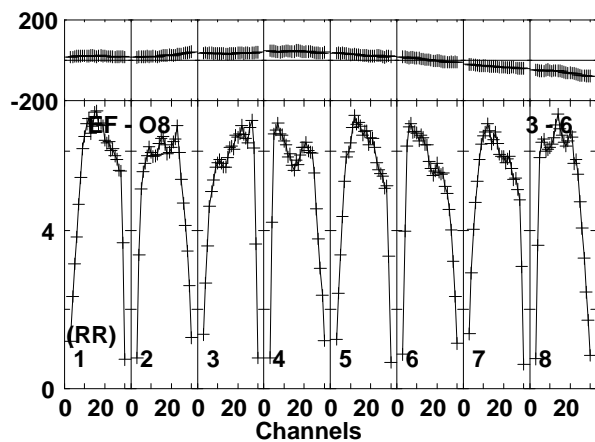
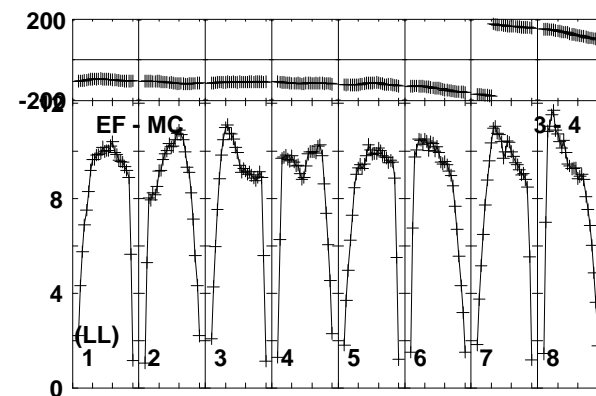
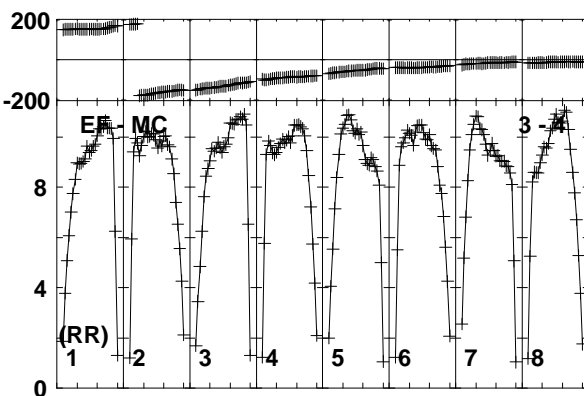
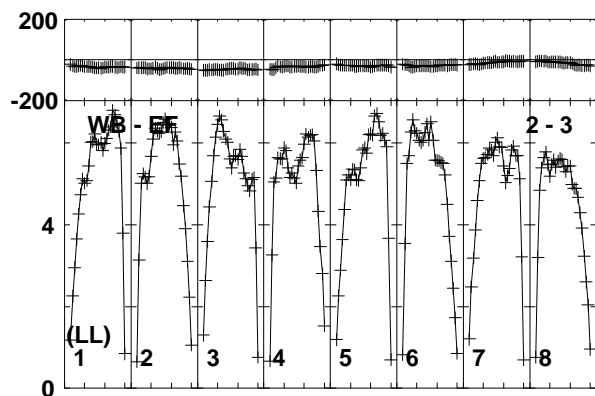
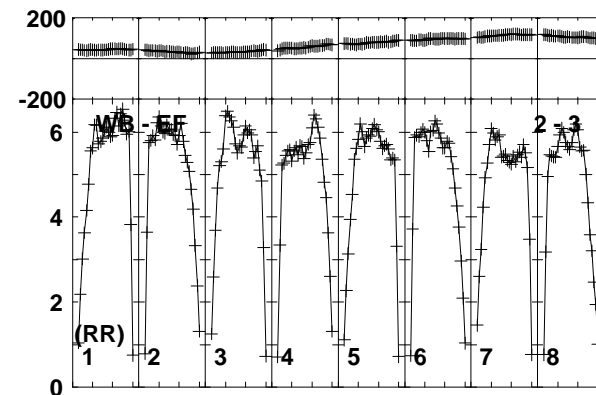
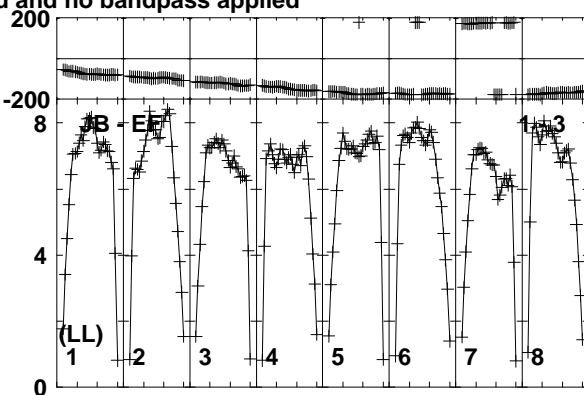
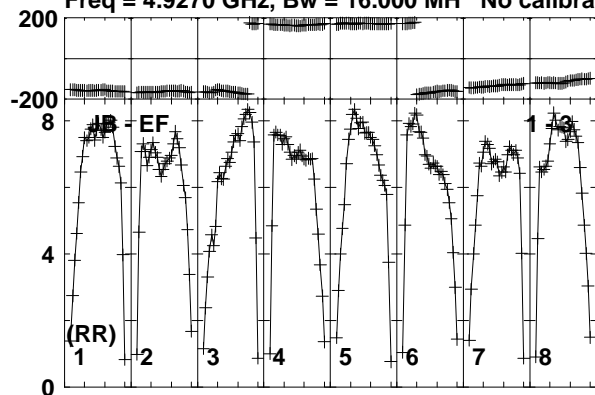

Lower frame: Milli Ampl Jy Top frame: Phas deg  
Vector averaged cross-power spectrum Baseline: JB (01) - EF (03)  
Timerange: 00/09:49:31 to 00/09:50:29

Plot file version 176 created 19-DEC-2018 17:58:24

J1619+2247 RY007C.UVDATA.1

Freq = 4.9270 GHz, Bw = 16.000 MH No calibration applied and no bandpass applied

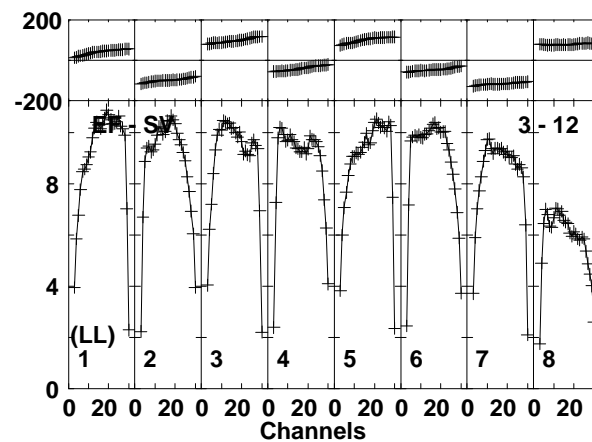
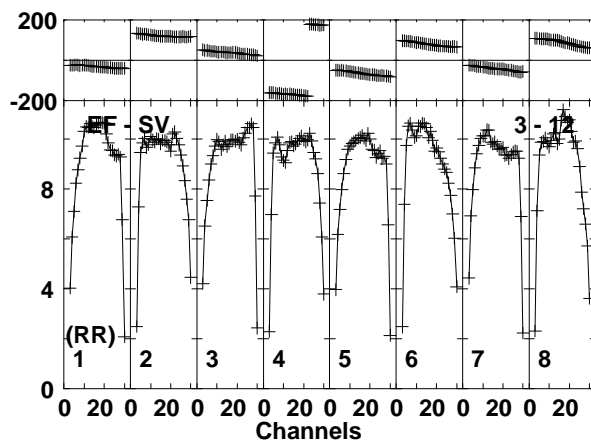
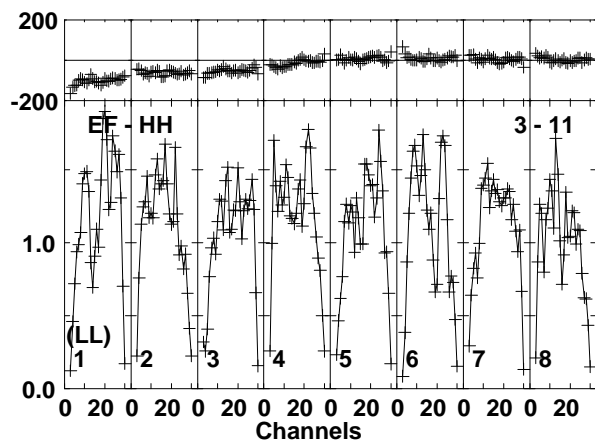
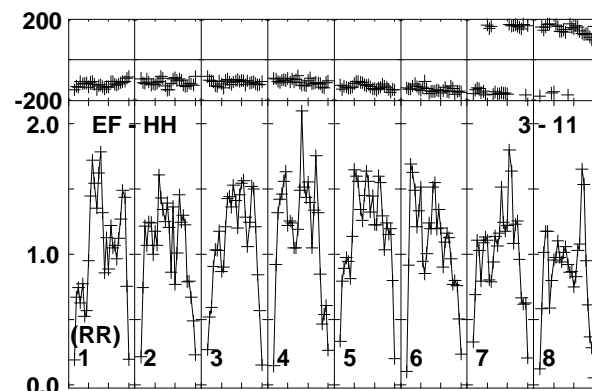
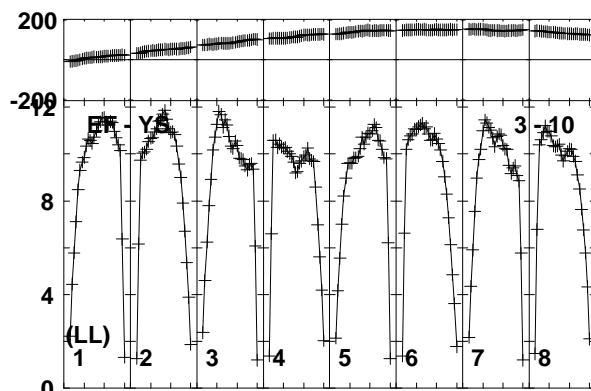
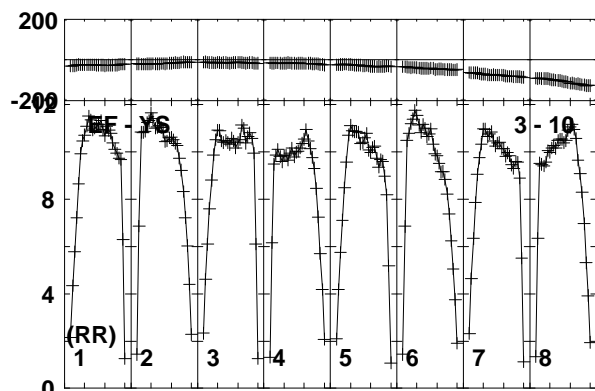
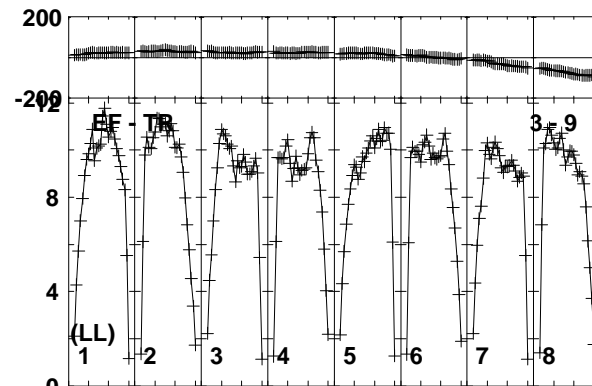
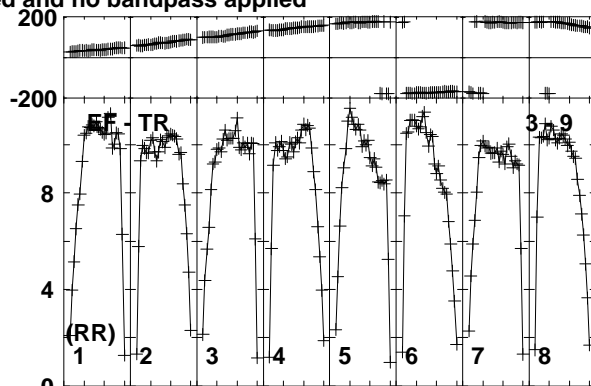
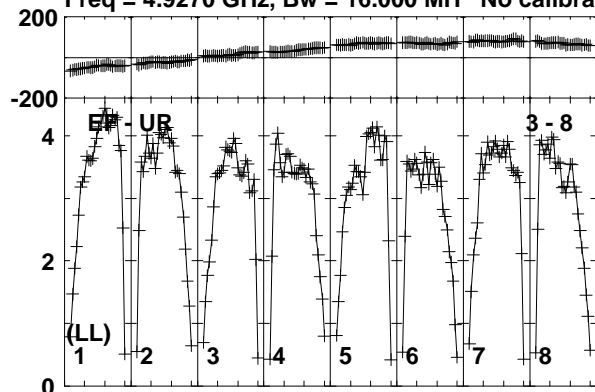

Lower frame: Milli Ampl Jy Top frame: Phas deg  
Vector averaged cross-power spectrum Baseline: EF (03) - UR (08)  
Timerange: 00/09:49:31 to 00/09:50:29

Plot file version 177 created 19-DEC-2018 17:58:24

J1619+2247 RY007C.UVDATA.1

Freq = 4.9270 GHz, Bw = 16.000 MH No calibration applied and no bandpass applied

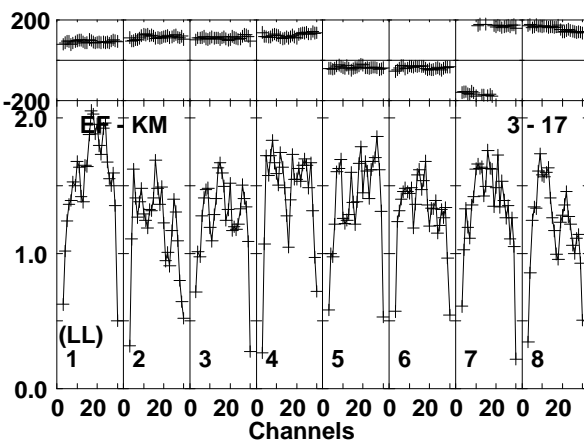
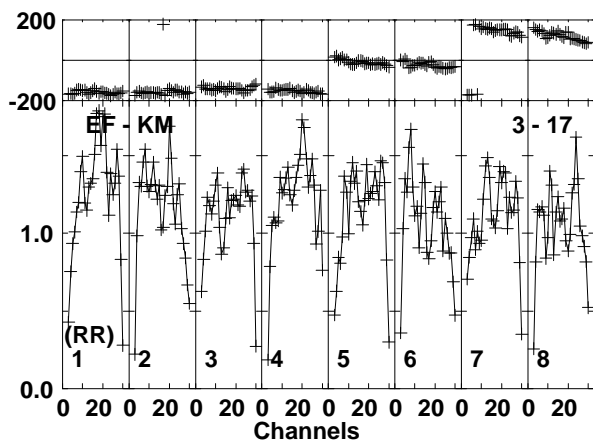
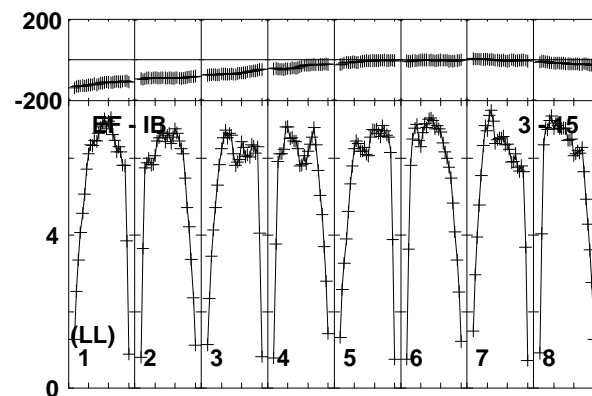
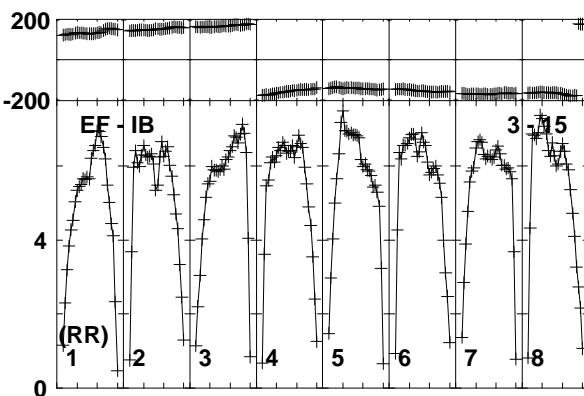
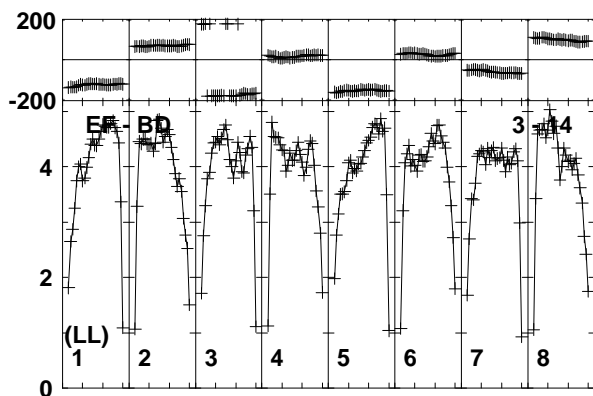
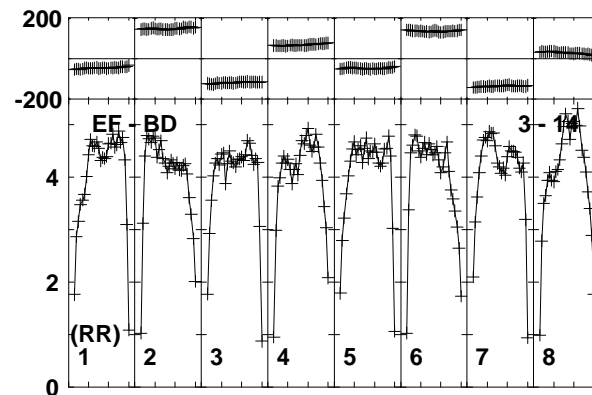
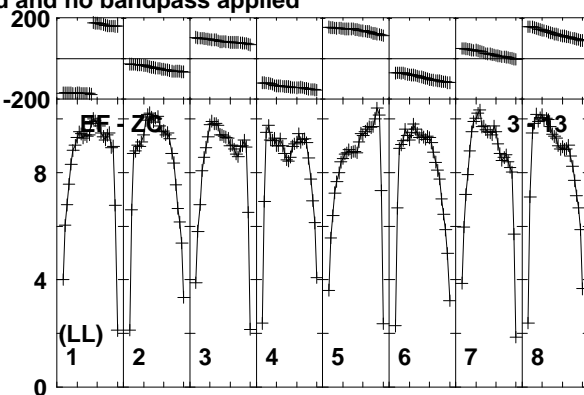
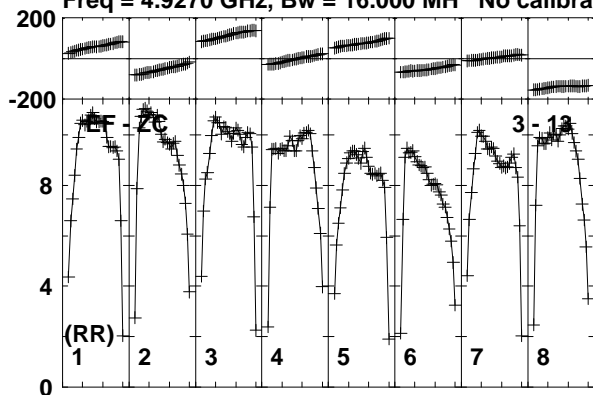

Lower frame: Milli Ampl Jy Top frame: Phas deg  
Vector averaged cross-power spectrum Baseline: EF (03) - ZC (13)  
Timerange: 00/09:49:31 to 00/09:50:29

Plot file version 178 created 19-DEC-2018 17:58:24  
 AT2018\_RY007C.UVDATA.1

Freq = 4.9270 GHz, Bw = 16.000 MH No calibration applied and no bandpass applied

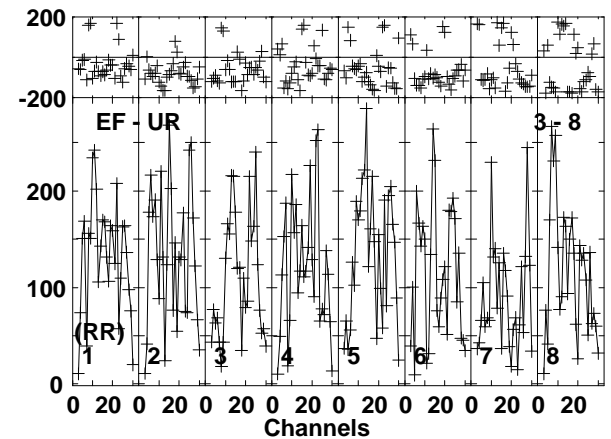
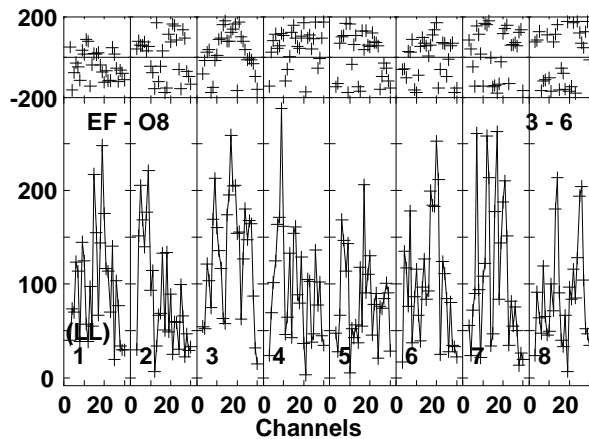
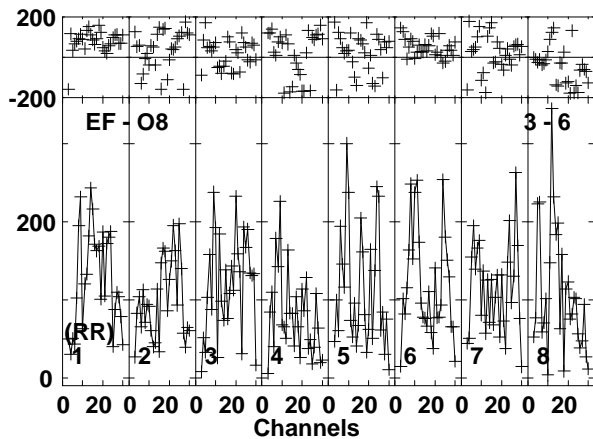
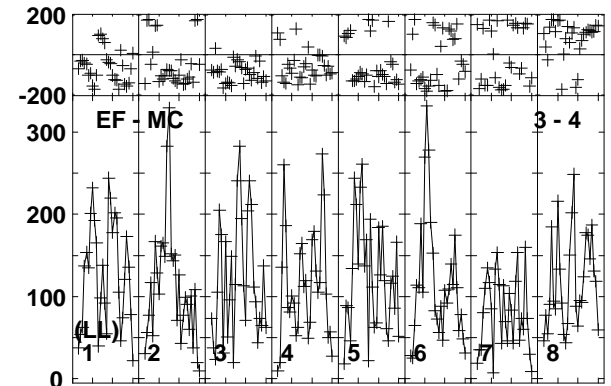
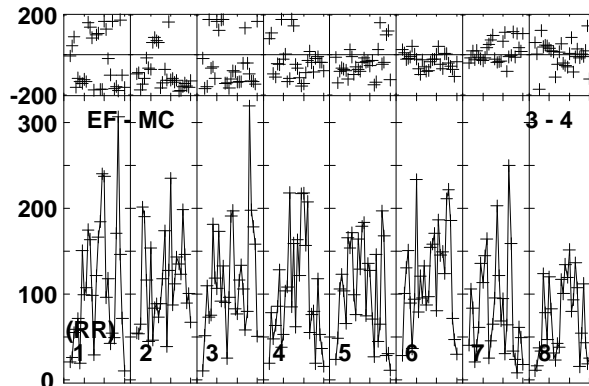
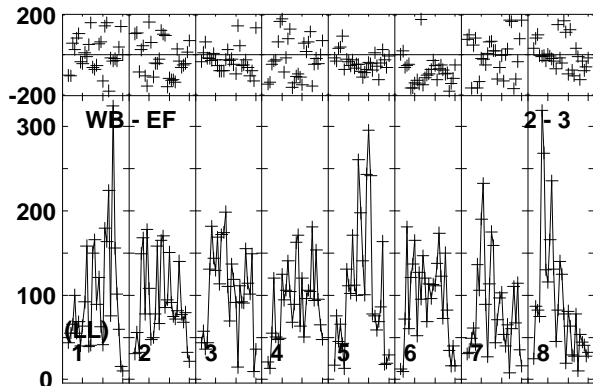
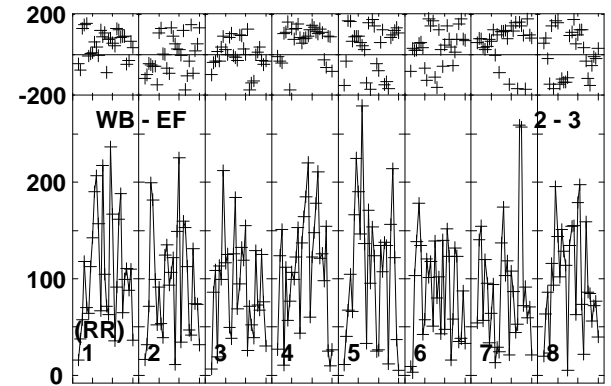
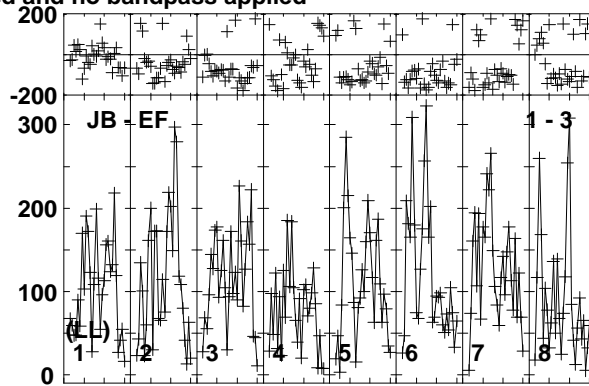
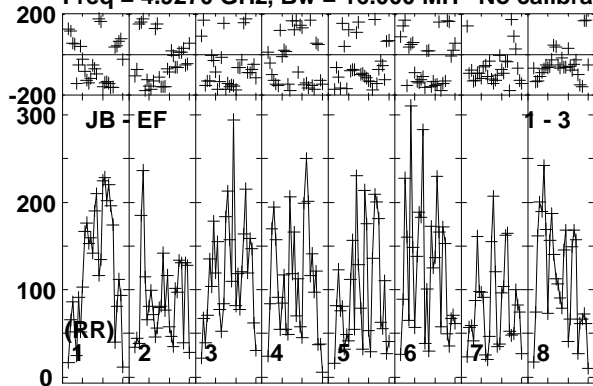

Lower frame: Micro Ampl Jy Top frame: Phas deg  
 Vector averaged cross-power spectrum Baseline: JB (01) - EF (03)  
 Timerange: 00/09:50:31 to 00/09:53:29



Plot file version 179 created 19-DEC-2018 17:58:24

AT2018\_RY007C.UVDATA.1

Freq = 4.9270 GHz, Bw = 16.000 MH No calibration applied and no bandpass applied

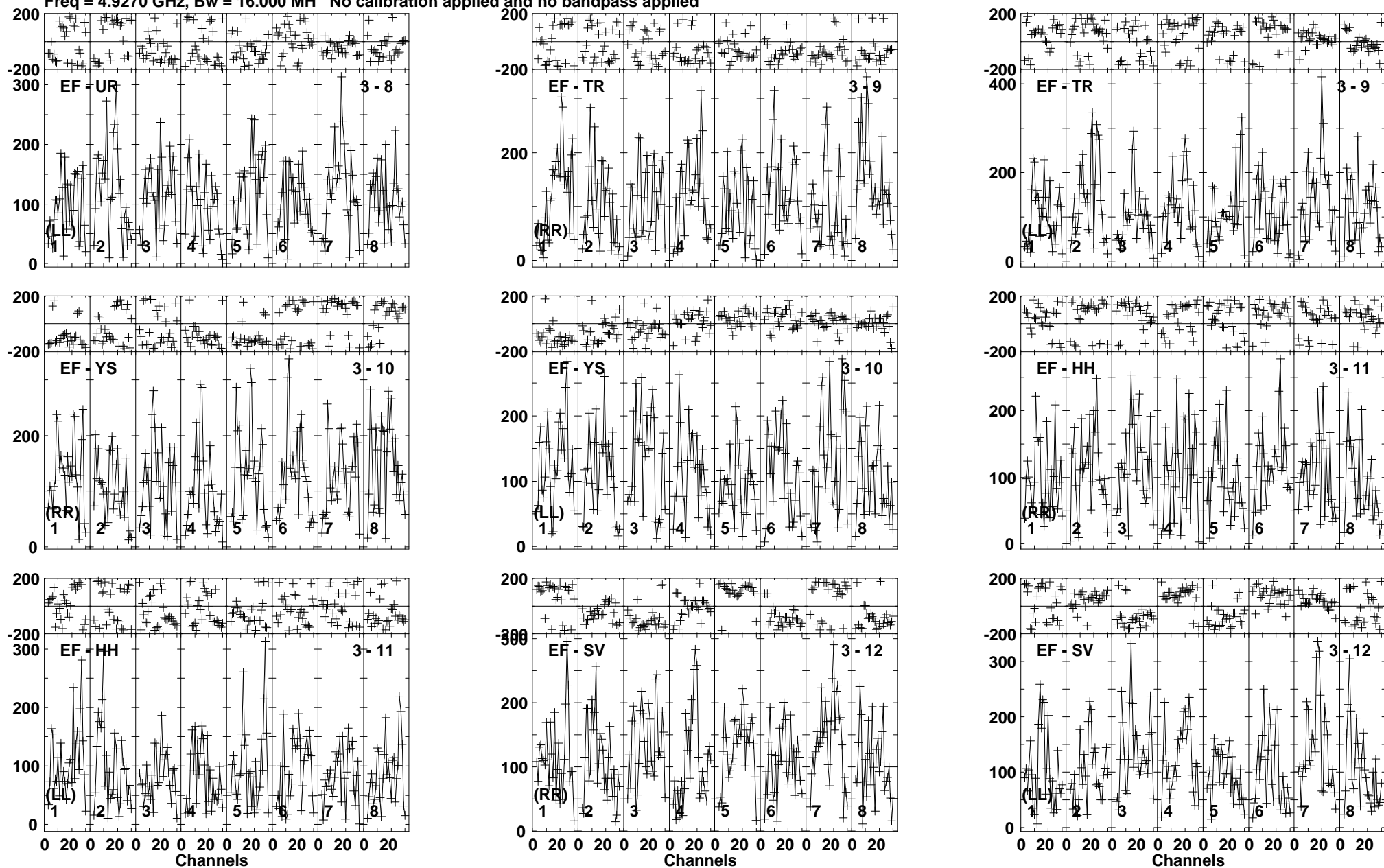

Lower frame: Micro Ampl Jy Top frame: Phas deg  
Vector averaged cross-power spectrum Baseline: EF (03) - UR (08)  
Timerange: 00/09:50:31 to 00/09:53:29

Plot file version 180 created 19-DEC-2018 17:58:24

AT2018\_RY007C.UVDATA.1

Freq = 4.9270 GHz, Bw = 16.000 MH No calibration applied and no bandpass applied

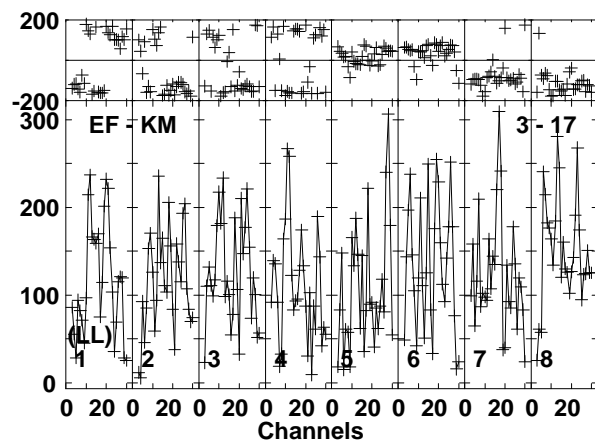
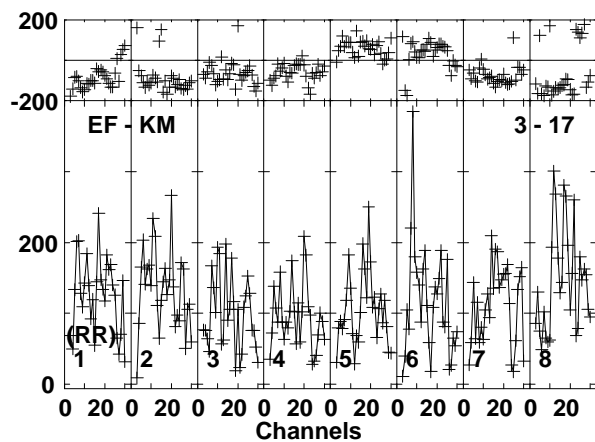
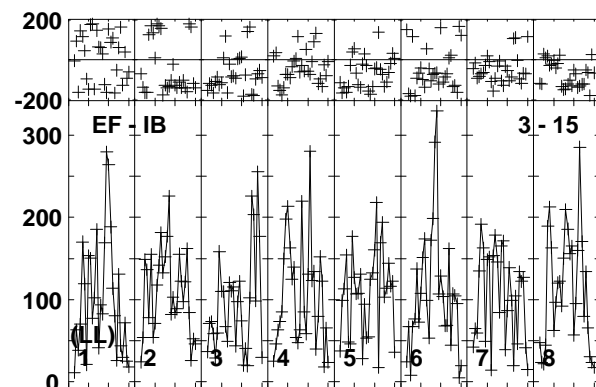
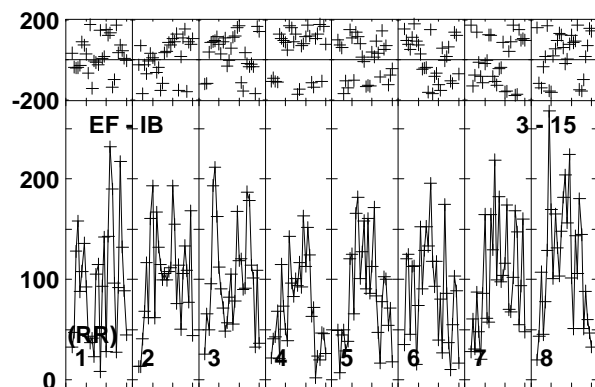
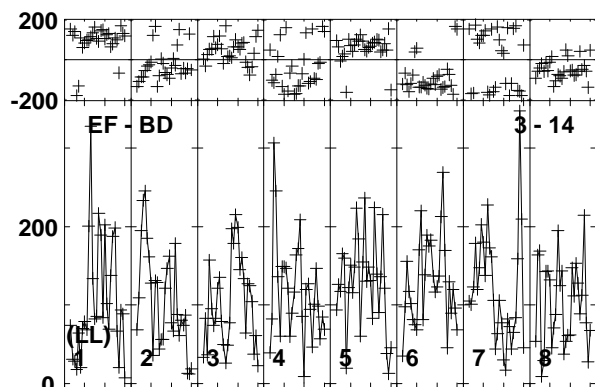
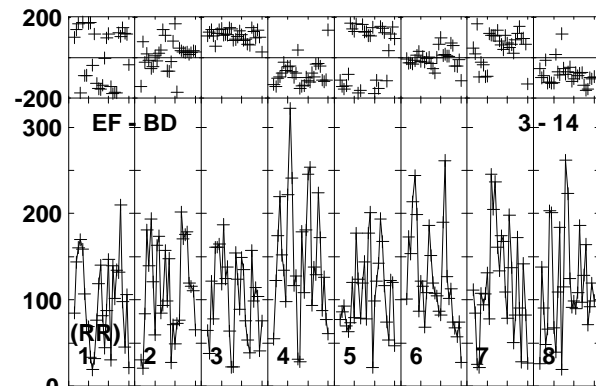
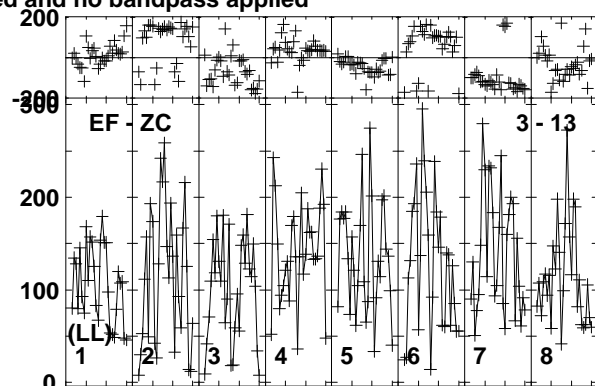
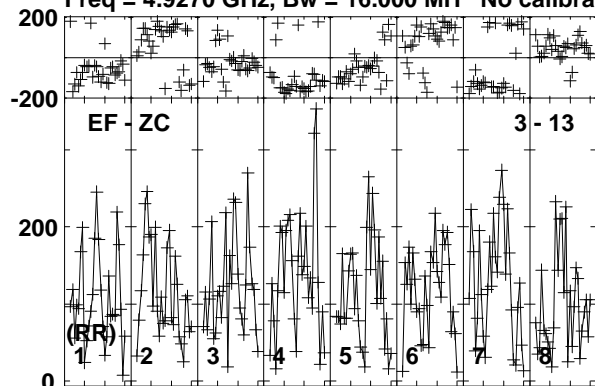

Lower frame: Micro Ampl Jy Top frame: Phas deg  
Vector averaged cross-power spectrum Baseline: EF (03) - ZC (13)  
Timerange: 00/09:50:31 to 00/09:53:29

Plot file version 181 created 19-DEC-2018 17:58:24

J1619+2247 RY007C.UVDATA.1

Freq = 4.9270 GHz, Bw = 16.000 MH No calibration applied and no bandpass applied

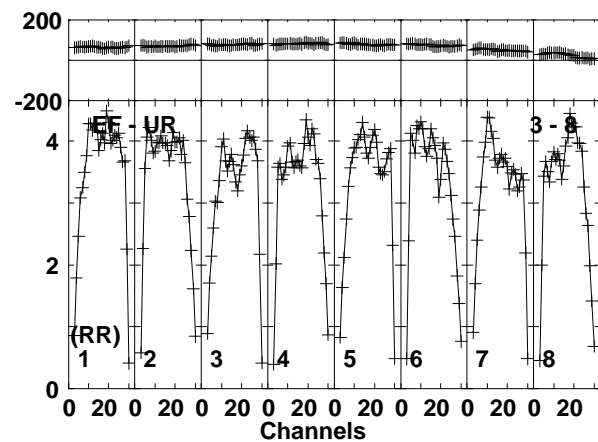
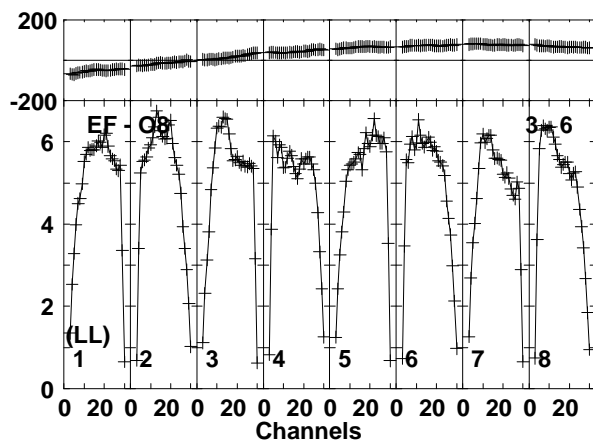
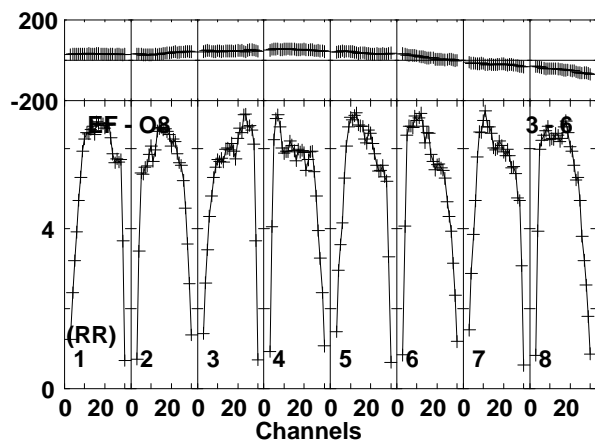
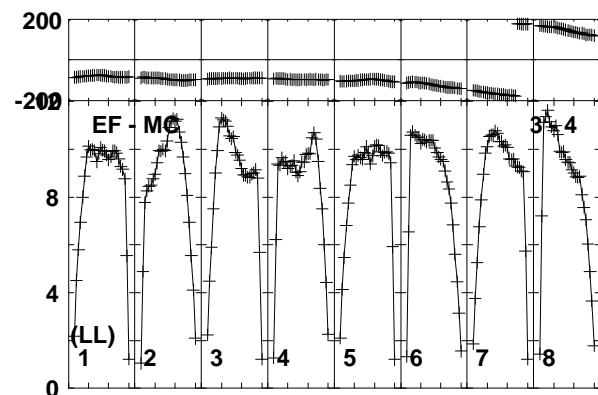
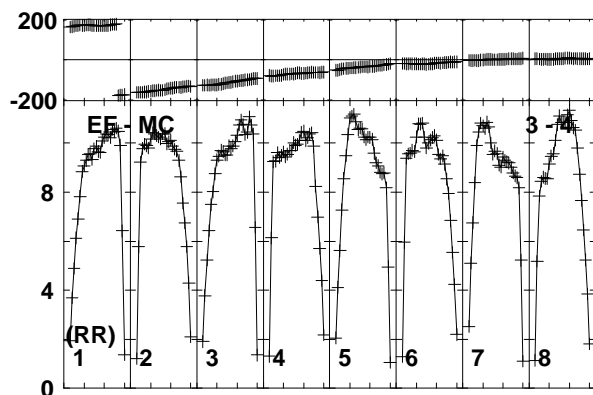
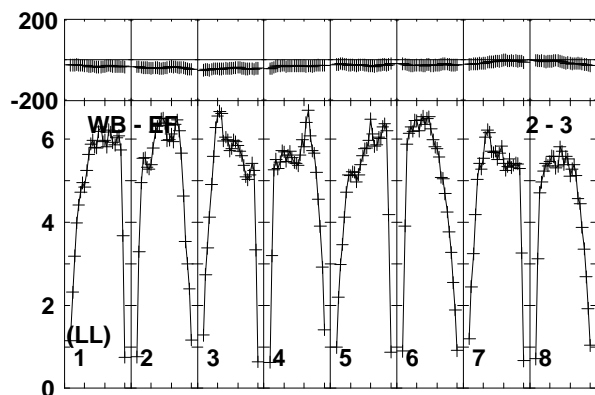
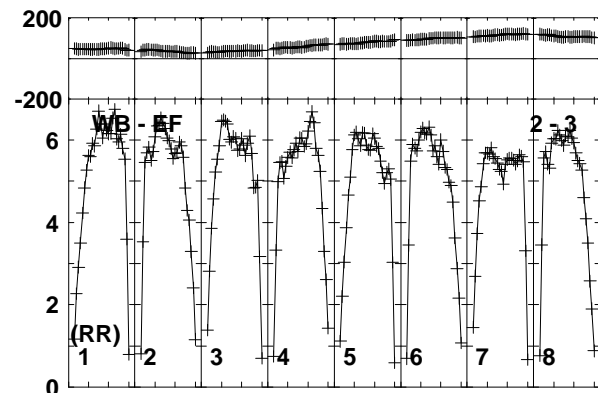
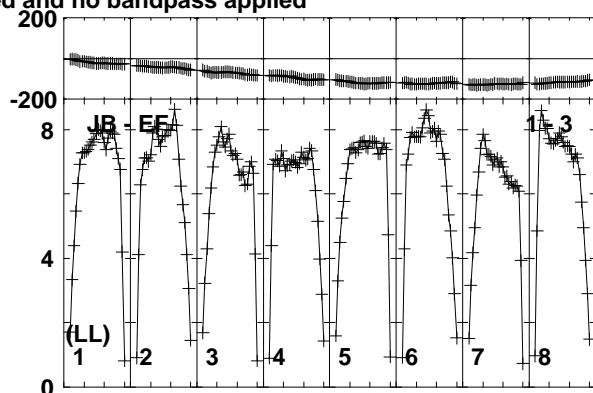
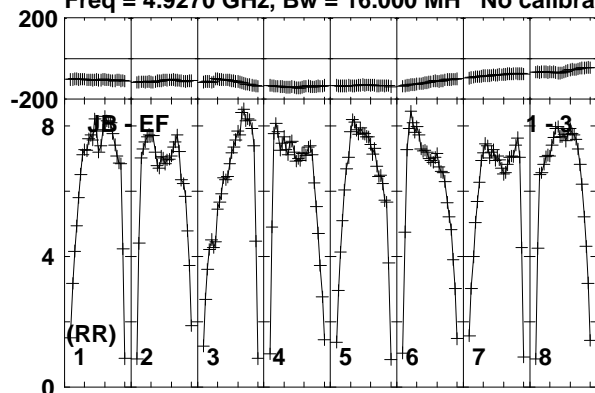

Lower frame: Milli Ampl Jy Top frame: Phas deg  
Vector averaged cross-power spectrum Baseline: JB (01) - EF (03)  
Timerange: 00/09:53:31 to 00/09:54:29

Plot file version 182 created 19-DEC-2018 17:58:24

J1619+2247 RY007C.UVDATA.1

Freq = 4.9270 GHz, Bw = 16.000 MH No calibration applied and no bandpass applied

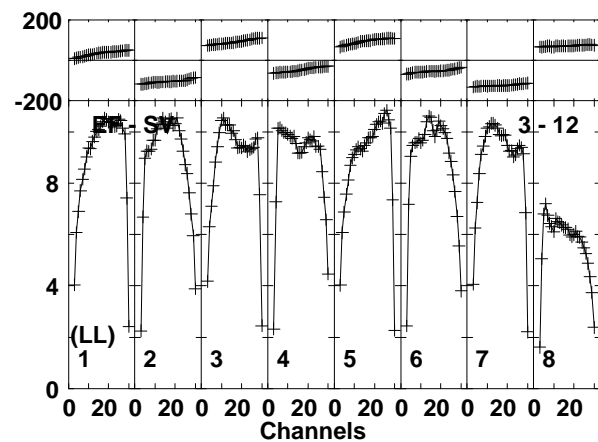
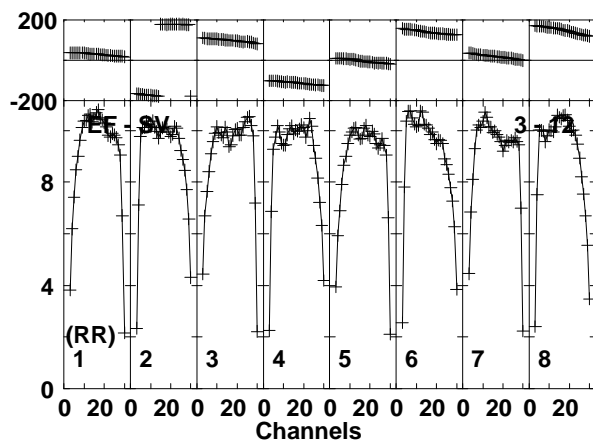
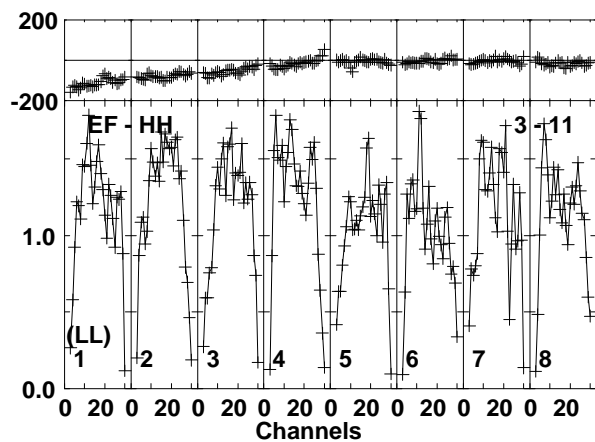
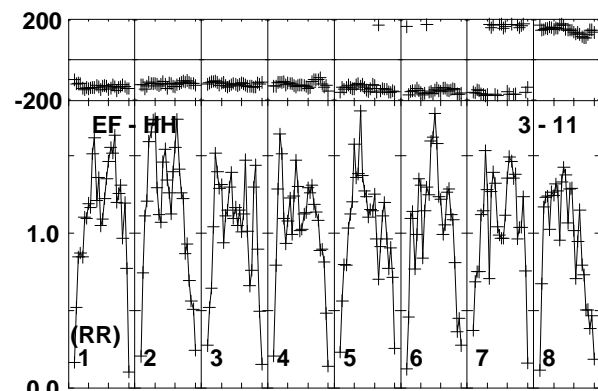
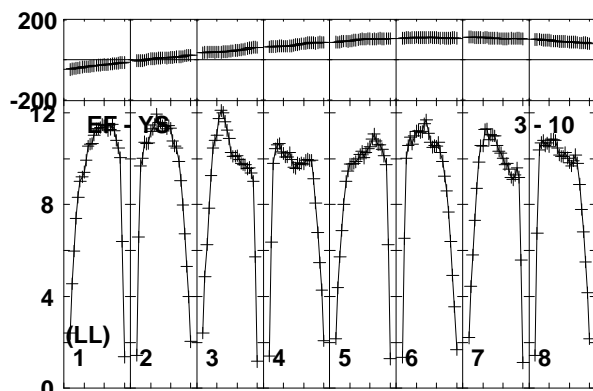
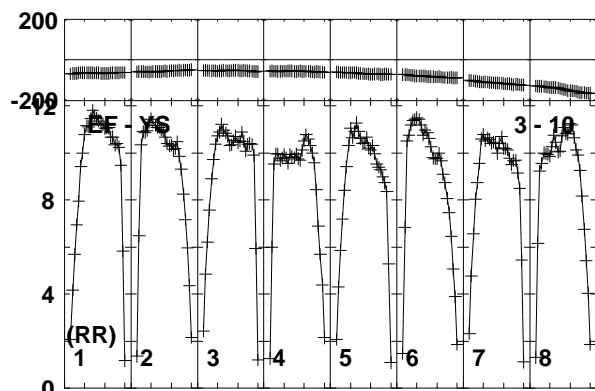
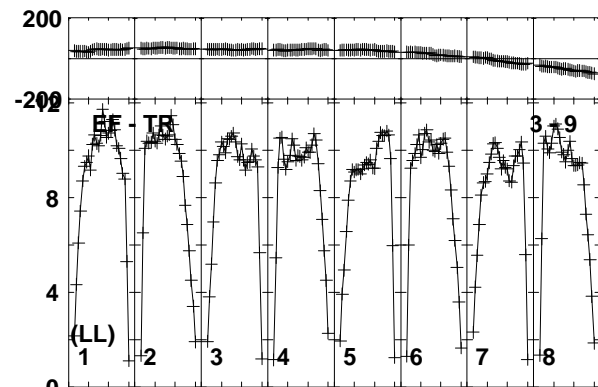
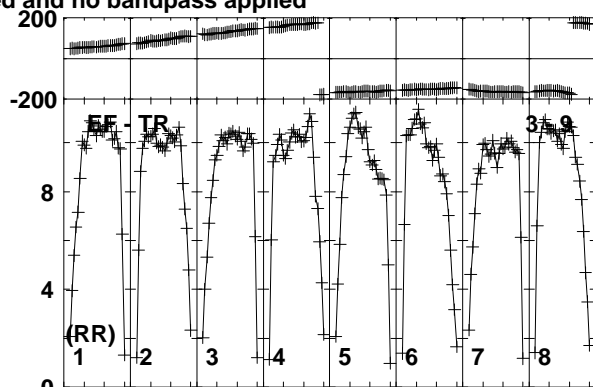
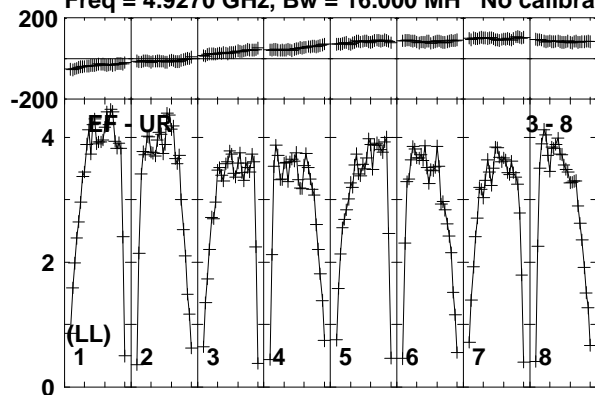

Lower frame: Milli Ampl Jy Top frame: Phas deg  
Vector averaged cross-power spectrum Baseline: EF (03) - UR (08)  
Timerange: 00/09:53:31 to 00/09:54:29

Plot file version 183 created 19-DEC-2018 17:58:24

J1619+2247 RY007C.UVDATA.1

Freq = 4.9270 GHz, Bw = 16.000 MH No calibration applied and no bandpass applied

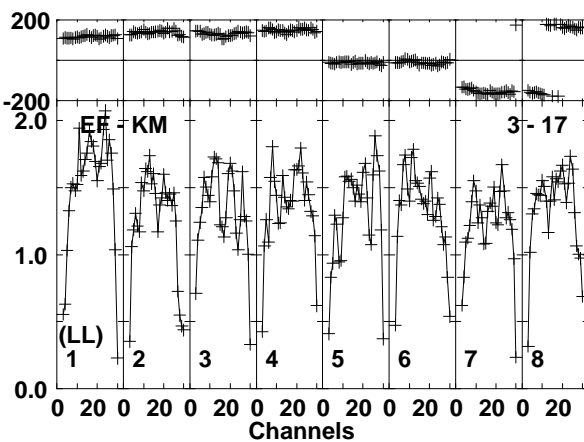
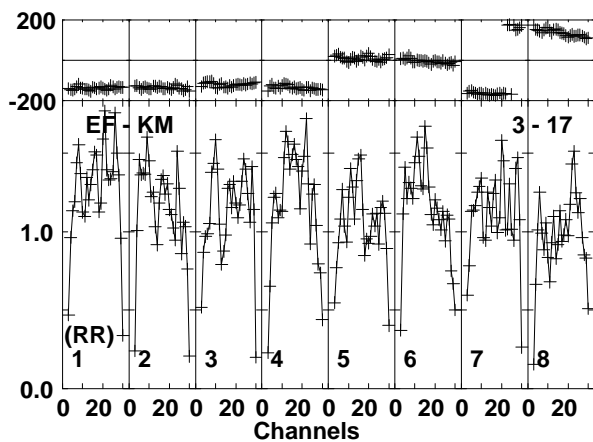
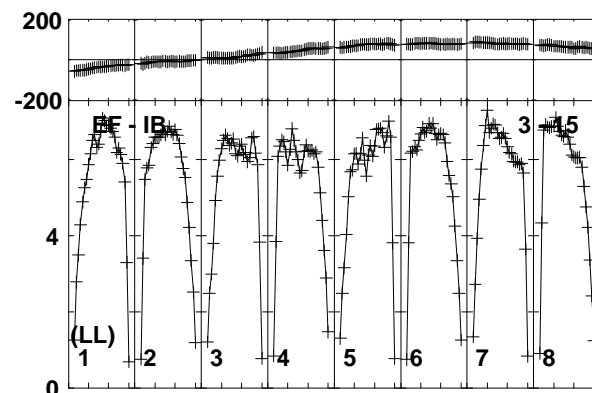
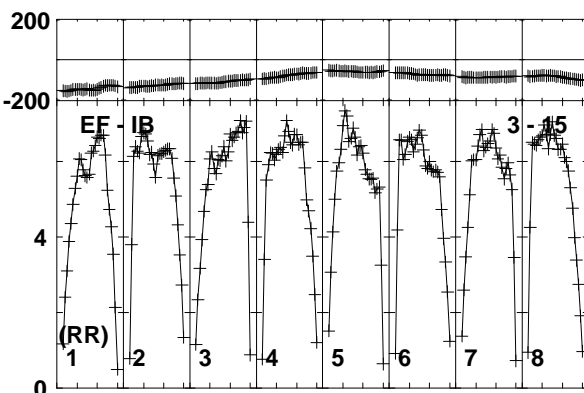
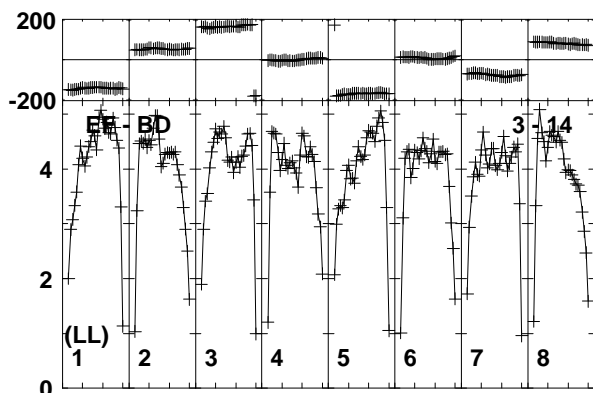
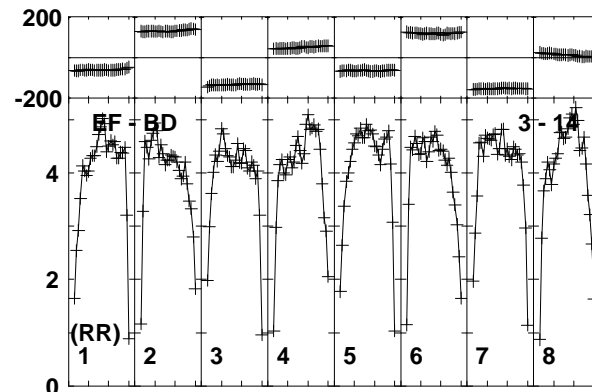
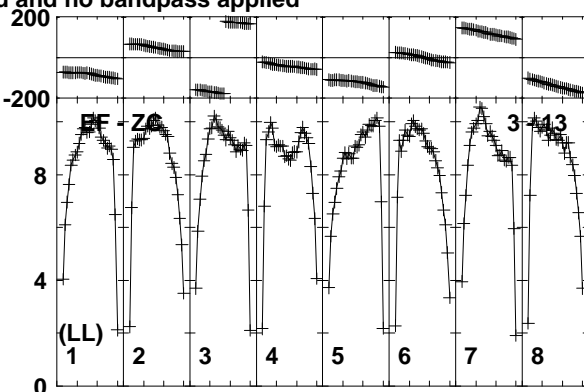
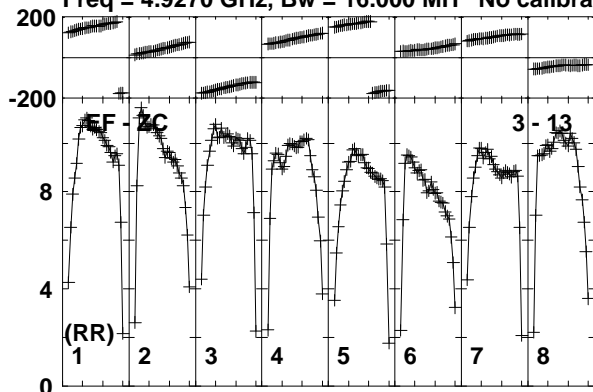

Lower frame: Milli Ampl Jy Top frame: Phas deg  
Vector averaged cross-power spectrum Baseline: EF (03) - ZC (13)  
Timerange: 00/09:53:31 to 00/09:54:29

Plot file version 184 created 19-DEC-2018 17:58:24

VLA1 RY007C.UVDATA.1

Freq = 4.9270 GHz, Bw = 16.000 MH No calibration applied and no bandpass applied

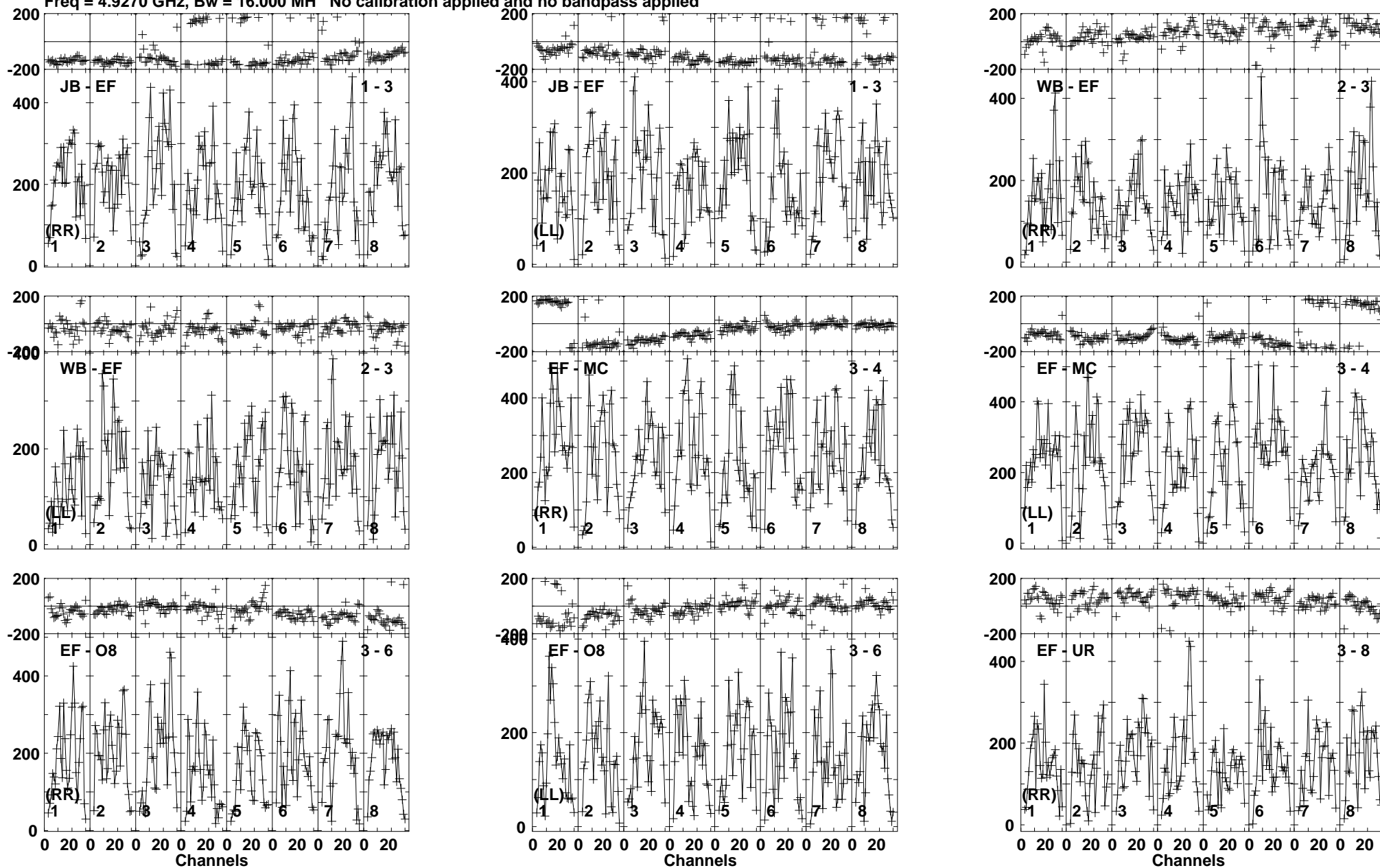

Lower frame: Micro Ampl Jy Top frame: Phas deg  
Vector averaged cross-power spectrum Baseline: JB (01) - EF (03)  
Timerange: 00/09:55:01 to 00/09:56:59

Plot file version 185 created 19-DEC-2018 17:58:24

VLA1 RY007C.UVDATA.1

Freq = 4.9270 GHz, Bw = 16.000 MH No calibration applied and no bandpass applied

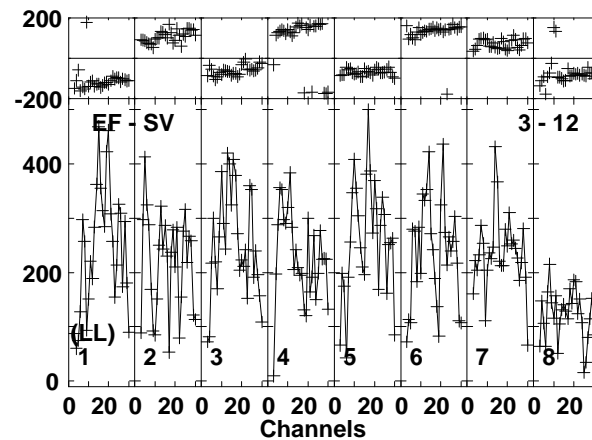
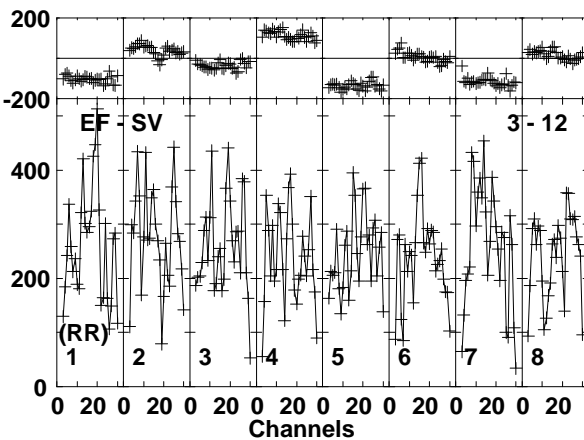
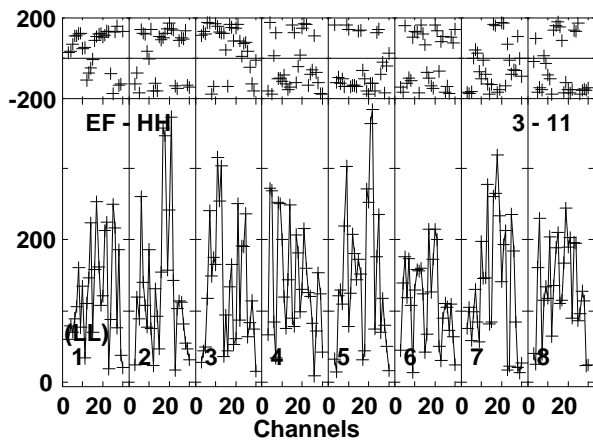
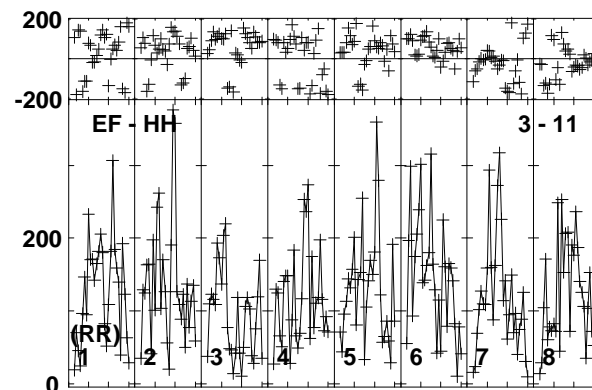
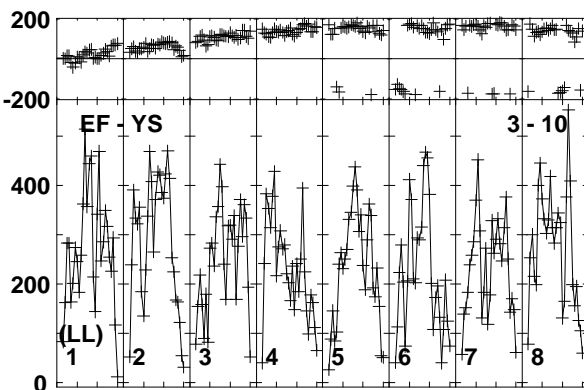
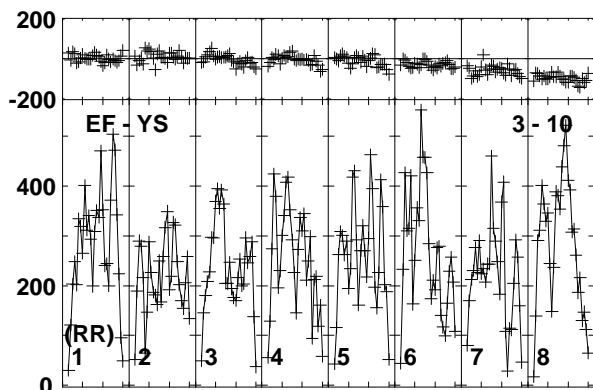
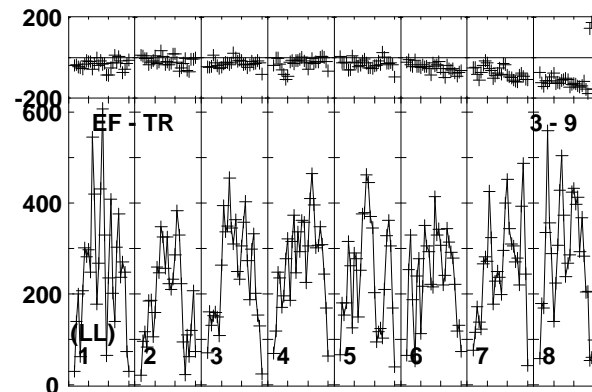
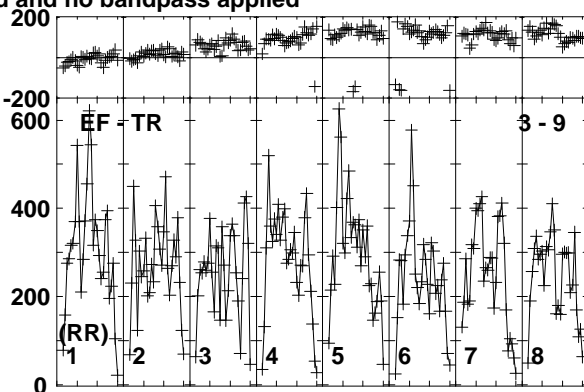
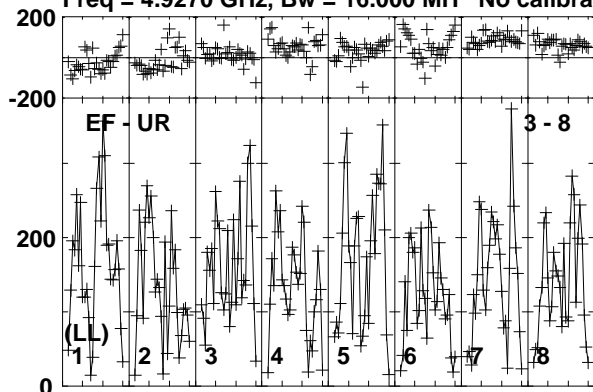

Lower frame: Micro Ampl Jy Top frame: Phas deg  
Vector averaged cross-power spectrum Baseline: EF (03) - UR (08)  
Timerange: 00/09:55:01 to 00/09:56:59

Plot file version 186 created 19-DEC-2018 17:58:24

VLA1 RY007C.UVDATA.1

Freq = 4.9270 GHz, Bw = 16.000 MH No calibration applied and no bandpass applied

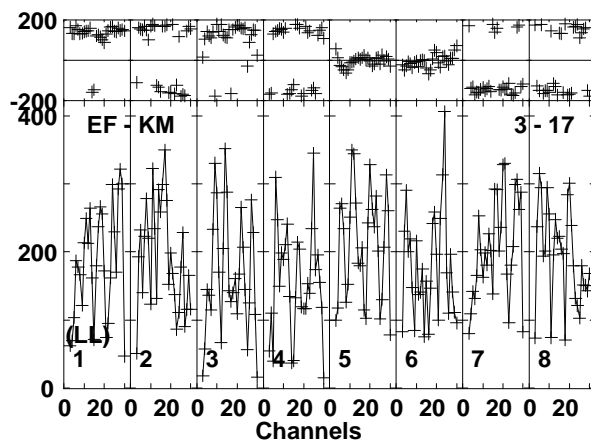
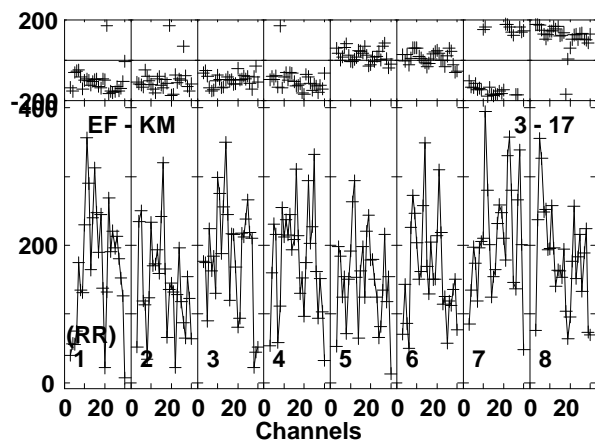
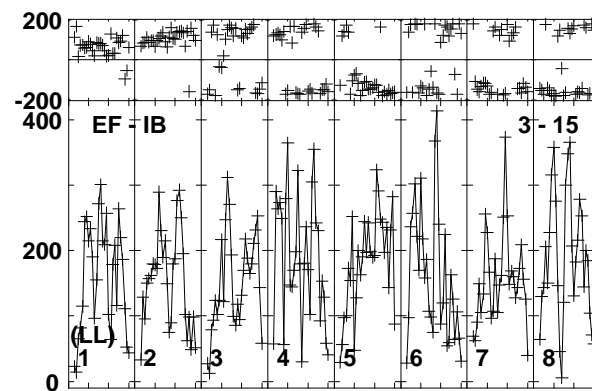
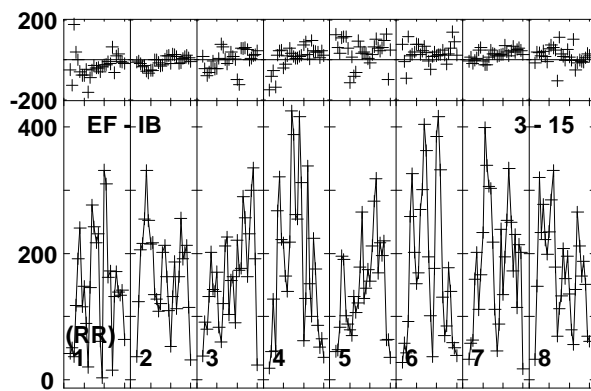
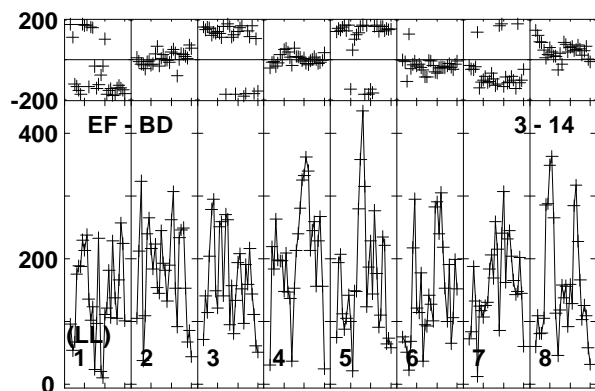
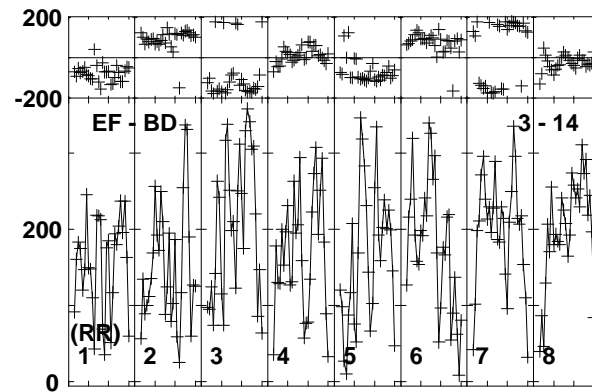
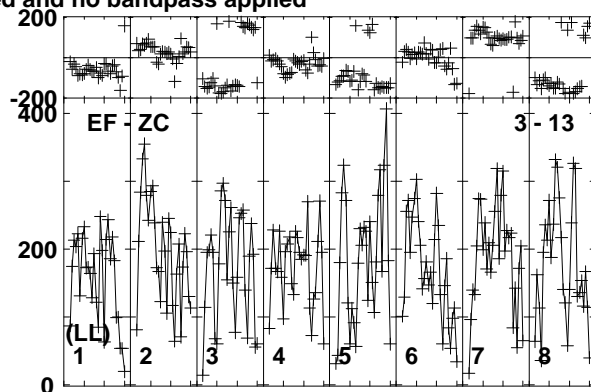
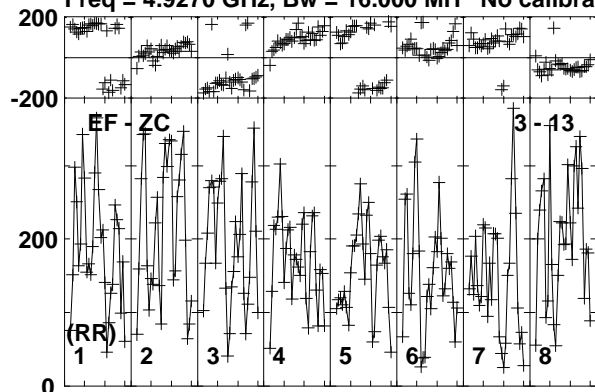

Lower frame: Micro Ampl Jy Top frame: Phas deg  
Vector averaged cross-power spectrum Baseline: EF (03) - ZC (13)  
Timerange: 00/09:55:01 to 00/09:56:59



Plot file version 187 created 19-DEC-2018 17:58:24

J1619+2247 RY007C.UVDATA.1

Freq = 4.9270 GHz, Bw = 16.000 MH No calibration applied and no bandpass applied

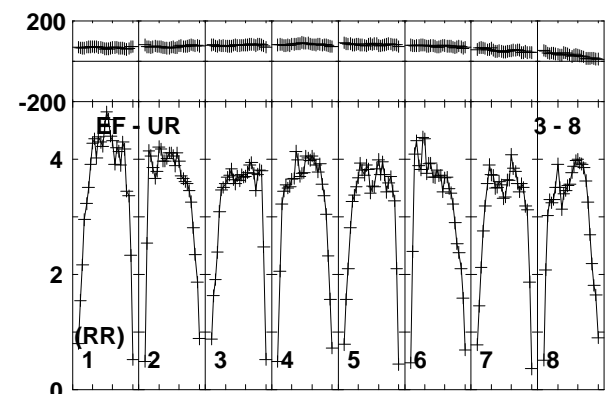
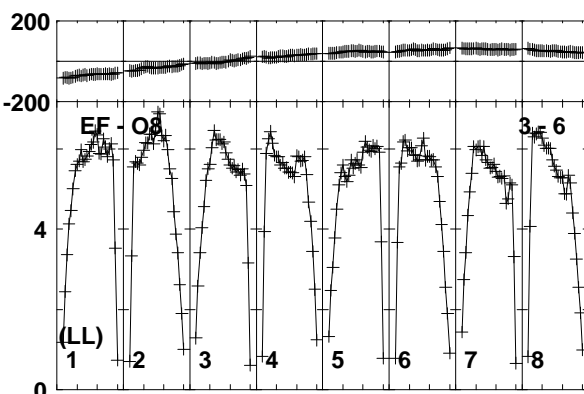
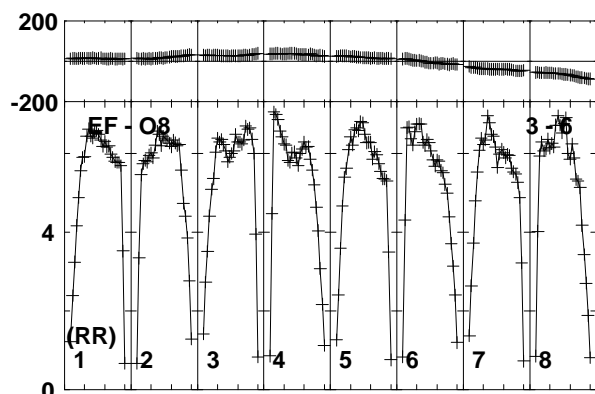
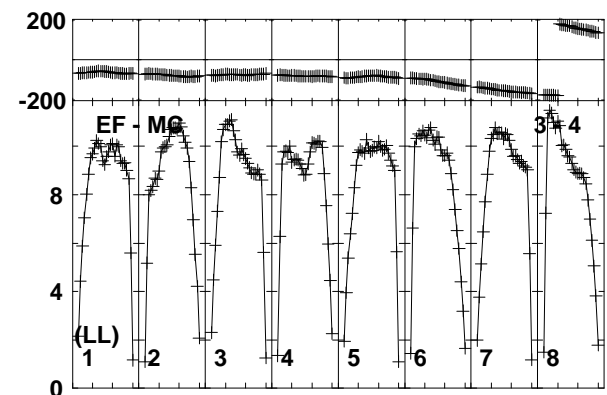
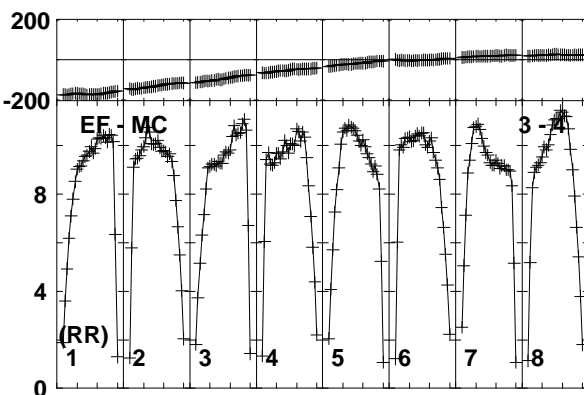
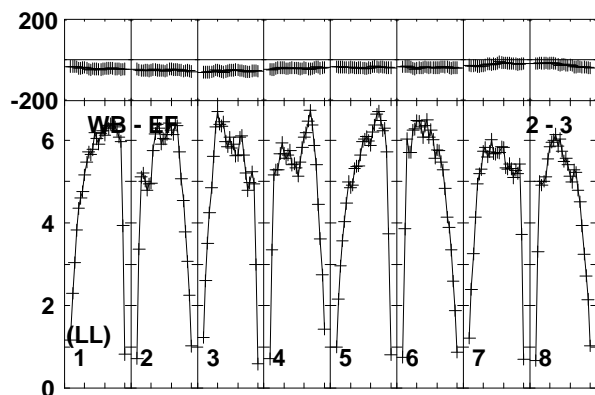
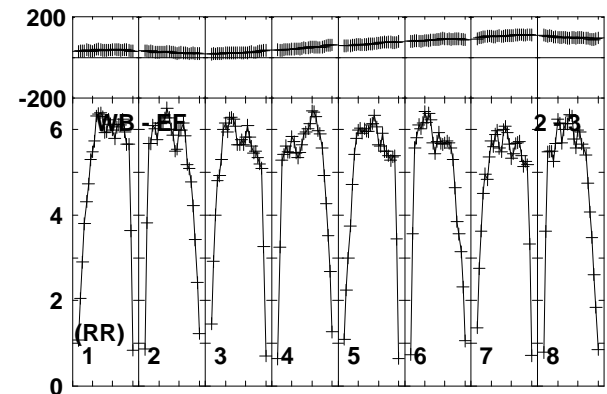
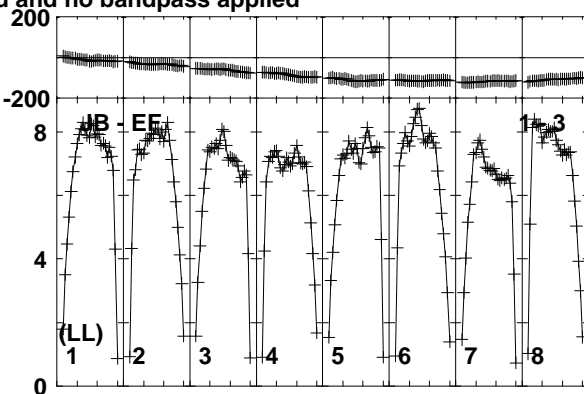
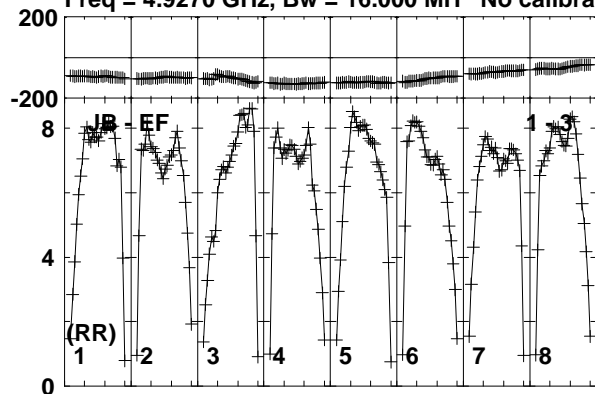

Lower frame: Milli Ampl Jy Top frame: Phas deg

Vector averaged cross-power spectrum Baseline: JB (01) - EF (03)

Timerange: 00/09:57:01 to 00/09:57:59

Plot file version 188 created 19-DEC-2018 17:58:24

J1619+2247 RY007C.UVDATA.1

Freq = 4.9270 GHz, Bw = 16.000 MH No calibration applied and no bandpass applied

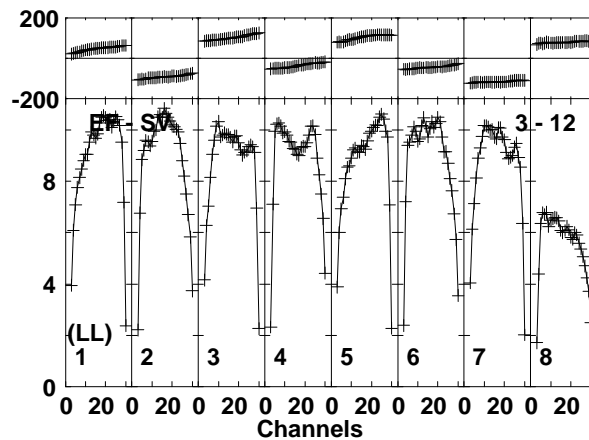
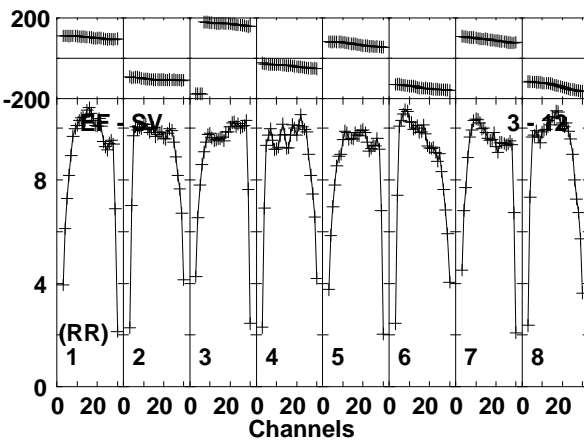
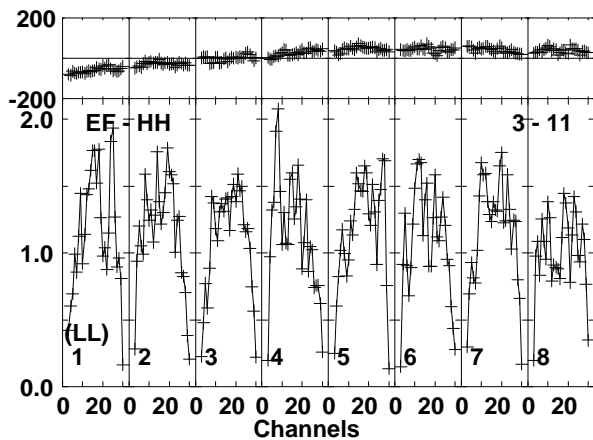
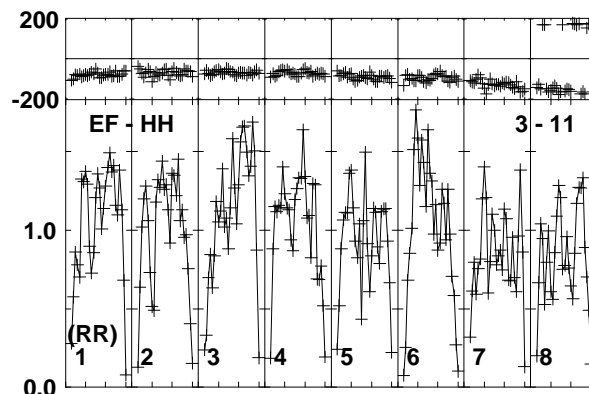
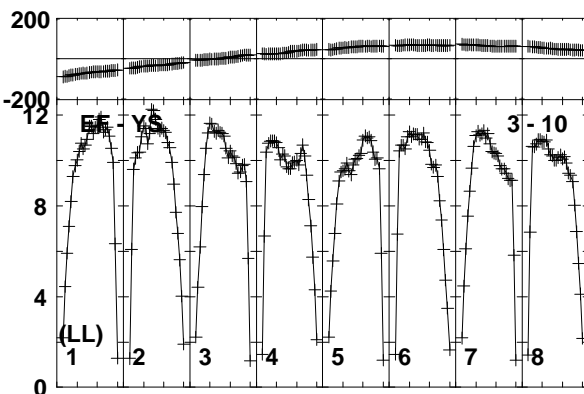
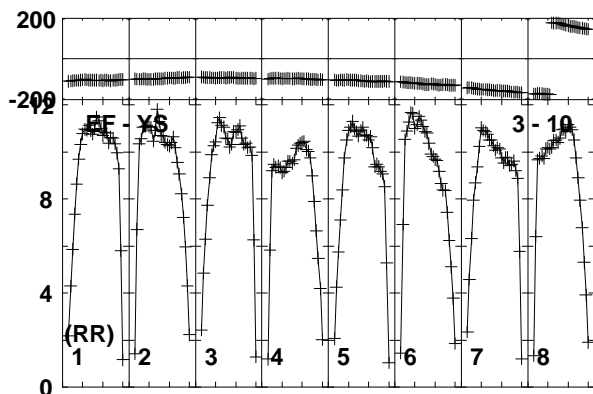
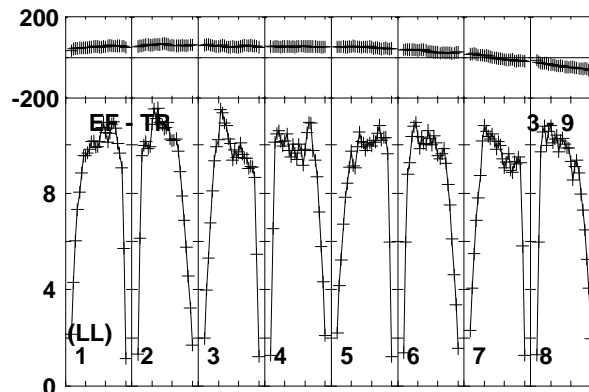
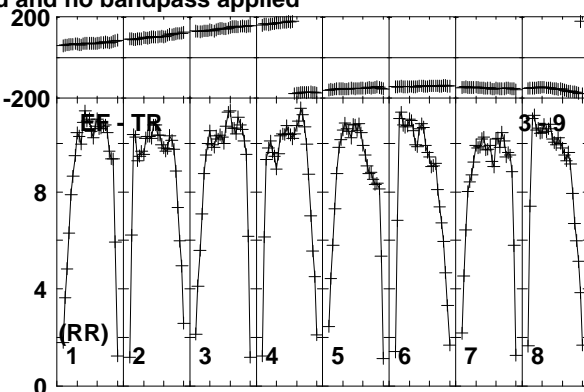
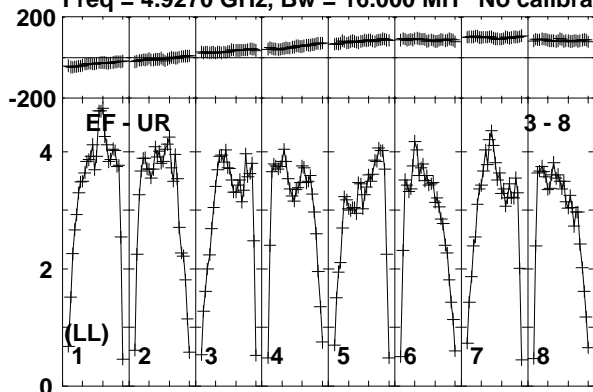

Lower frame: Milli Ampl Jy Top frame: Phas deg  
Vector averaged cross-power spectrum Baseline: EF (03) - UR (08)  
Timerange: 00/09:57:01 to 00/09:57:59

Plot file version 189 created 19-DEC-2018 17:58:24

J1619+2247 RY007C.UVDATA.1

Freq = 4.9270 GHz, Bw = 16.000 MH No calibration applied and no bandpass applied

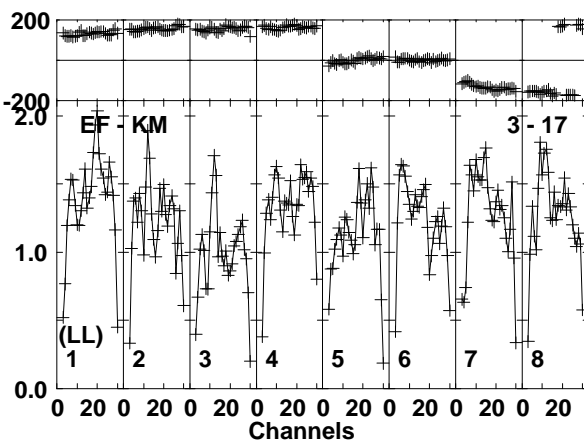
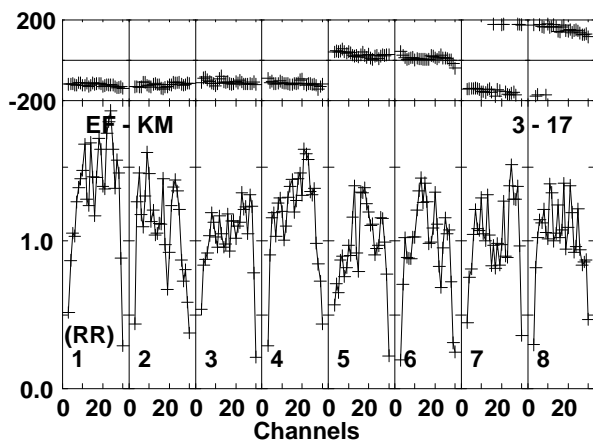
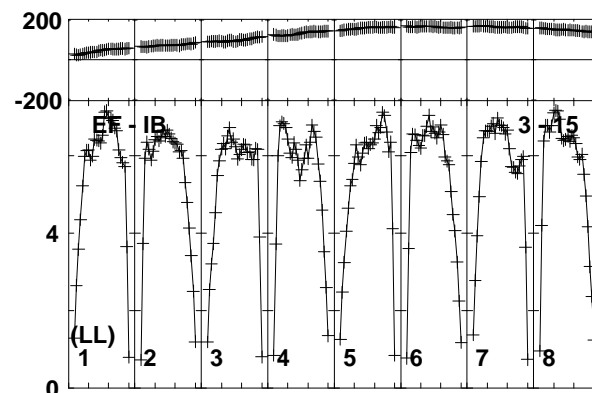
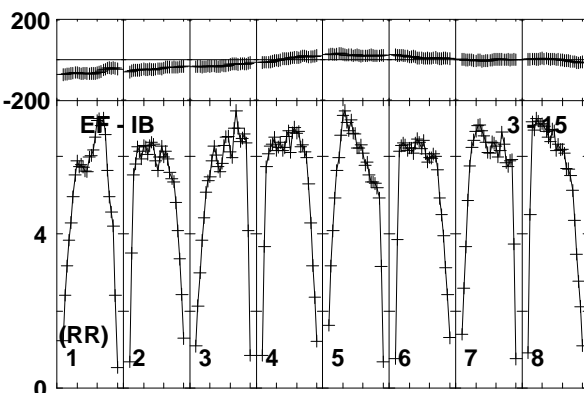
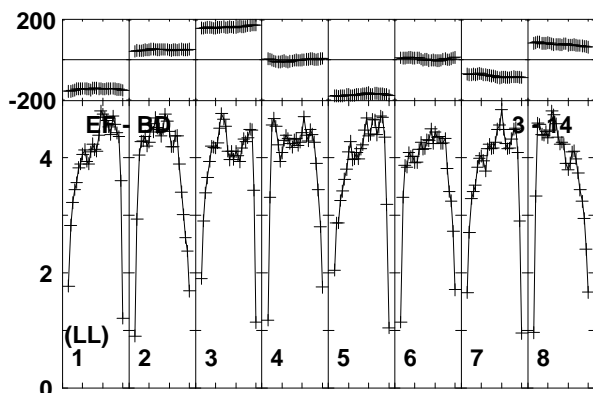
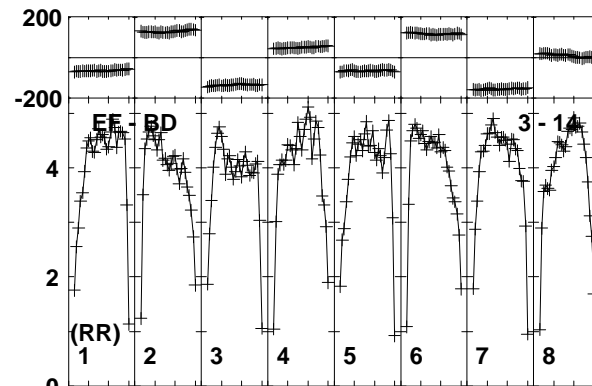
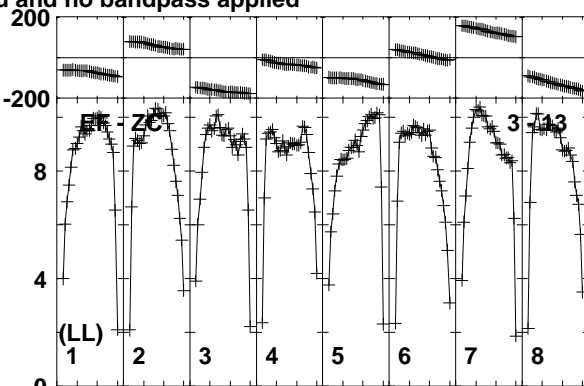
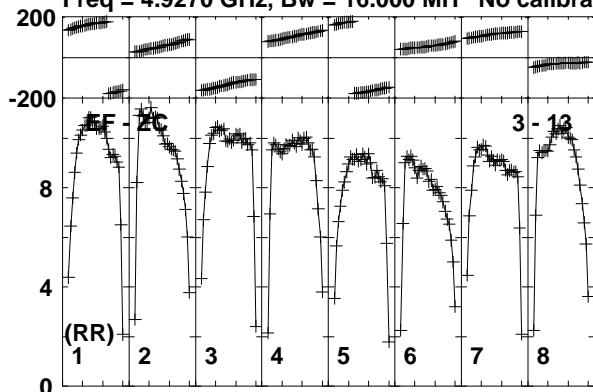

Lower frame: Milli Ampl Jy Top frame: Phas deg

Vector averaged cross-power spectrum Baseline: EF (03) - ZC (13)

Timerange: 00/09:57:01 to 00/09:57:59

Plot file version 190 created 19-DEC-2018 17:58:24  
AT2018\_RY007C.UVDATA.1

Freq = 4.9270 GHz, Bw = 16.000 MH No calibration applied and no bandpass applied

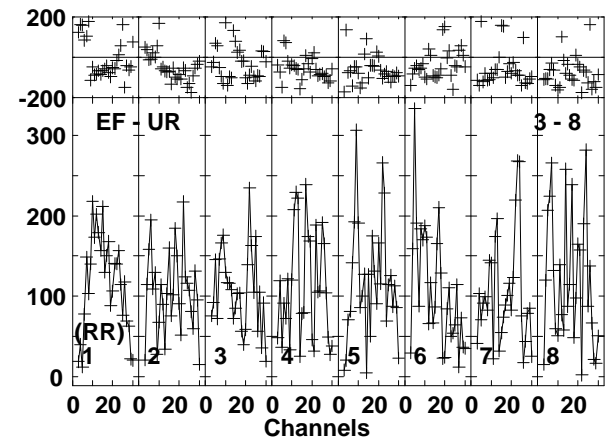
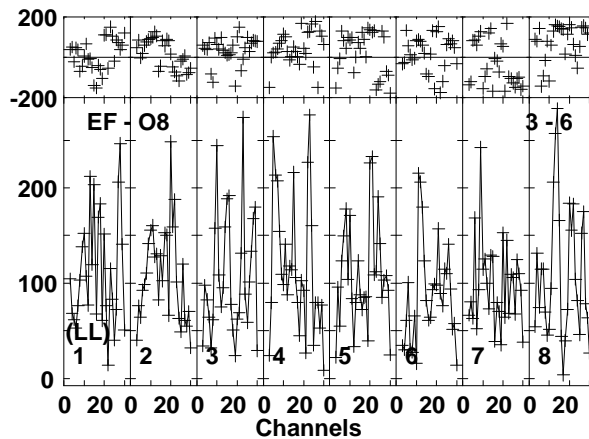
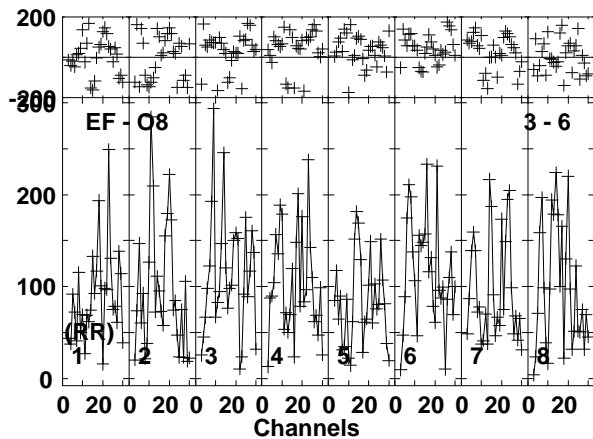
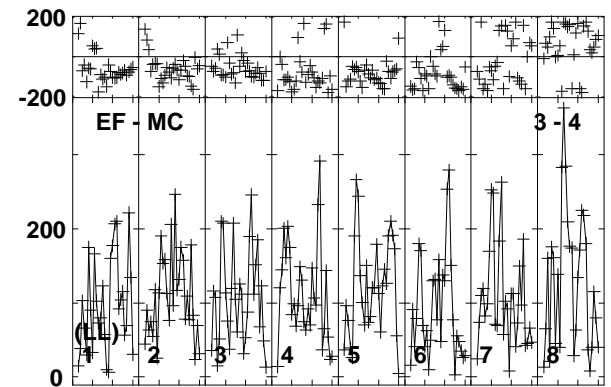
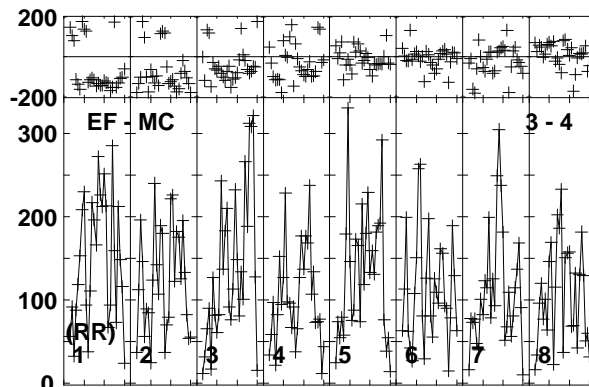
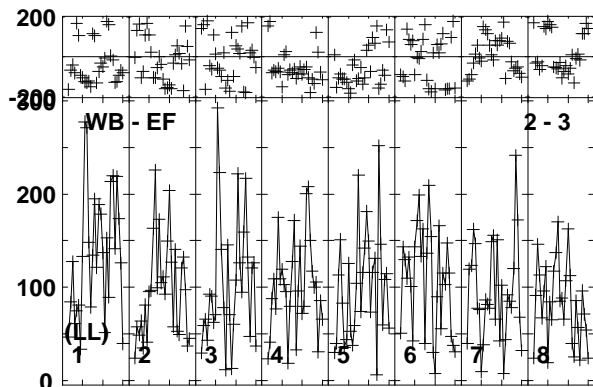
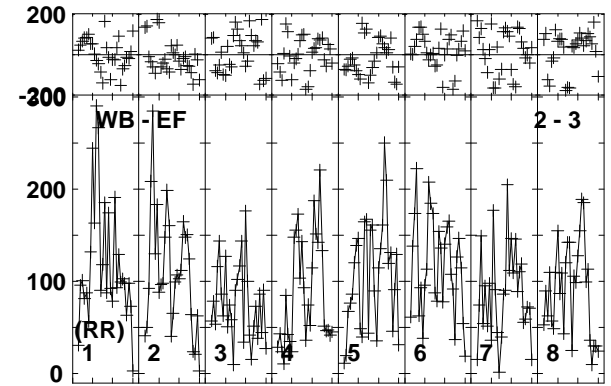
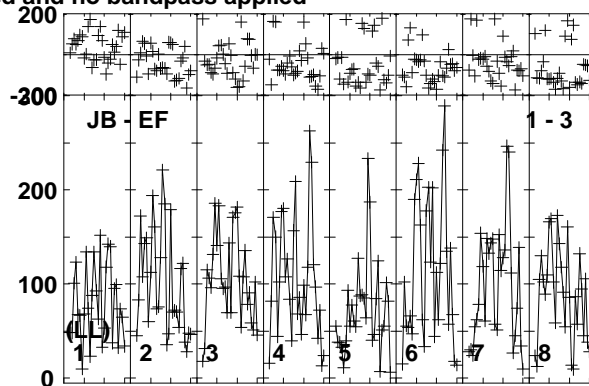
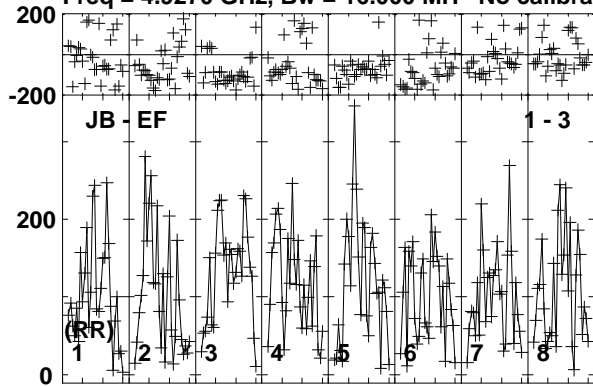

Lower frame: Micro Ampl Jy Top frame: Phas deg  
Vector averaged cross-power spectrum Baseline: JB (01) - EF (03)  
Timerange: 00/09:58:01 to 00/10:00:59

Plot file version 191 created 19-DEC-2018 17:58:25

AT2018\_RY007C.UVDATA.1

Freq = 4.9270 GHz, Bw = 16.000 MH No calibration applied and no bandpass applied

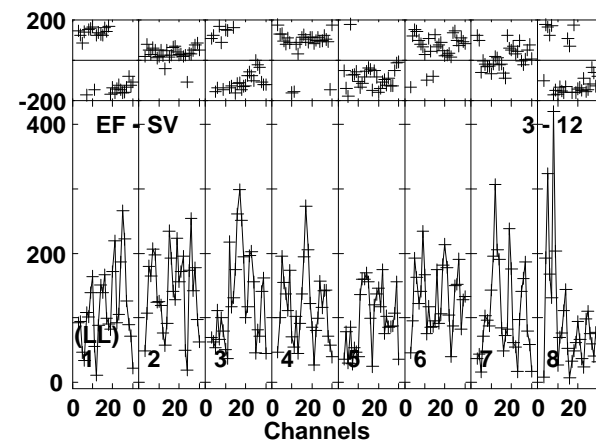
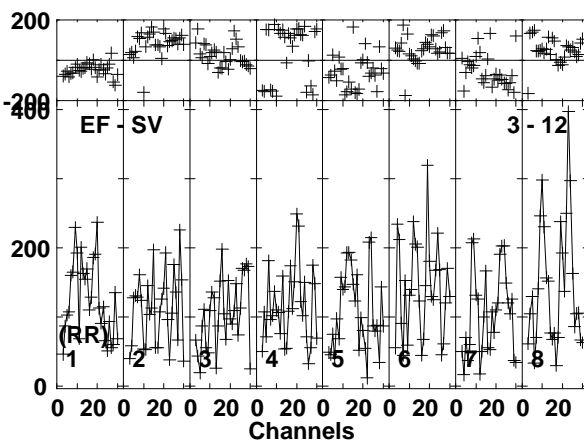
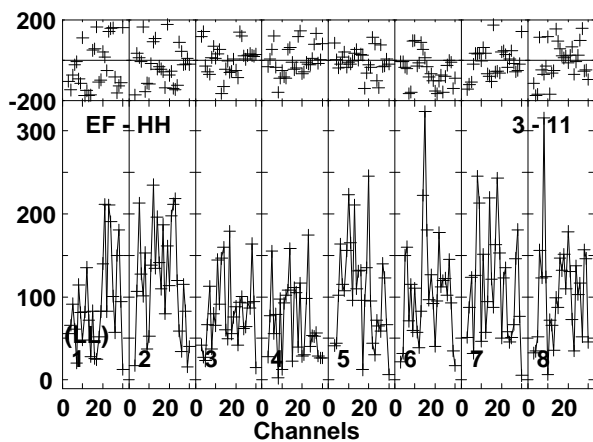
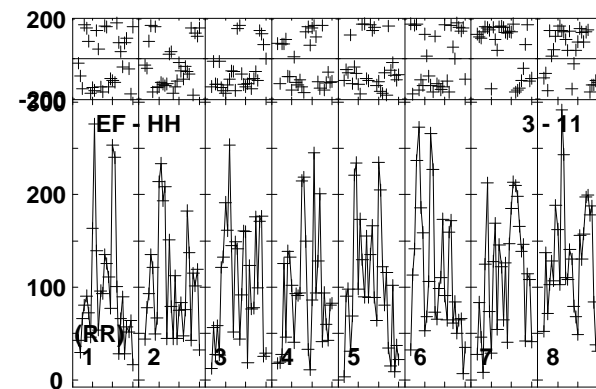
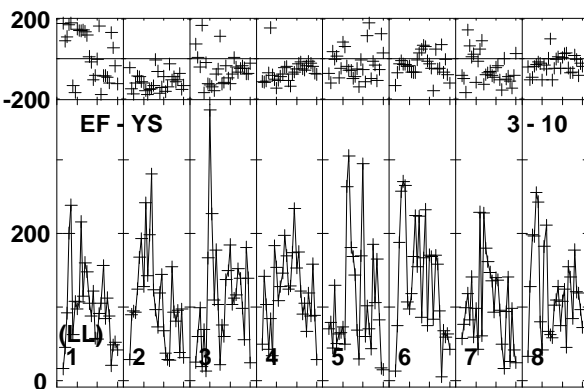
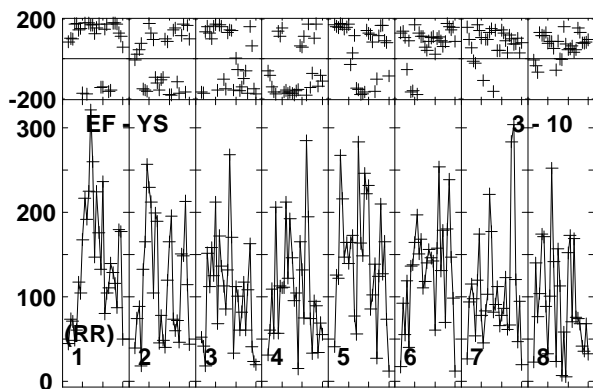
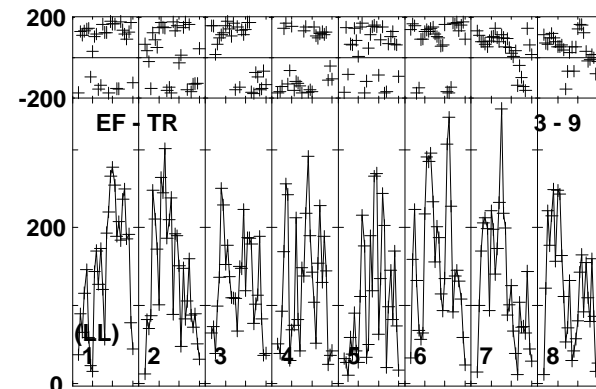
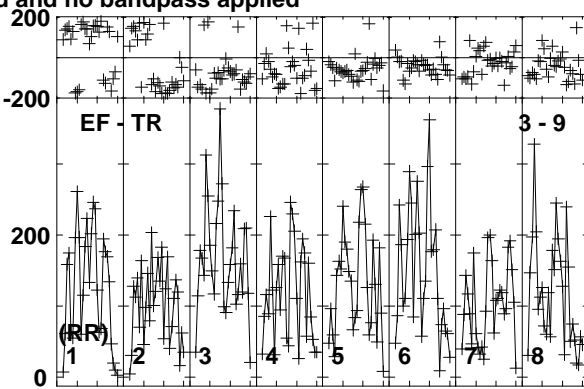
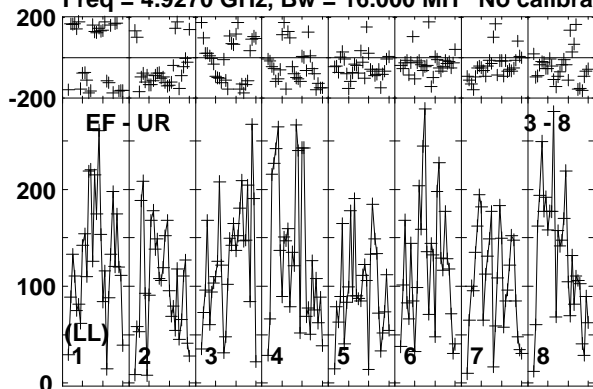

Lower frame: Micro Ampl Jy Top frame: Phas deg  
Vector averaged cross-power spectrum Baseline: EF (03) - UR (08)  
Timerange: 00/09:58:01 to 00/10:00:59

Plot file version 192 created 19-DEC-2018 17:58:25

AT2018\_RY007C.UVDATA.1

Freq = 4.9270 GHz, Bw = 16.000 MH No calibration applied and no bandpass applied

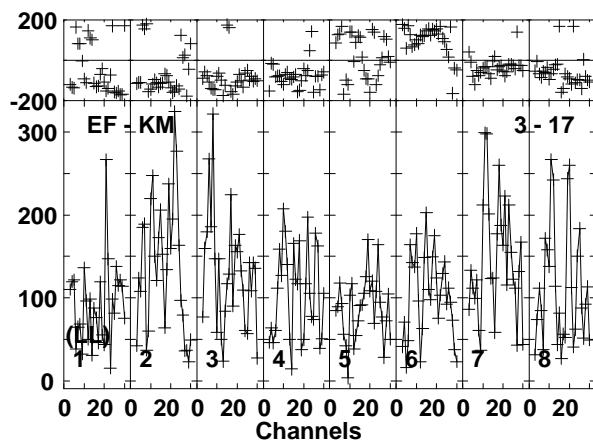
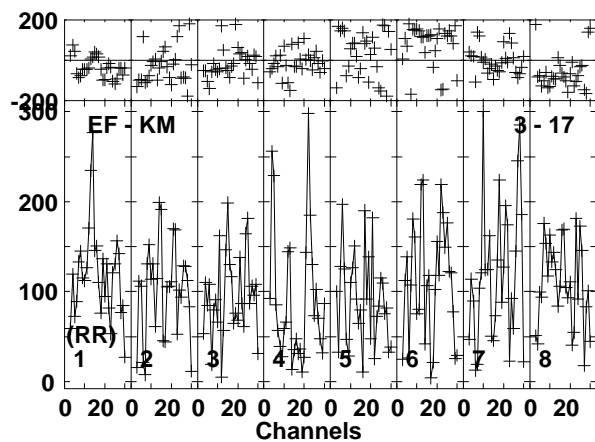
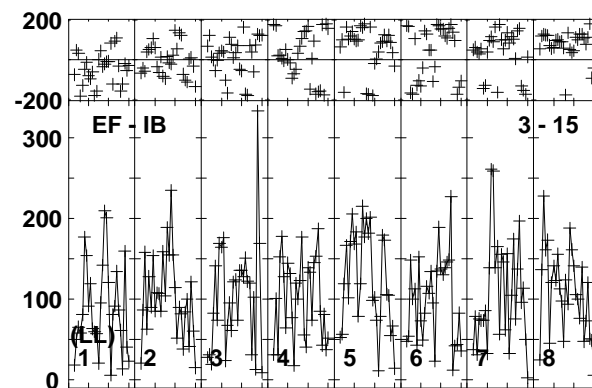
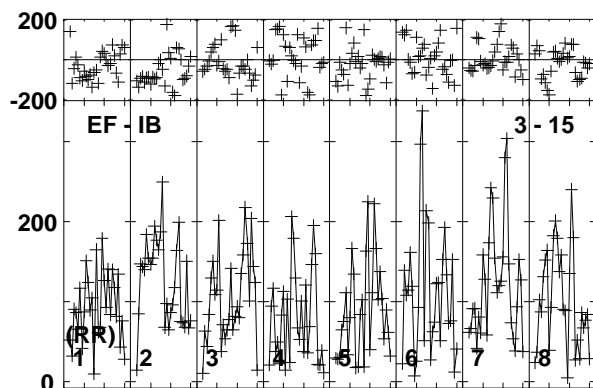
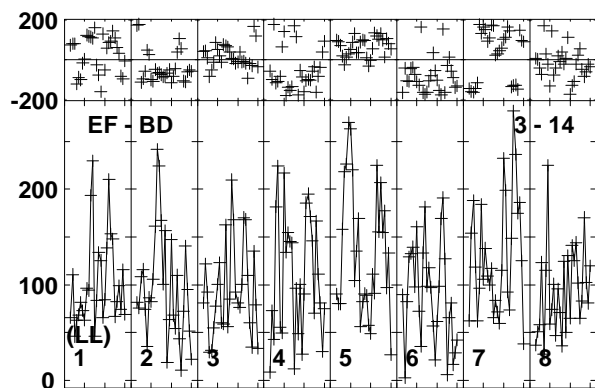
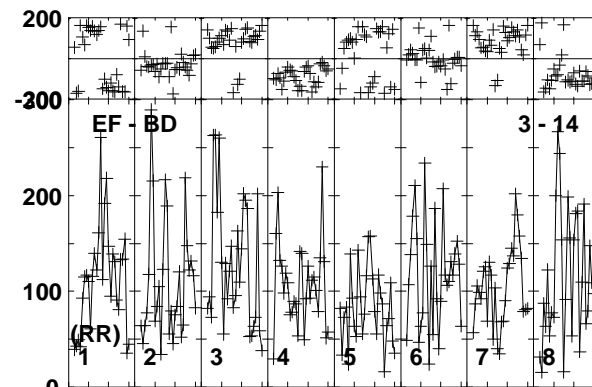
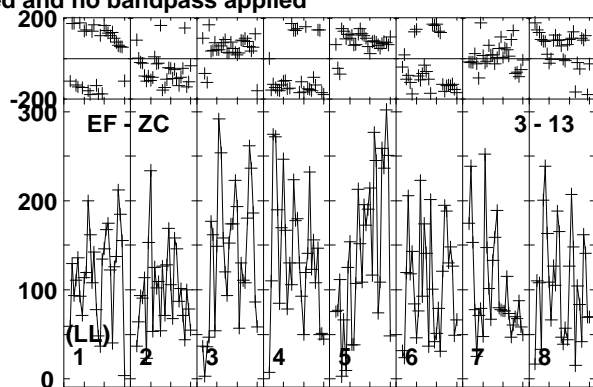
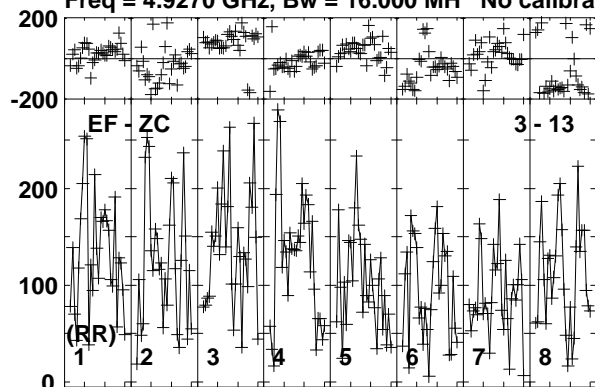

Lower frame: Micro Ampl Jy Top frame: Phas deg  
Vector averaged cross-power spectrum Baseline: EF (03) - ZC (13)  
Timerange: 00/09:58:01 to 00/10:00:59

Plot file version 193 created 19-DEC-2018 17:58:25

J1619+2247 RY007C.UVDATA.1

Freq = 4.9270 GHz, Bw = 16.000 MH No calibration applied and no bandpass applied

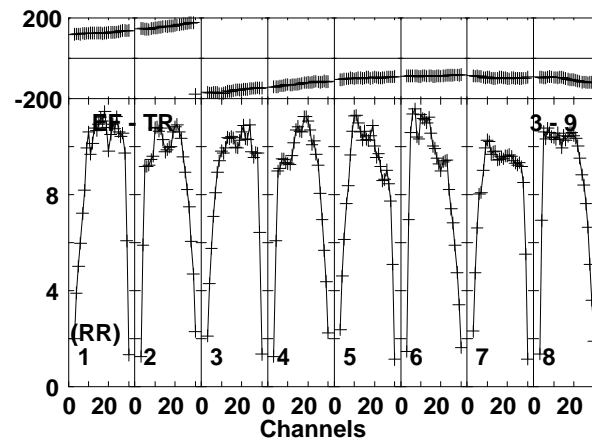
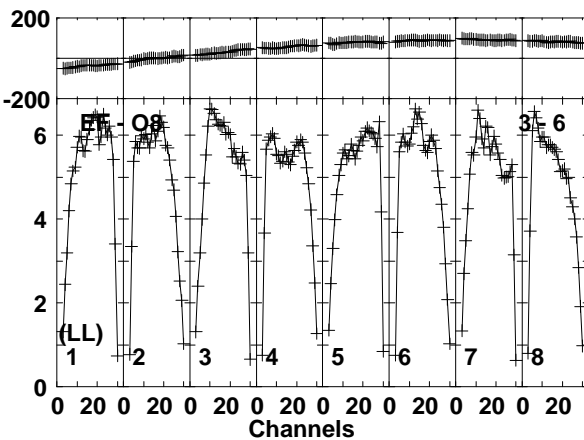
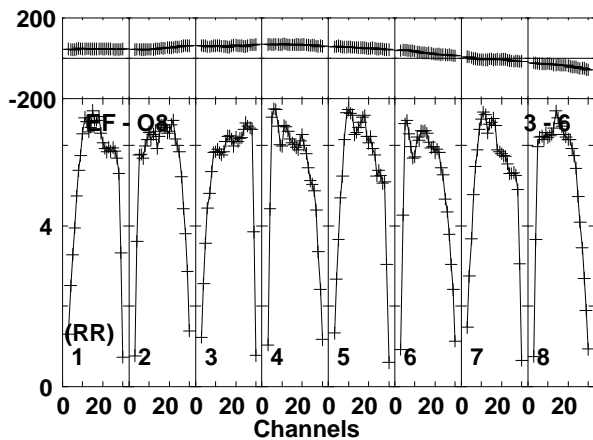
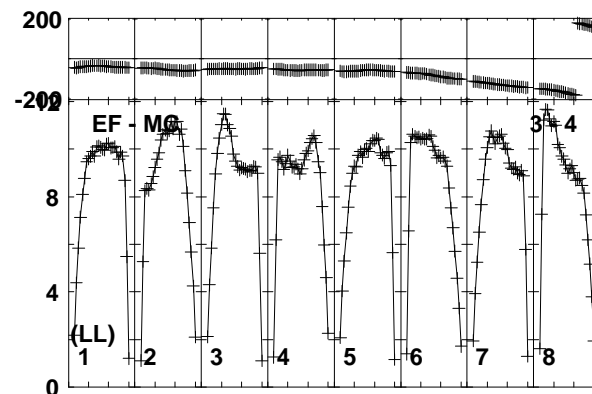
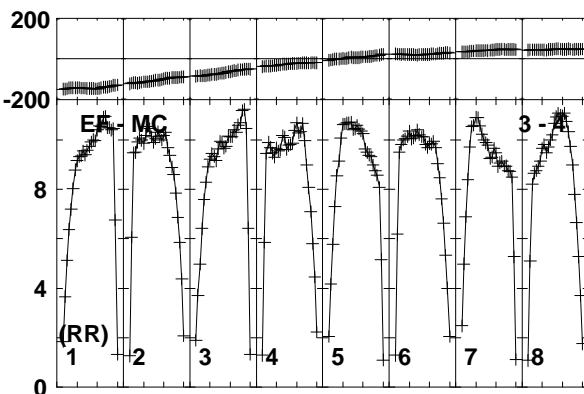
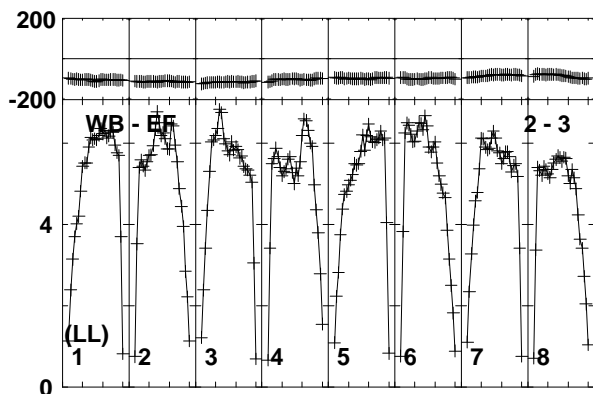
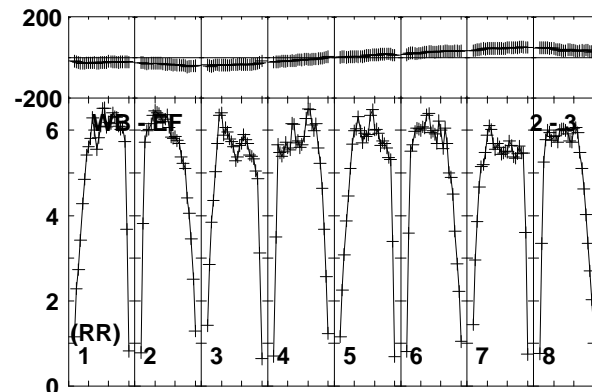
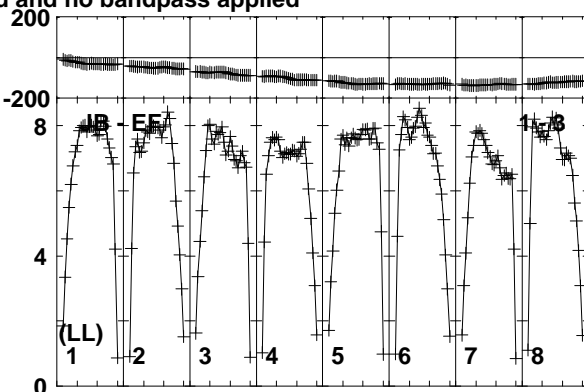
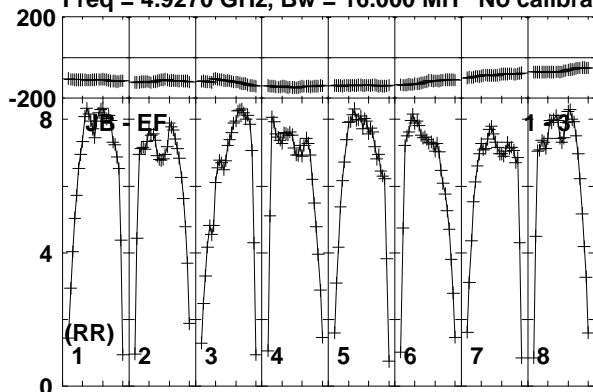

Lower frame: Milli Ampl Jy Top frame: Phas deg  
Vector averaged cross-power spectrum Baseline: JB (01) - EF (03)  
Timerange: 00/10:01:01 to 00/10:01:59

Plot file version 194 created 19-DEC-2018 17:58:25

J1619+2247 RY007C.UVDATA.1

Freq = 4.9270 GHz, Bw = 16.000 MH No calibration applied and no bandpass applied

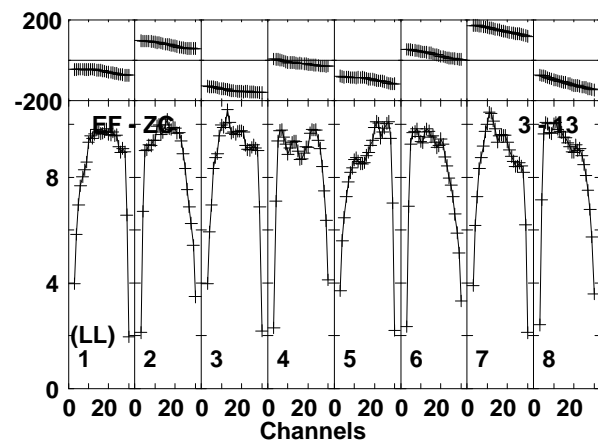
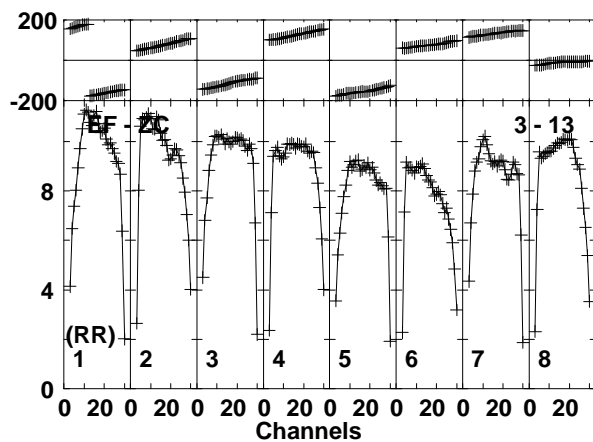
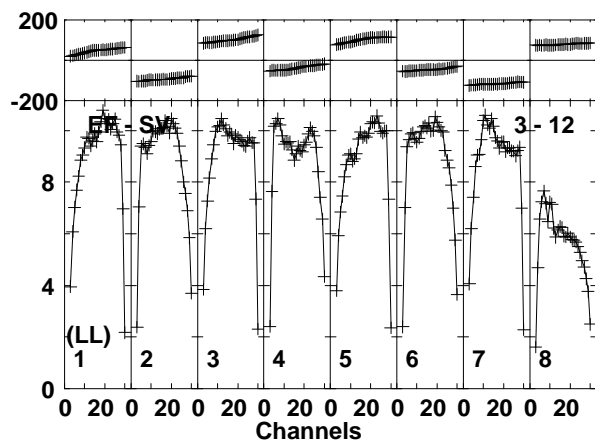
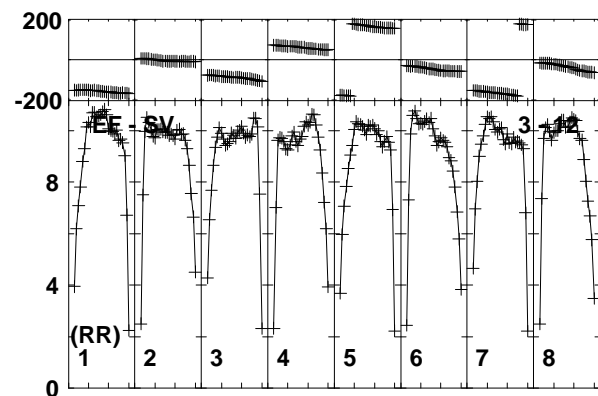
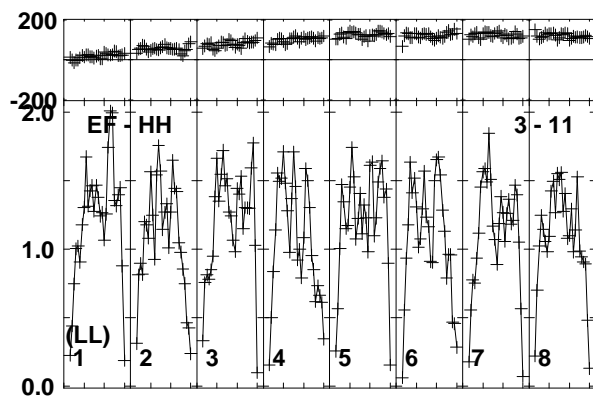
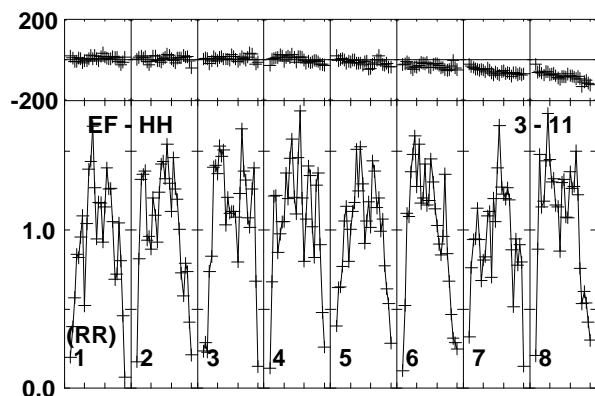
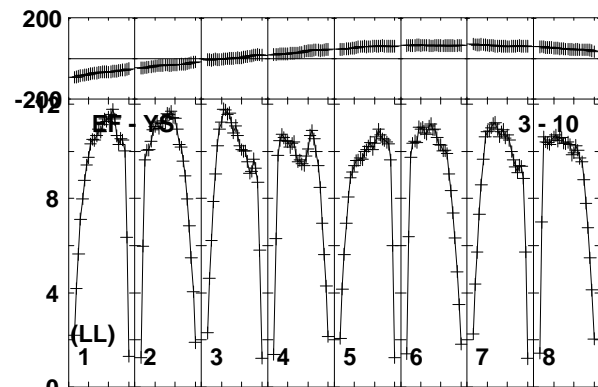
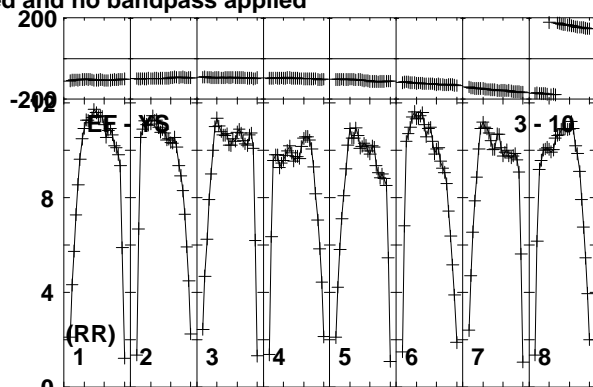
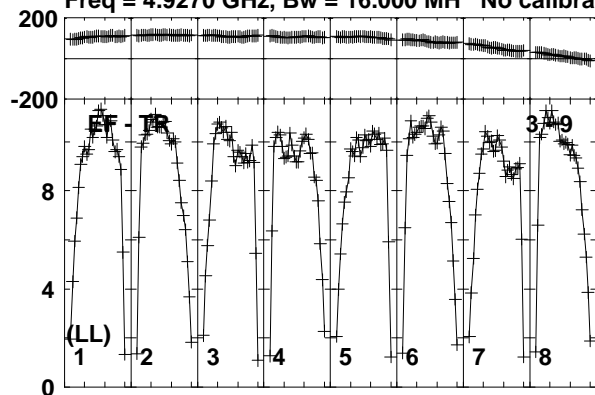

Lower frame: Milli Ampl Jy Top frame: Phas deg  
Vector averaged cross-power spectrum Baseline: EF (03) - TR (09)  
Timerange: 00/10:01:01 to 00/10:01:59



Plot file version 195 created 19-DEC-2018 17:58:25

J1619+2247 RY007C.UVDATA.1

Freq = 4.9270 GHz, Bw = 16.000 MH No calibration applied and no bandpass applied

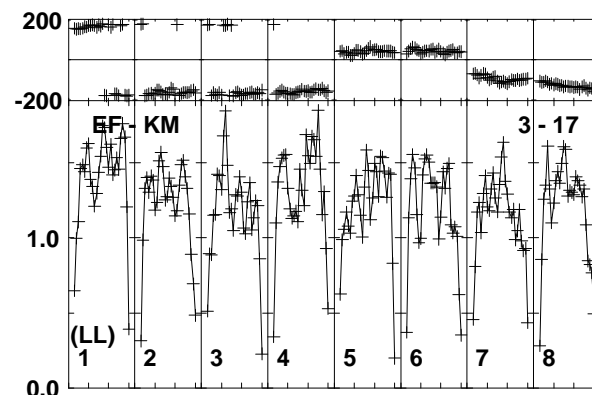
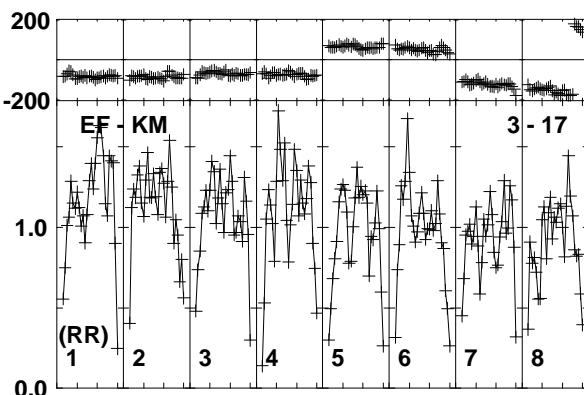
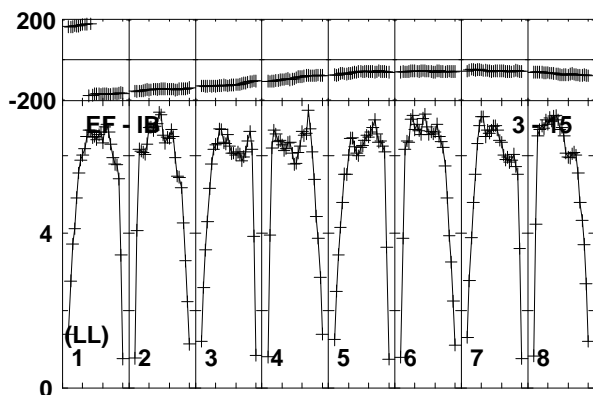
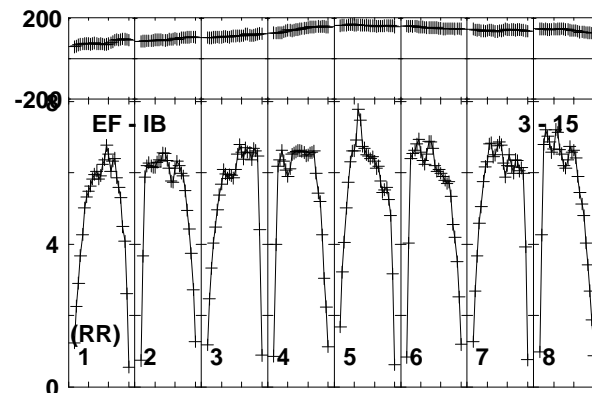
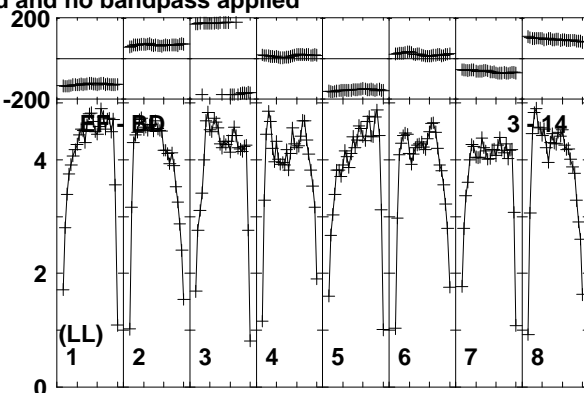
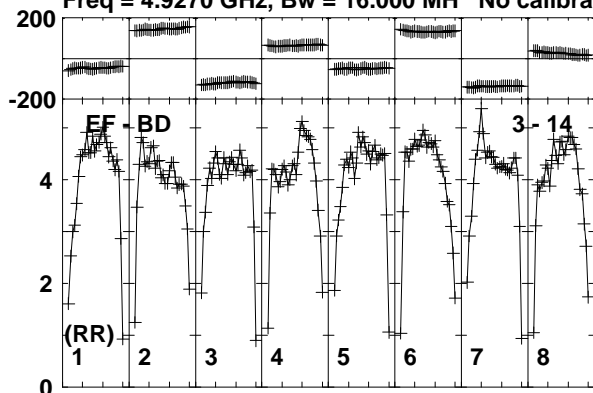

Lower frame: Milli Ampl Jy Top frame: Phas deg  
Vector averaged cross-power spectrum Baseline: EF (03) - BD (14)  
Timerange: 00/10:01:01 to 00/10:01:59

Plot file version 196 created 19-DEC-2018 17:58:25

AT2018\_RY007C.UVDATA.1

Freq = 4.9270 GHz, Bw = 16.000 MH No calibration applied and no bandpass applied

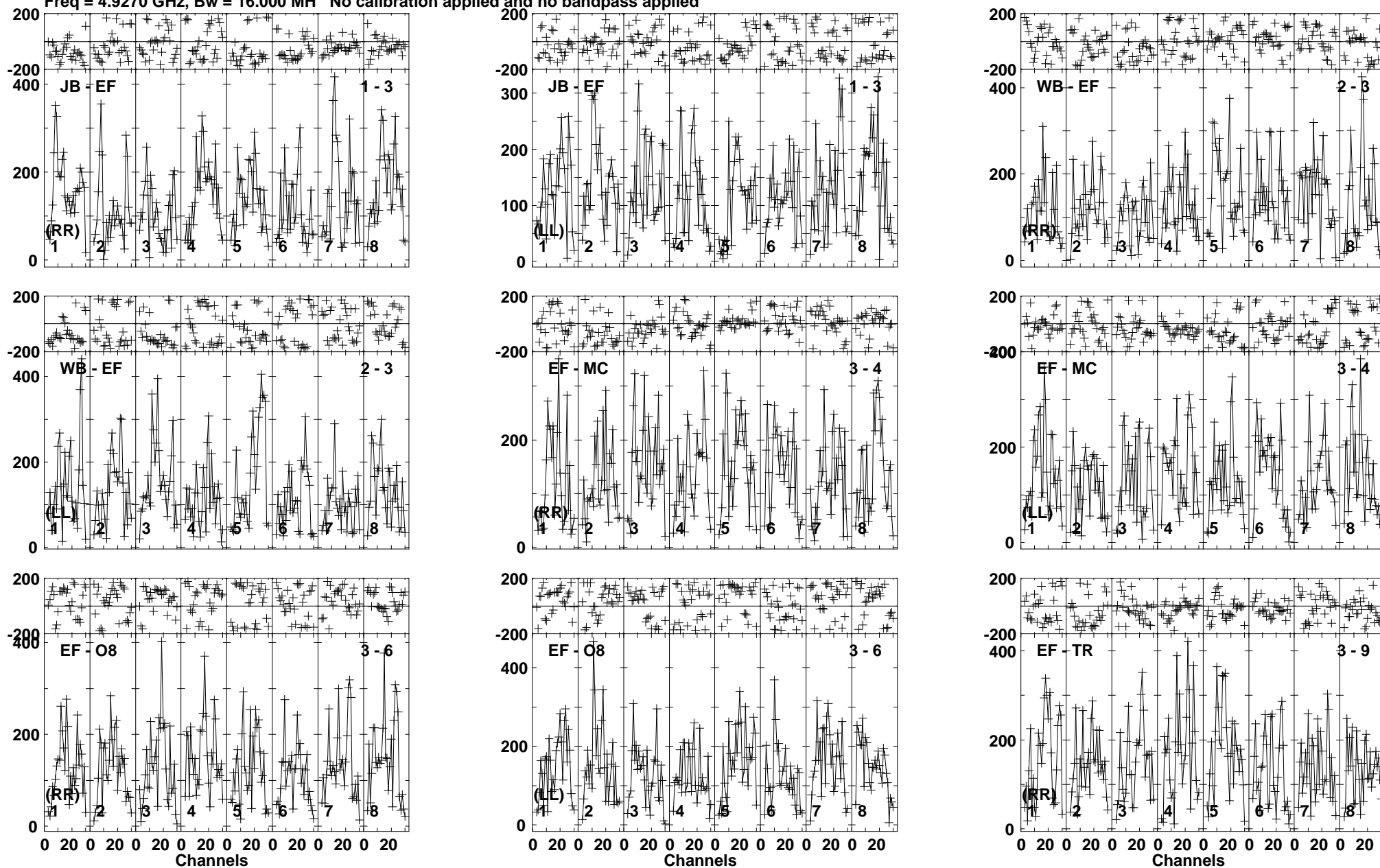

Lower frame: Micro Ampl Jy Top frame: Phas deg  
Vector averaged cross-power spectrum Baseline: JB (01) - EF (03)  
Timerange: 00/10:02:01 to 00/10:03:59

Plot file version 197 created 19-DEC-2018 17:58:25

AT2018\_RY007C.UVDATA.1

Freq = 4.9270 GHz, Bw = 16.000 MH No calibration applied and no bandpass applied

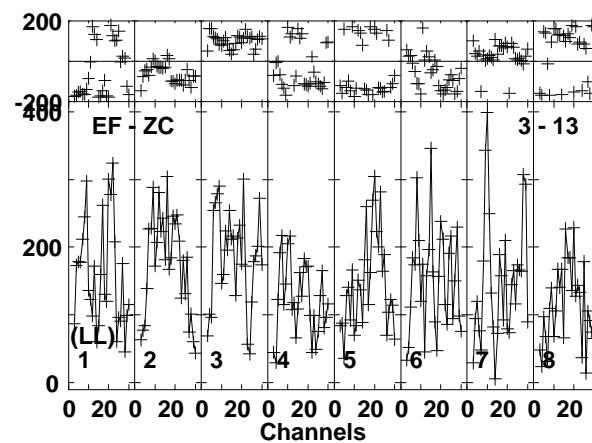
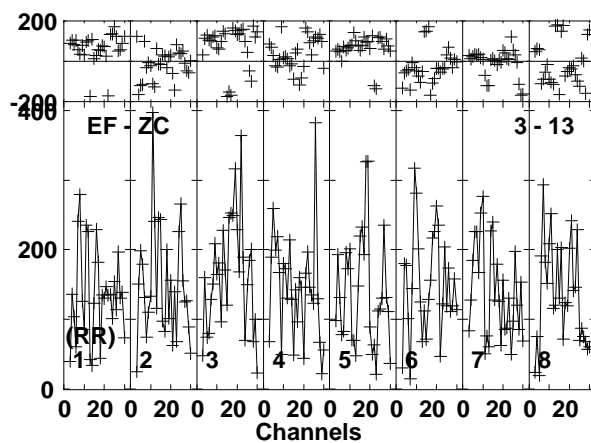
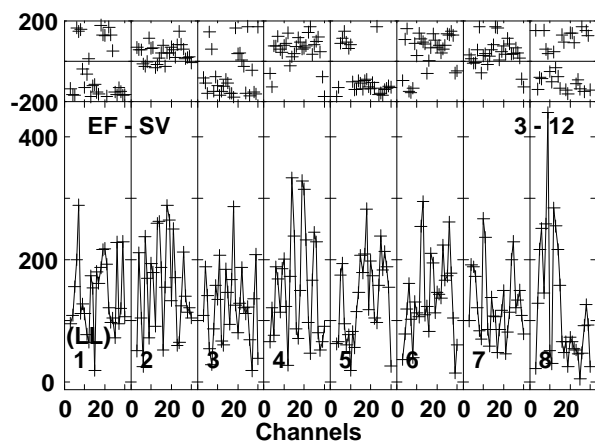
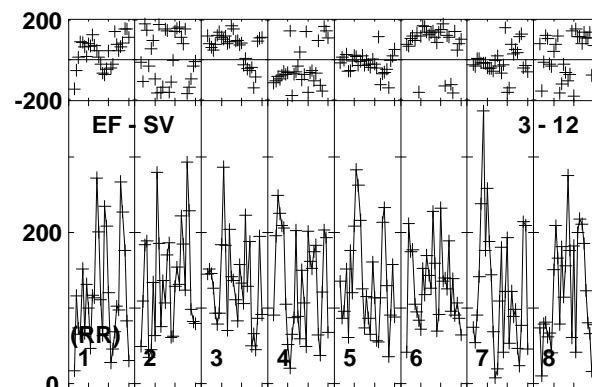
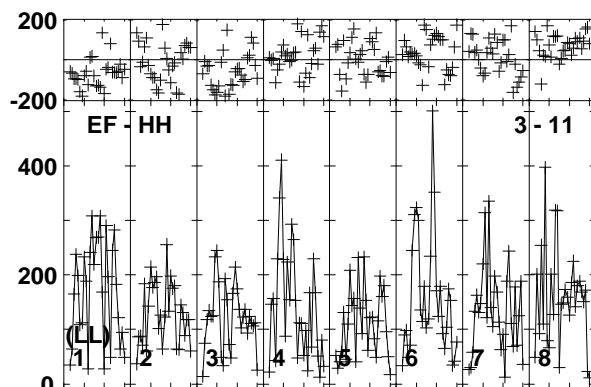
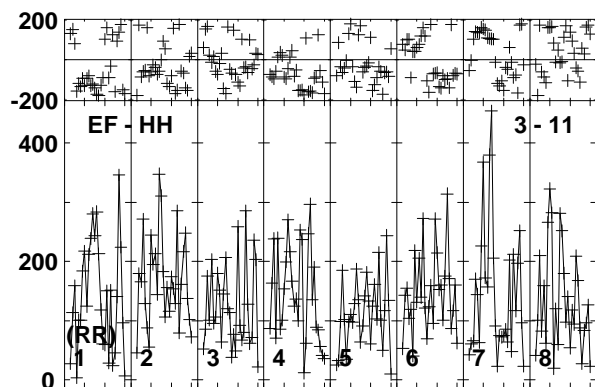
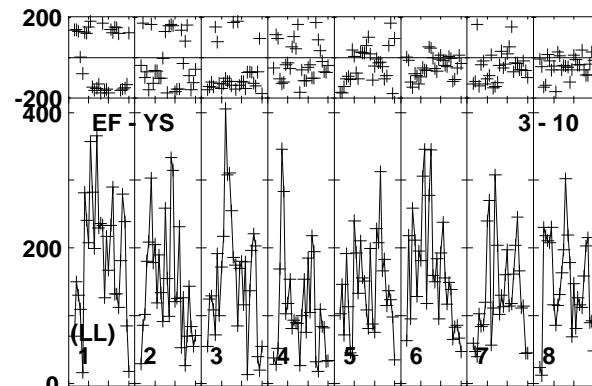
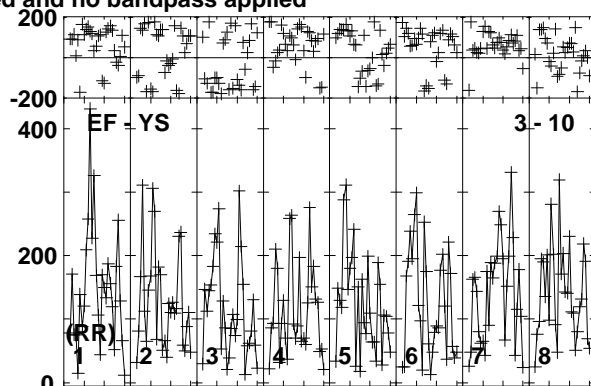
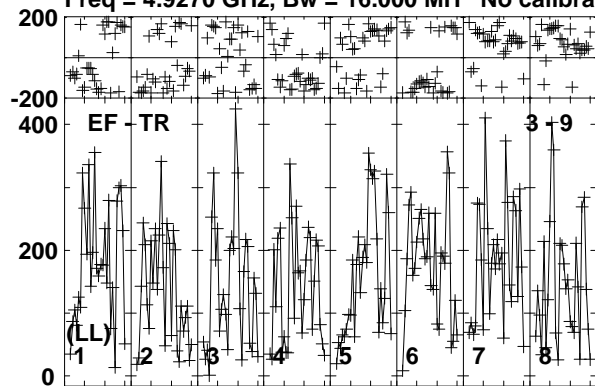

Lower frame: Micro Ampl Jy Top frame: Phas deg  
Vector averaged cross-power spectrum Baseline: EF (03) - TR (09)  
Timerange: 00/10:02:01 to 00/10:03:59

Plot file version 198 created 19-DEC-2018 17:58:25

AT2018\_RY007C.UVDATA.1

Freq = 4.9270 GHz, Bw = 16.000 MH No calibration applied and no bandpass applied

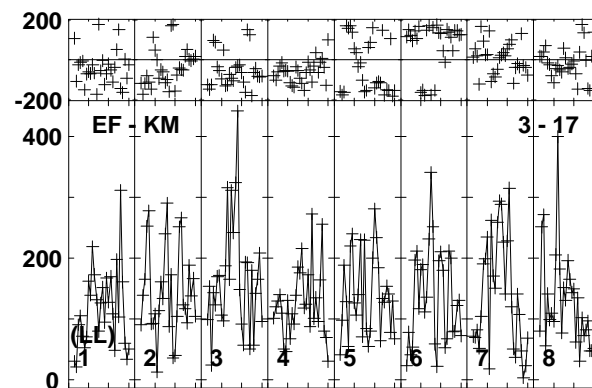
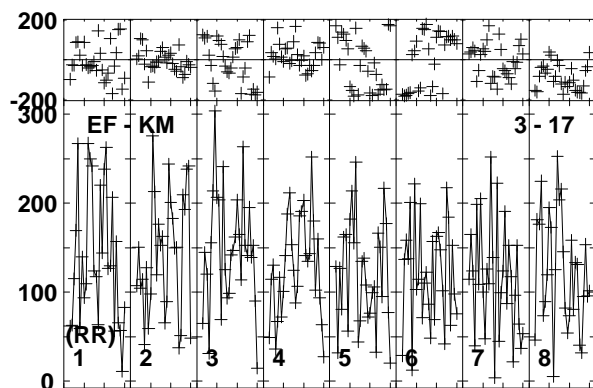
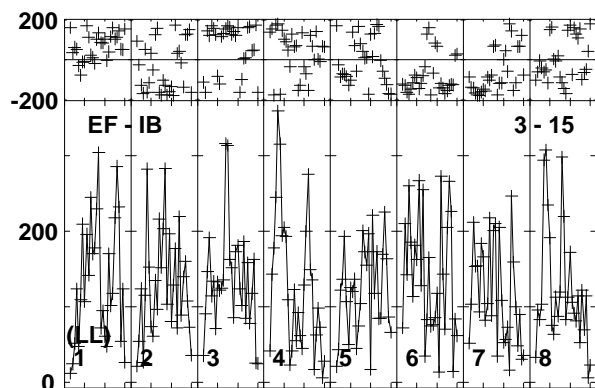
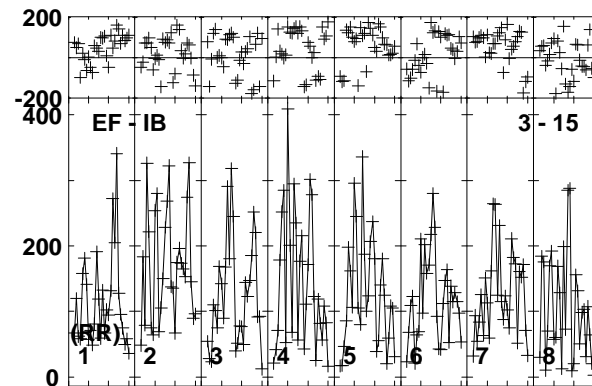
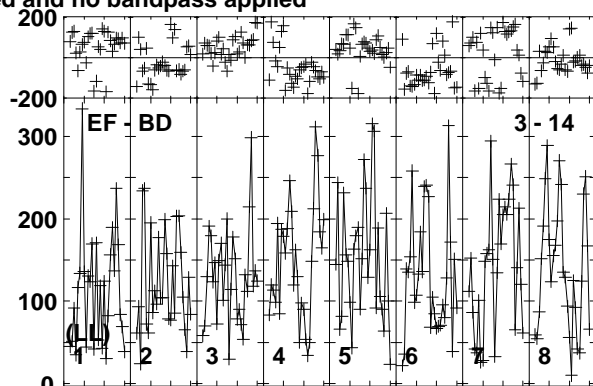
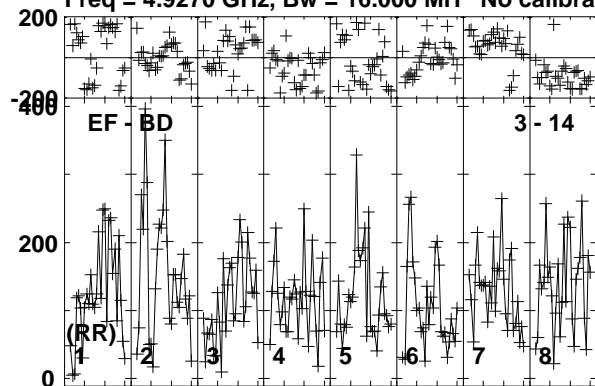

Lower frame: Micro Ampl Jy Top frame: Phas deg  
Vector averaged cross-power spectrum Baseline: EF (03) - BD (14)  
Timerange: 00/10:02:01 to 00/10:03:59

Plot file version 199 created 19-DEC-2018 17:58:25

VLA2 RY007C.UVDATA.1

Freq = 4.9270 GHz, Bw = 16.000 MH No calibration applied and no bandpass applied

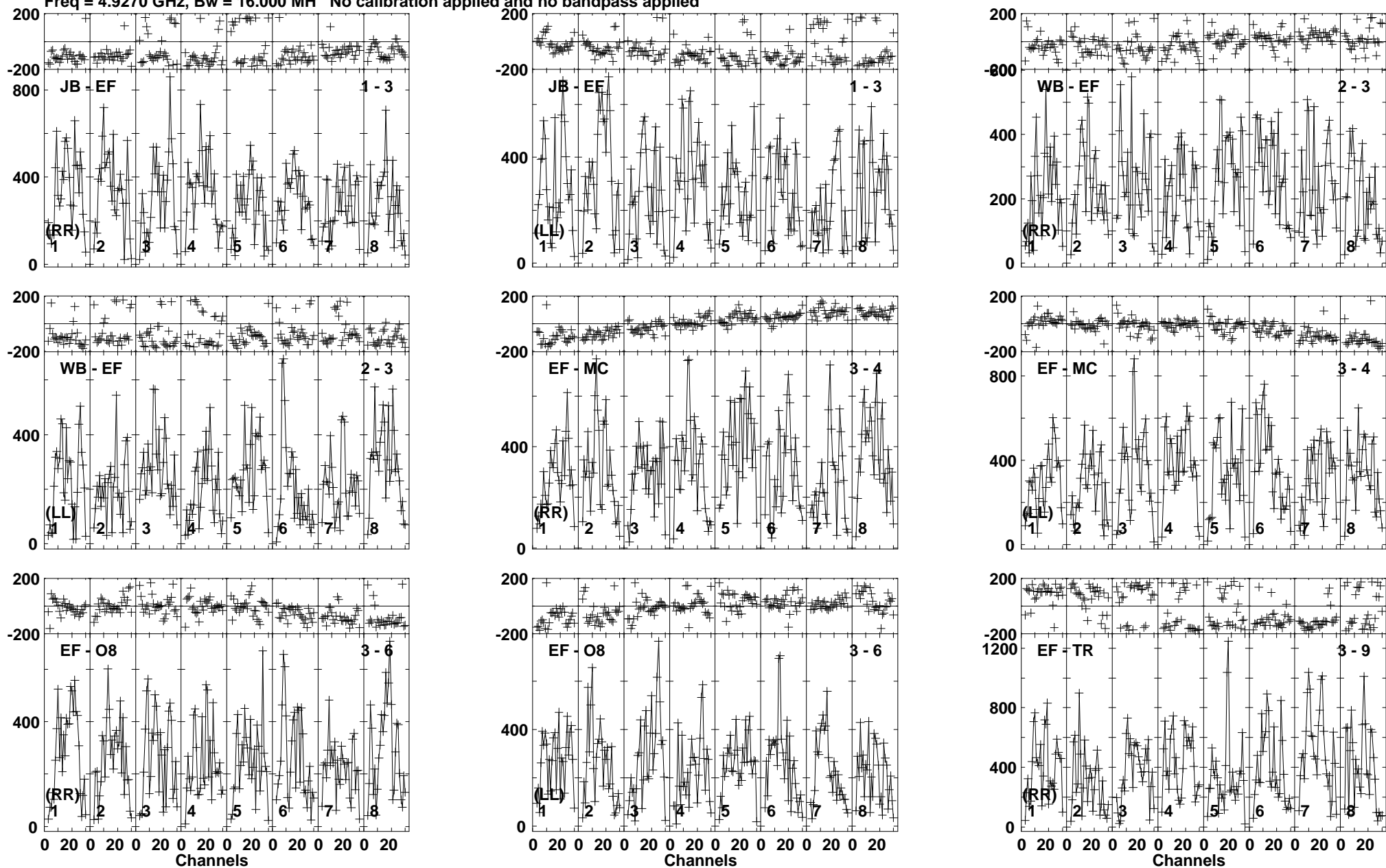

Lower frame: Micro Ampl Jy Top frame: Phas deg  
Vector averaged cross-power spectrum Baseline: JB (01) - EF (03)  
Timerange: 00/10/04:01 to 00/10/04:59

Plot file version 200 created 19-DEC-2018 17:58:25

VLA2 RY007C.UVDATA.1

Freq = 4.9270 GHz, Bw = 16.000 MH No calibration applied and no bandpass applied

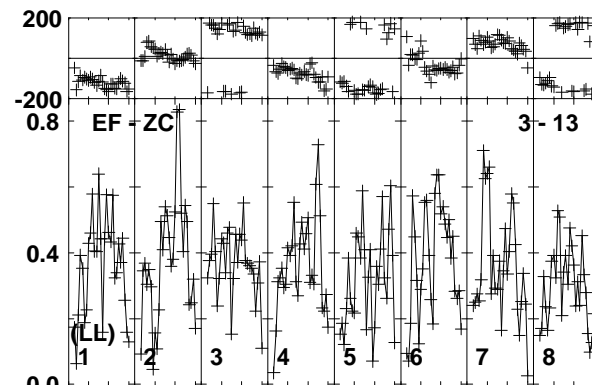
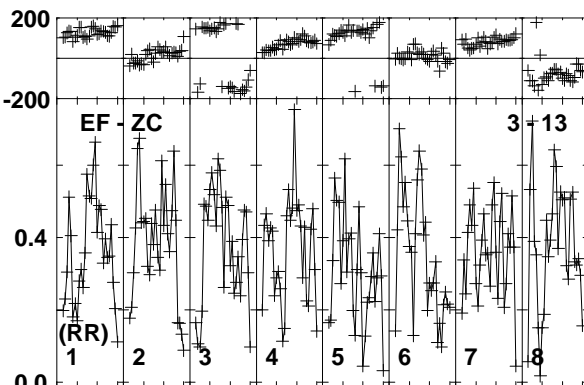
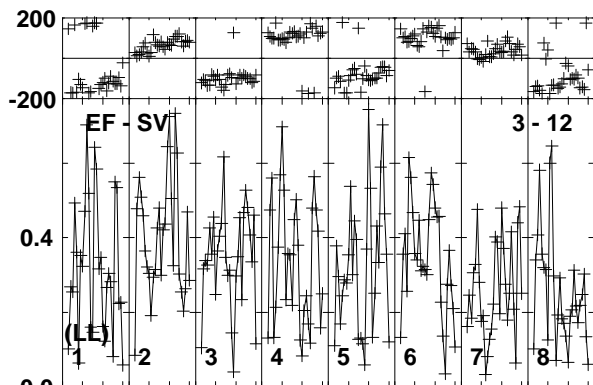
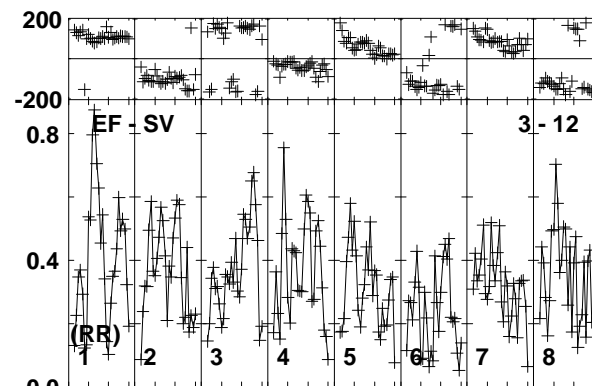
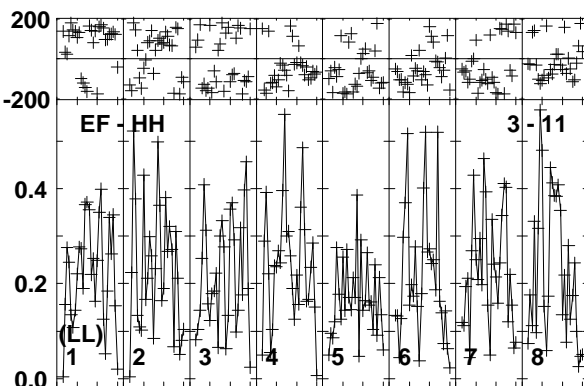
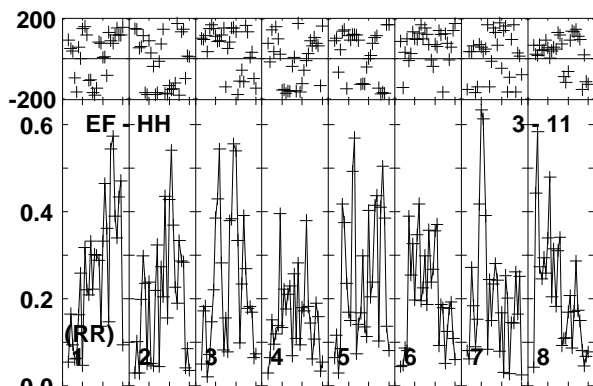
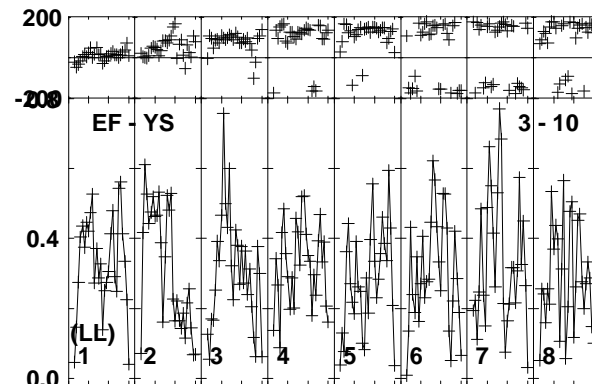
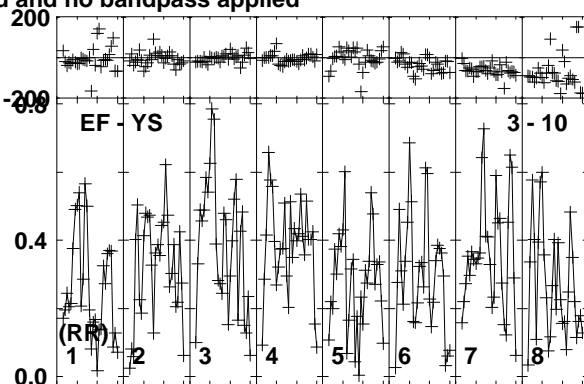
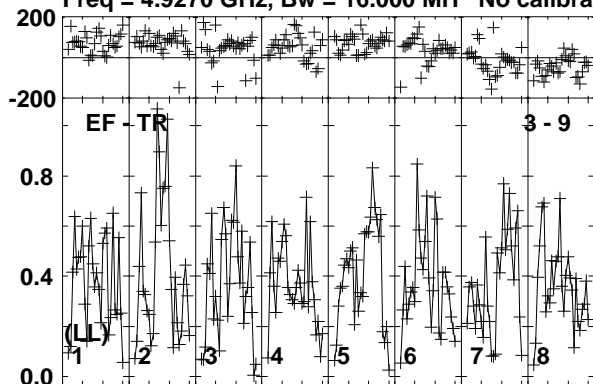

Lower frame: Milli Ampl Jy Top frame: Phas deg  
Vector averaged cross-power spectrum Baseline: EF (03) - TR (09)  
Timerange: 00/10:04:01 to 00/10:04:59

Plot file version 201 created 19-DEC-2018 17:58:25

VLA2 RY007C.UVDATA.1

Freq = 4.9270 GHz, Bw = 16.000 MH No calibration applied and no bandpass applied

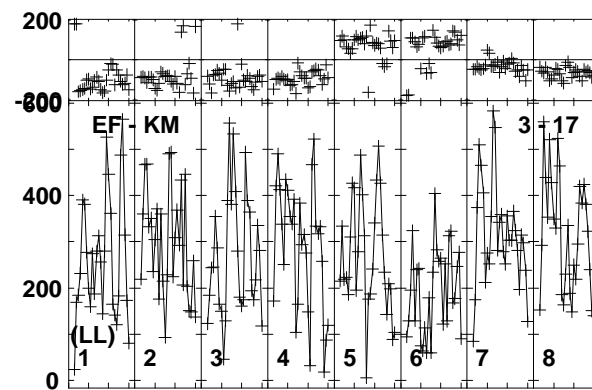
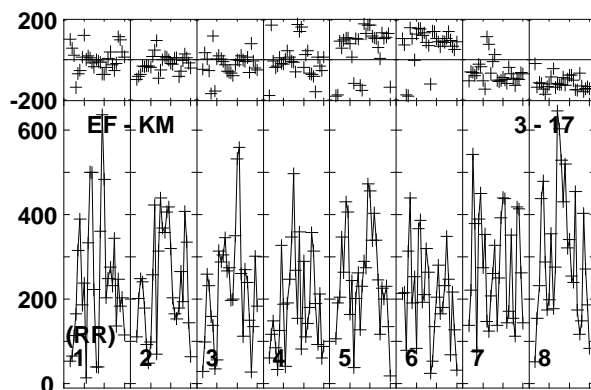
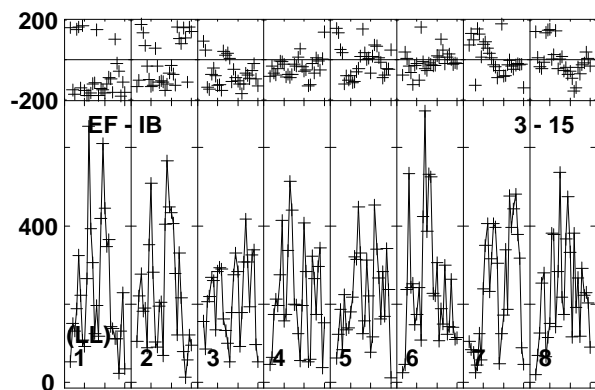
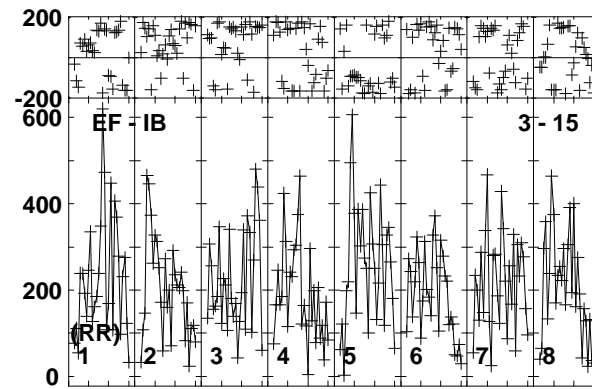
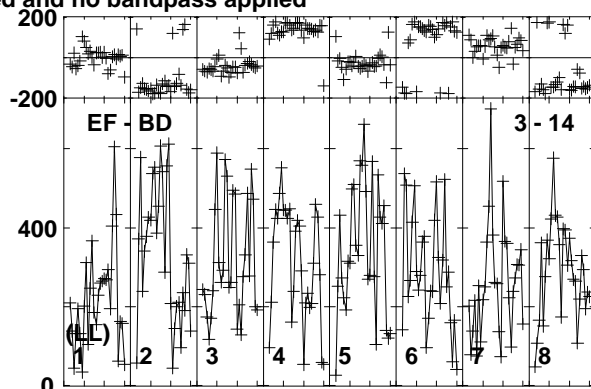
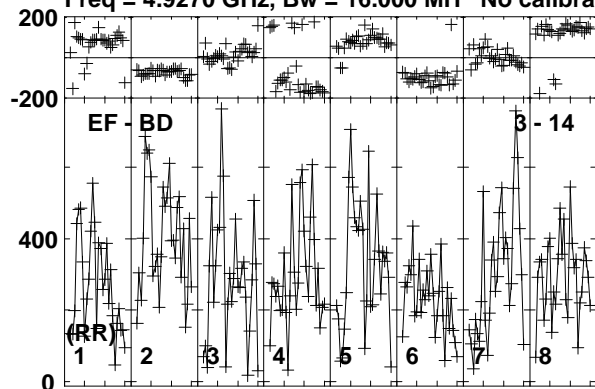

Lower frame: Micro Ampl Jy Top frame: Phas deg  
Vector averaged cross-power spectrum Baseline: EF (03) - BD (14)  
Timerange: 00/10:04:01 to 00/10:04:59

Plot file version 202 created 19-DEC-2018 17:58:25

J1619+2247 RY007C.UVDATA.1

Freq = 4.9270 GHz, Bw = 16.000 MH No calibration applied and no bandpass applied

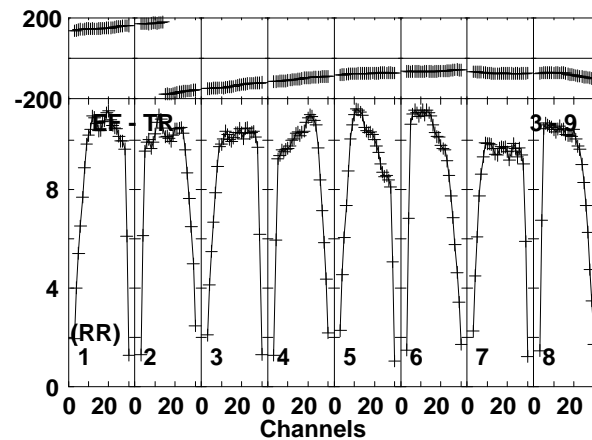
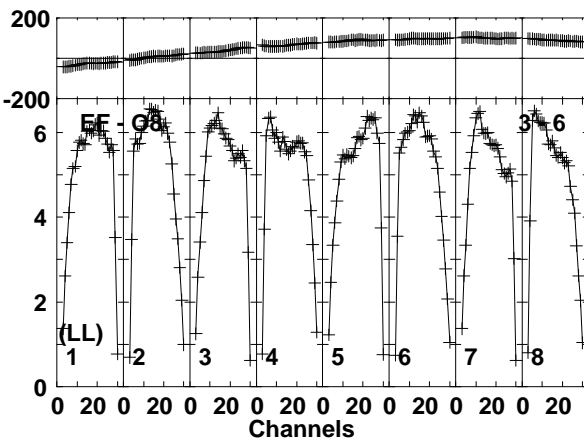
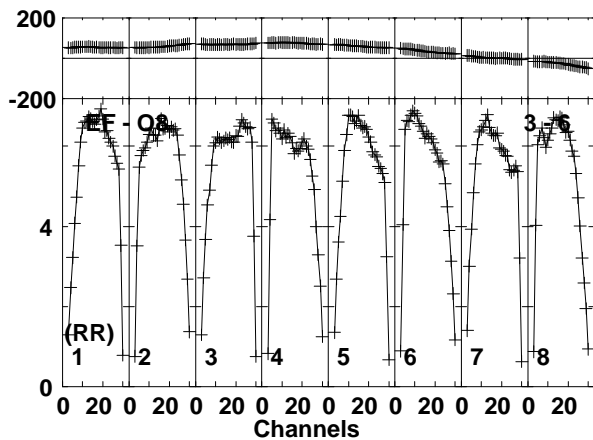
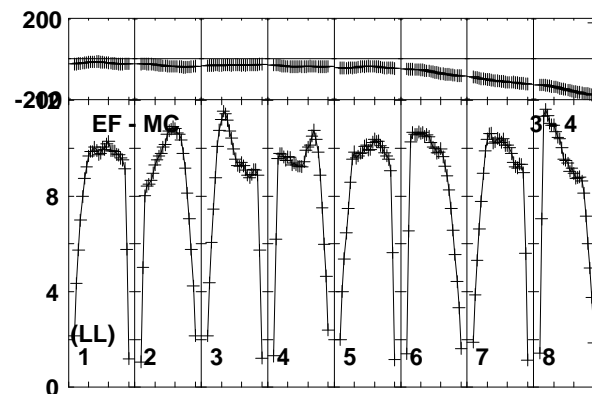
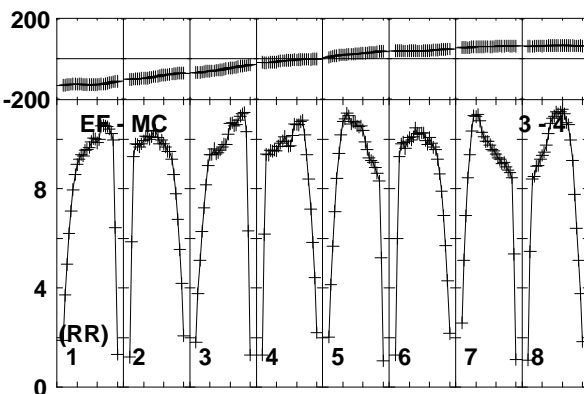
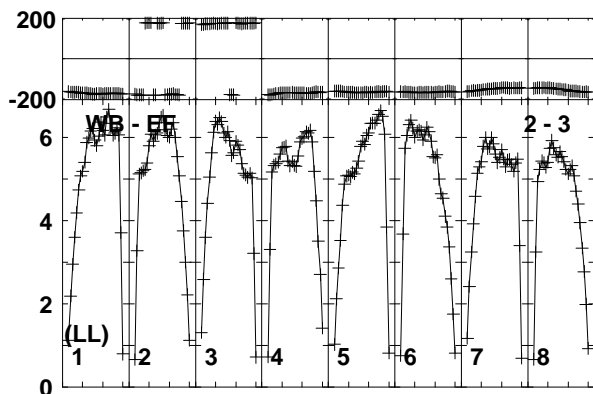
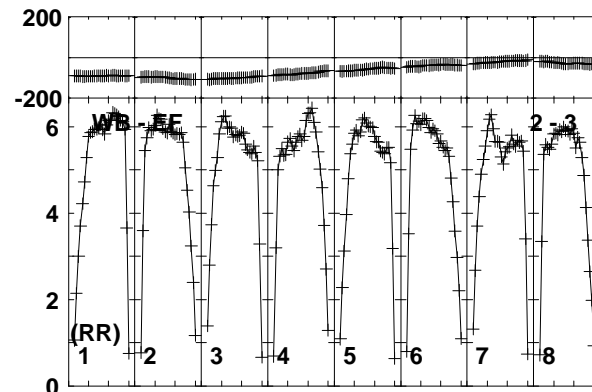
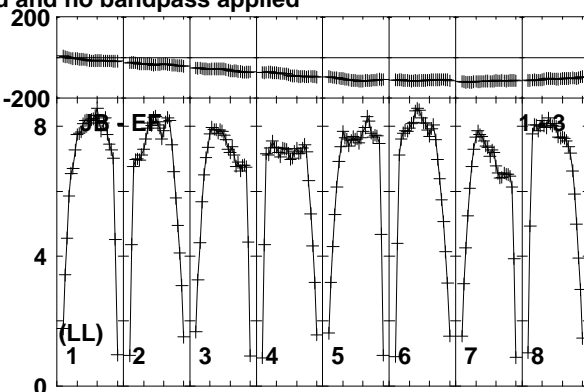
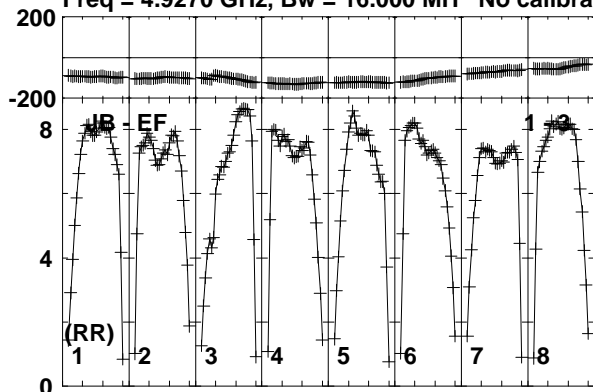

Lower frame: Milli Ampl Jy Top frame: Phas deg  
Vector averaged cross-power spectrum Baseline: JB (01) - EF (03)  
Timerange: 00/10/05:31 to 00/10/06:29



Plot file version 203 created 19-DEC-2018 17:58:25

J1619+2247 RY007C.UVDATA.1

Freq = 4.9270 GHz, Bw = 16.000 MH No calibration applied and no bandpass applied

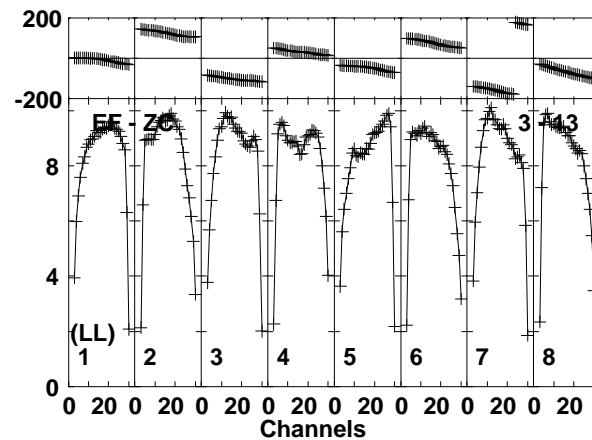
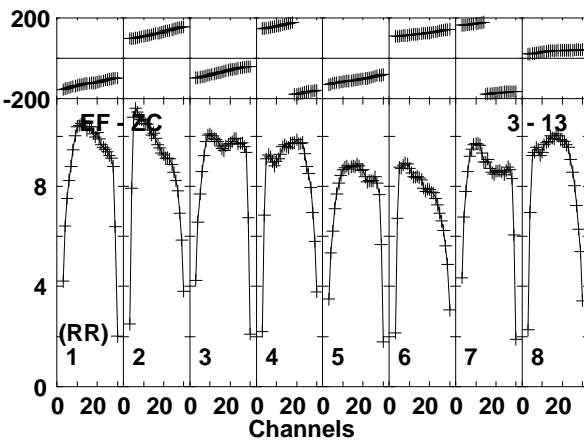
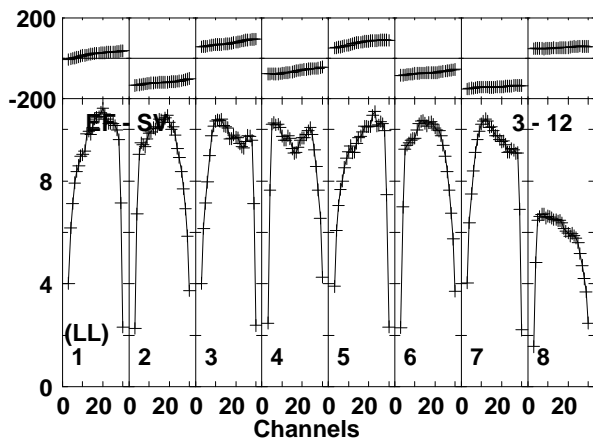
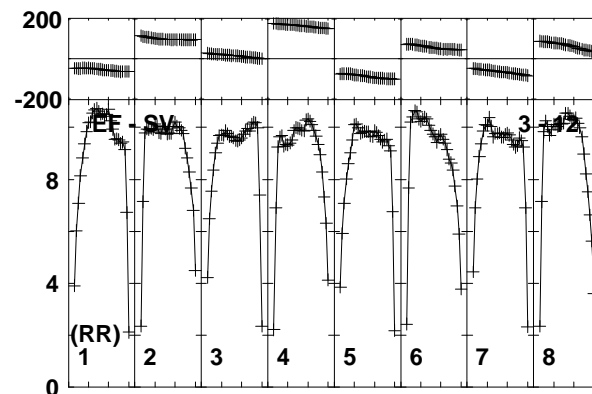
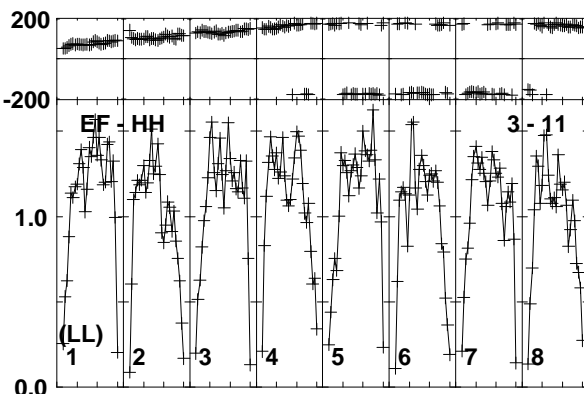
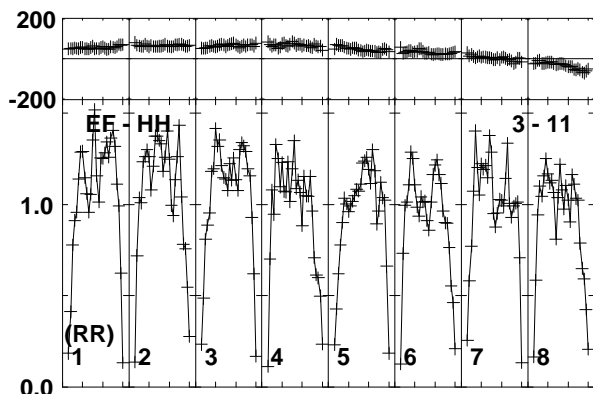
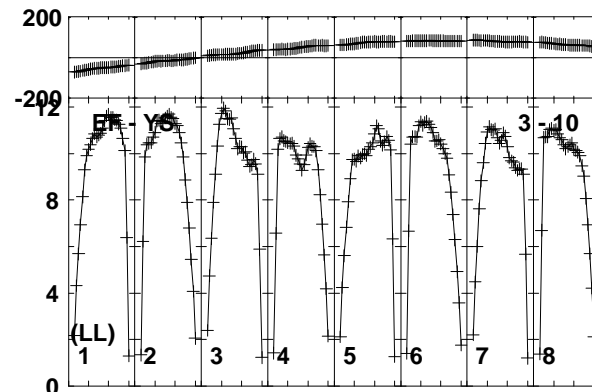
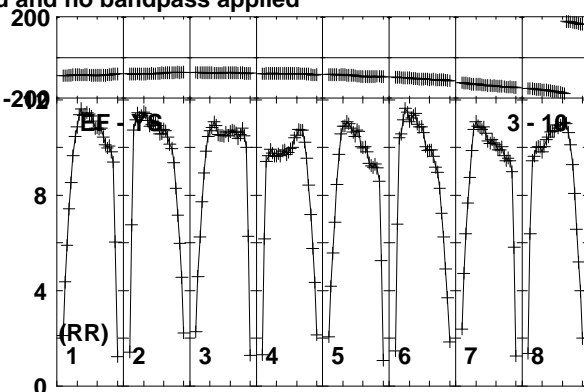
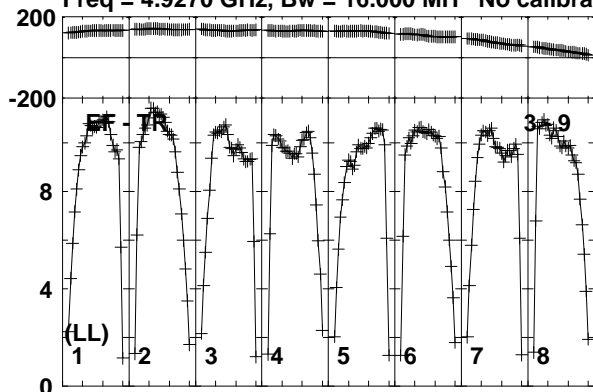

Lower frame: Milli Ampl Jy Top frame: Phas deg  
Vector averaged cross-power spectrum Baseline: EF (03) - TR (09)  
Timerange: 00/10:05:31 to 00/10:06:29

Plot file version 204 created 19-DEC-2018 17:58:25

J1619+2247 RY007C.UVDATA.1

Freq = 4.9270 GHz, Bw = 16.000 MH No calibration applied and no bandpass applied

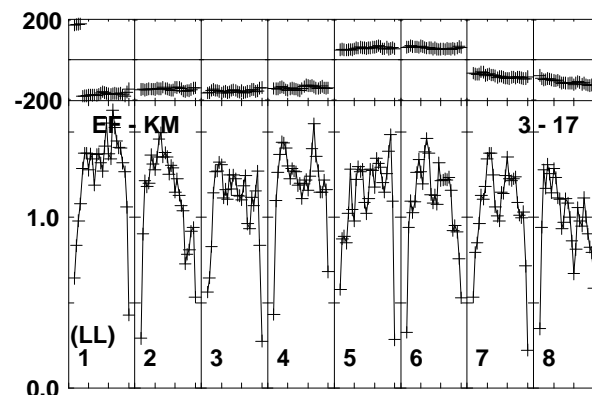
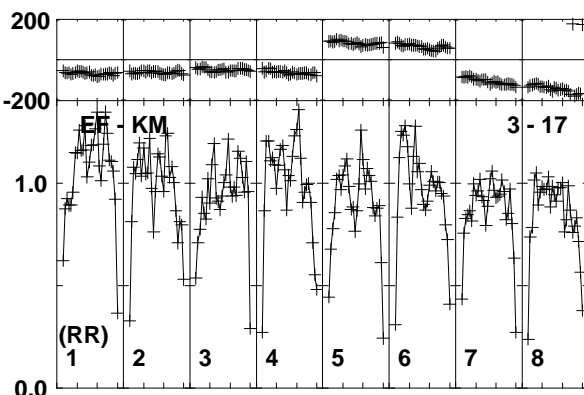
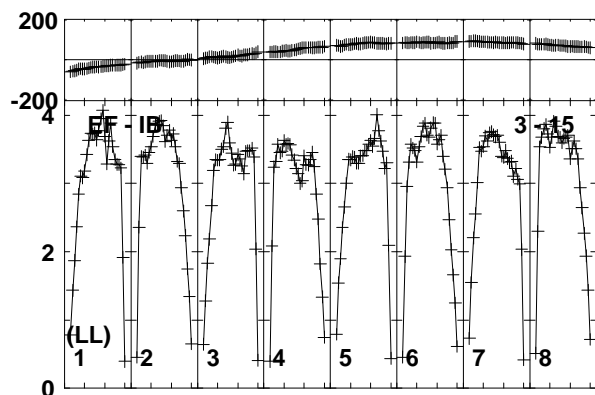
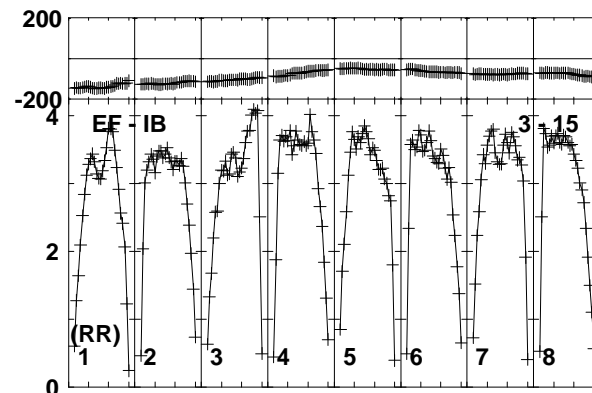
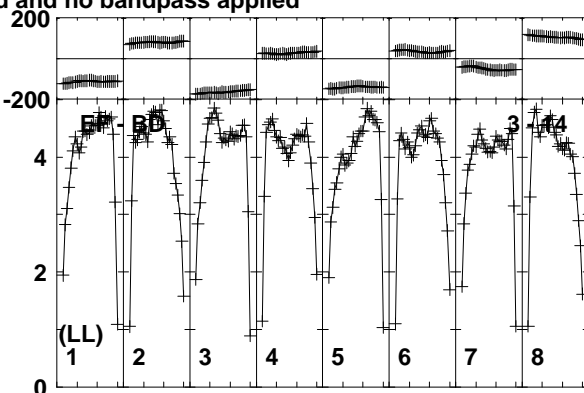
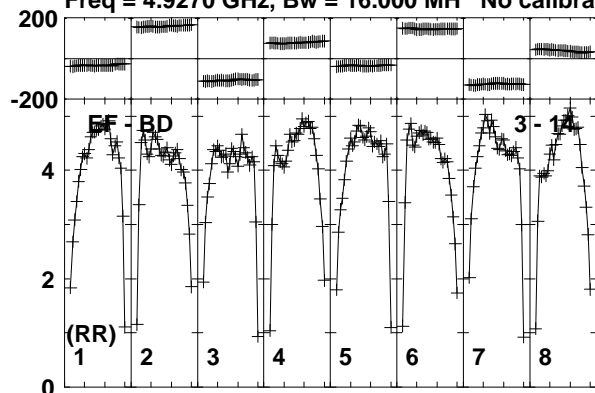

Lower frame: Milli Ampl Jy Top frame: Phas deg  
Vector averaged cross-power spectrum Baseline: EF (03) - BD (14)  
Timerange: 00/10:05:31 to 00/10:06:29

Plot file version 205 created 19-DEC-2018 17:58:25

AT2018\_RY007C.UVDATA.1

Freq = 4.9270 GHz, Bw = 16.000 MH No calibration applied and no bandpass applied

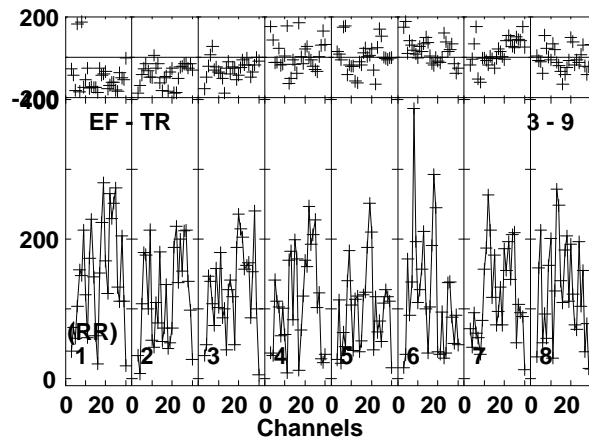
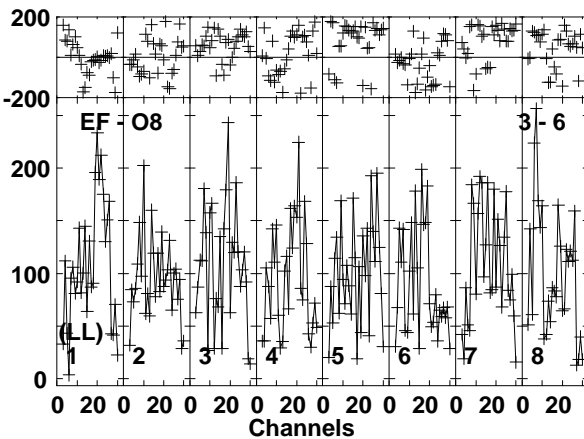
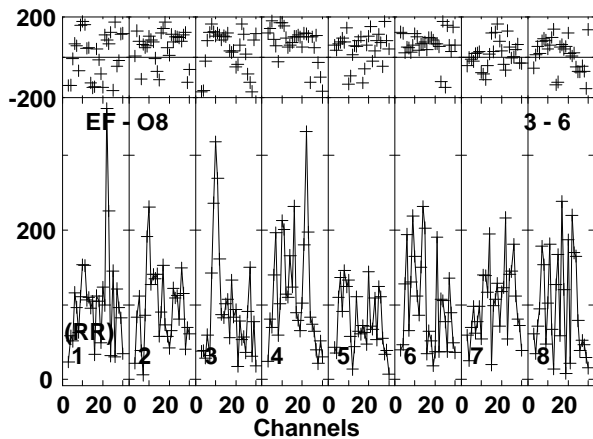
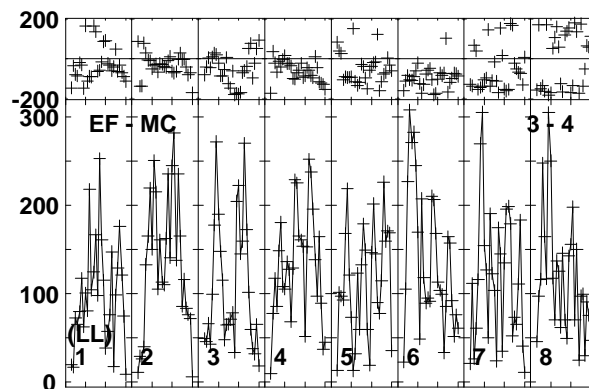
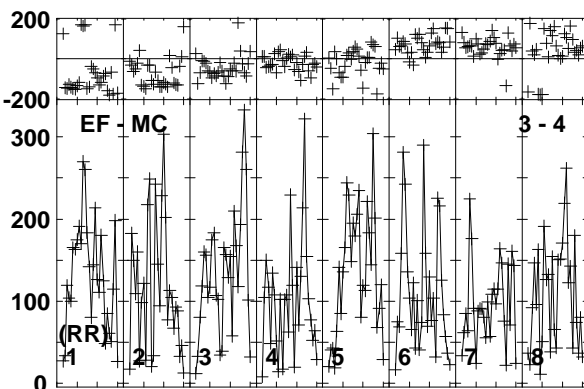
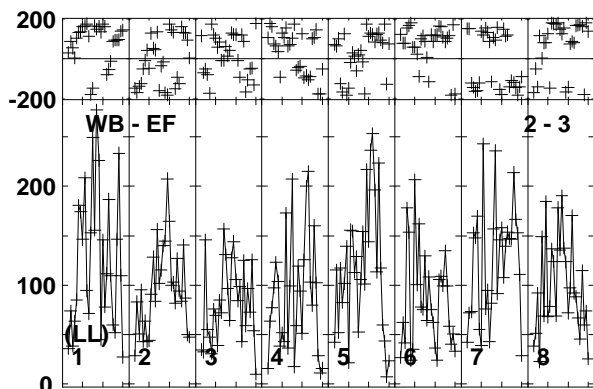
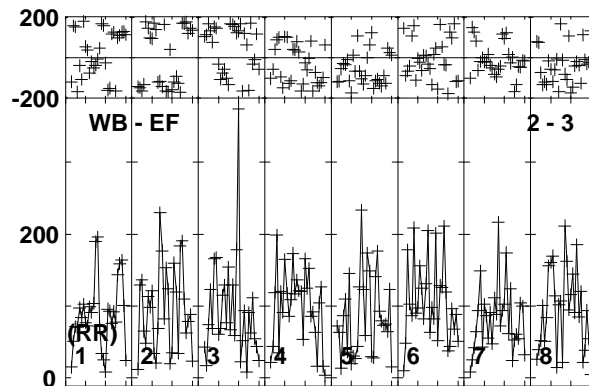
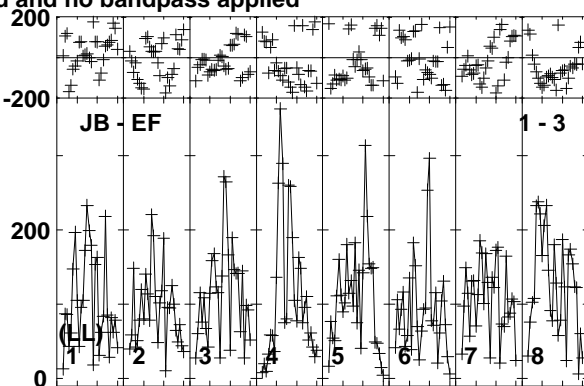
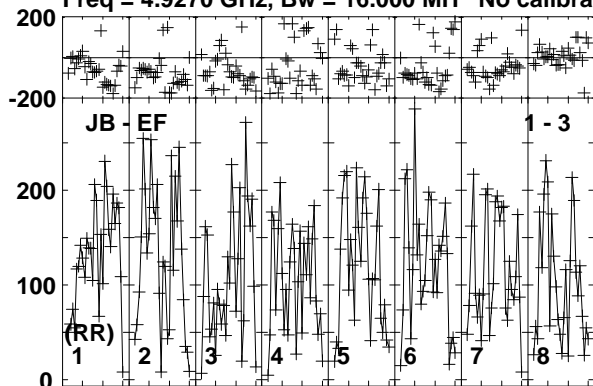

Lower frame: Micro Ampl Jy Top frame: Phas deg  
Vector averaged cross-power spectrum Baseline: JB (01) - EF (03)  
Timerange: 00/10/06:31 to 00/10/09:29

Plot file version 206 created 19-DEC-2018 17:58:25

AT2018\_RY007C.UVDATA.1

Freq = 4.9270 GHz, Bw = 16.000 MH No calibration applied and no bandpass applied

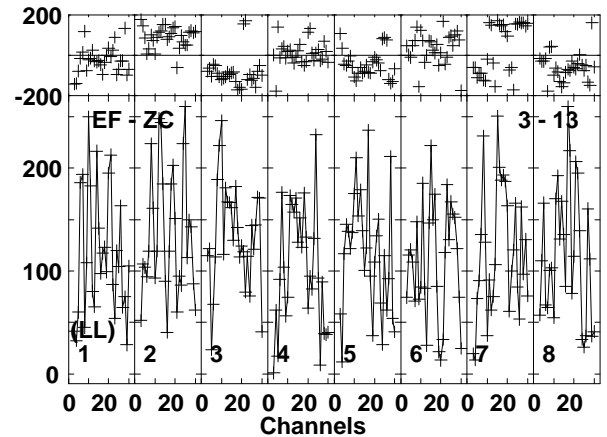
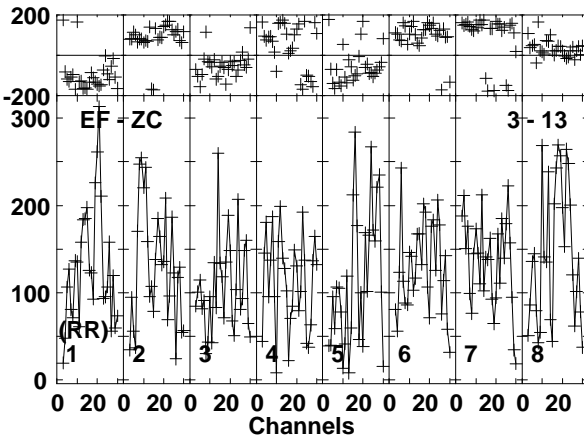
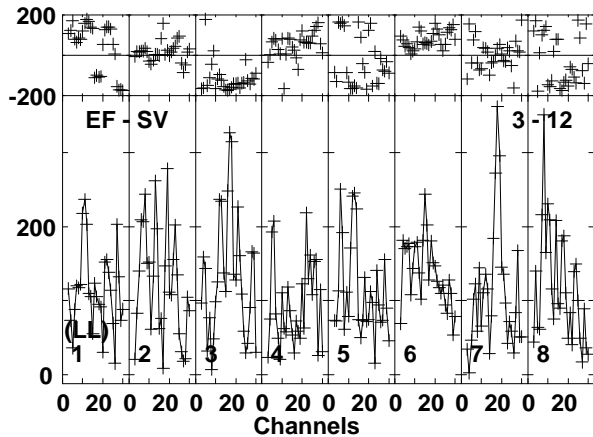
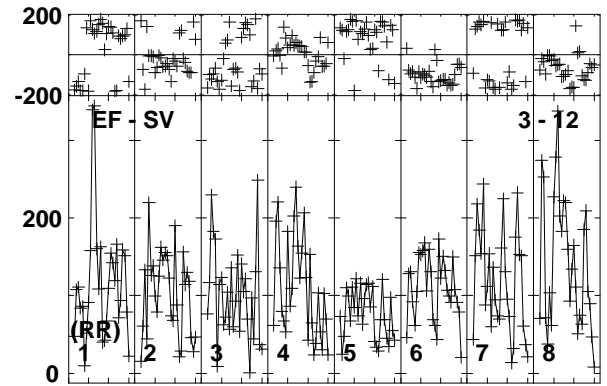
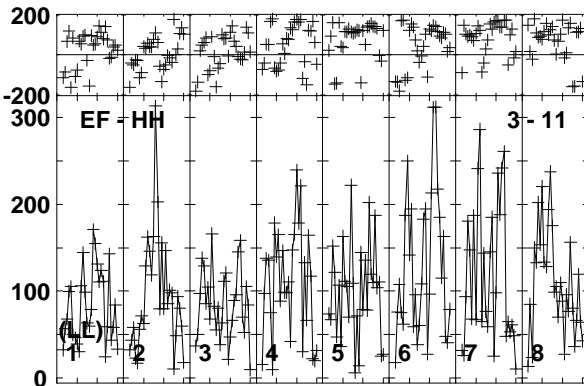
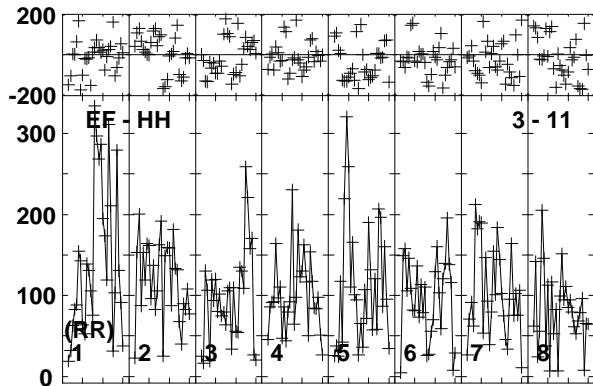
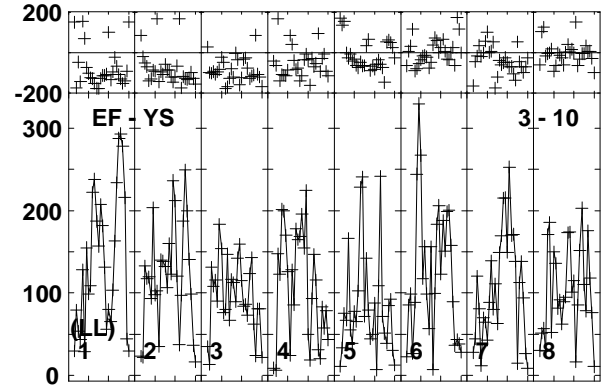
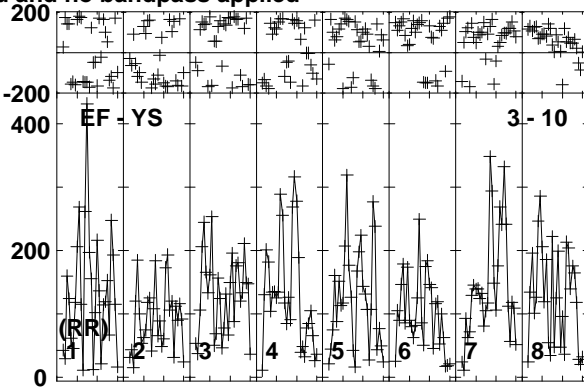
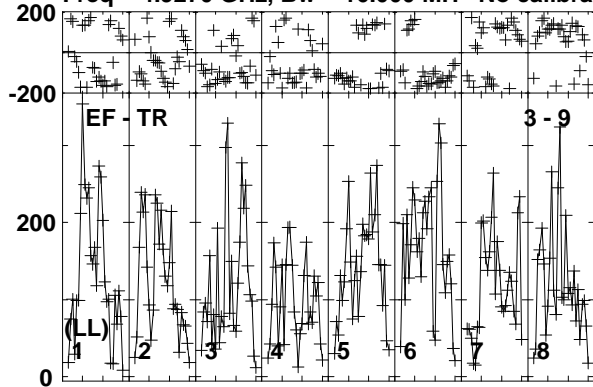

Lower frame: Micro Ampl Jy Top frame: Phas deg  
Vector averaged cross-power spectrum Baseline: EF (03) - TR (09)  
Timerange: 00/10:06:31 to 00/10:09:29

Plot file version 207 created 19-DEC-2018 17:58:25

AT2018\_RY007C.UVDATA.1

Freq = 4.9270 GHz, Bw = 16.000 MH No calibration applied and no bandpass applied

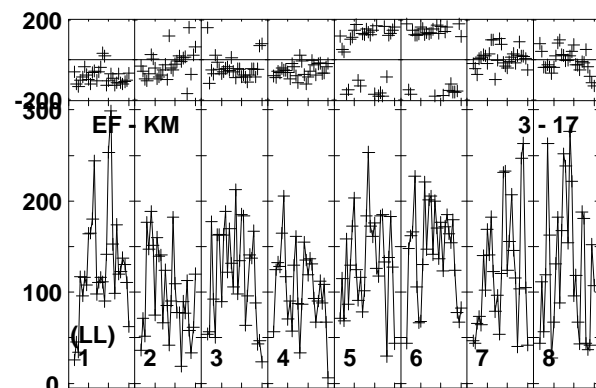
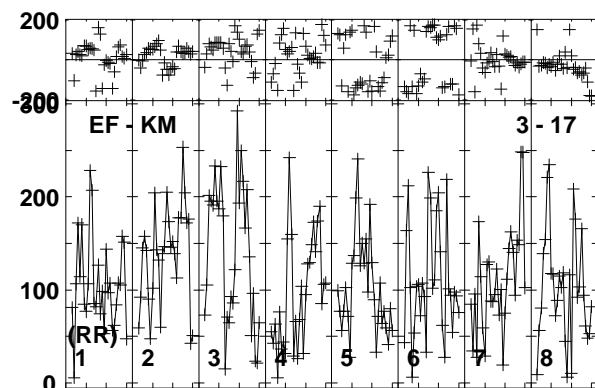
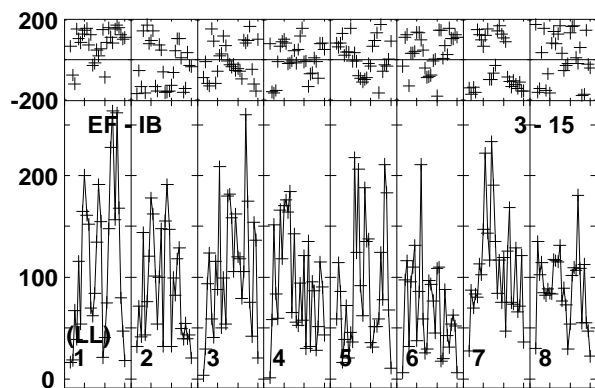
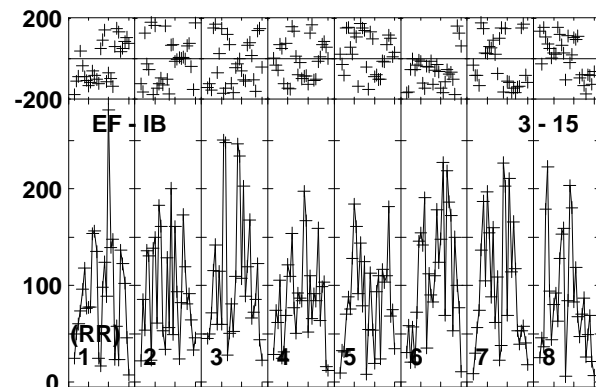
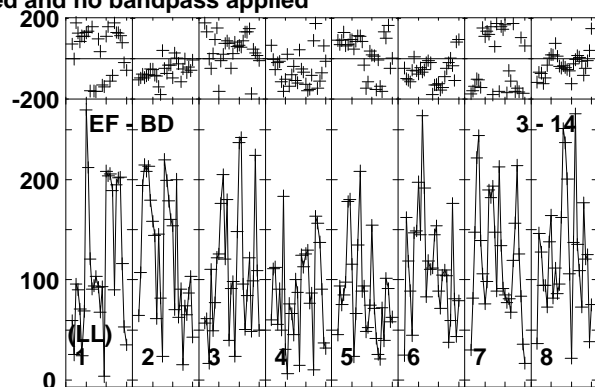
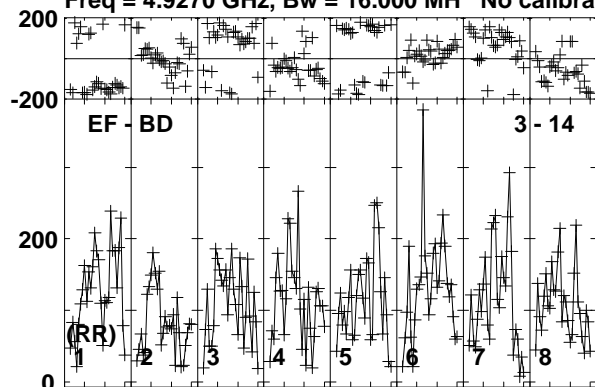

Lower frame: Micro Ampl Jy Top frame: Phas deg  
Vector averaged cross-power spectrum Baseline: EF (03) - BD (14)  
Timerange: 00/10:06:31 to 00/10:09:29

Plot file version 208 created 19-DEC-2018 17:58:26

J1619+2247 RY007C.UVDATA.1

Freq = 4.9270 GHz, Bw = 16.000 MH No calibration applied and no bandpass applied

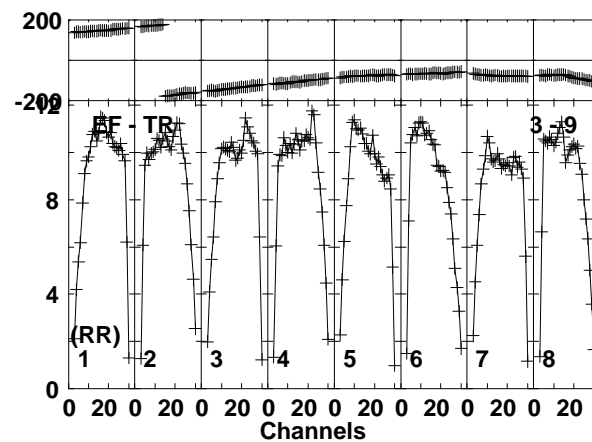
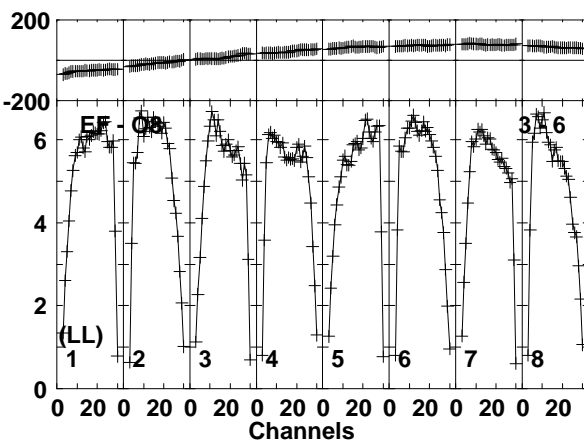
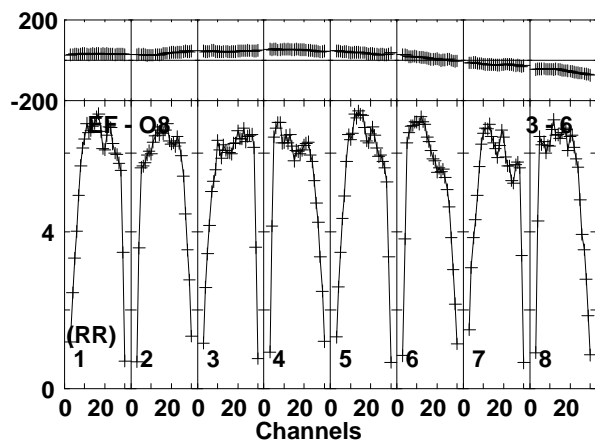
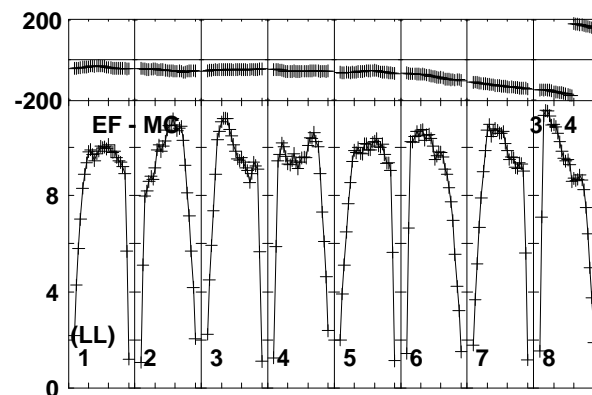
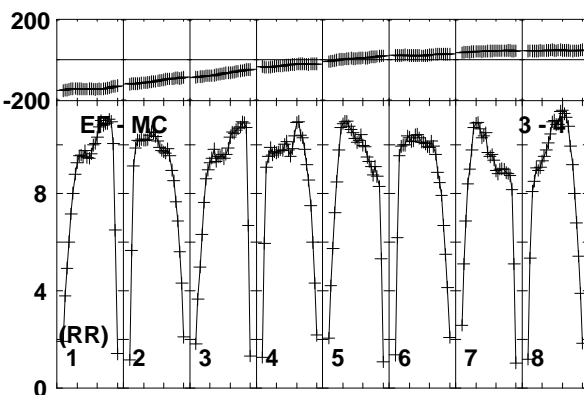
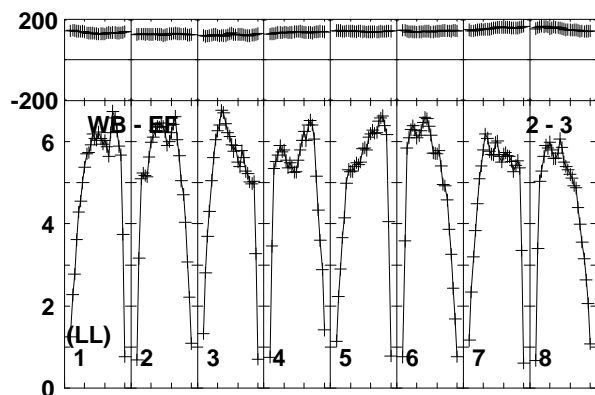
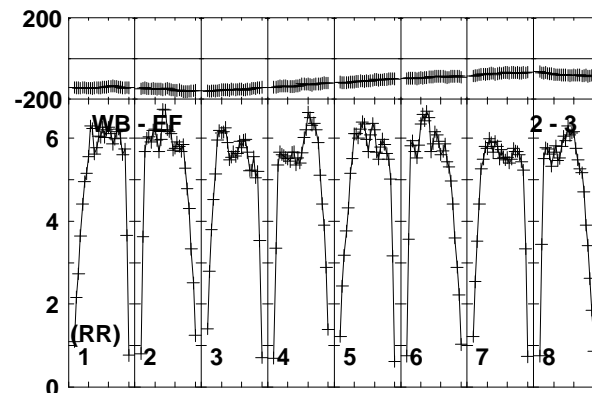
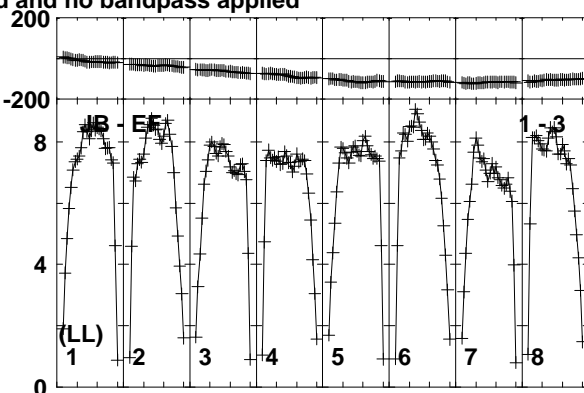
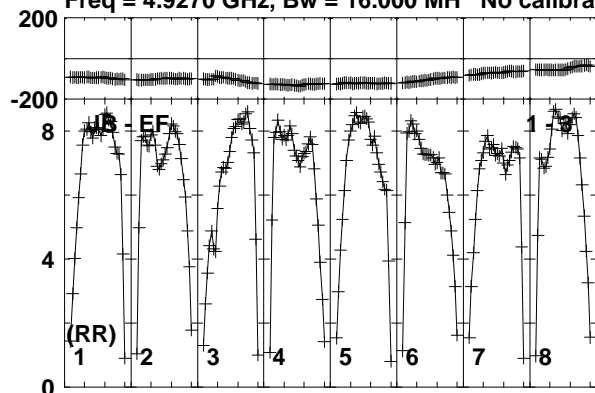

Lower frame: Milli Ampl Jy Top frame: Phas deg  
Vector averaged cross-power spectrum Baseline: JB (01) - EF (03)  
Timerange: 00/10/09:31 to 00/10/10:29

Plot file version 209 created 19-DEC-2018 17:58:26

J1619+2247 RY007C.UVDATA.1

Freq = 4.9270 GHz, Bw = 16.000 MH No calibration applied and no bandpass applied

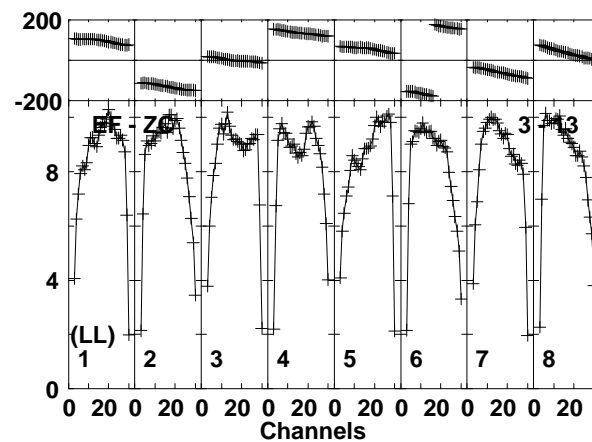
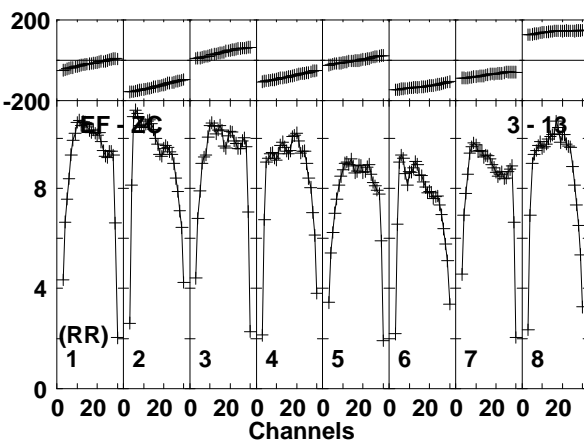
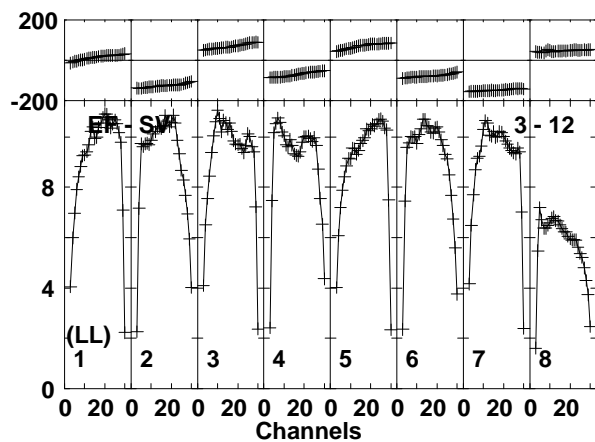
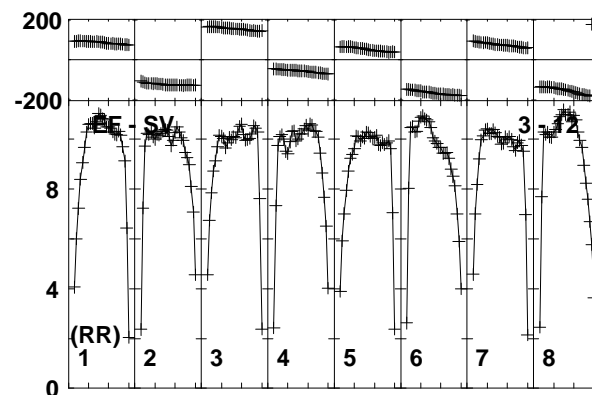
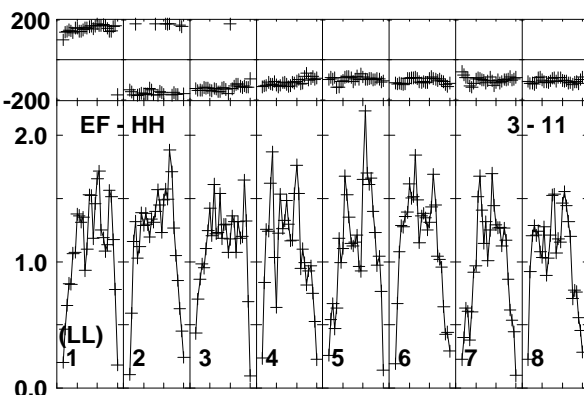
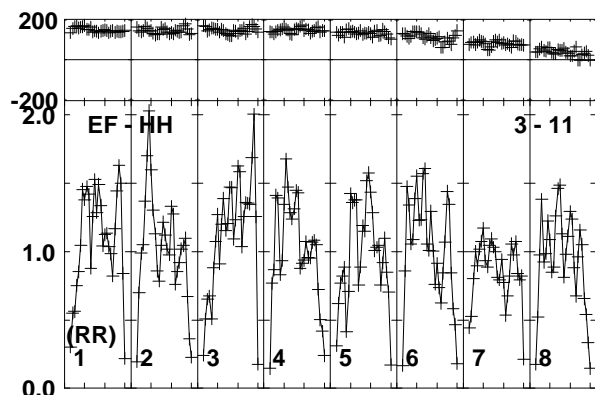
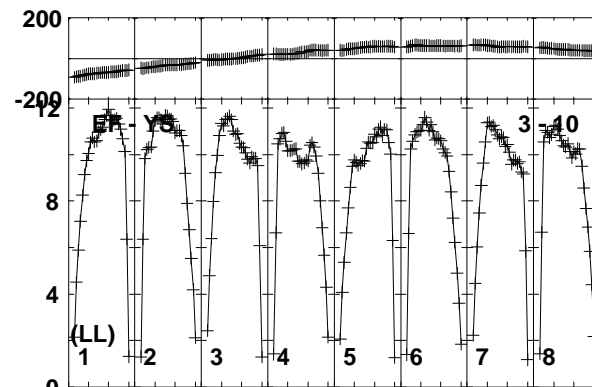
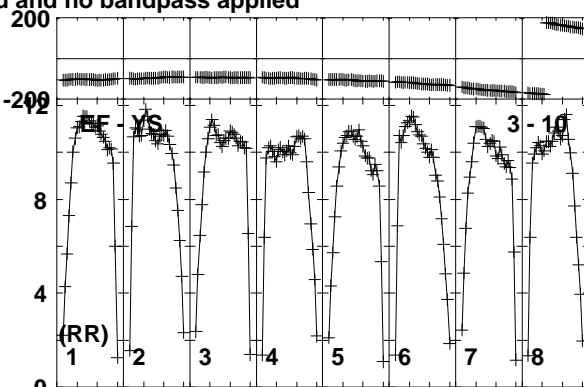
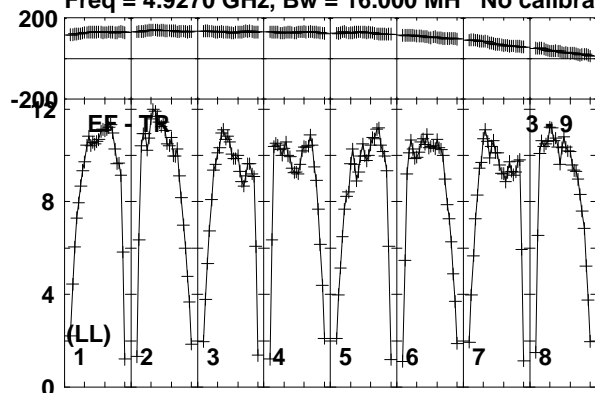

Lower frame: Milli Ampl Jy Top frame: Phas deg  
Vector averaged cross-power spectrum Baseline: EF (03) - TR (09)  
Timerange: 00/10/09:31 to 00/10/10:29

Plot file version 210 created 19-DEC-2018 17:58:26

J1619+2247 RY007C.UVDATA.1

Freq = 4.9270 GHz, Bw = 16.000 MH No calibration applied and no bandpass applied

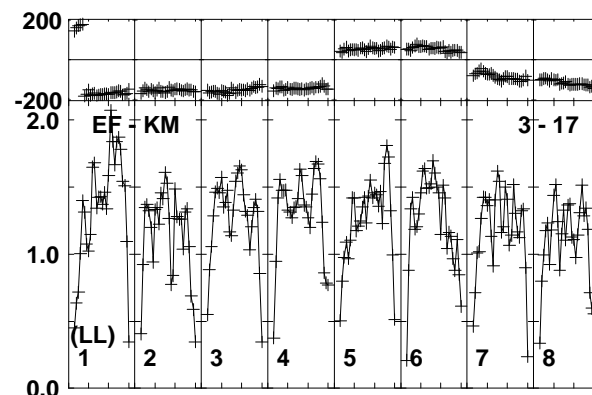
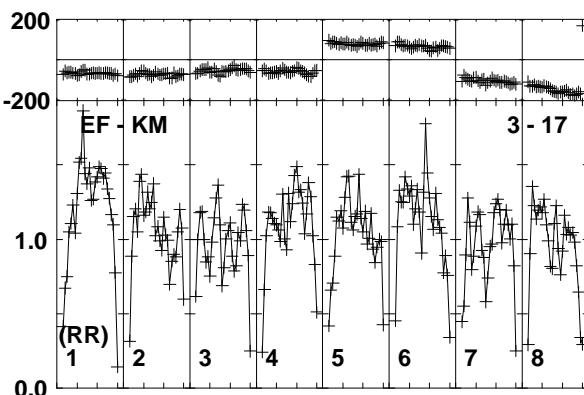
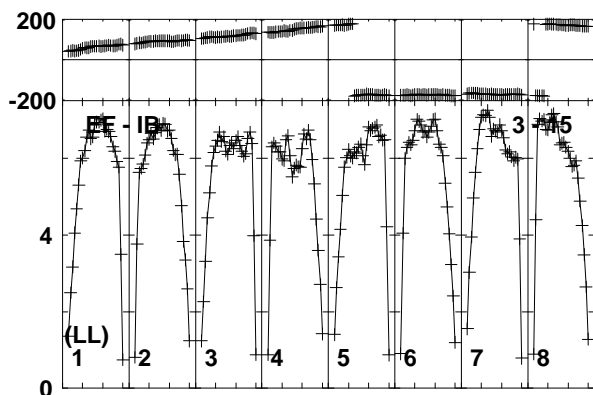
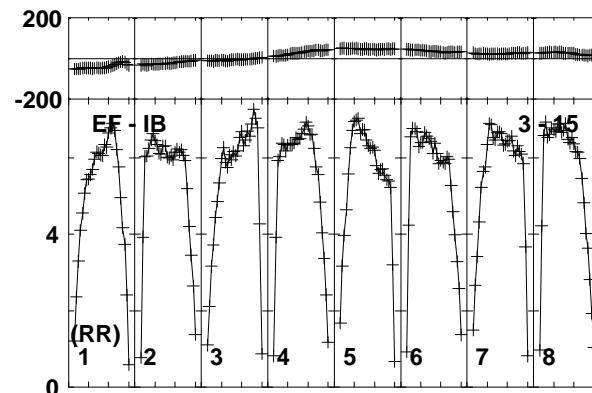
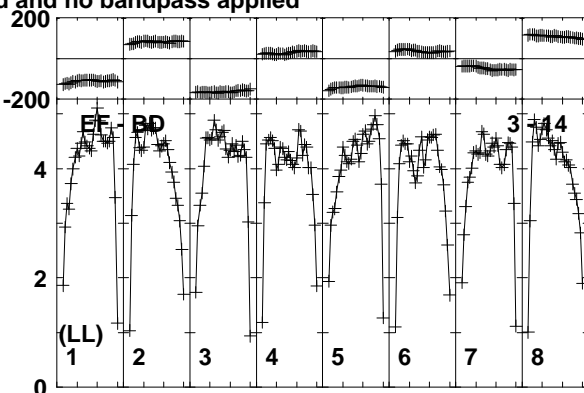
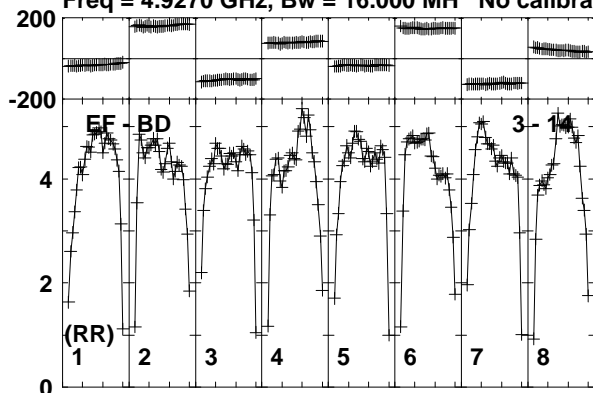

Lower frame: Milli Ampl Jy Top frame: Phas deg  
Vector averaged cross-power spectrum Baseline: EF (03) - BD (14)  
Timerange: 00/10:09:31 to 00/10:10:29



Plot file version 211 created 19-DEC-2018 17:58:26

AT2018\_RY007C.UVDATA.1

Freq = 4.9270 GHz, Bw = 16.000 MH No calibration applied and no bandpass applied

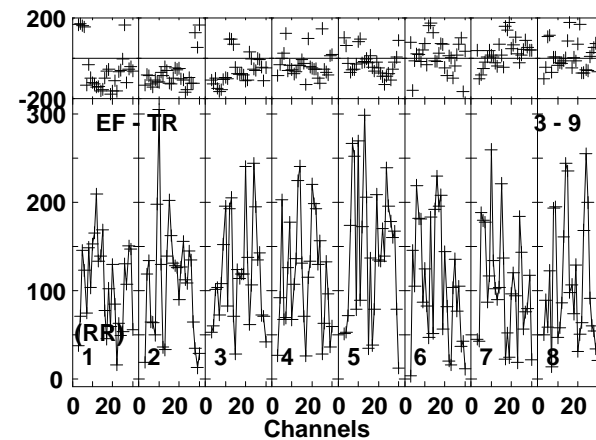
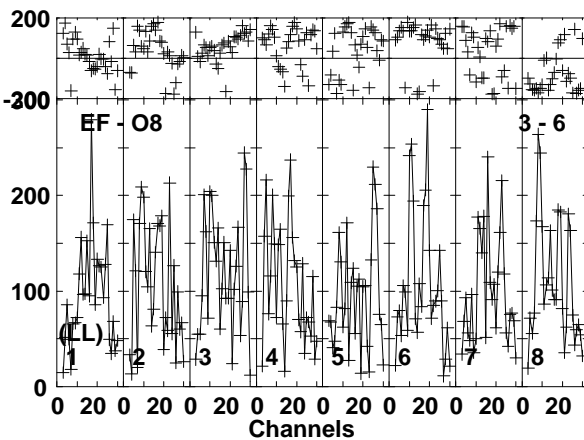
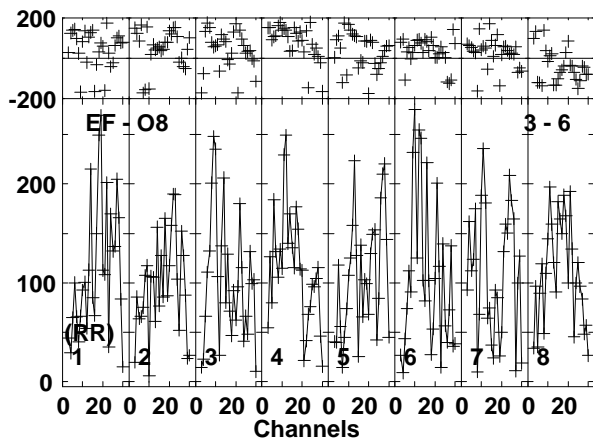
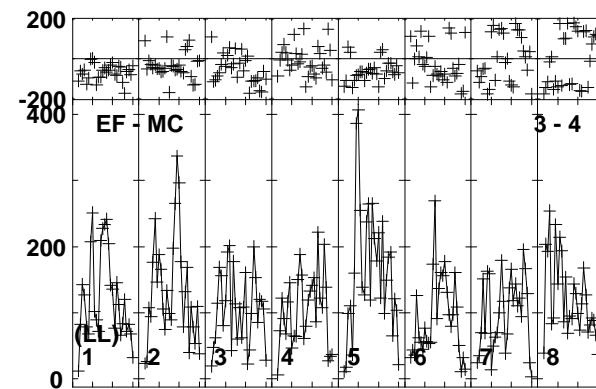
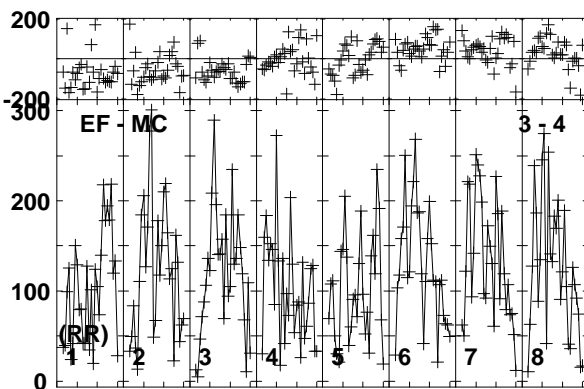
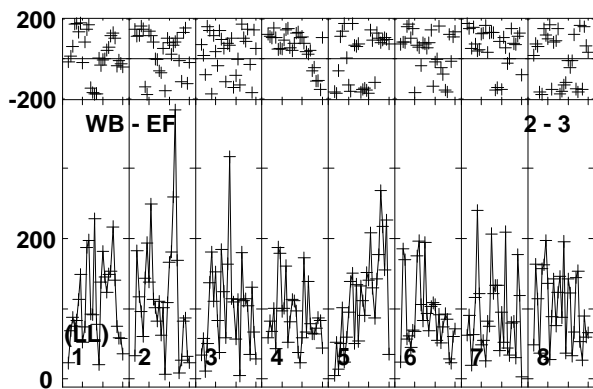
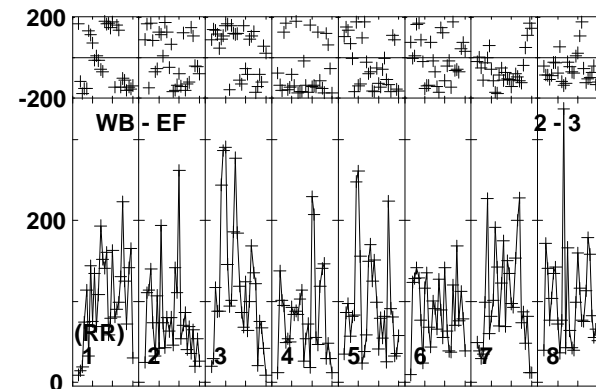
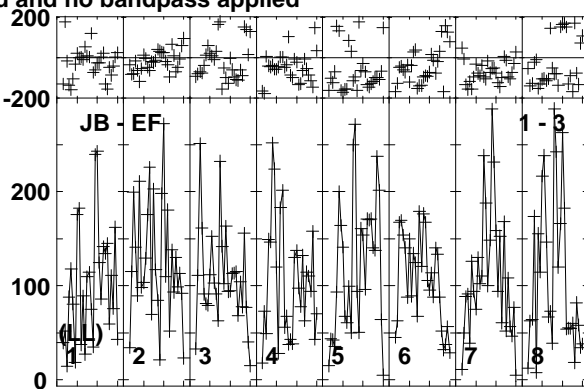
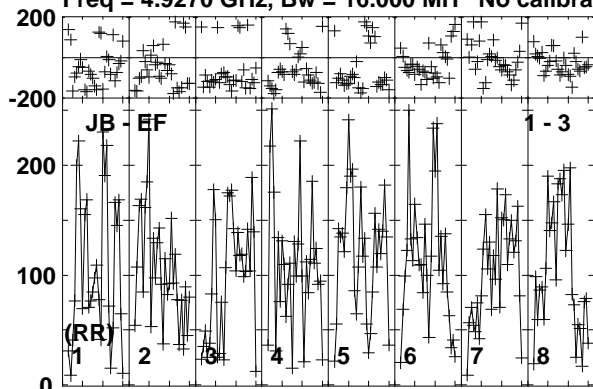

Lower frame: Micro Ampl Jy Top frame: Phas deg  
Vector averaged cross-power spectrum Baseline: JB (01) - EF (03)  
Timerange: 00/10:10:31 to 00/10:13:29

Plot file version 212 created 19-DEC-2018 17:58:26

AT2018\_RY007C.UVDATA.1

Freq = 4.9270 GHz, Bw = 16.000 MH No calibration applied and no bandpass applied

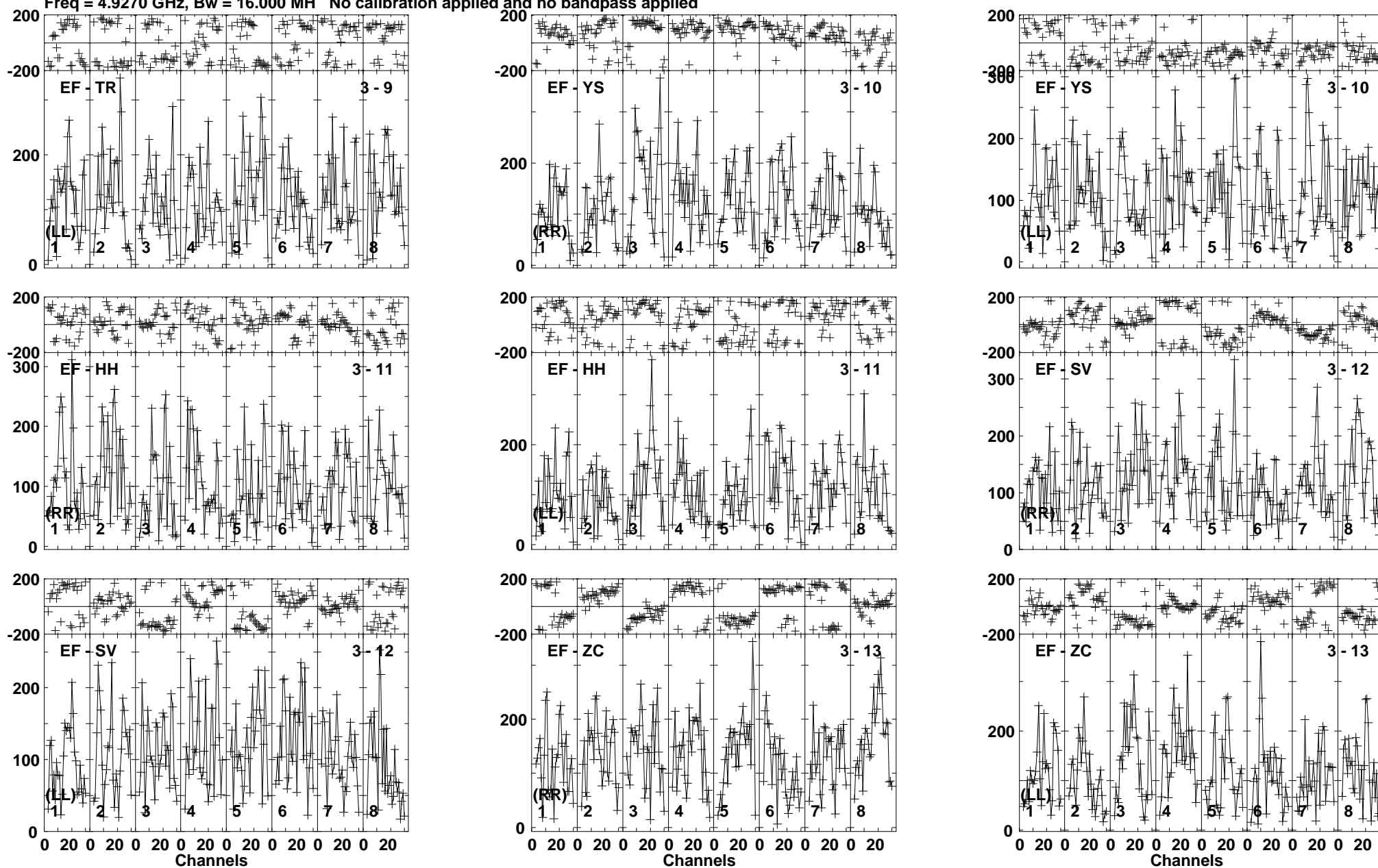

Lower frame: Micro Ampl Jy Top frame: Phas deg  
Vector averaged cross-power spectrum Baseline: EF (03) - TR (09)  
Timerange: 00/10:10:31 to 00/10:13:29

Plot file version 213 created 19-DEC-2018 17:58:26

AT2018\_RY007C.UVDATA.1

Freq = 4.9270 GHz, Bw = 16.000 MH No calibration applied and no bandpass applied

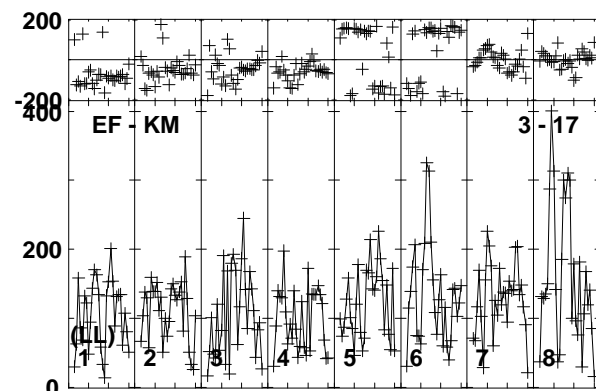
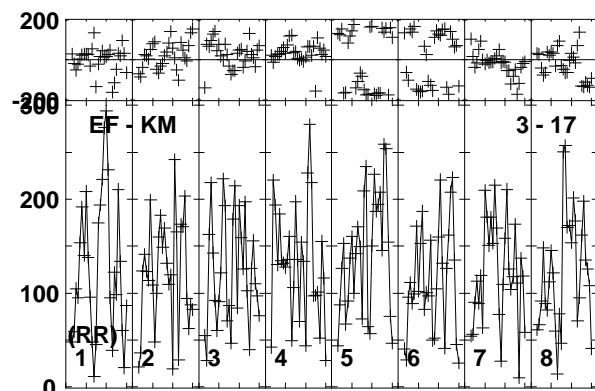
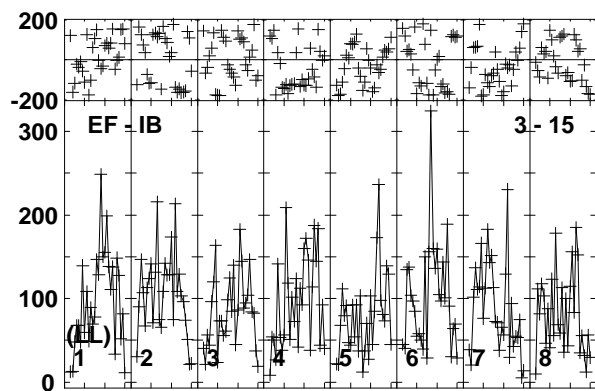
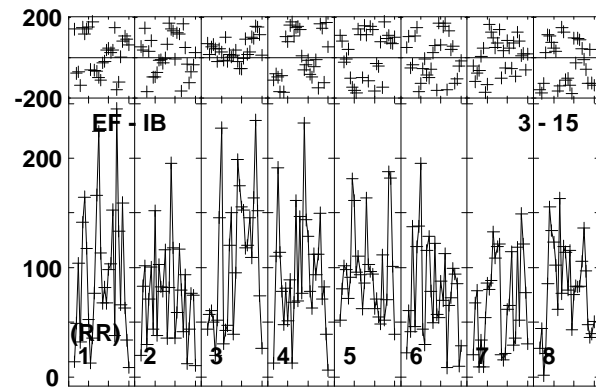
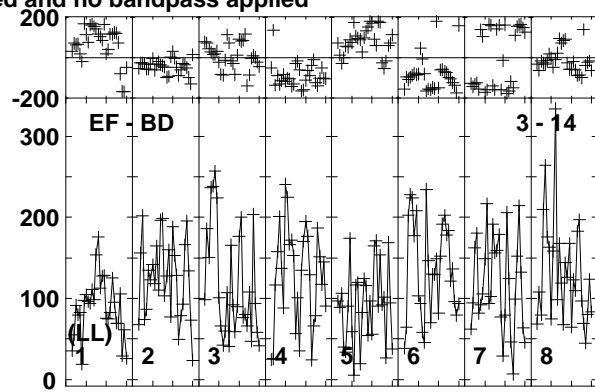
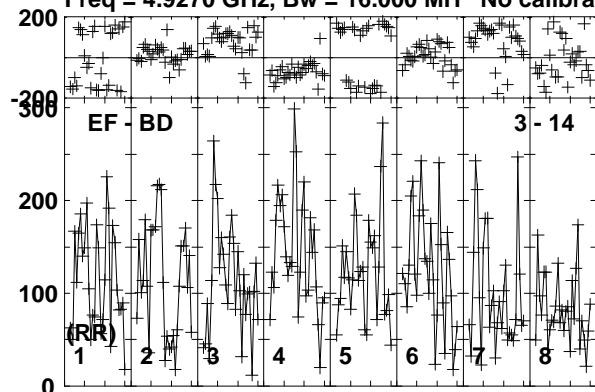

Lower frame: Micro Ampl Jy Top frame: Phas deg  
Vector averaged cross-power spectrum Baseline: EF (03) - BD (14)  
Timerange: 00/10:10:31 to 00/10:13:29

Plot file version 214 created 19-DEC-2018 17:58:26

J1619+2247 RY007C.UVDATA.1

Freq = 4.9270 GHz, Bw = 16.000 MH No calibration applied and no bandpass applied

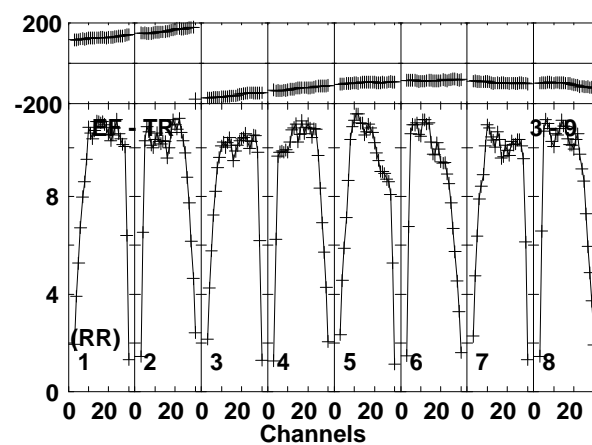
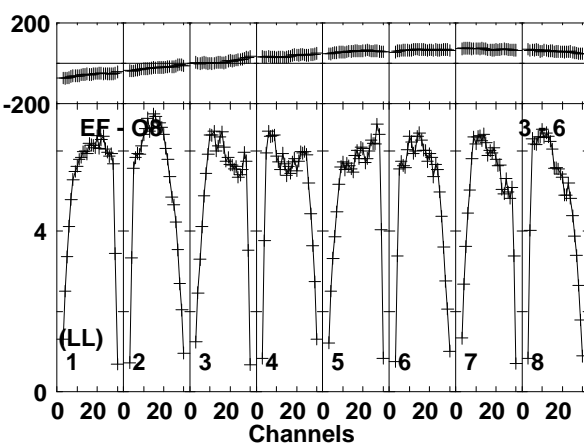
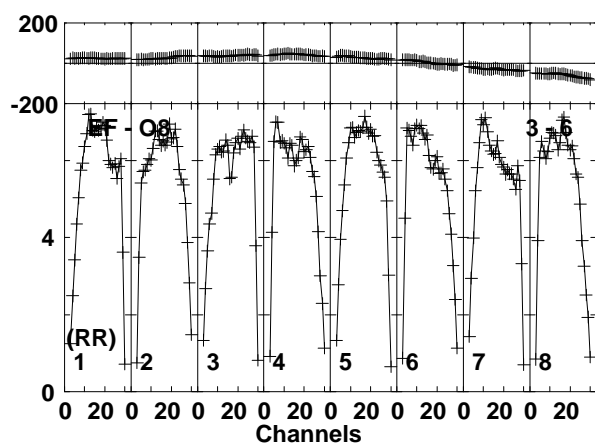
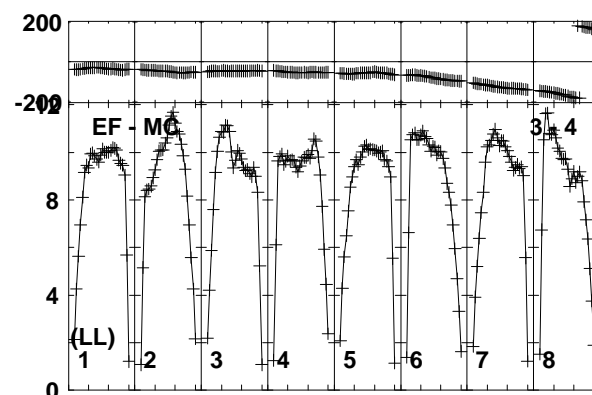
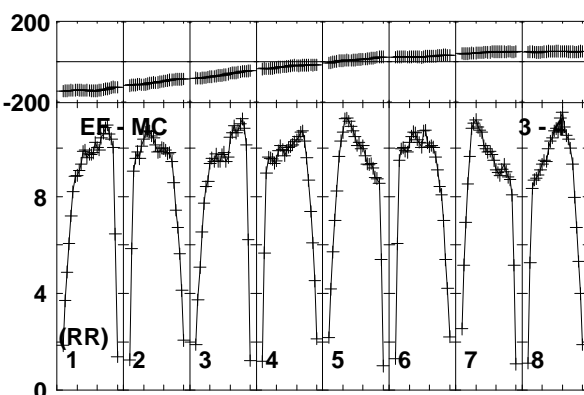
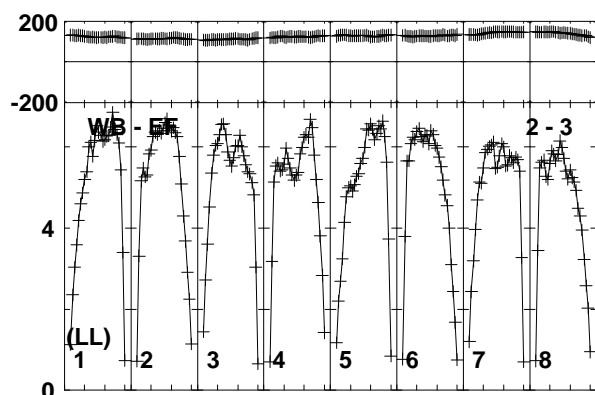
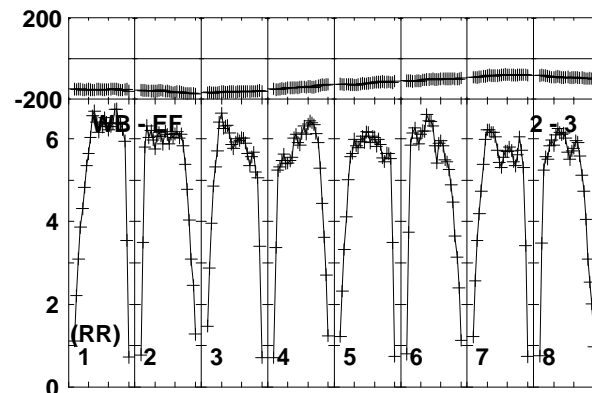
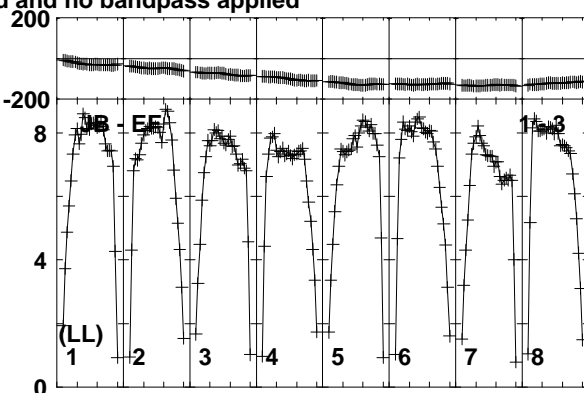
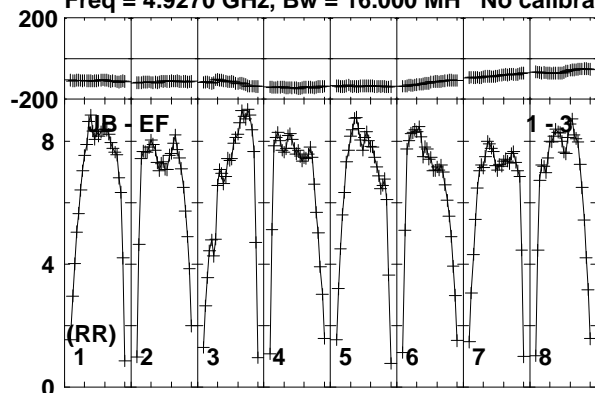

Lower frame: Milli Ampl Jy Top frame: Phas deg  
Vector averaged cross-power spectrum Baseline: JB (01) - EF (03)  
Timerange: 00/10:13:31 to 00/10:14:29

Plot file version 215 created 19-DEC-2018 17:58:26

J1619+2247 RY007C.UVDATA.1

Freq = 4.9270 GHz, Bw = 16.000 MH No calibration applied and no bandpass applied

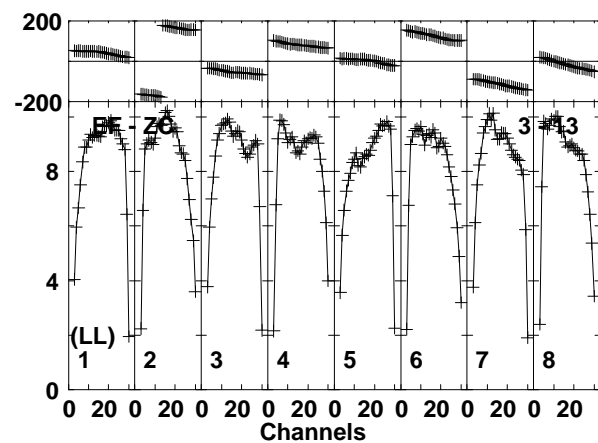
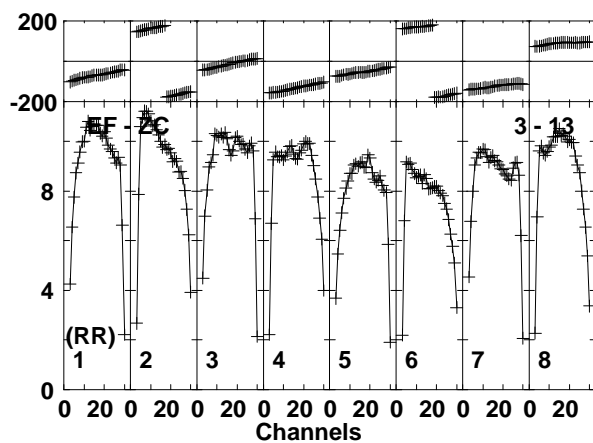
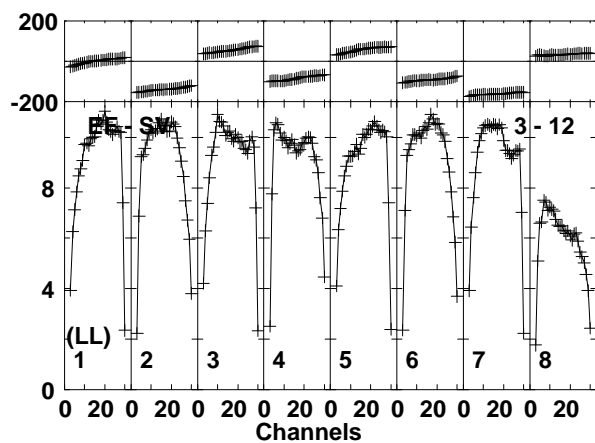
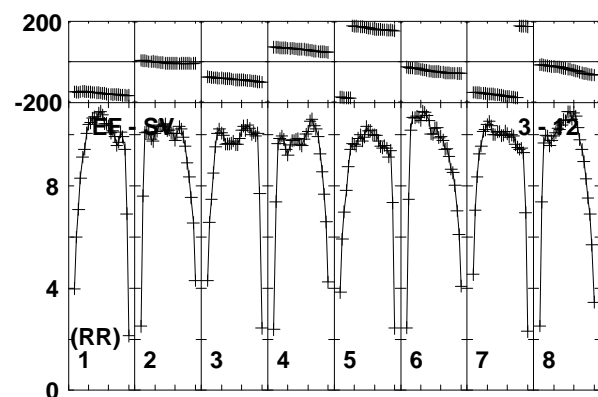
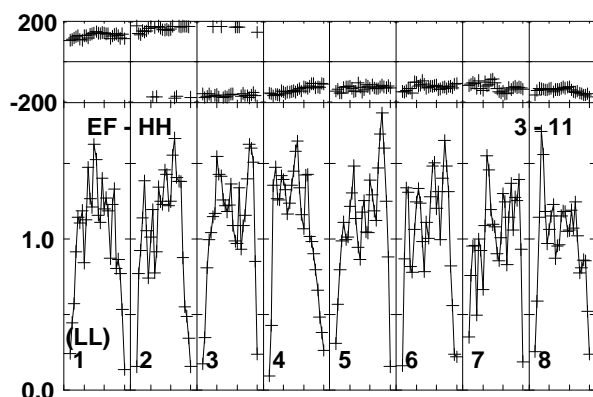
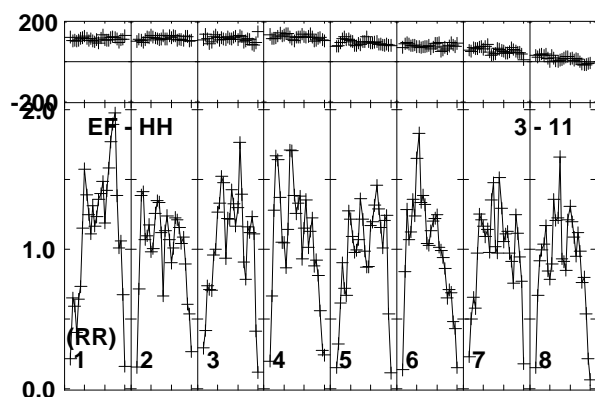
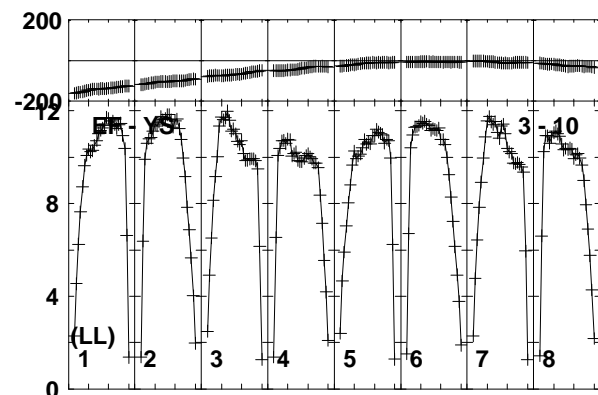
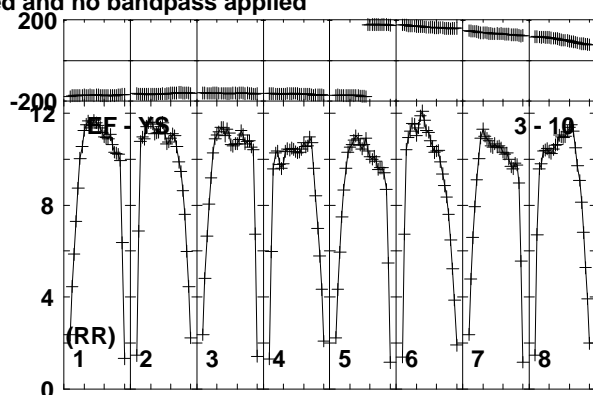
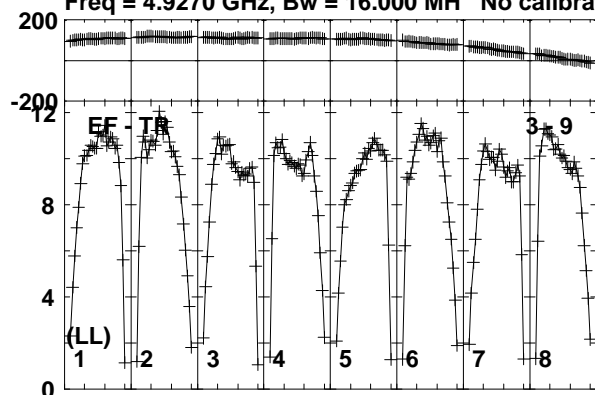

Lower frame: Milli Ampl Jy Top frame: Phas deg  
Vector averaged cross-power spectrum Baseline: EF (03) - TR (09)  
Timerange: 00/10:13:31 to 00/10:14:29

Plot file version 216 created 19-DEC-2018 17:58:26

J1619+2247 RY007C.UVDATA.1

Freq = 4.9270 GHz, Bw = 16.000 MH No calibration applied and no bandpass applied

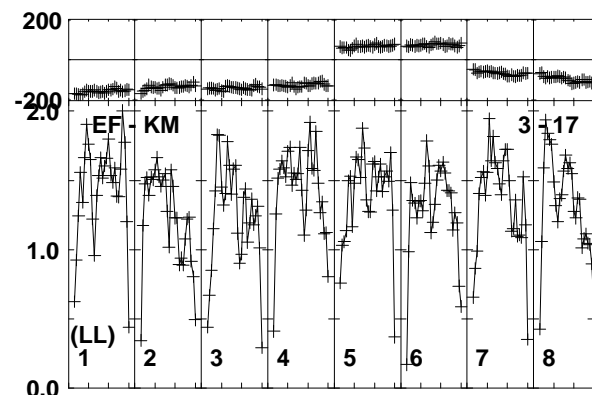
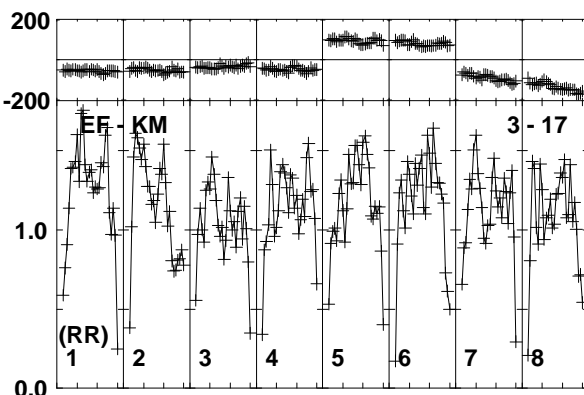
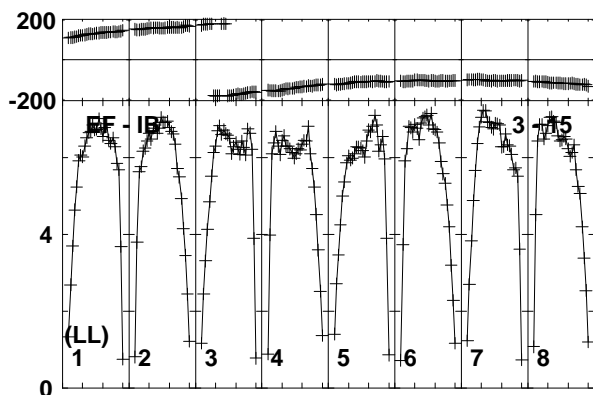
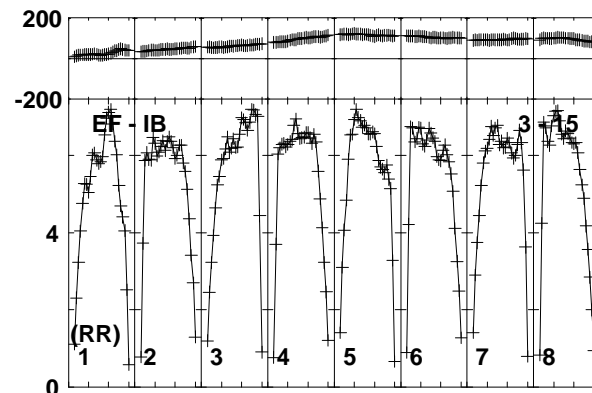
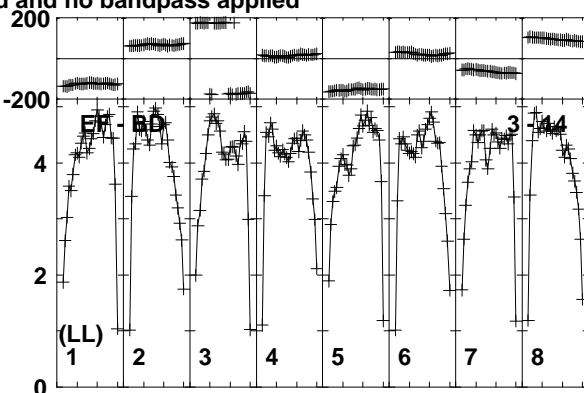
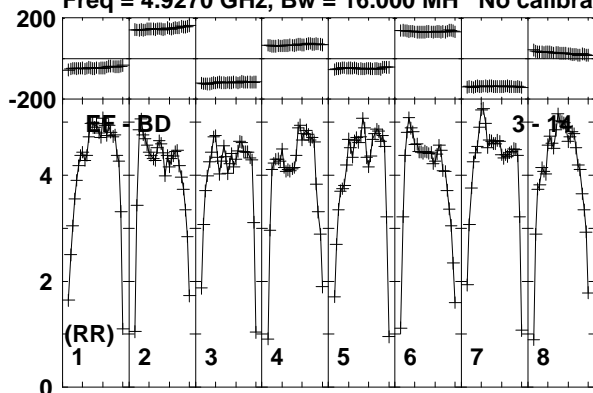

Lower frame: Milli Ampl Jy Top frame: Phas deg  
Vector averaged cross-power spectrum Baseline: EF (03) - BD (14)  
Timerange: 00/10:13:31 to 00/10:14:29

Plot file version 217 created 19-DEC-2018 17:58:26

VLA1 RY007C.UVDATA.1

Freq = 4.9270 GHz, Bw = 16.000 MH No calibration applied and no bandpass applied

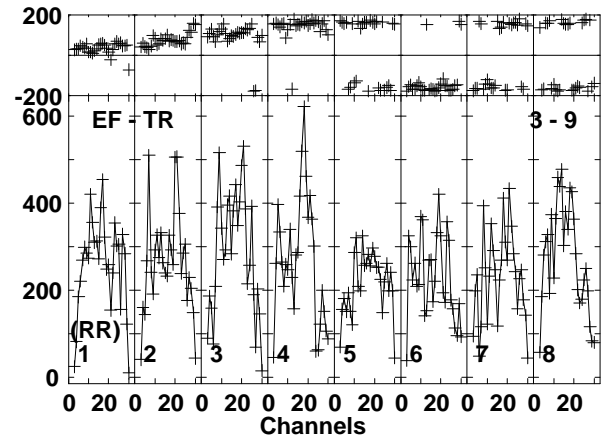
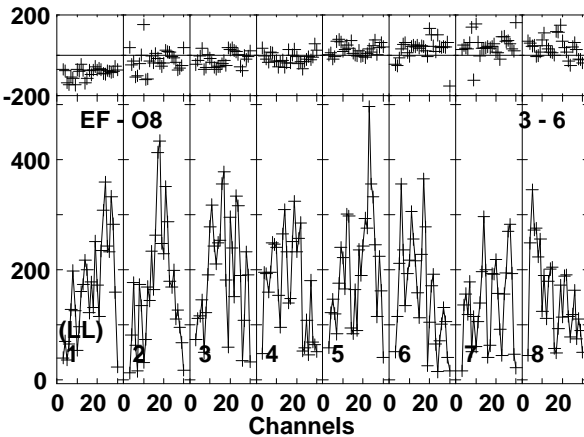
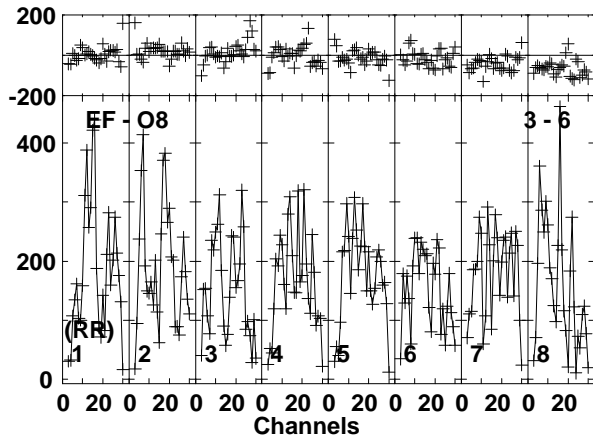
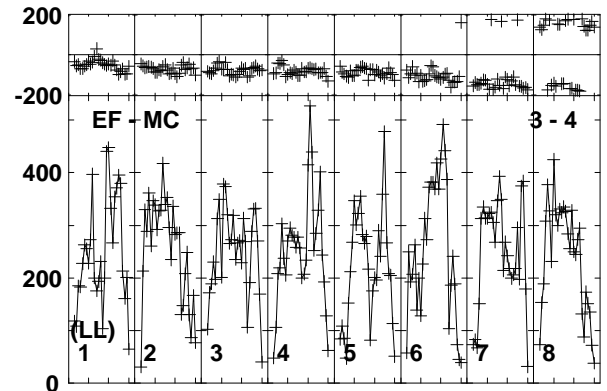
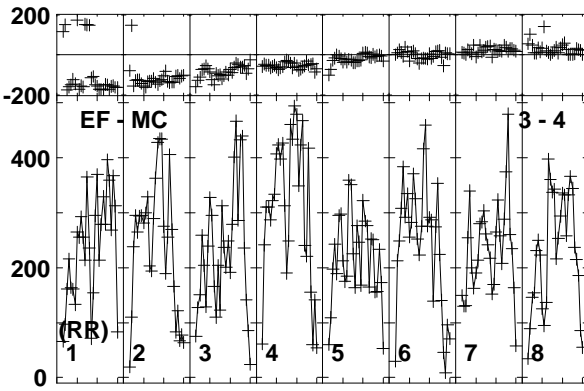
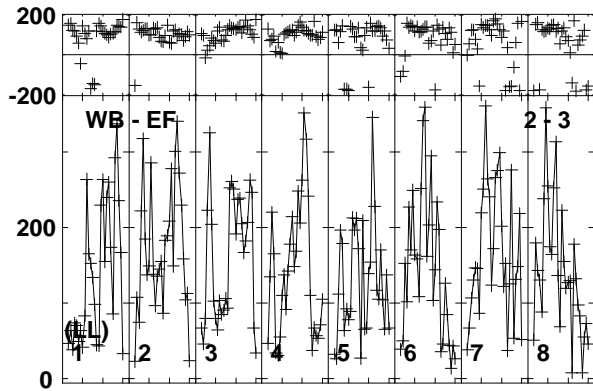
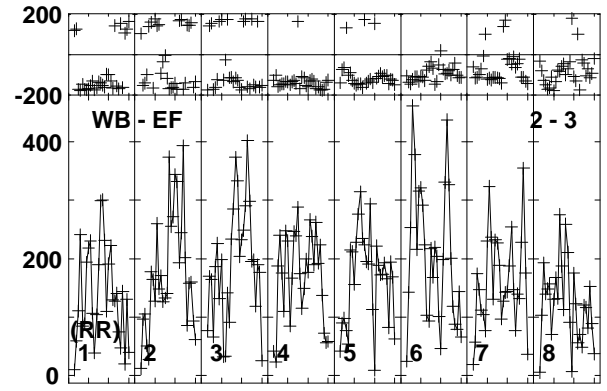
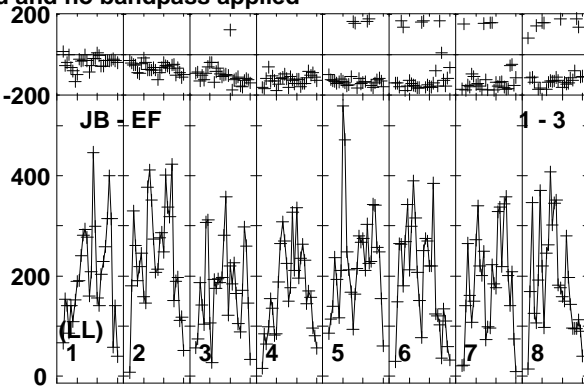
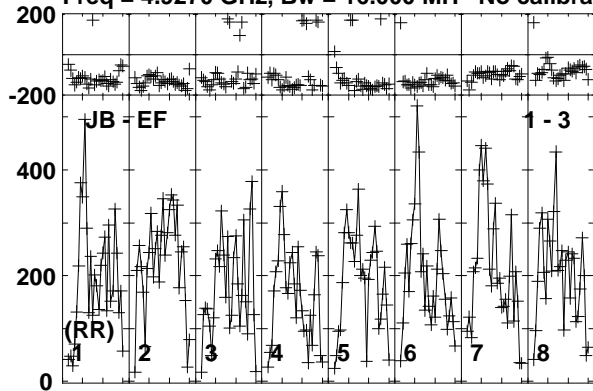

Lower frame: Micro Ampl Jy Top frame: Phas deg  
Vector averaged cross-power spectrum Baseline: JB (01) - EF (03)  
Timerange: 00/10:15:01 to 00/10:16:59

Plot file version 218 created 19-DEC-2018 17:58:26

VLA1 RY007C.UVDATA.1

Freq = 4.9270 GHz, Bw = 16.000 MH No calibration applied and no bandpass applied

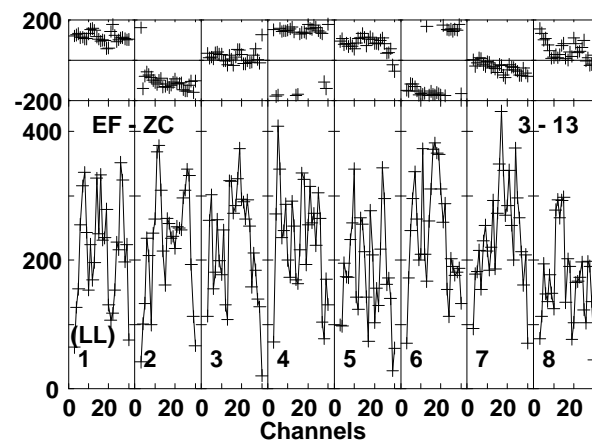
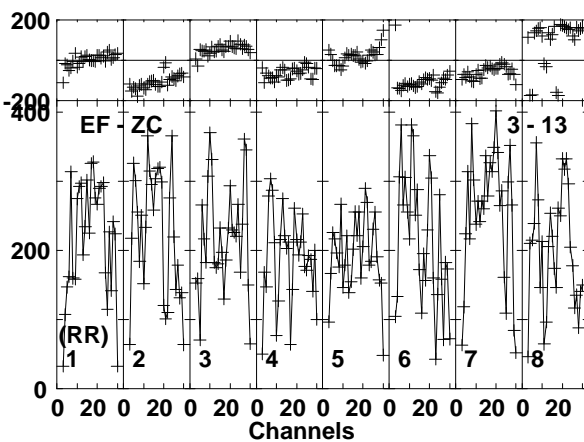
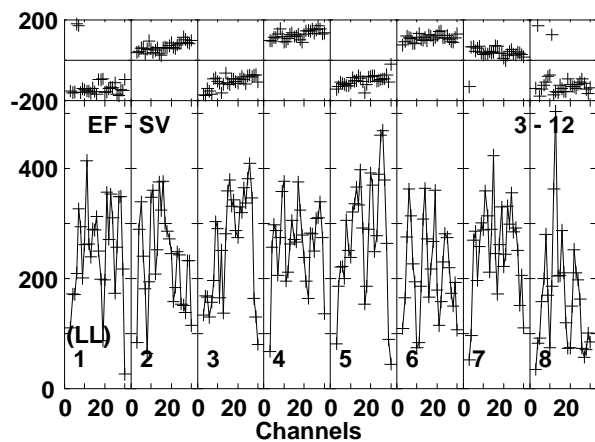
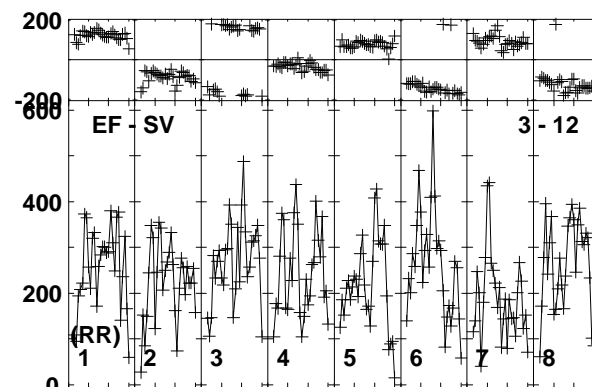
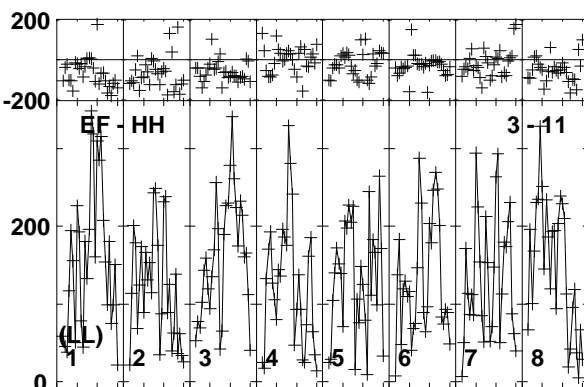
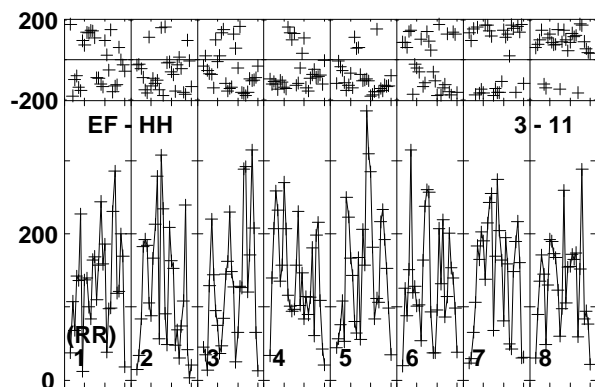
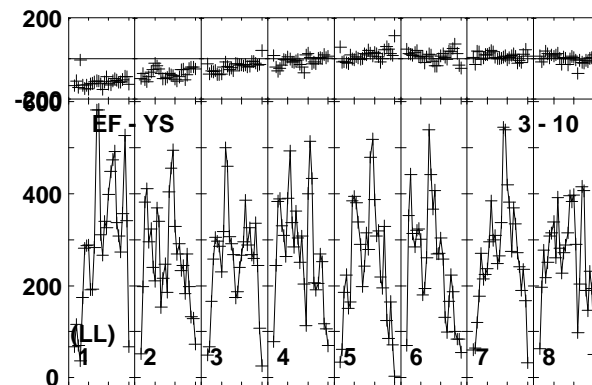
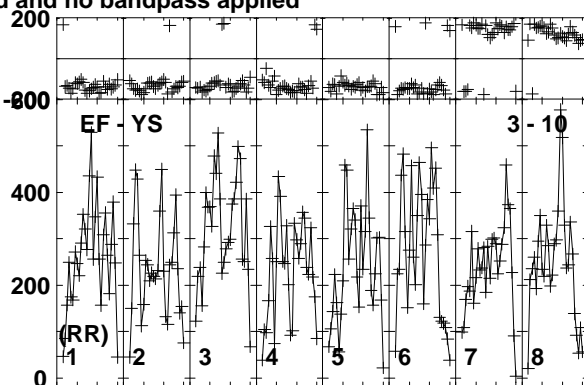
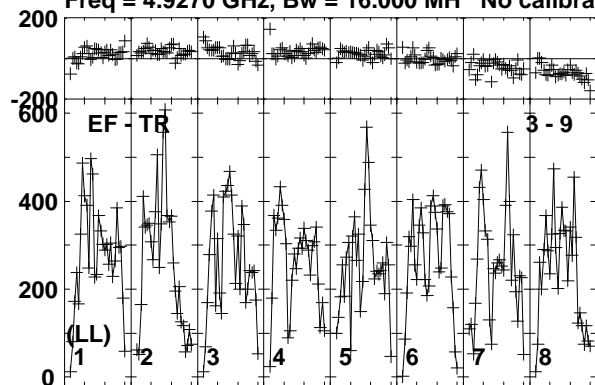

Lower frame: Micro Ampl Jy Top frame: Phas deg  
Vector averaged cross-power spectrum Baseline: EF (03) - TR (09)  
Timerange: 00/10:15:01 to 00/10:16:59



Plot file version 219 created 19-DEC-2018 17:58:26

VLA1 RY007C.UVDATA.1

Freq = 4.9270 GHz, Bw = 16.000 MH No calibration applied and no bandpass applied

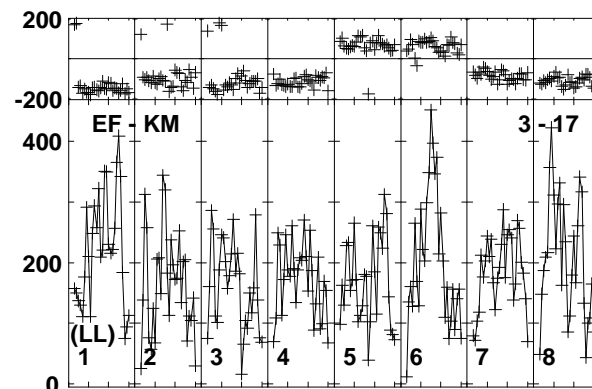
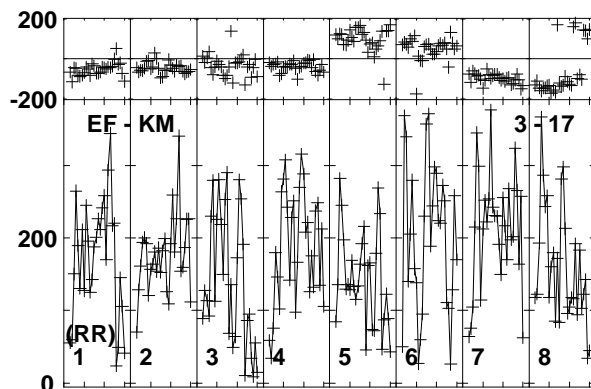
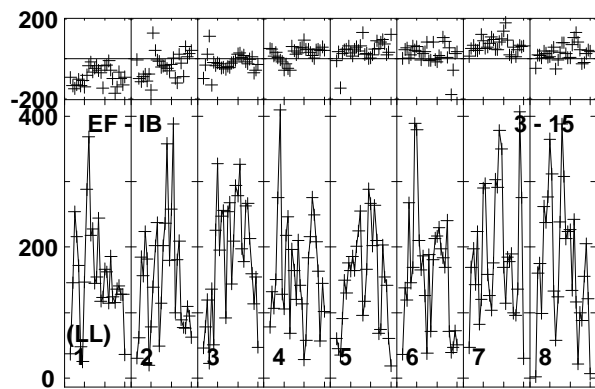
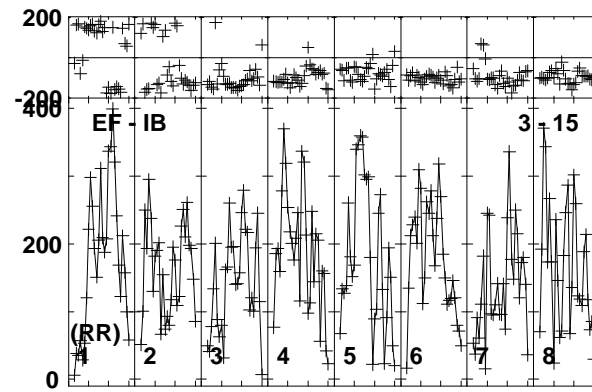
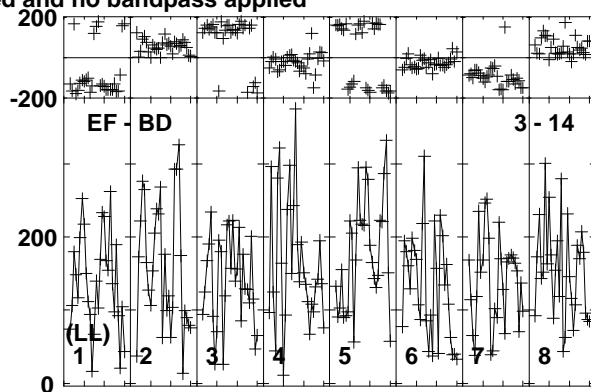
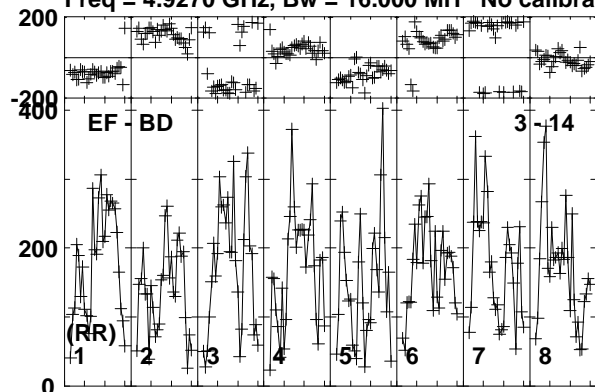

Lower frame: Micro Ampl Jy Top frame: Phas deg  
Vector averaged cross-power spectrum Baseline: EF (03) - BD (14)  
Timerange: 00/10:15:01 to 00/10:16:59

Plot file version 220 created 19-DEC-2018 17:58:26

J1619+2247 RY007C.UVDATA.1

Freq = 4.9270 GHz, Bw = 16.000 MH No calibration applied and no bandpass applied

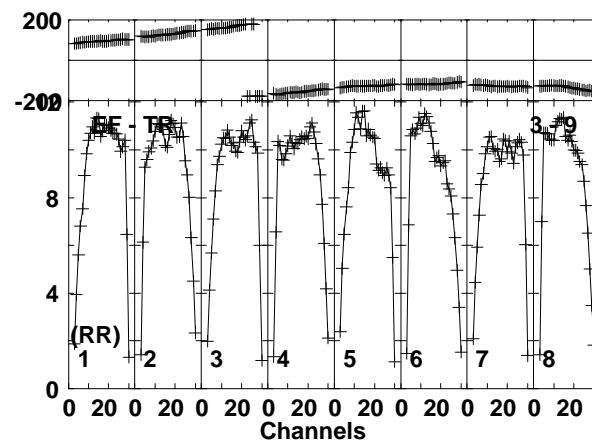
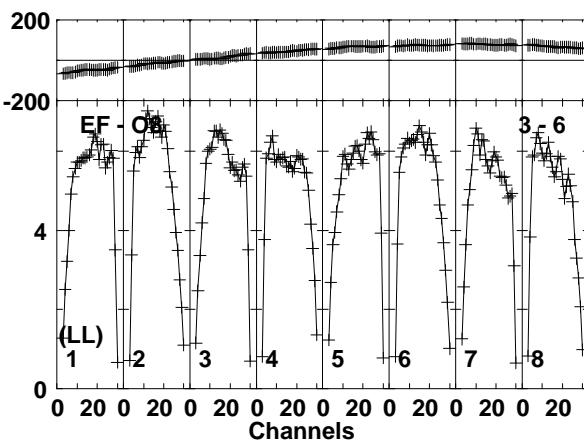
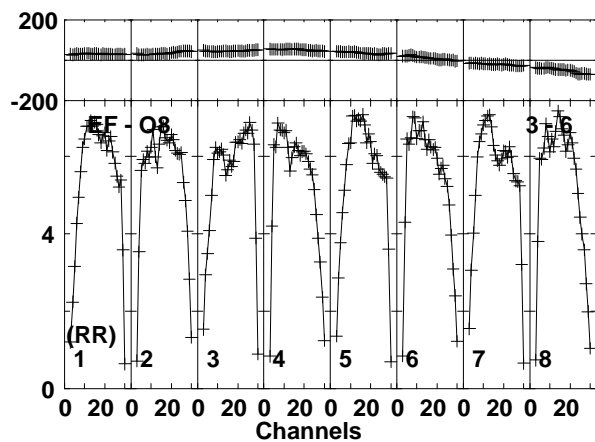
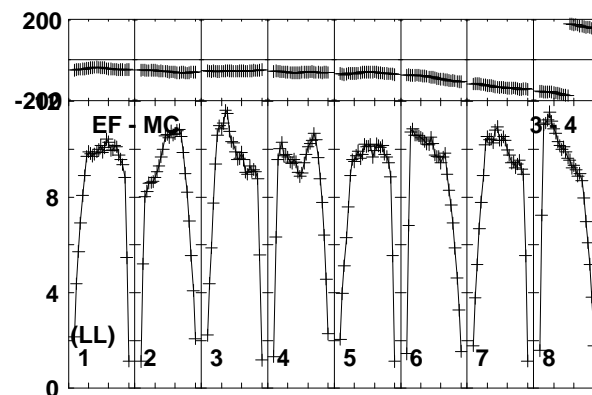
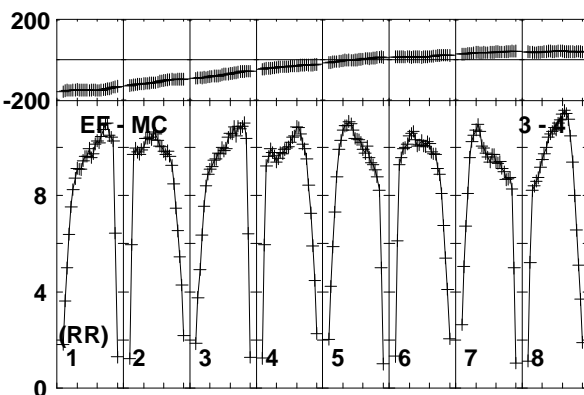
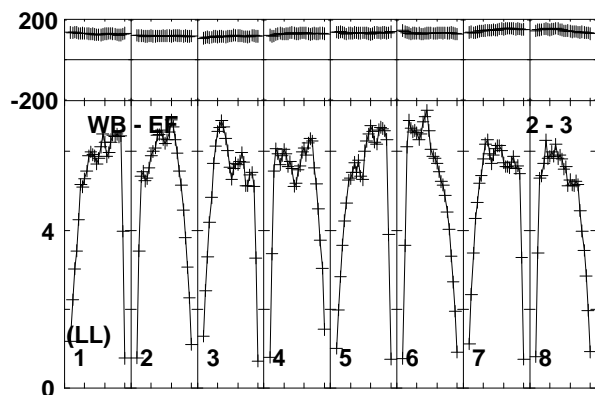
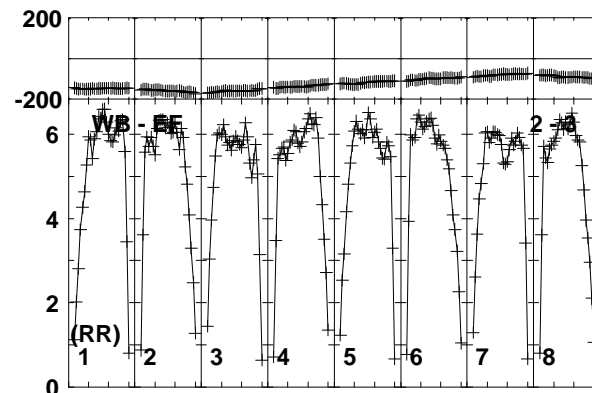
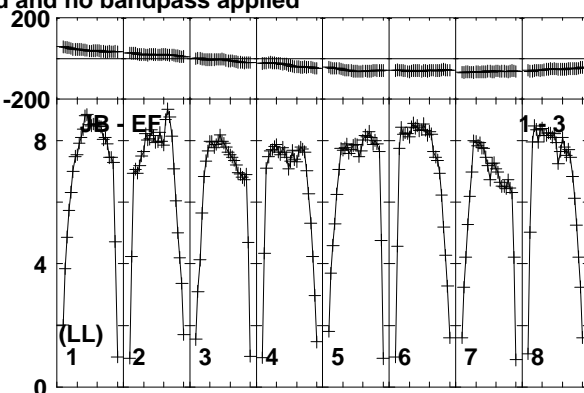
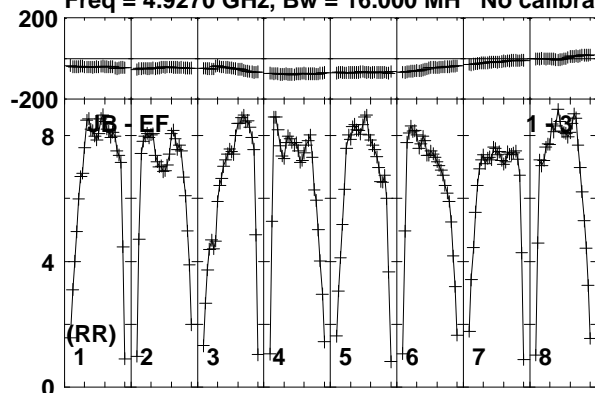

Lower frame: Milli Ampl Jy Top frame: Phas deg  
Vector averaged cross-power spectrum Baseline: JB (01) - EF (03)  
Timerange: 00/10:17:01 to 00/10:17:59

Plot file version 221 created 19-DEC-2018 17:58:26

J1619+2247 RY007C.UVDATA.1

Freq = 4.9270 GHz, Bw = 16.000 MH No calibration applied and no bandpass applied

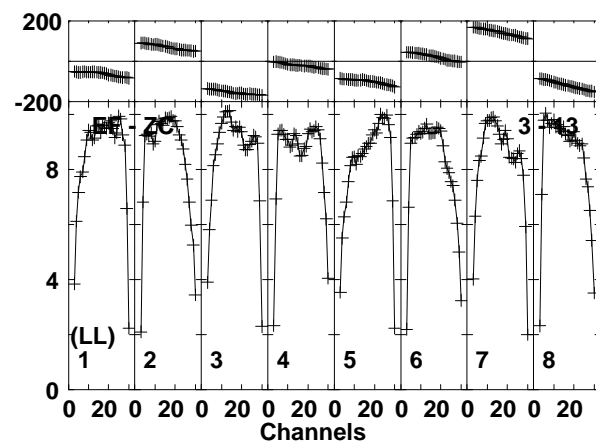
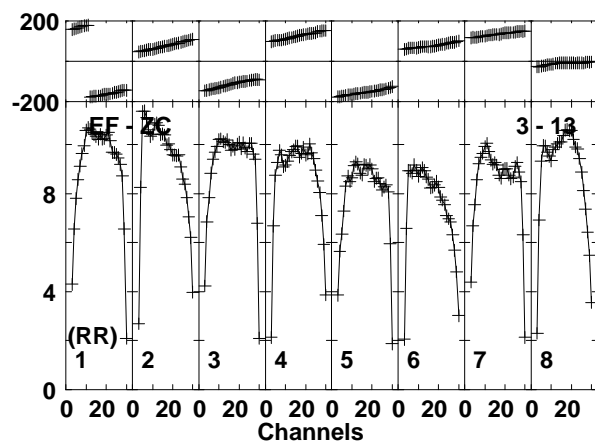
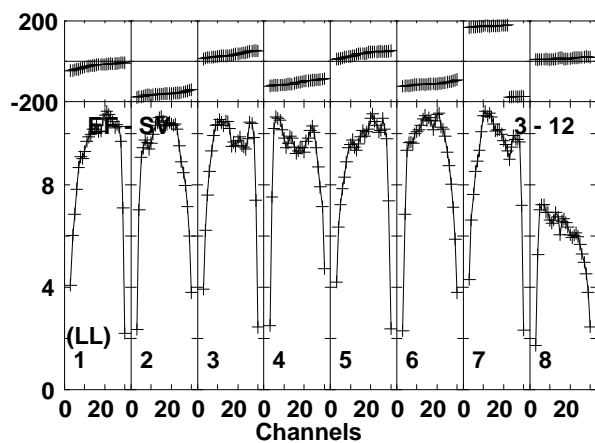
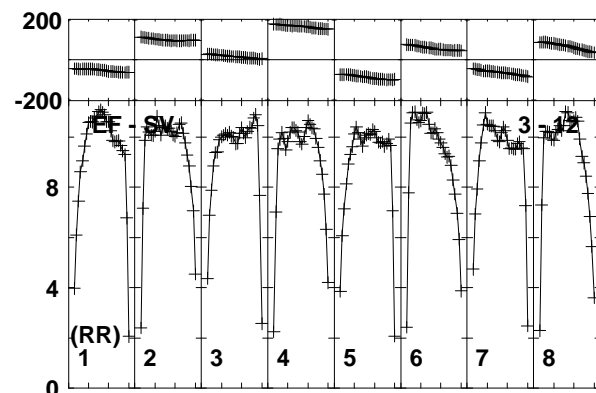
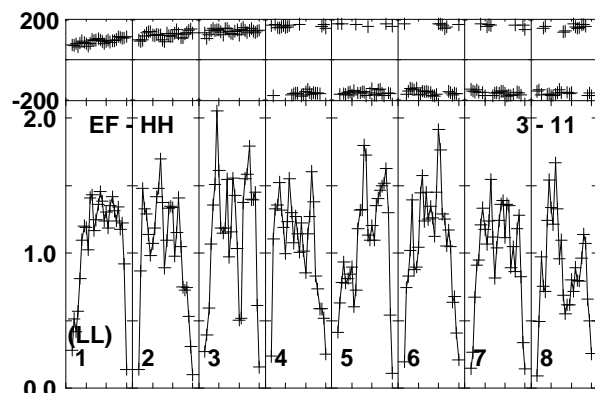
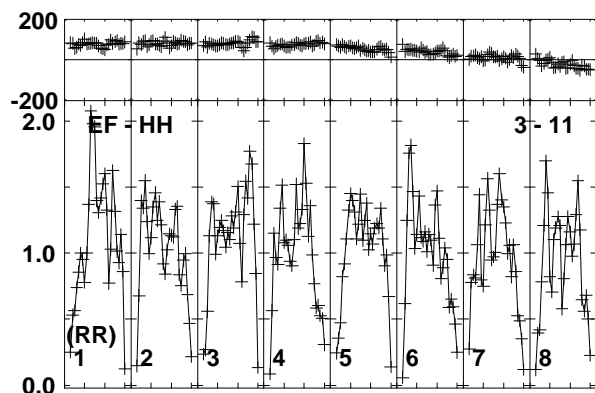
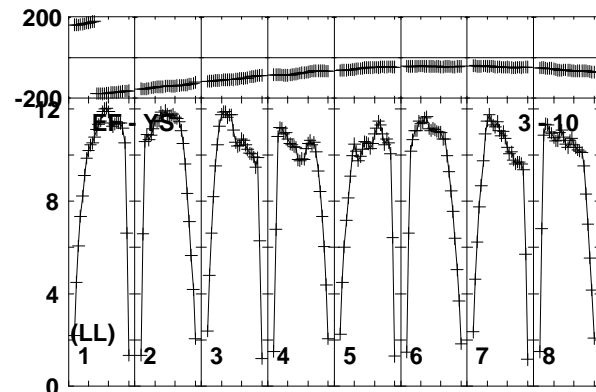
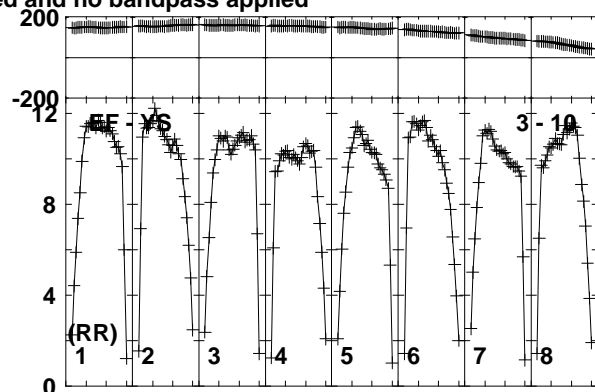
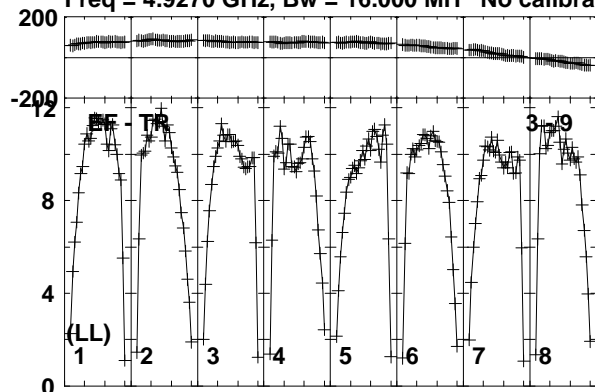

Lower frame: Milli Ampl Jy Top frame: Phas deg  
Vector averaged cross-power spectrum Baseline: EF (03) - TR (09)  
Timerange: 00/10:17:01 to 00/10:17:59

Plot file version 222 created 19-DEC-2018 17:58:26

J1619+2247 RY007C.UVDATA.1

Freq = 4.9270 GHz, Bw = 16.000 MH No calibration applied and no bandpass applied

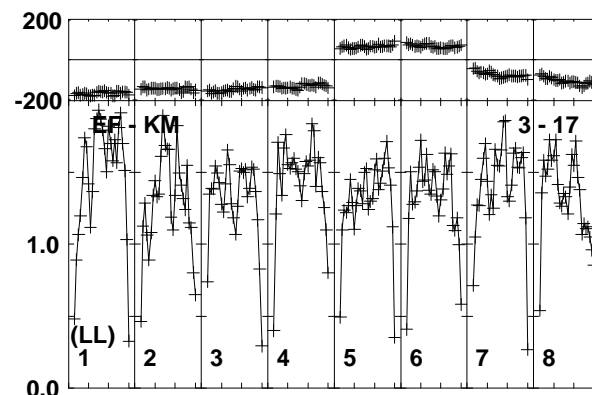
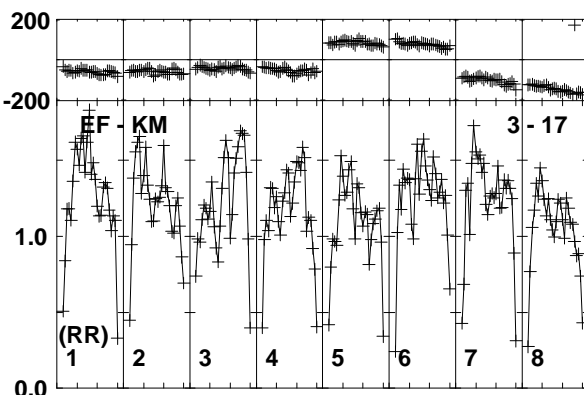
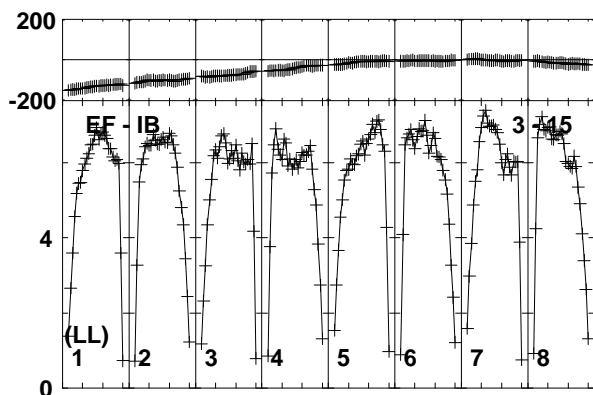
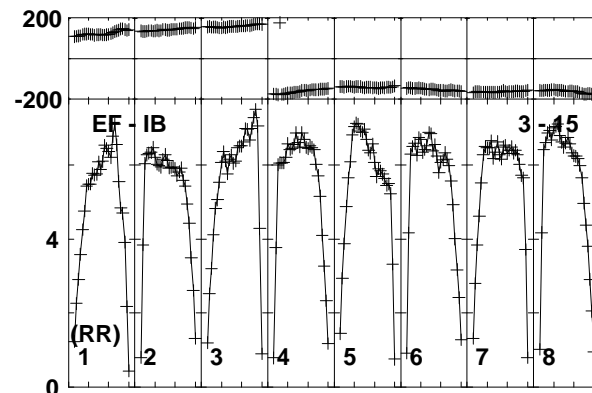
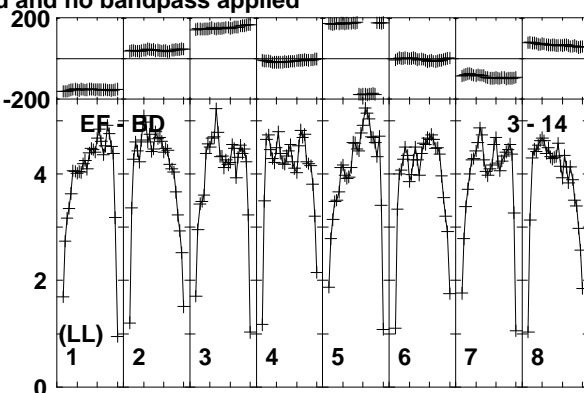
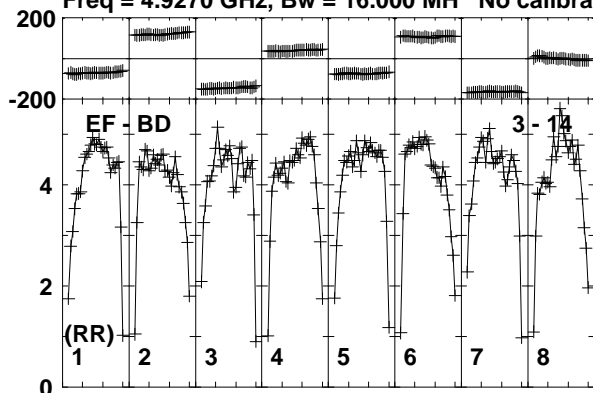

Lower frame: Milli Ampl Jy Top frame: Phas deg  
Vector averaged cross-power spectrum Baseline: EF (03) - BD (14)  
Timerange: 00/10:17:01 to 00/10:17:59

Plot file version 223 created 19-DEC-2018 17:58:26

AT2018\_RY007C.UVDATA.1

Freq = 4.9270 GHz, Bw = 16.000 MH No calibration applied and no bandpass applied

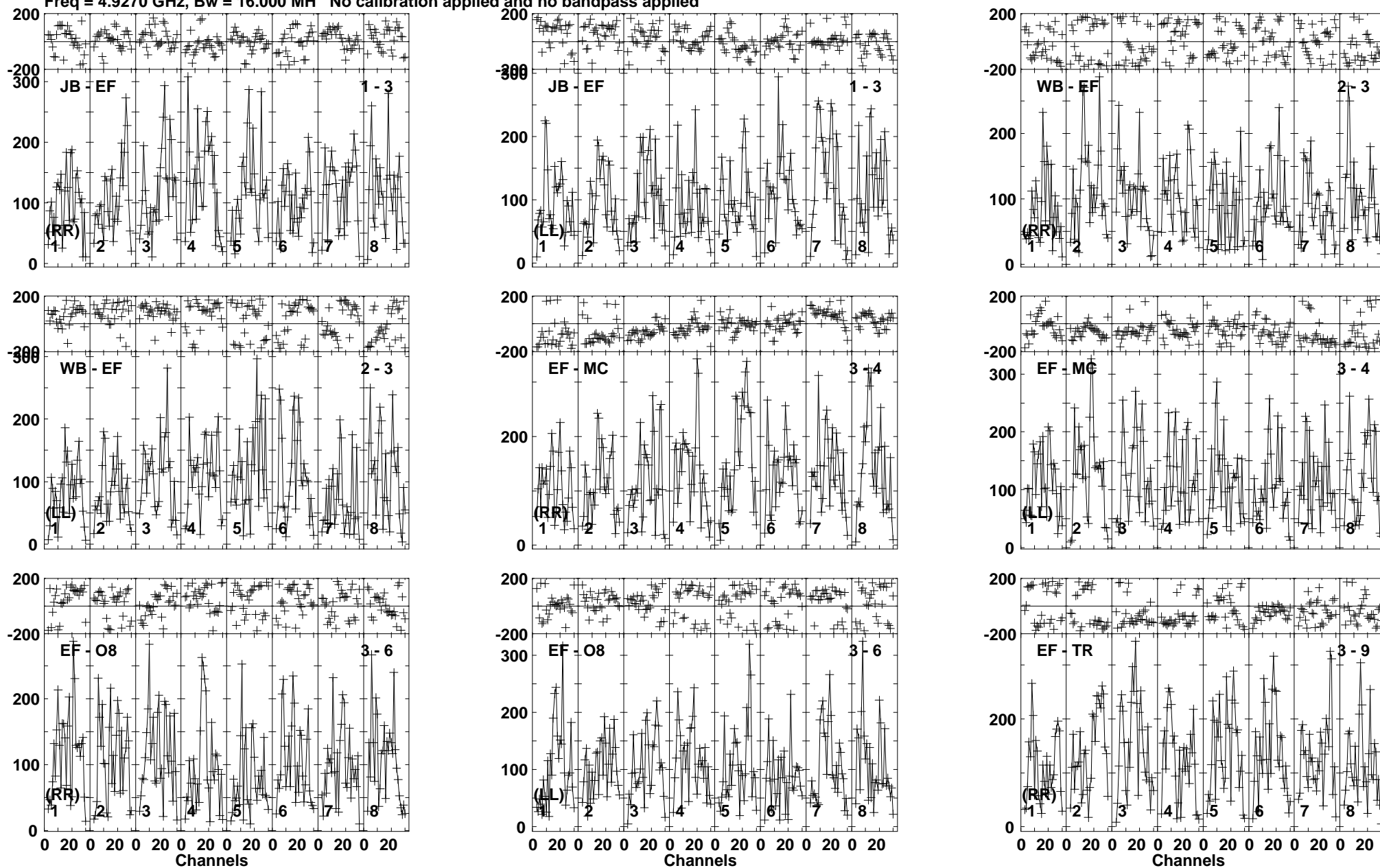

Lower frame: Micro Ampl Jy Top frame: Phas deg  
Vector averaged cross-power spectrum Baseline: JB (01) - EF (03)  
Timerange: 00/10:18:01 to 00/10:20:59

Plot file version 224 created 19-DEC-2018 17:58:26

AT2018\_RY007C.UVDATA.1

Freq = 4.9270 GHz, Bw = 16.000 MH No calibration applied and no bandpass applied

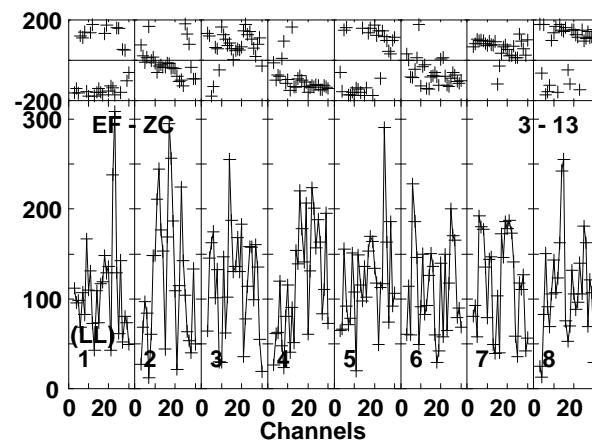
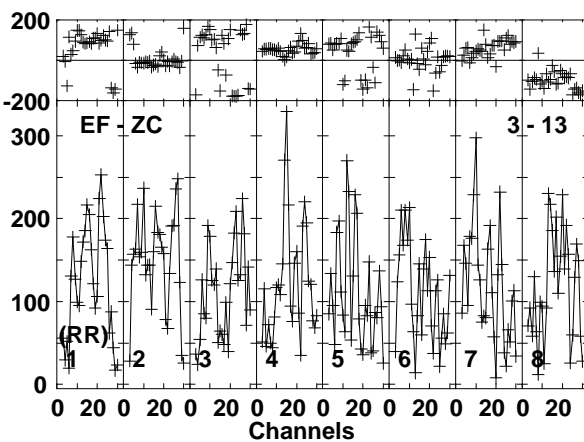
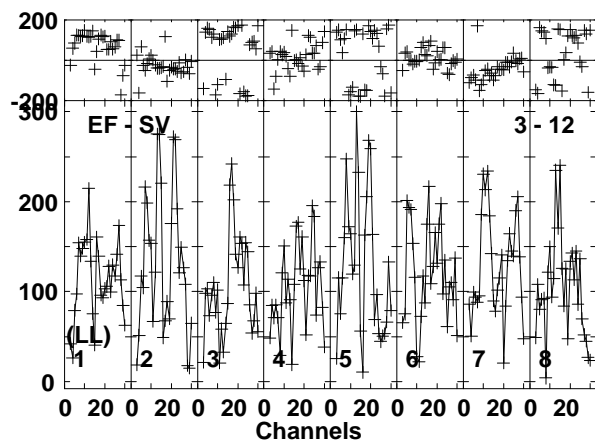
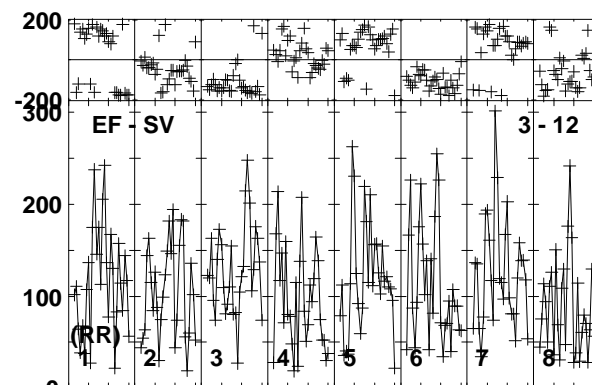
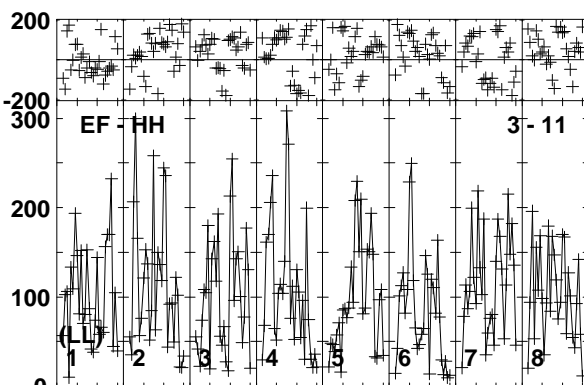
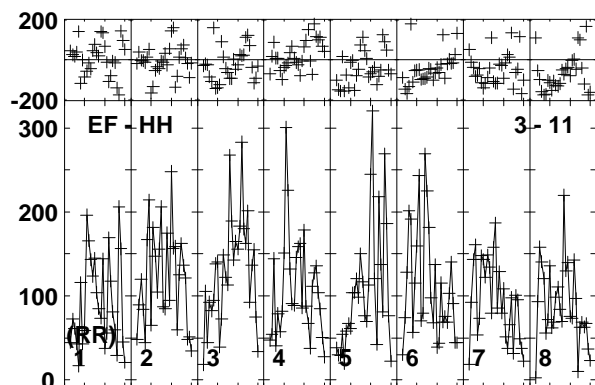
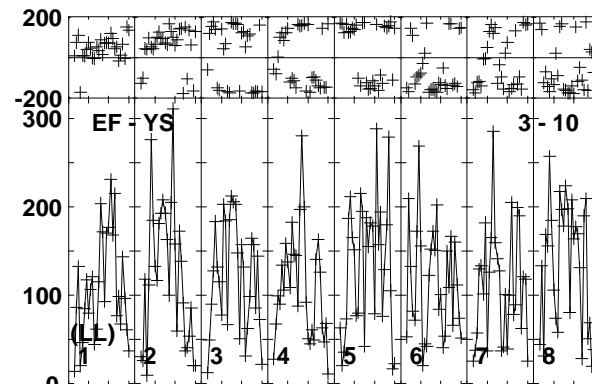
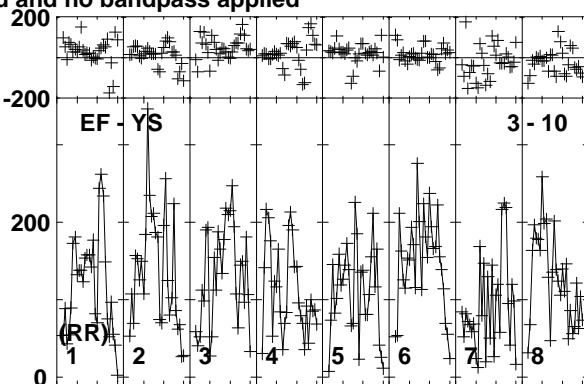
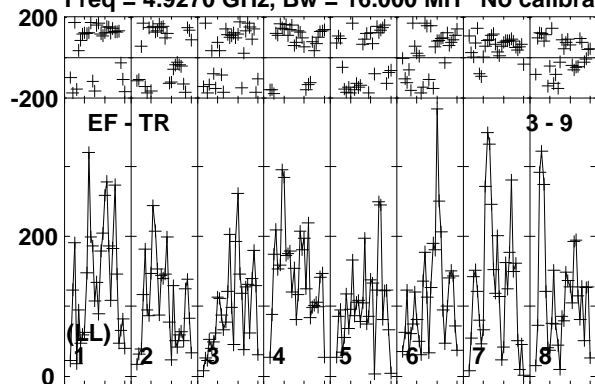

Lower frame: Micro Ampl Jy Top frame: Phas deg  
Vector averaged cross-power spectrum Baseline: EF (03) - TR (09)  
Timerange: 00/10:18:01 to 00/10:20:59

Plot file version 225 created 19-DEC-2018 17:58:26

AT2018\_RY007C.UVDATA.1

Freq = 4.9270 GHz, Bw = 16.000 MH No calibration applied and no bandpass applied

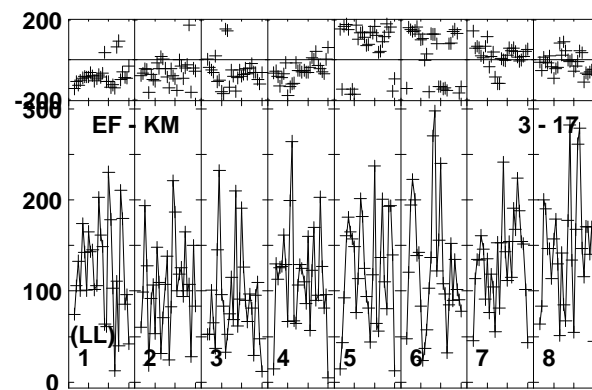
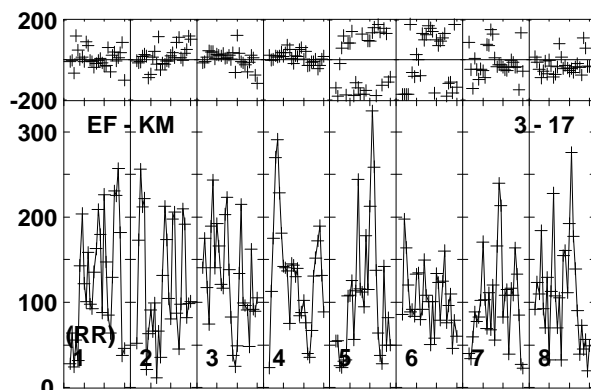
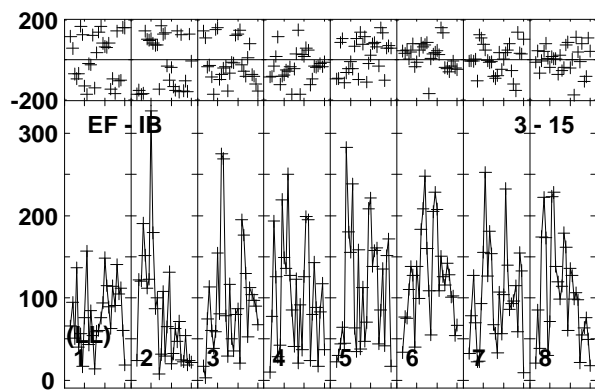
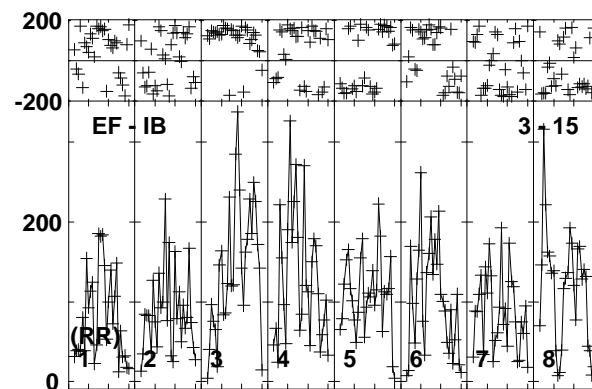
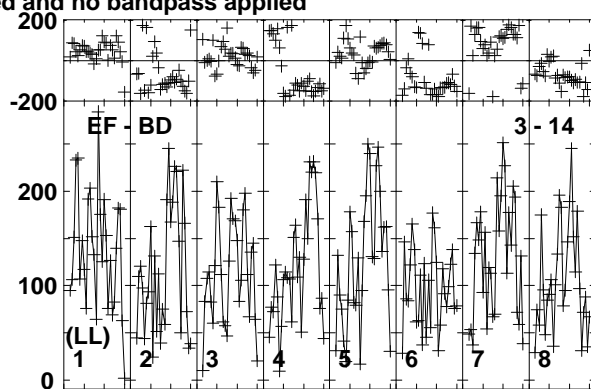
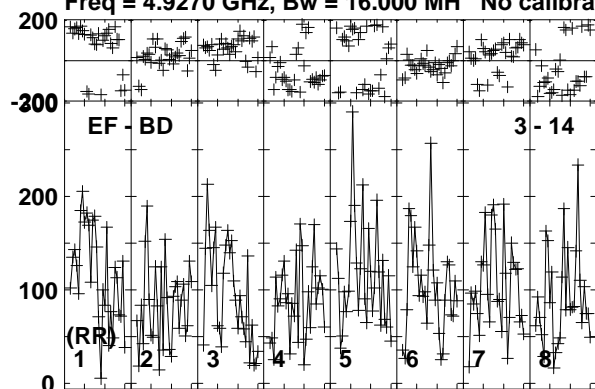

Lower frame: Micro Ampl Jy Top frame: Phas deg  
Vector averaged cross-power spectrum Baseline: EF (03) - BD (14)  
Timerange: 00/10:18:01 to 00/10:20:59

Plot file version 226 created 19-DEC-2018 17:58:26

J1619+2247 RY007C.UVDATA.1

Freq = 4.9270 GHz, Bw = 16.000 MH No calibration applied and no bandpass applied

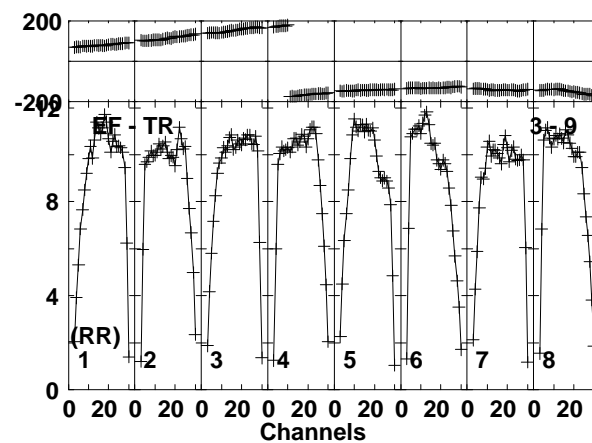
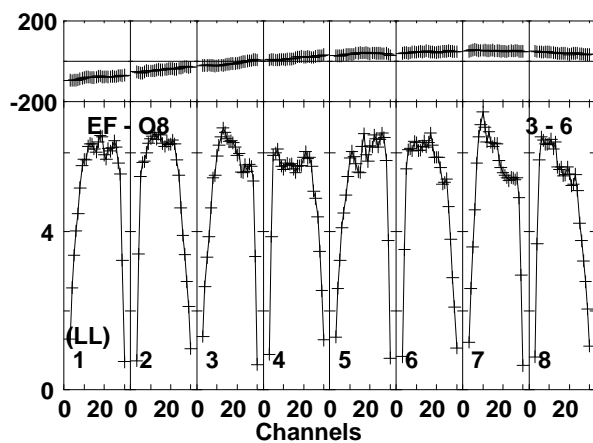
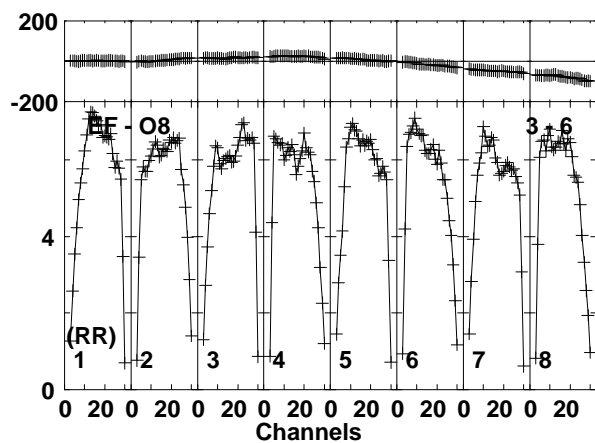
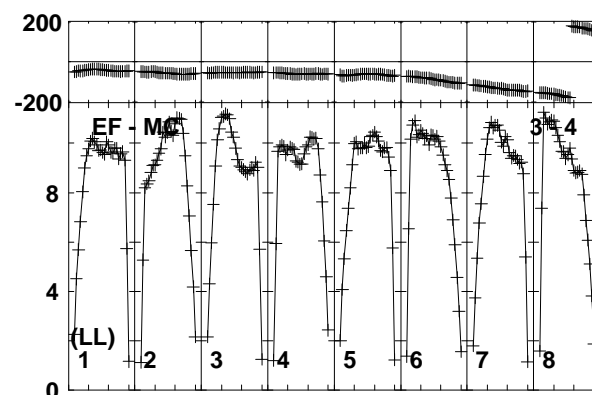
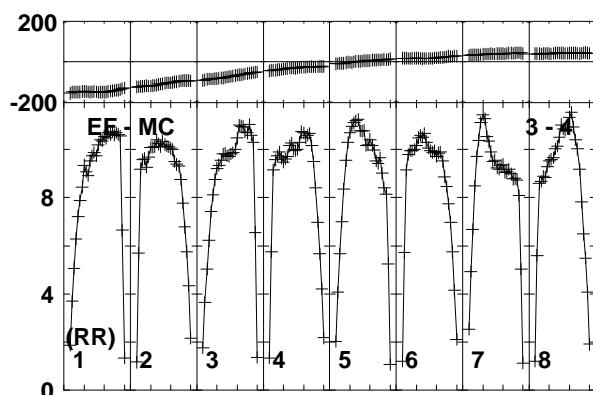
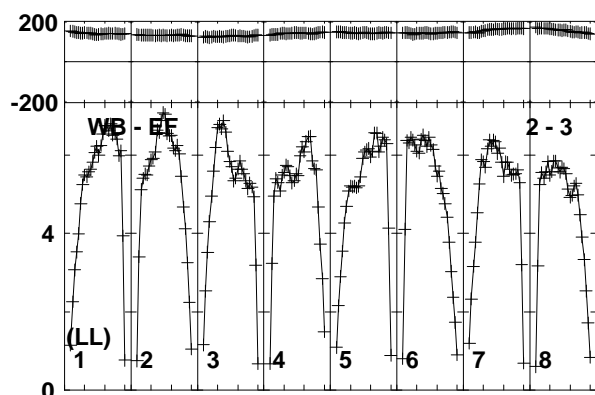
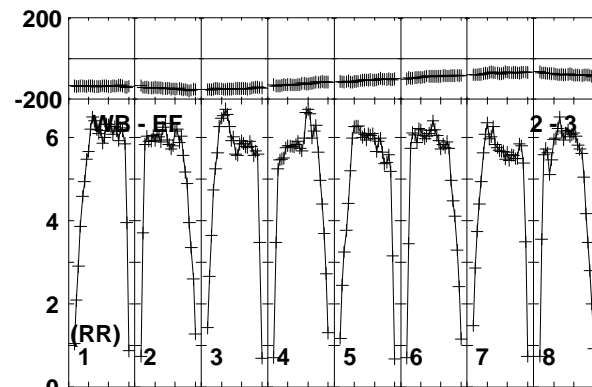
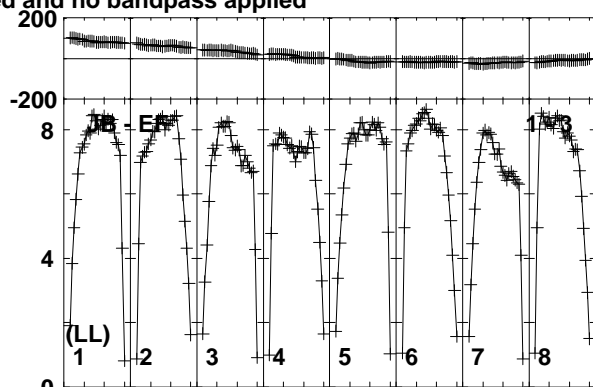
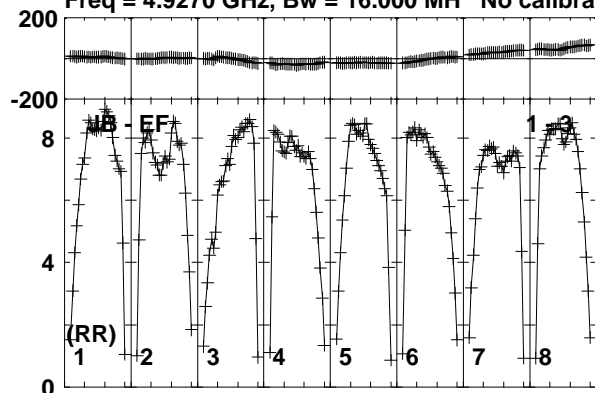

Lower frame: Milli Ampl Jy Top frame: Phas deg  
Vector averaged cross-power spectrum Baseline: JB (01) - EF (03)  
Timerange: 00/10:21:01 to 00/10:21:59



Plot file version 227 created 19-DEC-2018 17:58:27

J1619+2247 RY007C.UVDATA.1

Freq = 4.9270 GHz, Bw = 16.000 MH No calibration applied and no bandpass applied

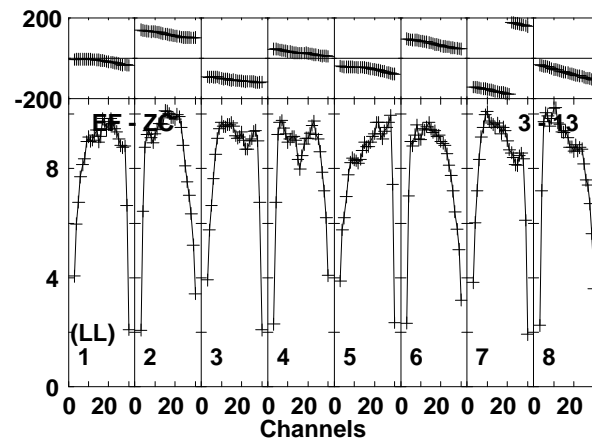
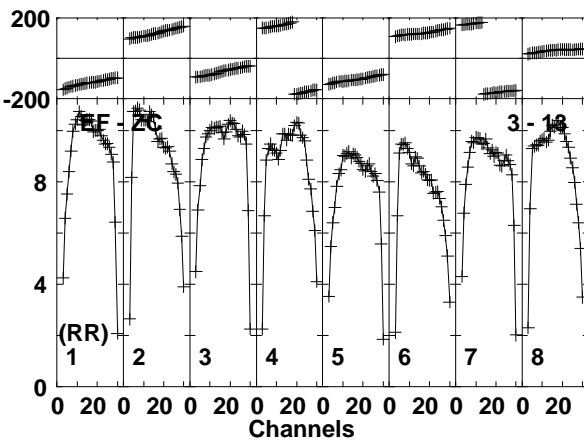
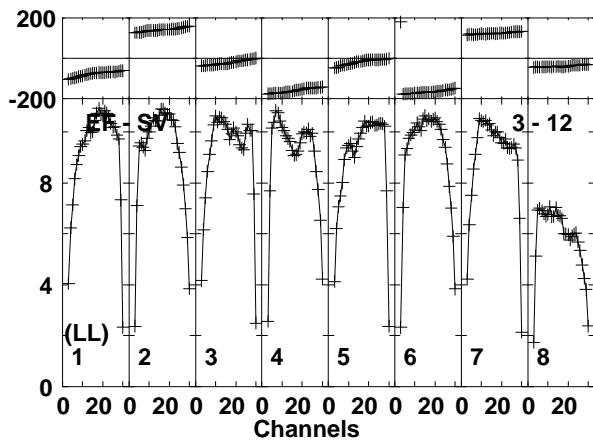
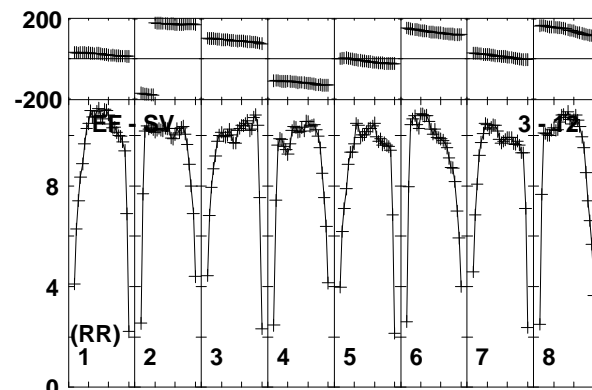
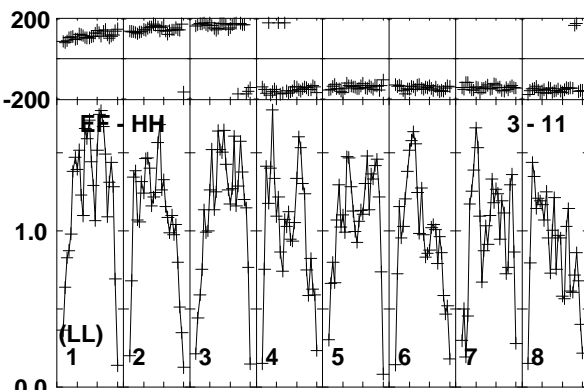
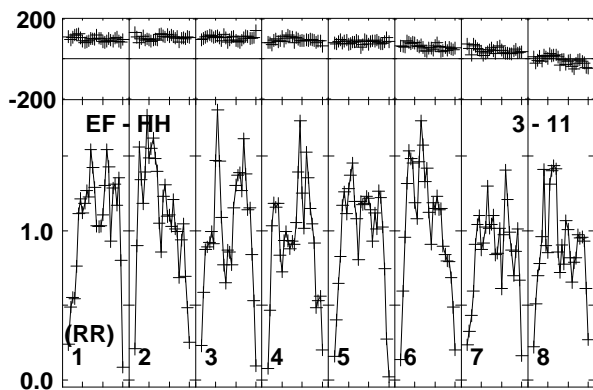
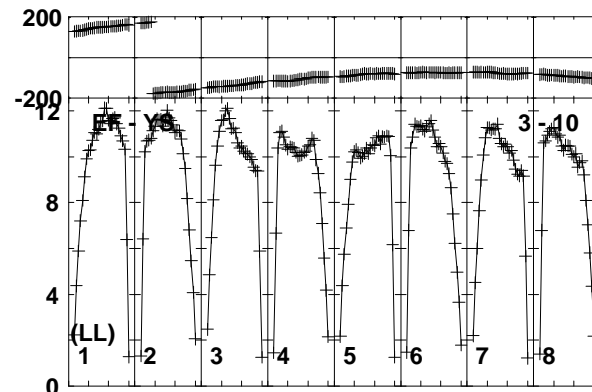
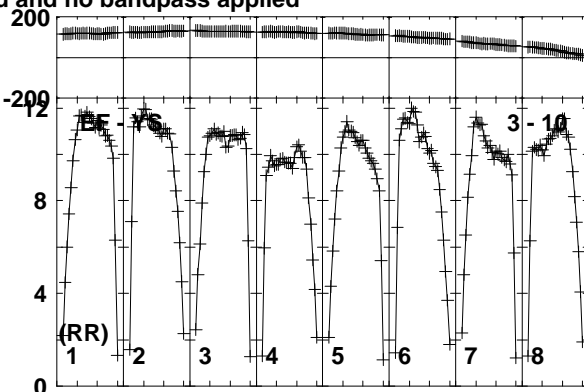
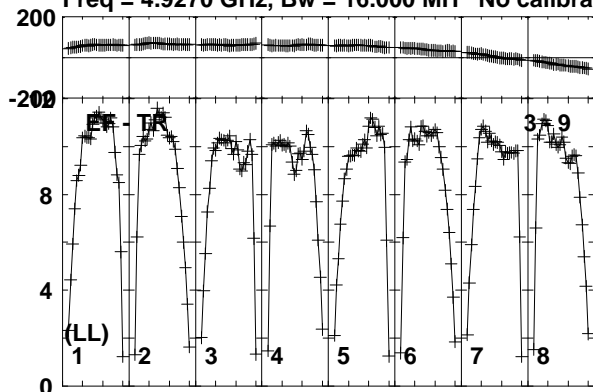

Lower frame: Milli Ampl Jy Top frame: Phas deg  
Vector averaged cross-power spectrum Baseline: EF (03) - TR (09)  
Timerange: 00/10:21:01 to 00/10:21:59

Plot file version 228 created 19-DEC-2018 17:58:27

J1619+2247 RY007C.UVDATA.1

Freq = 4.9270 GHz, Bw = 16.000 MH No calibration applied and no bandpass applied

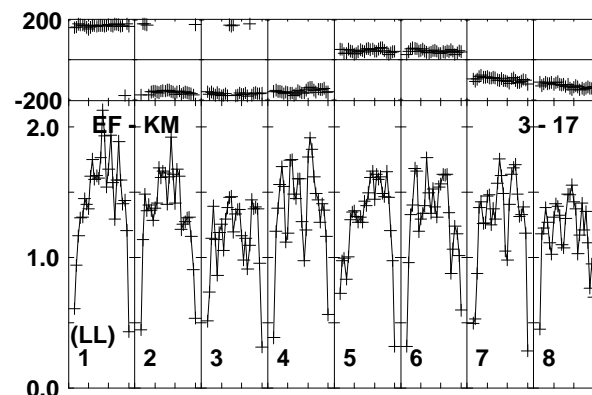
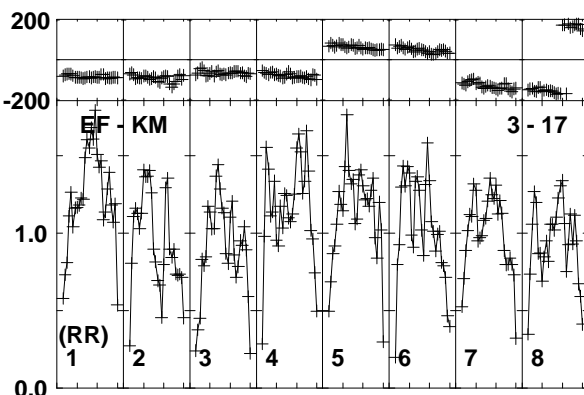
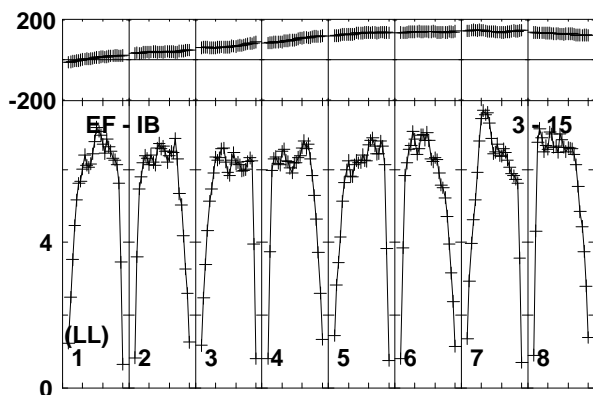
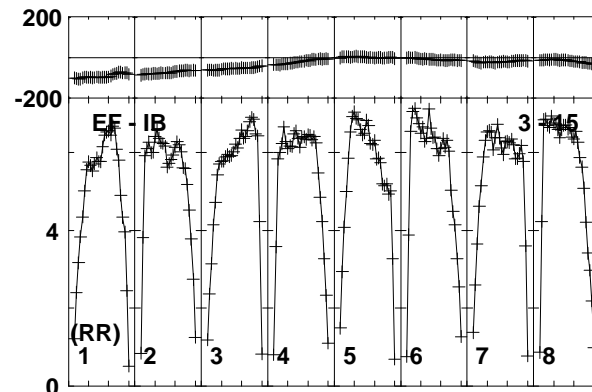
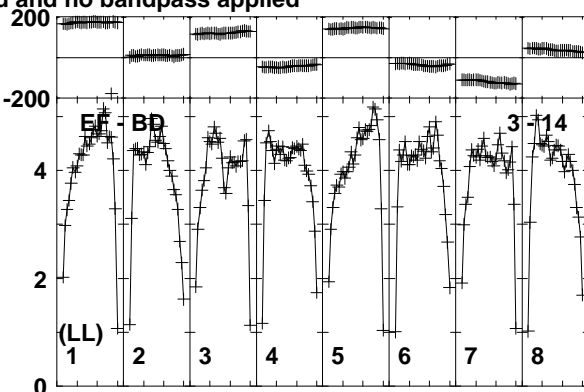
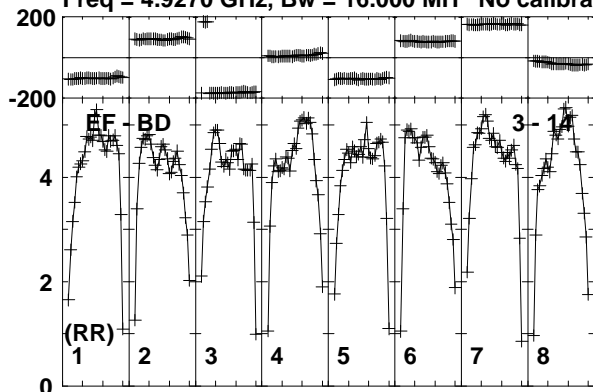

Lower frame: Milli Ampl Jy Top frame: Phas deg  
Vector averaged cross-power spectrum Baseline: EF (03) - BD (14)  
Timerange: 00/10:21:01 to 00/10:21:59

Plot file version 229 created 19-DEC-2018 17:58:27

AT2018\_RY007C.UVDATA.1

Freq = 4.9270 GHz, Bw = 16.000 MH No calibration applied and no bandpass applied

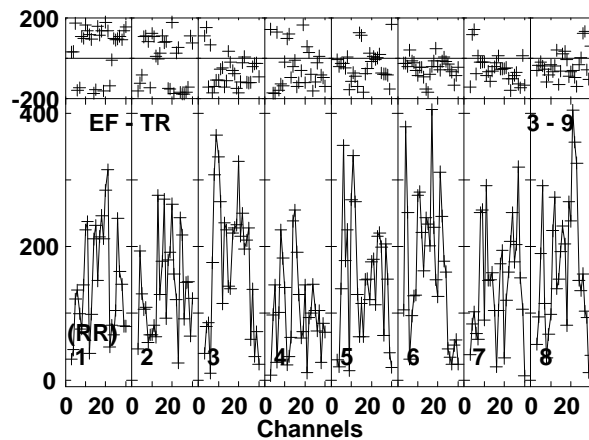
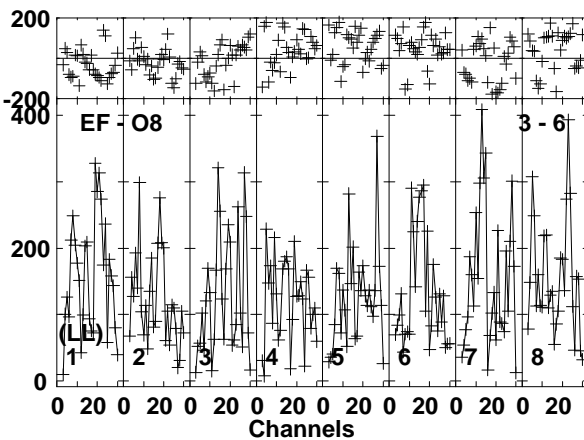
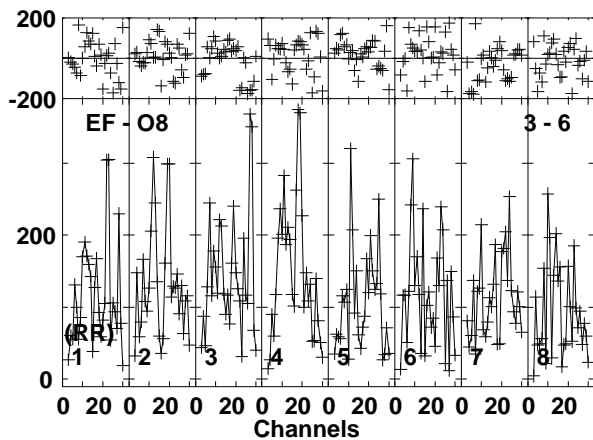
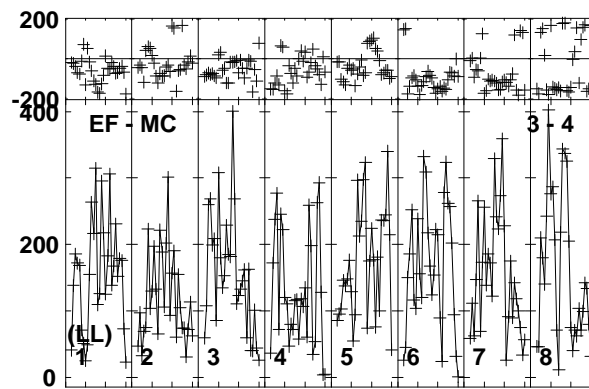
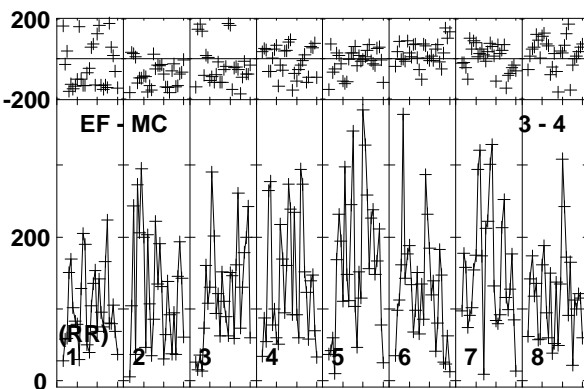
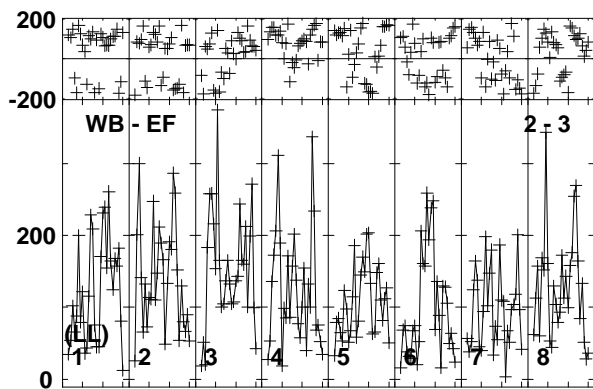
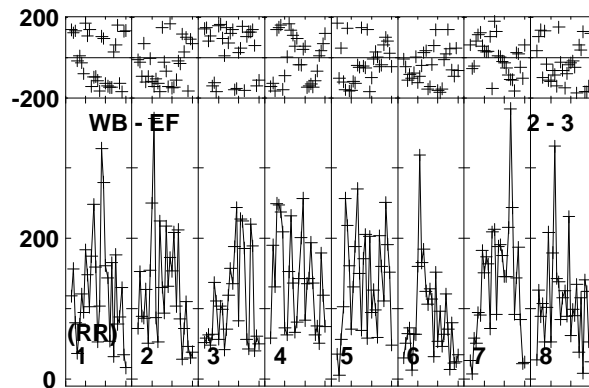
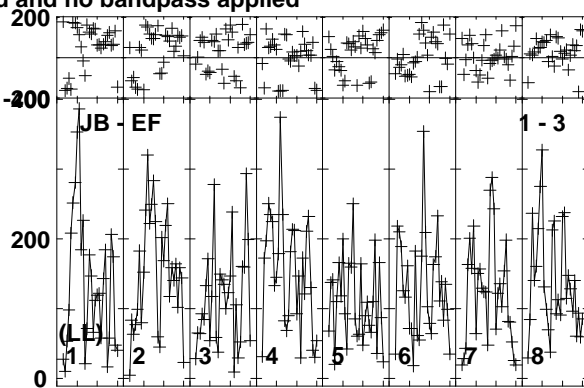
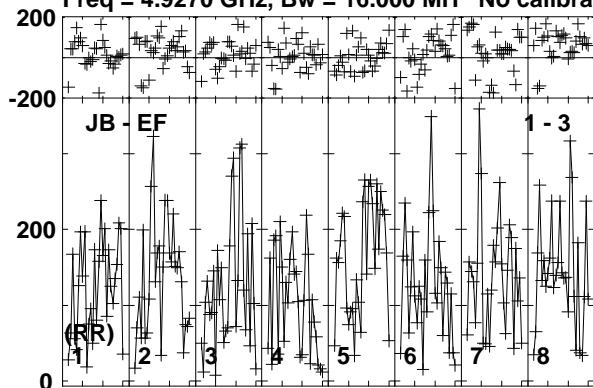

Lower frame: Micro Ampl Jy Top frame: Phas deg  
Vector averaged cross-power spectrum Baseline: JB (01) - EF (03)  
Timerange: 00/10/22:01 to 00/10/23:59

Plot file version 230 created 19-DEC-2018 17:58:27

AT2018\_RY007C.UVDATA.1

Freq = 4.9270 GHz, Bw = 16.000 MH No calibration applied and no bandpass applied

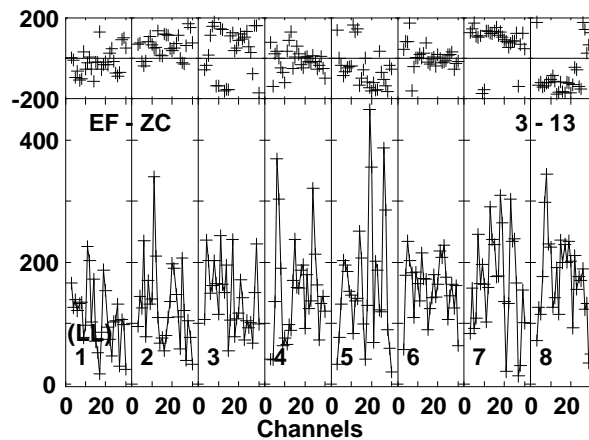
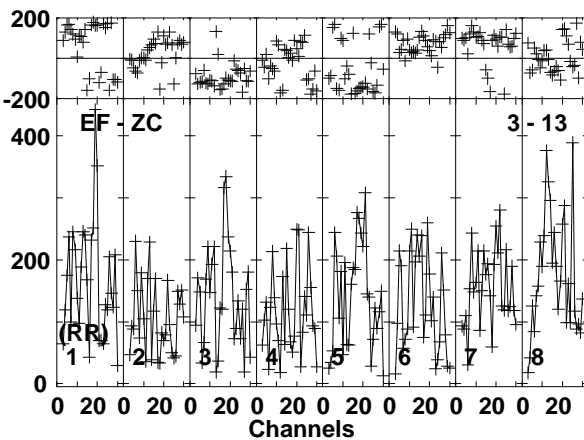
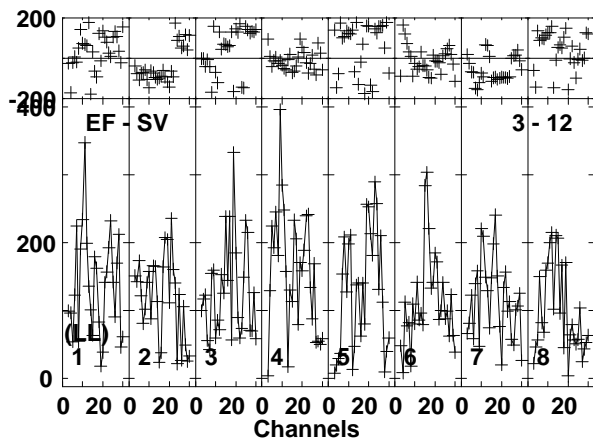
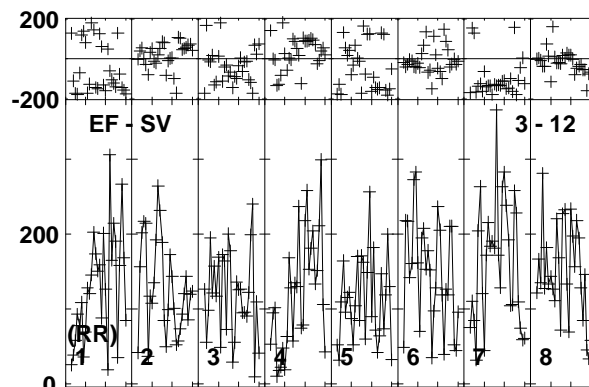
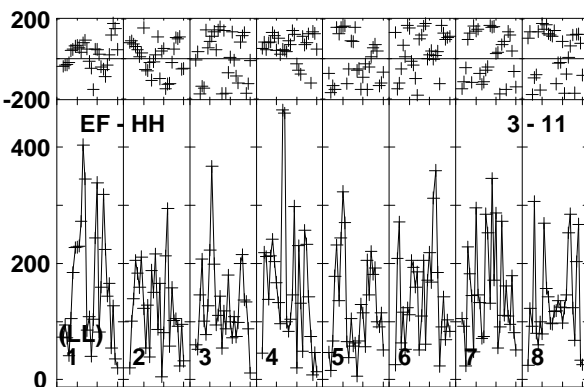
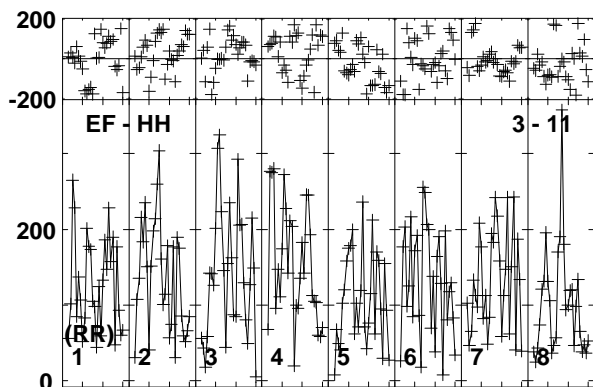
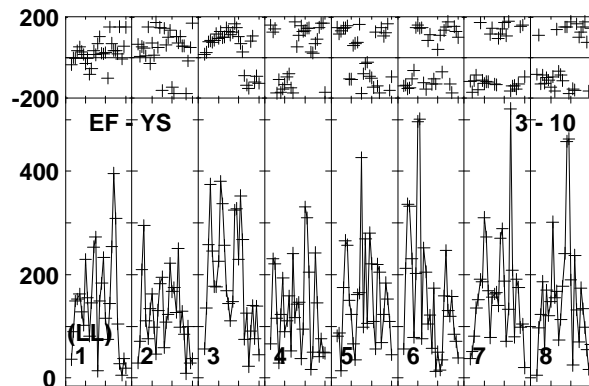
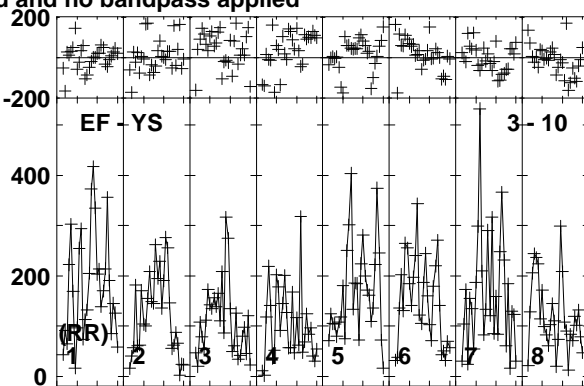
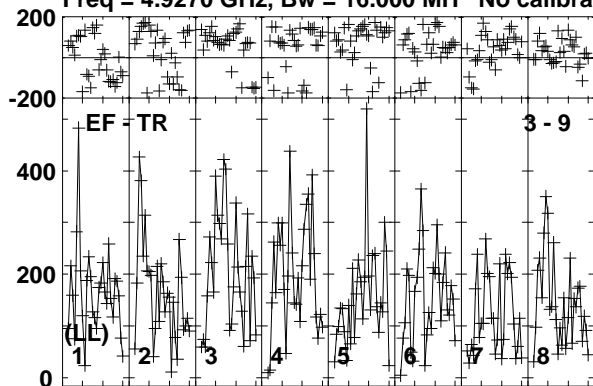

Lower frame: Micro Ampl Jy Top frame: Phas deg  
Vector averaged cross-power spectrum Baseline: EF (03) - TR (09)  
Timerange: 00/10:22:01 to 00/10:23:59

Plot file version 231 created 19-DEC-2018 17:58:27

AT2018\_RY007C.UVDATA.1

Freq = 4.9270 GHz, Bw = 16.000 MH No calibration applied and no bandpass applied

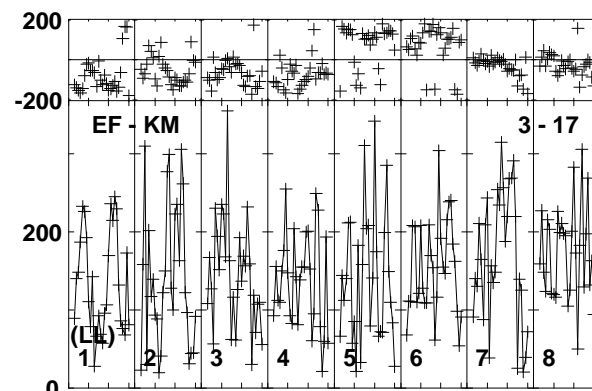
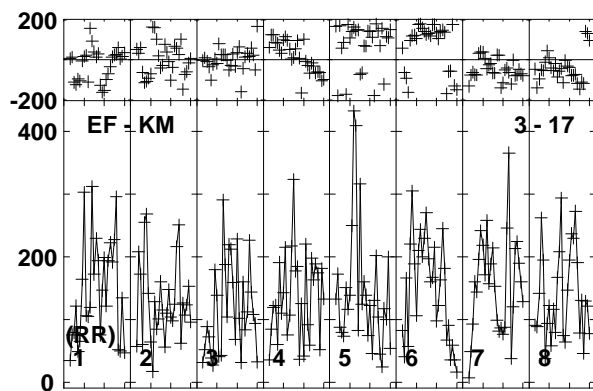
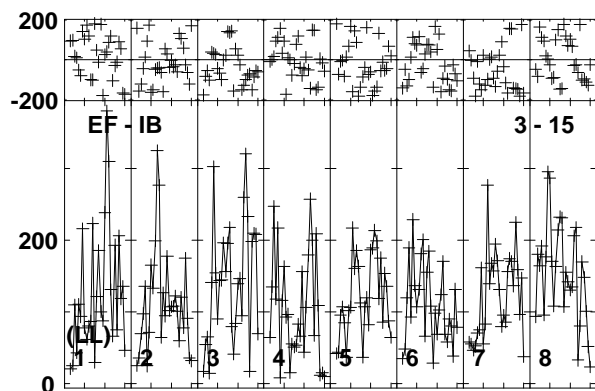
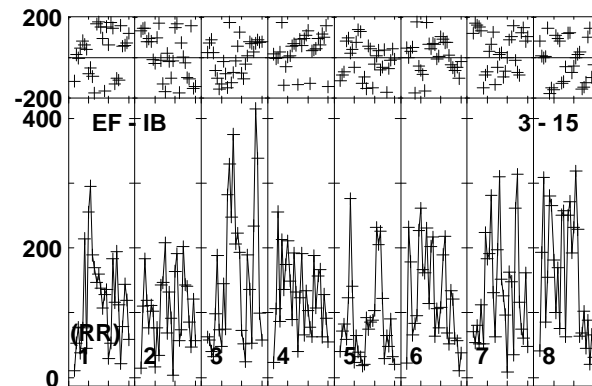
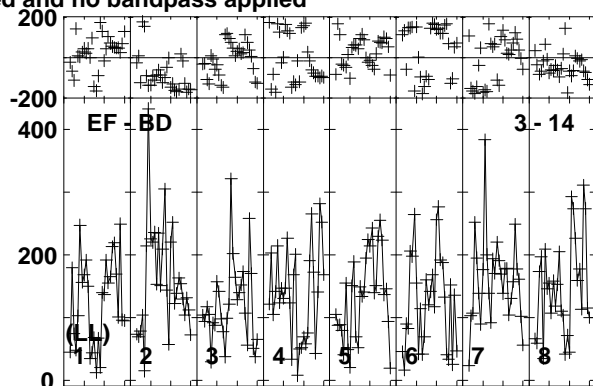
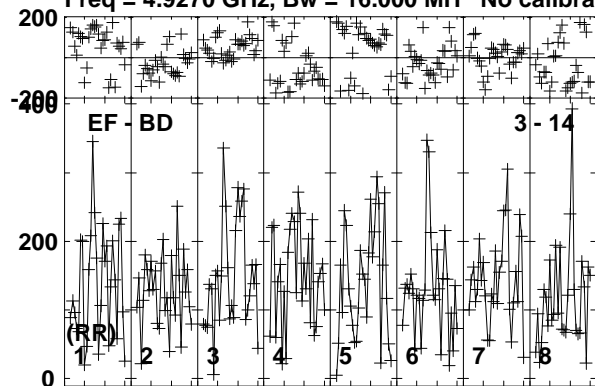

Lower frame: Micro Ampl Jy Top frame: Phas deg  
Vector averaged cross-power spectrum Baseline: EF (03) - BD (14)  
Timerange: 00/10:22:01 to 00/10:23:59

Plot file version 232 created 19-DEC-2018 17:58:27

VLA2 RY007C.UVDATA.1

Freq = 4.9270 GHz, Bw = 16.000 MH No calibration applied and no bandpass applied

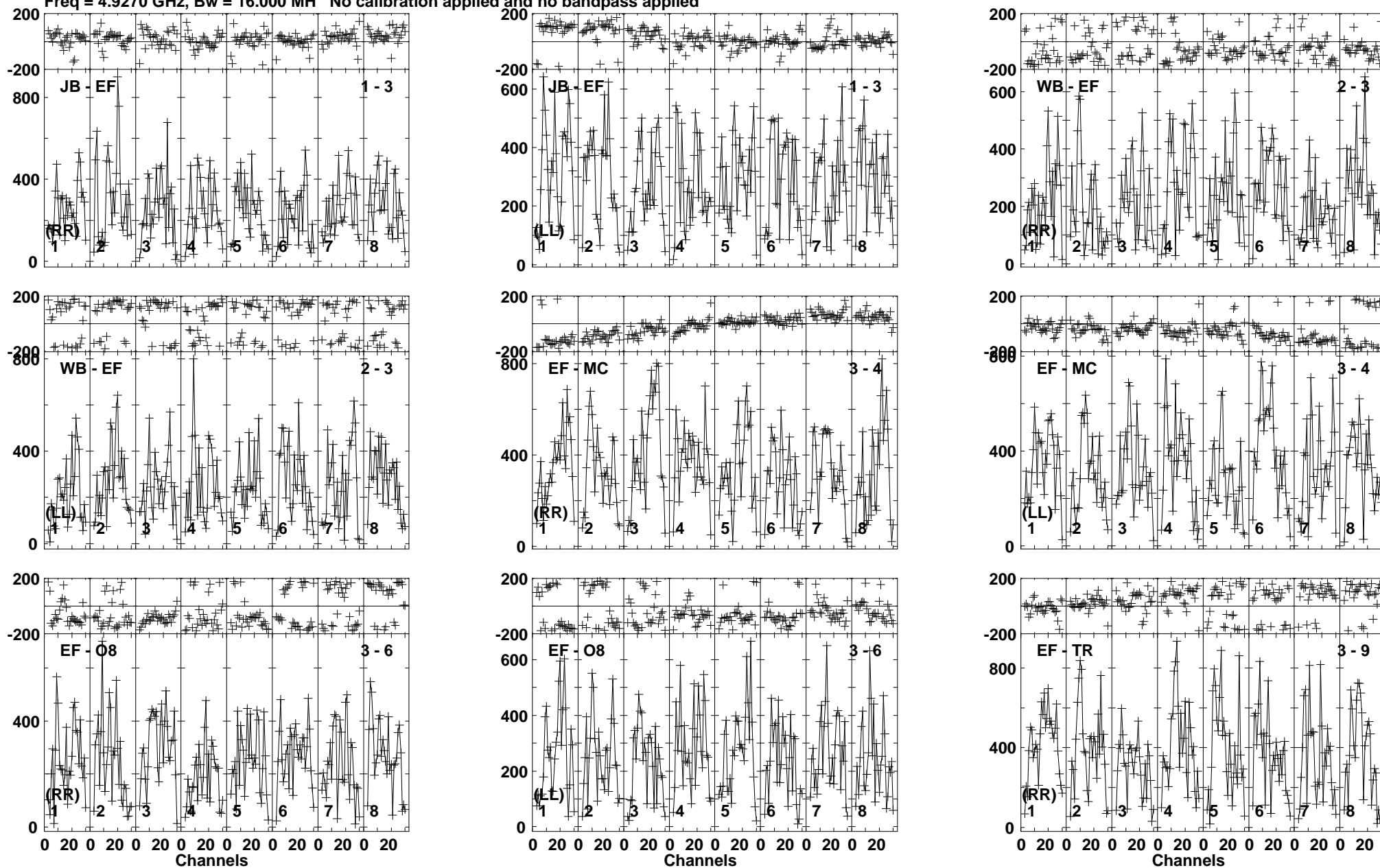

Lower frame: Micro Ampl Jy Top frame: Phas deg  
Vector averaged cross-power spectrum Baseline: JB (01) - EF (03)  
Timerange: 00/10:24:01 to 00/10:24:59

Plot file version 233 created 19-DEC-2018 17:58:27

VLA2\_RY007C.UVDATA.1

Freq = 4.9270 GHz, Bw = 16.000 MH No calibration applied and no bandpass applied

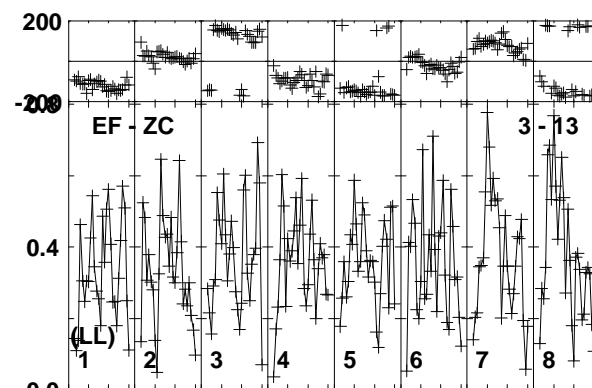
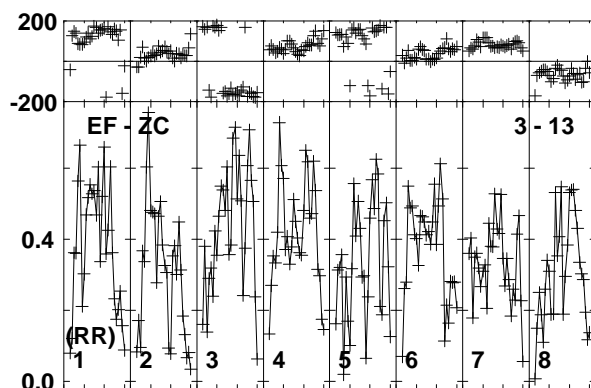
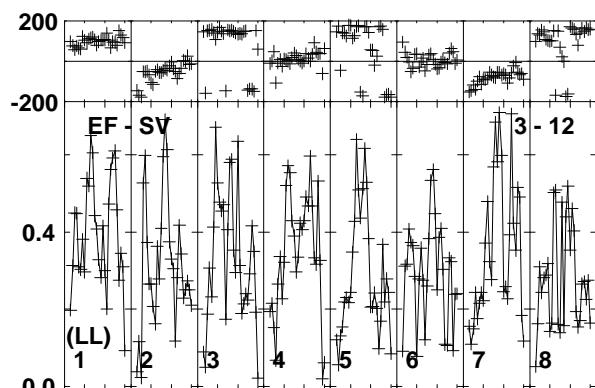
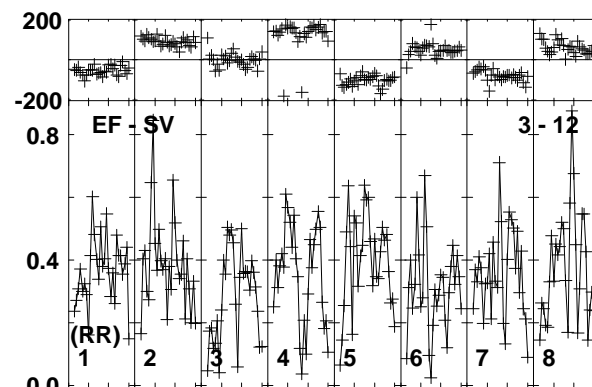
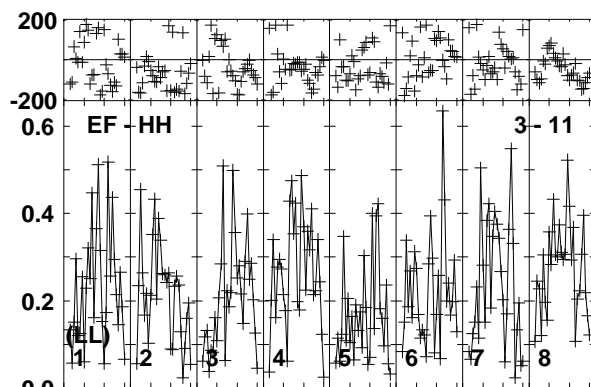
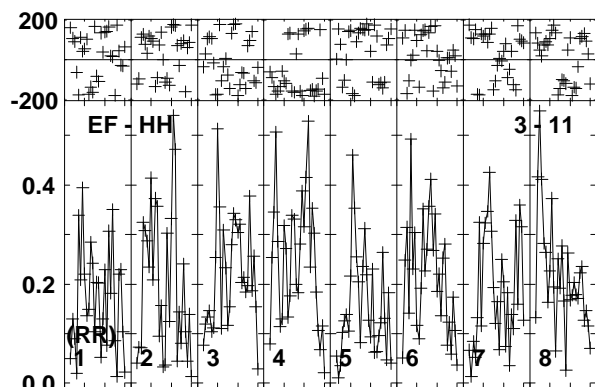
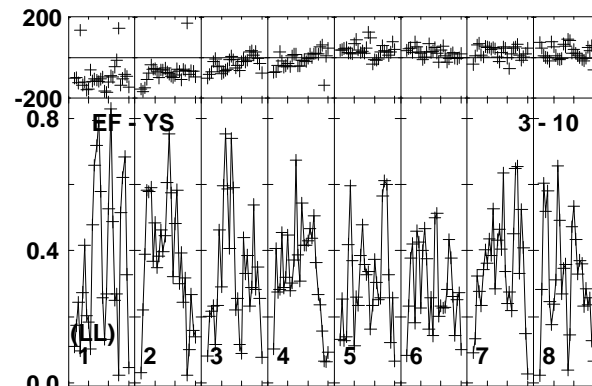
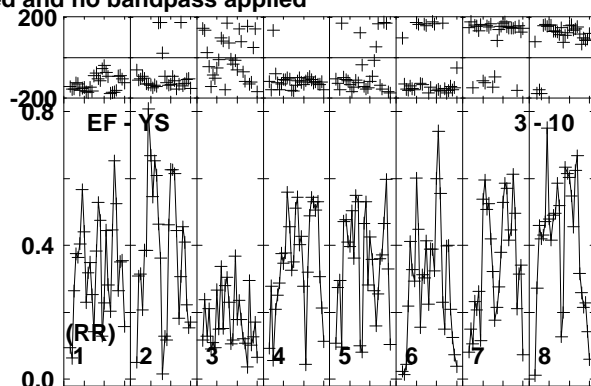
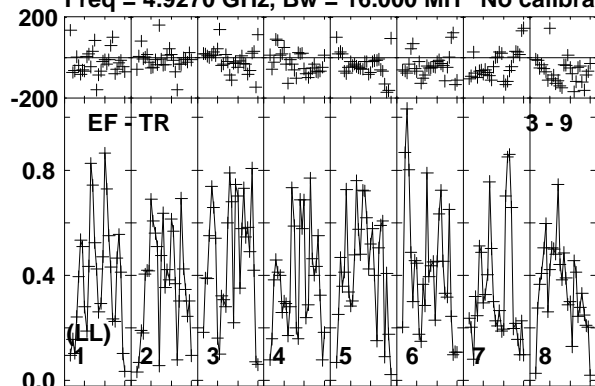

Lower frame: Milli Ampl Jy Top frame: Phas deg  
Vector averaged cross-power spectrum Baseline: EF (03) - TR (09)  
Timerange: 00/10:24:01 to 00/10:24:59

Plot file version 234 created 19-DEC-2018 17:58:27

VLA2 RY007C.UVDATA.1

Freq = 4.9270 GHz, Bw = 16.000 MH No calibration applied and no bandpass applied

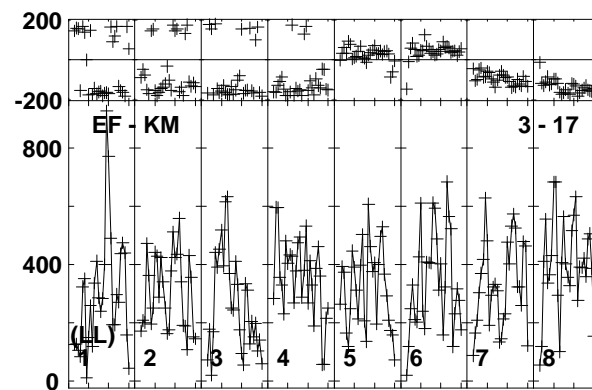
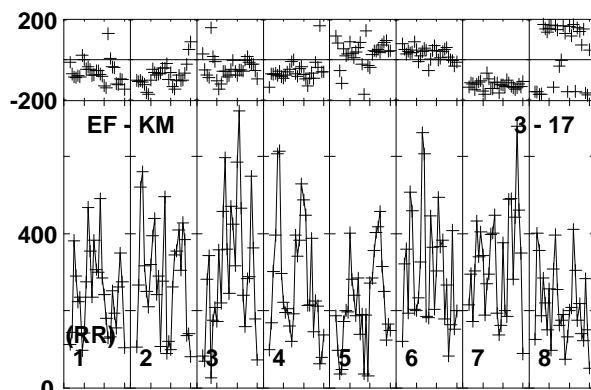
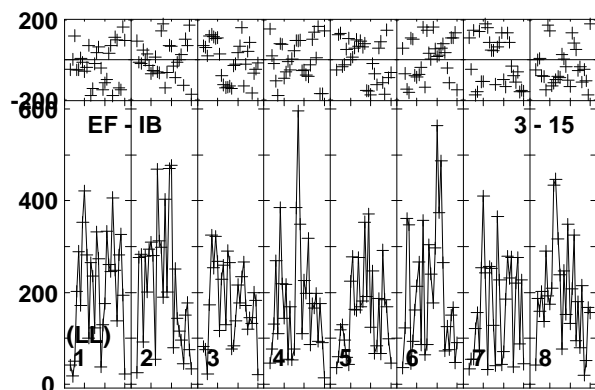
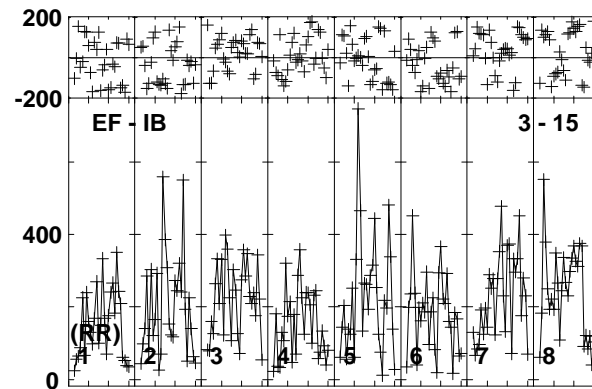
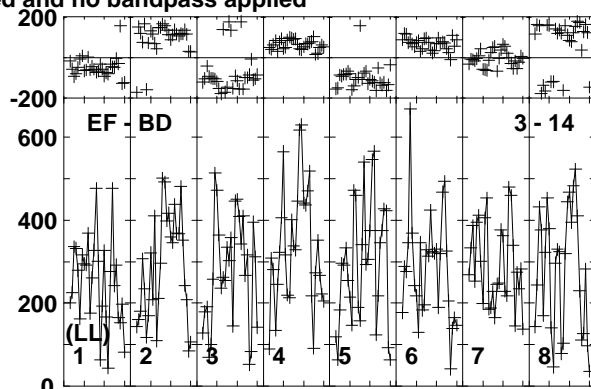
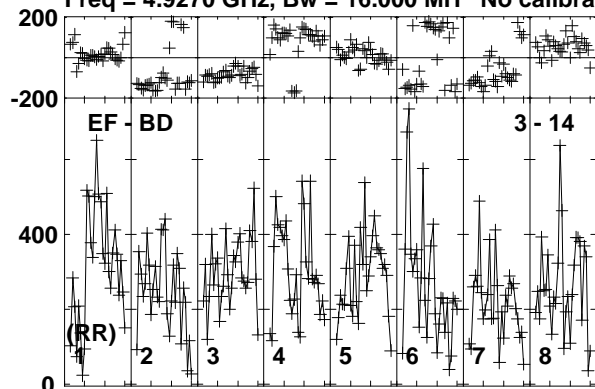

Lower frame: Micro Ampl Jy Top frame: Phas deg  
Vector averaged cross-power spectrum Baseline: EF (03) - BD (14)  
Timerange: 00/10:24:01 to 00/10:24:59



Plot file version 235 created 19-DEC-2018 17:58:27

J1619+2247 RY007C.UVDATA.1

Freq = 4.9270 GHz, Bw = 16.000 MH No calibration applied and no bandpass applied

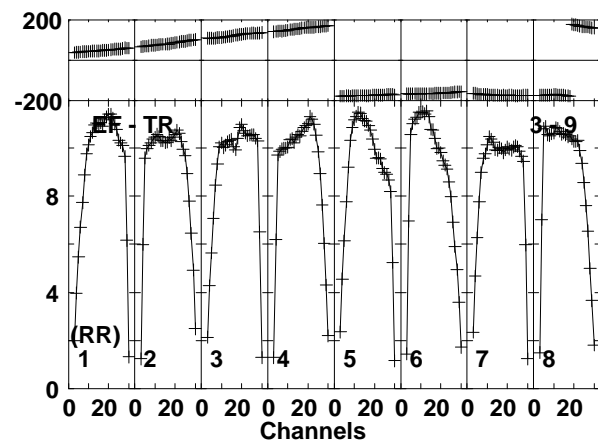
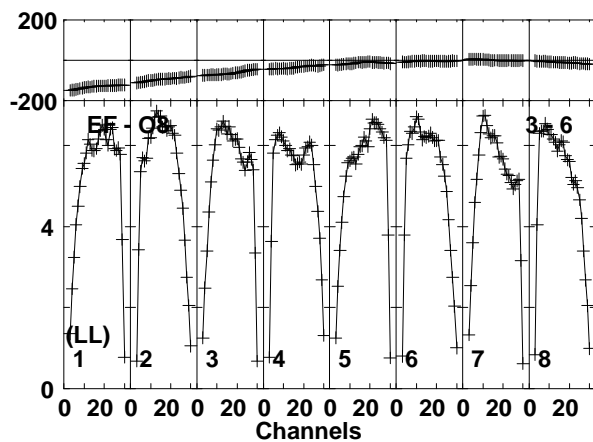
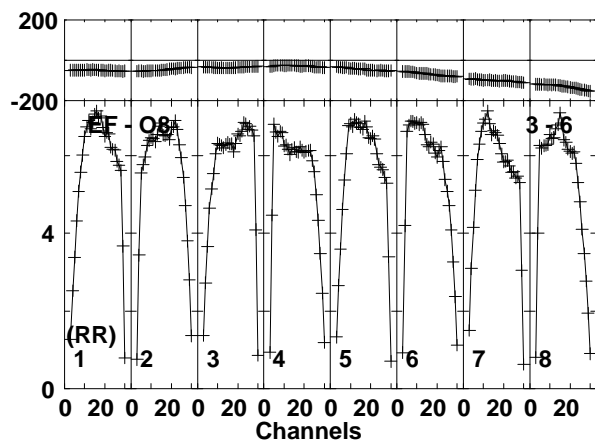
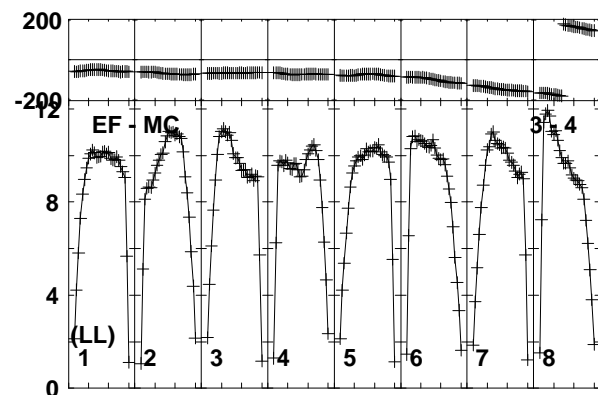
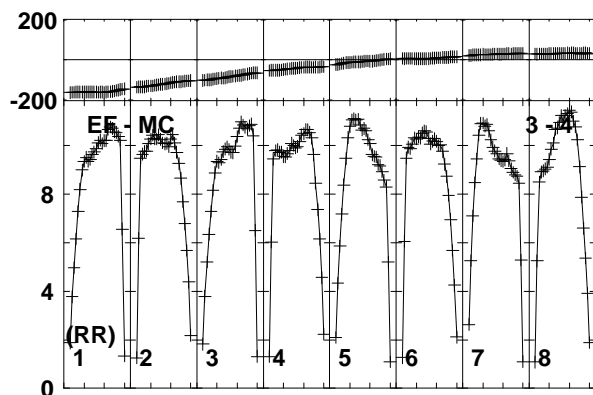
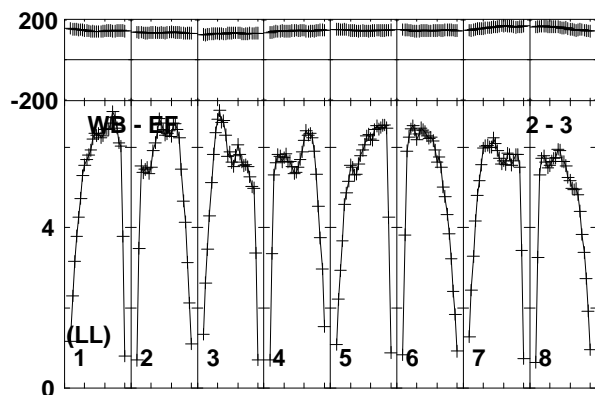
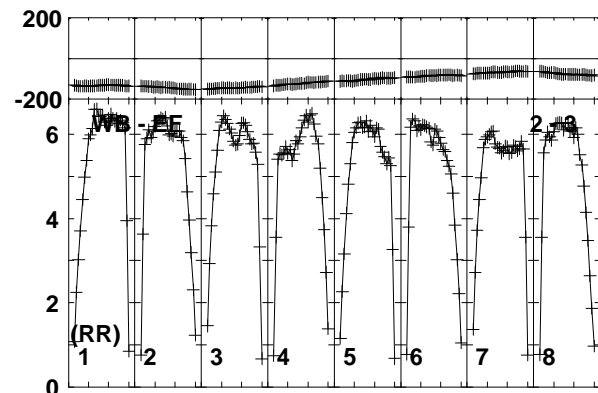
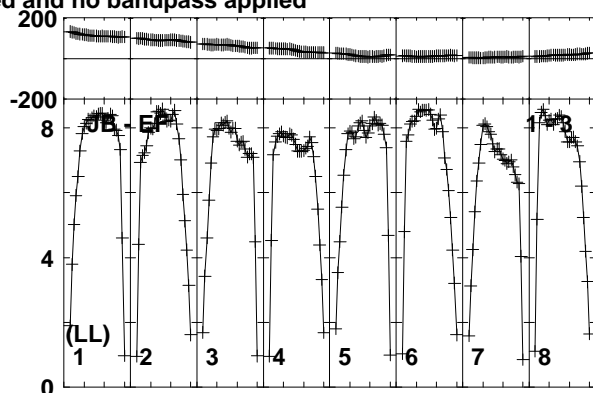
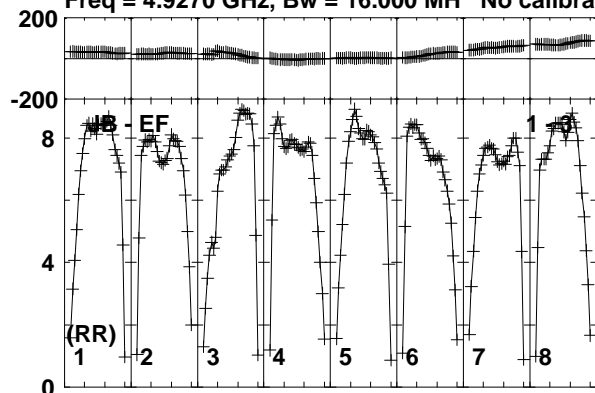

Lower frame: Milli Ampl Jy Top frame: Phas deg  
Vector averaged cross-power spectrum Baseline: JB (01) - EF (03)  
Timerange: 00/10:25:31 to 00/10:26:29

Plot file version 236 created 19-DEC-2018 17:58:27

J1619+2247 RY007C.UVDATA.1

Freq = 4.9270 GHz, Bw = 16.000 MH No calibration applied and no bandpass applied

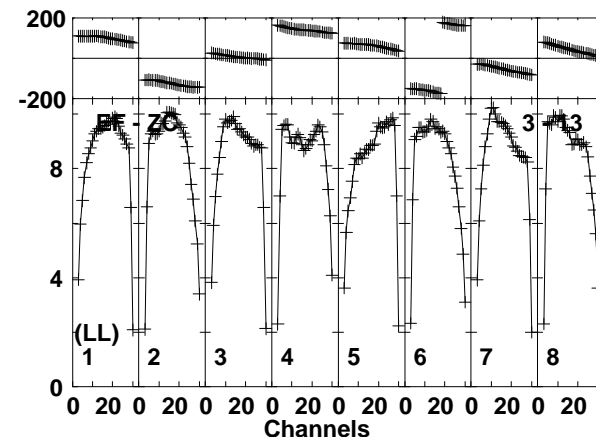
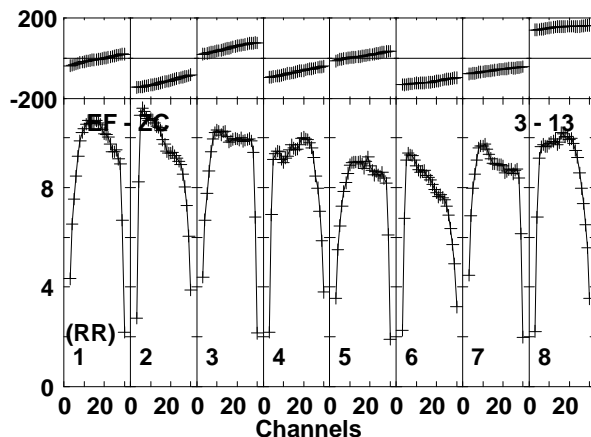
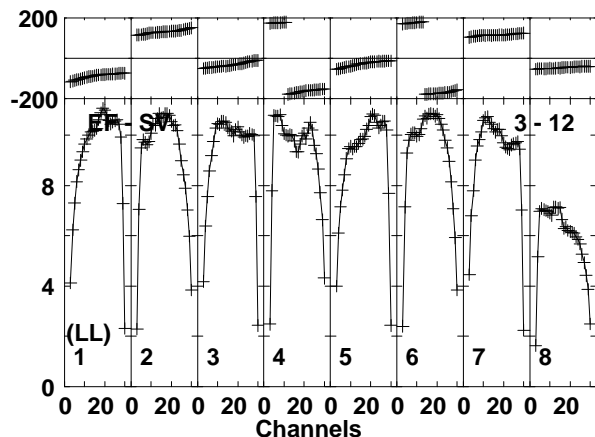
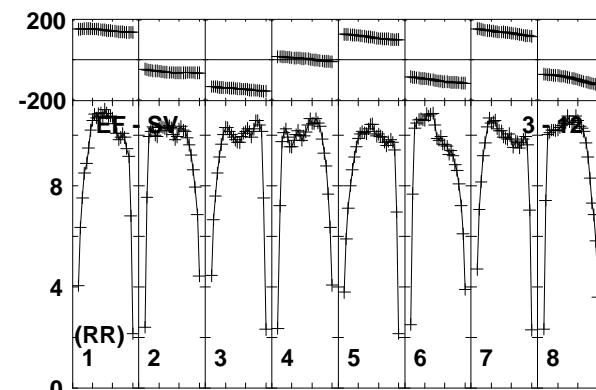
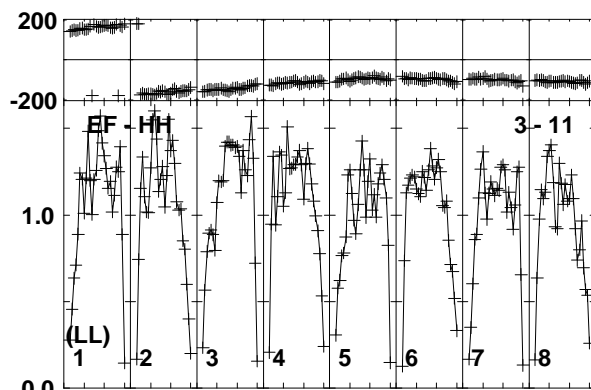
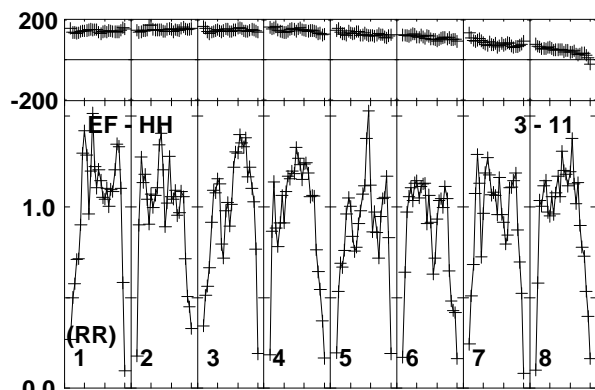
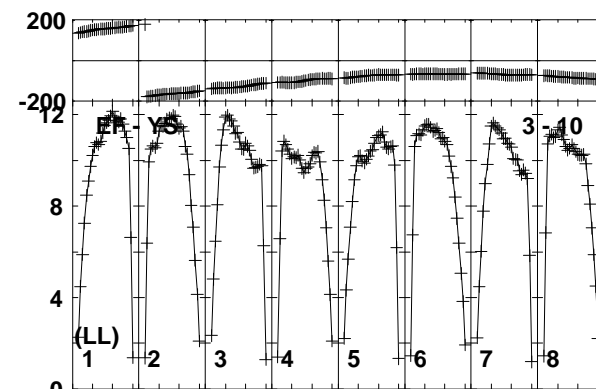
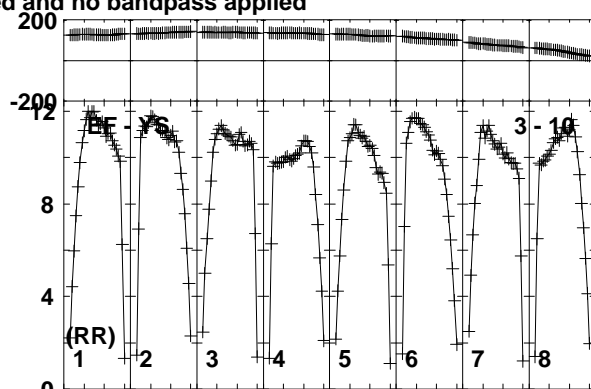
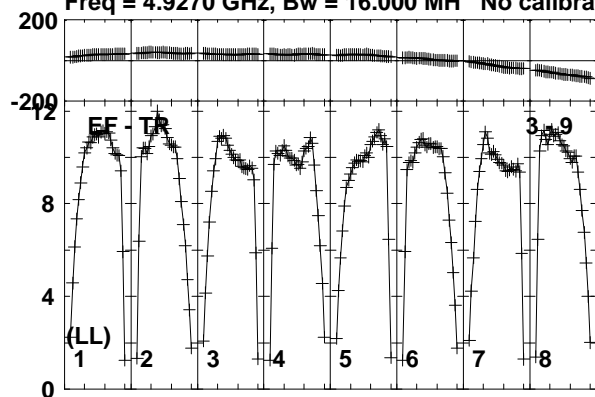

Lower frame: Milli Ampl Jy Top frame: Phas deg  
Vector averaged cross-power spectrum Baseline: EF (03) - TR (09)  
Timerange: 00/10:25:31 to 00/10:26:29

Plot file version 237 created 19-DEC-2018 17:58:27

J1619+2247 RY007C.UVDATA.1

Freq = 4.9270 GHz, Bw = 16.000 MH No calibration applied and no bandpass applied

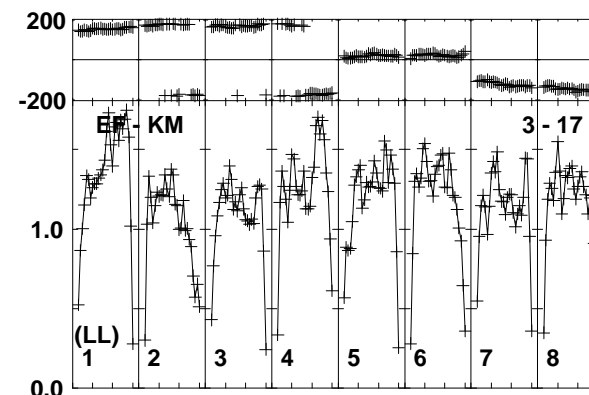
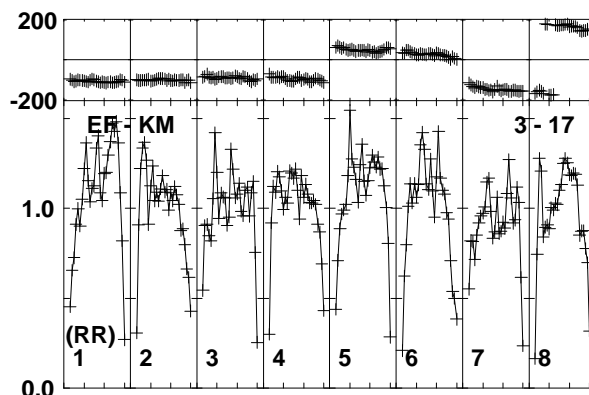
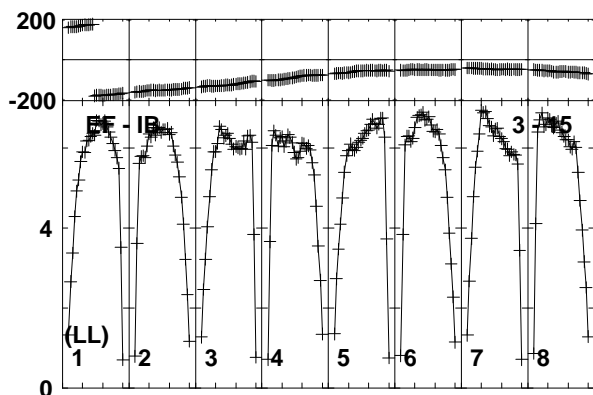
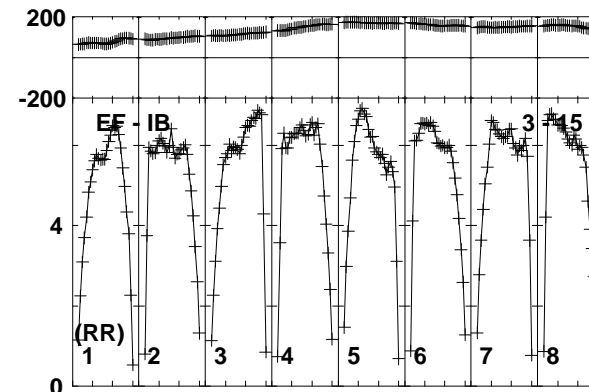
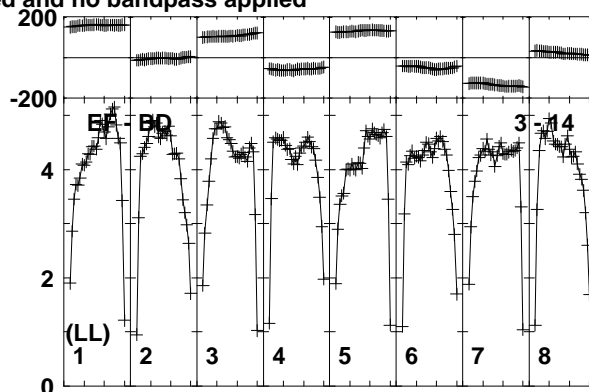
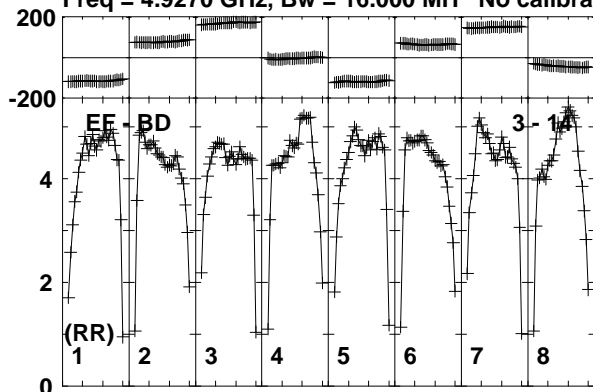

Lower frame: Milli Ampl Jy Top frame: Phas deg  
Vector averaged cross-power spectrum Baseline: EF (03) - BD (14)  
Timerange: 00/10:25:31 to 00/10:26:29

Plot file version 238 created 19-DEC-2018 17:58:27

AT2018\_RY007C.UVDATA.1

Freq = 4.9270 GHz, Bw = 16.000 MH No calibration applied and no bandpass applied

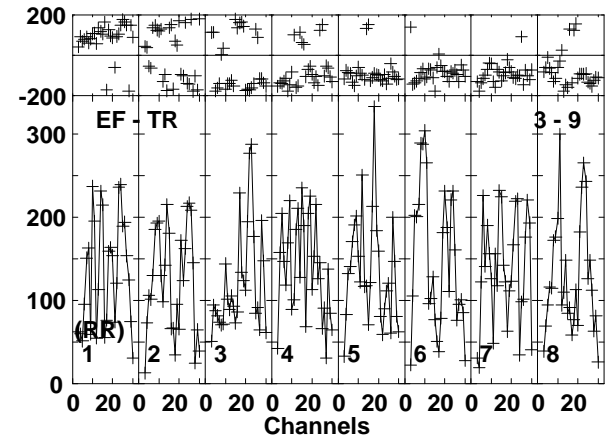
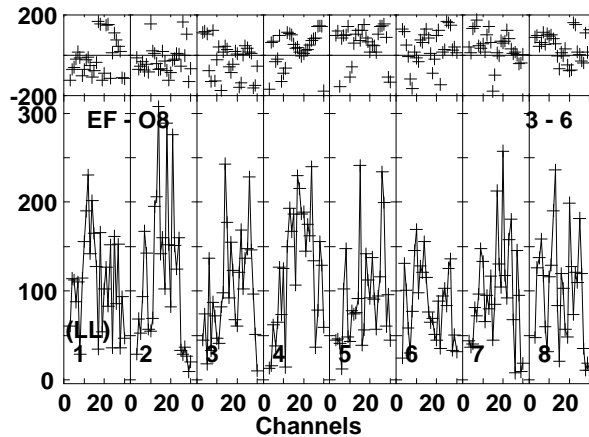
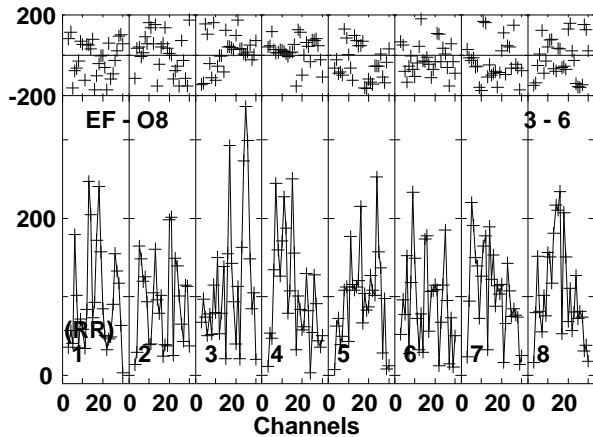
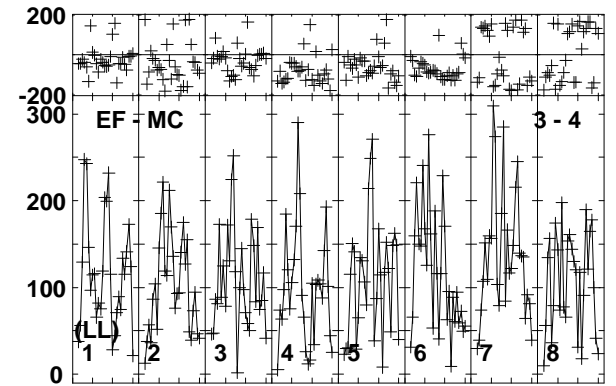
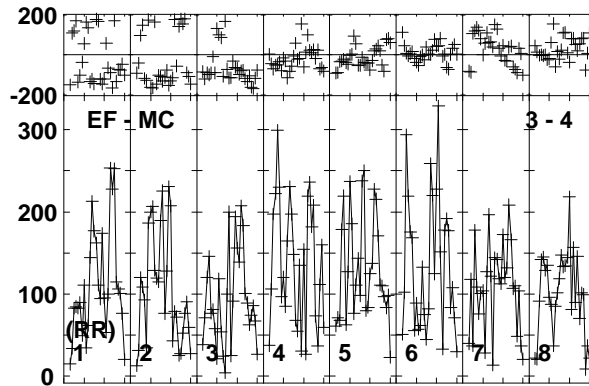
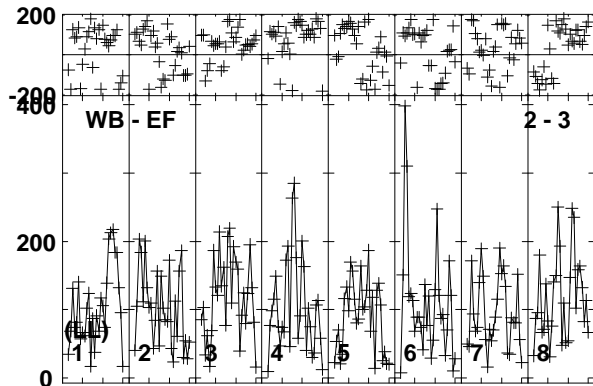
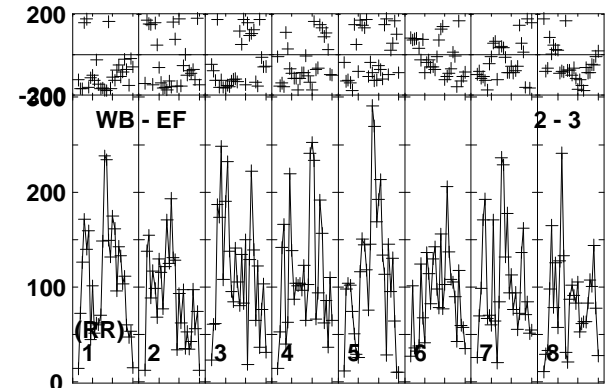
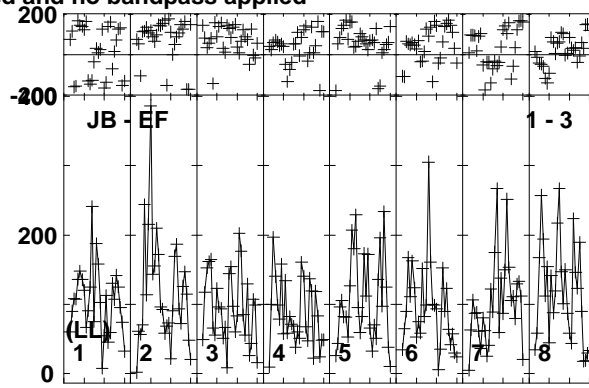
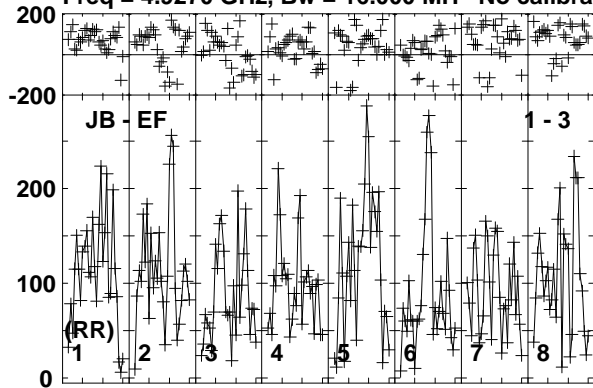

Lower frame: Micro Ampl Jy Top frame: Phas deg  
Vector averaged cross-power spectrum Baseline: JB (01) - EF (03)  
Timerange: 00/10:26:31 to 00/10:29:29

Plot file version 239 created 19-DEC-2018 17:58:27

AT2018\_RY007C.UVDATA.1

Freq = 4.9270 GHz, Bw = 16.000 MH No calibration applied and no bandpass applied

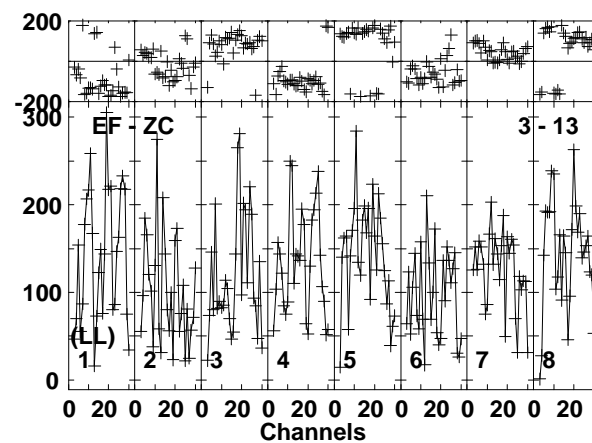
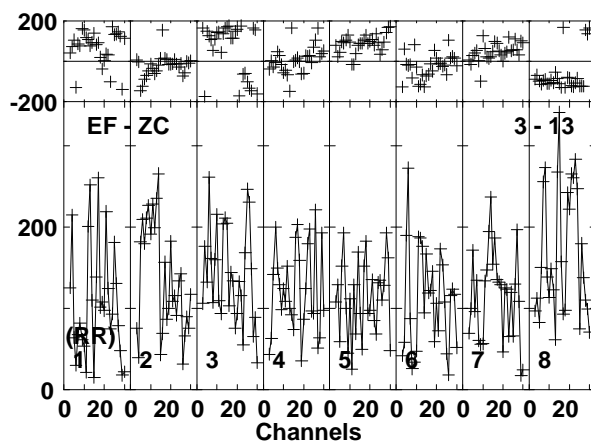
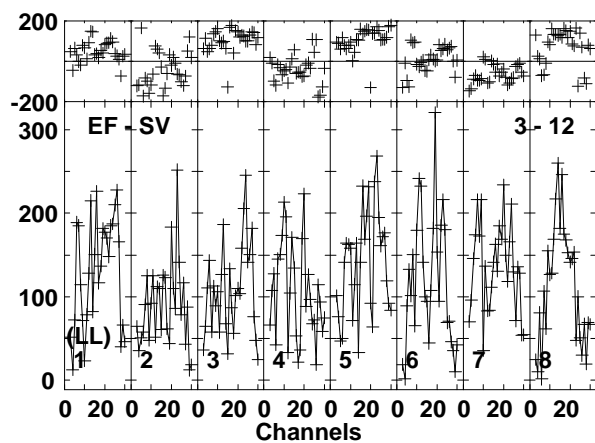
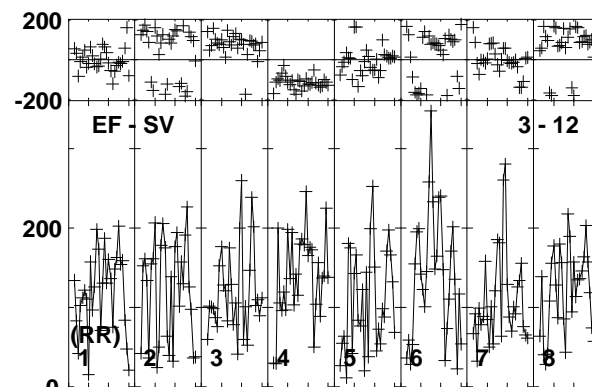
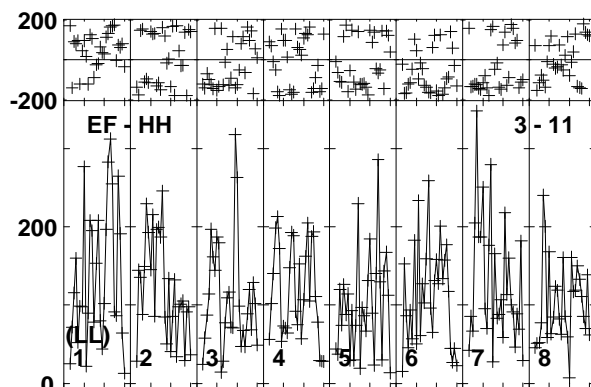
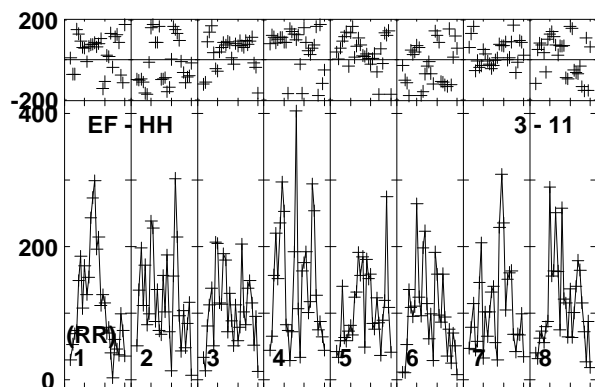
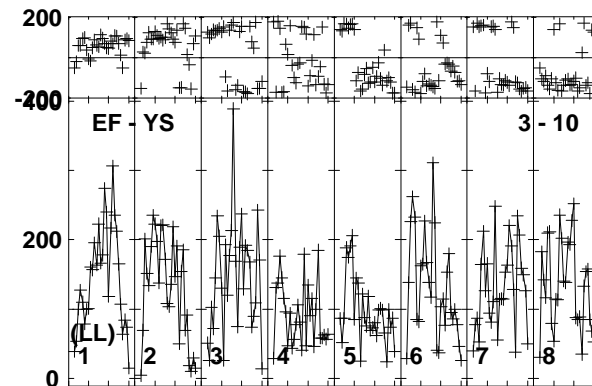
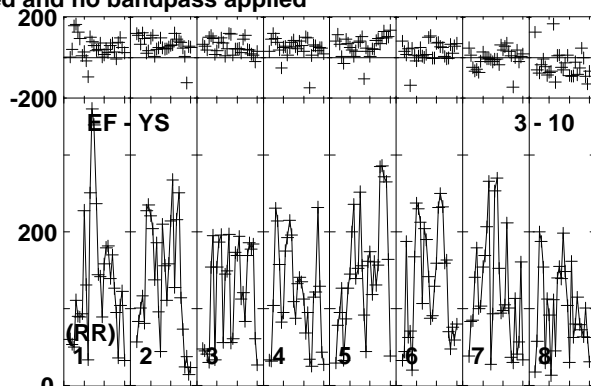
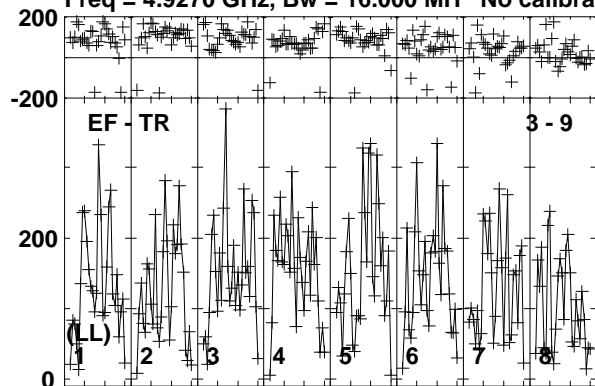

Lower frame: Micro Ampl Jy Top frame: Phas deg  
Vector averaged cross-power spectrum Baseline: EF (03) - TR (09)  
Timerange: 00/10:26:31 to 00/10:29:29

Plot file version 240 created 19-DEC-2018 17:58:27

AT2018\_RY007C.UVDATA.1

Freq = 4.9270 GHz, Bw = 16.000 MH No calibration applied and no bandpass applied

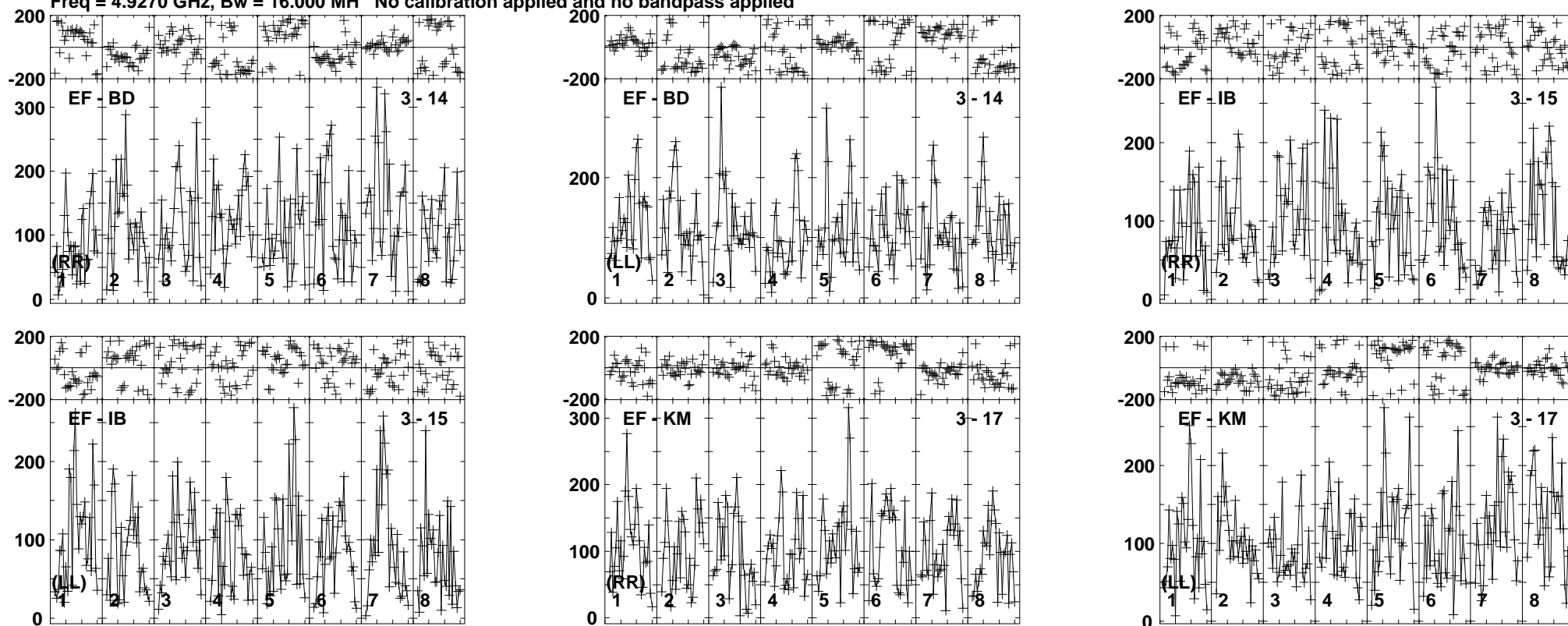

Lower frame: Micro Ampl Jy Top frame: Phas deg  
Vector averaged cross-power spectrum Baseline: EF (03) - BD (14)  
Timerange: 00/10:26:31 to 00/10:29:29

Plot file version 241 created 19-DEC-2018 17:58:27

J1619+2247 RY007C.UVDATA.1

Freq = 4.9270 GHz, Bw = 16.000 MH No calibration applied and no bandpass applied

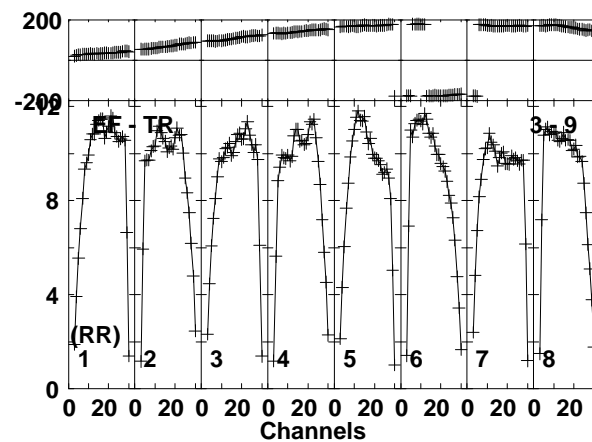
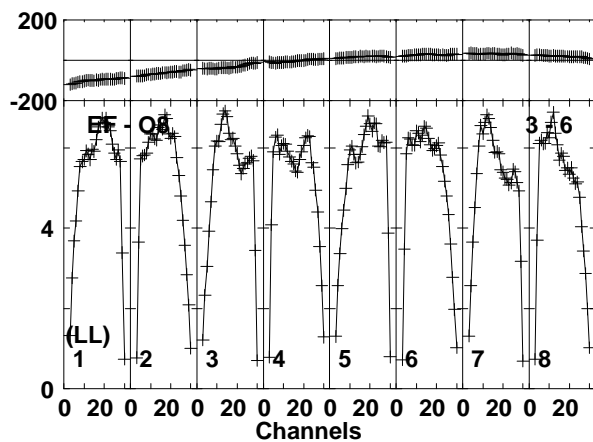
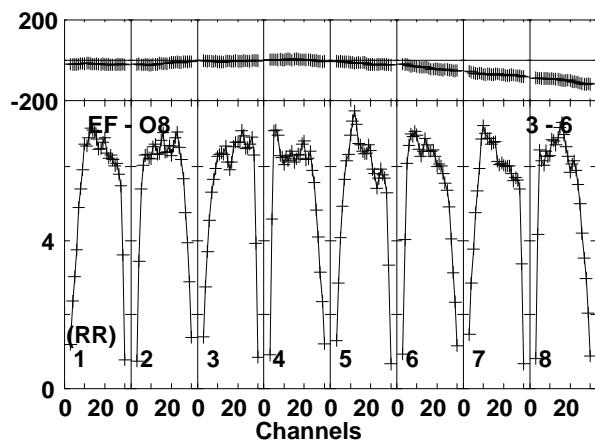
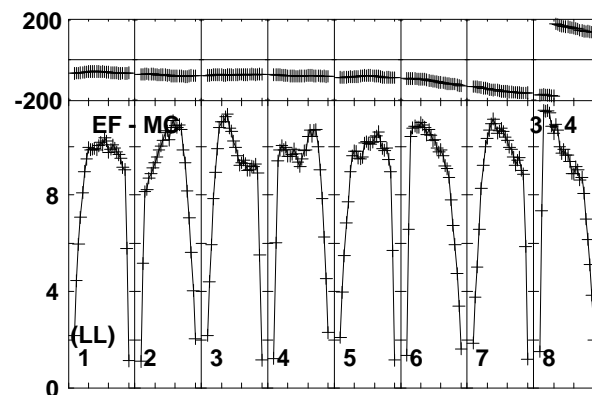
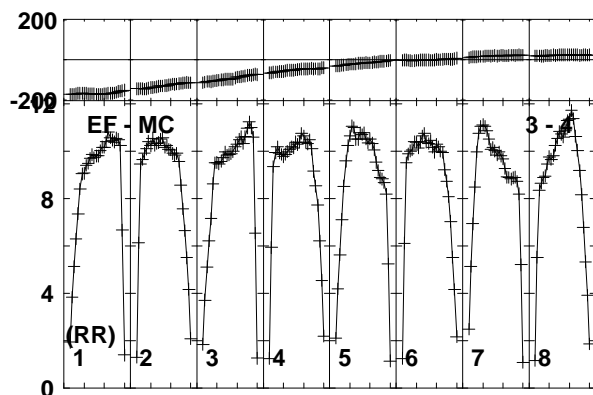
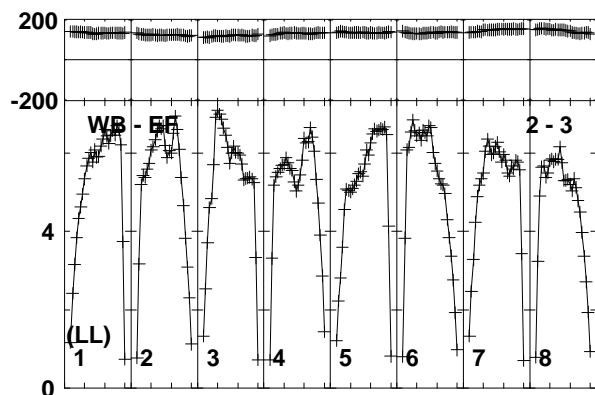
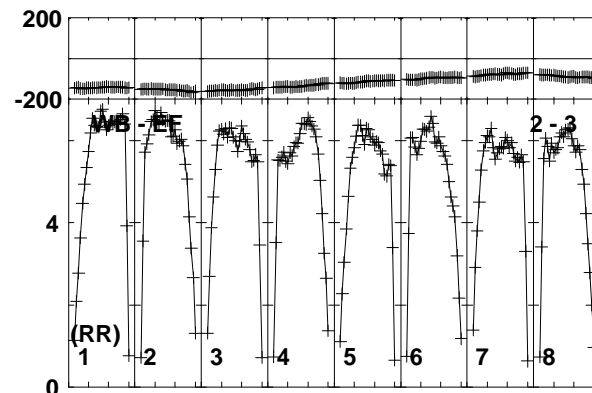
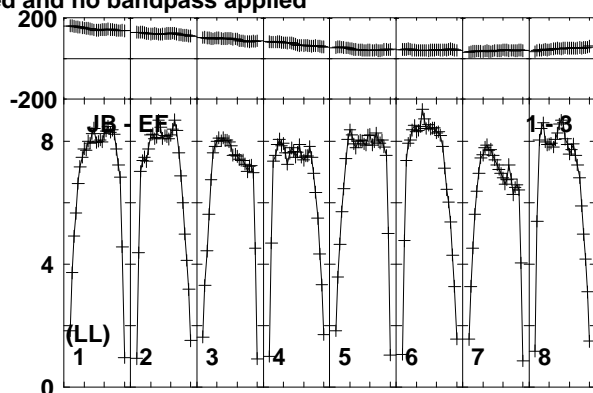
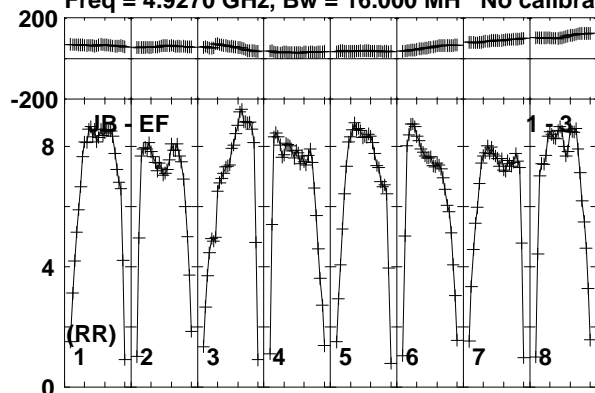

Lower frame: Milli Ampl Jy Top frame: Phas deg  
Vector averaged cross-power spectrum Baseline: JB (01) - EF (03)  
Timerange: 00/10:29:31 to 00/10:30:29

Plot file version 242 created 19-DEC-2018 17:58:27

J1619+2247 RY007C.UVDATA.1

Freq = 4.9270 GHz, Bw = 16.000 MH No calibration applied and no bandpass applied

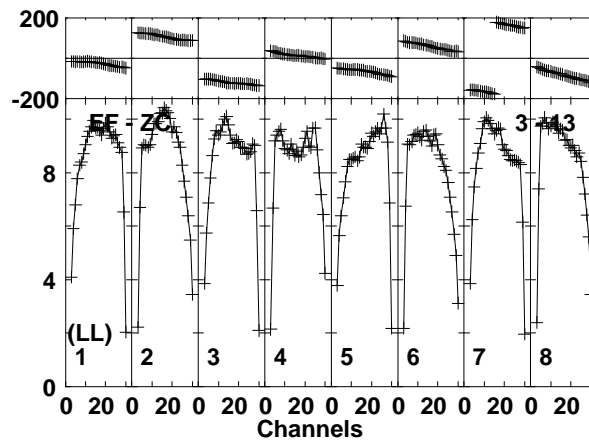
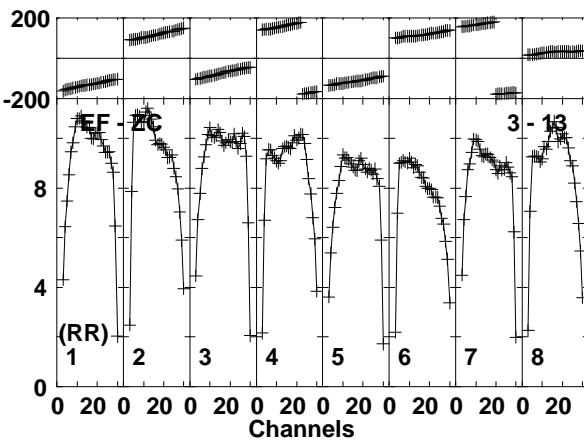
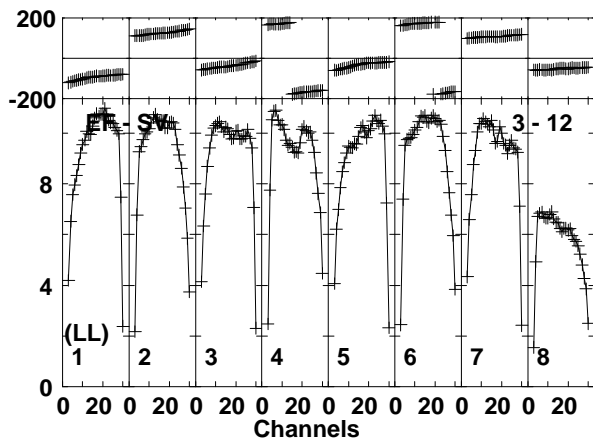
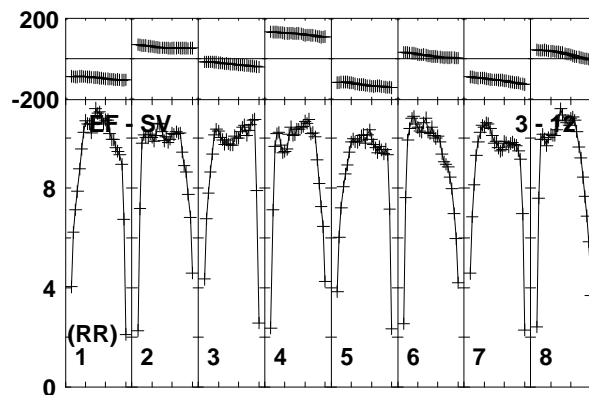
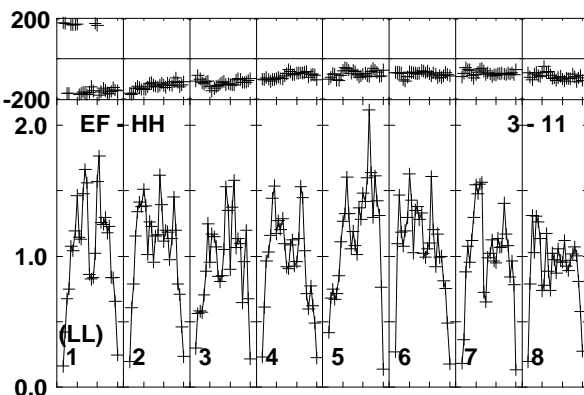
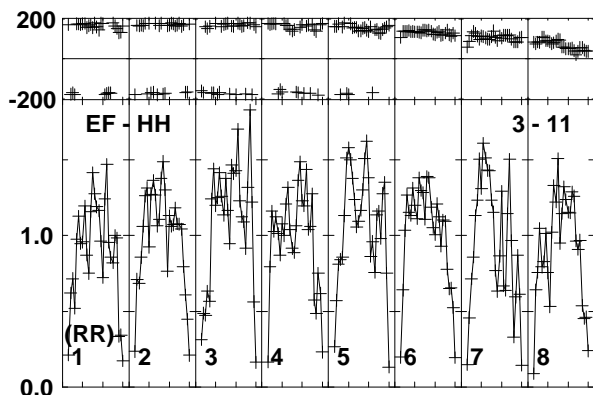
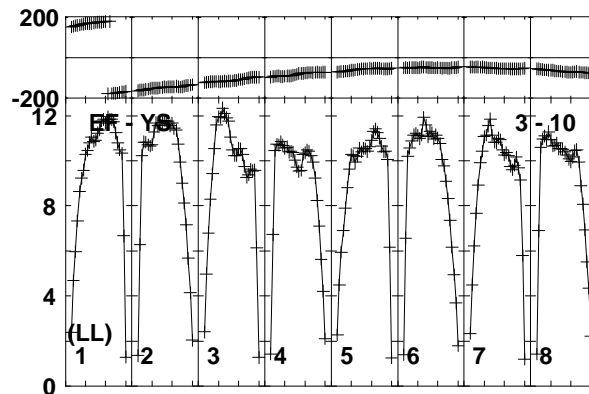
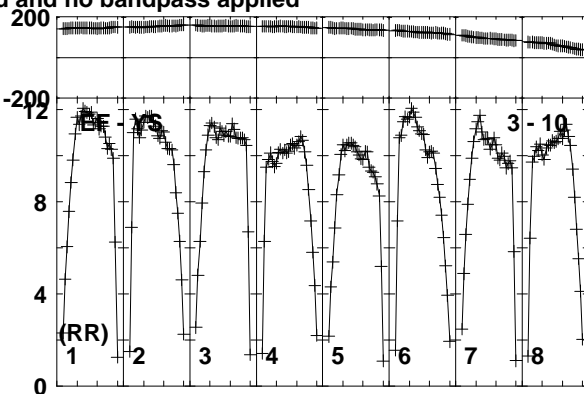
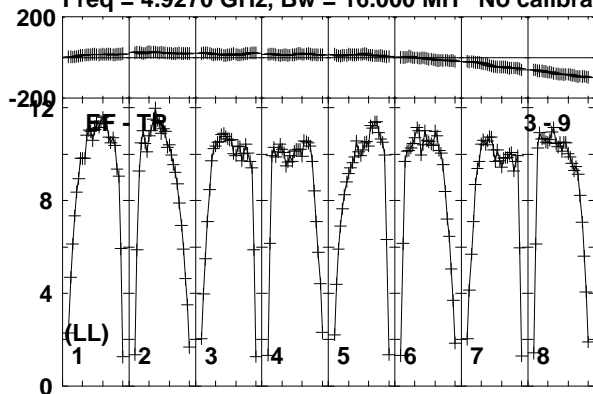

Lower frame: Milli Ampl Jy Top frame: Phas deg  
Vector averaged cross-power spectrum Baseline: EF (03) - TR (09)  
Timerange: 00/10:29:31 to 00/10:30:29



Plot file version 243 created 19-DEC-2018 17:58:27

J1619+2247 RY007C.UVDATA.1

Freq = 4.9270 GHz, Bw = 16.000 MH No calibration applied and no bandpass applied

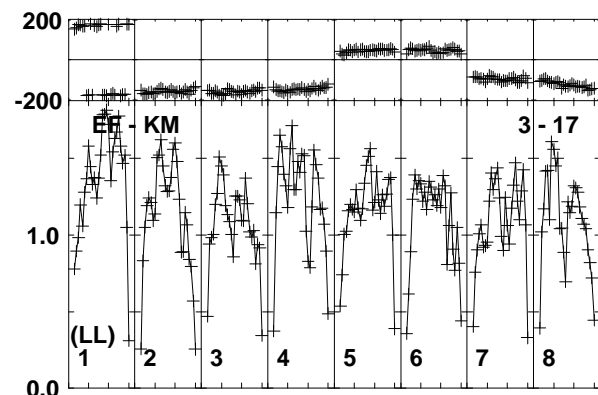
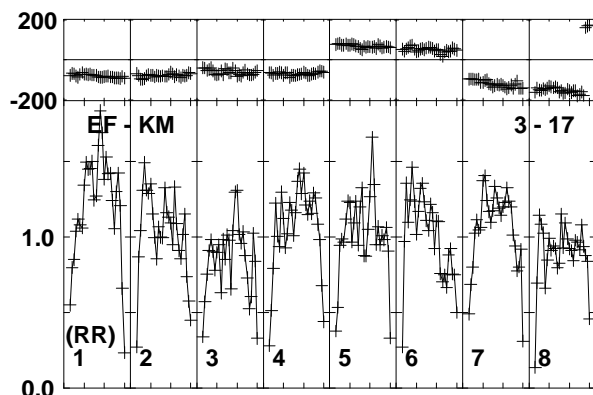
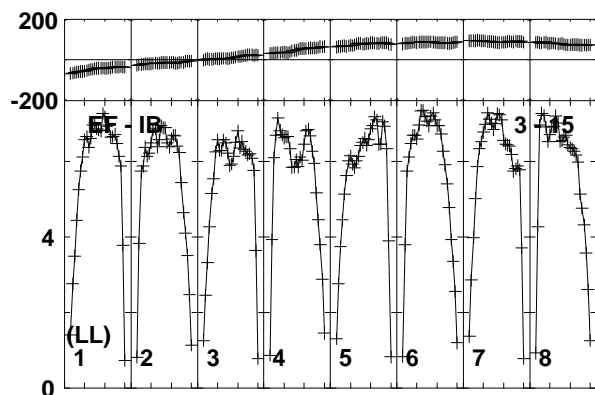
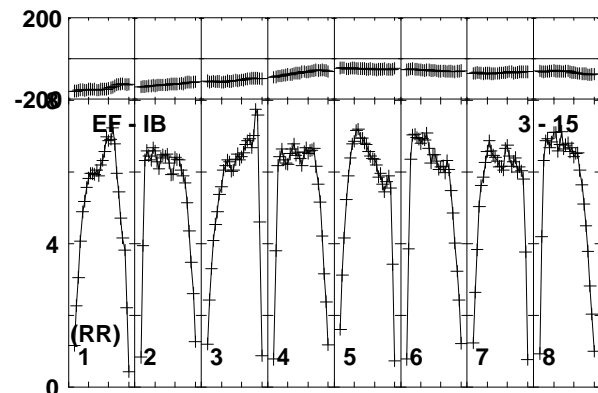
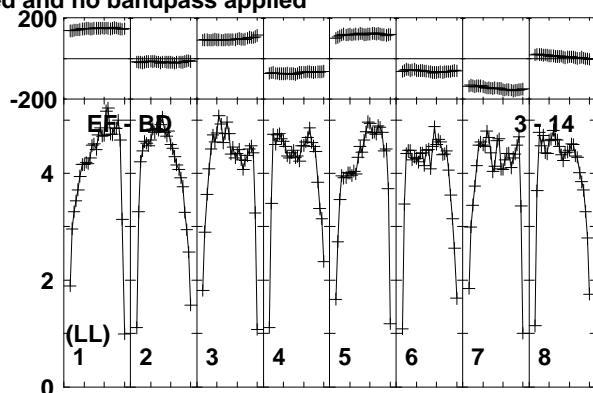
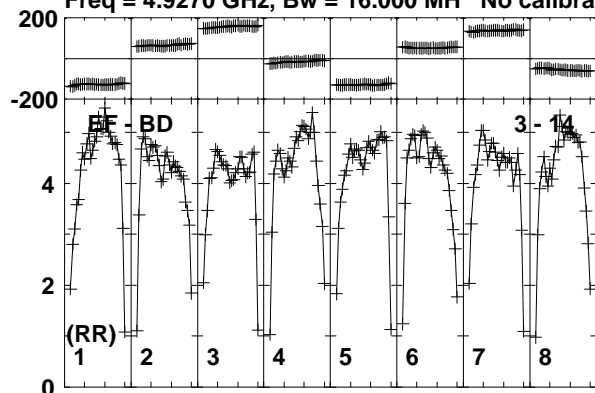

Lower frame: Milli Ampl Jy Top frame: Phas deg  
Vector averaged cross-power spectrum Baseline: EF (03) - BD (14)  
Timerange: 00/10:29:31 to 00/10:30:29

Plot file version 244 created 19-DEC-2018 17:58:27

AT2018\_RY007C.UVDATA.1

Freq = 4.9270 GHz, Bw = 16.000 MH No calibration applied and no bandpass applied

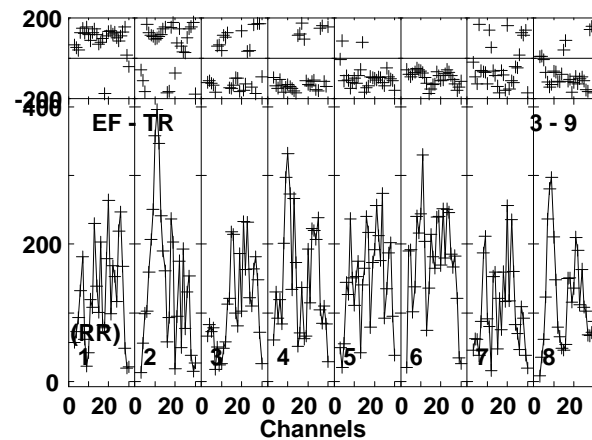
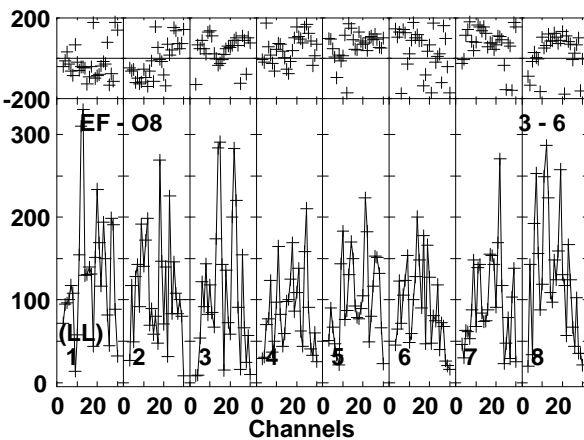
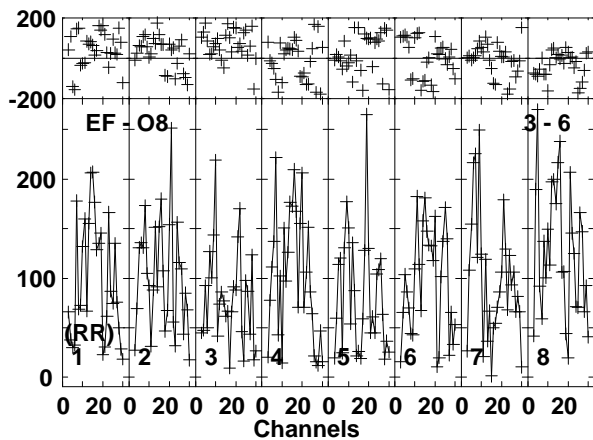
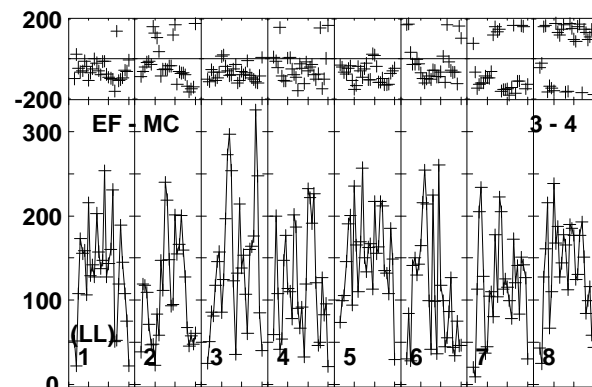
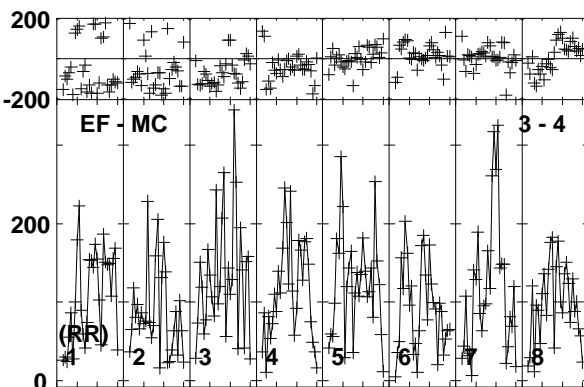
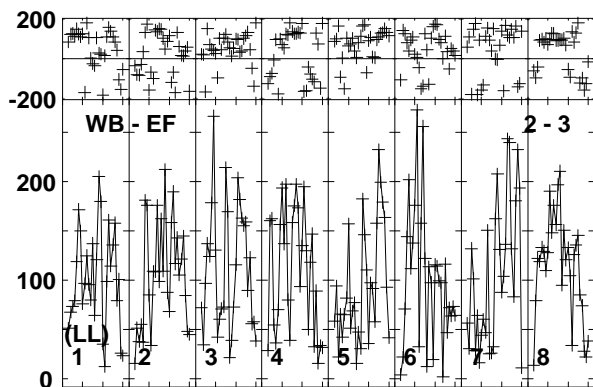
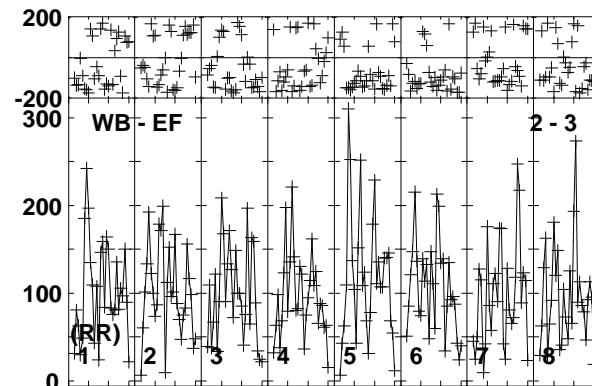
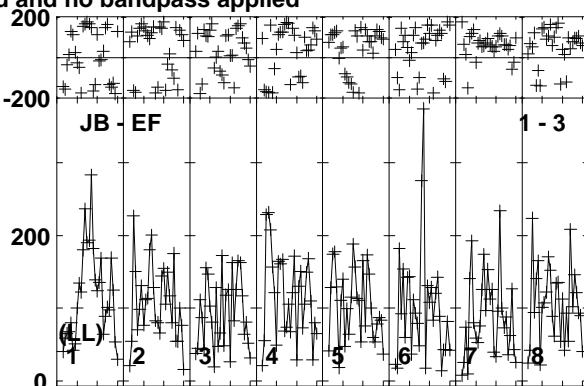
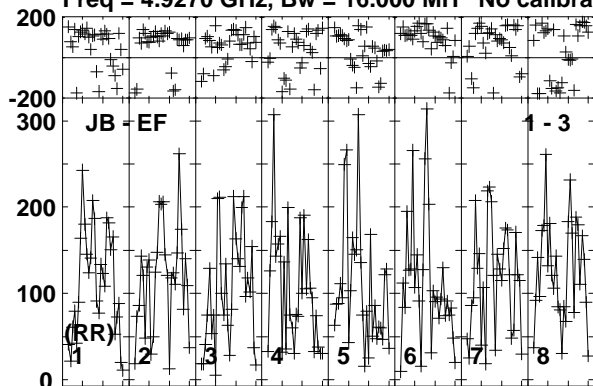

Lower frame: Micro Ampl Jy Top frame: Phas deg  
Vector averaged cross-power spectrum Baseline: JB (01) - EF (03)  
Timerange: 00/10:30:31 to 00/10:33:29

Plot file version 245 created 19-DEC-2018 17:58:28

AT2018\_RY007C.UVDATA.1

Freq = 4.9270 GHz, Bw = 16.000 MH No calibration applied and no bandpass applied

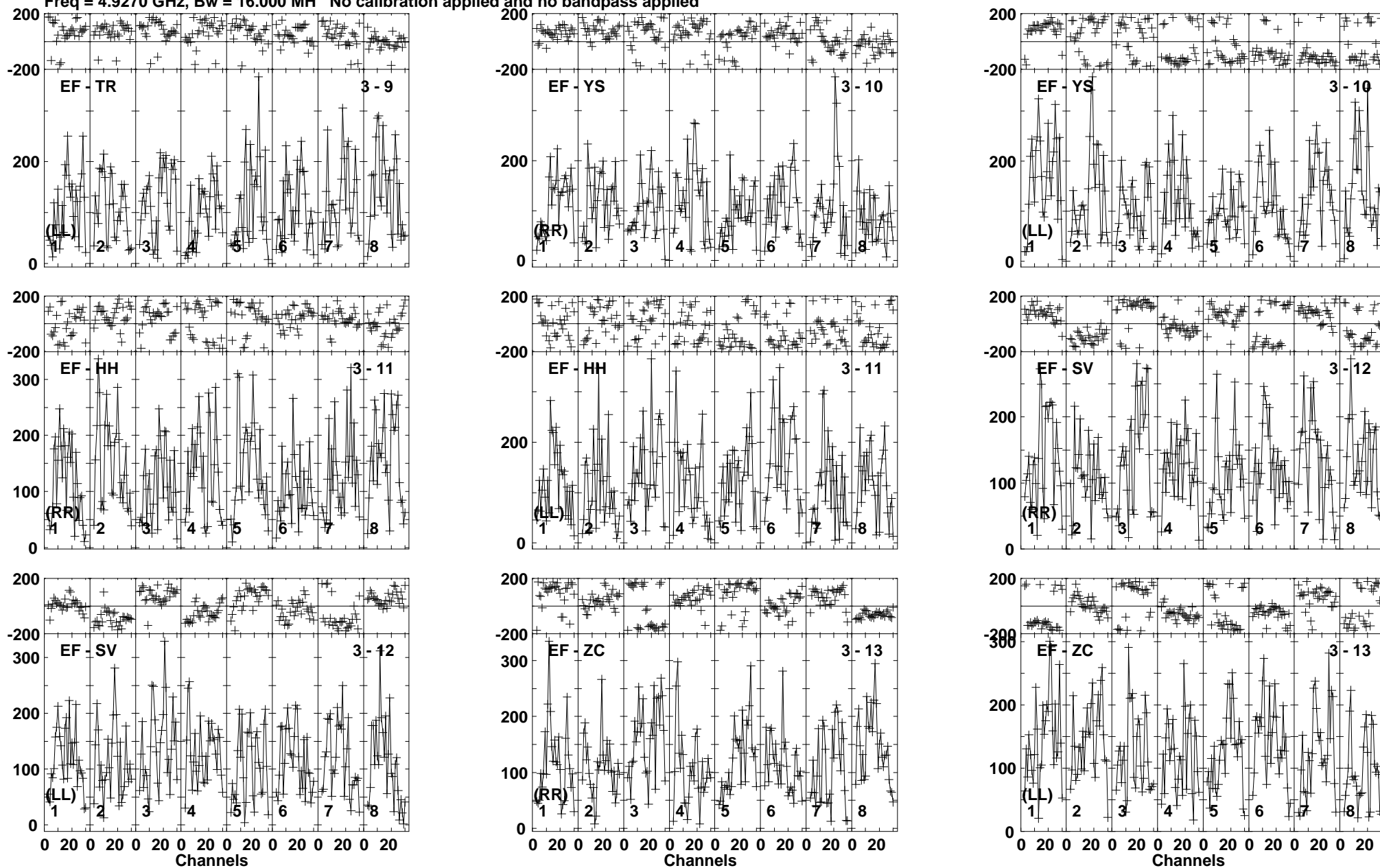

Lower frame: Micro Ampl Jy Top frame: Phas deg  
Vector averaged cross-power spectrum Baseline: EF (03) - TR (09)  
Timerange: 00/10:30:31 to 00/10:33:29

Plot file version 246 created 19-DEC-2018 17:58:28

AT2018\_RY007C.UVDATA.1

Freq = 4.9270 GHz, Bw = 16.000 MH No calibration applied and no bandpass applied

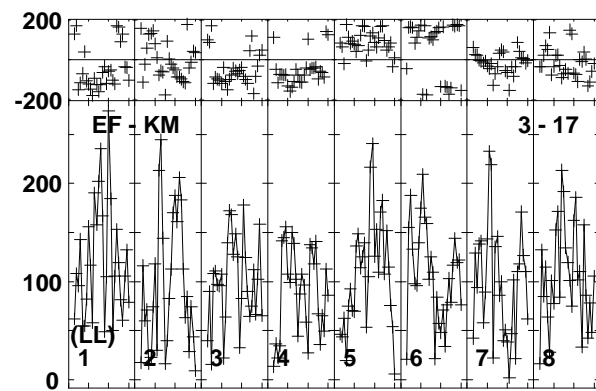
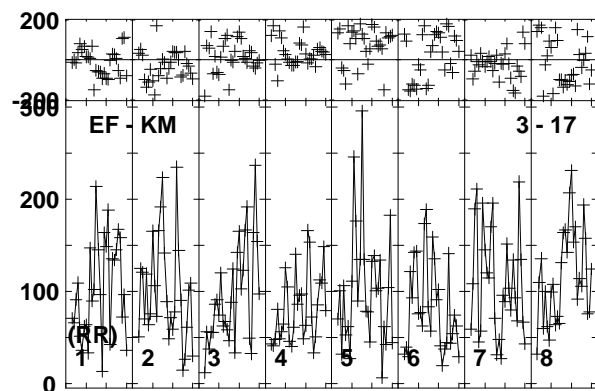
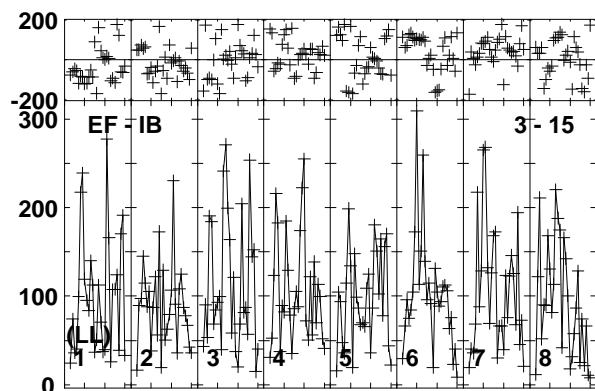
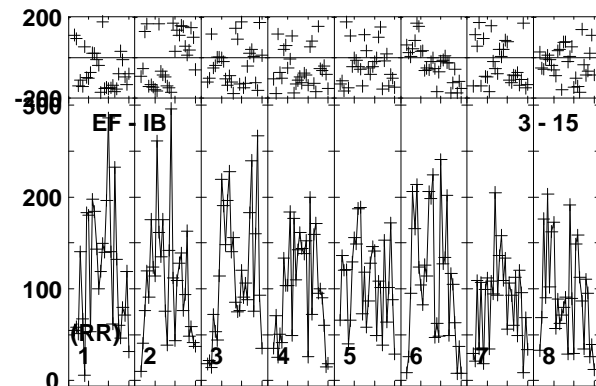
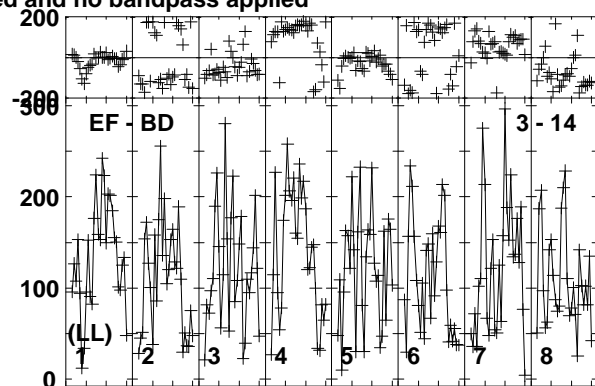
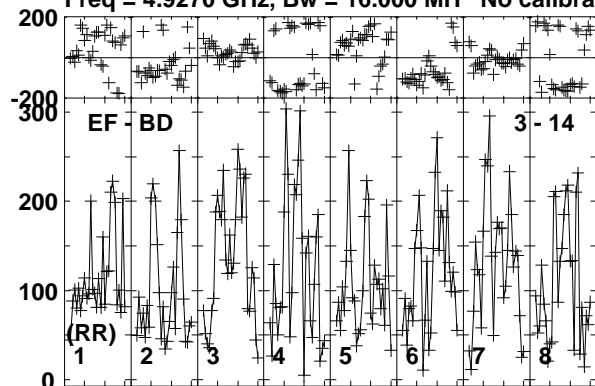

Lower frame: Micro Ampl Jy Top frame: Phas deg  
Vector averaged cross-power spectrum Baseline: EF (03) - BD (14)  
Timerange: 00/10:30:31 to 00/10:33:29

Plot file version 247 created 19-DEC-2018 17:58:28

J1619+2247 RY007C.UVDATA.1

Freq = 4.9270 GHz, Bw = 16.000 MH No calibration applied and no bandpass applied

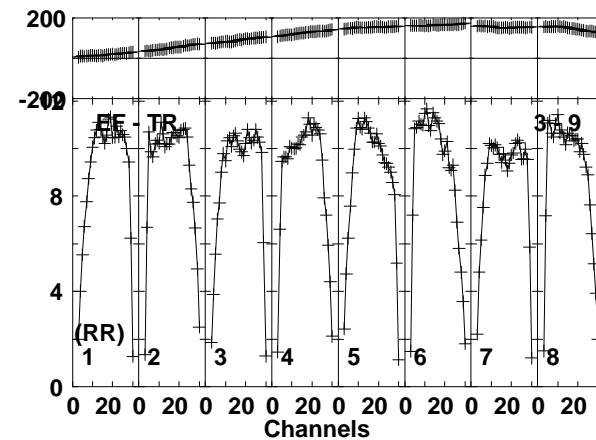
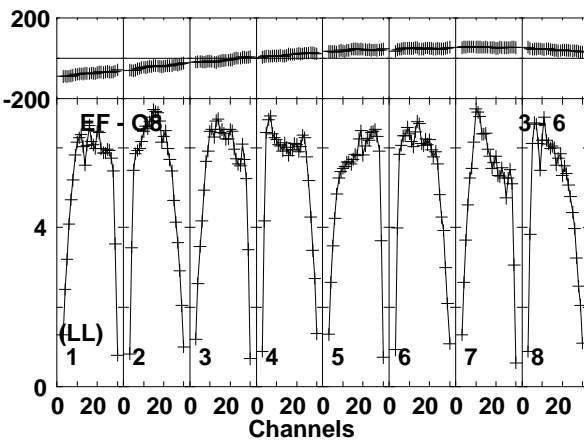
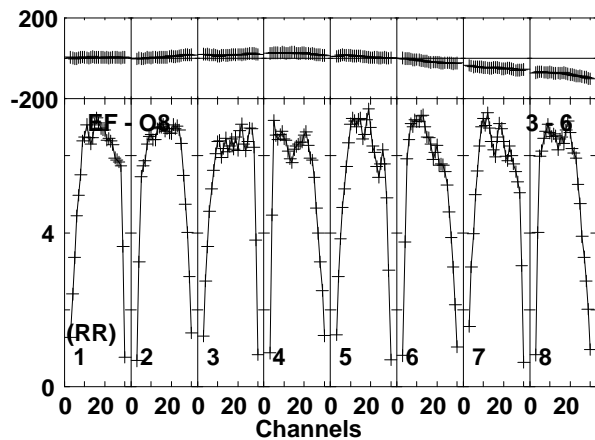
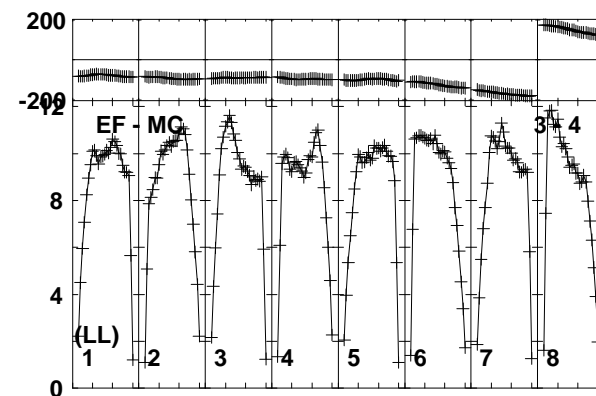
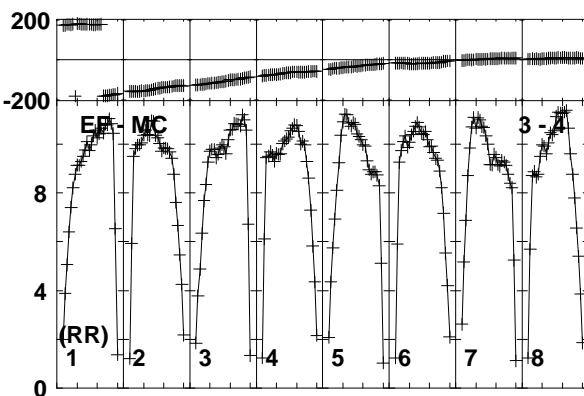
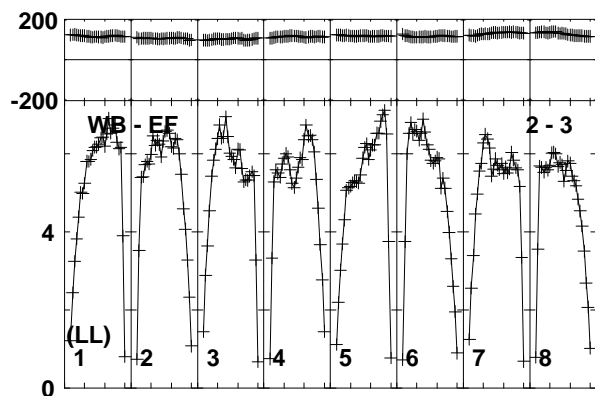
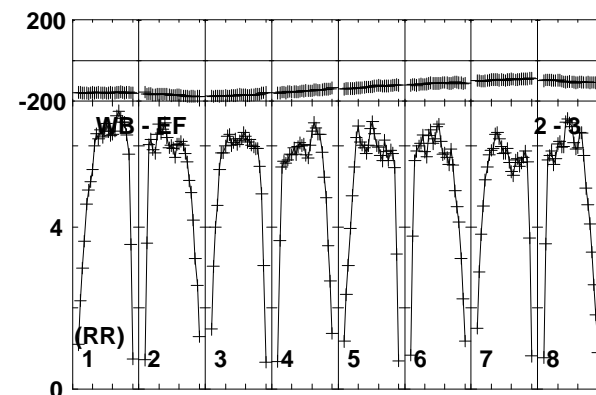
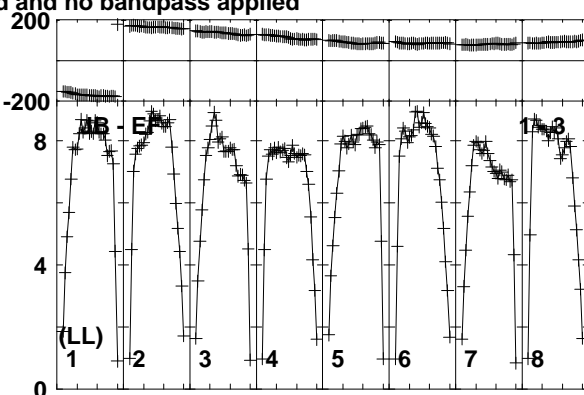
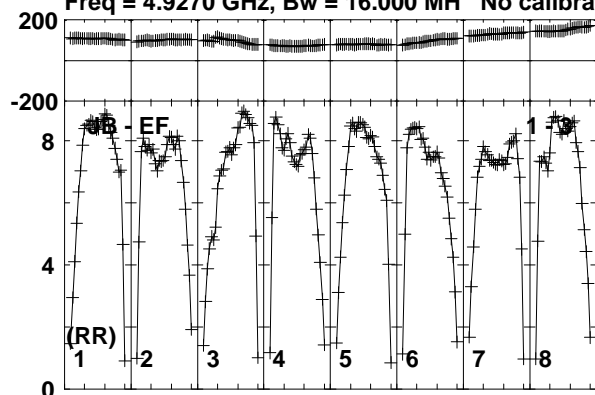

Lower frame: Milli Ampl Jy Top frame: Phas deg  
Vector averaged cross-power spectrum Baseline: JB (01) - EF (03)  
Timerange: 00/10:33:31 to 00/10:34:29

Plot file version 248 created 19-DEC-2018 17:58:28

J1619+2247 RY007C.UVDATA.1

Freq = 4.9270 GHz, Bw = 16.000 MH No calibration applied and no bandpass applied

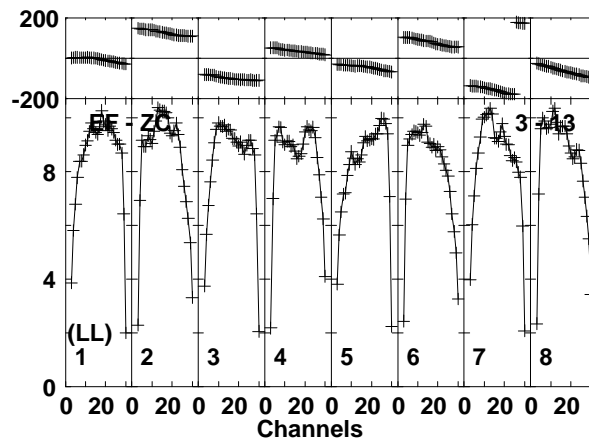
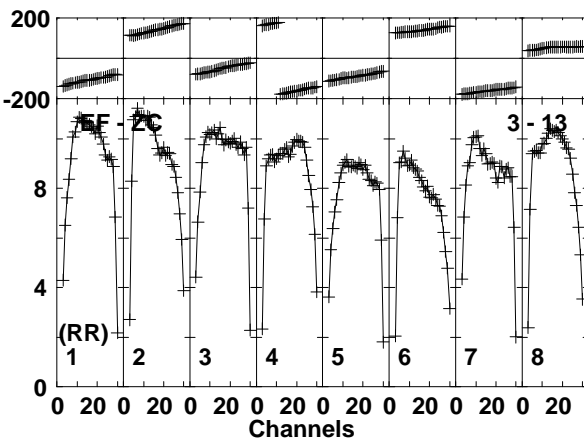
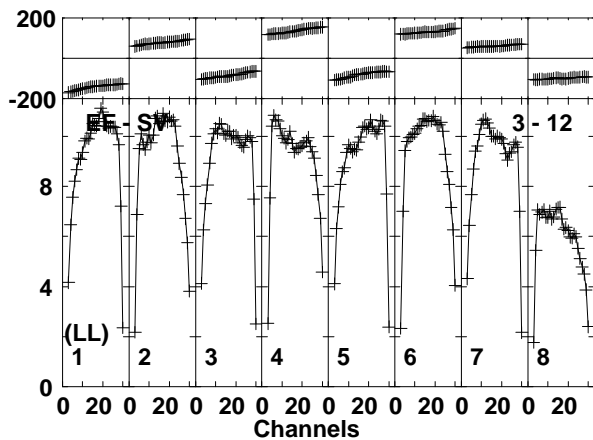
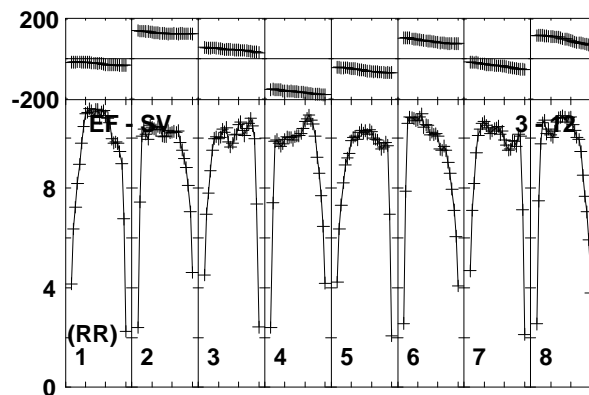
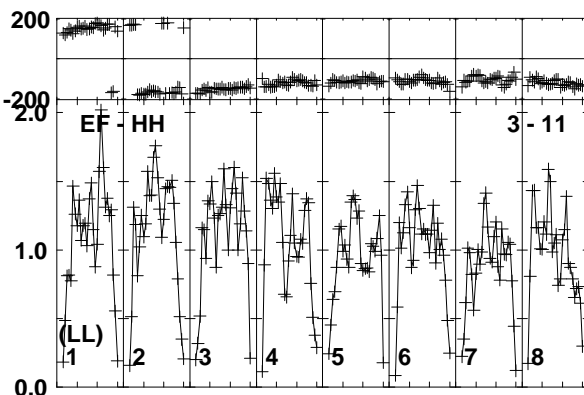
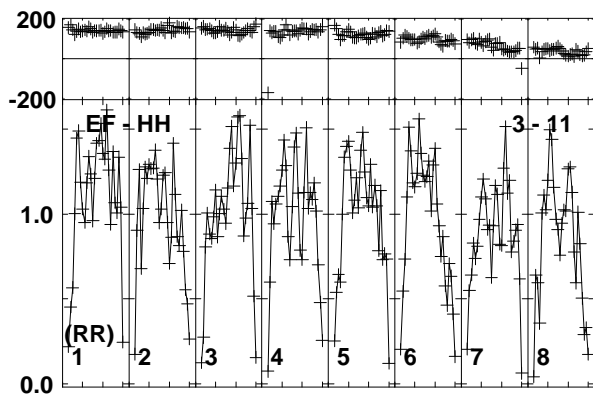
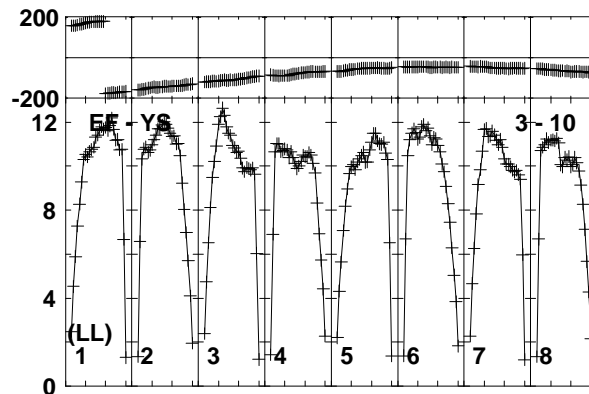
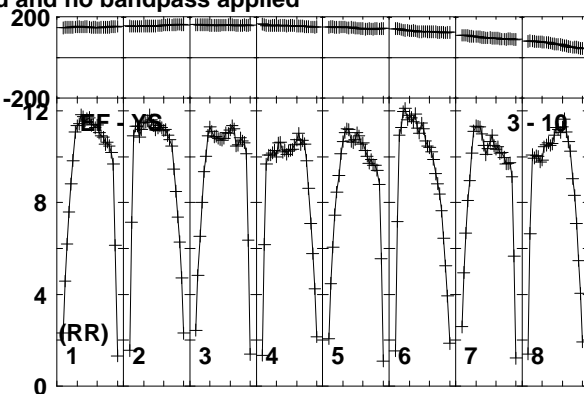
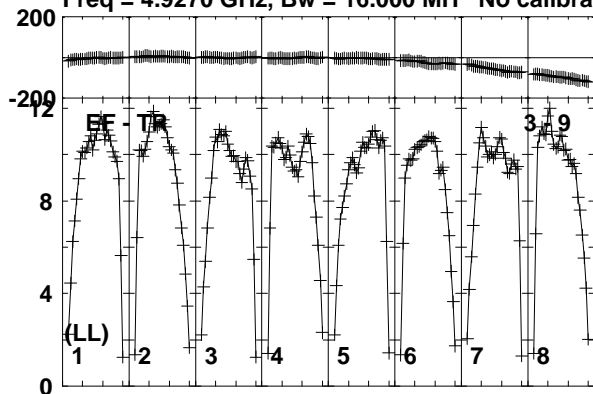

Lower frame: Milli Ampl Jy Top frame: Phas deg  
Vector averaged cross-power spectrum Baseline: EF (03) - TR (09)  
Timerange: 00/10:33:31 to 00/10:34:29

Plot file version 249 created 19-DEC-2018 17:58:28

J1619+2247 RY007C.UVDATA.1

Freq = 4.9270 GHz, Bw = 16.000 MH No calibration applied and no bandpass applied

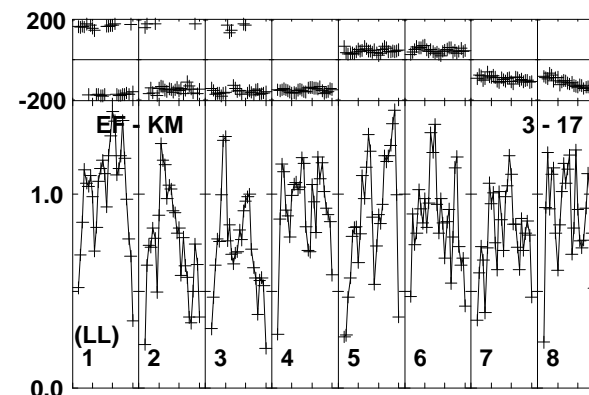
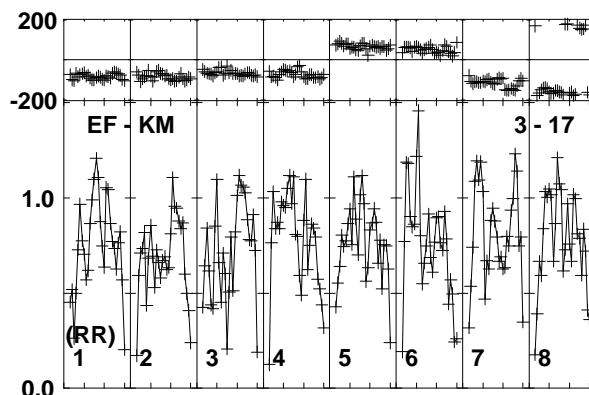
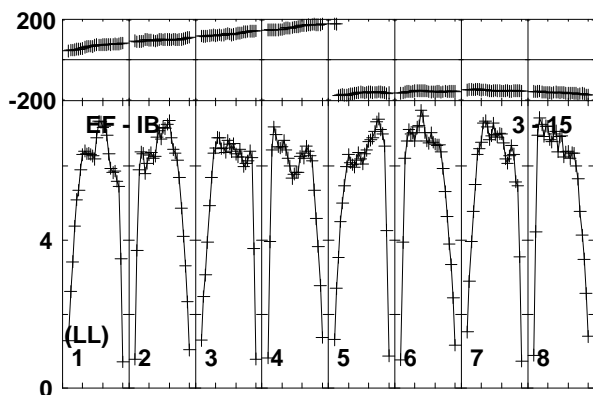
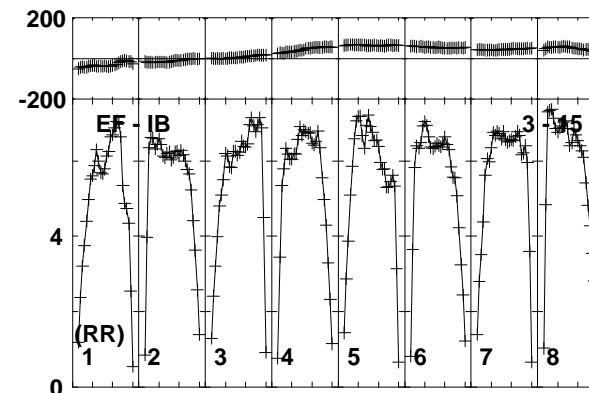
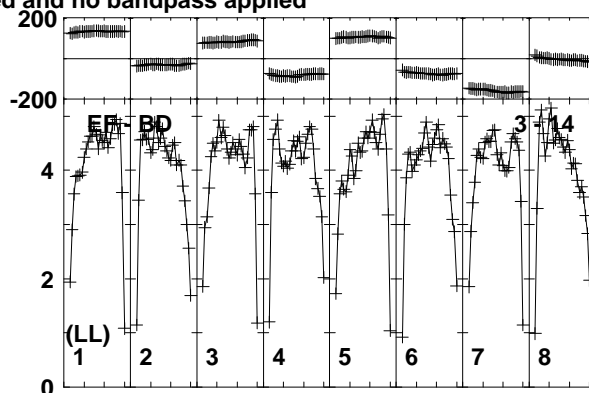
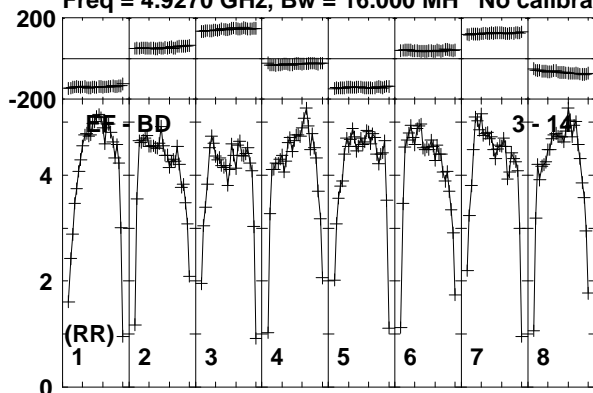

Lower frame: Milli Ampl Jy Top frame: Phas deg  
Vector averaged cross-power spectrum Baseline: EF (03) - BD (14)  
Timerange: 00/10:33:31 to 00/10:34:29

Plot file version 250 created 19-DEC-2018 17:58:28

VLA1 RY007C.UVDATA.1

Freq = 4.9270 GHz, Bw = 16.000 MH No calibration applied and no bandpass applied

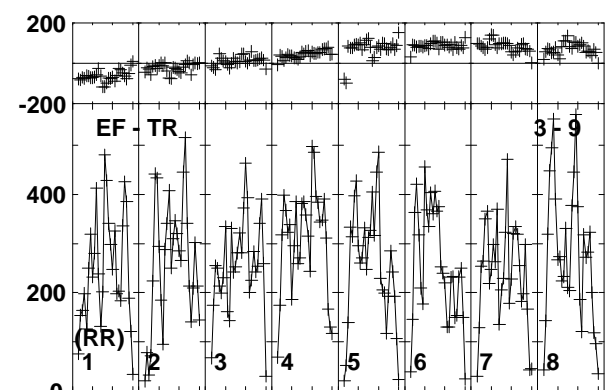
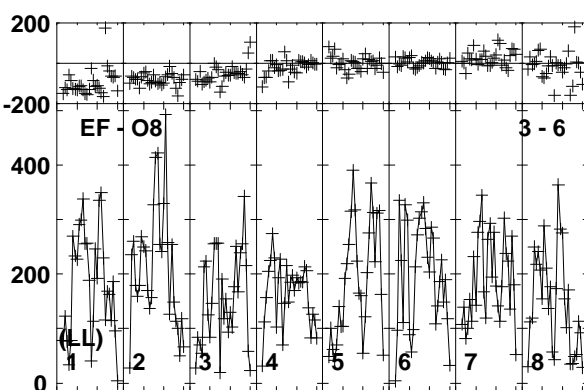
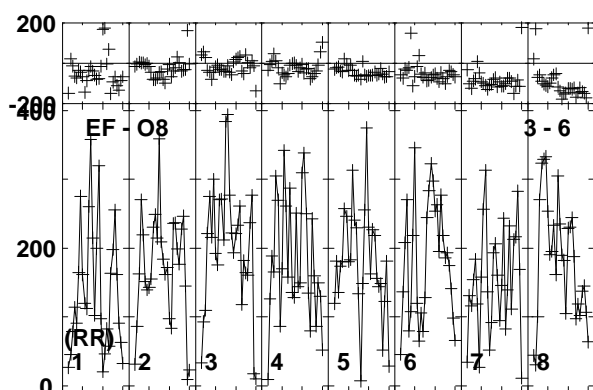
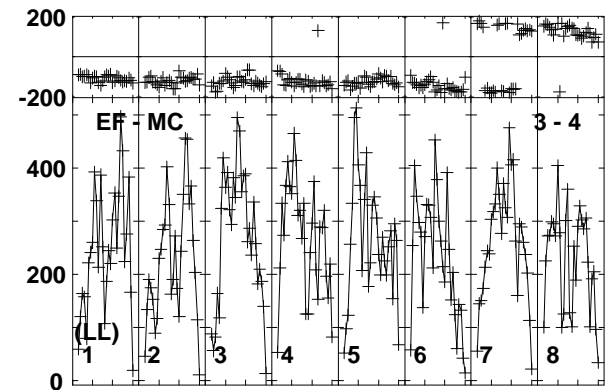
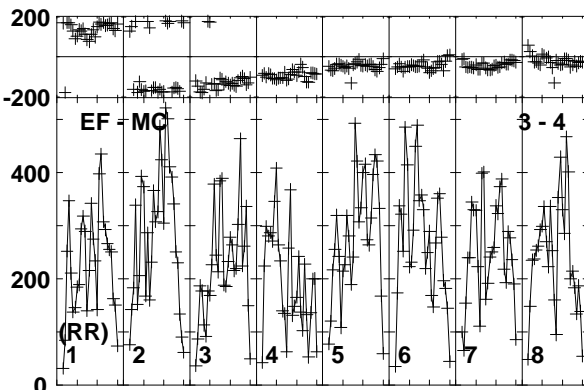
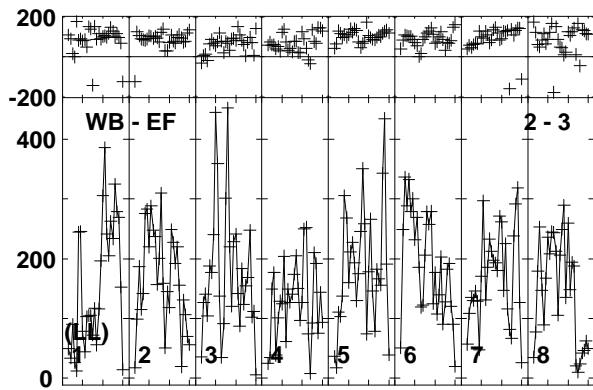
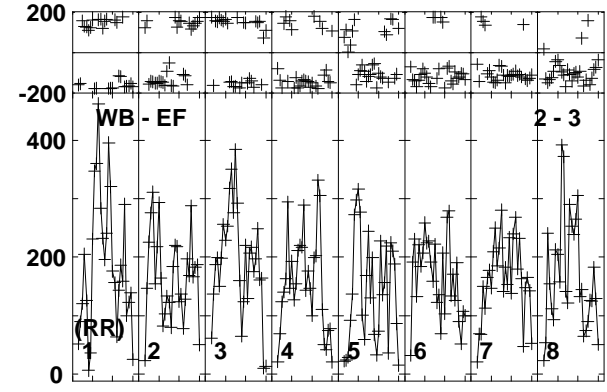
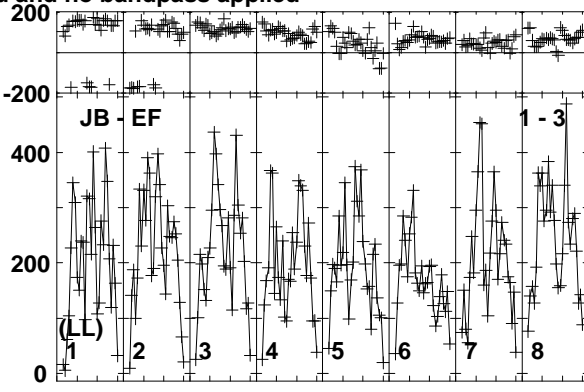
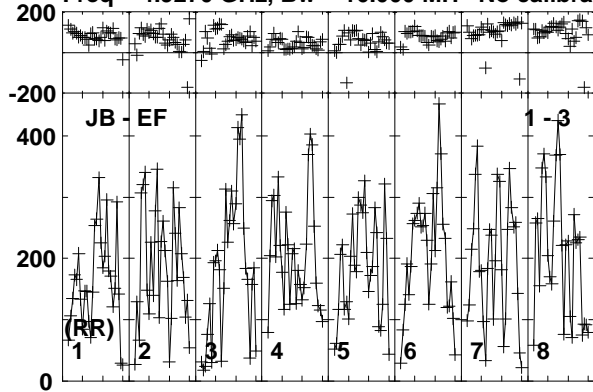

Lower frame: Micro Ampl Jy Top frame: Phas deg  
Vector averaged cross-power spectrum Baseline: JB (01) - EF (03)  
Timerange: 00/10:35:01 to 00/10:36:59



Plot file version 251 created 19-DEC-2018 17:58:28

VLA1 RY007C.UVDATA.1

Freq = 4.9270 GHz, Bw = 16.000 MH No calibration applied and no bandpass applied

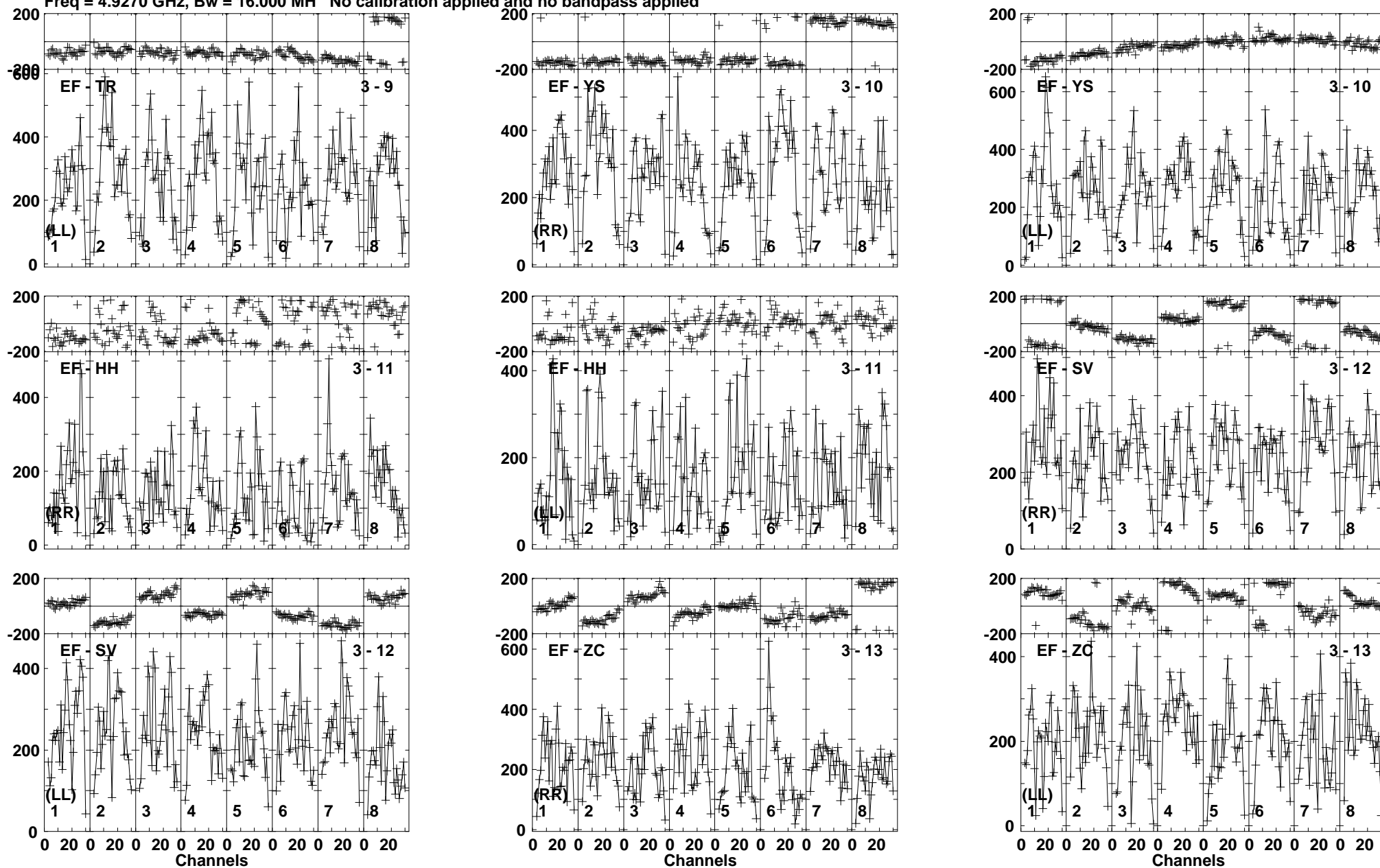

Lower frame: Micro Ampl Jy Top frame: Phas deg  
Vector averaged cross-power spectrum Baseline: EF (03) - TR (09)  
Timerange: 00/10:35:01 to 00/10:36:59

Plot file version 252 created 19-DEC-2018 17:58:28

VLA1 RY007C.UVDATA.1

Freq = 4.9270 GHz, Bw = 16.000 MH No calibration applied and no bandpass applied

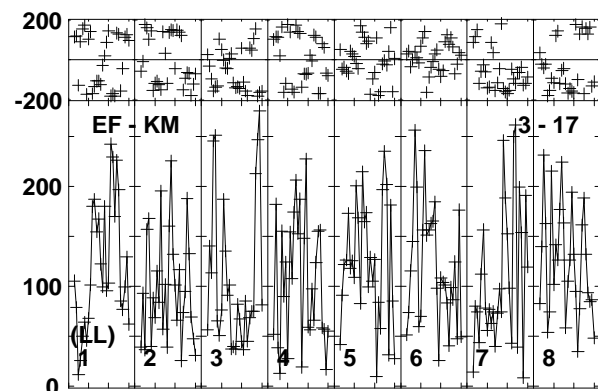
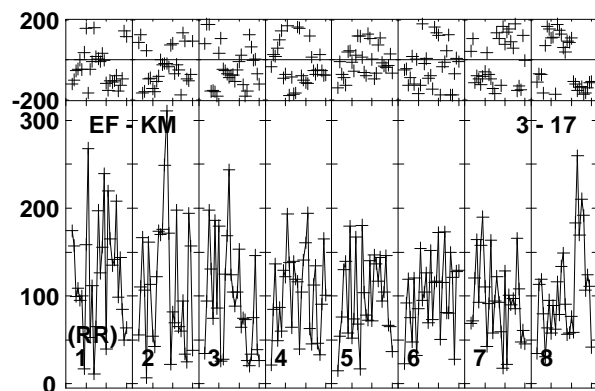
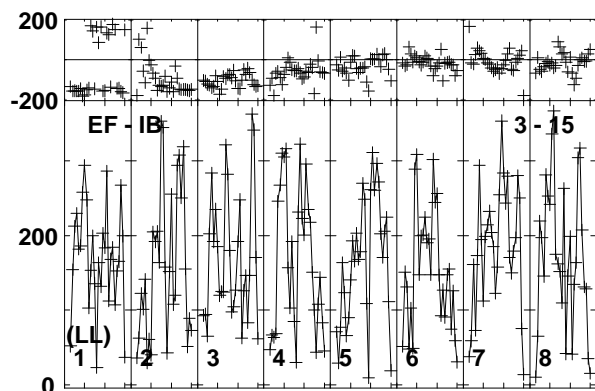
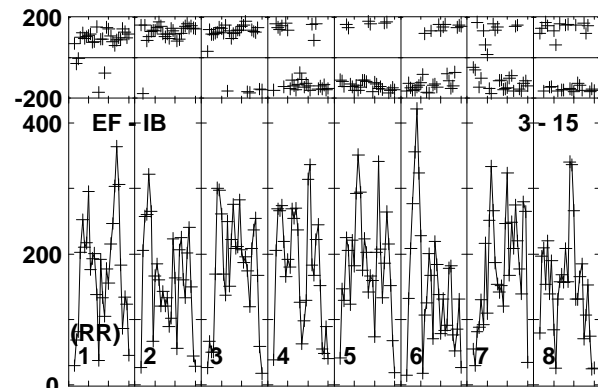
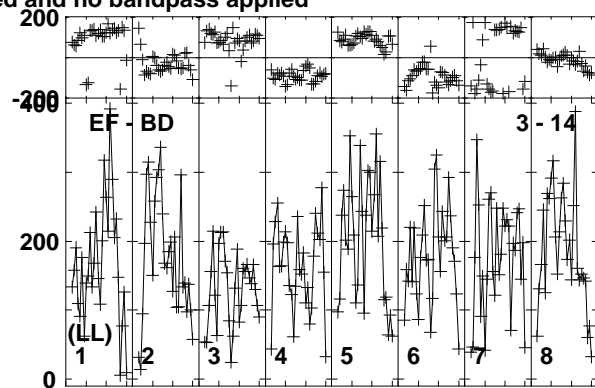
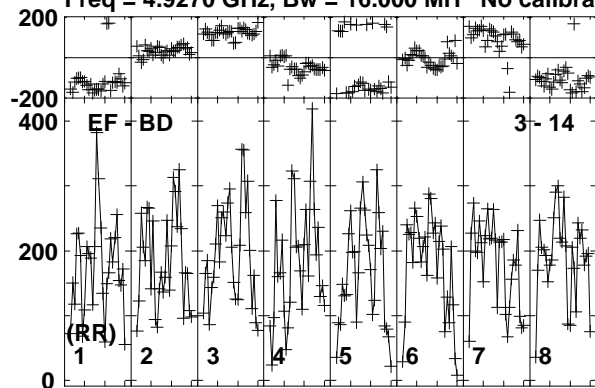

Lower frame: Micro Ampl Jy Top frame: Phas deg  
Vector averaged cross-power spectrum Baseline: EF (03) - BD (14)  
Timerange: 00/10:35:01 to 00/10:36:59

Plot file version 253 created 19-DEC-2018 17:58:28

J1619+2247 RY007C.UVDATA.1

Freq = 4.9270 GHz, Bw = 16.000 MH No calibration applied and no bandpass applied

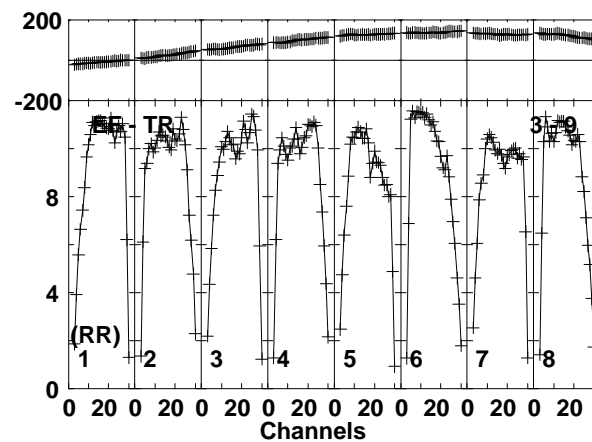
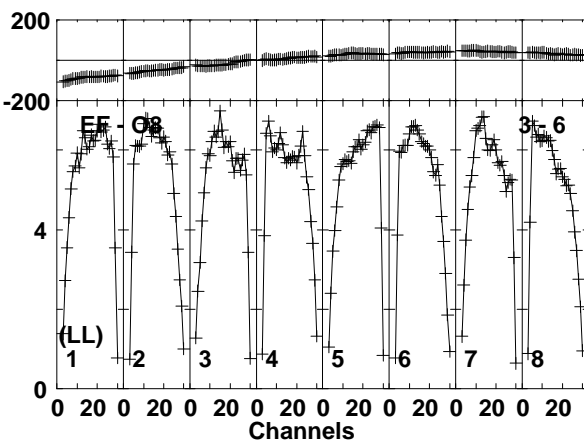
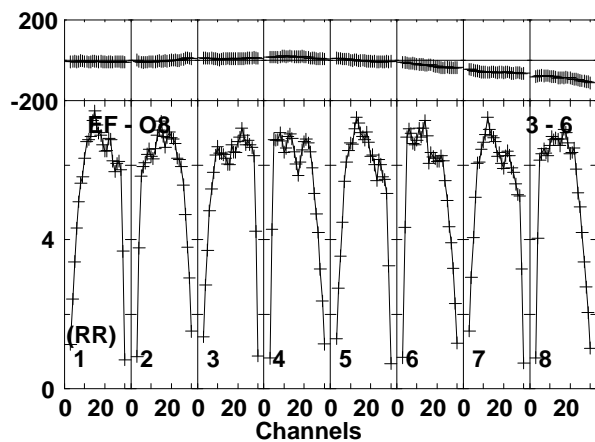
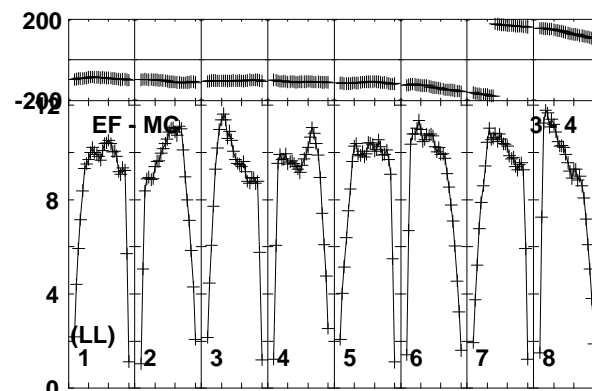
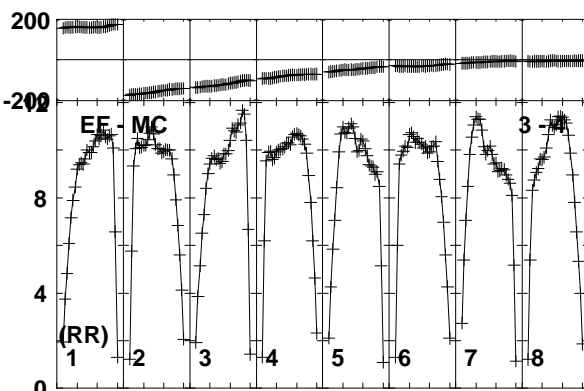
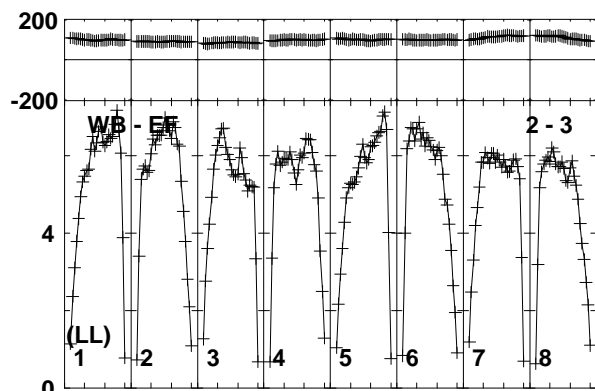
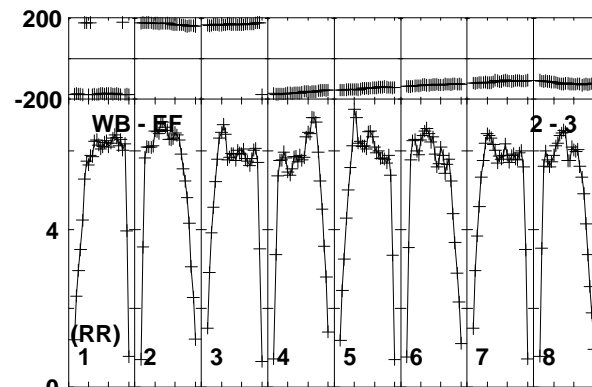
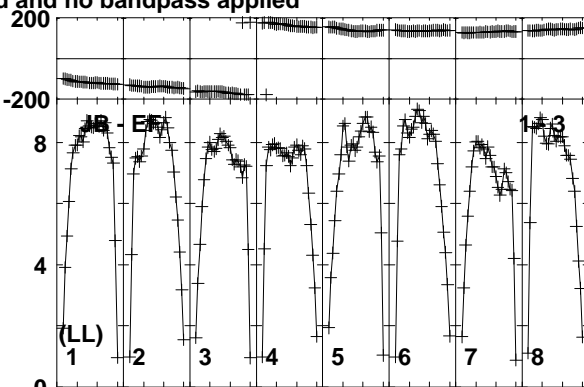
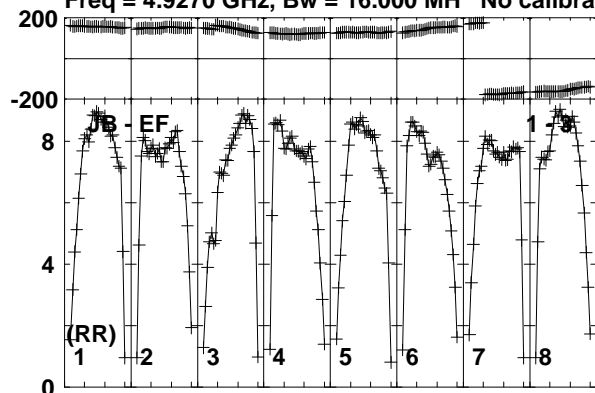

Lower frame: Milli Ampl Jy Top frame: Phas deg  
Vector averaged cross-power spectrum Baseline: JB (01) - EF (03)  
Timerange: 00/10:37:01 to 00/10:37:59

Plot file version 254 created 19-DEC-2018 17:58:28

J1619+2247 RY007C.UVDATA.1

Freq = 4.9270 GHz, Bw = 16.000 MH No calibration applied and no bandpass applied

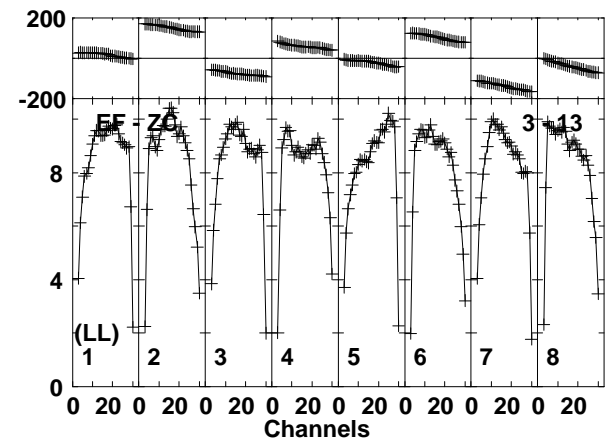
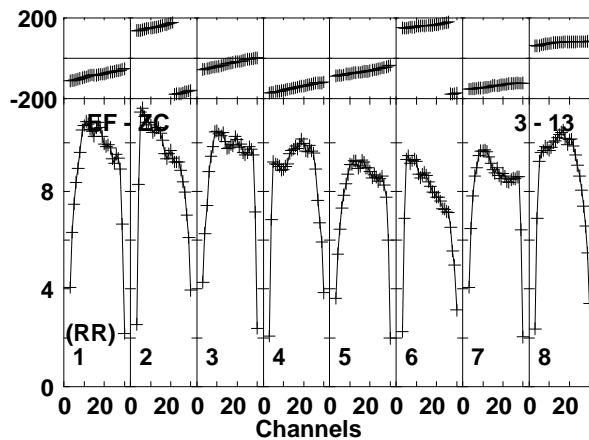
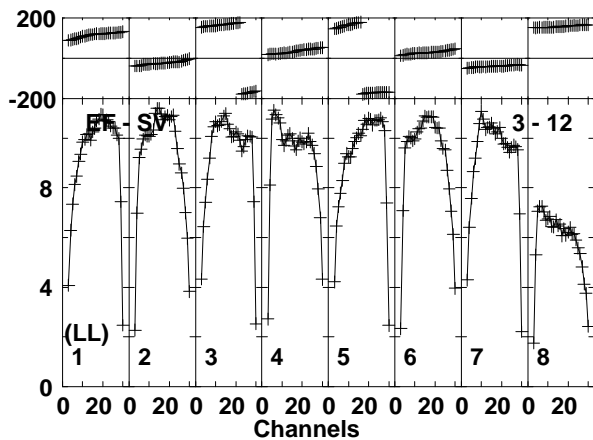
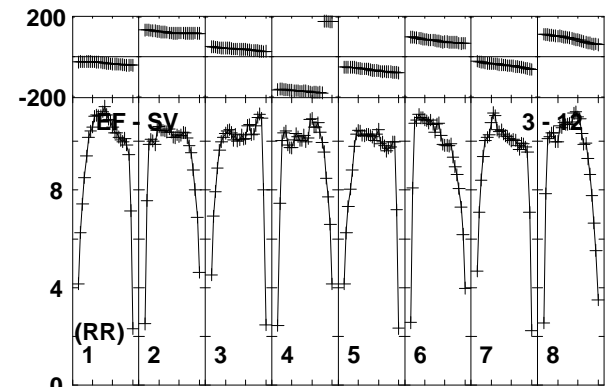
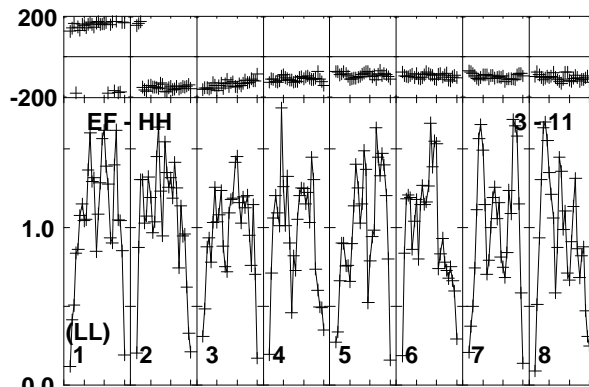
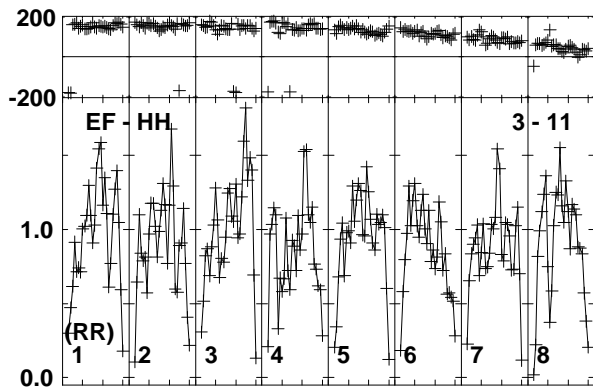
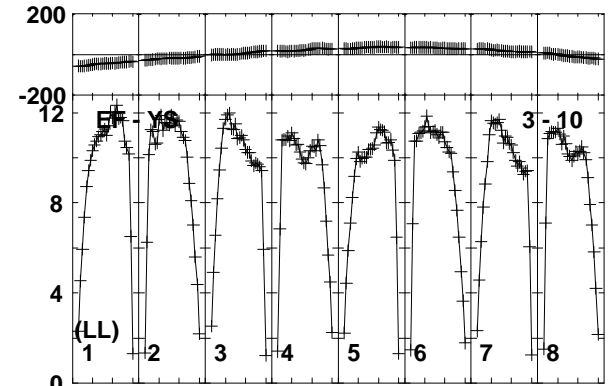
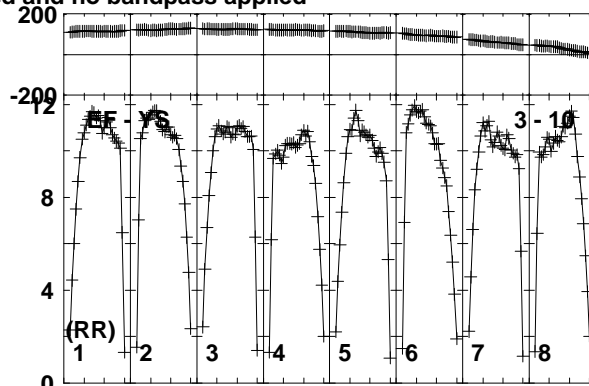
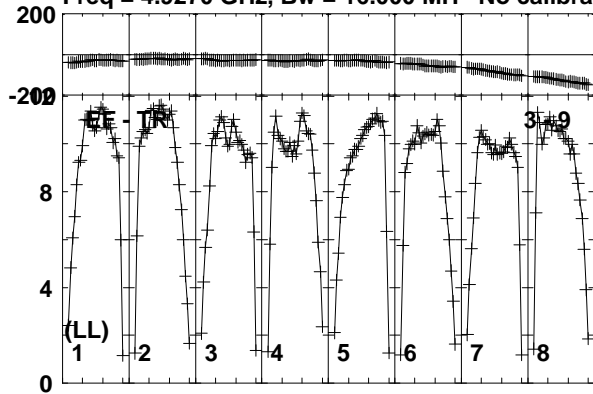

Lower frame: Milli Ampl Jy Top frame: Phas deg  
Vector averaged cross-power spectrum Baseline: EF (03) - TR (09)  
Timerange: 00/10:37:01 to 00/10:37:59

Plot file version 255 created 19-DEC-2018 17:58:28

J1619+2247 RY007C.UVDATA.1

Freq = 4.9270 GHz, Bw = 16.000 MH No calibration applied and no bandpass applied

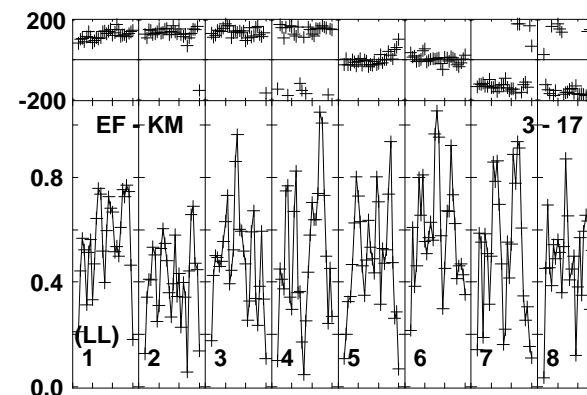
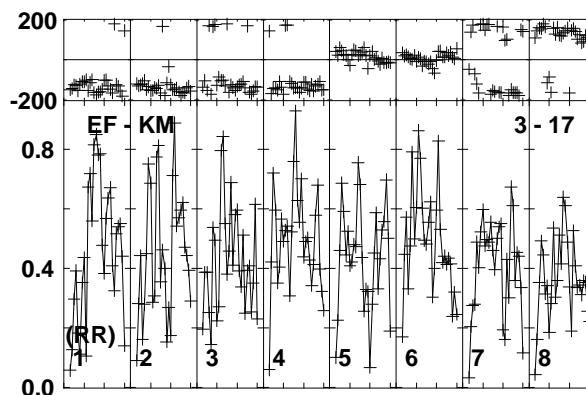
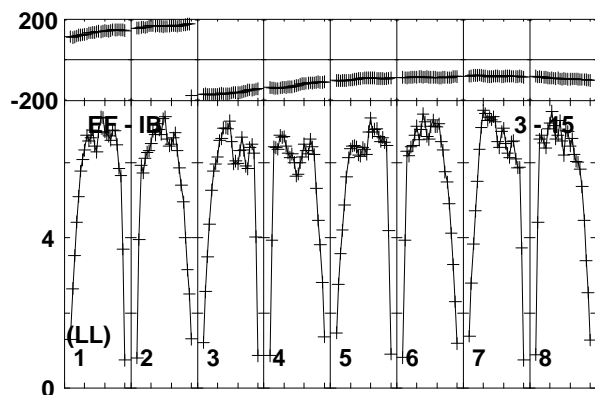
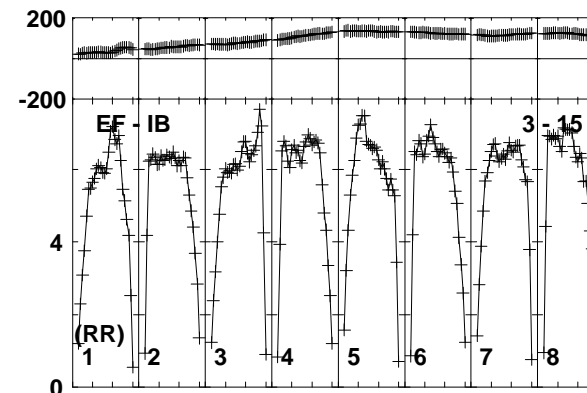
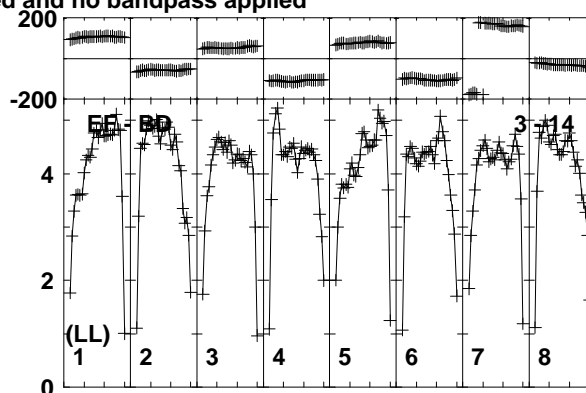
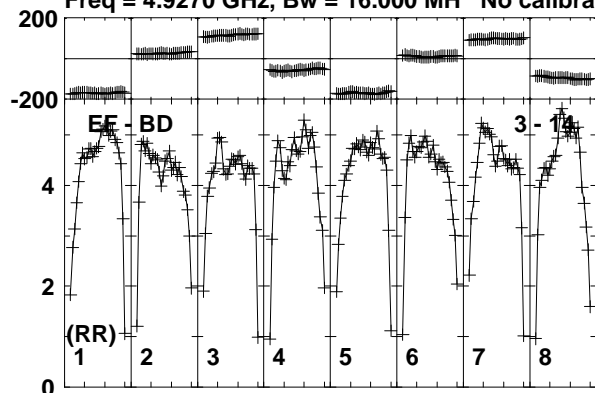

Lower frame: Milli Ampl Jy Top frame: Phas deg  
Vector averaged cross-power spectrum Baseline: EF (03) - BD (14)  
Timerange: 00/10:37:01 to 00/10:37:59

Plot file version 256 created 19-DEC-2018 17:58:28

AT2018\_RY007C.UVDATA.1

Freq = 4.9270 GHz, Bw = 16.000 MH No calibration applied and no bandpass applied

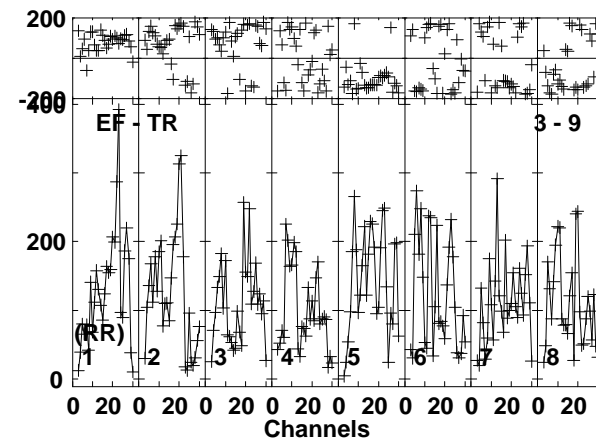
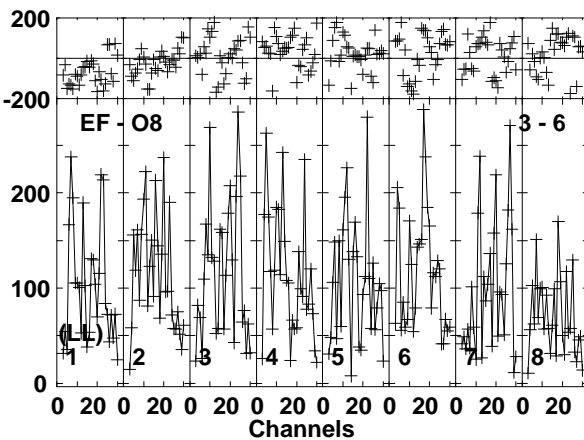
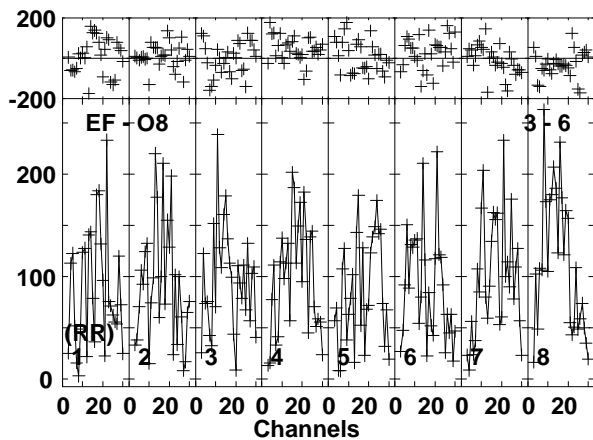
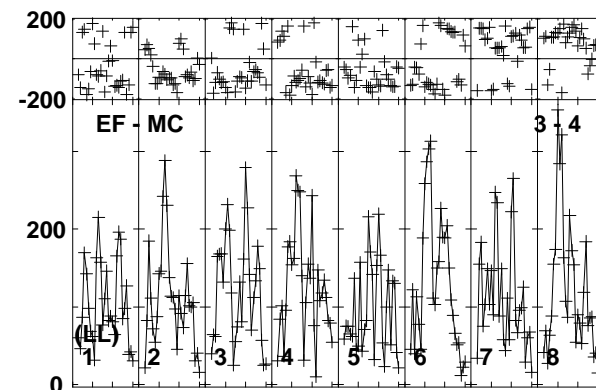
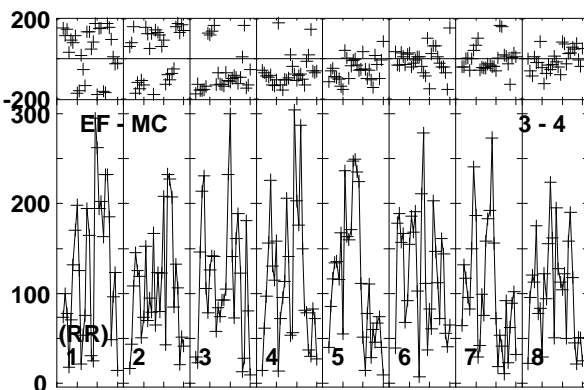
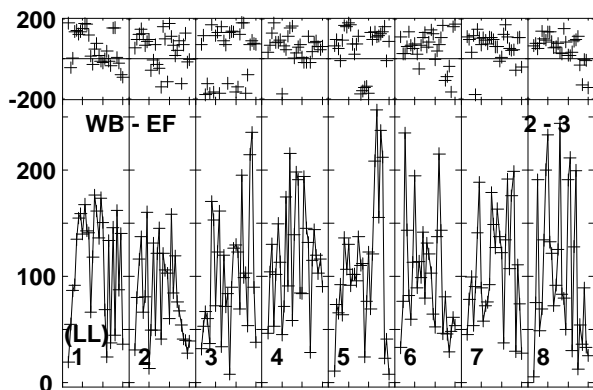
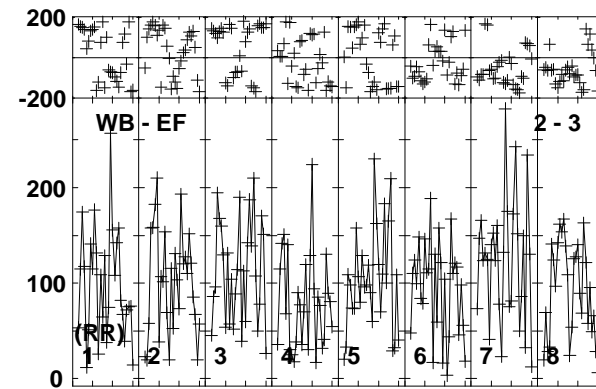
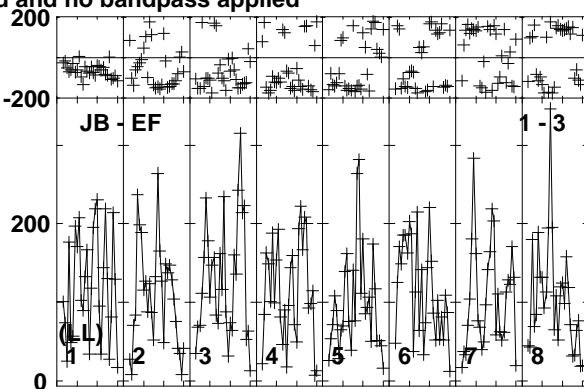
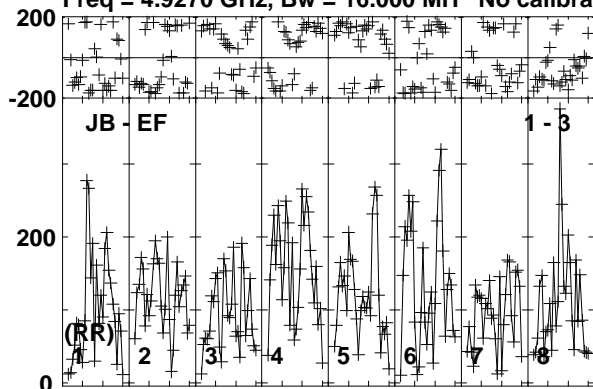

Lower frame: Micro Ampl Jy Top frame: Phas deg  
Vector averaged cross-power spectrum Baseline: JB (01) - EF (03)  
Timerange: 00/10:38:01 to 00/10:40:59

Plot file version 257 created 19-DEC-2018 17:58:28

AT2018\_RY007C.UVDATA.1

Freq = 4.9270 GHz, Bw = 16.000 MH No calibration applied and no bandpass applied

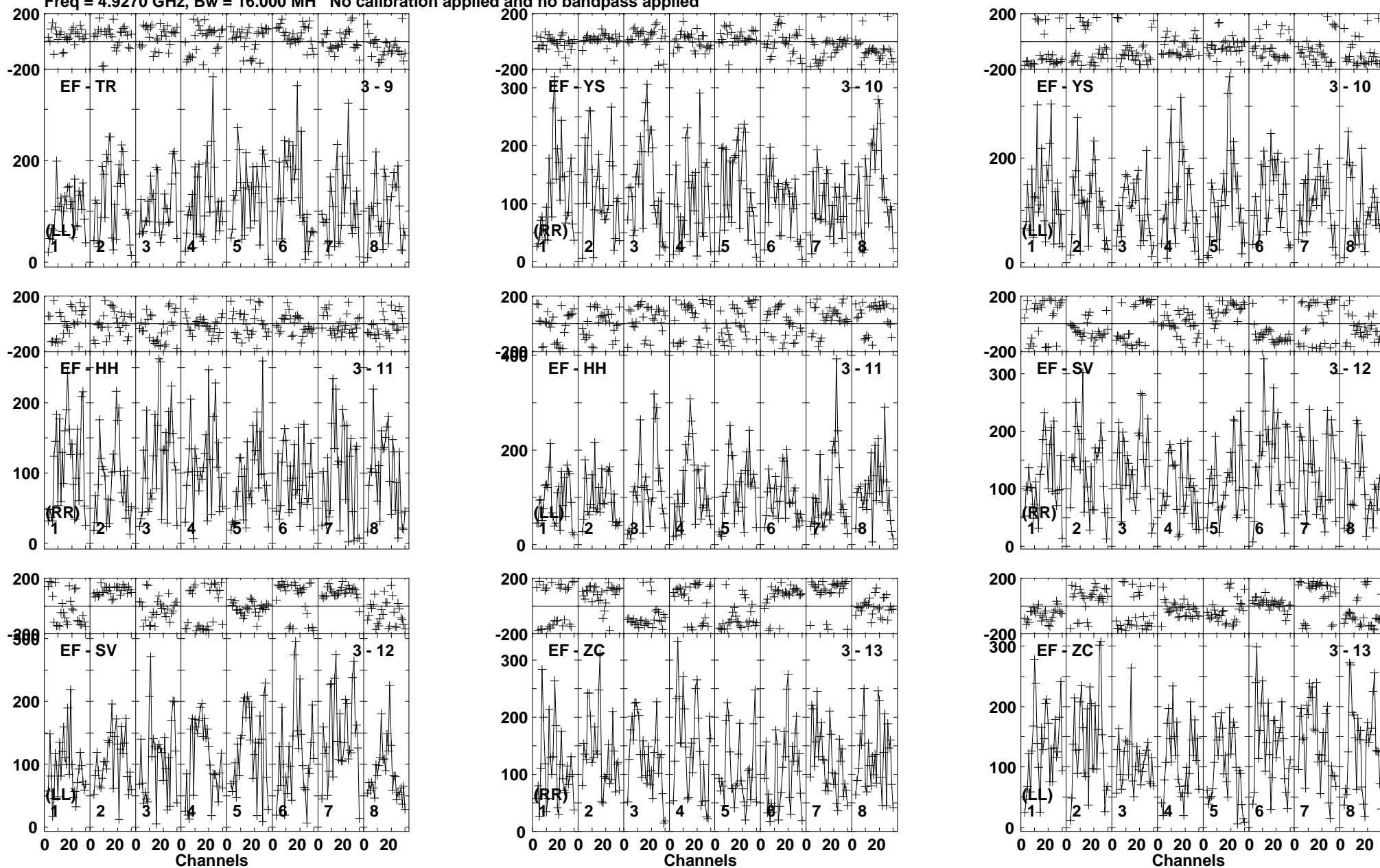

Lower frame: Micro Ampl Jy Top frame: Phas deg  
Vector averaged cross-power spectrum Baseline: EF (03) - TR (09)  
Timerange: 00/10:38:01 to 00/10:40:59

Plot file version 258 created 19-DEC-2018 17:58:28

AT2018\_RY007C.UVDATA.1

Freq = 4.9270 GHz, Bw = 16.000 MH No calibration applied and no bandpass applied

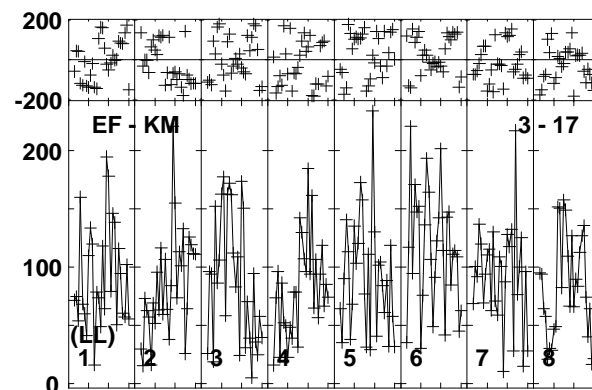
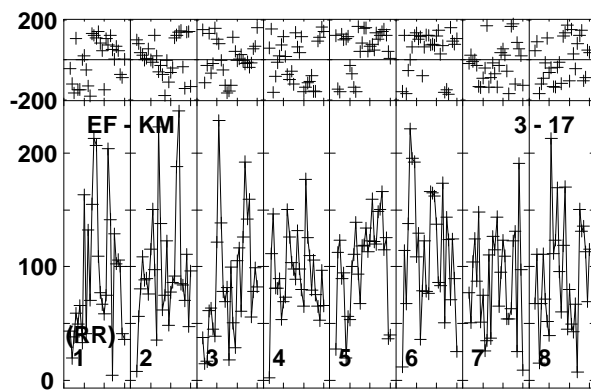
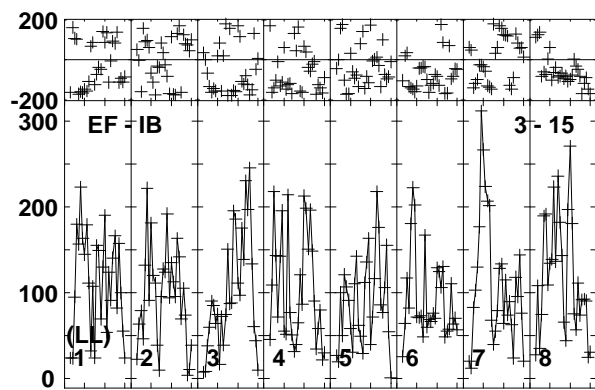
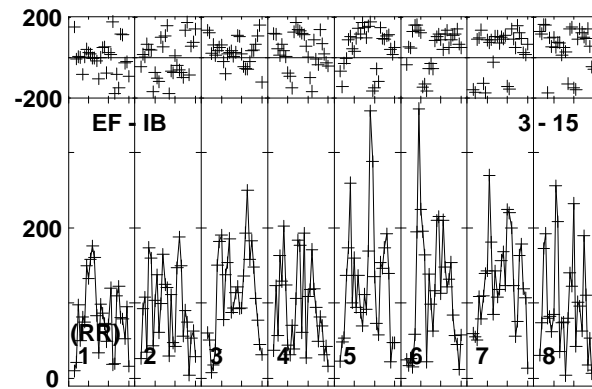
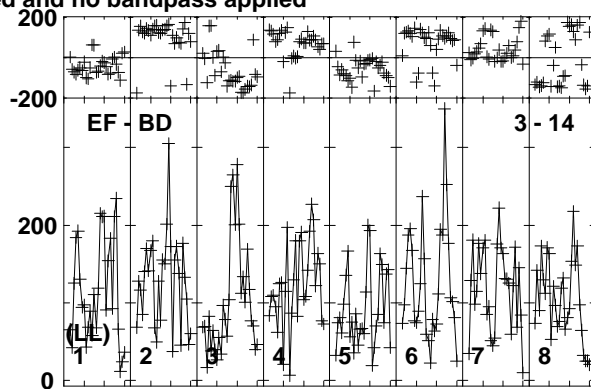
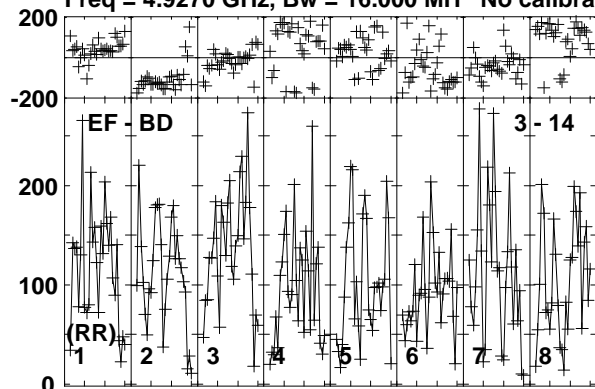

Lower frame: Micro Ampl Jy Top frame: Phas deg  
Vector averaged cross-power spectrum Baseline: EF (03) - BD (14)  
Timerange: 00/10:38:01 to 00/10:40:59



Plot file version 259 created 19-DEC-2018 17:58:28

J1619+2247 RY007C.UVDATA.1

Freq = 4.9270 GHz, Bw = 16.000 MH No calibration applied and no bandpass applied

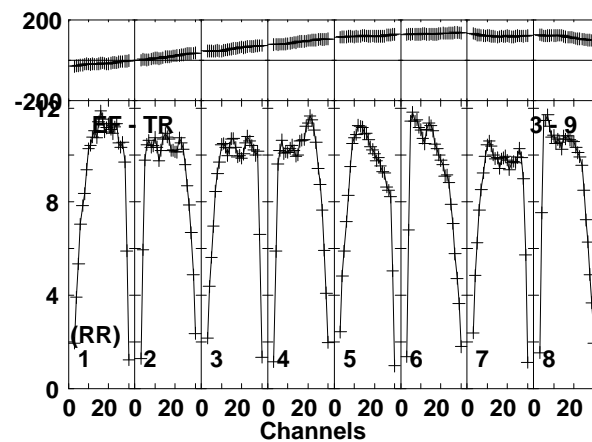
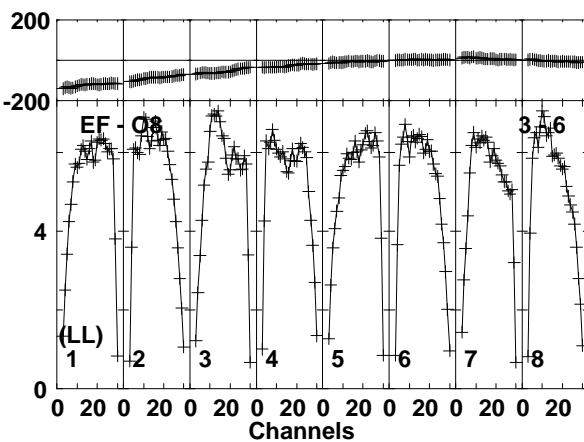
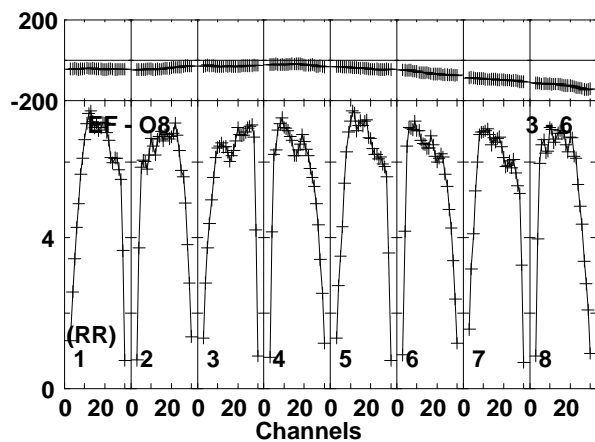
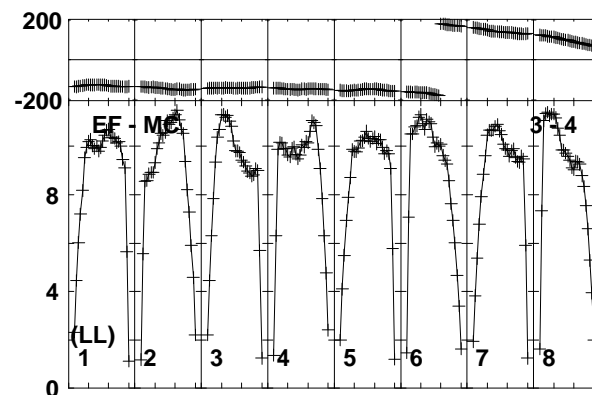
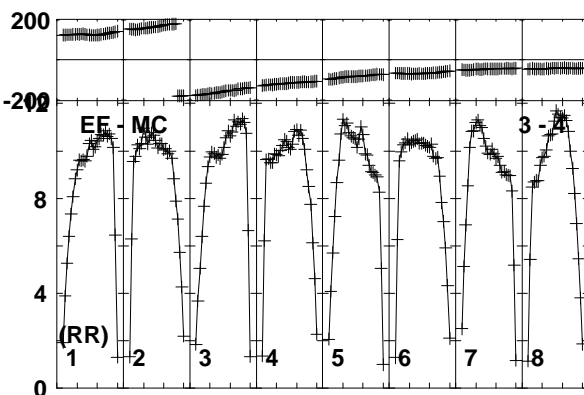
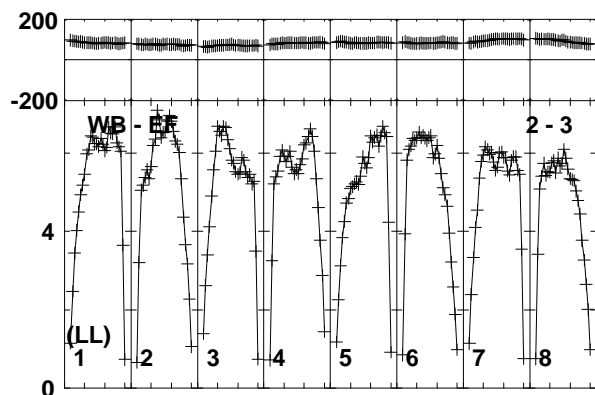
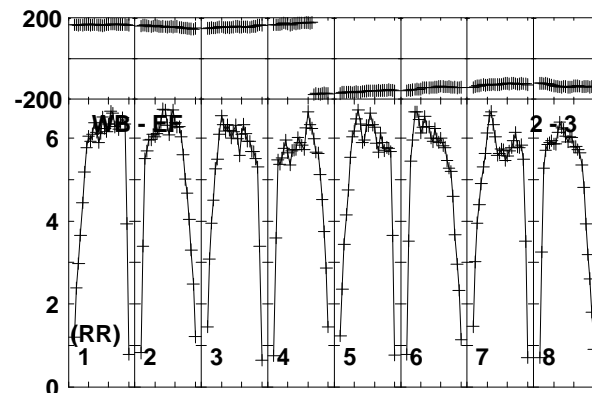
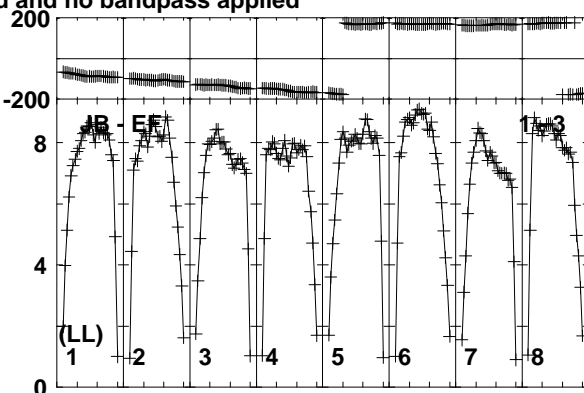
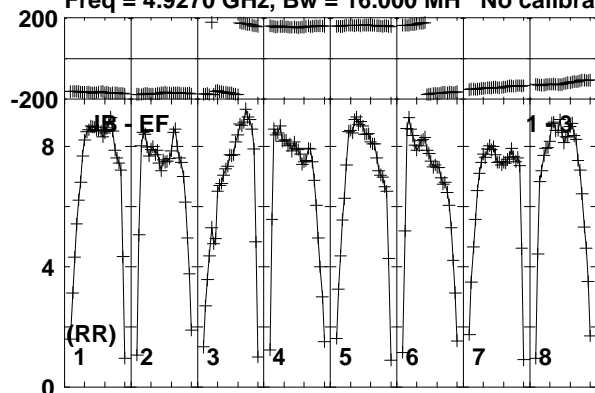

Lower frame: Milli Ampl Jy Top frame: Phas deg  
Vector averaged cross-power spectrum Baseline: JB (01) - EF (03)  
Timerange: 00/10:41:01 to 00/10:41:59

Plot file version 260 created 19-DEC-2018 17:58:28

J1619+2247 RY007C.UVDATA.1

Freq = 4.9270 GHz, Bw = 16.000 MH No calibration applied and no bandpass applied

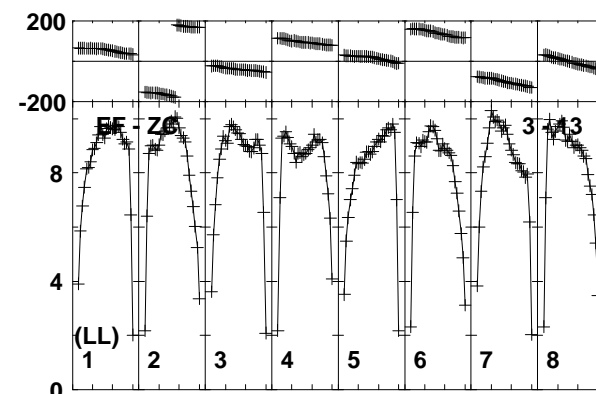
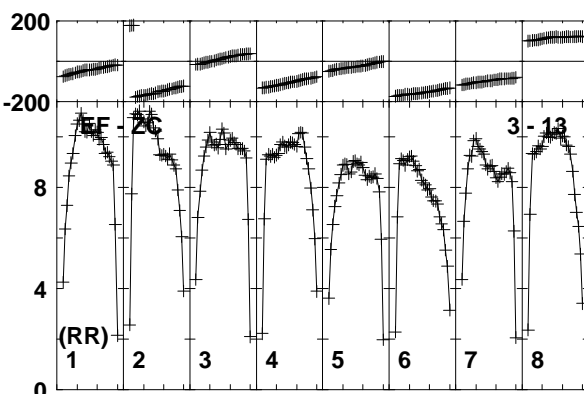
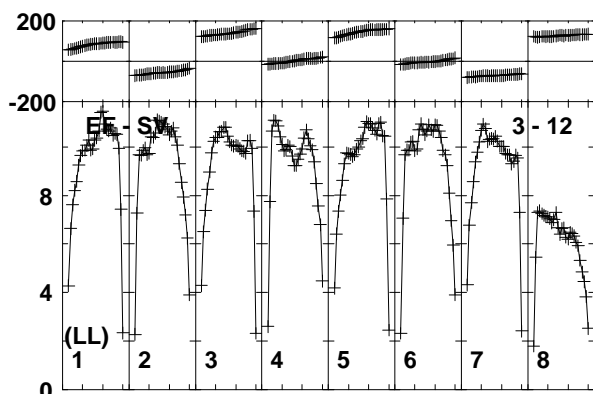
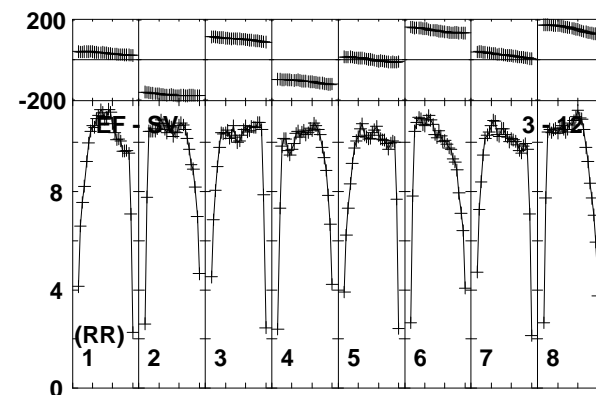
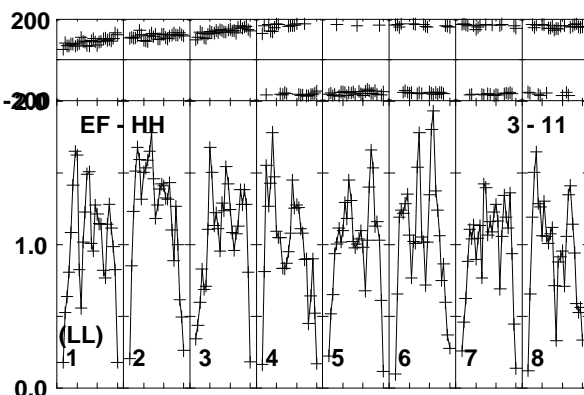
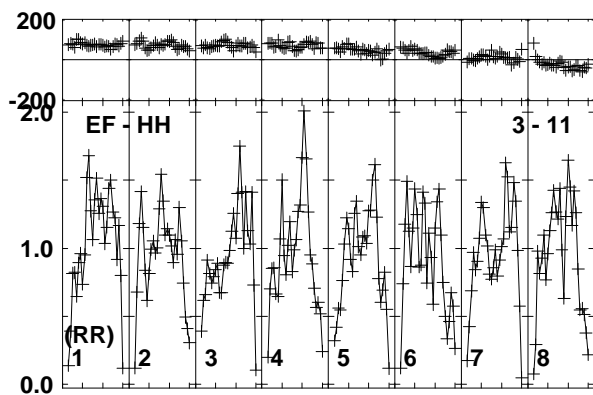
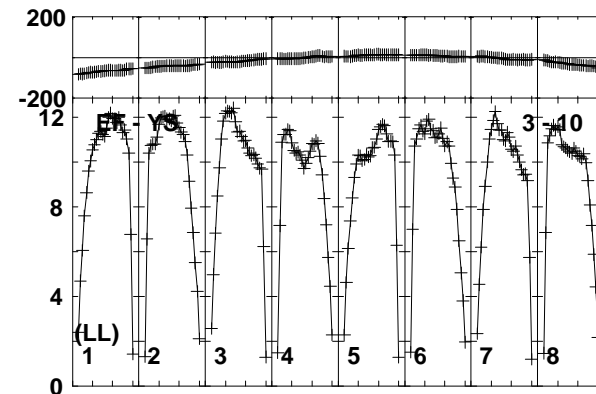
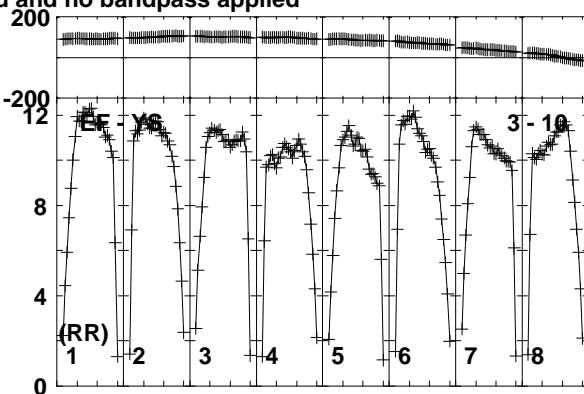
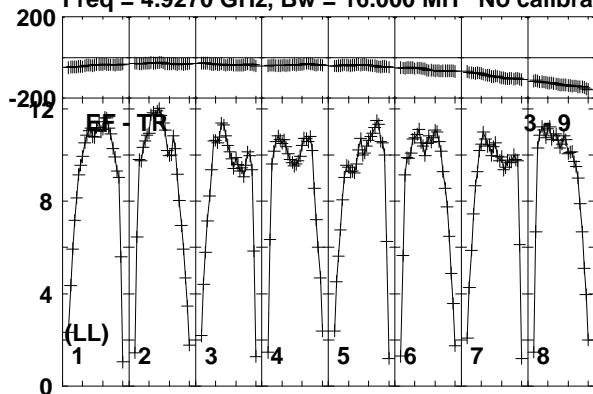

Lower frame: Milli Ampl Jy Top frame: Phas deg  
Vector averaged cross-power spectrum Baseline: EF (03) - TR (09)  
Timerange: 00/10:41:01 to 00/10:41:59

Plot file version 261 created 19-DEC-2018 17:58:28

J1619+2247 RY007C.UVDATA.1

Freq = 4.9270 GHz, Bw = 16.000 MH No calibration applied and no bandpass applied

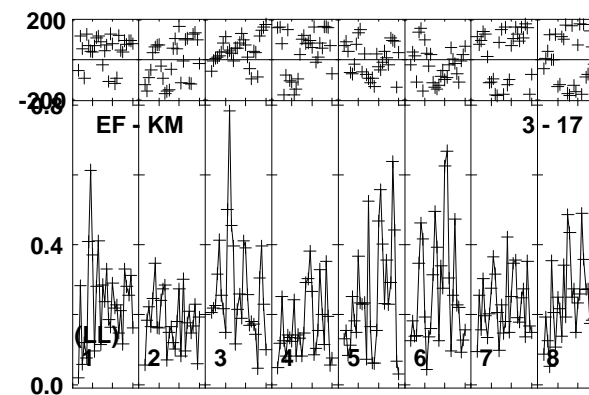
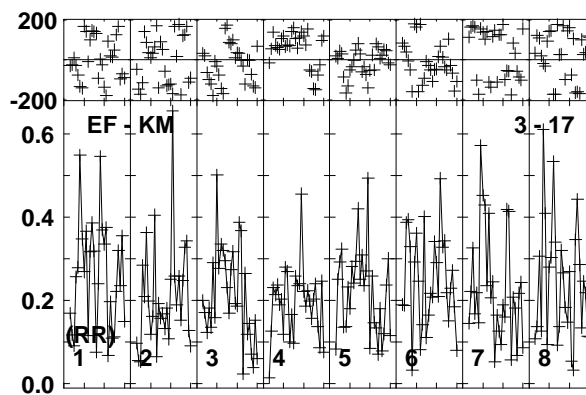
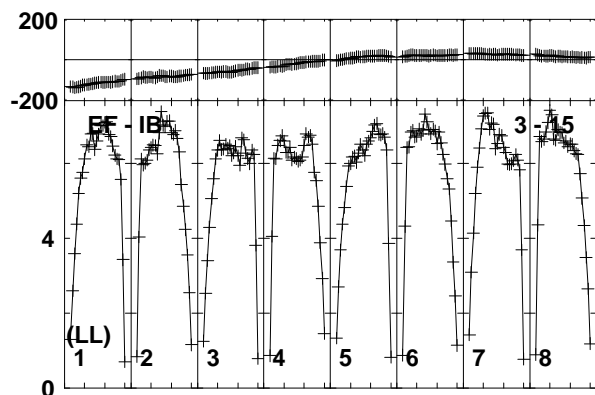
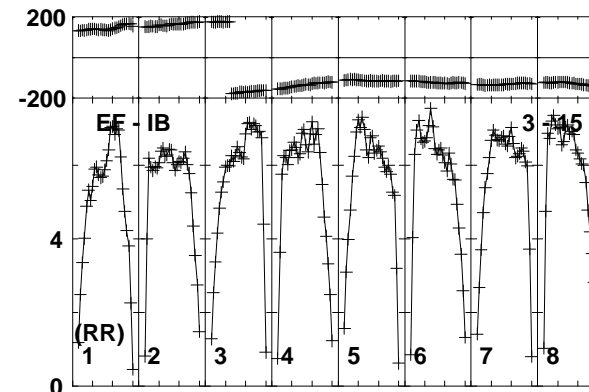
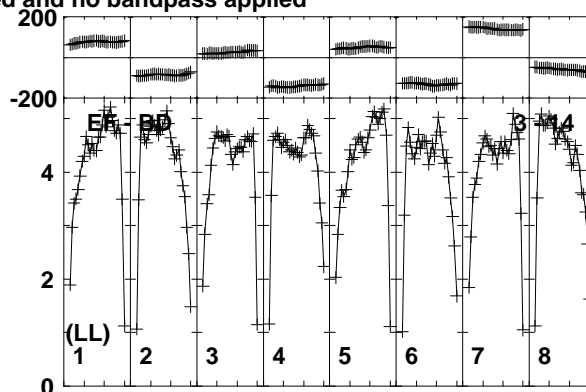
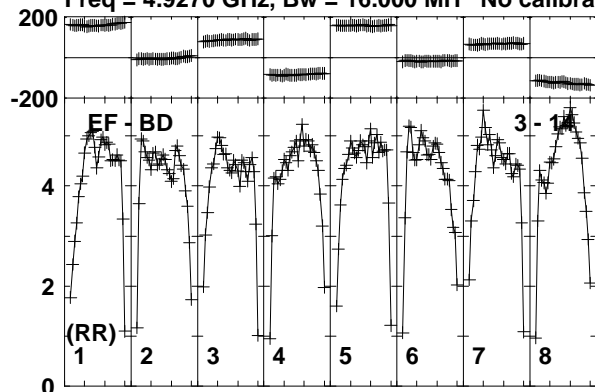

Lower frame: Milli Ampl Jy Top frame: Phas deg  
Vector averaged cross-power spectrum Baseline: EF (03) - BD (14)  
Timerange: 00/10:41:01 to 00/10:41:59

Plot file version 262 created 19-DEC-2018 17:58:28

AT2018\_RY007C.UVDATA.1

Freq = 4.9270 GHz, Bw = 16.000 MH No calibration applied and no bandpass applied

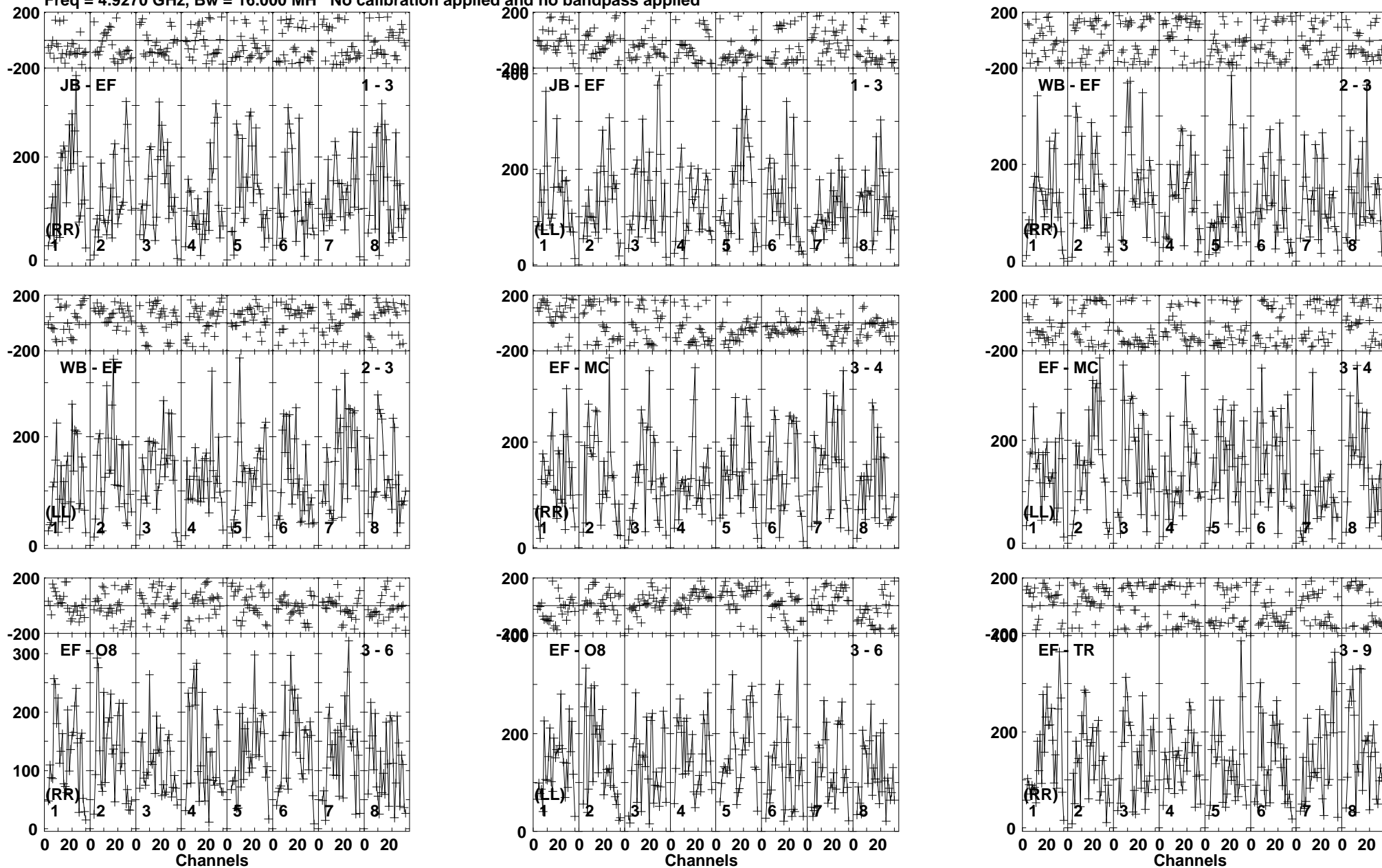

Lower frame: Micro Ampl Jy Top frame: Phas deg  
Vector averaged cross-power spectrum Baseline: JB (01) - EF (03)  
Timerange: 00/10:42:01 to 00/10:43:59

Plot file version 263 created 19-DEC-2018 17:58:28

AT2018\_RY007C.UVDATA.1

Freq = 4.9270 GHz, Bw = 16.000 MH No calibration applied and no bandpass applied

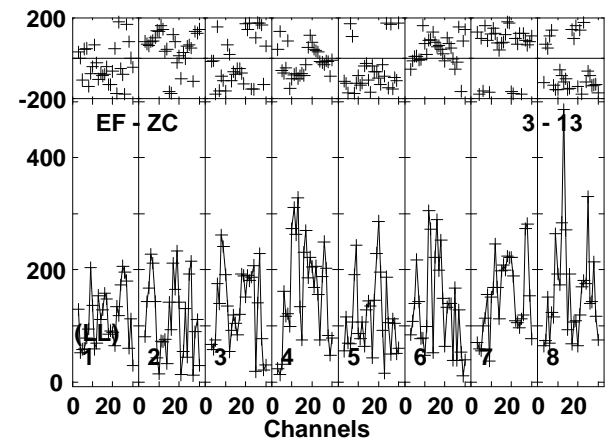
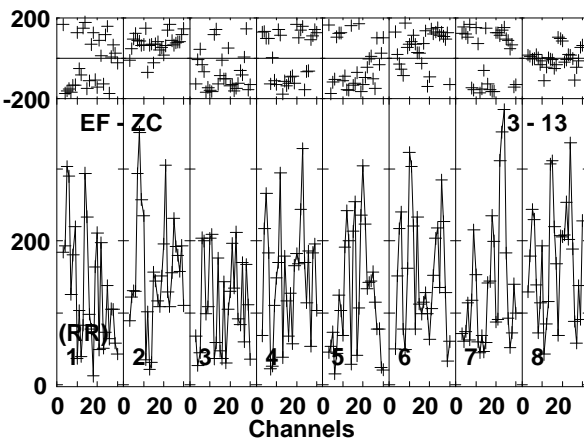
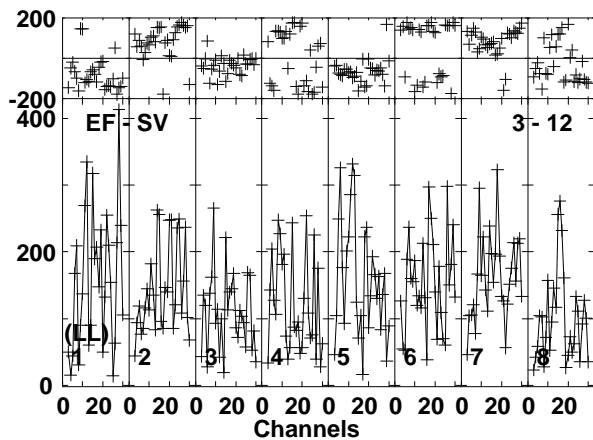
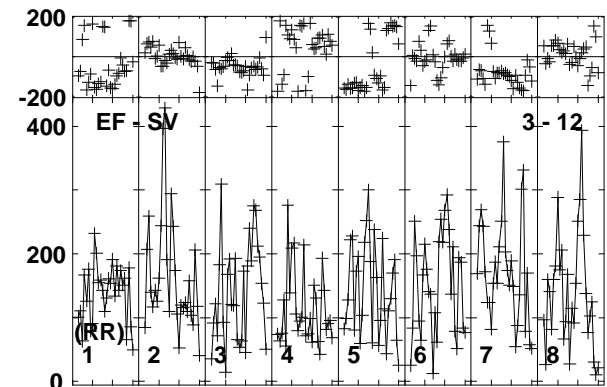
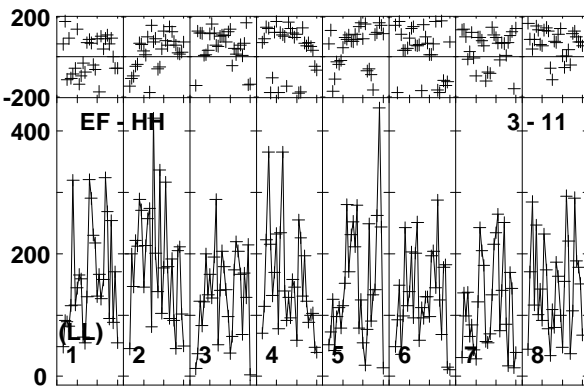
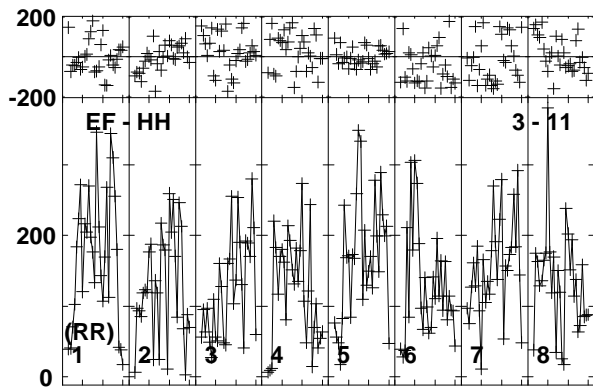
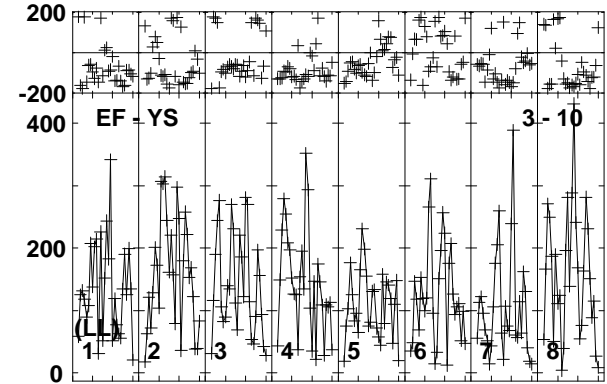
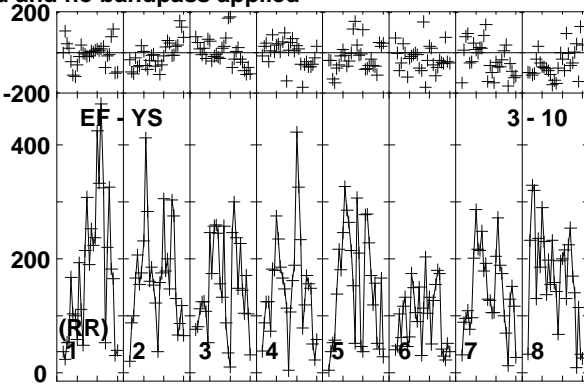
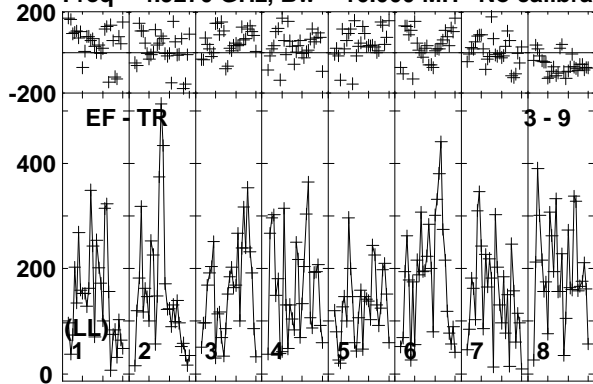

Lower frame: Micro Ampl Jy Top frame: Phas deg  
Vector averaged cross-power spectrum Baseline: EF (03) - TR (09)  
Timerange: 00/10:42:01 to 00/10:43:59

Plot file version 264 created 19-DEC-2018 17:58:29

AT2018\_RY007C.UVDATA.1

Freq = 4.9270 GHz, Bw = 16.000 MH No calibration applied and no bandpass applied

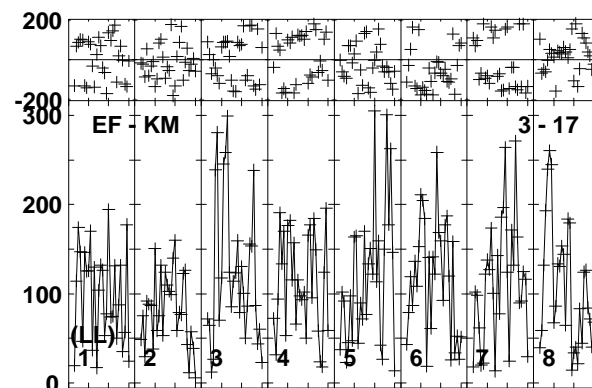
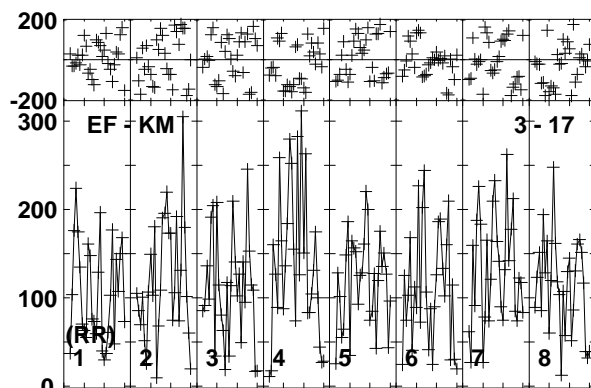
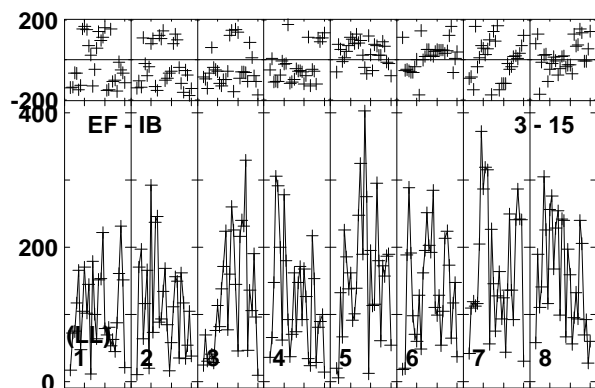
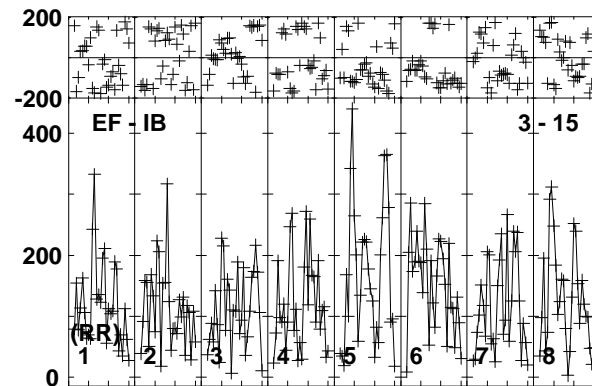
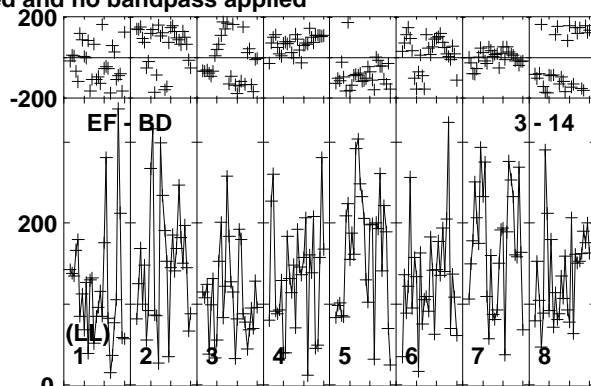
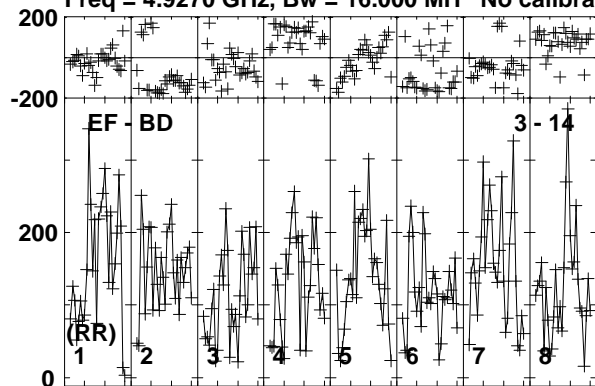

Lower frame: Micro Ampl Jy Top frame: Phas deg  
Vector averaged cross-power spectrum Baseline: EF (03) - BD (14)  
Timerange: 00/10:42:01 to 00/10:43:59

Plot file version 265 created 19-DEC-2018 17:58:29

VLA2 RY007C.UVDATA.1

Freq = 4.9270 GHz, Bw = 16.000 MH No calibration applied and no bandpass applied

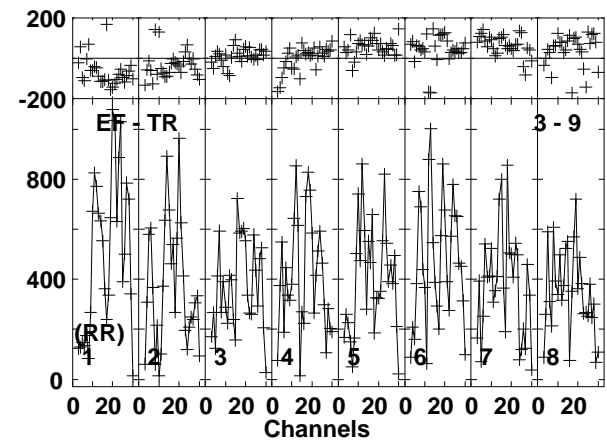
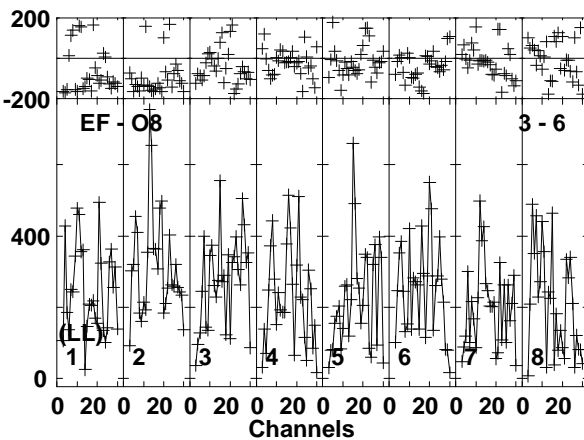
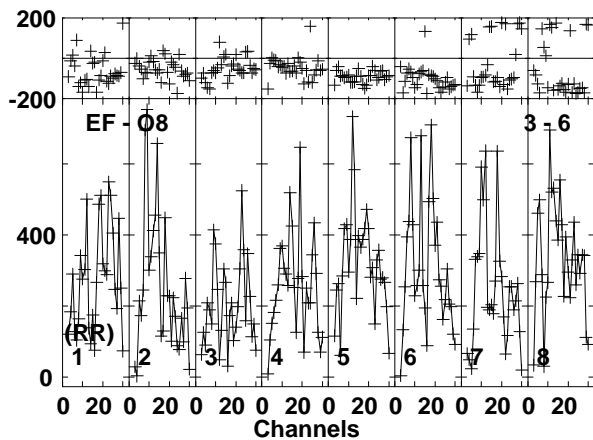
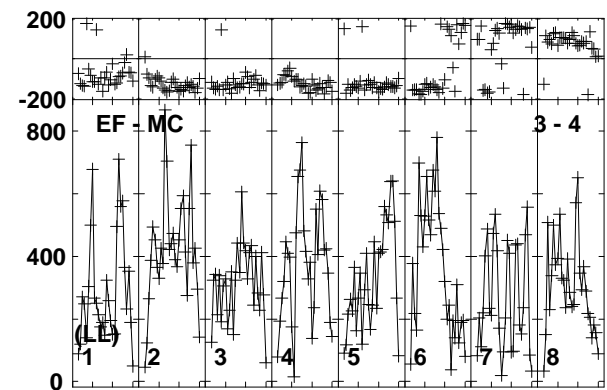
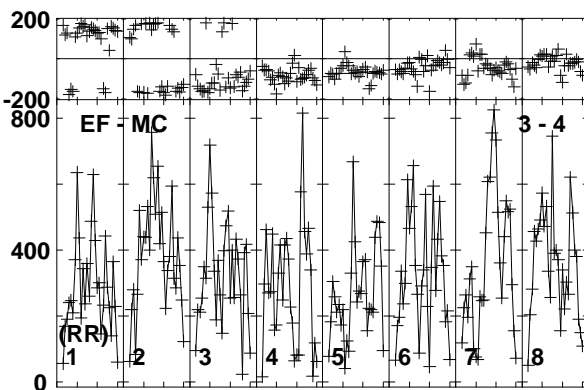
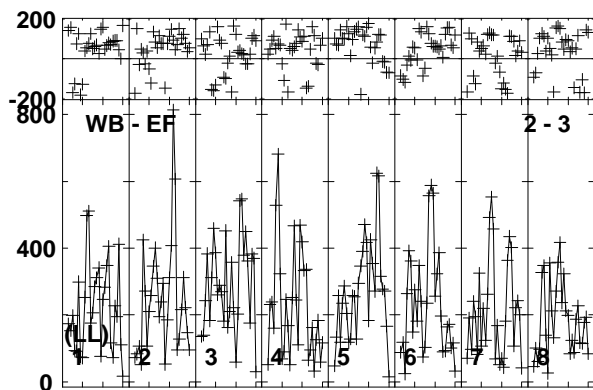
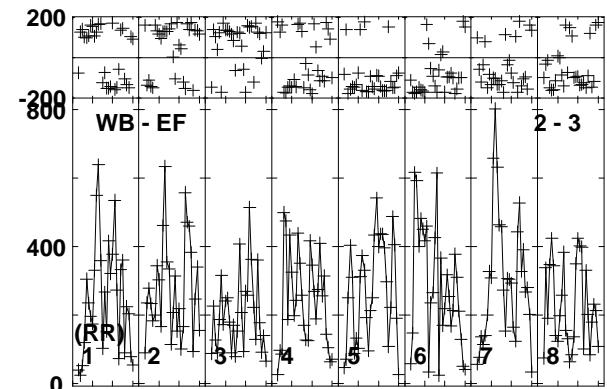
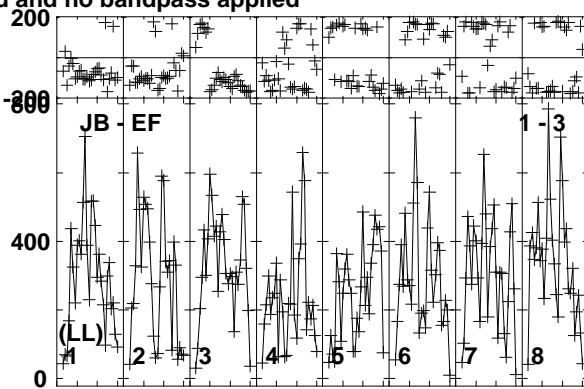
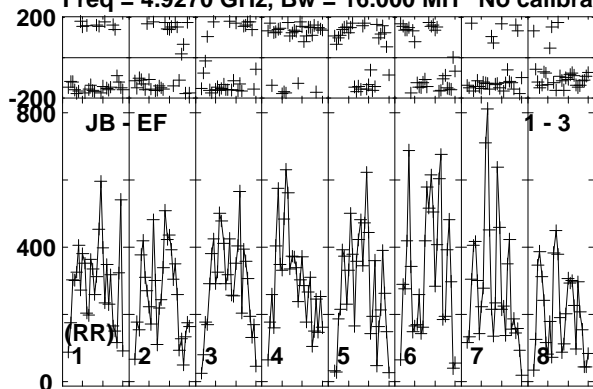

Lower frame: Micro Ampl Jy Top frame: Phas deg  
Vector averaged cross-power spectrum Baseline: JB (01) - EF (03)  
Timerange: 00/10:44:01 to 00/10:44:59

Plot file version 266 created 19-DEC-2018 17:58:29

VLA2\_RY007C.UVDATA.1

Freq = 4.9270 GHz, Bw = 16.000 MH No calibration applied and no bandpass applied

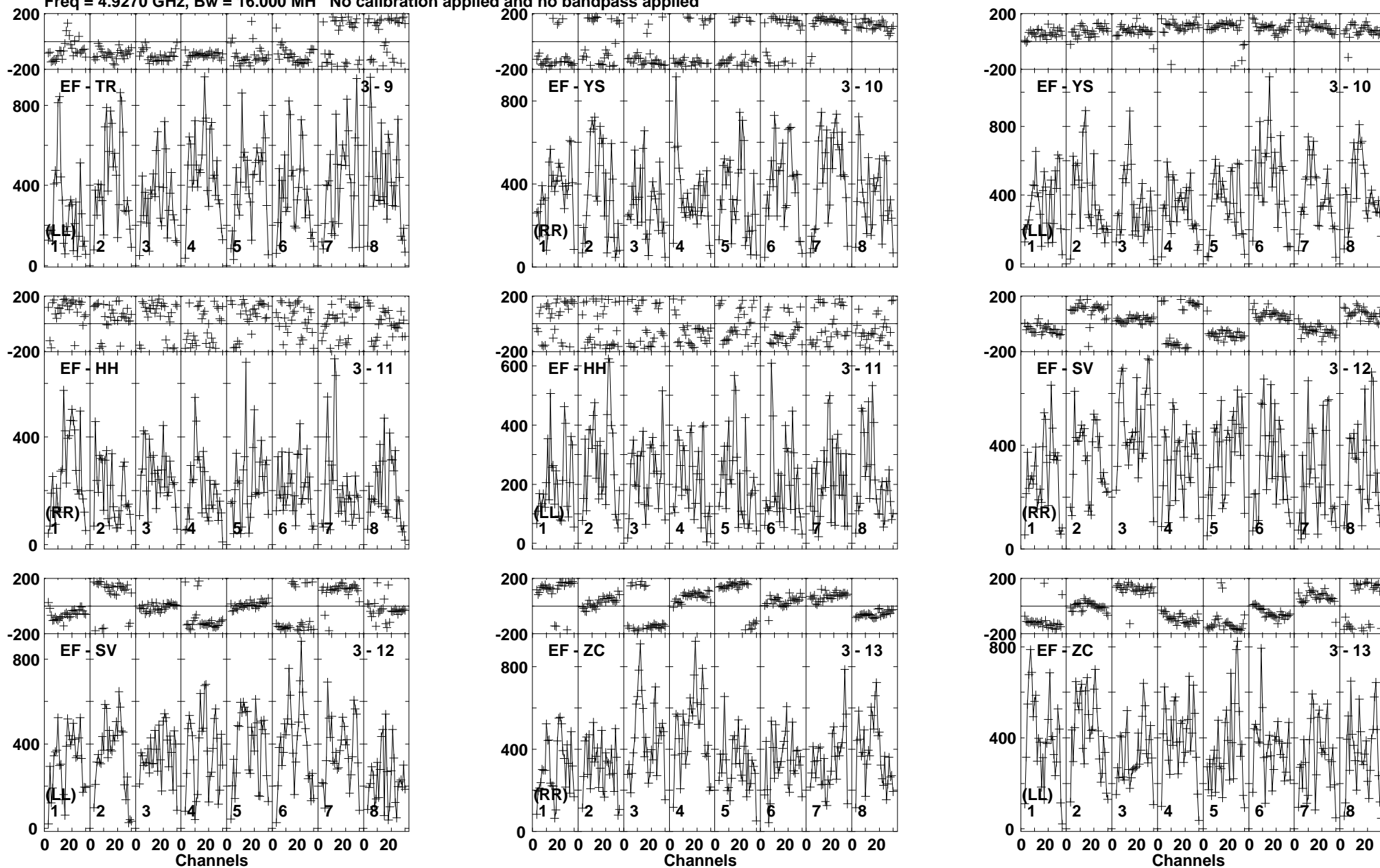

Lower frame: Micro Ampl Jy Top frame: Phas deg  
Vector averaged cross-power spectrum Baseline: EF (03) - TR (09)  
Timerange: 00/10:44:01 to 00/10:44:59



Plot file version 267 created 19-DEC-2018 17:58:29

VLA2 RY007C.UVDATA.1

Freq = 4.9270 GHz, Bw = 16.000 MH No calibration applied and no bandpass applied

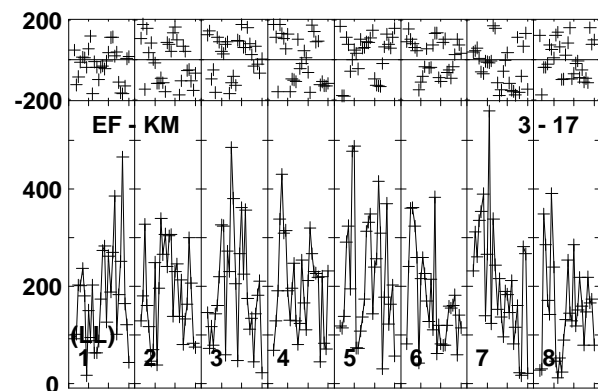
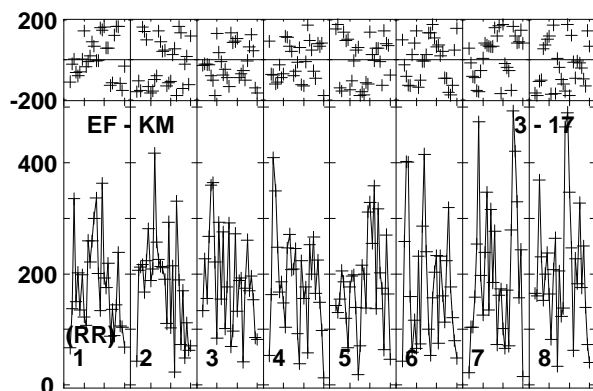
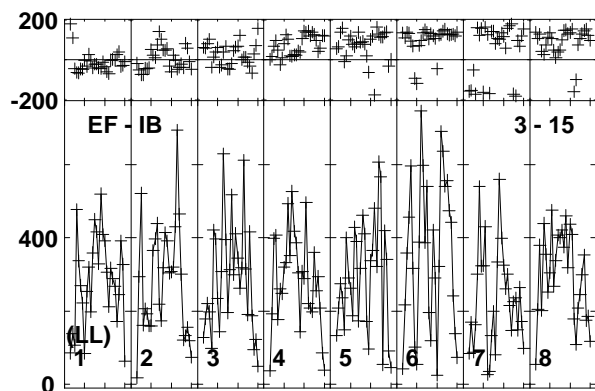
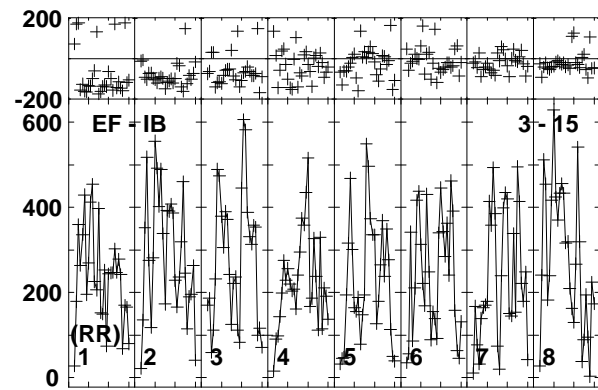
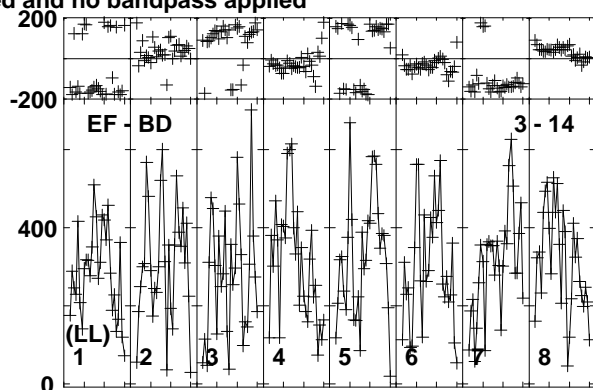
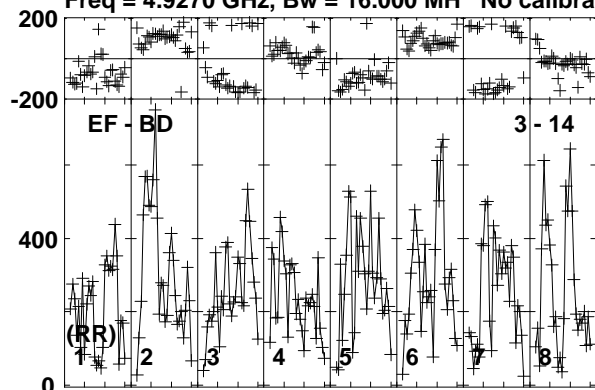

Lower frame: Micro Ampl Jy Top frame: Phas deg  
Vector averaged cross-power spectrum Baseline: EF (03) - BD (14)  
Timerange: 00/10:44:01 to 00/10:44:59

Plot file version 268 created 19-DEC-2018 17:58:29

J1619+2247 RY007C.UVDATA.1

Freq = 4.9270 GHz, Bw = 16.000 MH No calibration applied and no bandpass applied

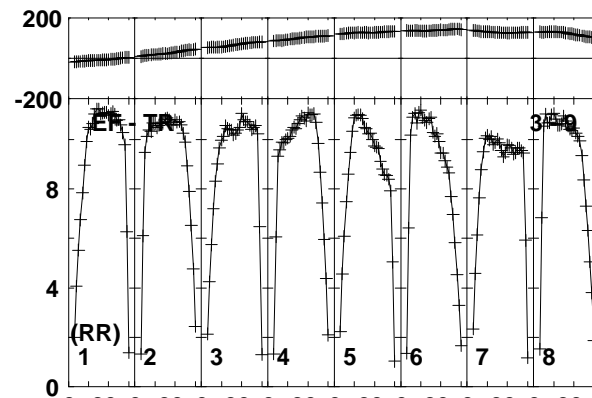
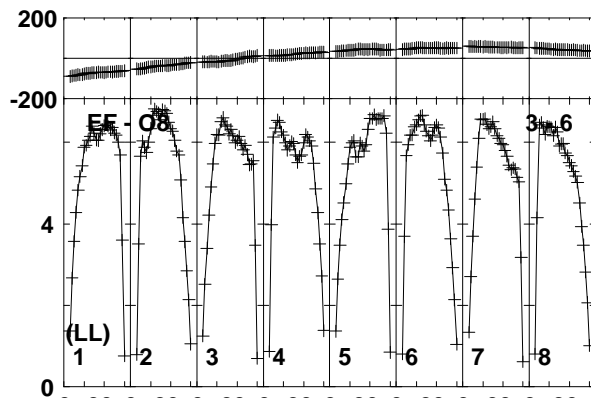
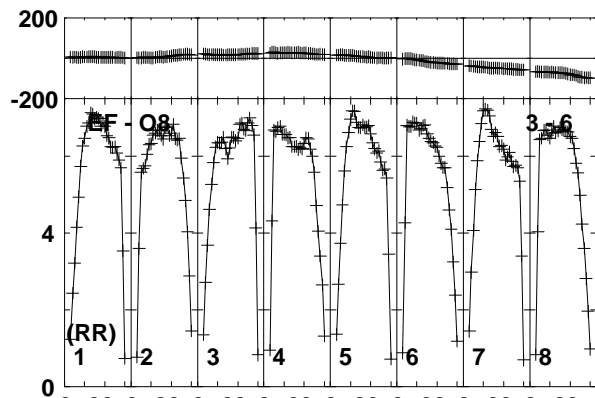
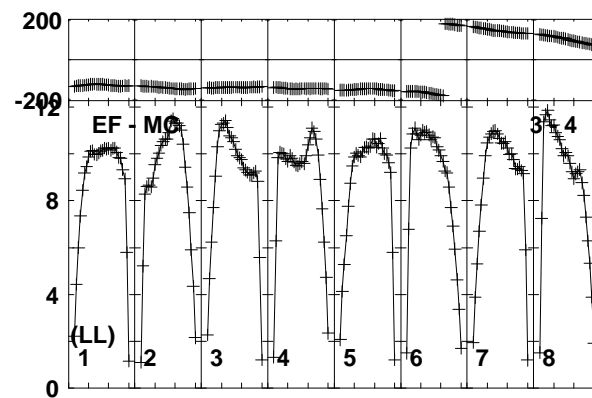
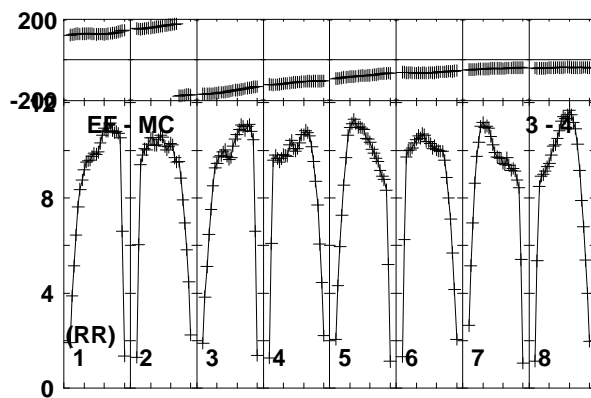
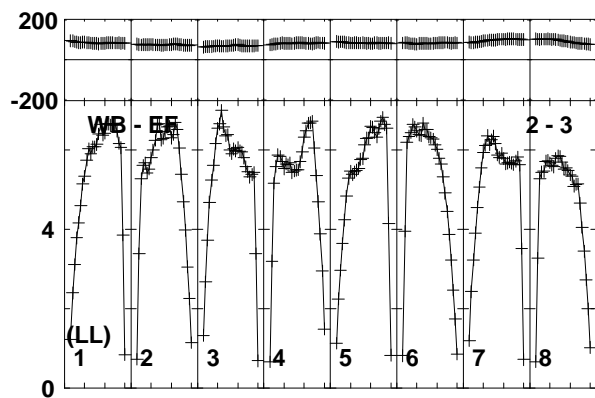
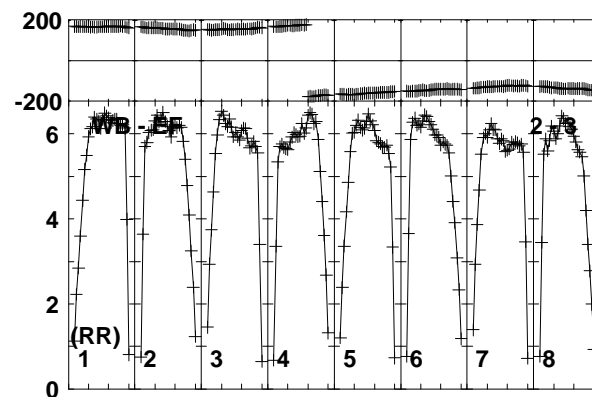
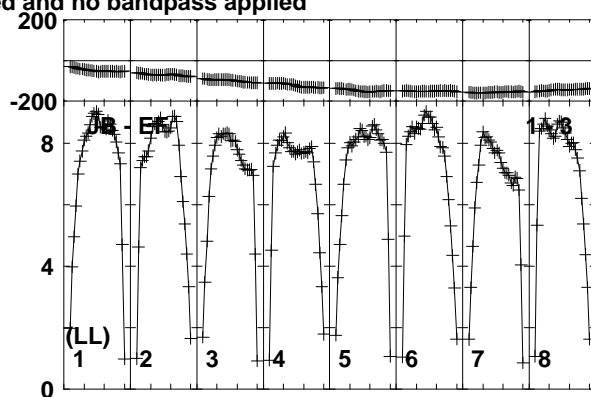
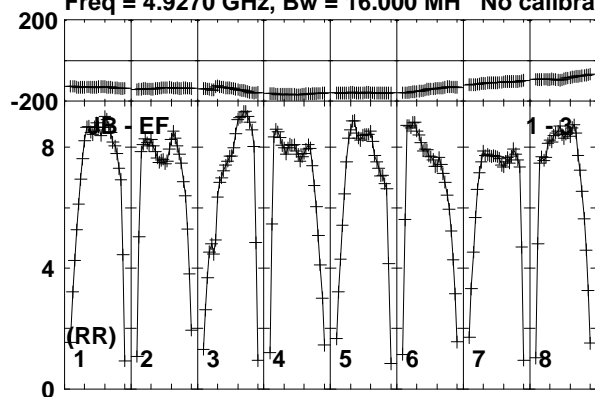

Lower frame: Milli Ampl Jy Top frame: Phas deg  
Vector averaged cross-power spectrum Baseline: JB (01) - EF (03)  
Timerange: 00/10:45:31 to 00/10:46:29

Plot file version 269 created 19-DEC-2018 17:58:29

J1619+2247 RY007C.UVDATA.1

Freq = 4.9270 GHz, Bw = 16.000 MH No calibration applied and no bandpass applied

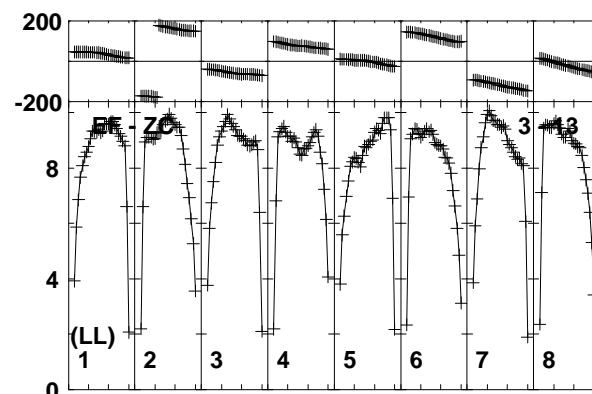
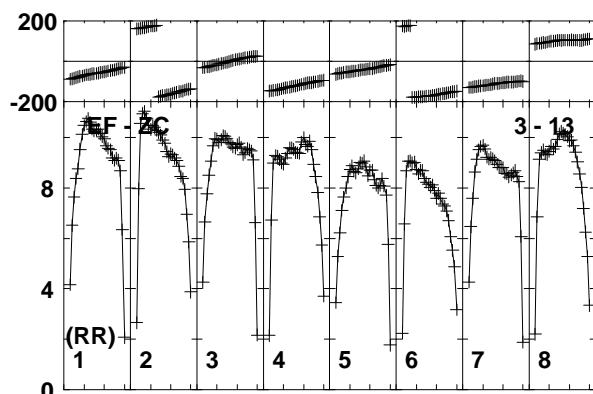
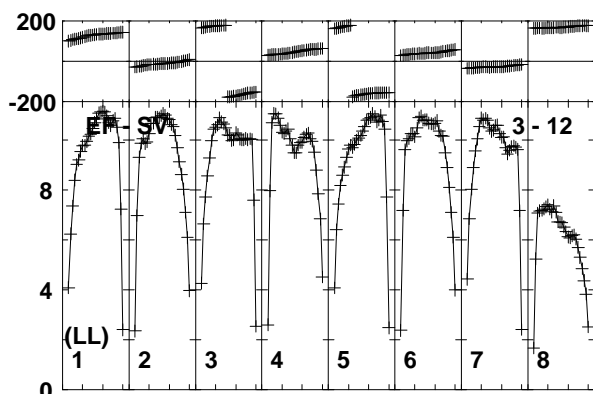
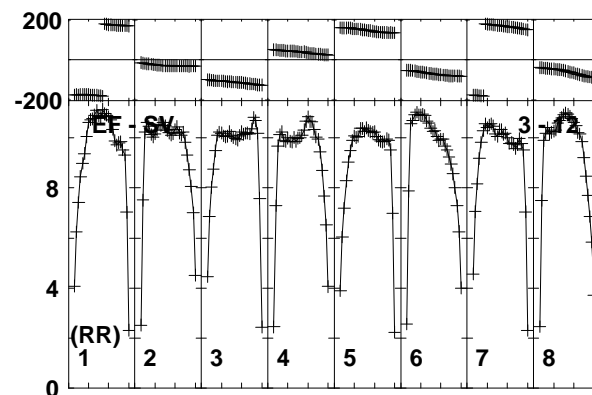
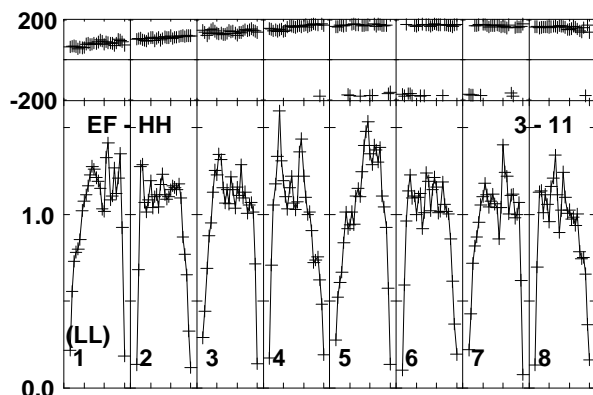
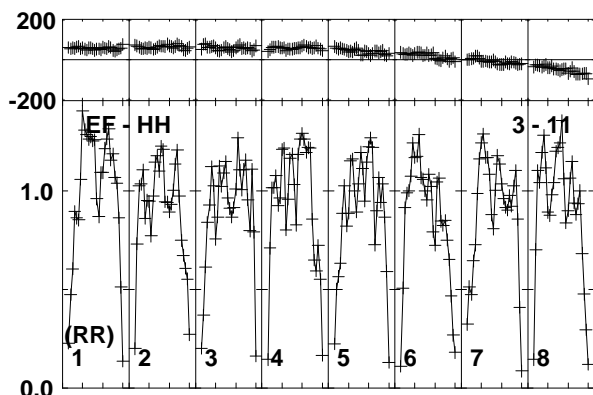
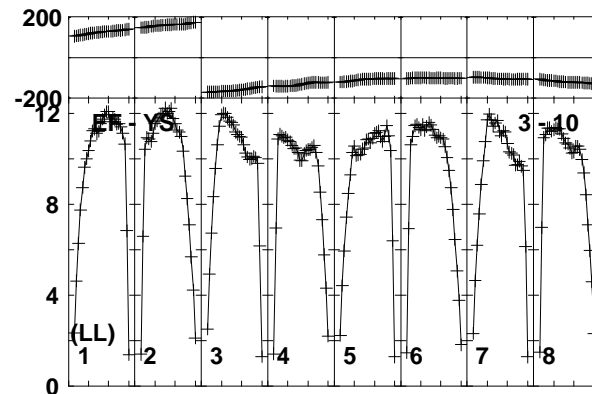
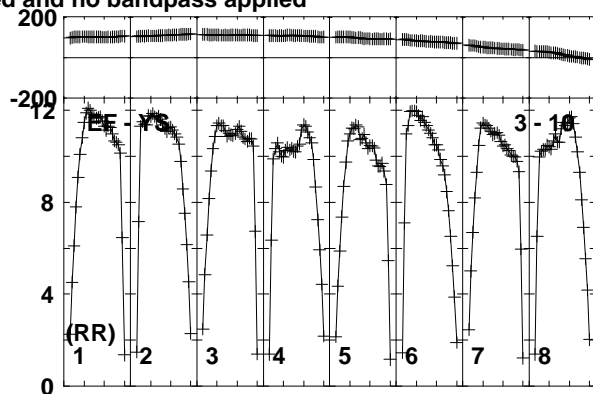
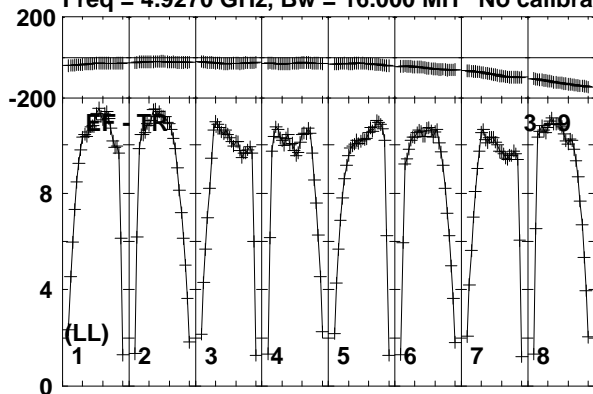

Lower frame: Milli Ampl Jy Top frame: Phas deg  
Vector averaged cross-power spectrum Baseline: EF (03) - TR (09)  
Timerange: 00/10:45:31 to 00/10:46:29

Plot file version 270 created 19-DEC-2018 17:58:29

J1619+2247 RY007C.UVDATA.1

Freq = 4.9270 GHz, Bw = 16.000 MH No calibration applied and no bandpass applied

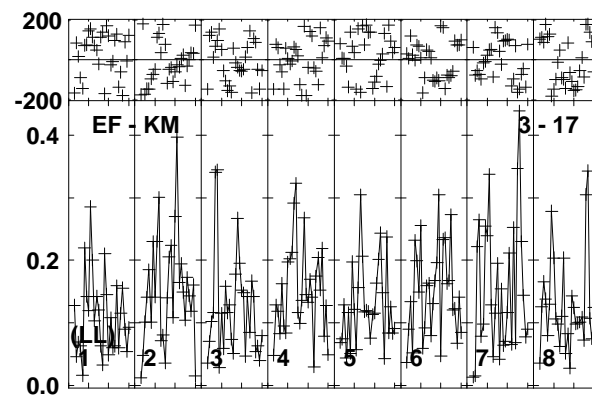
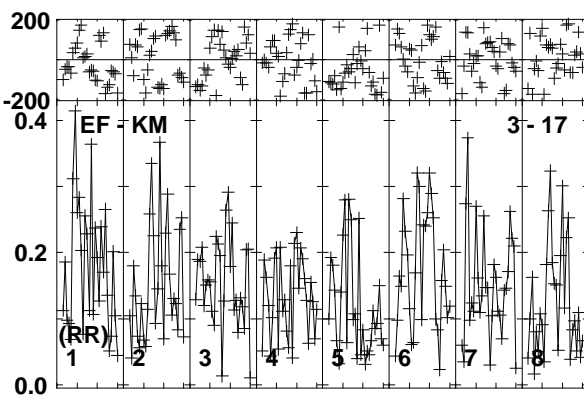
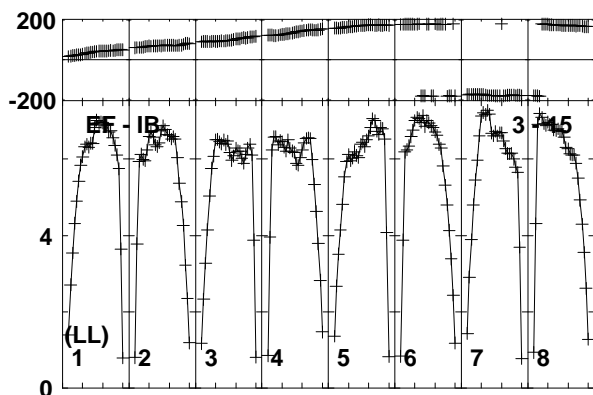
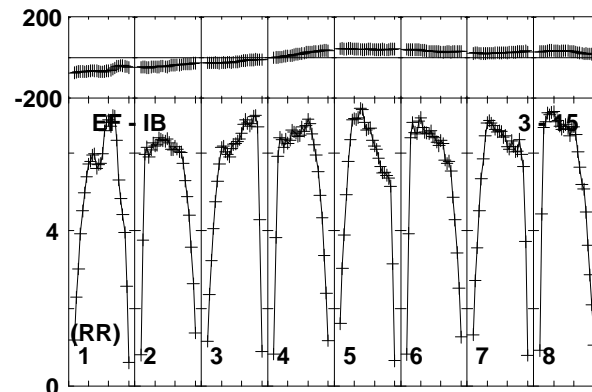
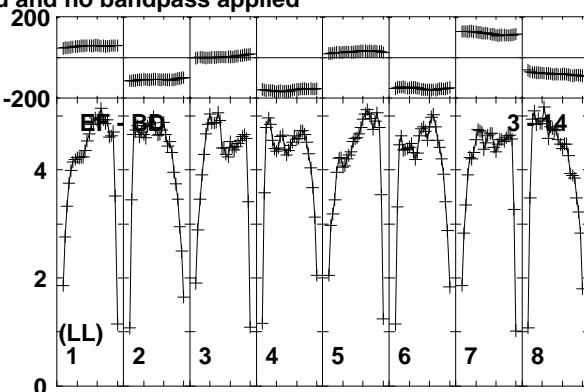
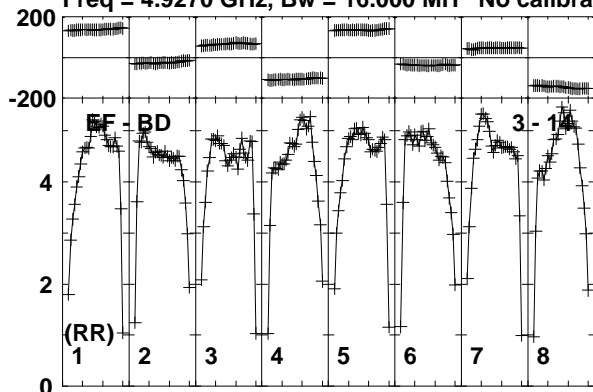

Lower frame: Milli Ampl Jy Top frame: Phas deg  
Vector averaged cross-power spectrum Baseline: EF (03) - BD (14)  
Timerange: 00/10:45:31 to 00/10:46:29

Plot file version 271 created 19-DEC-2018 17:58:29

AT2018\_RY007C.UVDATA.1

Freq = 4.9270 GHz, Bw = 16.000 MH No calibration applied and no bandpass applied

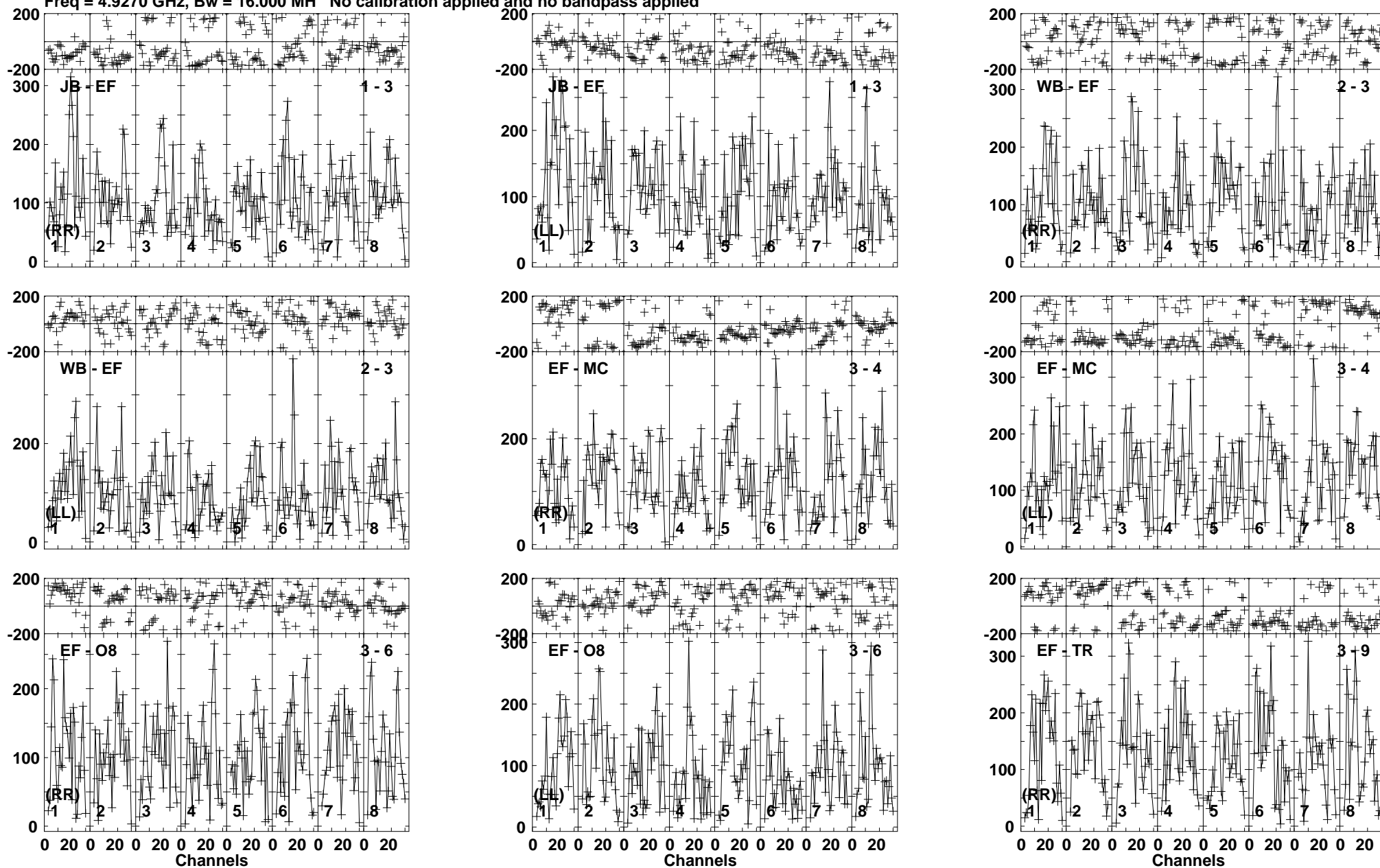

Lower frame: Micro Ampl Jy Top frame: Phas deg  
Vector averaged cross-power spectrum Baseline: JB (01) - EF (03)  
Timerange: 00/10:46:31 to 00/10:49:29

Plot file version 272 created 19-DEC-2018 17:58:29

AT2018\_RY007C.UVDATA.1

Freq = 4.9270 GHz, Bw = 16.000 MH No calibration applied and no bandpass applied

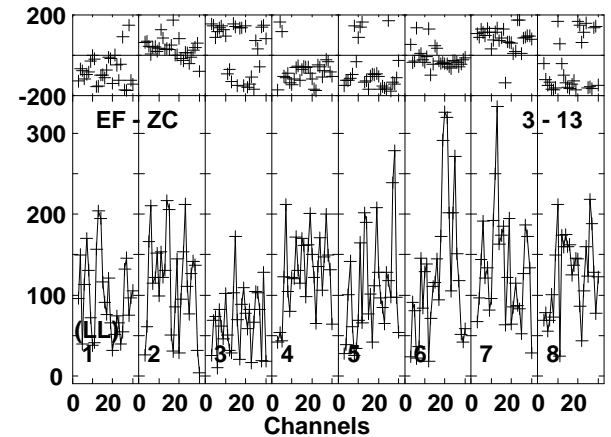
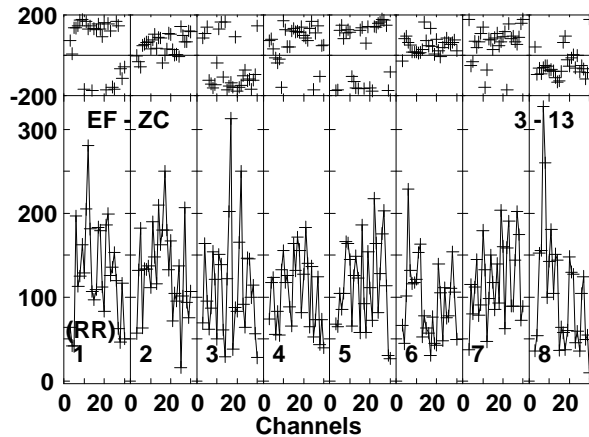
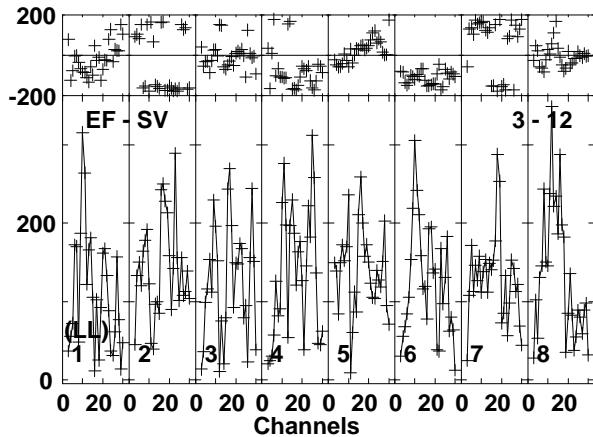
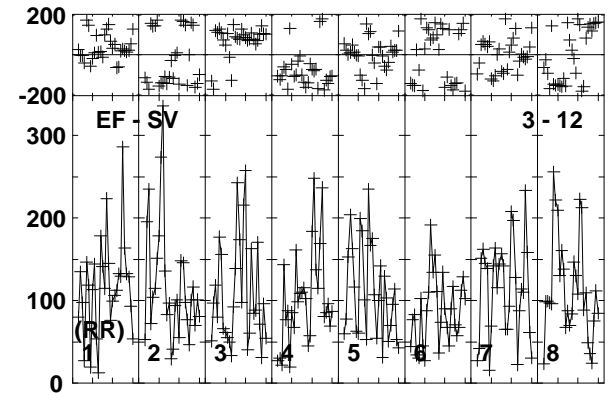
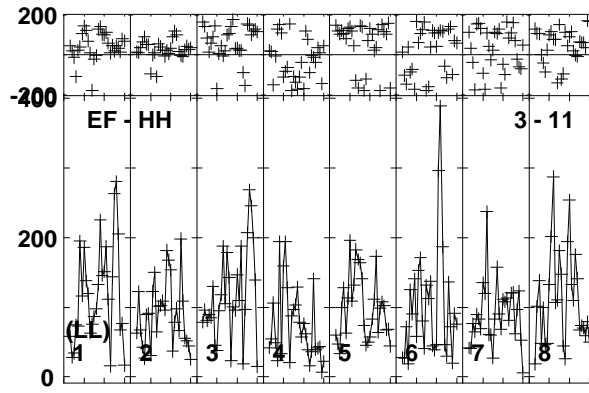
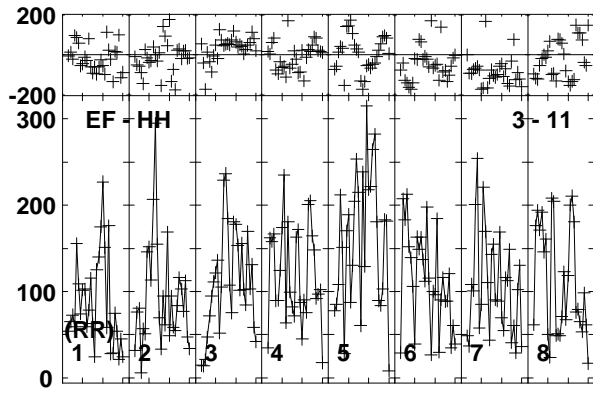
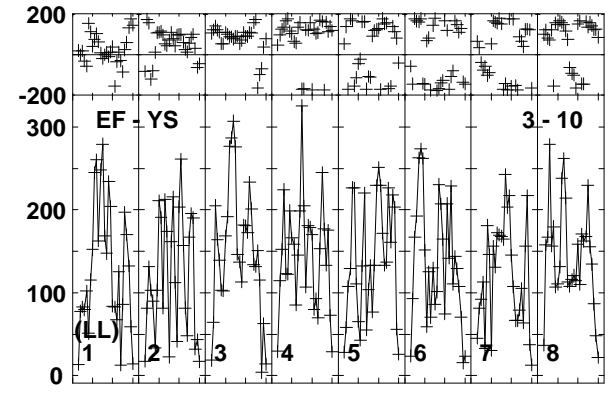
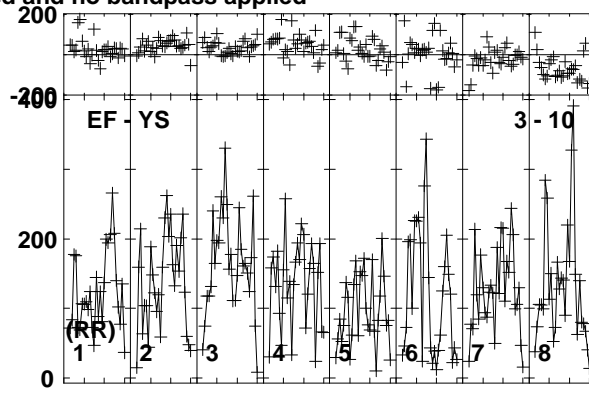
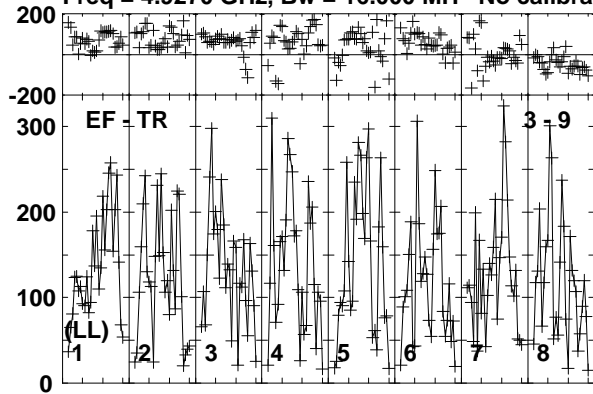

Lower frame: Micro Ampl Jy Top frame: Phas deg  
Vector averaged cross-power spectrum Baseline: EF (03) - TR (09)  
Timerange: 00/10:46:31 to 00/10:49:29

Plot file version 273 created 19-DEC-2018 17:58:29

AT2018\_RY007C.UVDATA.1

Freq = 4.9270 GHz, Bw = 16.000 MH No calibration applied and no bandpass applied

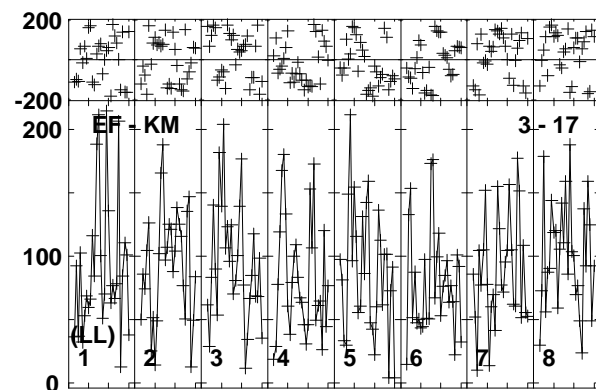
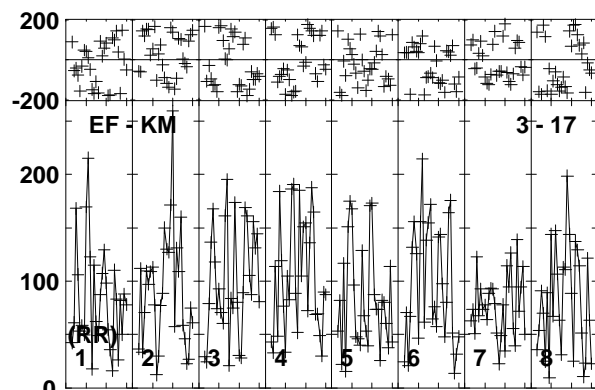
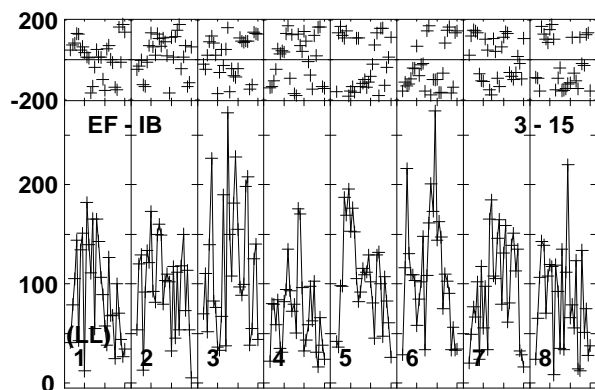
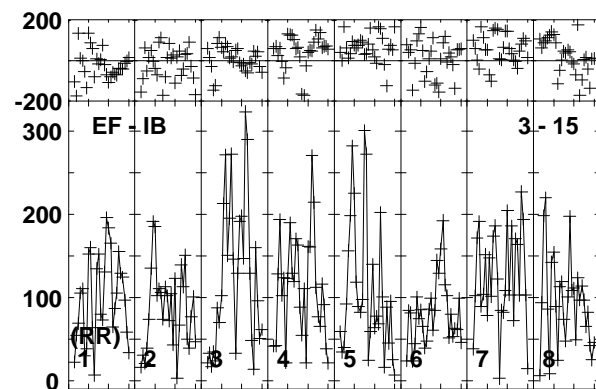
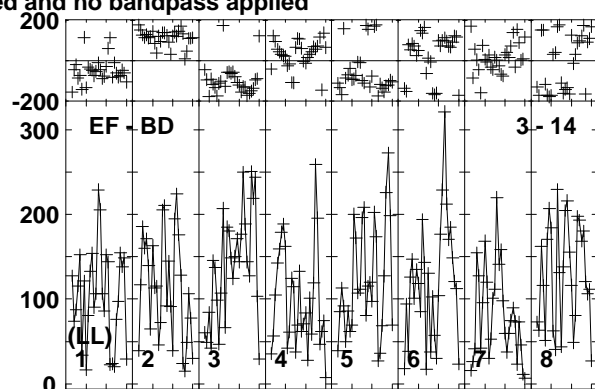
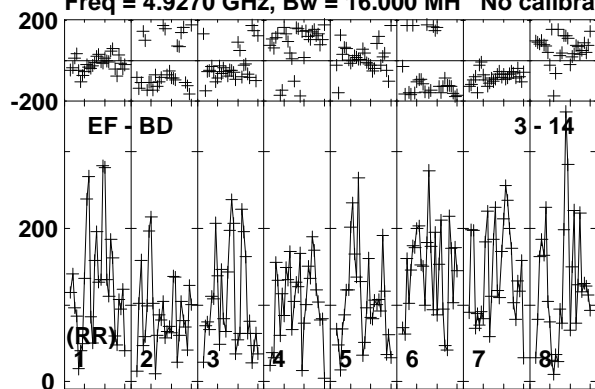

Lower frame: Micro Ampl Jy Top frame: Phas deg  
Vector averaged cross-power spectrum Baseline: EF (03) - BD (14)  
Timerange: 00/10:46:31 to 00/10:49:29

Plot file version 274 created 19-DEC-2018 17:58:29

J1619+2247 RY007C.UVDATA.1

Freq = 4.9270 GHz, Bw = 16.000 MH No calibration applied and no bandpass applied

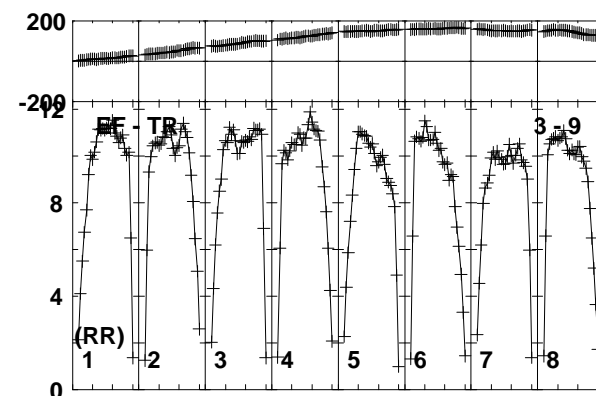
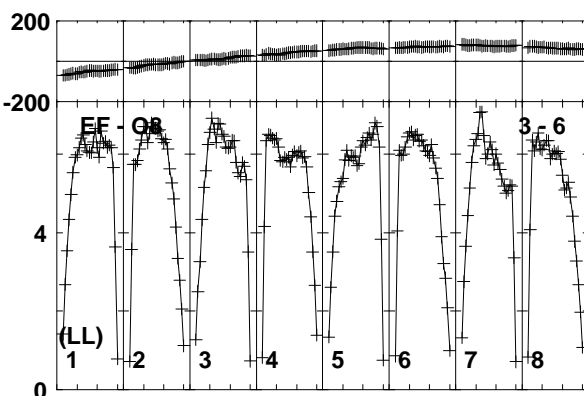
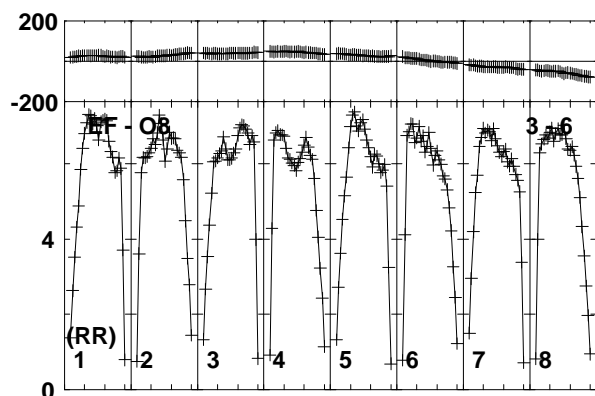
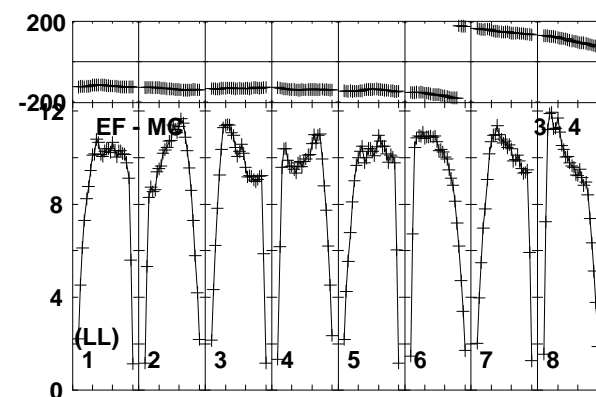
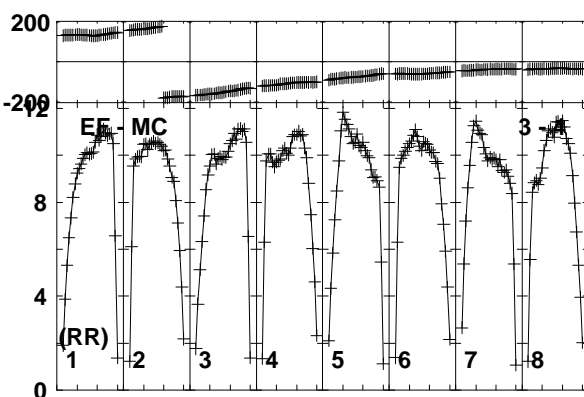
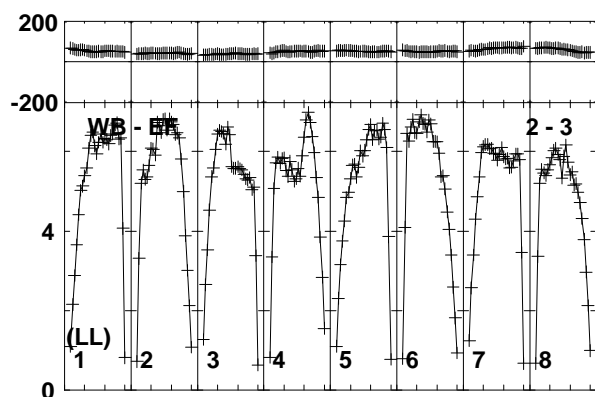
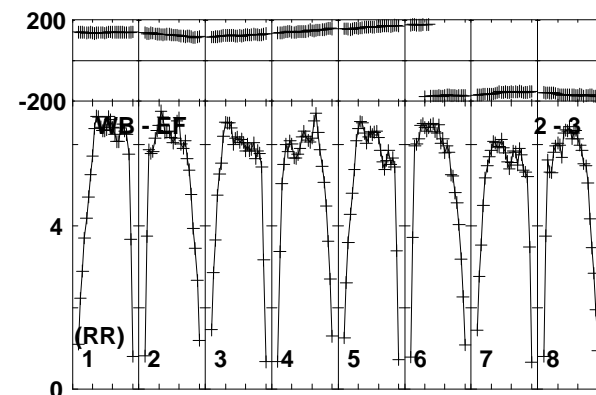
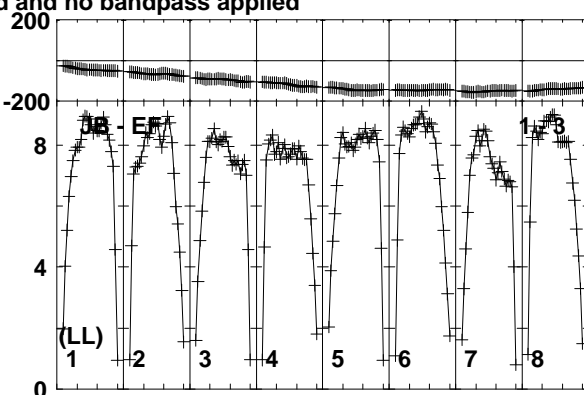
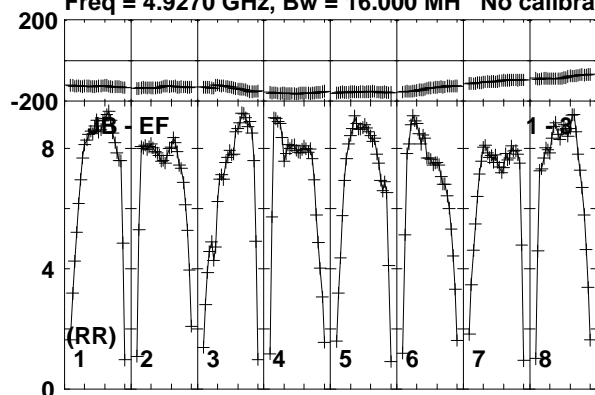

Lower frame: Milli Ampl Jy Top frame: Phas deg  
Vector averaged cross-power spectrum Baseline: JB (01) - EF (03)  
Timerange: 00/10:49:31 to 00/10:50:29



Plot file version 275 created 19-DEC-2018 17:58:29

J1619+2247 RY007C.UVDATA.1

Freq = 4.9270 GHz, Bw = 16.000 MH No calibration applied and no bandpass applied

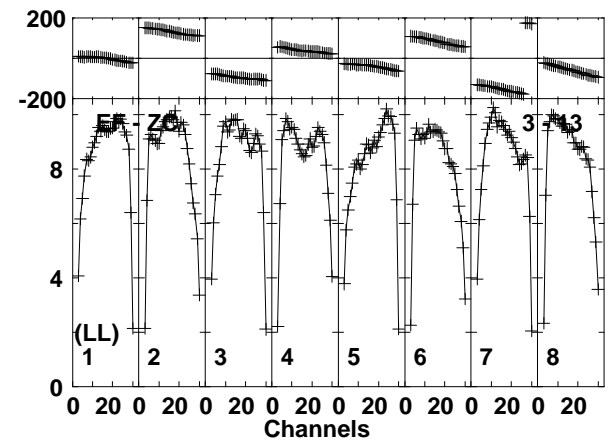
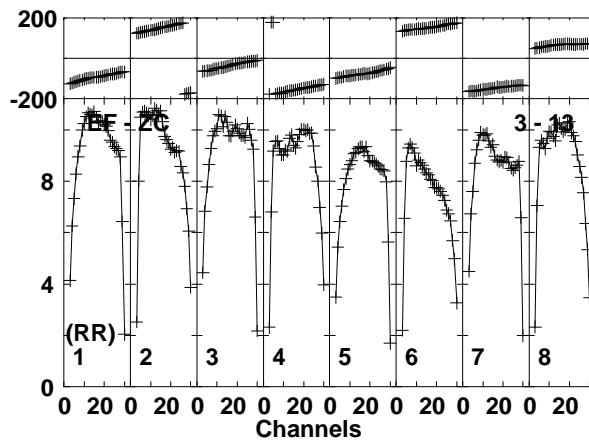
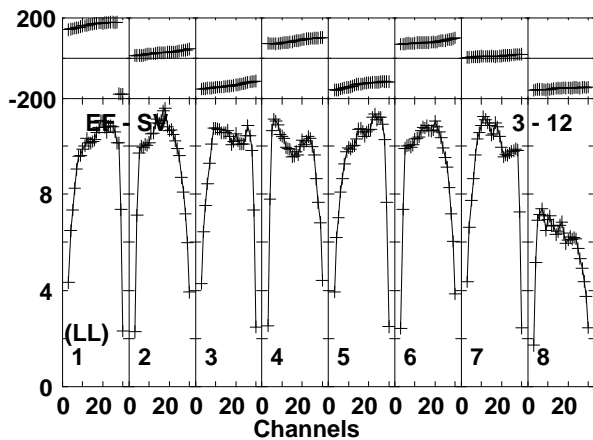
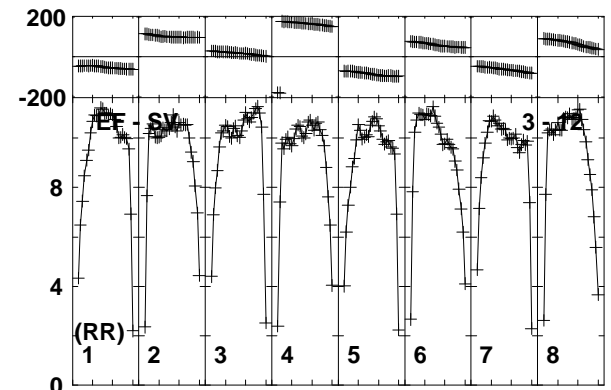
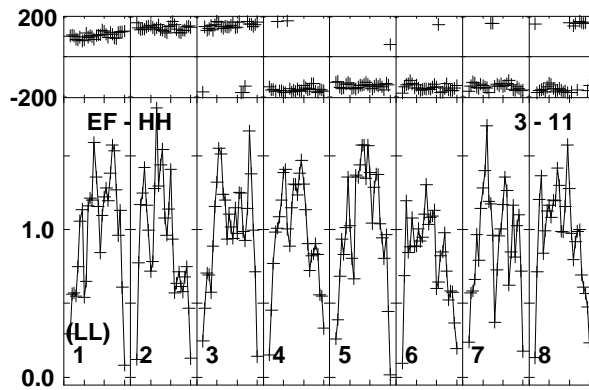
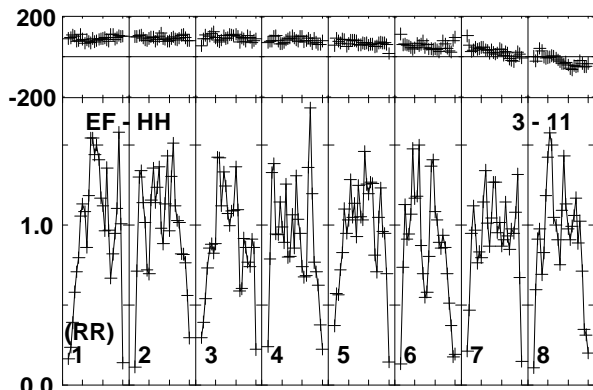
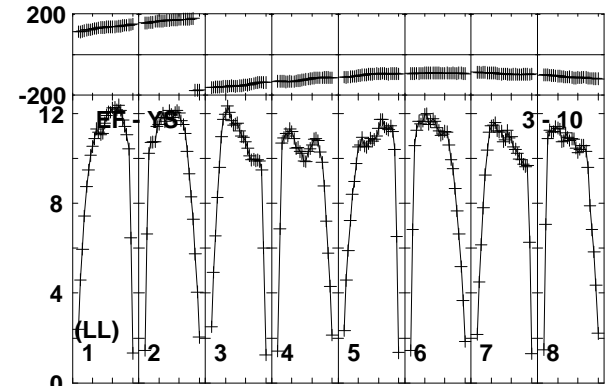
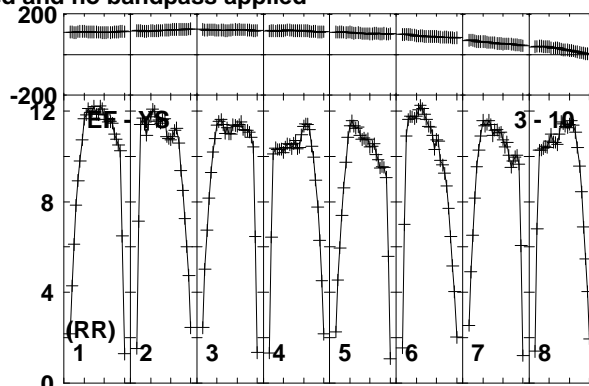
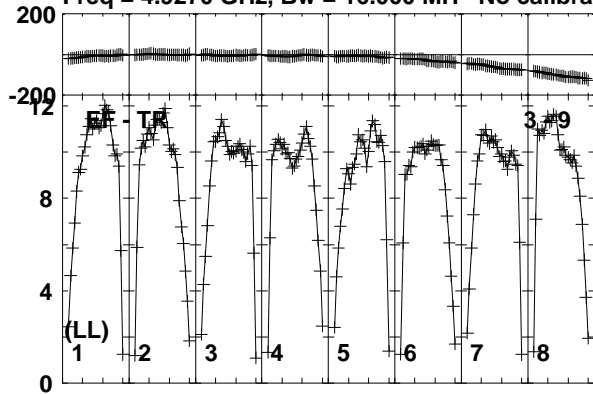

Lower frame: Milli Ampl Jy Top frame: Phas deg  
Vector averaged cross-power spectrum Baseline: EF (03) - TR (09)  
Timerange: 00/10:49:31 to 00/10:50:29

Plot file version 276 created 19-DEC-2018 17:58:29

J1619+2247 RY007C.UVDATA.1

Freq = 4.9270 GHz, Bw = 16.000 MH No calibration applied and no bandpass applied

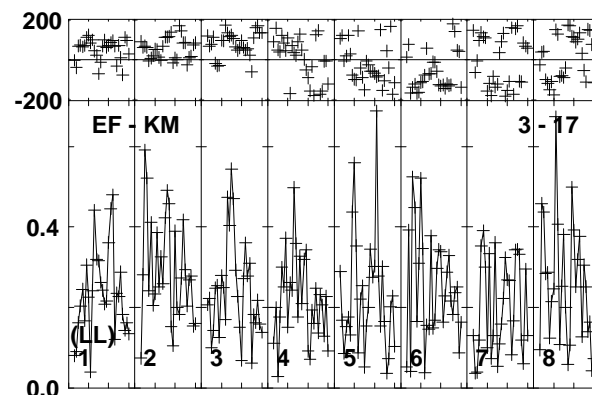
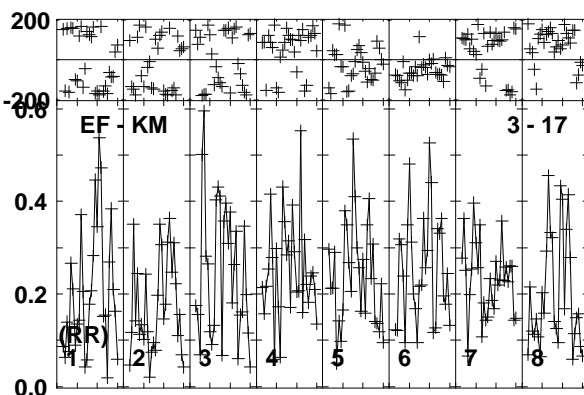
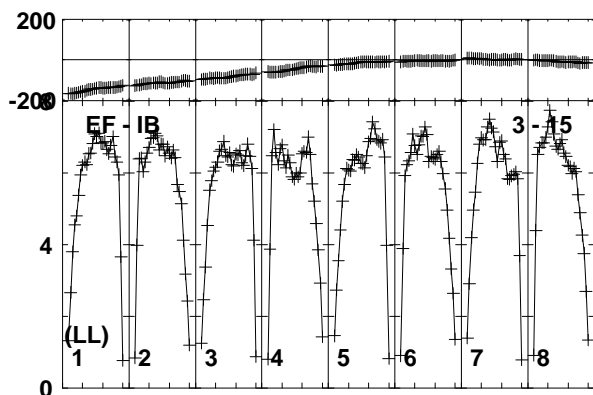
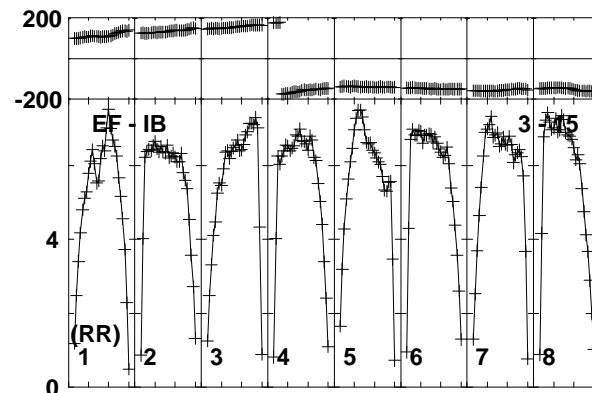
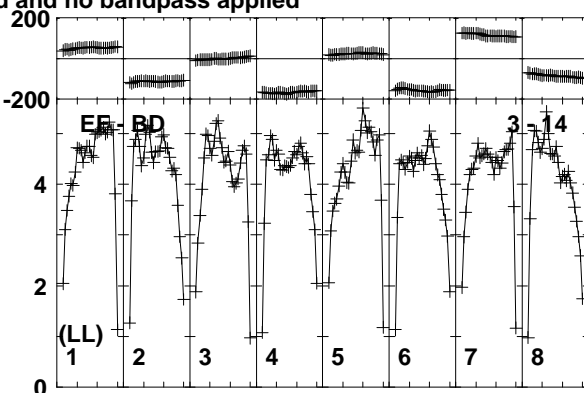
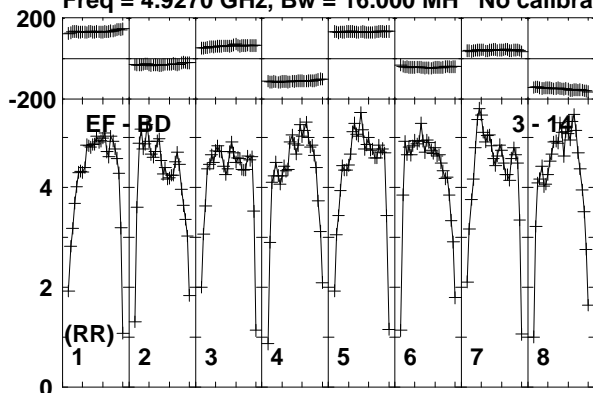

Lower frame: Milli Ampl Jy Top frame: Phas deg  
Vector averaged cross-power spectrum Baseline: EF (03) - BD (14)  
Timerange: 00/10:49:31 to 00/10:50:29

Plot file version 277 created 19-DEC-2018 17:58:29

AT2018\_RY007C.UVDATA.1

Freq = 4.9270 GHz, Bw = 16.000 MH No calibration applied and no bandpass applied

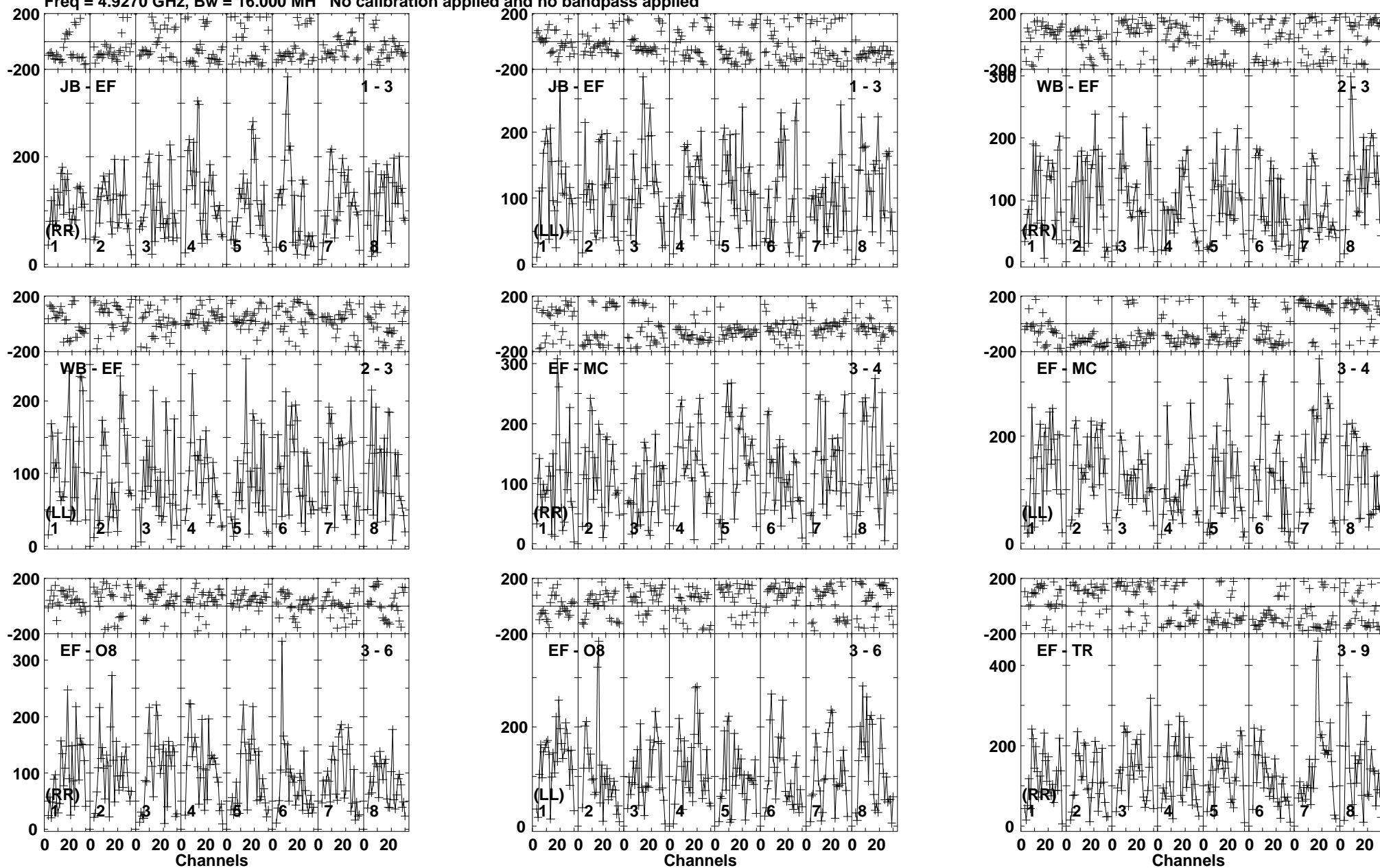

Lower frame: Micro Ampl Jy Top frame: Phas deg  
Vector averaged cross-power spectrum Baseline: JB (01) - EF (03)  
Timerange: 00/10:50:31 to 00/10:53:29

Plot file version 278 created 19-DEC-2018 17:58:29

AT2018\_RY007C.UVDATA.1

Freq = 4.9270 GHz, Bw = 16.000 MH No calibration applied and no bandpass applied

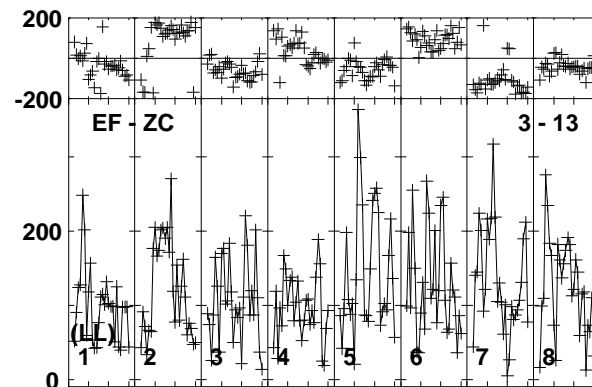
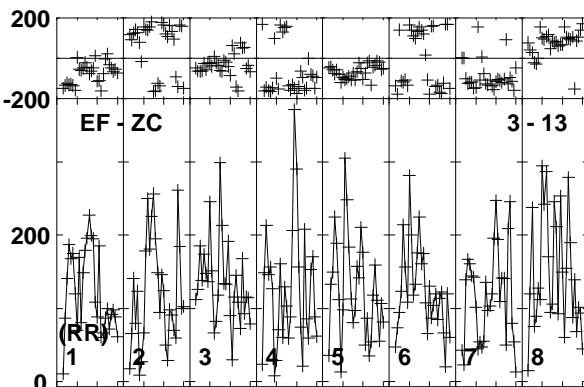
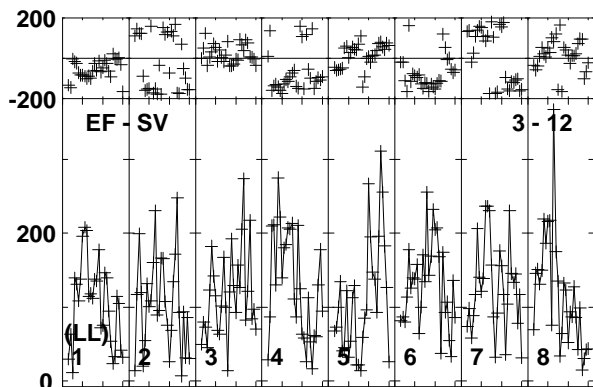
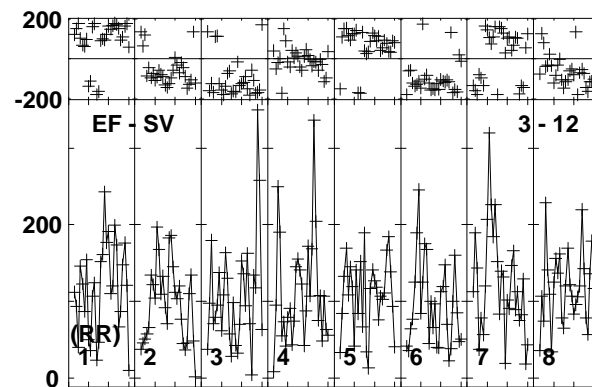
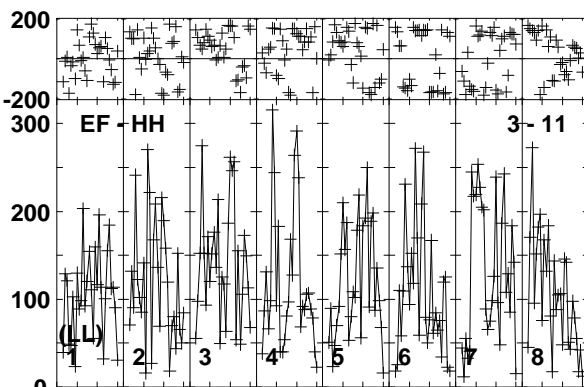
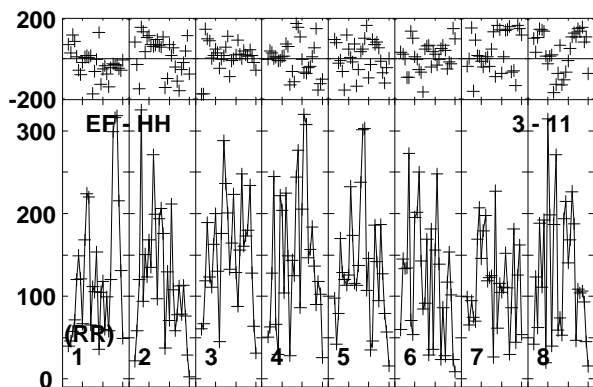
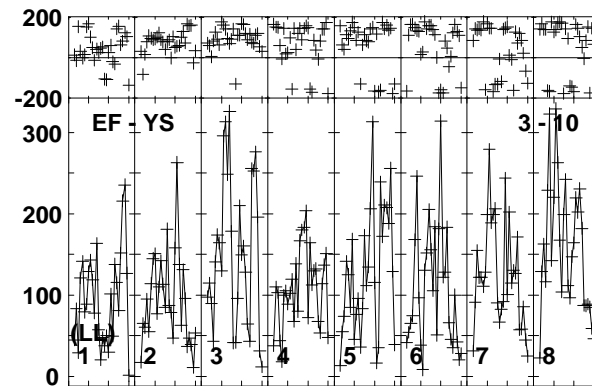
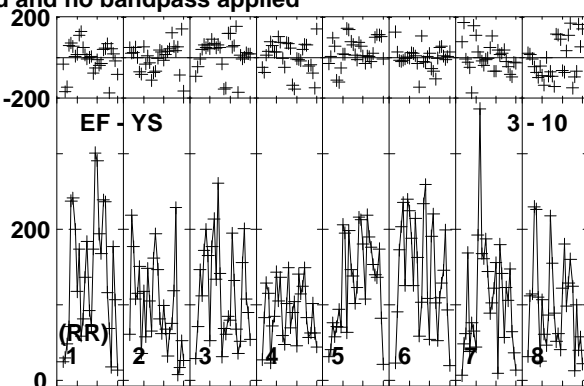
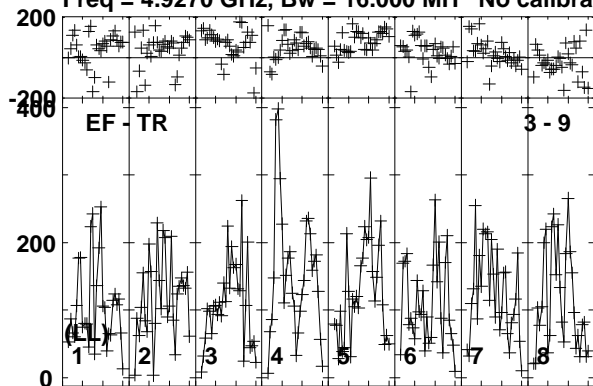

Lower frame: Micro Ampl Jy Top frame: Phas deg  
Vector averaged cross-power spectrum Baseline: EF (03) - TR (09)  
Timerange: 00/10:50:31 to 00/10:53:29

Plot file version 279 created 19-DEC-2018 17:58:29

AT2018\_RY007C.UVDATA.1

Freq = 4.9270 GHz, Bw = 16.000 MH No calibration applied and no bandpass applied

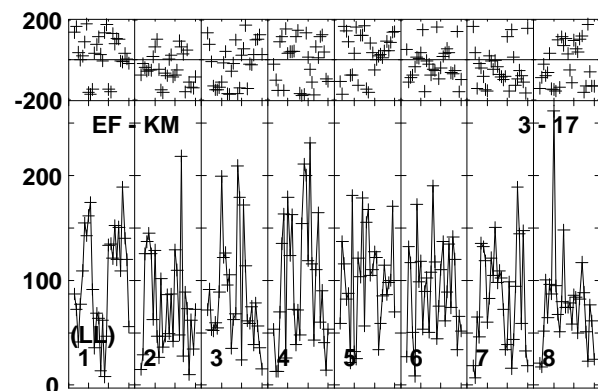
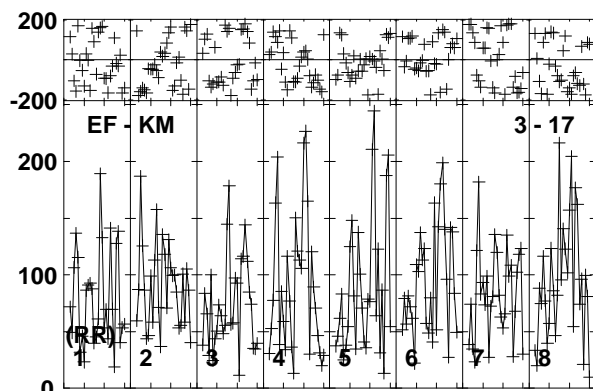
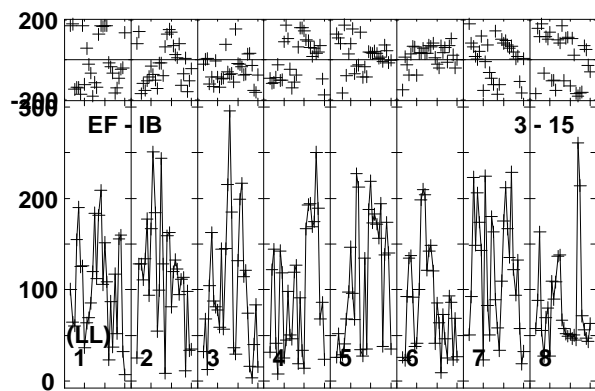
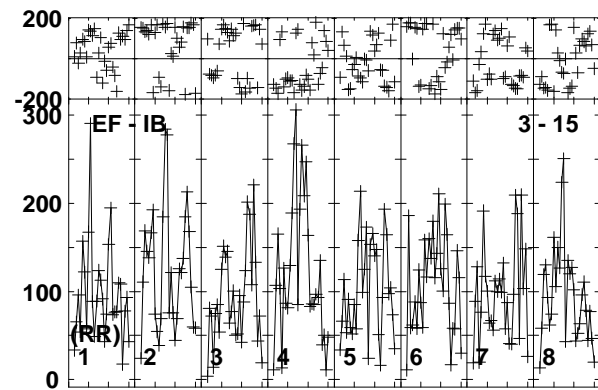
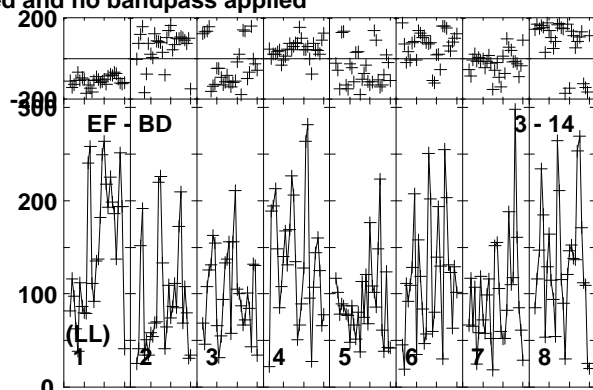
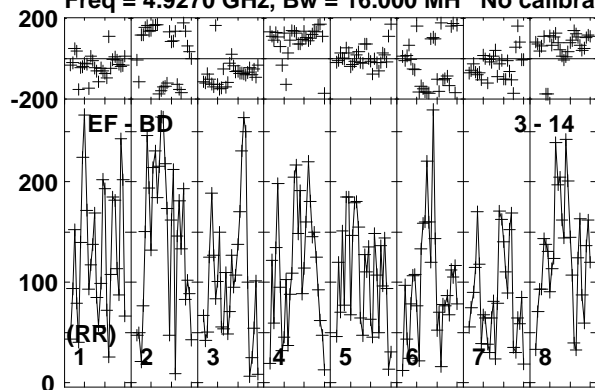

Lower frame: Micro Ampl Jy Top frame: Phas deg  
Vector averaged cross-power spectrum Baseline: EF (03) - BD (14)  
Timerange: 00/10:50:31 to 00/10:53:29

Plot file version 280 created 19-DEC-2018 17:58:29

J1619+2247 RY007C.UVDATA.1

Freq = 4.9270 GHz, Bw = 16.000 MH No calibration applied and no bandpass applied

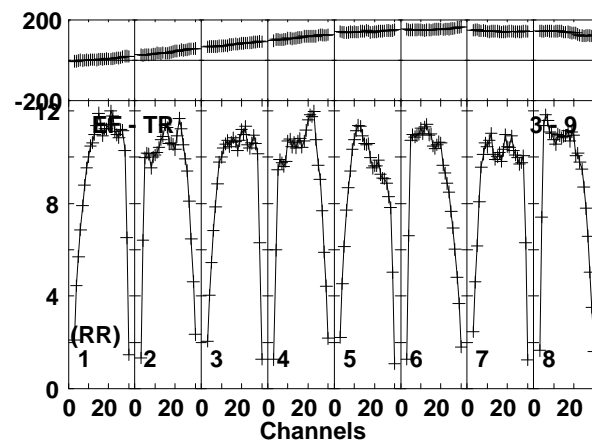
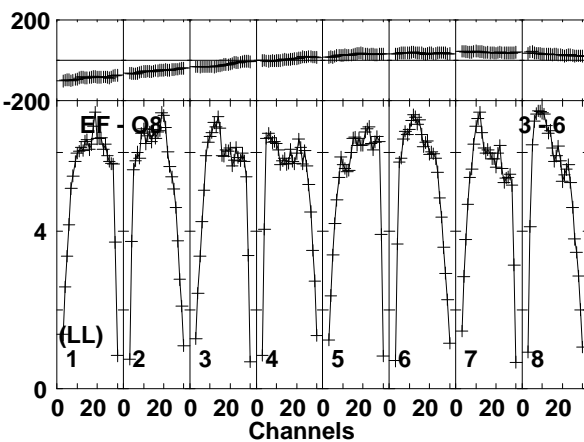
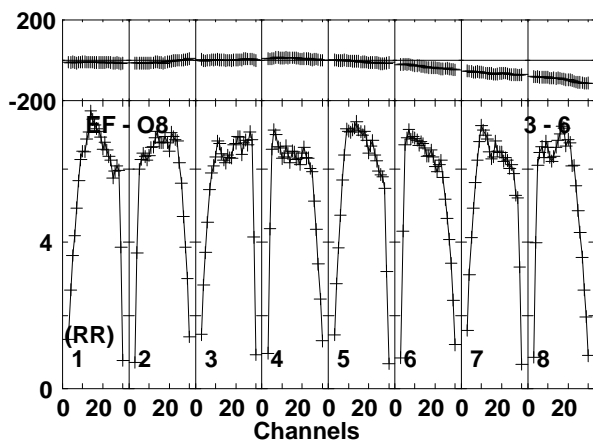
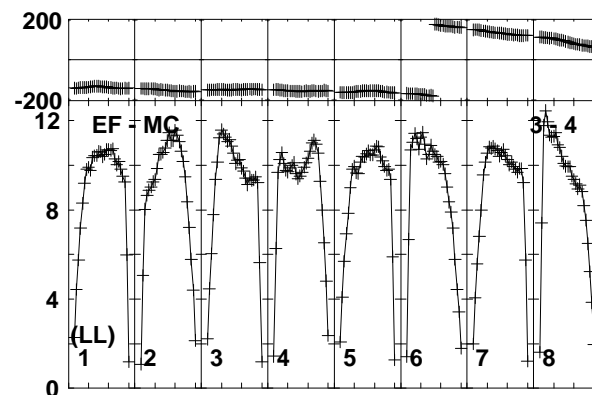
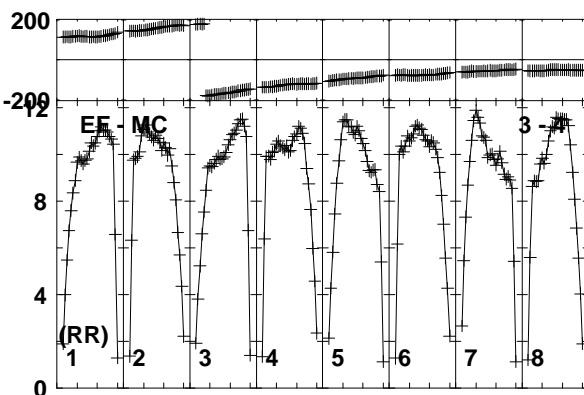
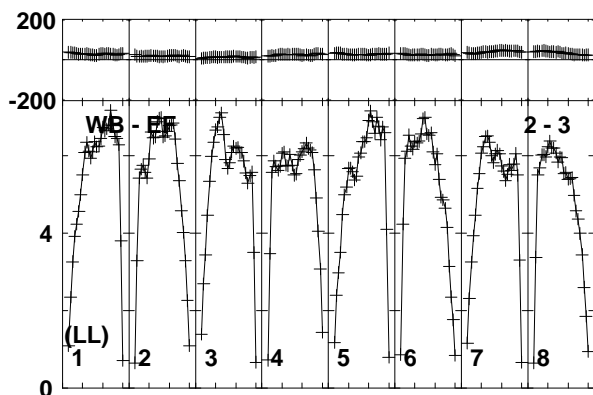
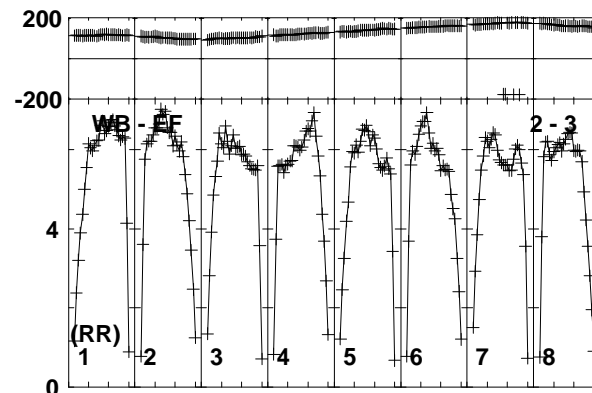
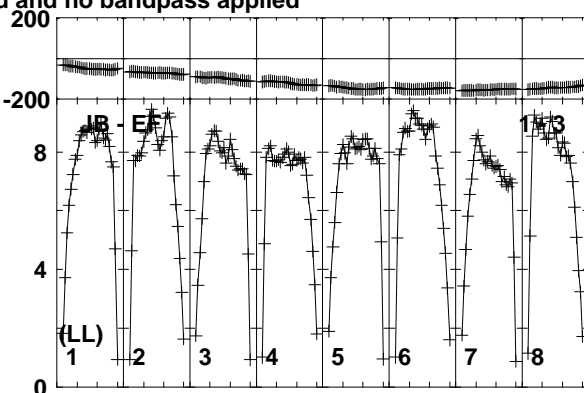
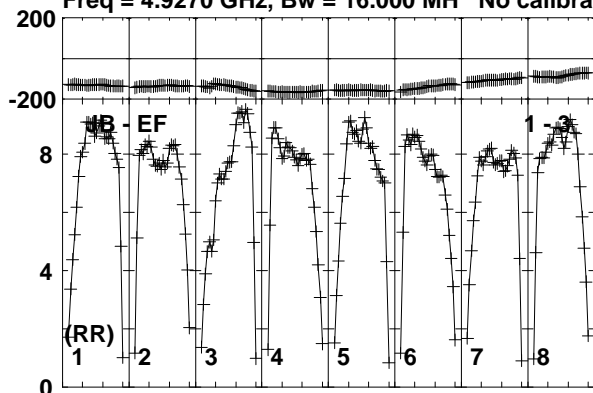

Lower frame: Milli Ampl Jy Top frame: Phas deg  
Vector averaged cross-power spectrum Baseline: JB (01) - EF (03)  
Timerange: 00/10:53:31 to 00/10:54:29

Plot file version 281 created 19-DEC-2018 17:58:29

J1619+2247 RY007C.UVDATA.1

Freq = 4.9270 GHz, Bw = 16.000 MH No calibration applied and no bandpass applied

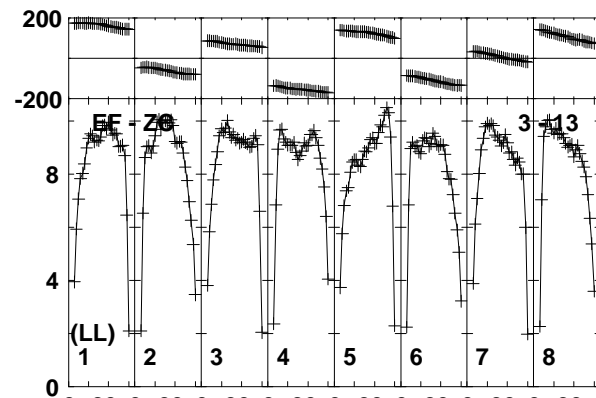
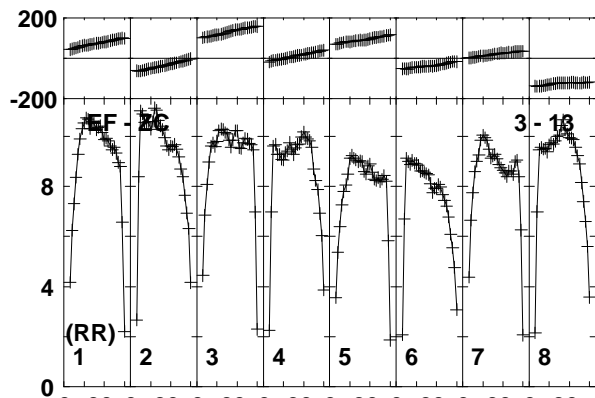
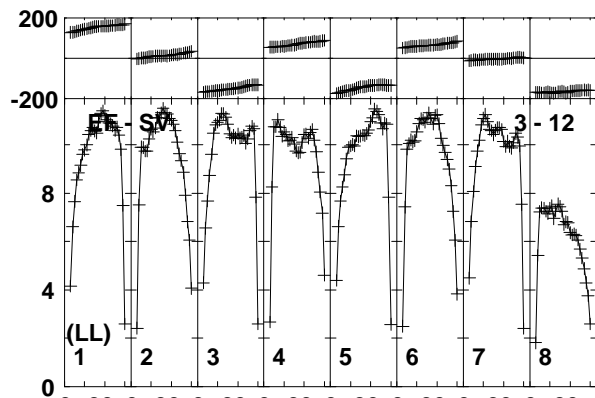
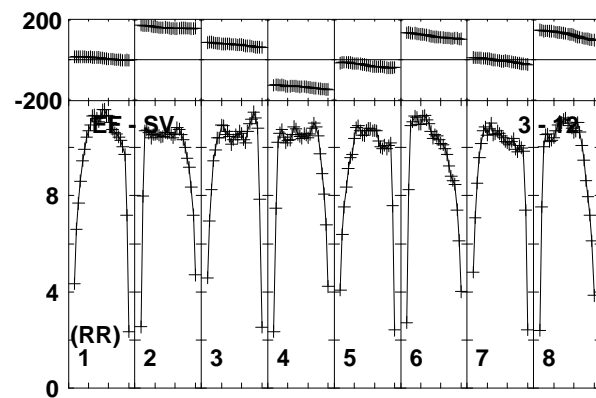
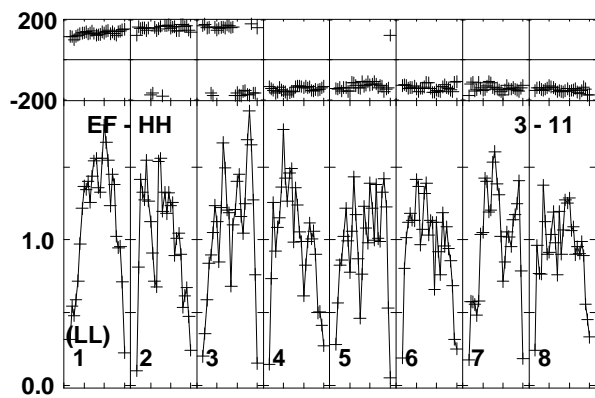
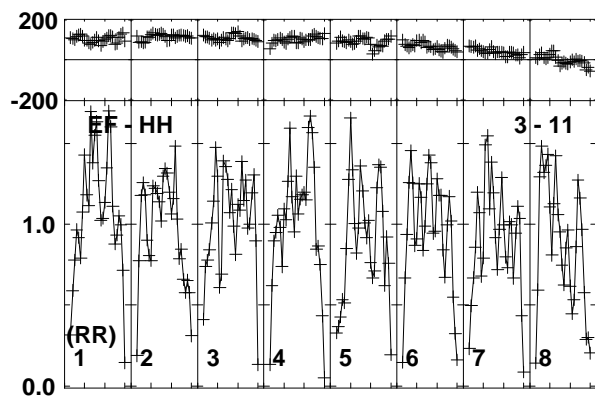
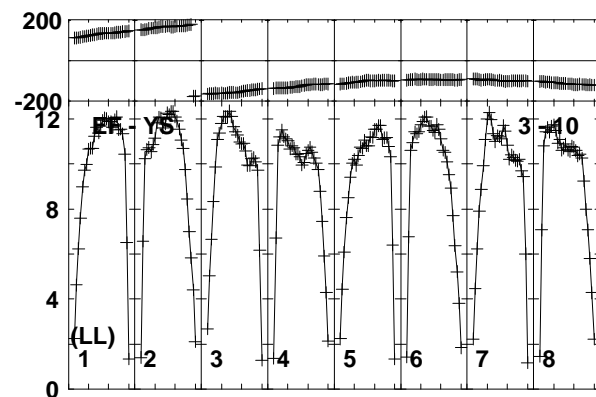
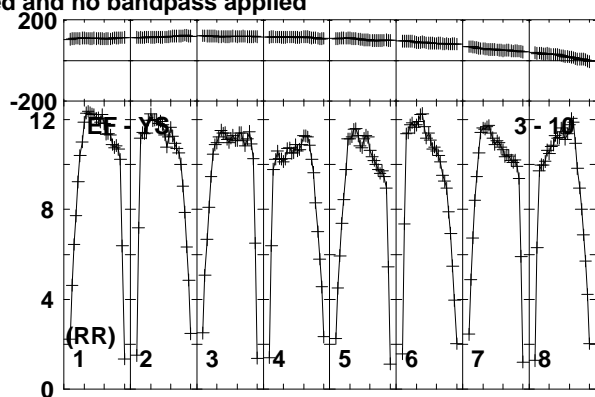
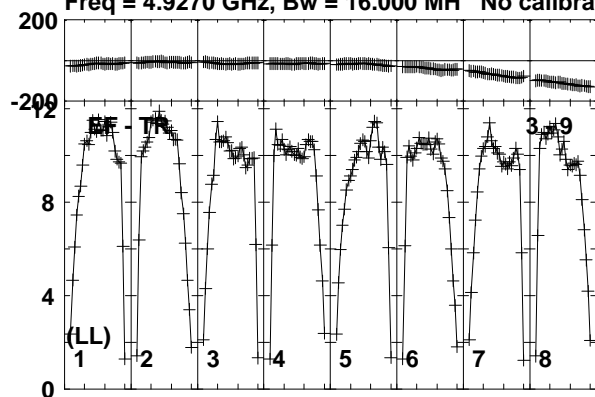

Lower frame: Milli Ampl Jy Top frame: Phas deg  
Vector averaged cross-power spectrum Baseline: EF (03) - TR (09)  
Timerange: 00/10:53:31 to 00/10:54:29

Plot file version 282 created 19-DEC-2018 17:58:30

J1619+2247 RY007C.UVDATA.1

Freq = 4.9270 GHz, Bw = 16.000 MH No calibration applied and no bandpass applied

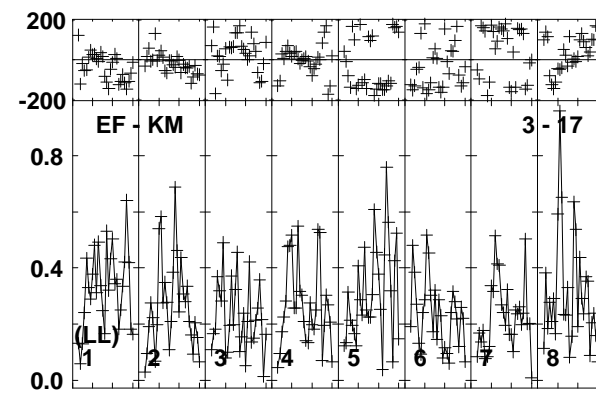
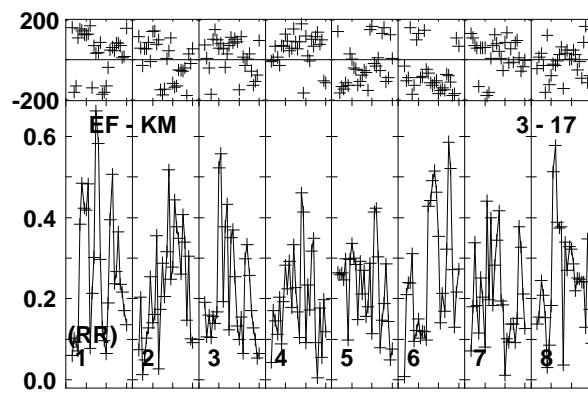
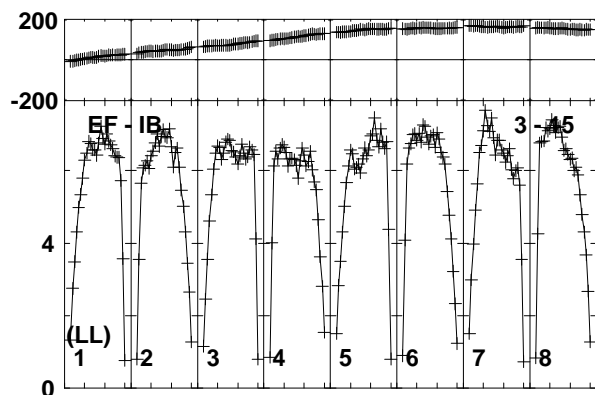
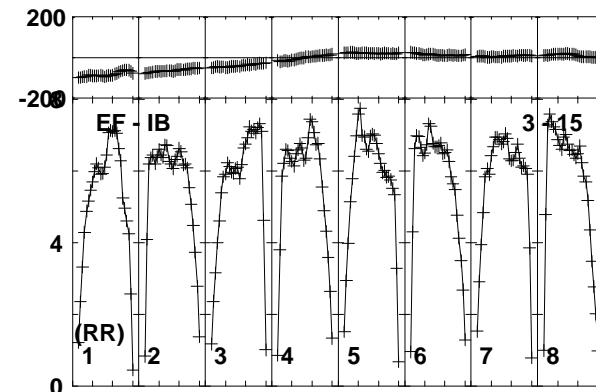
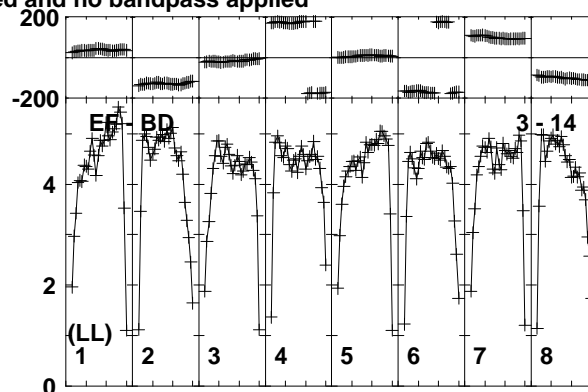
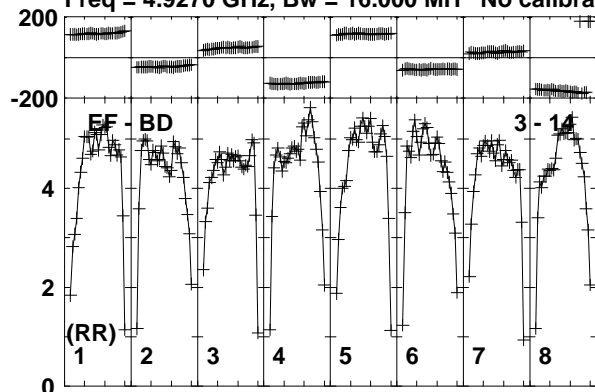

Lower frame: Milli Ampl Jy Top frame: Phas deg  
Vector averaged cross-power spectrum Baseline: EF (03) - BD (14)  
Timerange: 00/10:53:31 to 00/10:54:29



Plot file version 283 created 19-DEC-2018 17:58:30  
 VLA1 RY007C.UVDATA.1  
 Freq = 4.9270 GHz, Bw = 16.000 MH No calibration applied and no bandpass applied

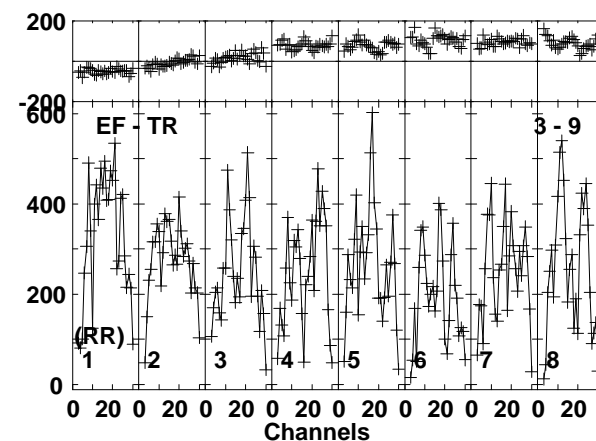
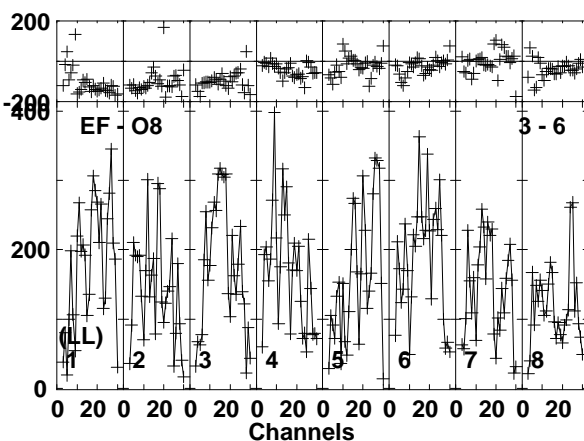
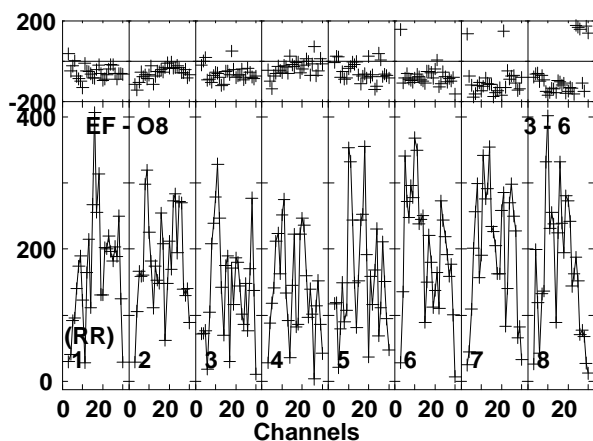
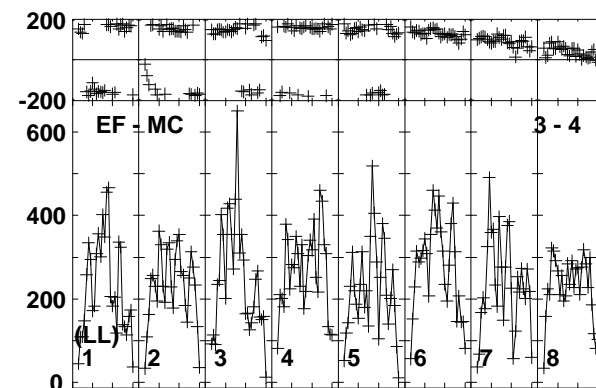
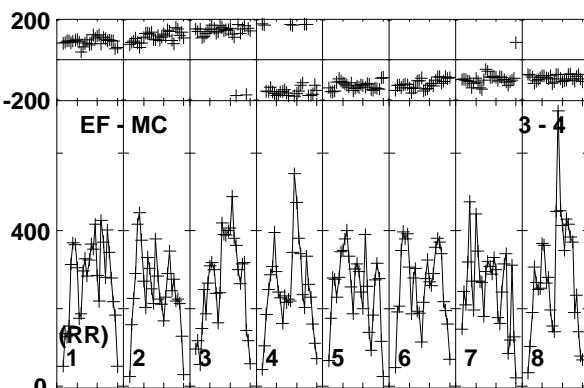
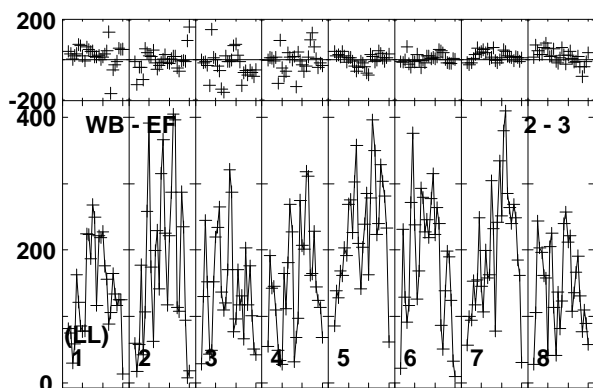
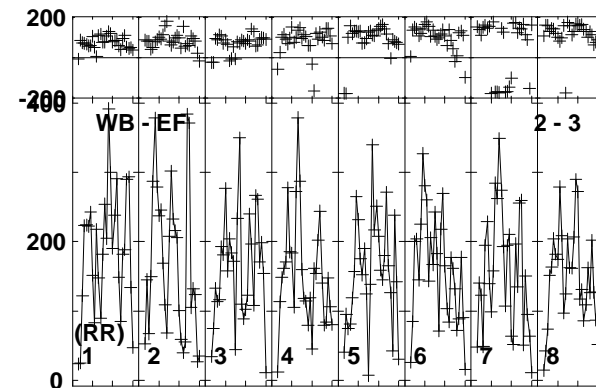
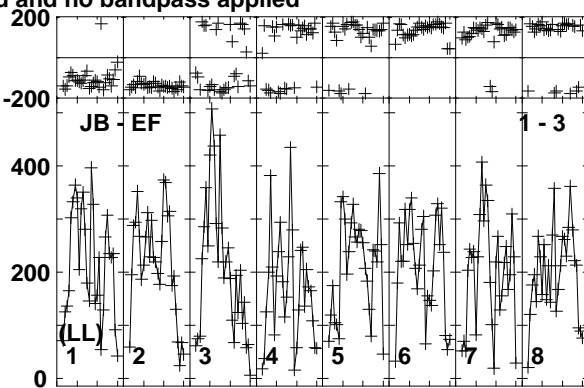
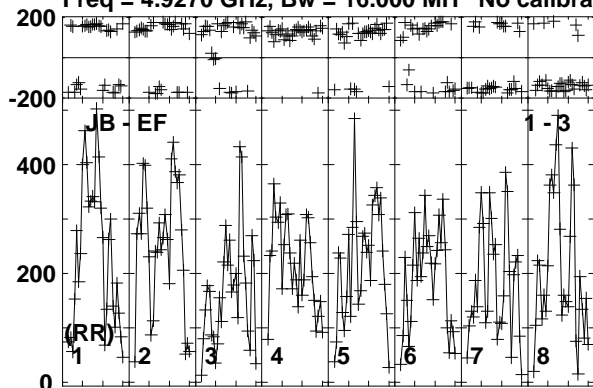

Lower frame: Micro Ampl Jy Top frame: Phas deg  
 Vector averaged cross-power spectrum Baseline: JB (01) - EF (03)  
 Timerange: 00/10:55:01 to 00/10:56:59

Plot file version 284 created 19-DEC-2018 17:58:30  
 VLA1 RY007C.UVDATA.1  
 Freq = 4.9270 GHz, Bw = 16.000 MH No calibration applied and no bandpass applied

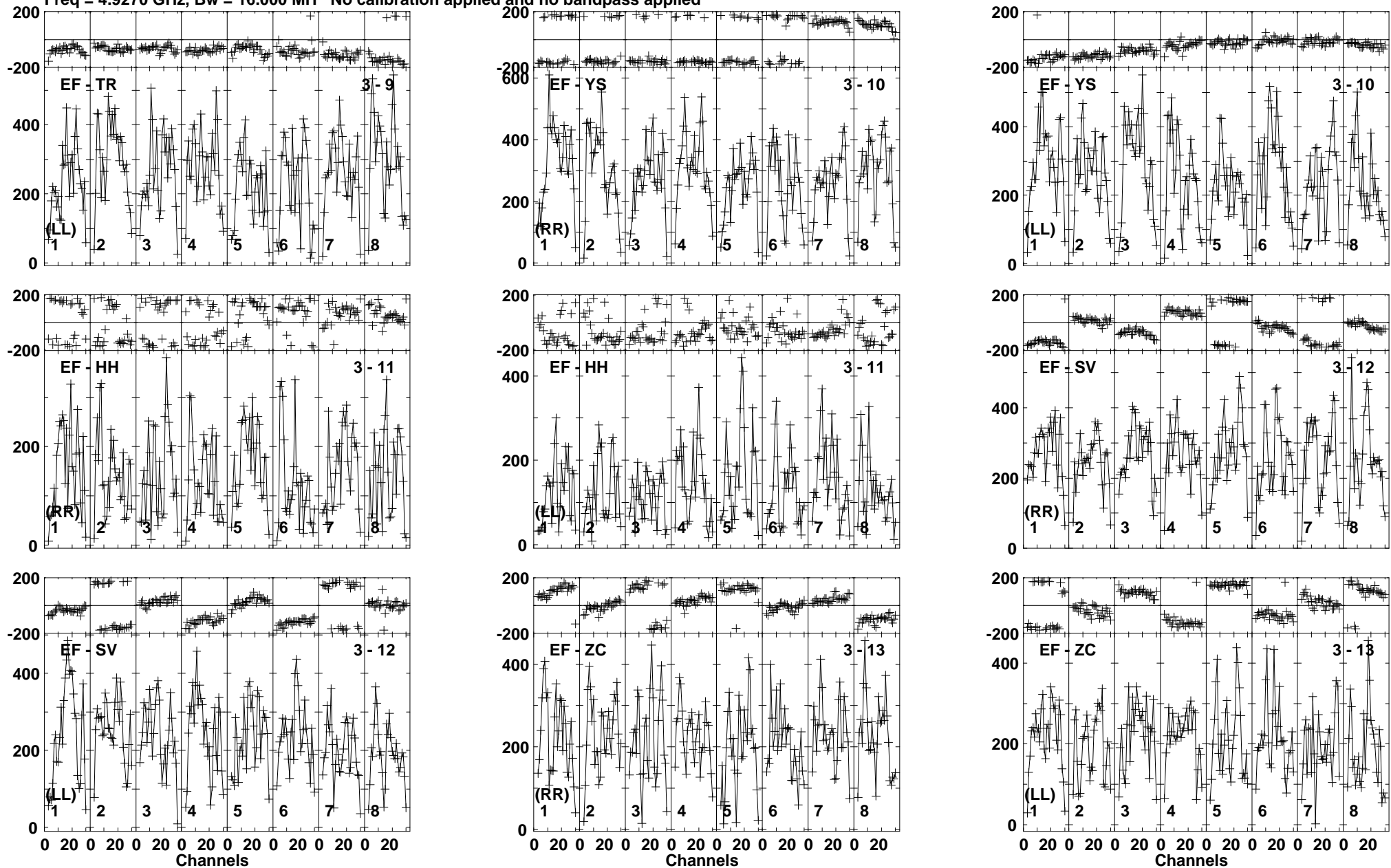

Lower frame: Micro Ampl Jy Top frame: Phas deg  
 Vector averaged cross-power spectrum Baseline: EF (03) - TR (09)  
 Timerange: 00/10:55:01 to 00/10:56:59

Plot file version 285 created 19-DEC-2018 17:58:30

VLA1 RY007C.UVDATA.1

Freq = 4.9270 GHz, Bw = 16.000 MH No calibration applied and no bandpass applied

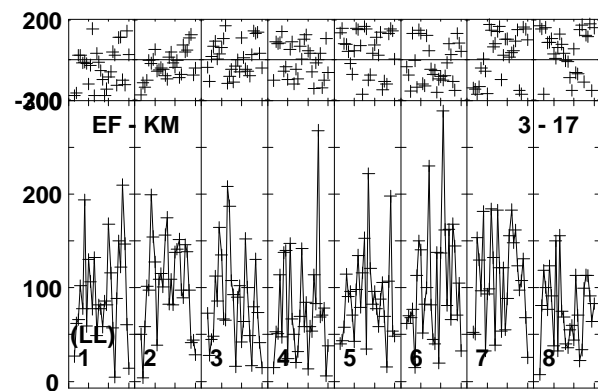
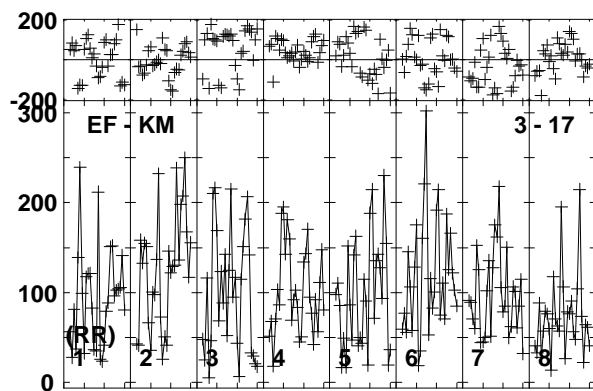
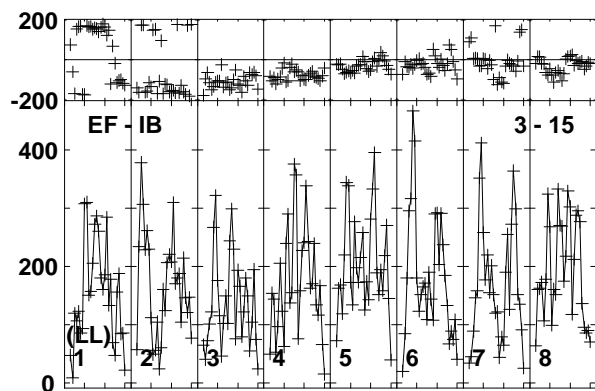
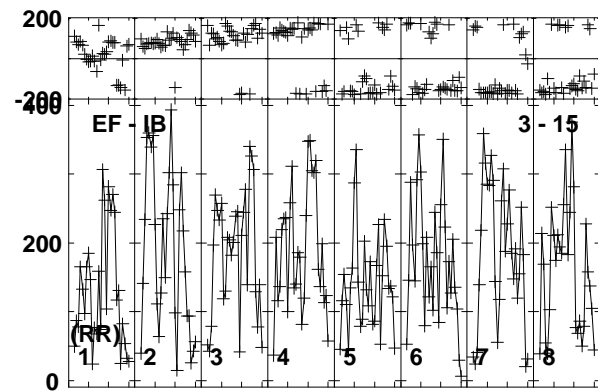
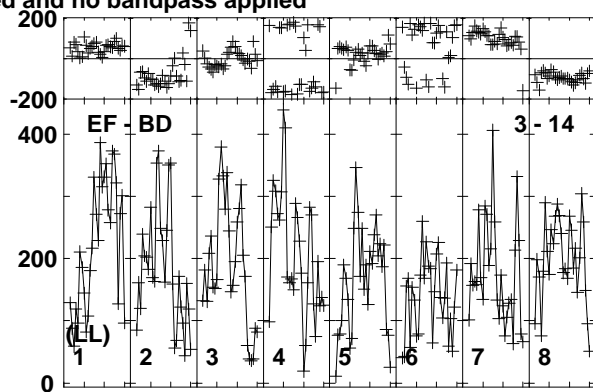
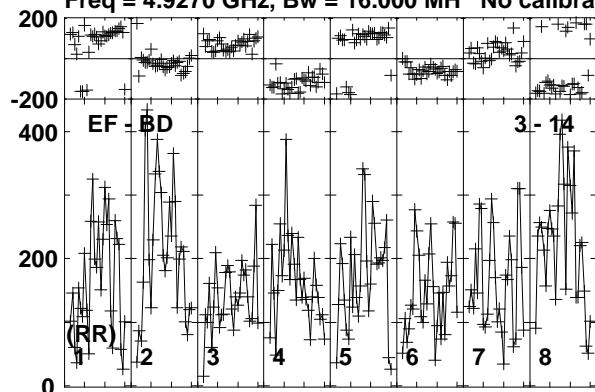

Lower frame: Micro Ampl Jy Top frame: Phas deg  
Vector averaged cross-power spectrum Baseline: EF (03) - BD (14)  
Timerange: 00/10:55:01 to 00/10:56:59

Plot file version 286 created 19-DEC-2018 17:58:30

J1619+2247 RY007C.UVDATA.1

Freq = 4.9270 GHz, Bw = 16.000 MH No calibration applied and no bandpass applied

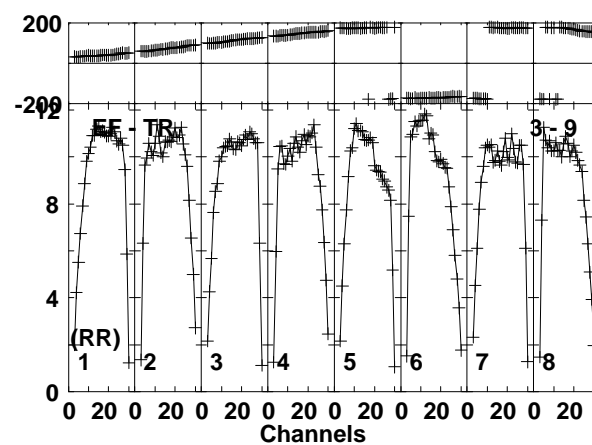
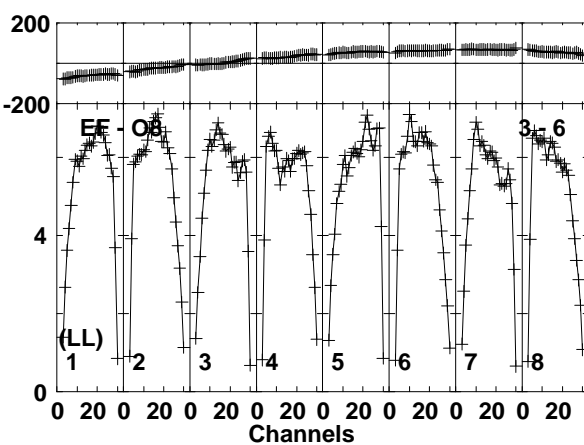
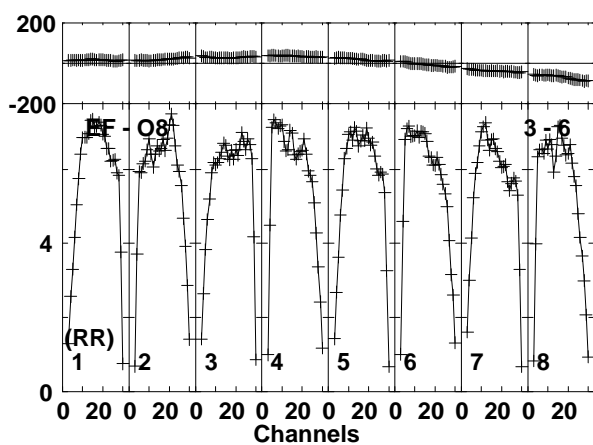
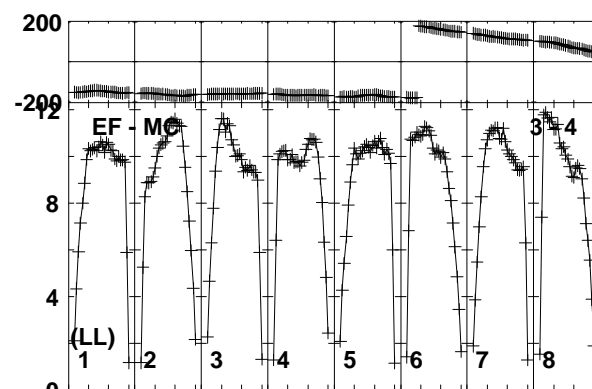
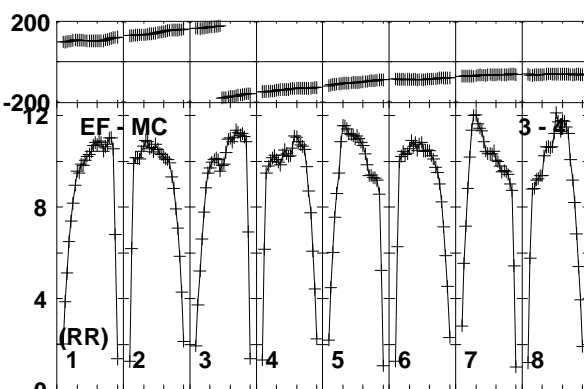
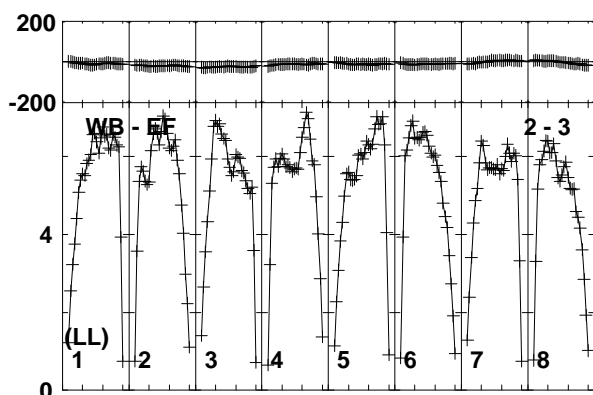
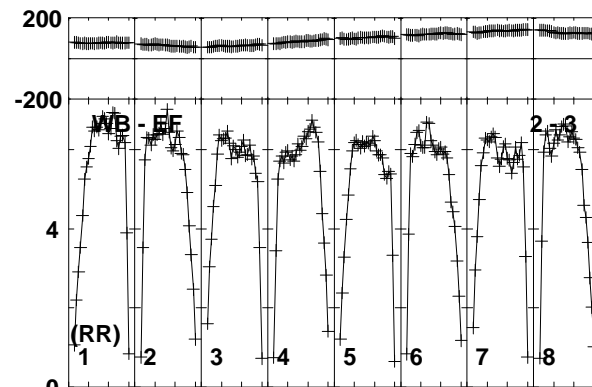
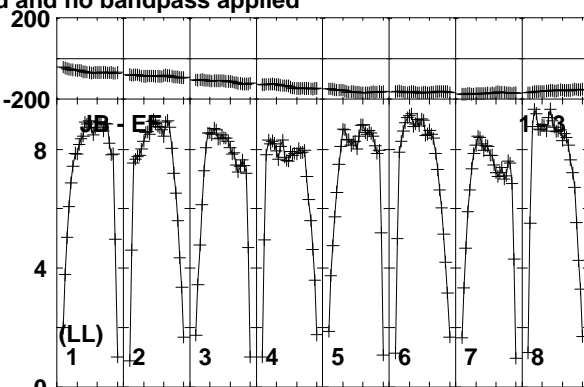
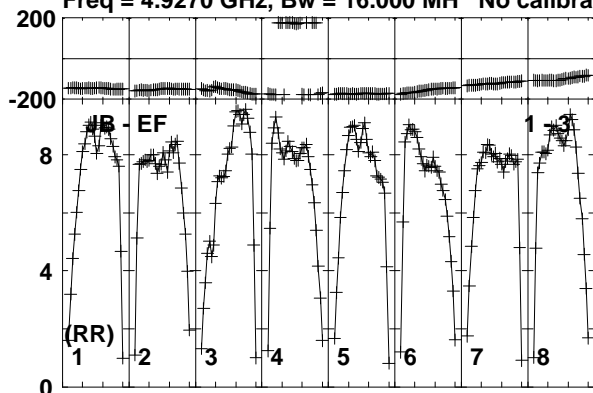

Lower frame: Milli Ampl Jy Top frame: Phas deg  
Vector averaged cross-power spectrum Baseline: JB (01) - EF (03)  
Timerange: 00/10:57:01 to 00/10:57:59

Plot file version 287 created 19-DEC-2018 17:58:30

J1619+2247 RY007C.UVDATA.1

Freq = 4.9270 GHz, Bw = 16.000 MH No calibration applied and no bandpass applied

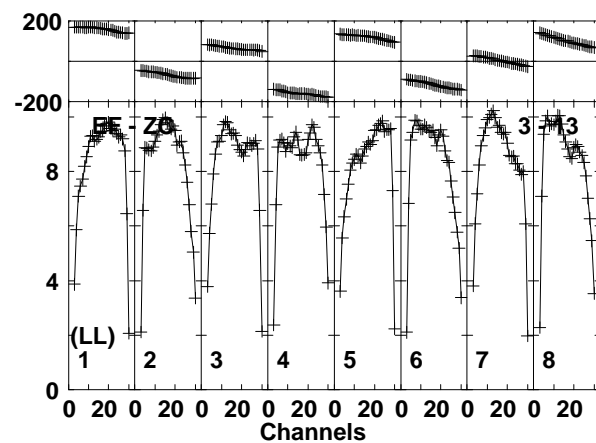
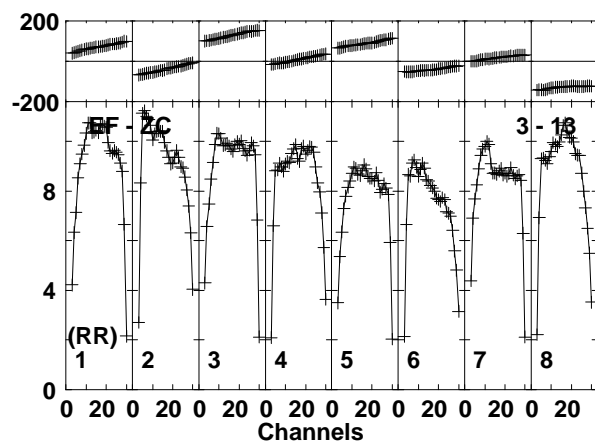
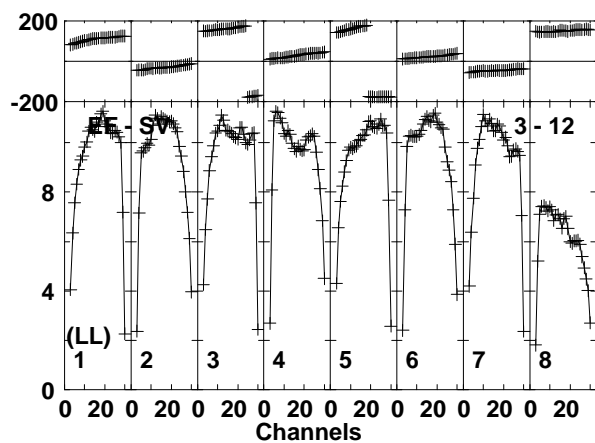
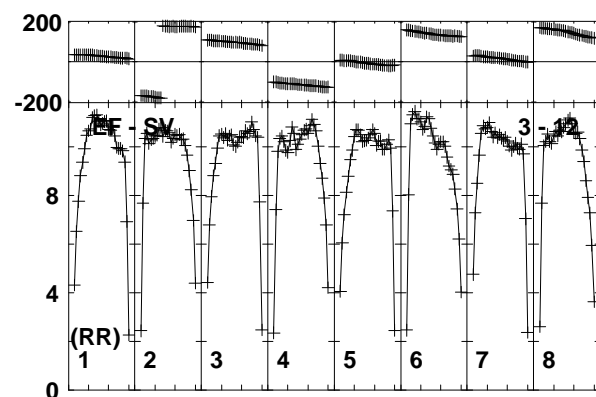
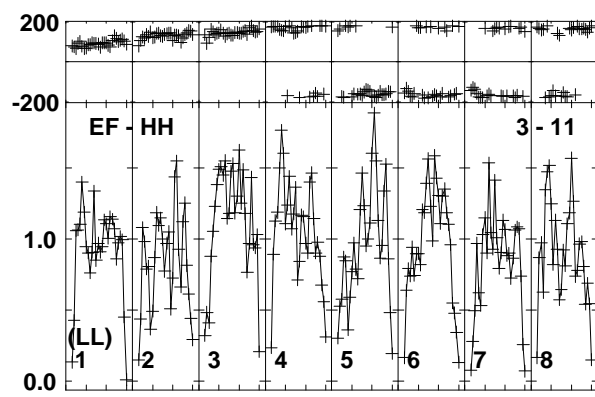
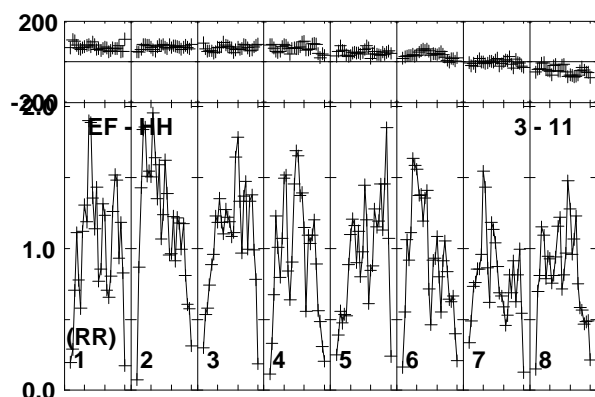
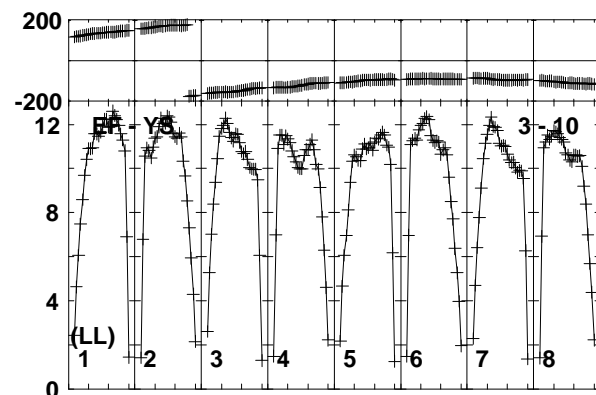
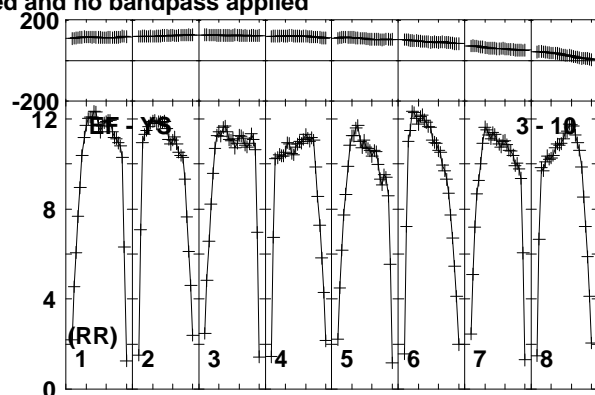
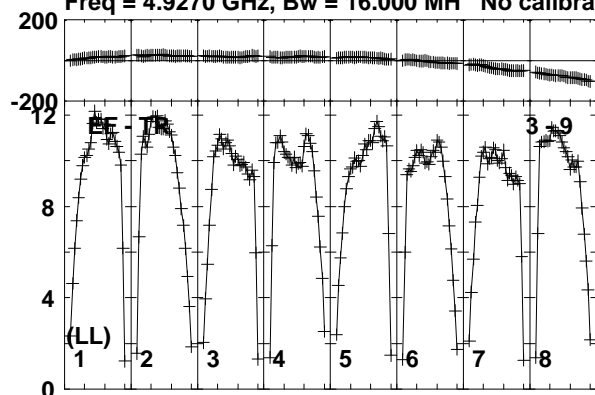

Lower frame: Milli Ampl Jy Top frame: Phas deg  
Vector averaged cross-power spectrum Baseline: EF (03) - TR (09)  
Timerange: 00/10:57:01 to 00/10:57:59

Plot file version 288 created 19-DEC-2018 17:58:30

J1619+2247 RY007C.UVDATA.1

Freq = 4.9270 GHz, Bw = 16.000 MH No calibration applied and no bandpass applied

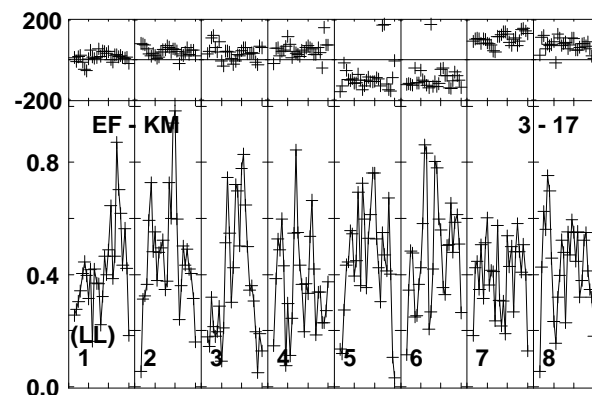
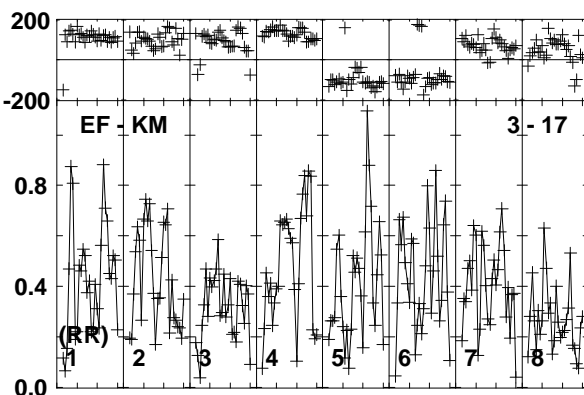
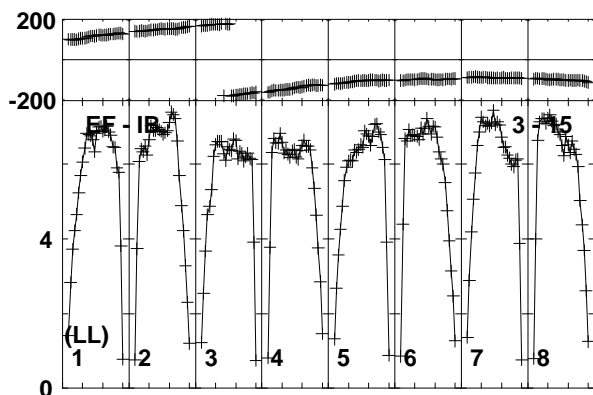
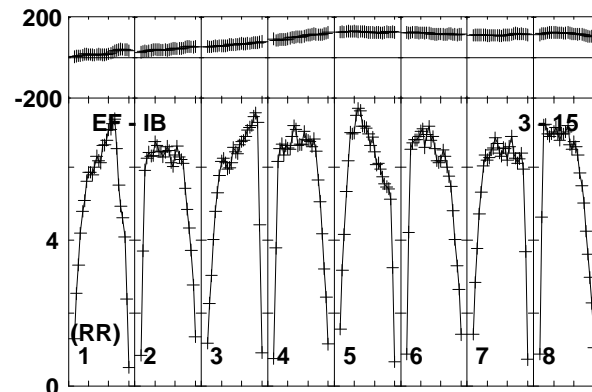
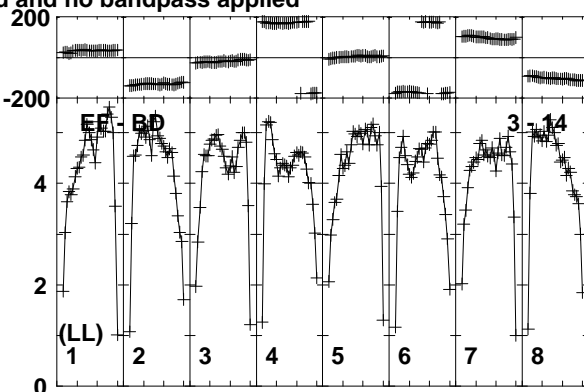
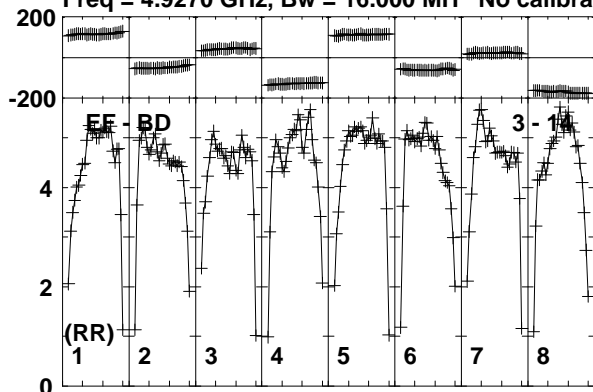

Lower frame: Milli Ampl Jy Top frame: Phas deg  
Vector averaged cross-power spectrum Baseline: EF (03) - BD (14)  
Timerange: 00/10:57:01 to 00/10:57:59

Plot file version 289 created 19-DEC-2018 17:58:30

AT2018\_RY007C.UVDATA.1

Freq = 4.9270 GHz, Bw = 16.000 MH No calibration applied and no bandpass applied

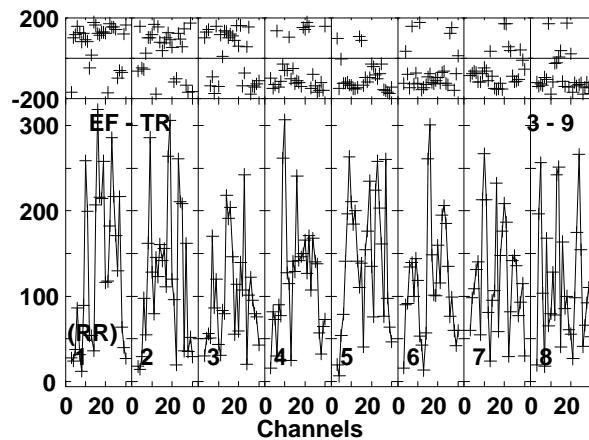
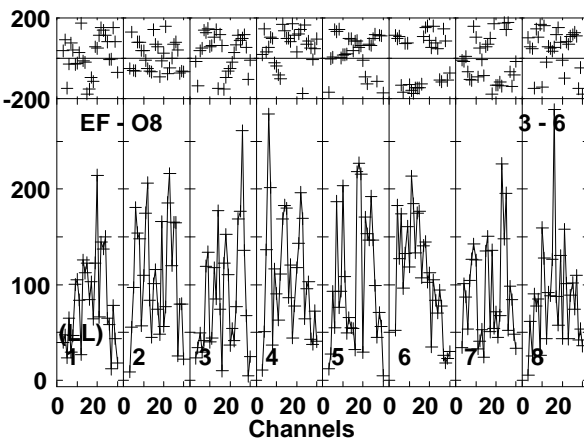
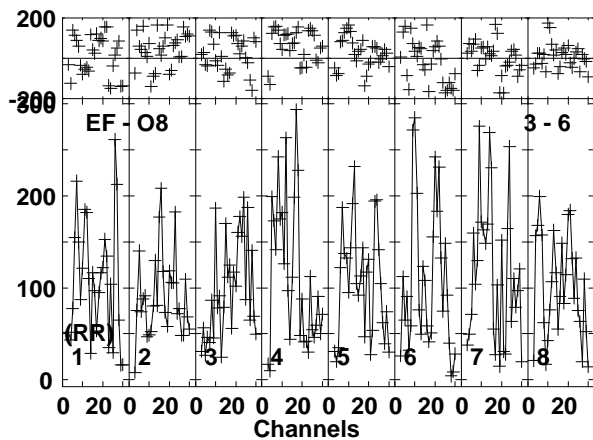
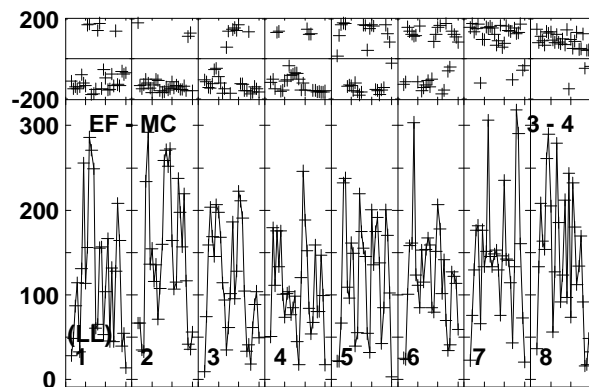
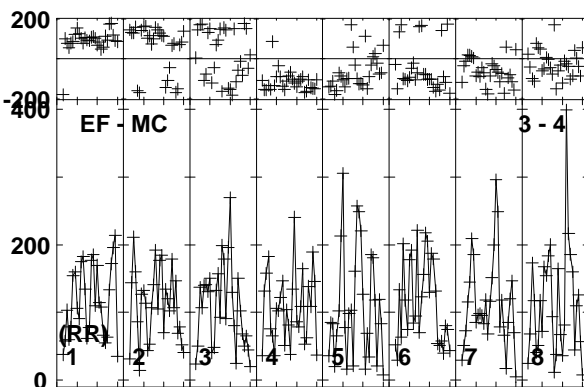
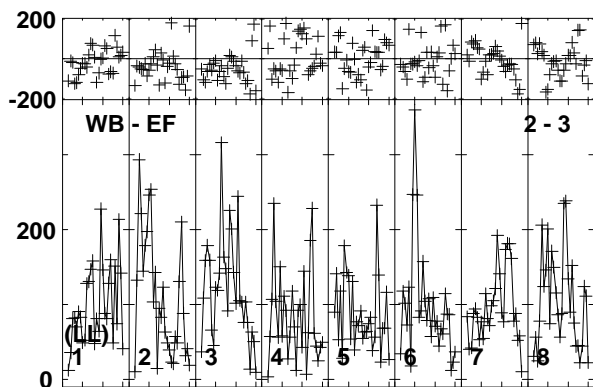
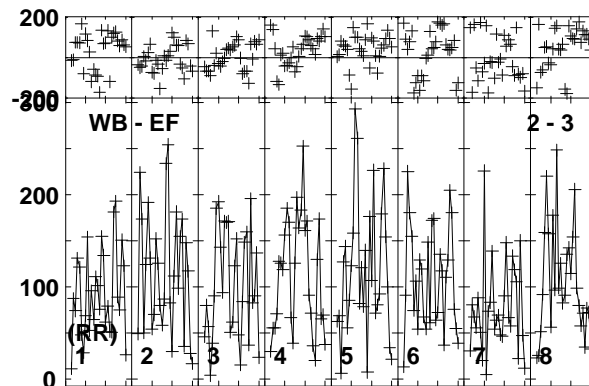
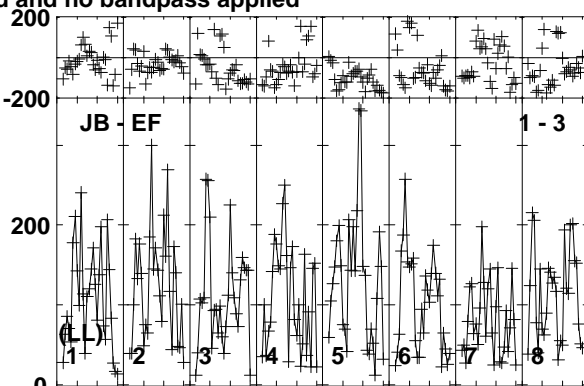
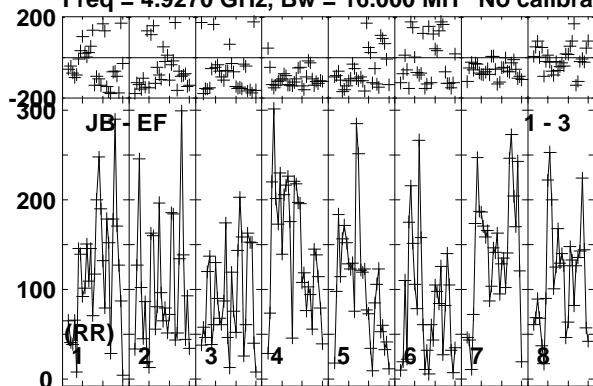

Lower frame: Micro Ampl Jy Top frame: Phas deg  
Vector averaged cross-power spectrum Baseline: JB (01) - EF (03)  
Timerange: 00/10:58:01 to 00/11:00:59

Plot file version 290 created 19-DEC-2018 17:58:32

AT2018\_RY007C.UVDATA.1

Freq = 4.9270 GHz, Bw = 16.000 MH No calibration applied and no bandpass applied

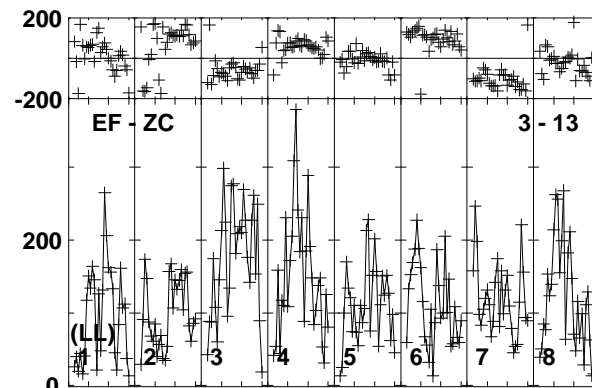
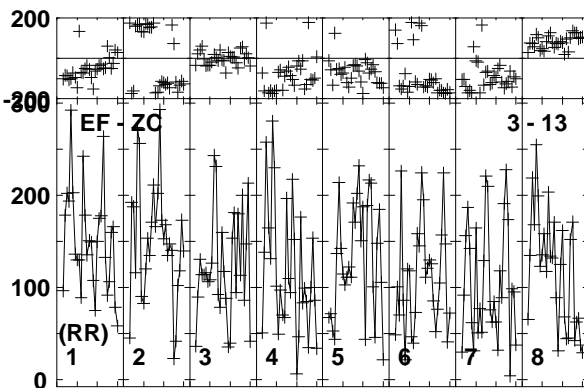
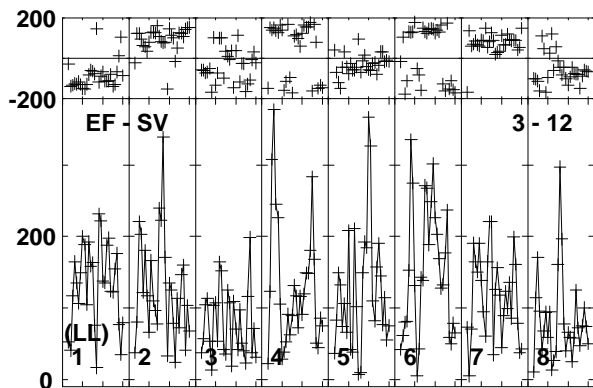
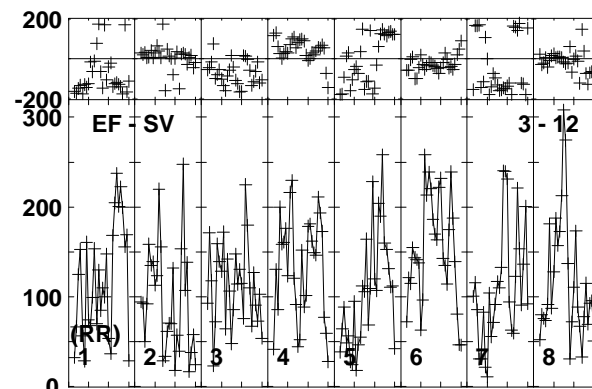
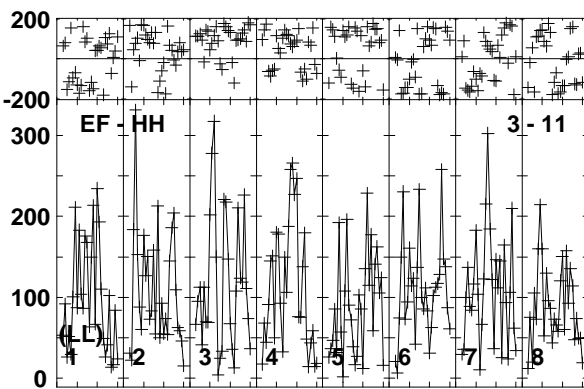
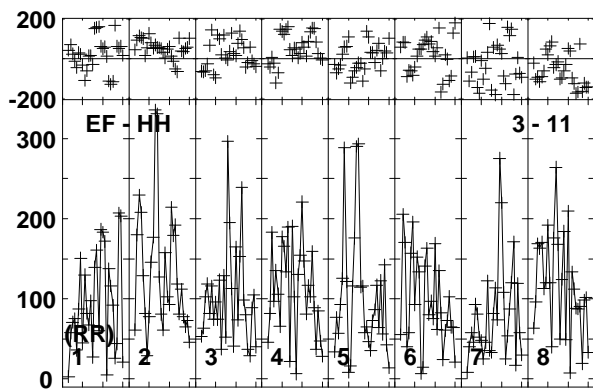
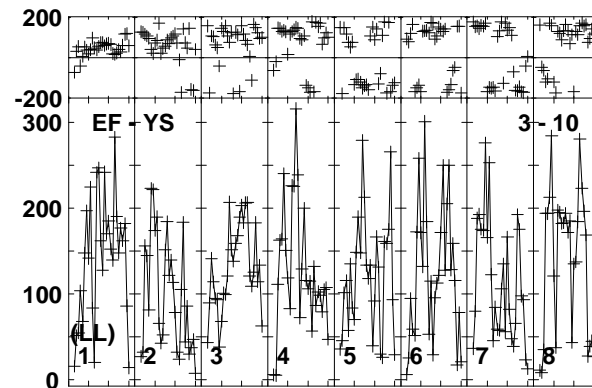
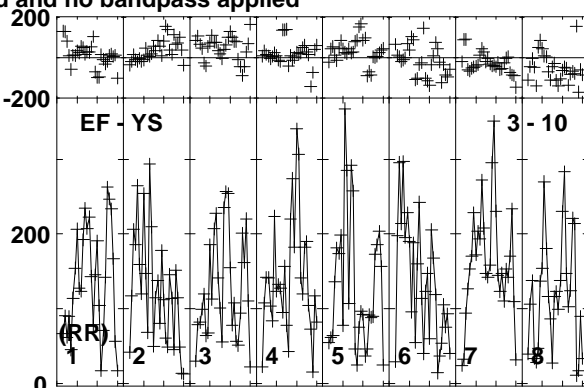
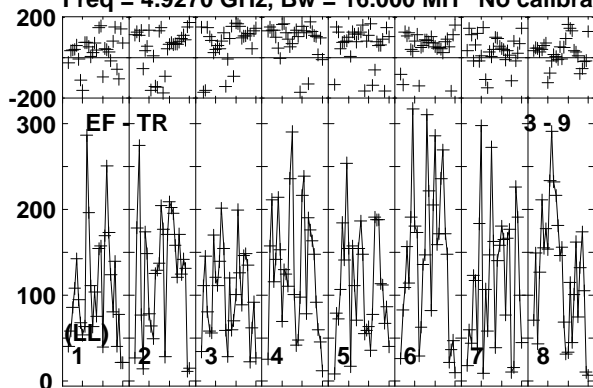

Lower frame: Micro Ampl Jy Top frame: Phas deg  
Vector averaged cross-power spectrum Baseline: EF (03) - TR (09)  
Timerange: 00/10:58:01 to 00/11:00:59



Plot file version 291 created 19-DEC-2018 17:58:32

AT2018\_RY007C.UVDATA.1

Freq = 4.9270 GHz, Bw = 16.000 MH No calibration applied and no bandpass applied

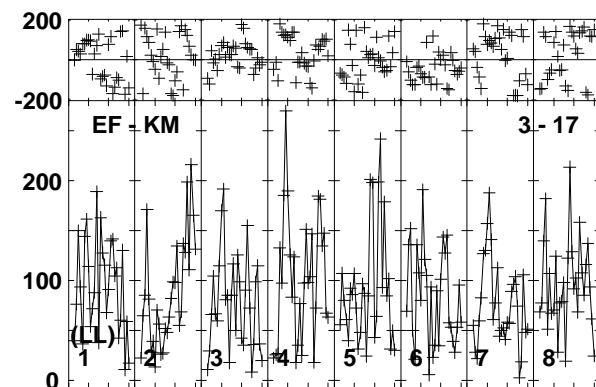
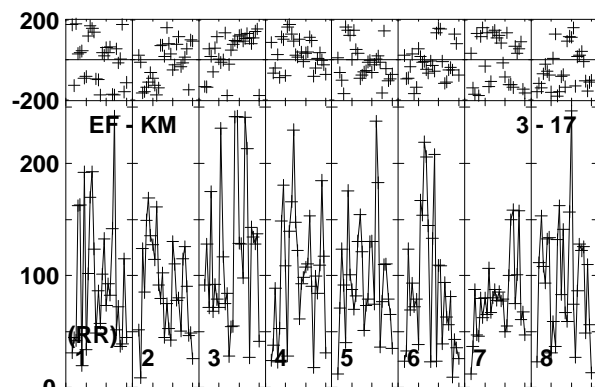
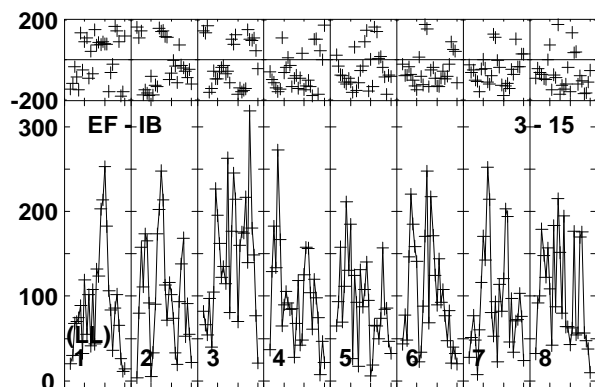
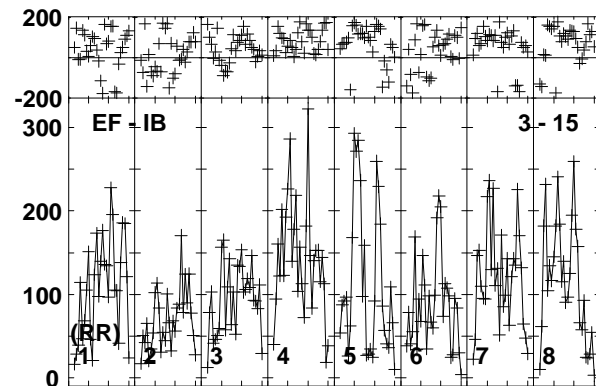
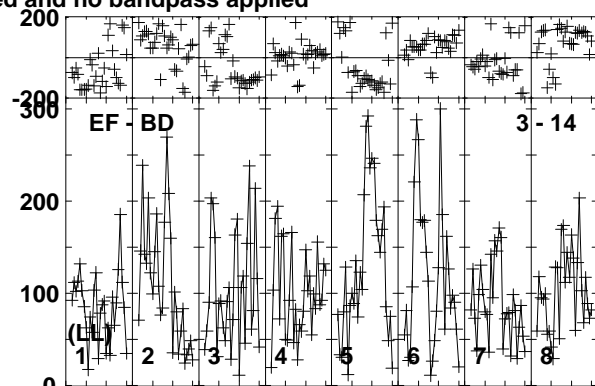
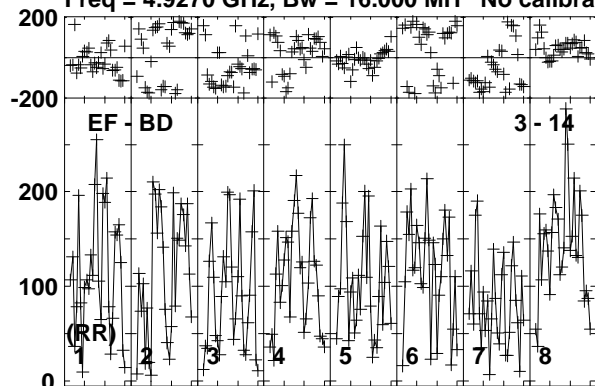

Lower frame: Micro Ampl Jy Top frame: Phas deg  
Vector averaged cross-power spectrum Baseline: EF (03) - BD (14)  
Timerange: 00/10:58:01 to 00/11:00:59

Plot file version 292 created 19-DEC-2018 17:58:32

J1619+2247 RY007C.UVDATA.1

Freq = 4.9270 GHz, Bw = 16.000 MH No calibration applied and no bandpass applied

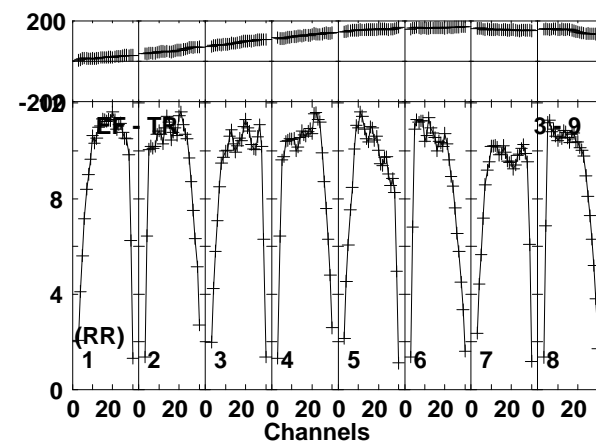
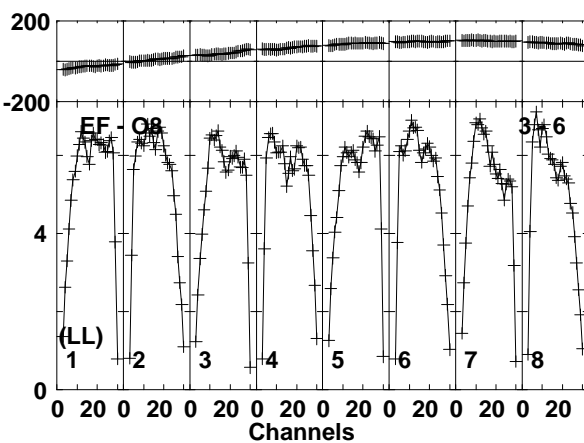
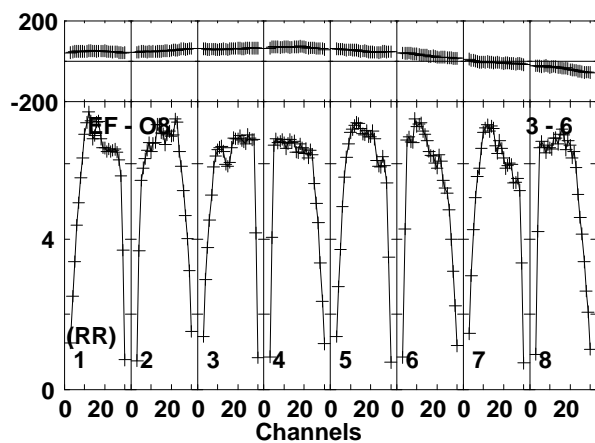
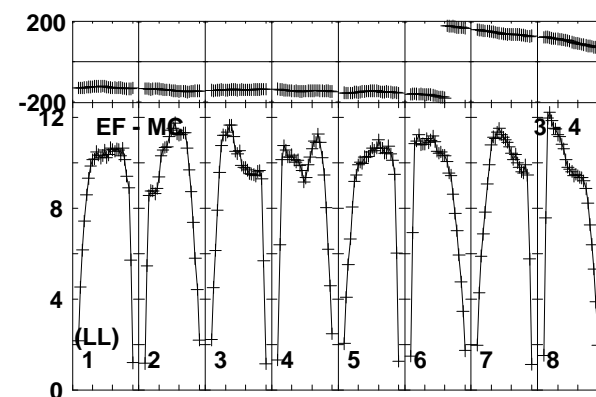
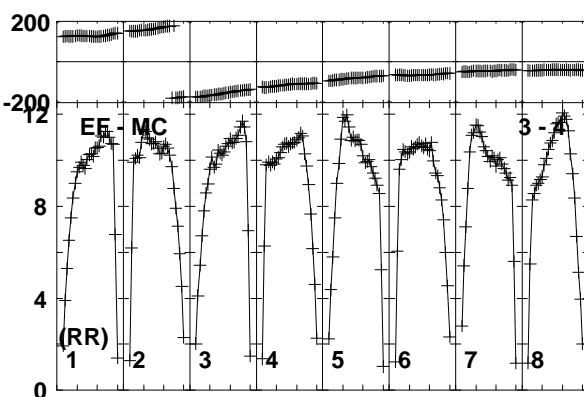
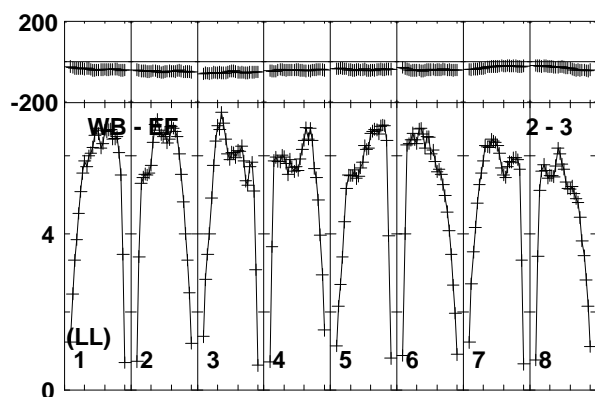
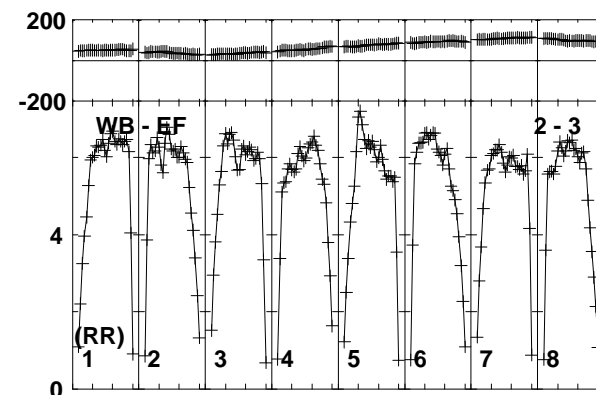
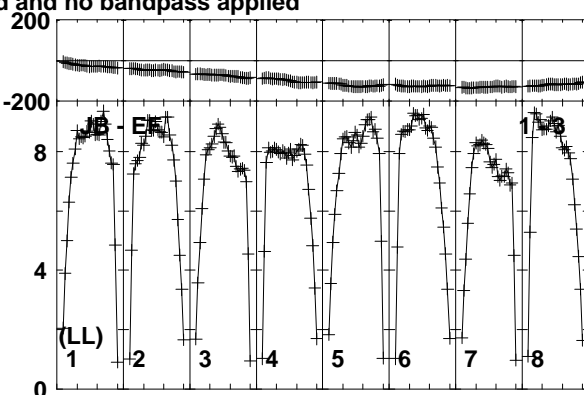
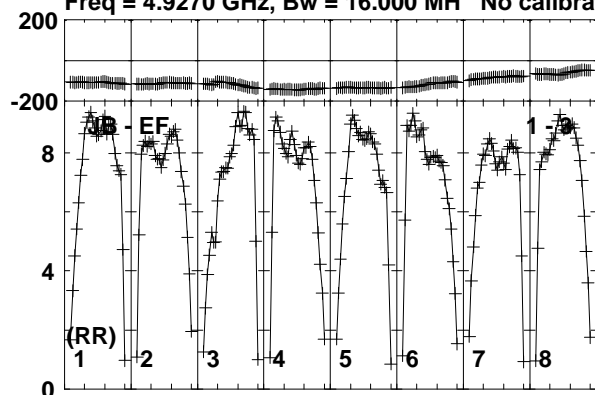

Lower frame: Milli Ampl Jy Top frame: Phas deg  
Vector averaged cross-power spectrum Baseline: JB (01) - EF (03)  
Timerange: 00/11:01:01 to 00/11:01:59

Plot file version 293 created 19-DEC-2018 17:58:32

J1619+2247 RY007C.UVDATA.1

Freq = 4.9270 GHz, Bw = 16.000 MH No calibration applied and no bandpass applied

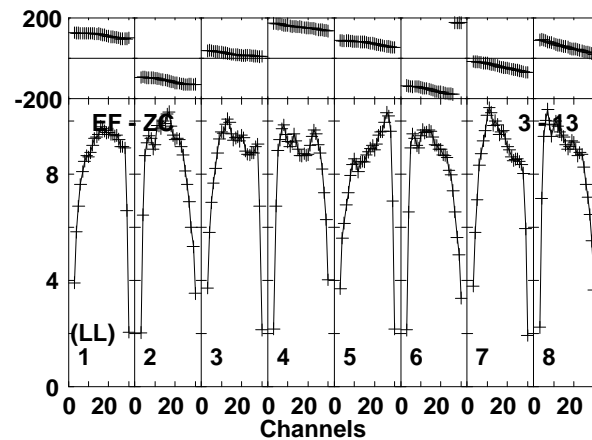
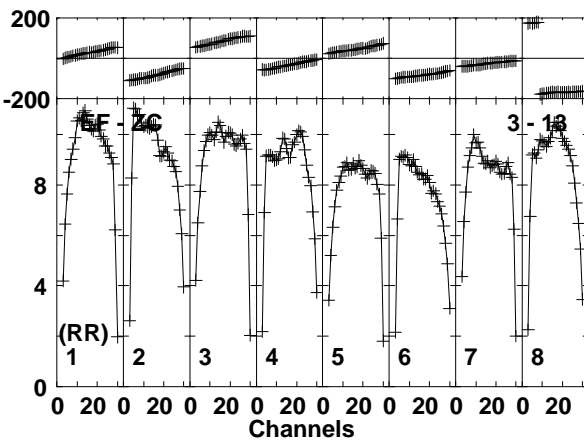
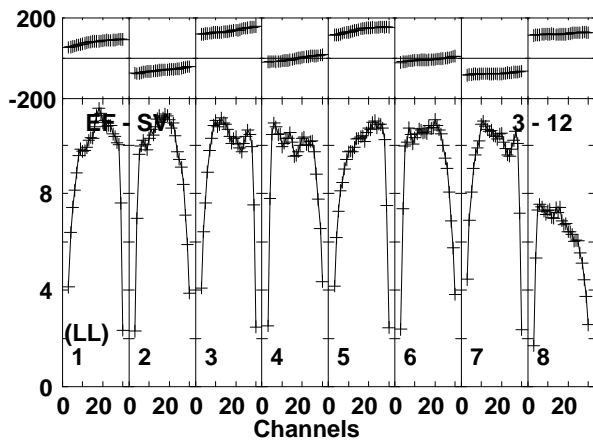
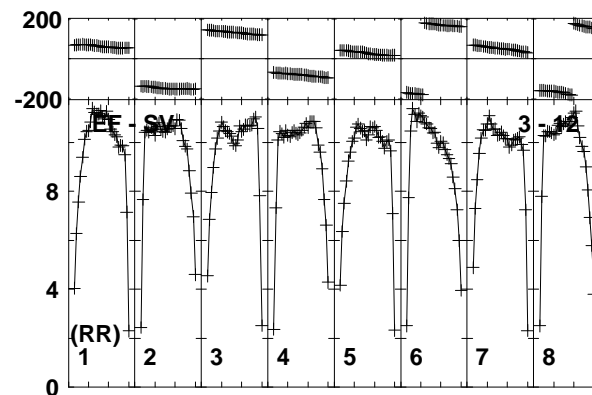
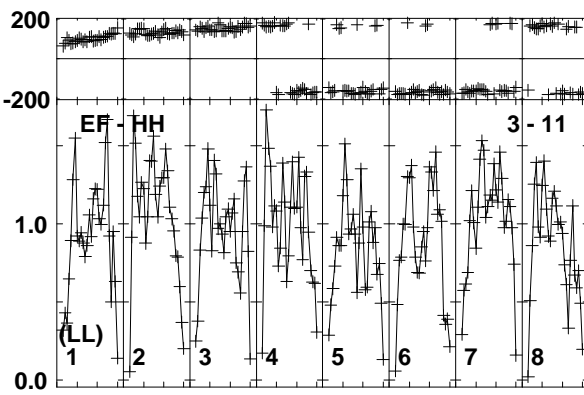
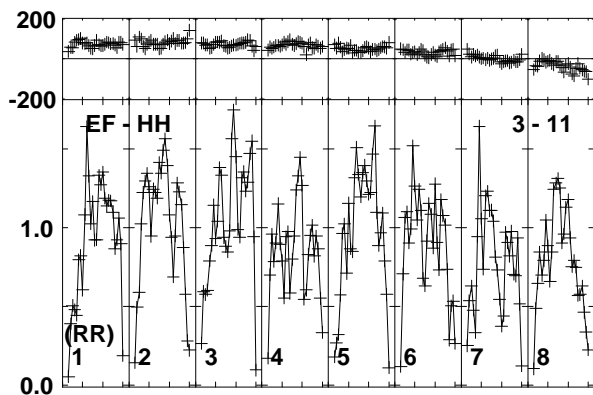
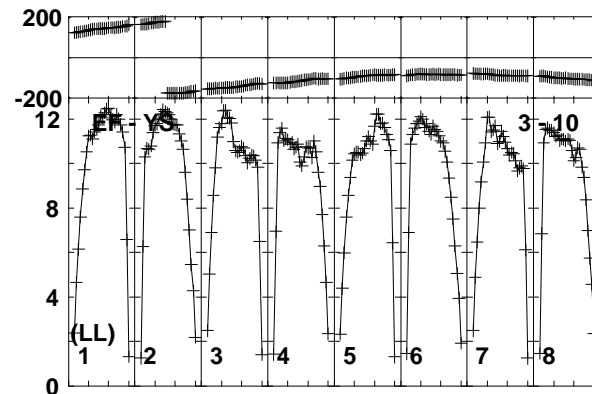
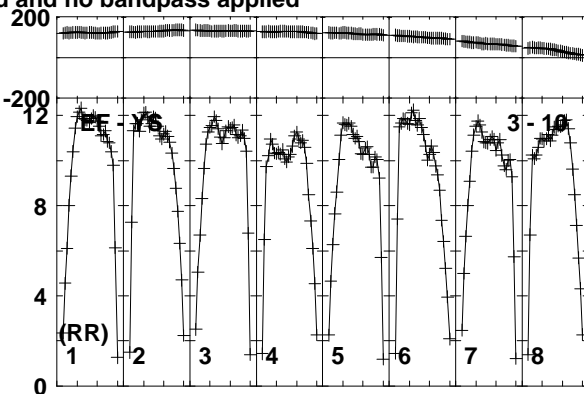
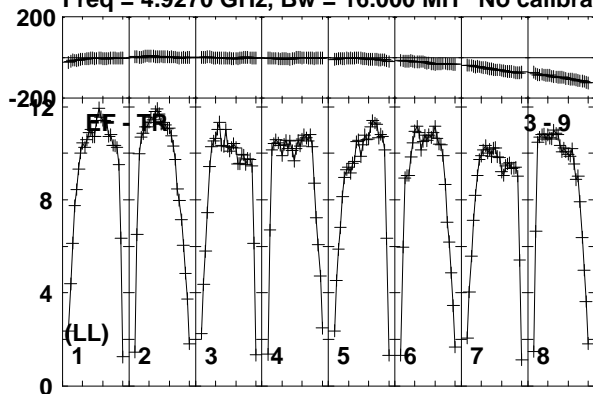

Lower frame: Milli Ampl Jy Top frame: Phas deg  
Vector averaged cross-power spectrum Baseline: EF (03) - TR (09)  
Timerange: 00/11:01:01 to 00/11:01:59

Plot file version 294 created 19-DEC-2018 17:58:32

J1619+2247 RY007C.UVDATA.1

Freq = 4.9270 GHz, Bw = 16.000 MH No calibration applied and no bandpass applied

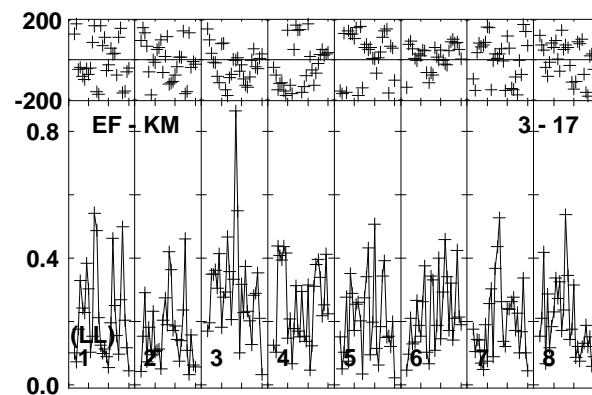
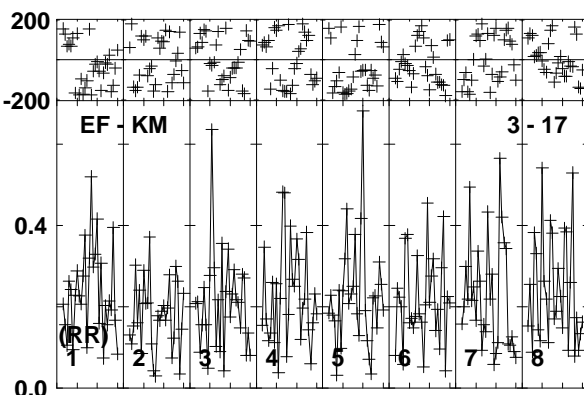
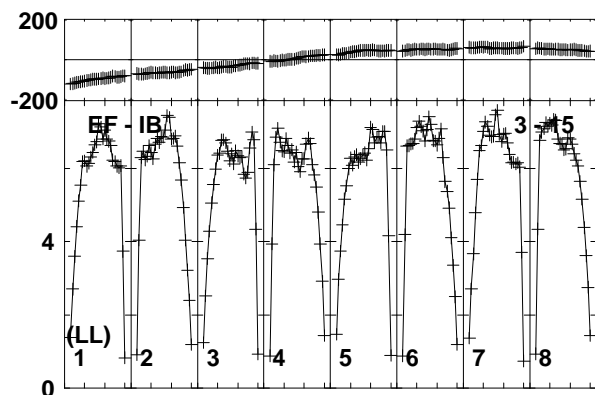
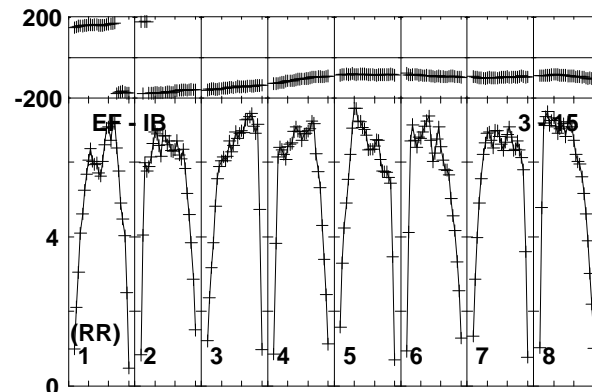
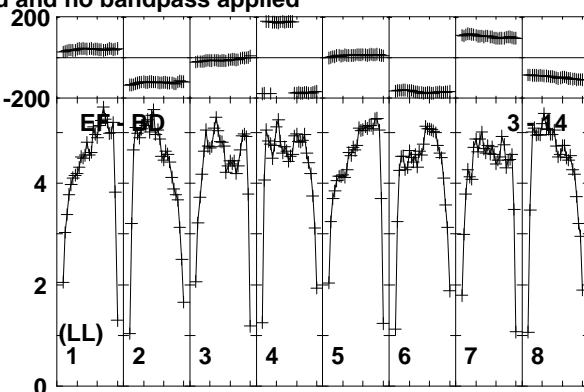
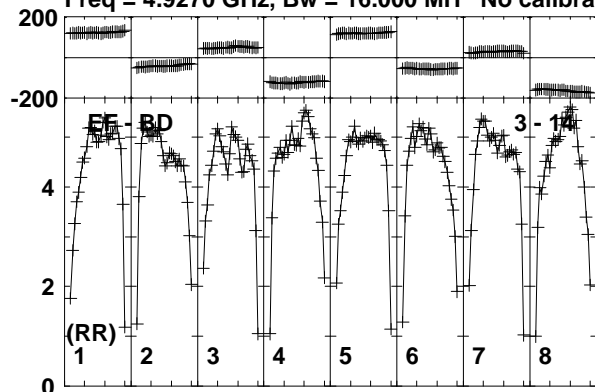

Lower frame: Milli Ampl Jy Top frame: Phas deg  
Vector averaged cross-power spectrum Baseline: EF (03) - BD (14)  
Timerange: 00/11:01:01 to 00/11:01:59

Plot file version 295 created 19-DEC-2018 17:58:32

AT2018\_RY007C.UVDATA.1

Freq = 4.9270 GHz, Bw = 16.000 MH No calibration applied and no bandpass applied

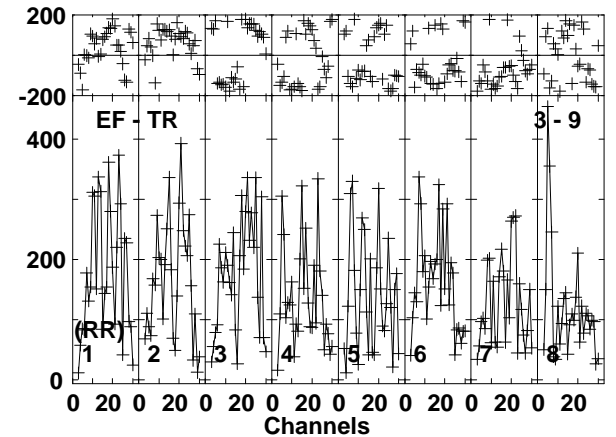
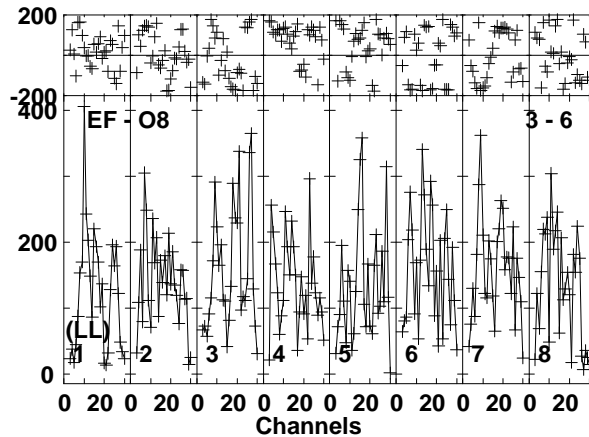
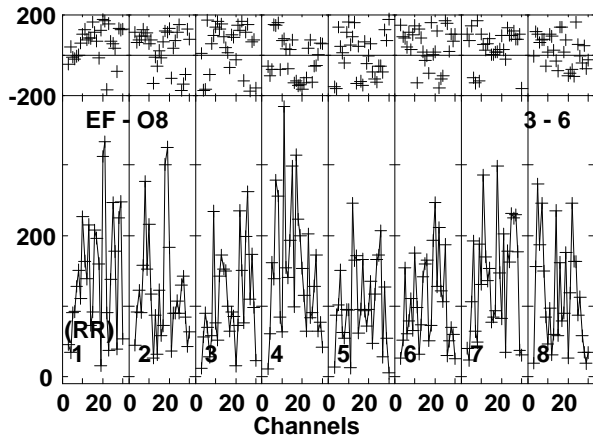
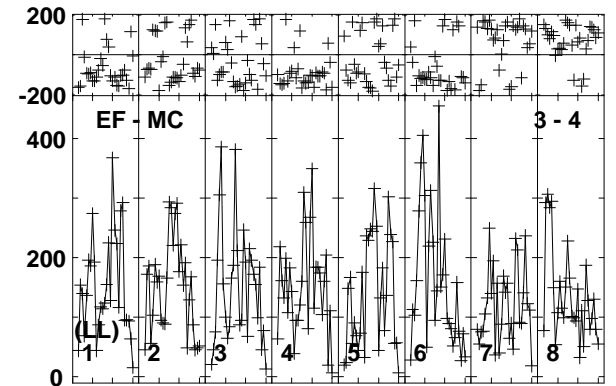
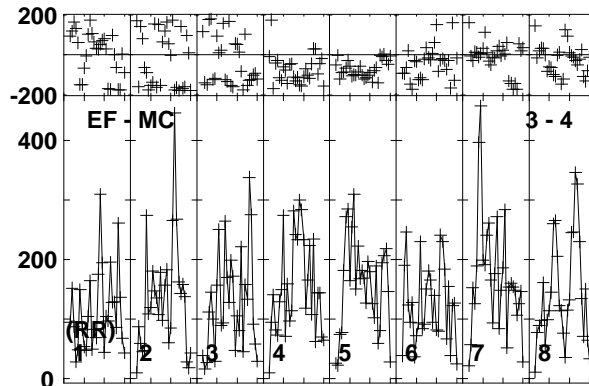
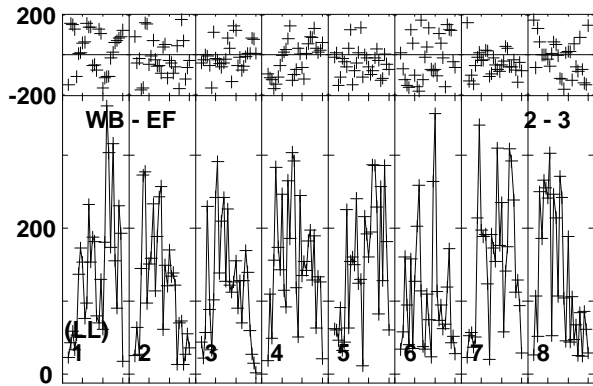
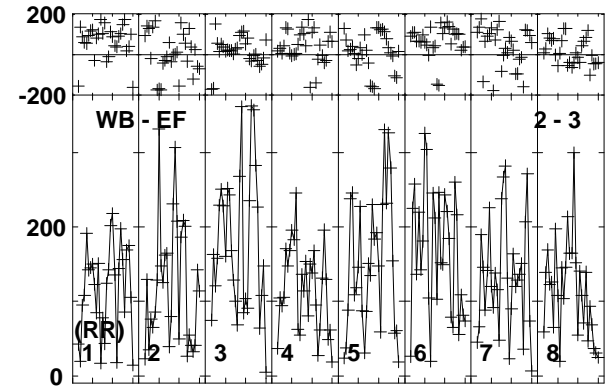
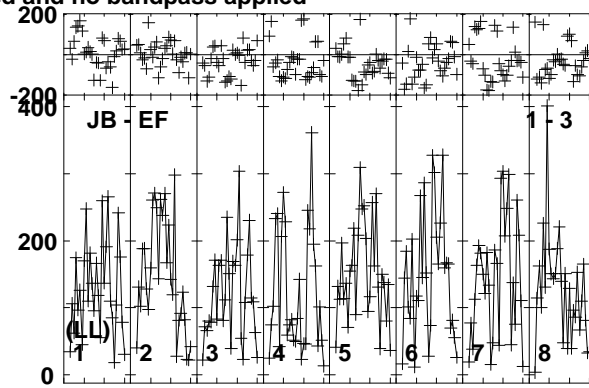
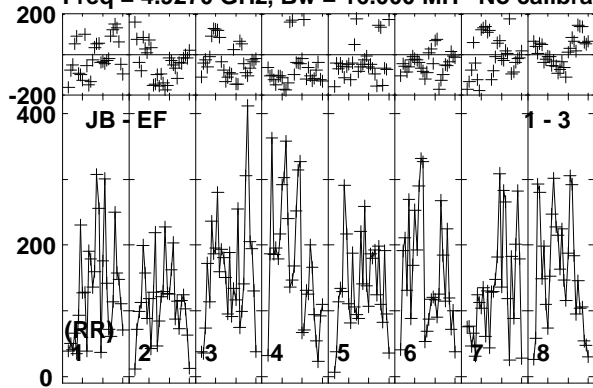

Lower frame: Micro Ampl Jy Top frame: Phas deg  
Vector averaged cross-power spectrum Baseline: JB (01) - EF (03)  
Timerange: 00/11:02:01 to 00/11:03:59

Plot file version 296 created 19-DEC-2018 17:58:32  
 AT2018\_RY007C.UVDATA.1

Freq = 4.9270 GHz, Bw = 16.000 MH No calibration applied and no bandpass applied

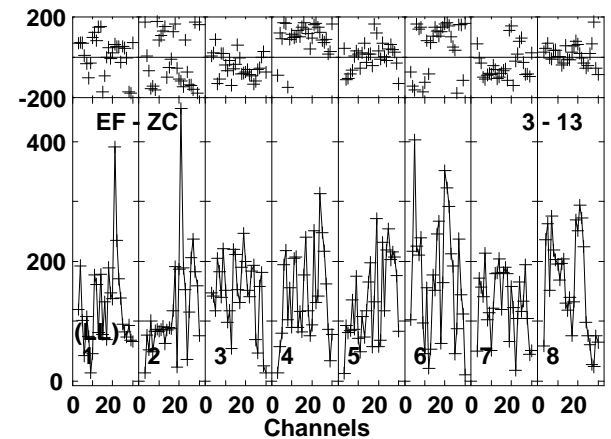
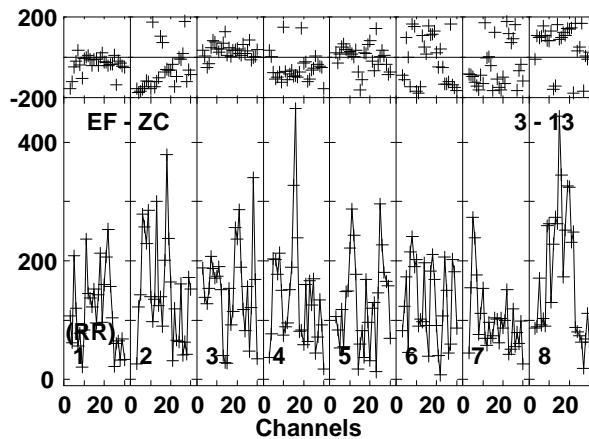
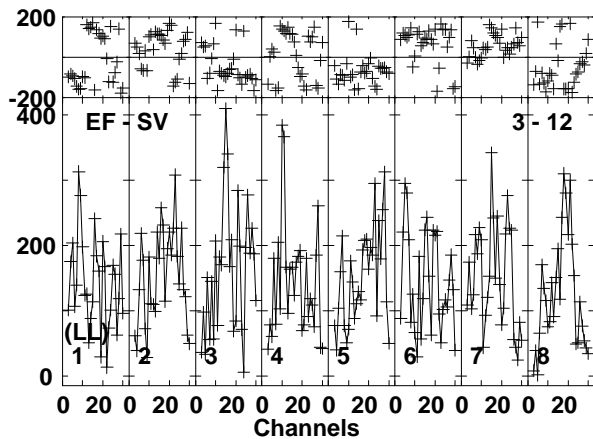
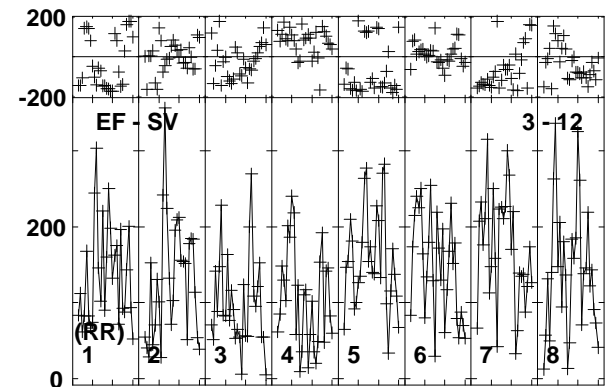
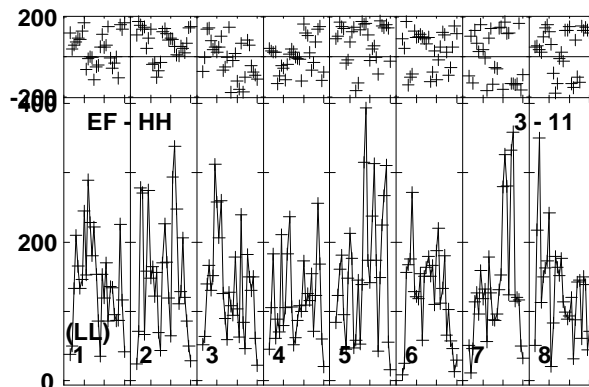
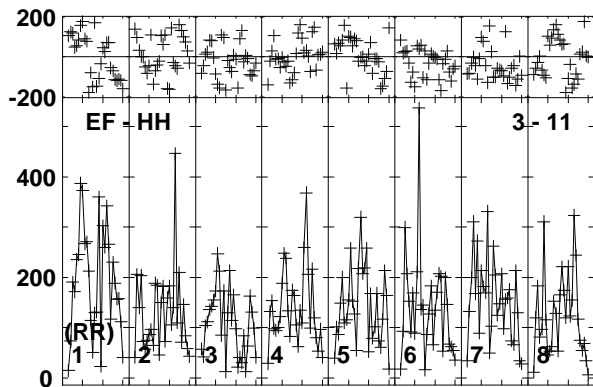
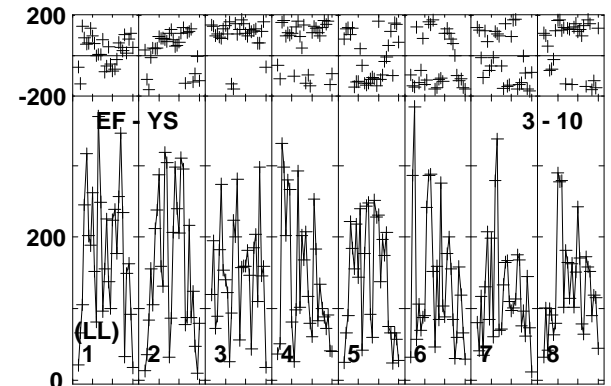
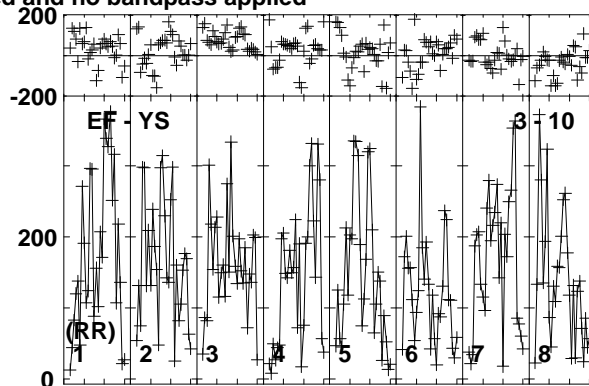
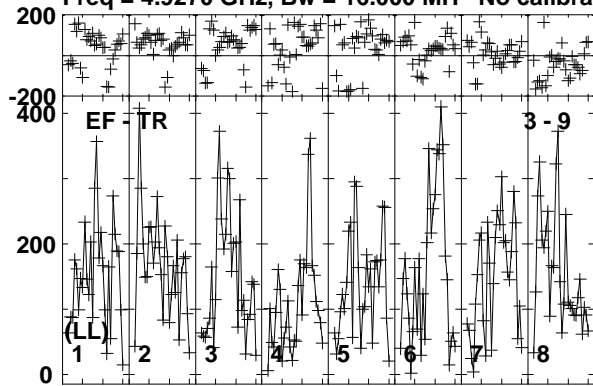

Lower frame: Micro Ampl Jy Top frame: Phas deg  
 Vector averaged cross-power spectrum Baseline: EF (03) - TR (09)  
 Timerange: 00/11:02:01 to 00/11:03:59

Plot file version 297 created 19-DEC-2018 17:58:32

AT2018\_RY007C.UVDATA.1

Freq = 4.9270 GHz, Bw = 16.000 MH No calibration applied and no bandpass applied

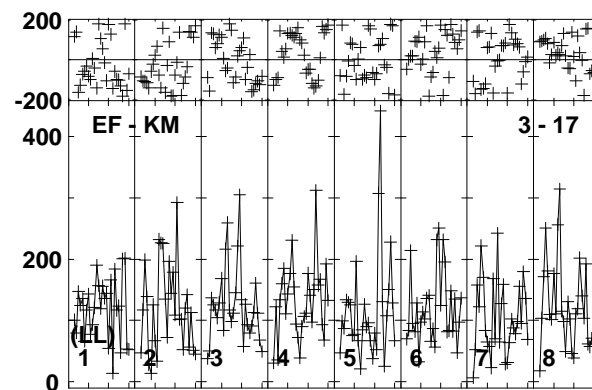
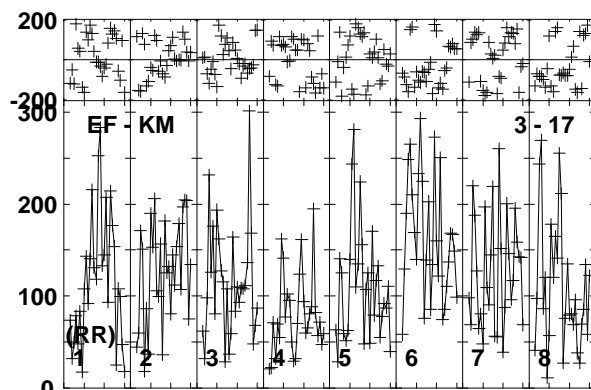
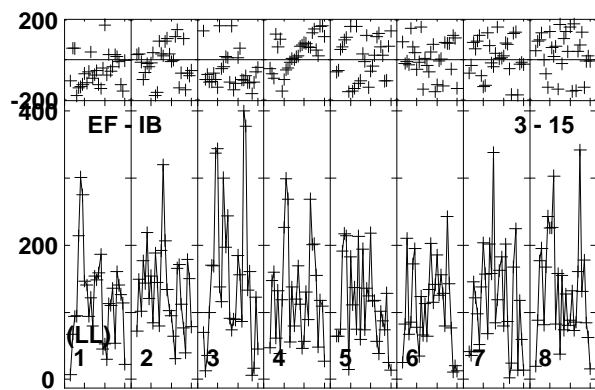
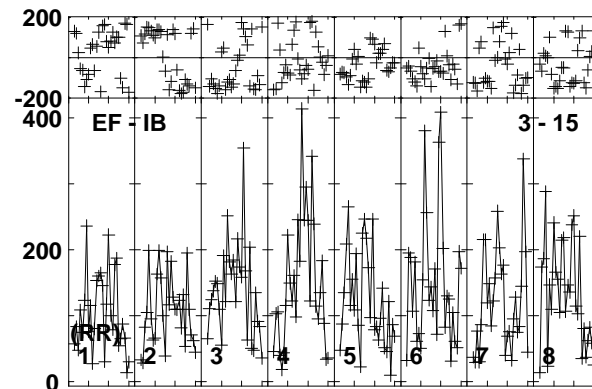
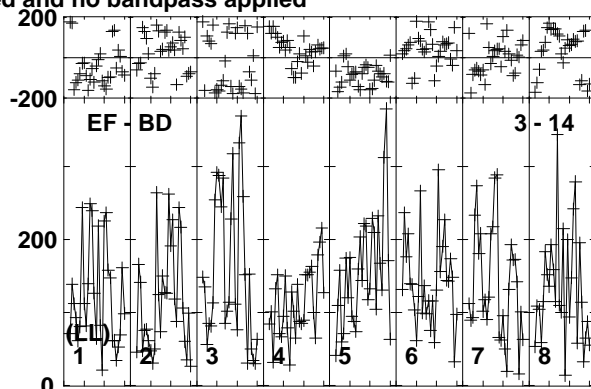
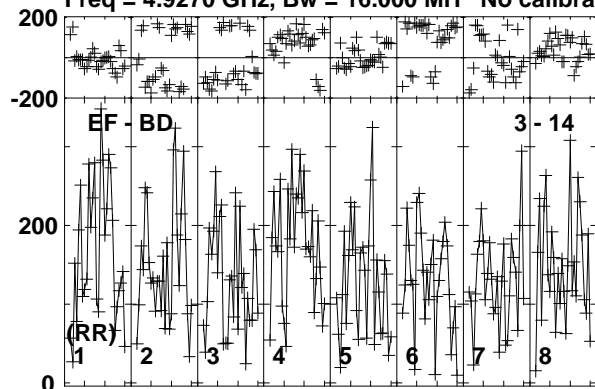

Lower frame: Micro Ampl Jy Top frame: Phas deg  
Vector averaged cross-power spectrum Baseline: EF (03) - BD (14)  
Timerange: 00/11:02:01 to 00/11:03:59

Plot file version 298 created 19-DEC-2018 17:58:32

VLA2 RY007C.UVDATA.1

Freq = 4.9270 GHz, Bw = 16.000 MH No calibration applied and no bandpass applied

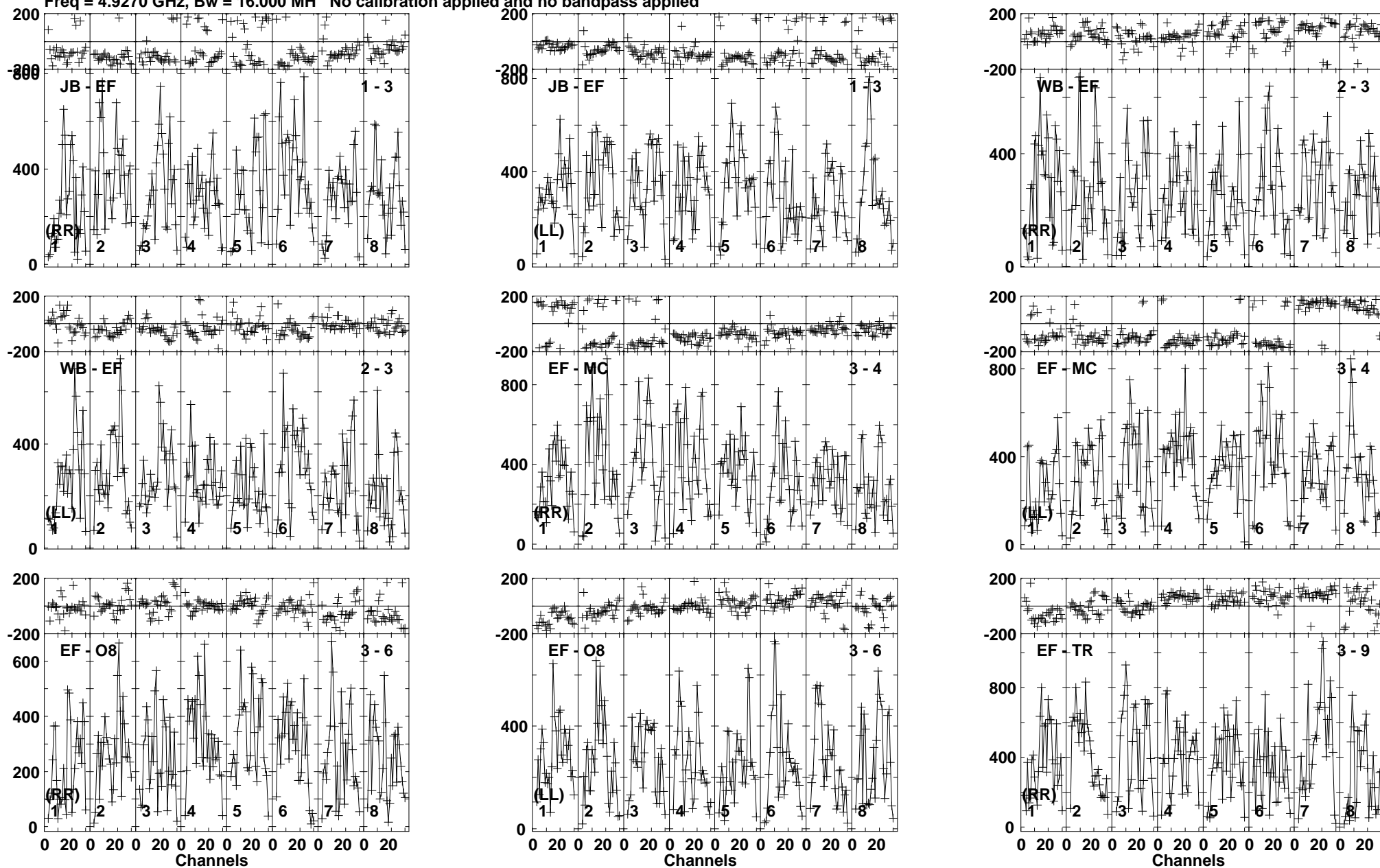

Lower frame: Micro Ampl Jy Top frame: Phas deg  
Vector averaged cross-power spectrum Baseline: JB (01) - EF (03)  
Timerange: 00/11:04:01 to 00/11:04:59



Plot file version 299 created 19-DEC-2018 17:58:32

VLA2 RY007C.UVDATA.1

Freq = 4.9270 GHz, Bw = 16.000 MH No calibration applied and no bandpass applied

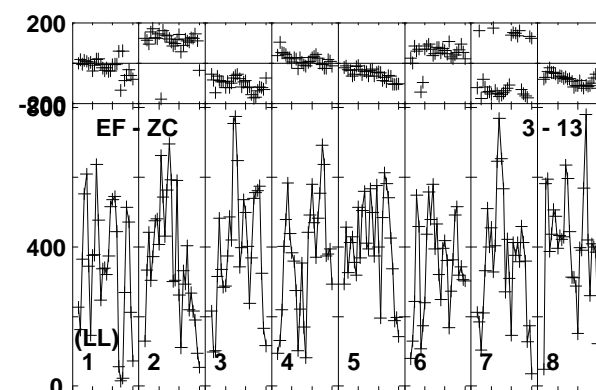
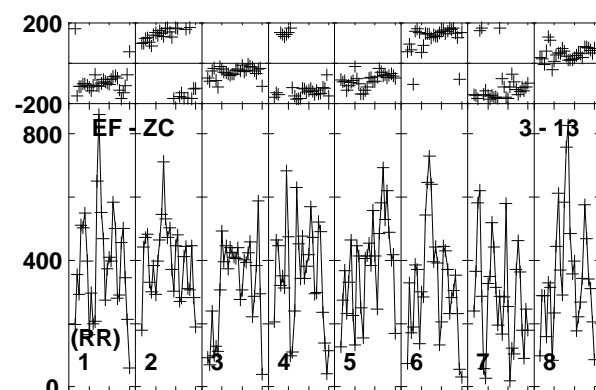
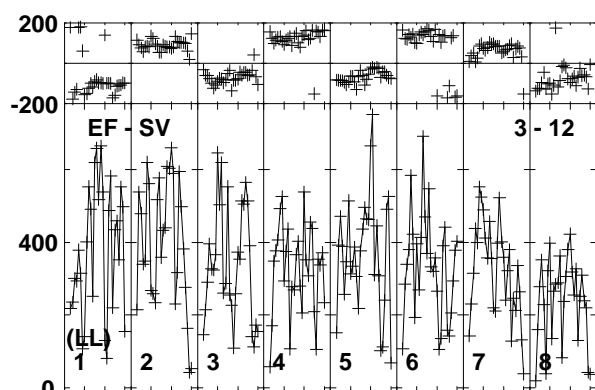
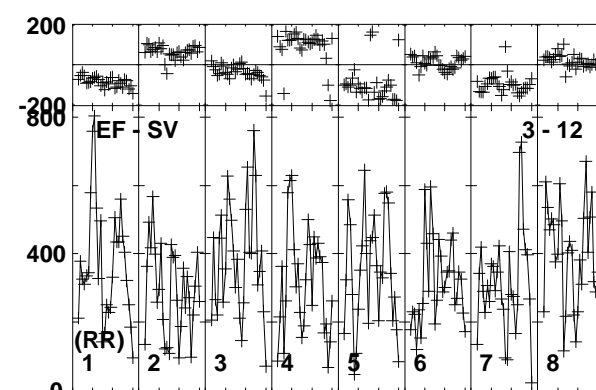
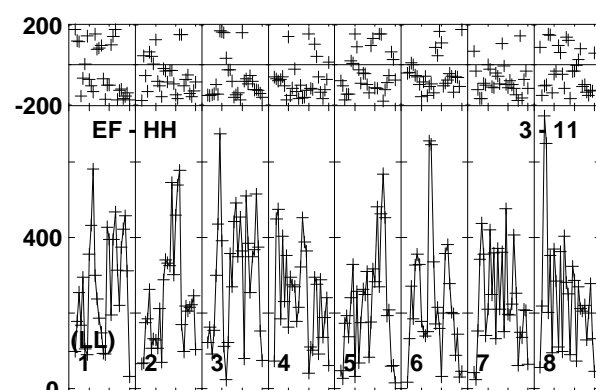
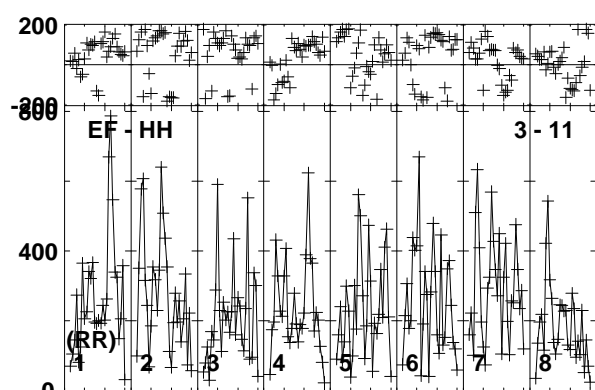
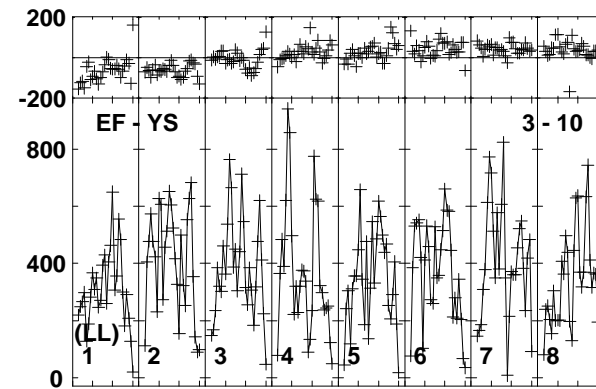
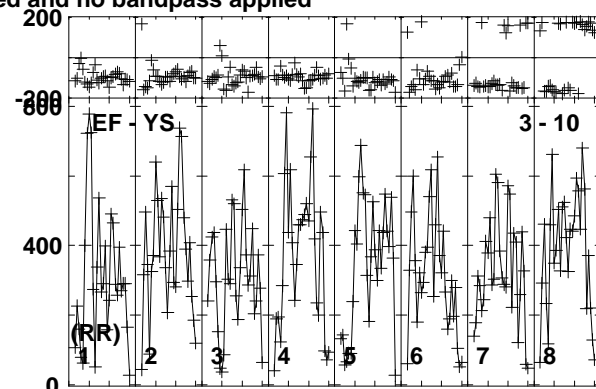
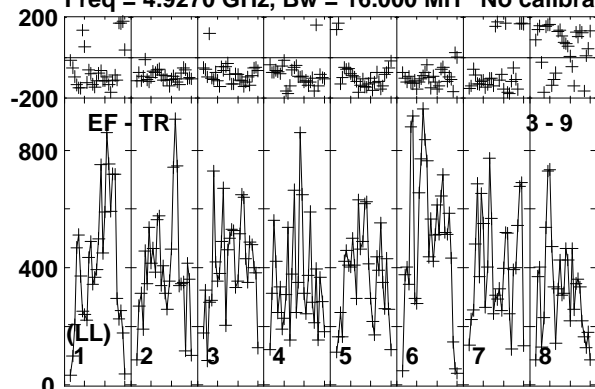

Lower frame: Micro Ampl Jy Top frame: Phas deg  
Vector averaged cross-power spectrum Baseline: EF (03) - TR (09)  
Timerange: 00/11:04:01 to 00/11:04:59

Plot file version 300 created 19-DEC-2018 17:58:32

VLA2 RY007C.UVDATA.1

Freq = 4.9270 GHz, Bw = 16.000 MH No calibration applied and no bandpass applied

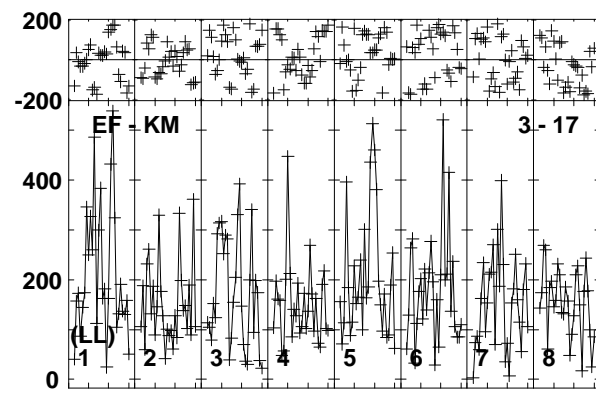
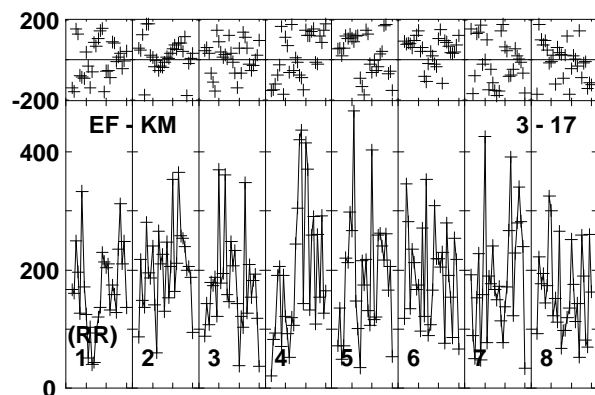
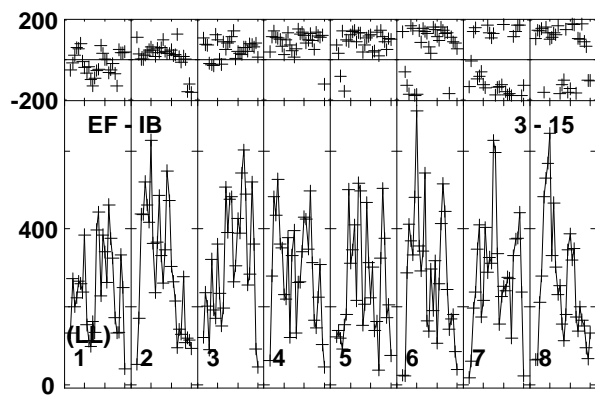
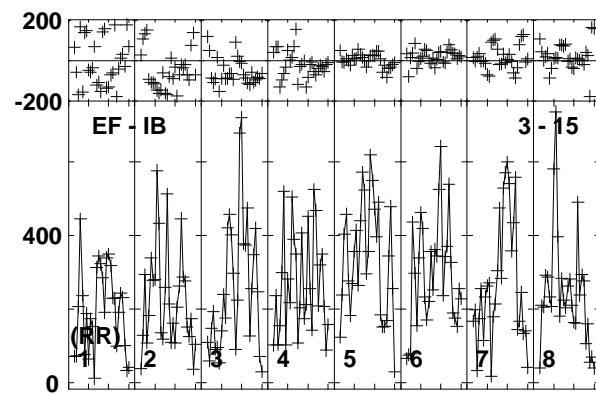
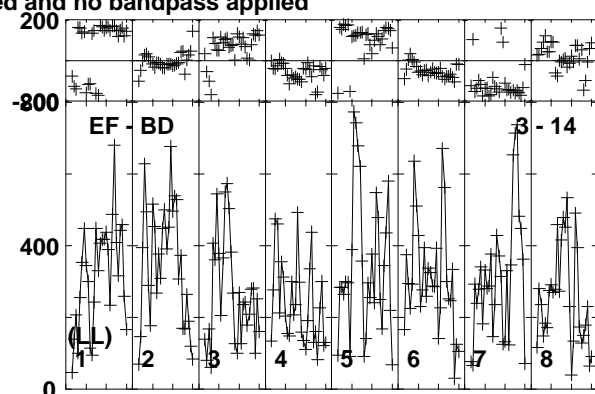
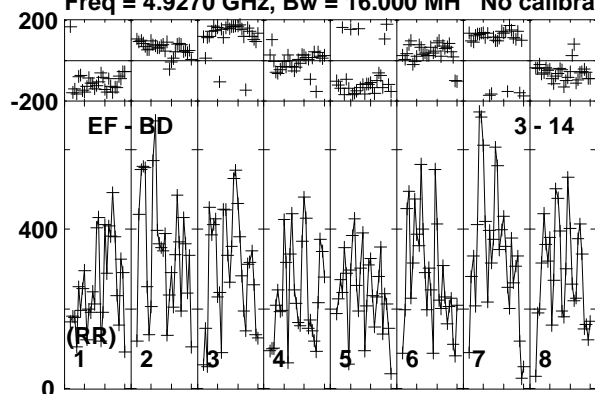

Lower frame: Micro Ampl Jy Top frame: Phas deg  
Vector averaged cross-power spectrum Baseline: EF (03) - BD (14)  
Timerange: 00/11:04:01 to 00/11:04:59

Plot file version 301 created 19-DEC-2018 17:58:32

J1619+2247 RY007C.UVDATA.1

Freq = 4.9270 GHz, Bw = 16.000 MH No calibration applied and no bandpass applied

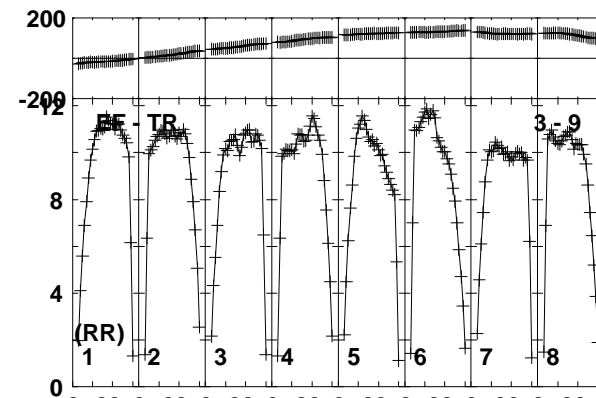
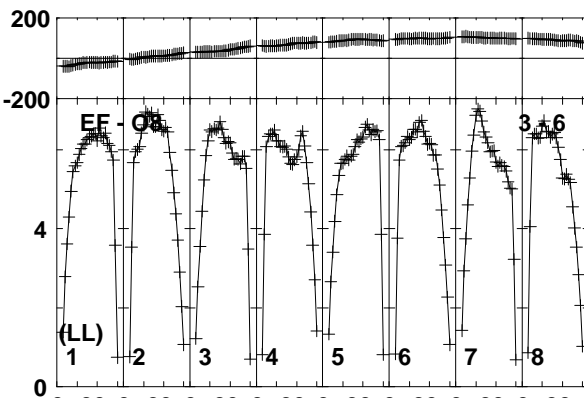
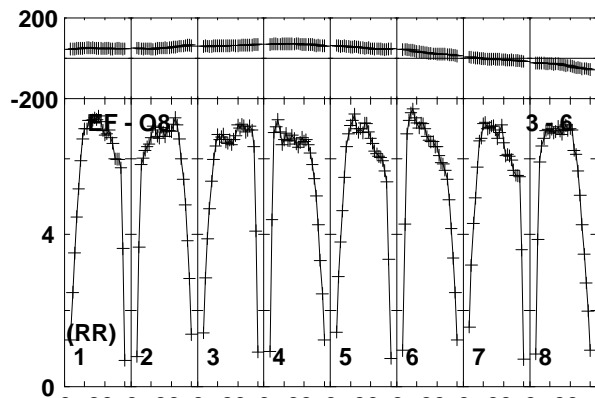
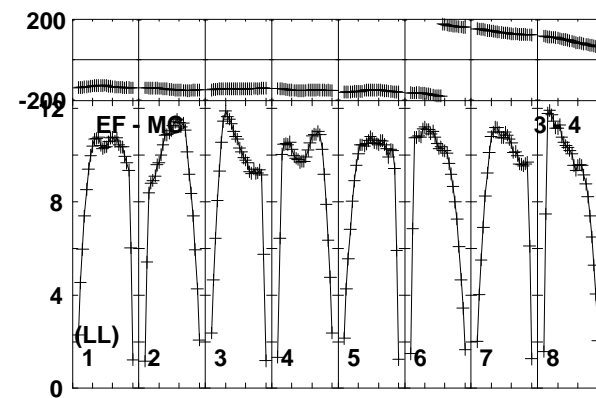
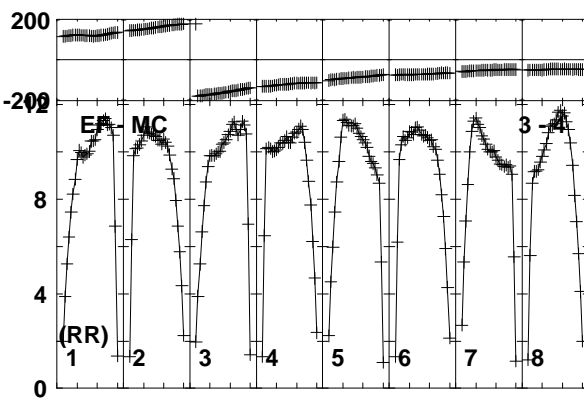
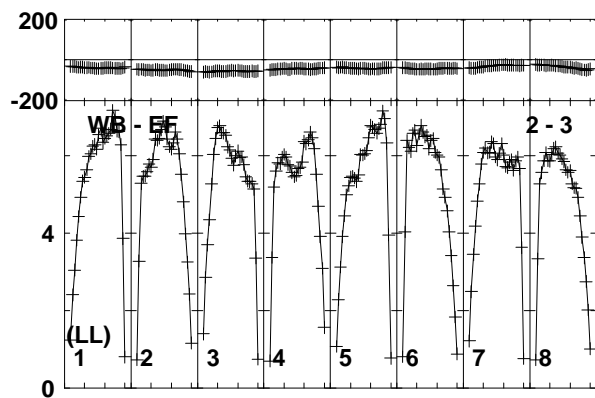
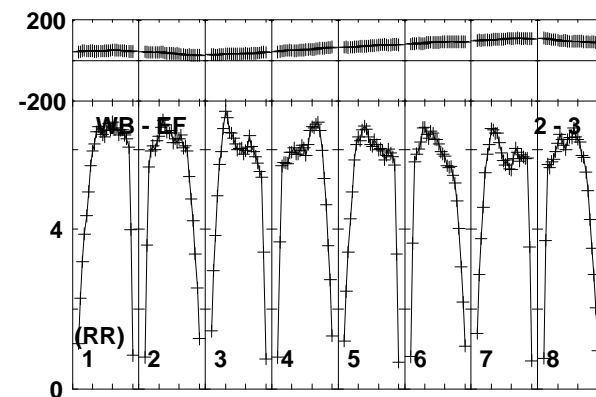
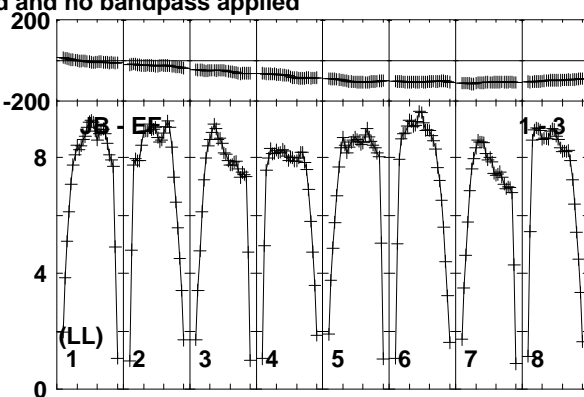
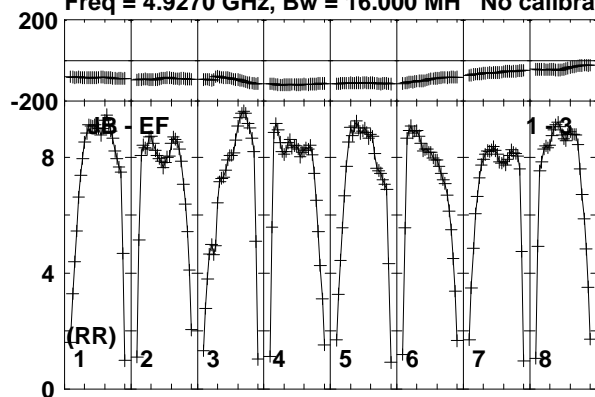

Lower frame: Milli Ampl Jy Top frame: Phas deg  
Vector averaged cross-power spectrum Baseline: JB (01) - EF (03)  
Timerange: 00/11:05:31 to 00/11:06:29

Plot file version 302 created 19-DEC-2018 17:58:33

J1619+2247 RY007C.UVDATA.1

Freq = 4.9270 GHz, Bw = 16.000 MH No calibration applied and no bandpass applied

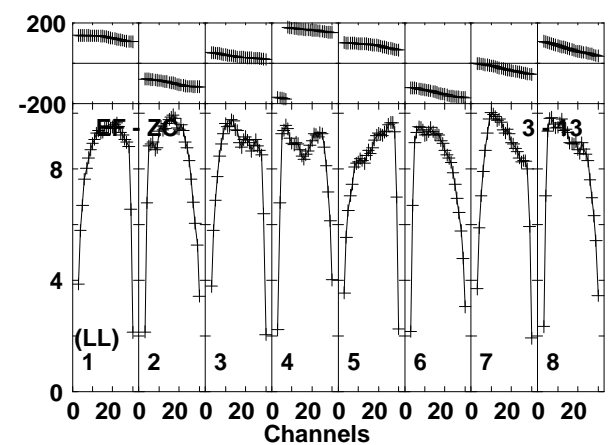
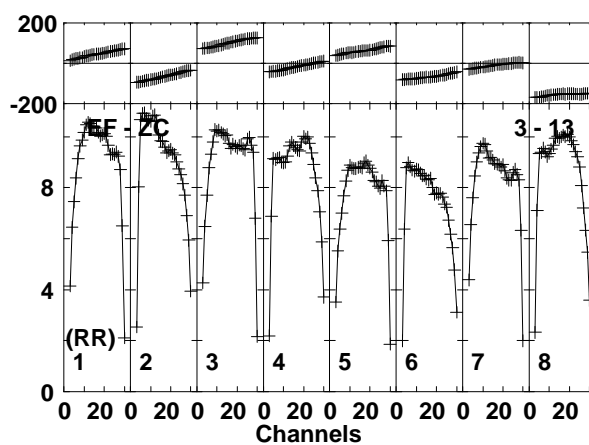
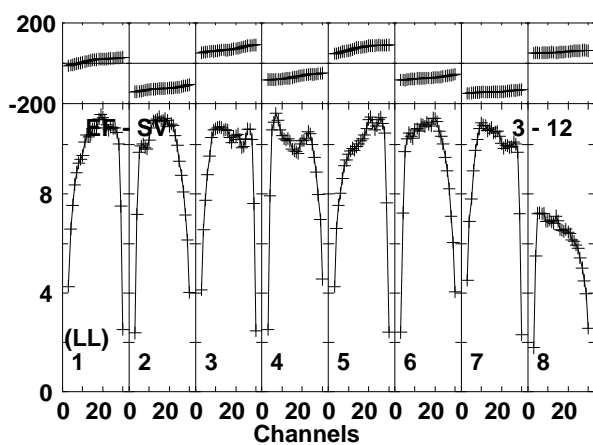
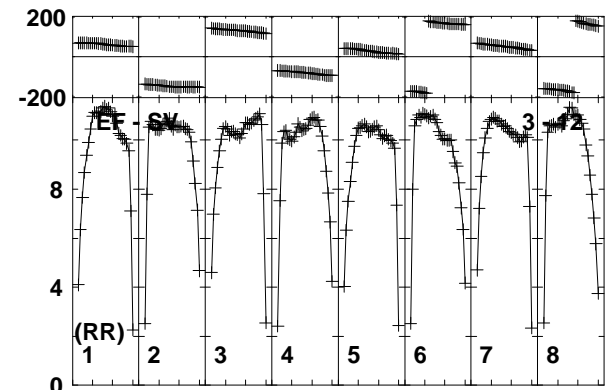
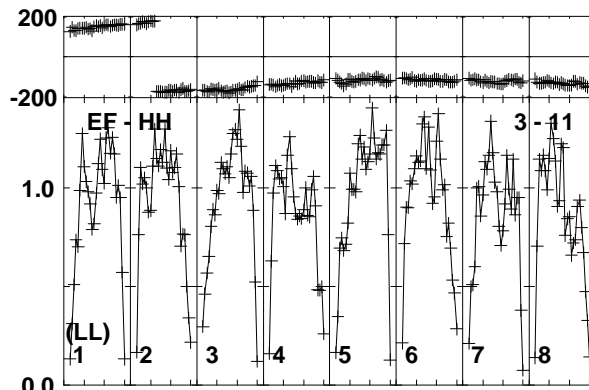
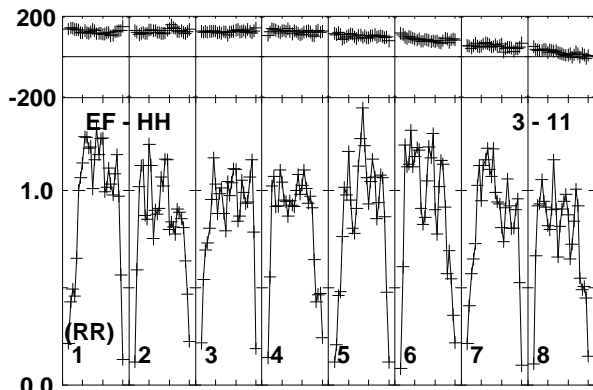
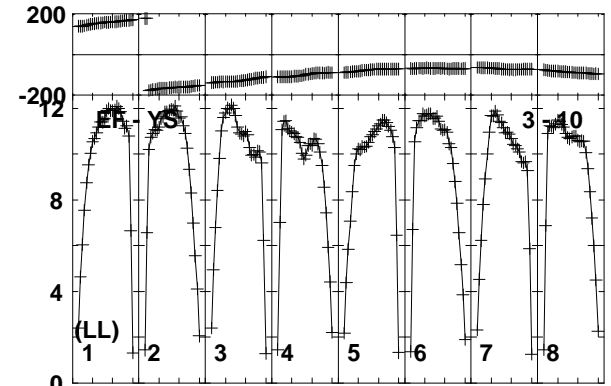
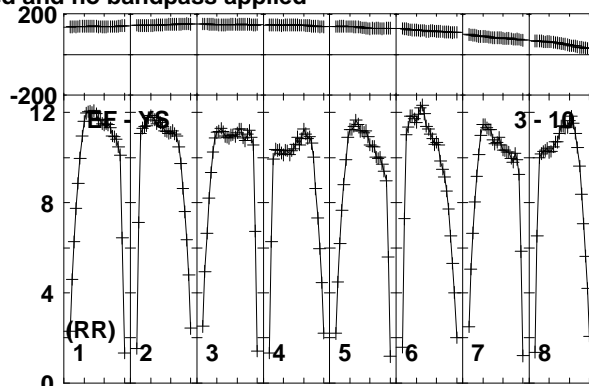
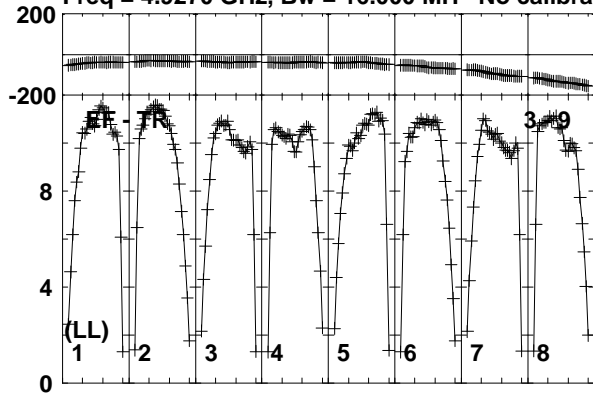

Lower frame: Milli Ampl Jy Top frame: Phas deg  
Vector averaged cross-power spectrum Baseline: EF (03) - TR (09)  
Timerange: 00/11:05:31 to 00/11:06:29

Plot file version 303 created 19-DEC-2018 17:58:33

J1619+2247 RY007C.UVDATA.1

Freq = 4.9270 GHz, Bw = 16.000 MH No calibration applied and no bandpass applied

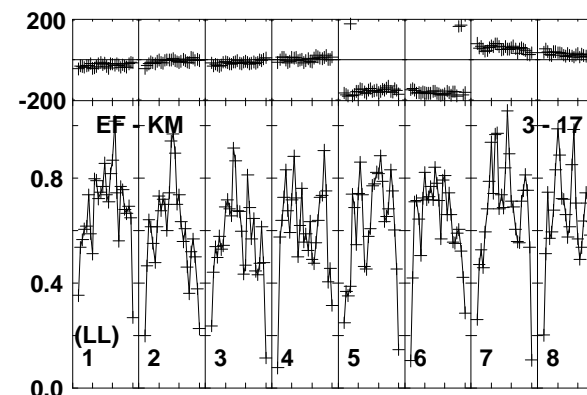
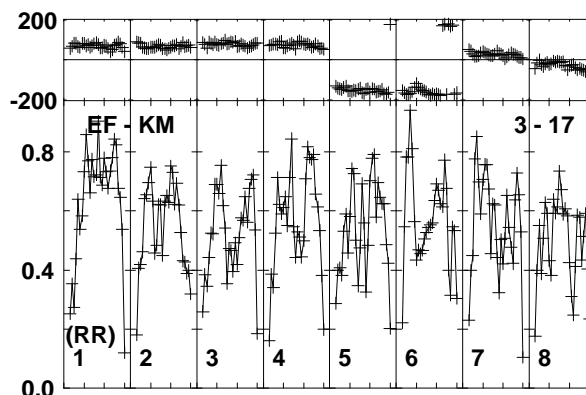
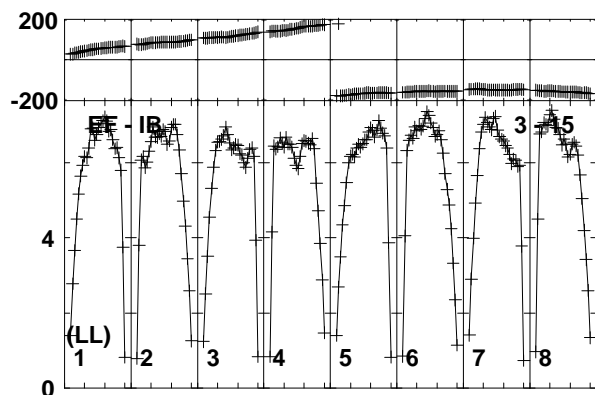
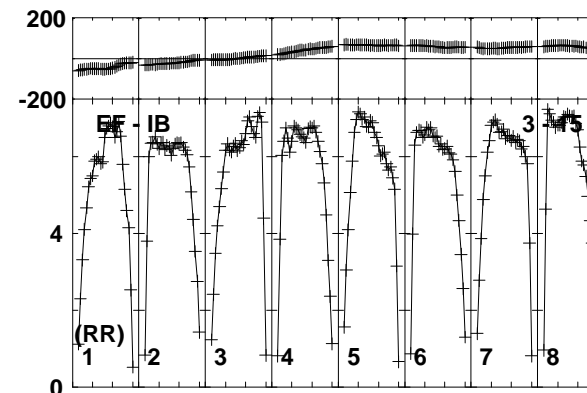
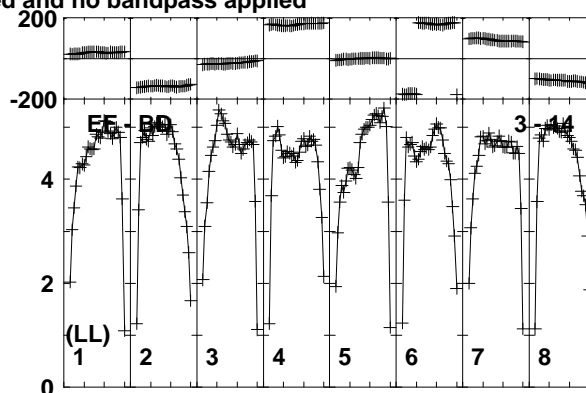
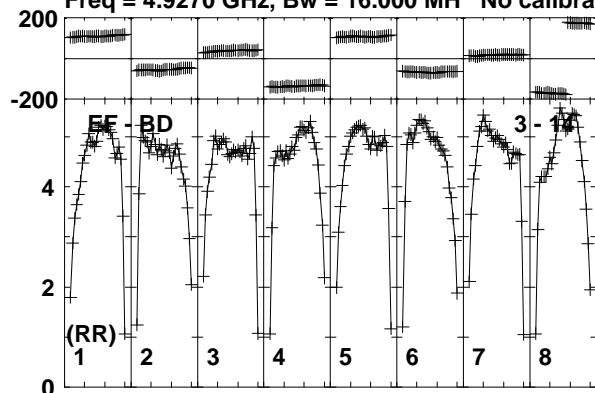

Lower frame: Milli Ampl Jy Top frame: Phas deg

Vector averaged cross-power spectrum Baseline: EF (03) - BD (14)

Timerange: 00/11:05:31 to 00/11:06:29

Plot file version 304 created 19-DEC-2018 17:58:33

AT2018\_RY007C.UVDATA.1

Freq = 4.9270 GHz, Bw = 16.000 MH No calibration applied and no bandpass applied

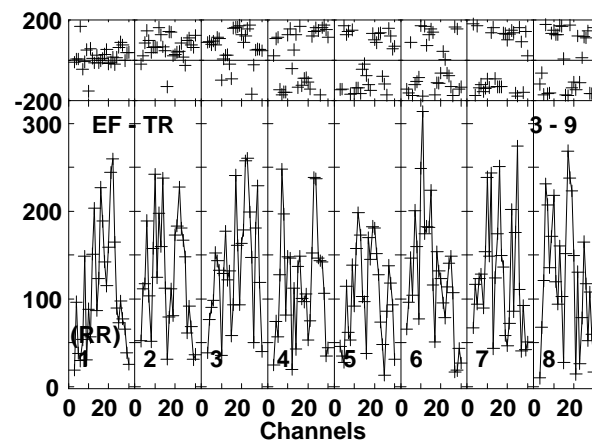
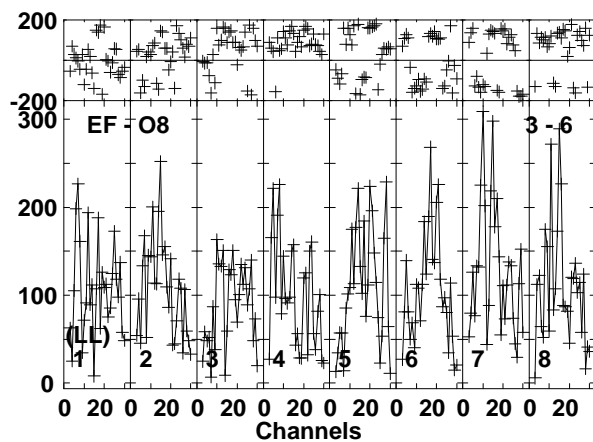
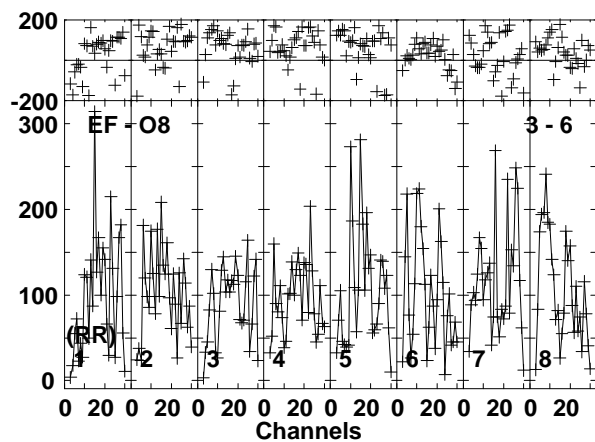
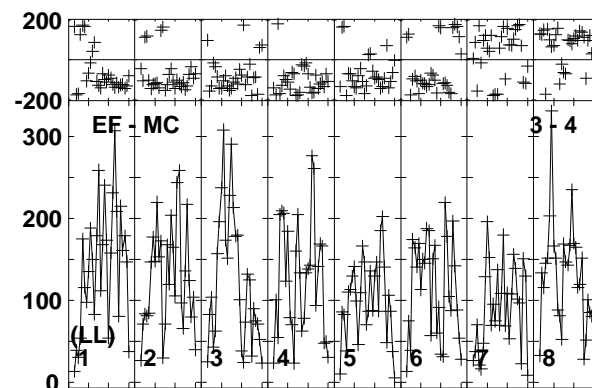
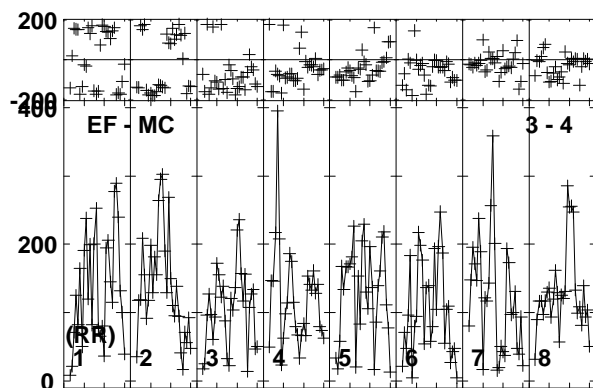
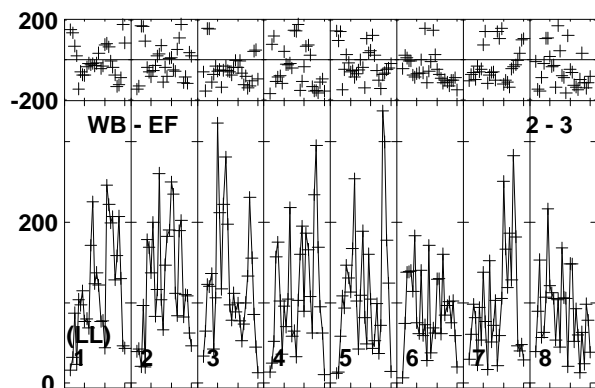
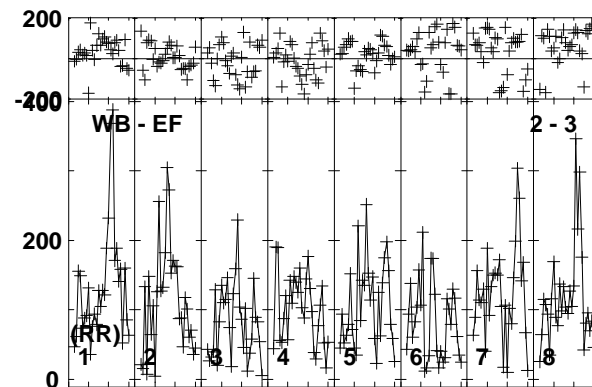
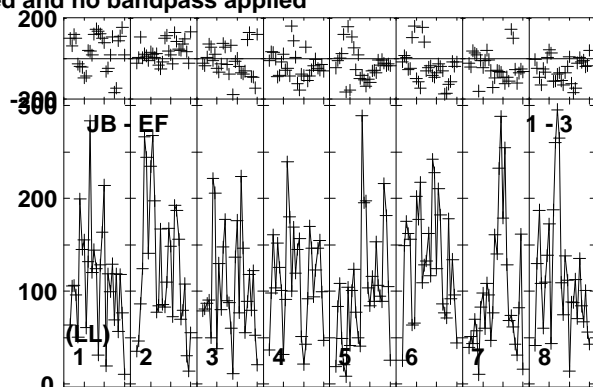
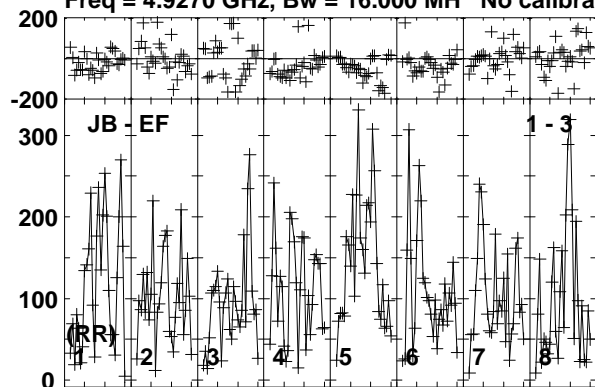

Lower frame: Micro Ampl Jy Top frame: Phas deg  
Vector averaged cross-power spectrum Baseline: JB (01) - EF (03)  
Timerange: 00/11:06:31 to 00/11:09:29

Plot file version 305 created 19-DEC-2018 17:58:33

AT2018\_RY007C.UVDATA.1

Freq = 4.9270 GHz, Bw = 16.000 MH No calibration applied and no bandpass applied

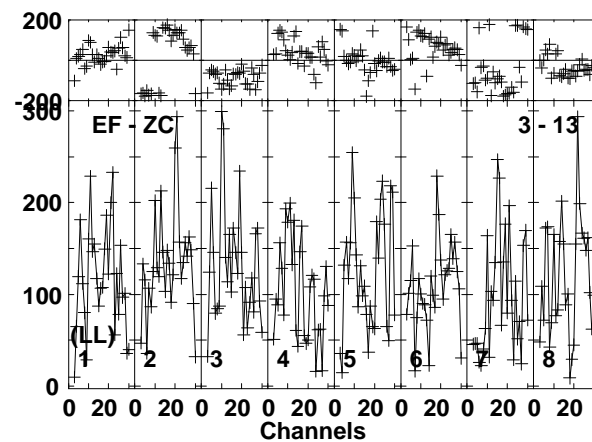
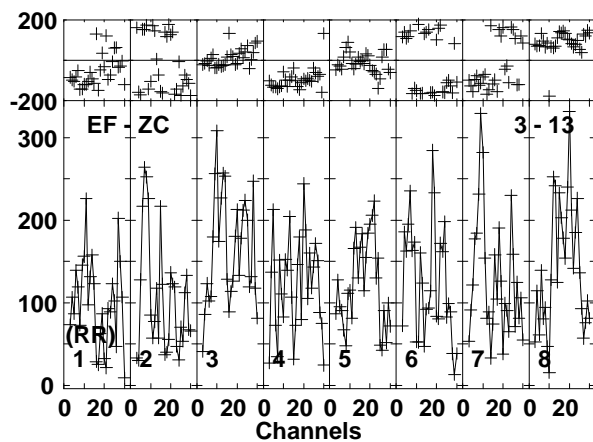
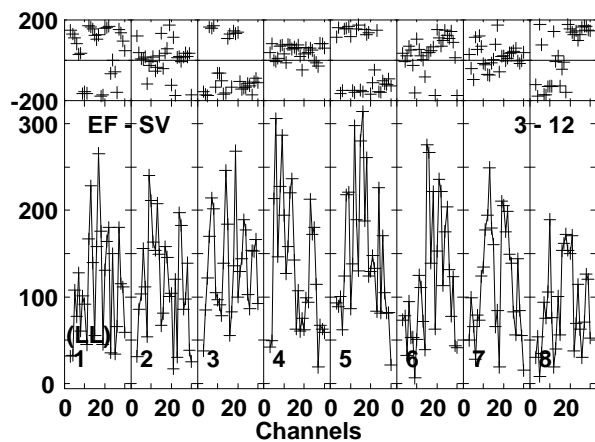
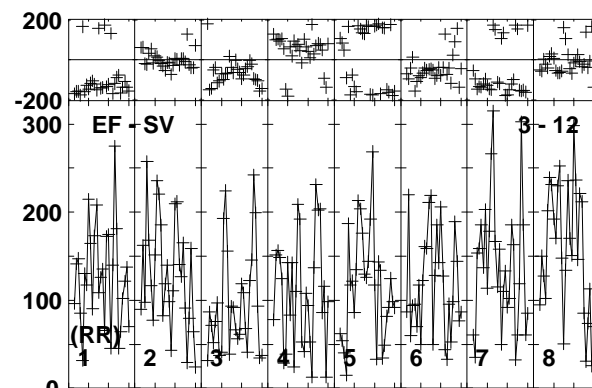
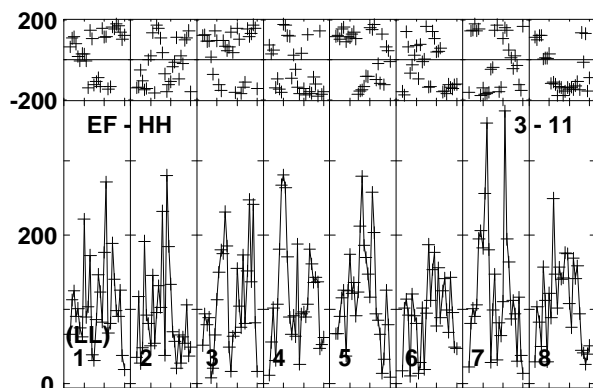
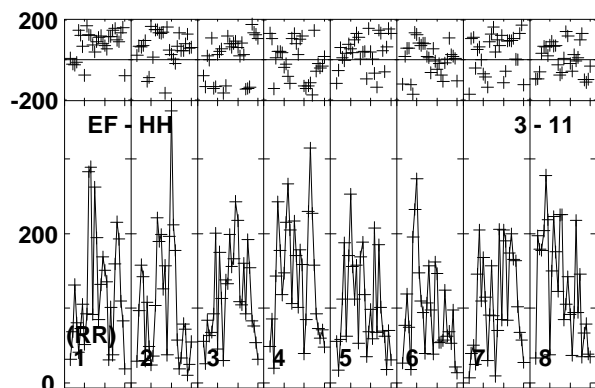
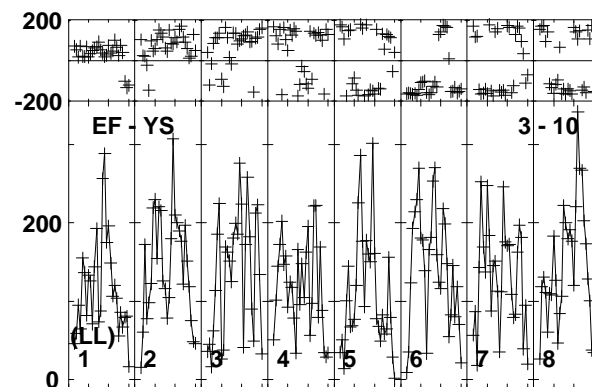
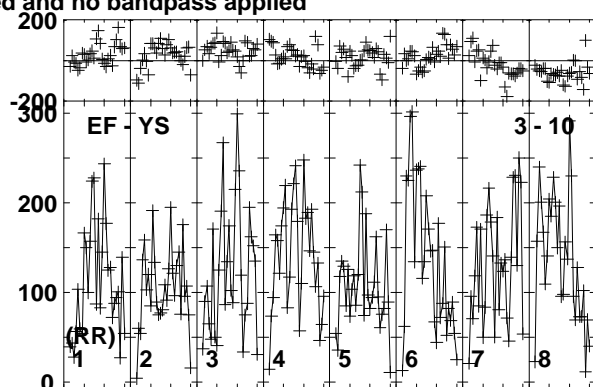
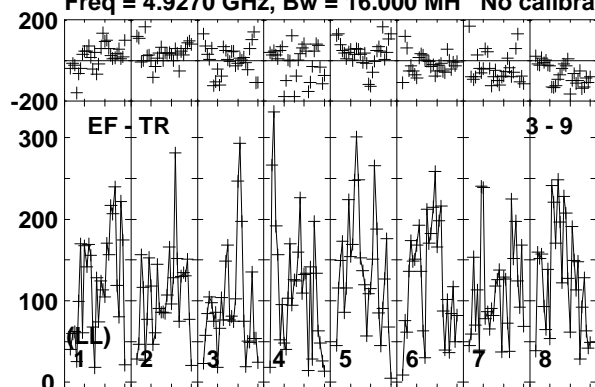

Lower frame: Micro Ampl Jy Top frame: Phas deg  
Vector averaged cross-power spectrum Baseline: EF (03) - TR (09)  
Timerange: 00/11:06:31 to 00/11:09:29

Plot file version 306 created 19-DEC-2018 17:58:33

AT2018\_RY007C.UVDATA.1

Freq = 4.9270 GHz, Bw = 16.000 MH No calibration applied and no bandpass applied

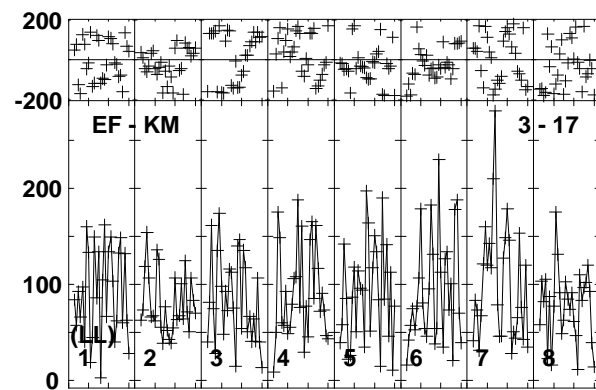
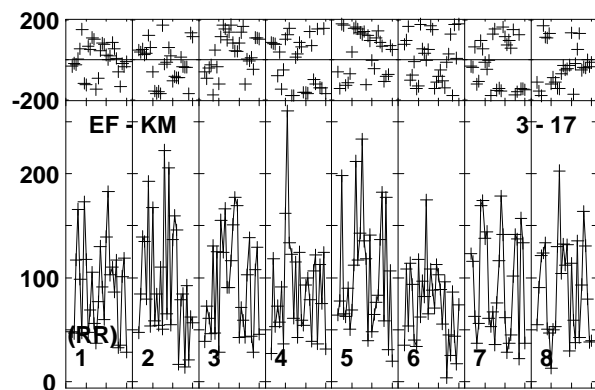
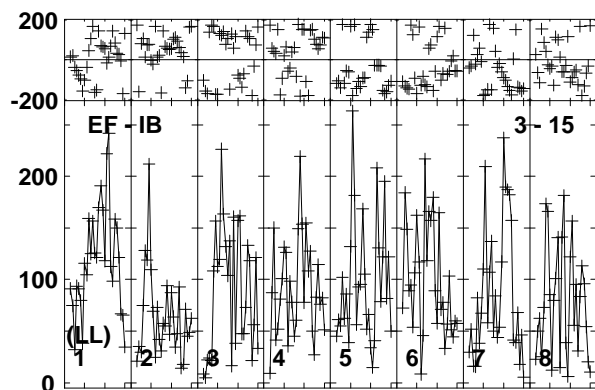
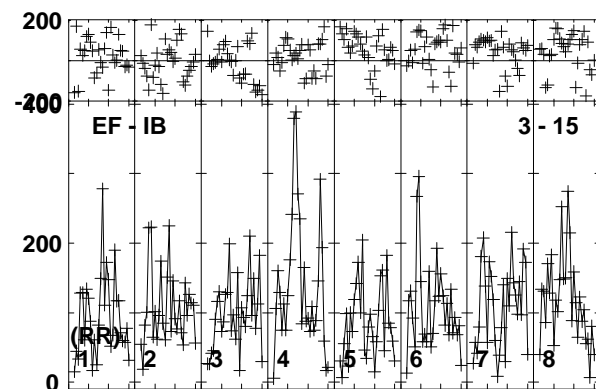
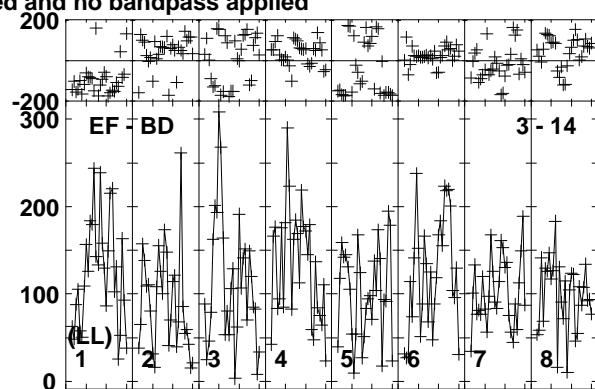
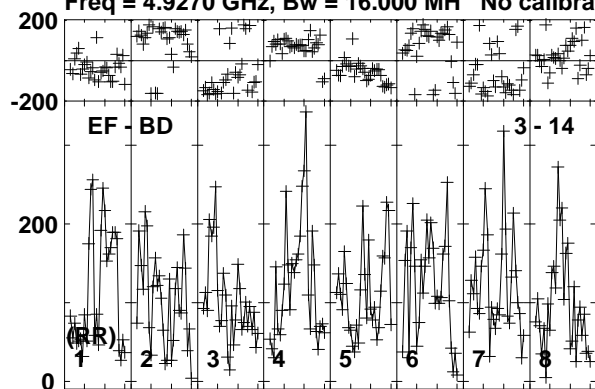

Lower frame: Micro Ampl Jy Top frame: Phas deg  
Vector averaged cross-power spectrum Baseline: EF (03) - BD (14)  
Timerange: 00/11:06:31 to 00/11:09:29



Plot file version 307 created 19-DEC-2018 17:58:33

J1619+2247 RY007C.UVDATA.1

Freq = 4.9270 GHz, Bw = 16.000 MH No calibration applied and no bandpass applied

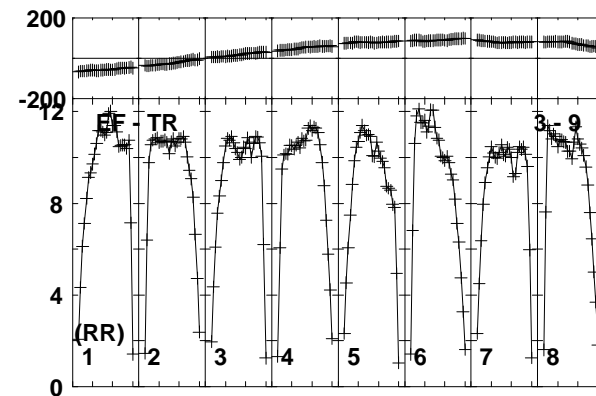
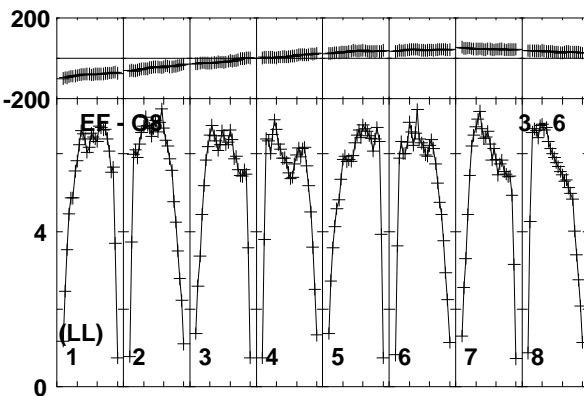
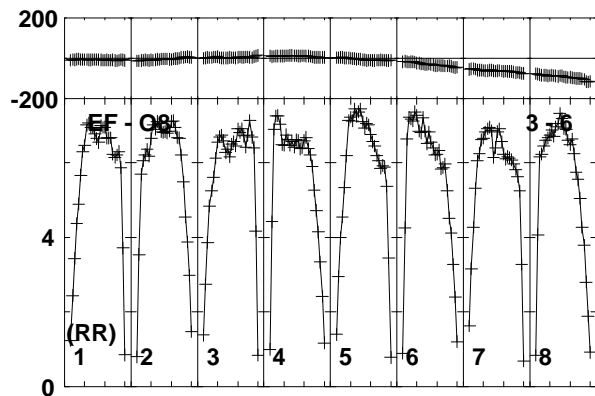
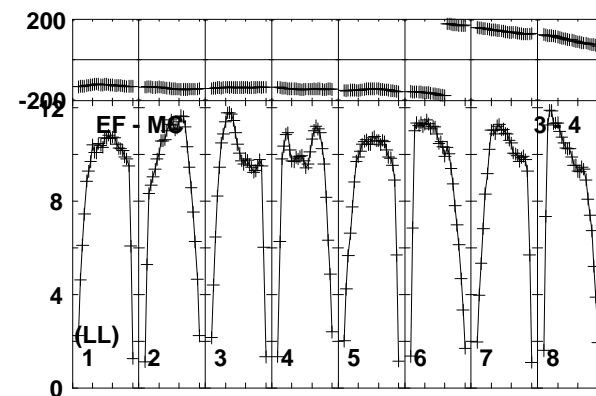
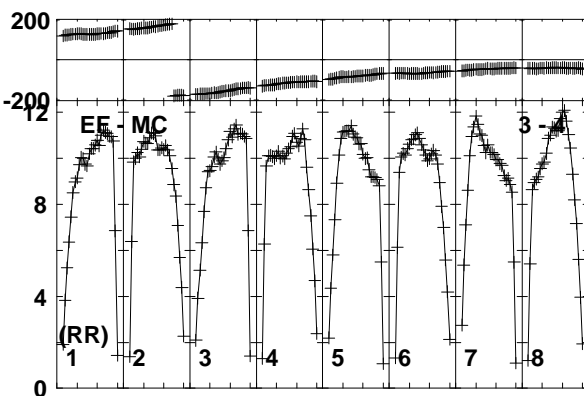
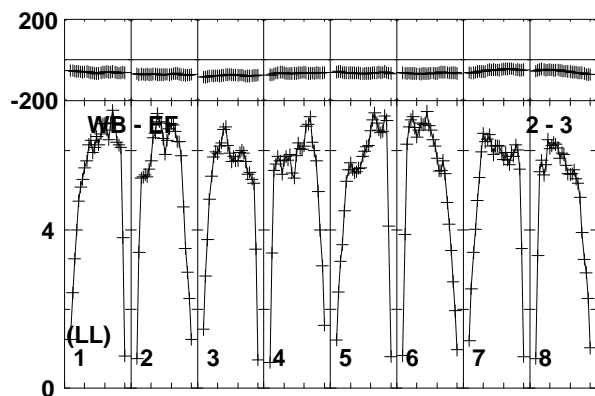
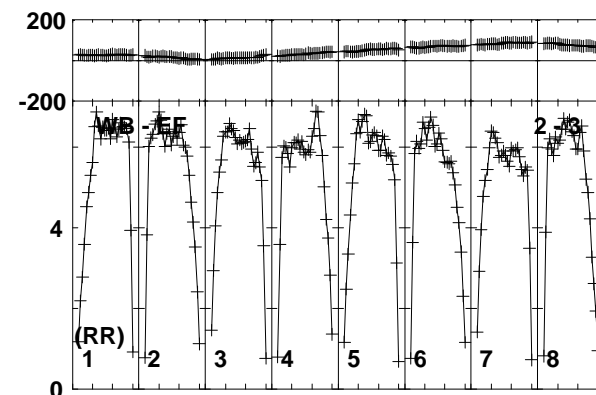
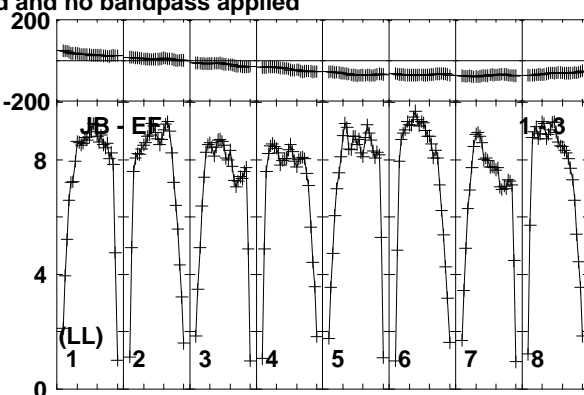
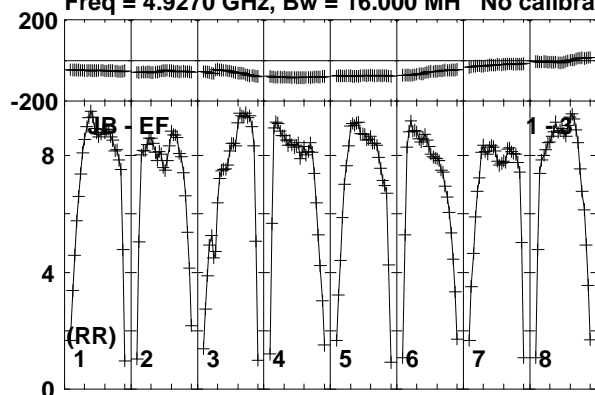

Lower frame: Milli Ampl Jy Top frame: Phas deg  
Vector averaged cross-power spectrum Baseline: JB (01) - EF (03)  
Timerange: 00/11:09:31 to 00/11:10:29

Plot file version 308 created 19-DEC-2018 17:58:33

J1619+2247 RY007C.UVDATA.1

Freq = 4.9270 GHz, Bw = 16.000 MH No calibration applied and no bandpass applied

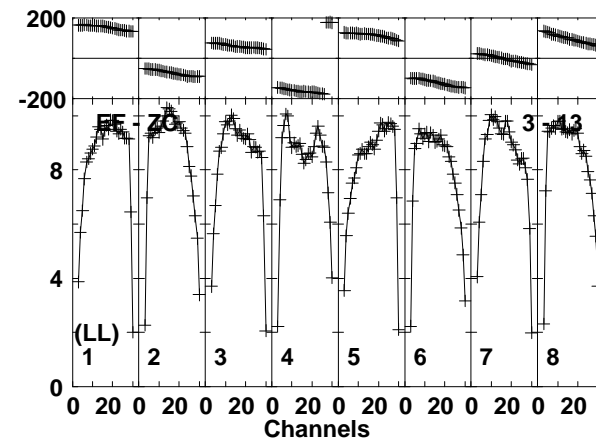
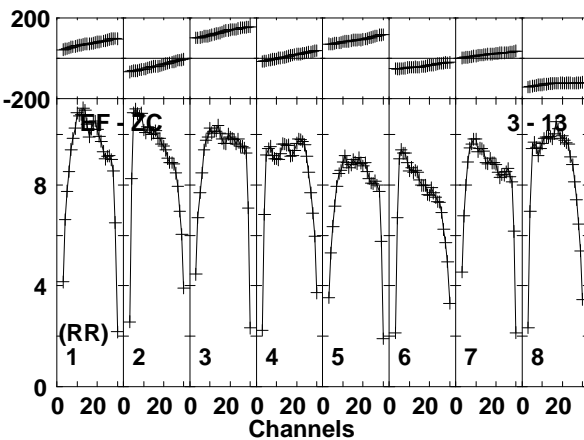
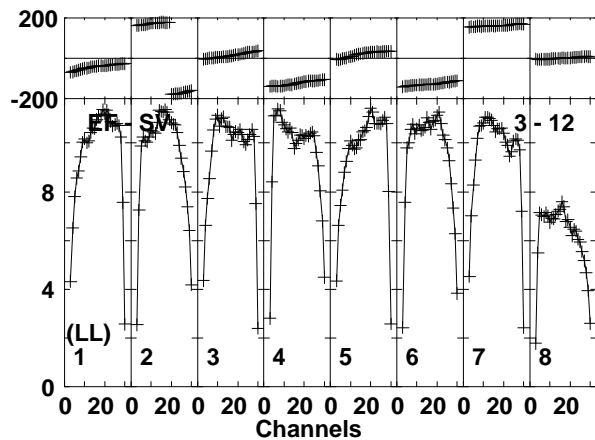
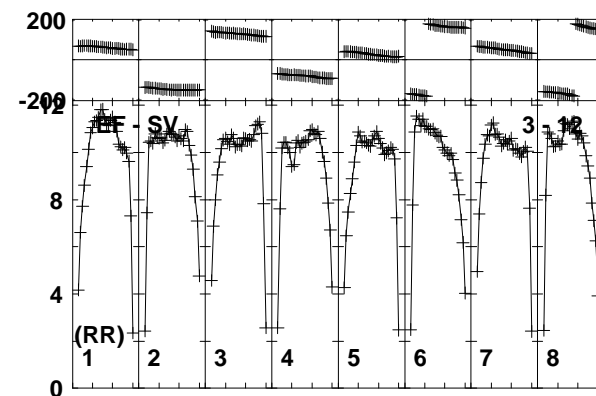
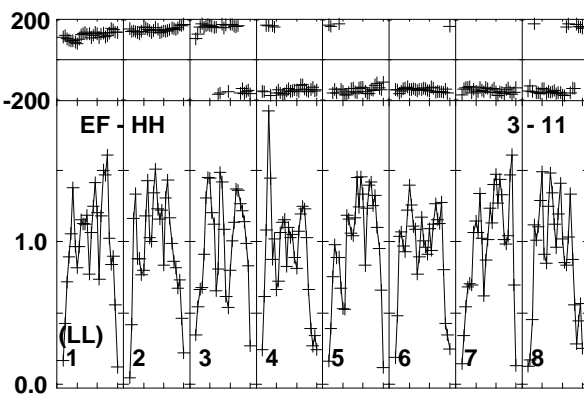
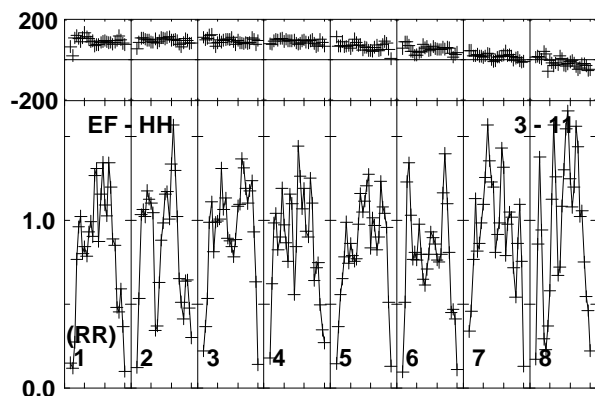
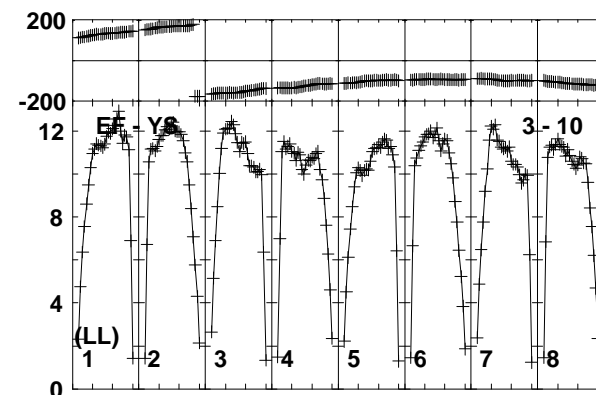
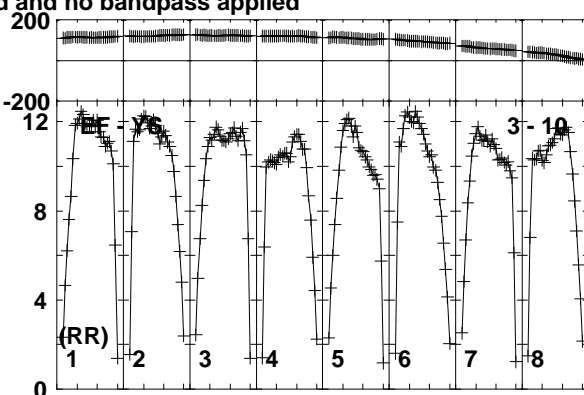
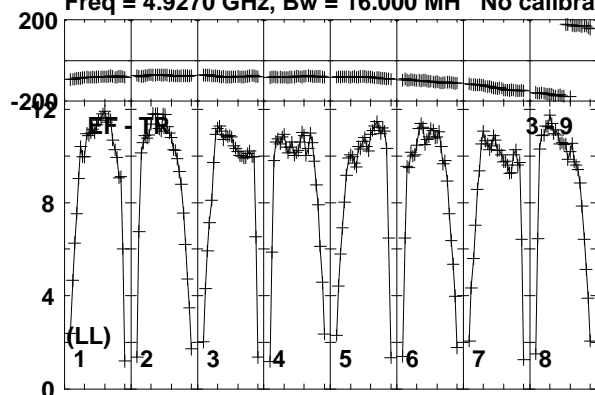

Lower frame: Milli Ampl Jy Top frame: Phas deg  
Vector averaged cross-power spectrum Baseline: EF (03) - TR (09)  
Timerange: 00/11:09:31 to 00/11:10:29

Plot file version 309 created 19-DEC-2018 17:58:33

J1619+2247 RY007C.UVDATA.1

Freq = 4.9270 GHz, Bw = 16.000 MH No calibration applied and no bandpass applied

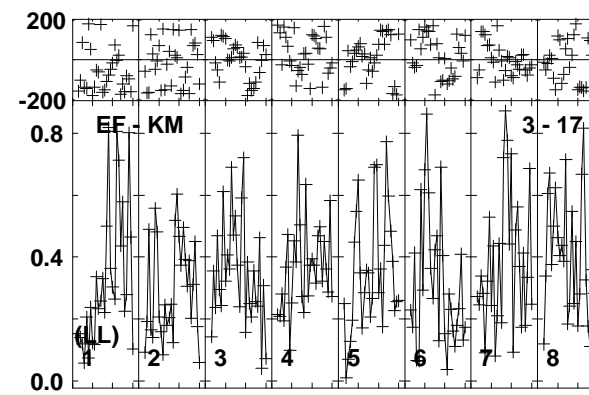
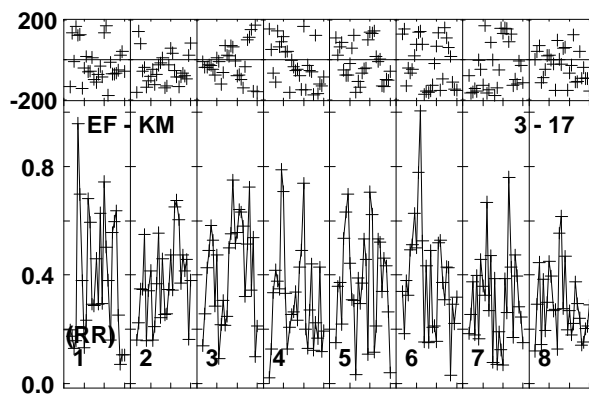
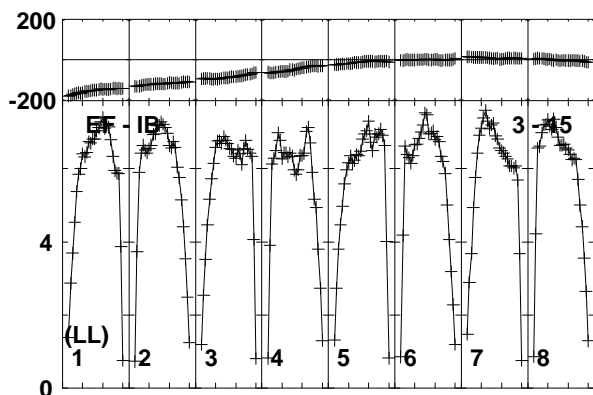
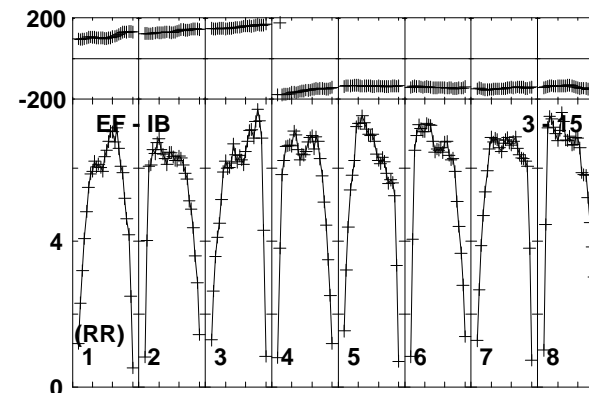
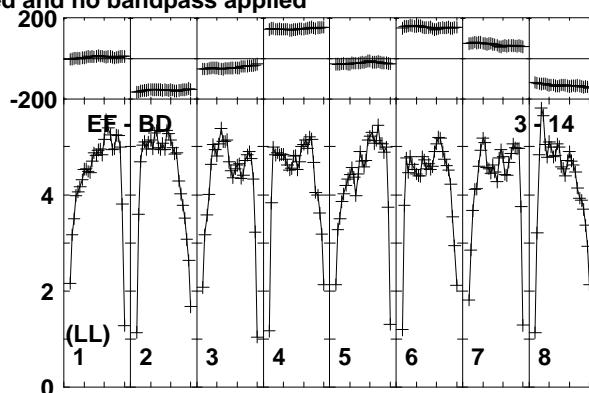
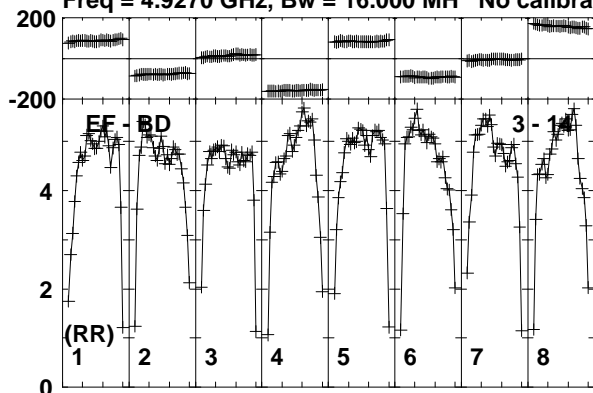

Lower frame: Milli Ampl Jy Top frame: Phas deg  
Vector averaged cross-power spectrum Baseline: EF (03) - BD (14)  
Timerange: 00/11:09:31 to 00/11:10:29

Plot file version 310 created 19-DEC-2018 17:58:33

AT2018\_RY007C.UVDATA.1

Freq = 4.9270 GHz, Bw = 16.000 MH No calibration applied and no bandpass applied

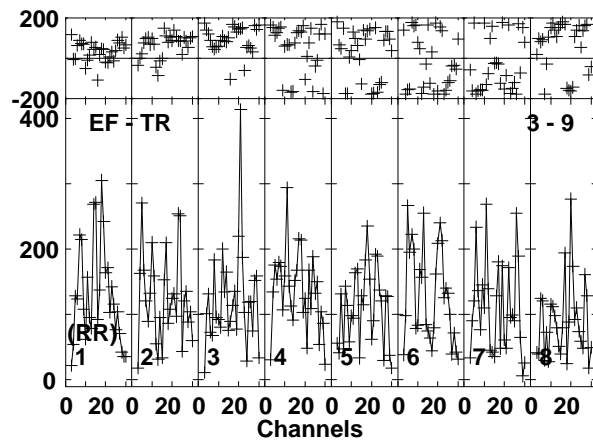
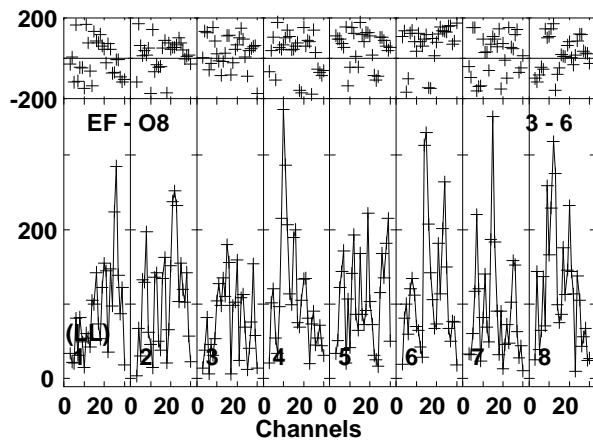
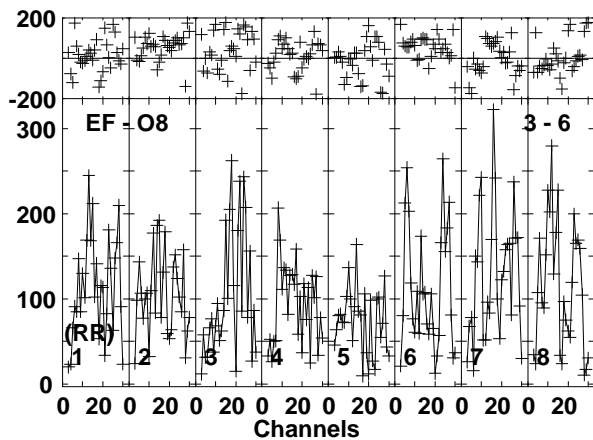
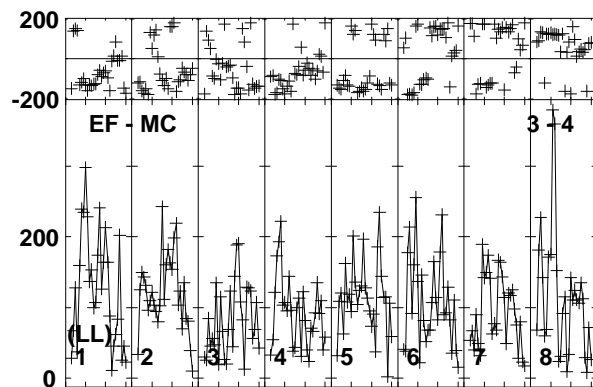
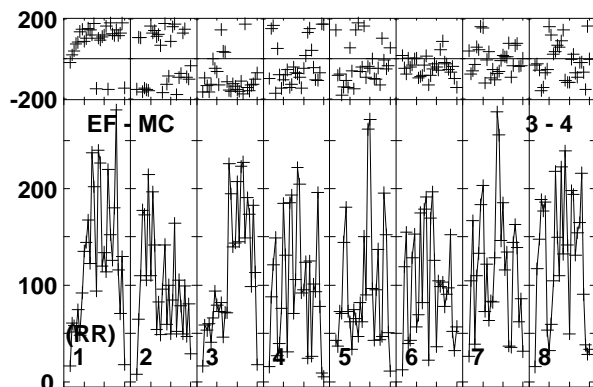
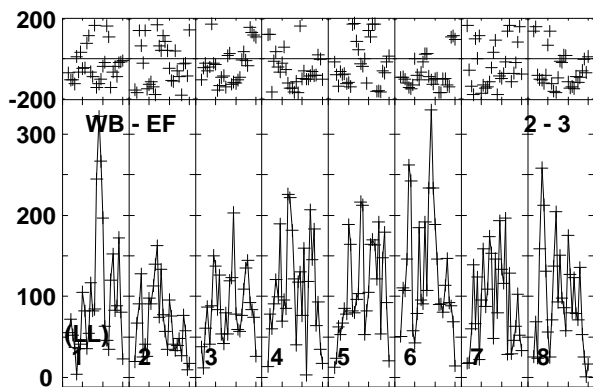
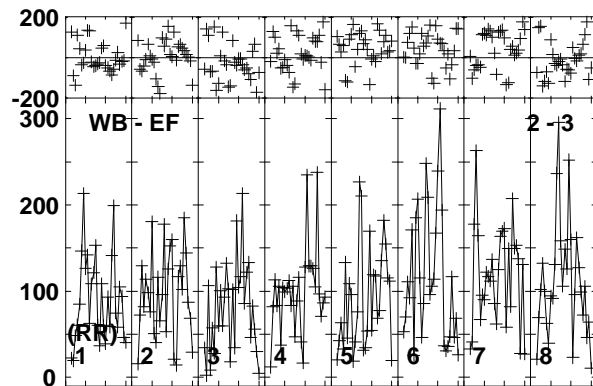
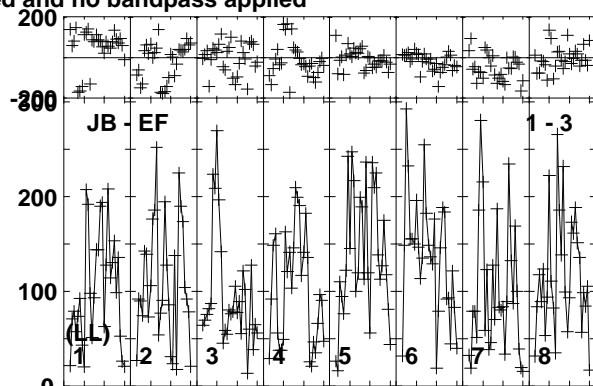
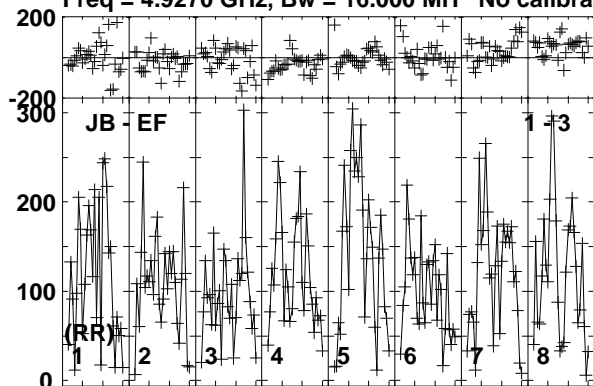

Lower frame: Micro Ampl Jy Top frame: Phas deg  
Vector averaged cross-power spectrum Baseline: JB (01) - EF (03)  
Timerange: 00/11:10:31 to 00/11:13:29

Plot file version 311 created 19-DEC-2018 17:58:33

AT2018\_RY007C.UVDATA.1

Freq = 4.9270 GHz, Bw = 16.000 MH No calibration applied and no bandpass applied

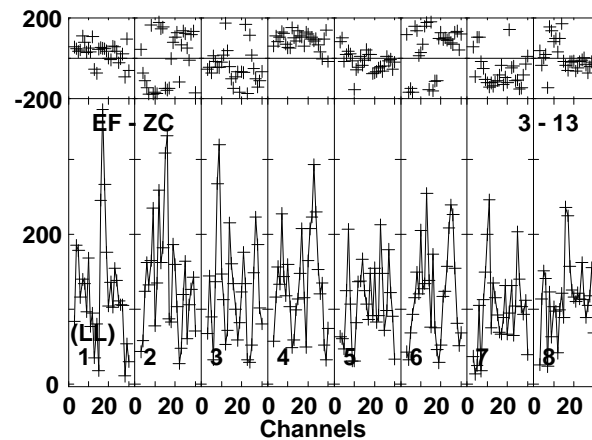
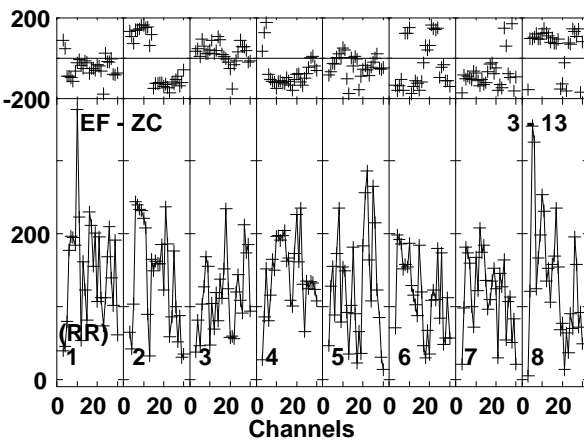
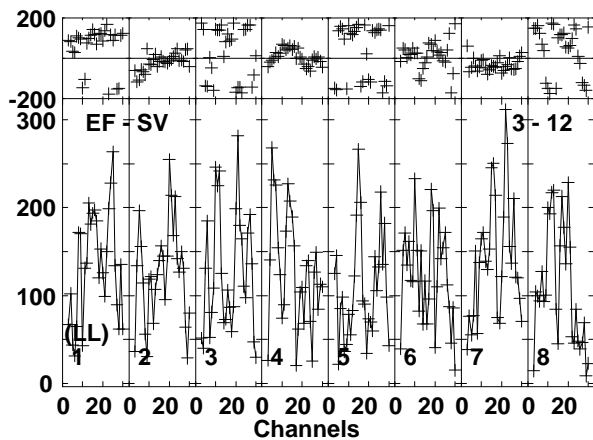
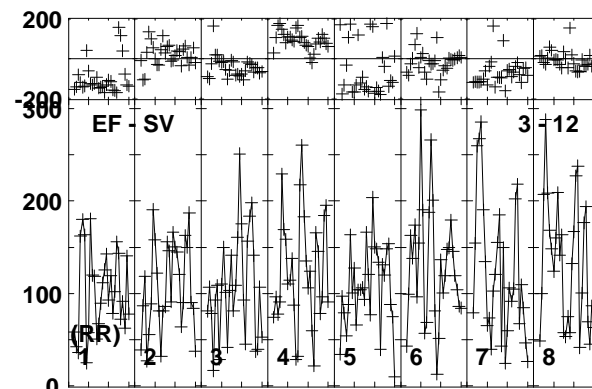
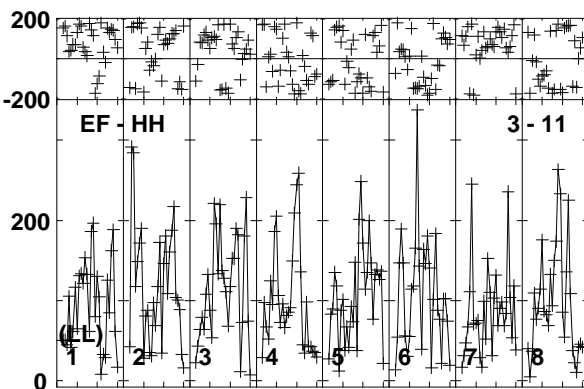
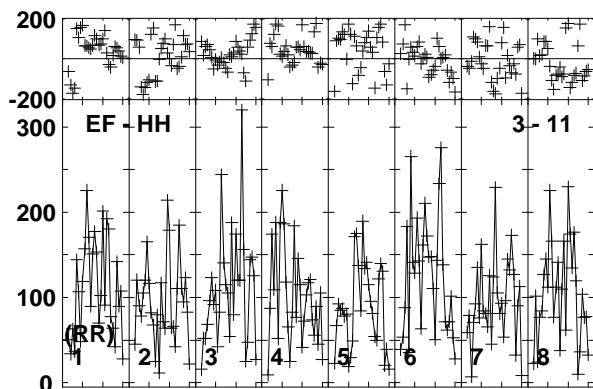
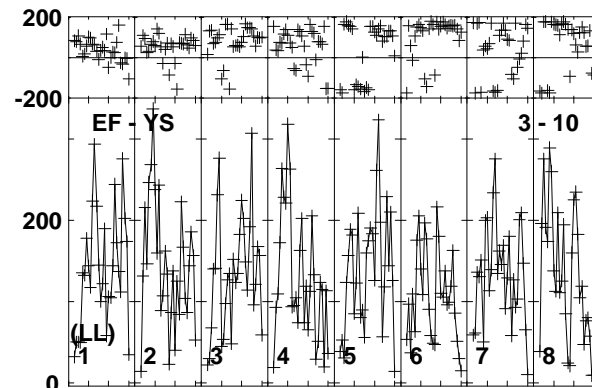
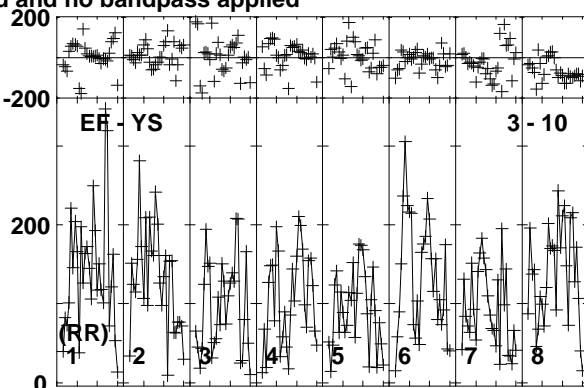
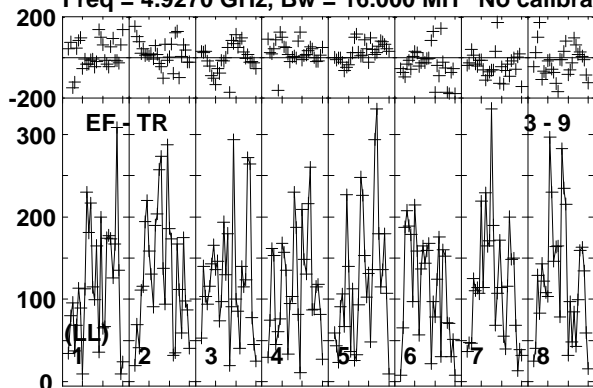

Lower frame: Micro Ampl Jy Top frame: Phas deg  
Vector averaged cross-power spectrum Baseline: EF (03) - TR (09)  
Timerange: 00/11:10:31 to 00/11:13:29

Plot file version 312 created 19-DEC-2018 17:58:33

AT2018\_RY007C.UVDATA.1

Freq = 4.9270 GHz, Bw = 16.000 MH No calibration applied and no bandpass applied

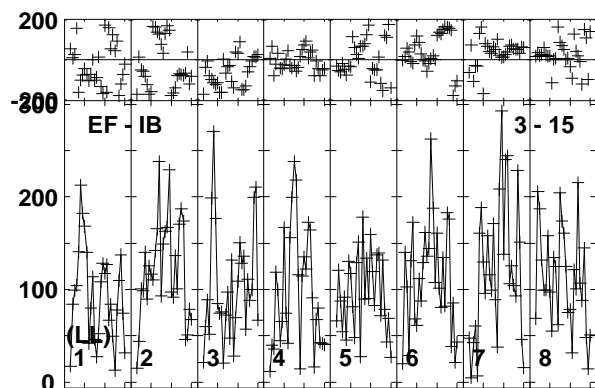
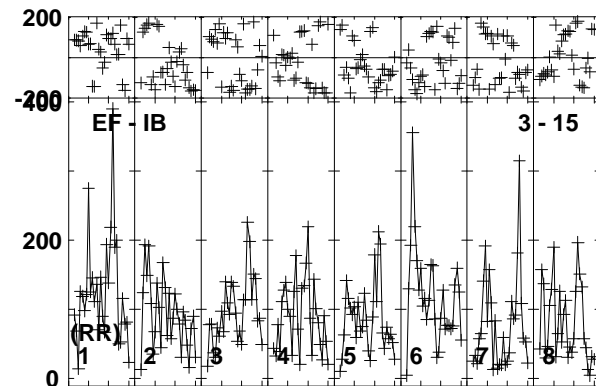
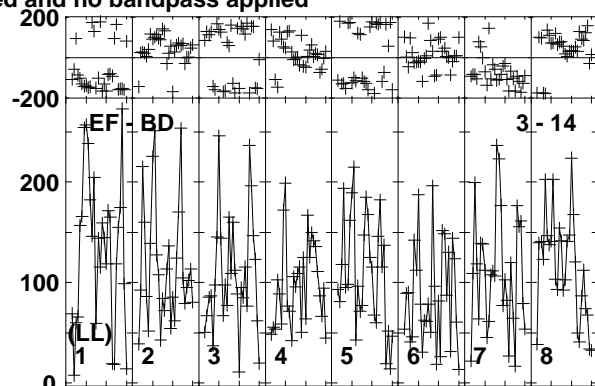
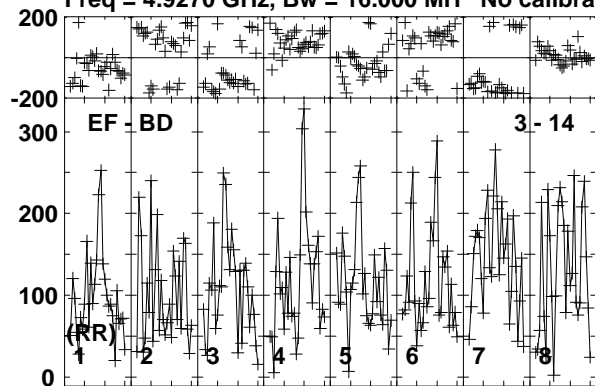

Lower frame: Micro Ampl Jy Top frame: Phas deg  
Vector averaged cross-power spectrum Baseline: EF (03) - BD (14)  
Timerange: 00/11:10:31 to 00/11:13:29

Plot file version 313 created 19-DEC-2018 17:58:33

J1619+2247 RY007C.UVDATA.1

Freq = 4.9270 GHz, Bw = 16.000 MH No calibration applied and no bandpass applied

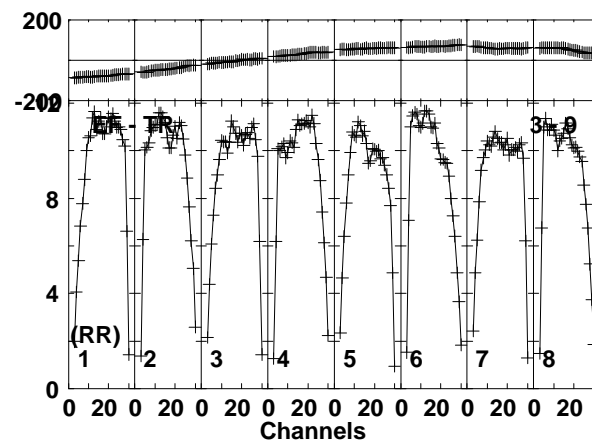
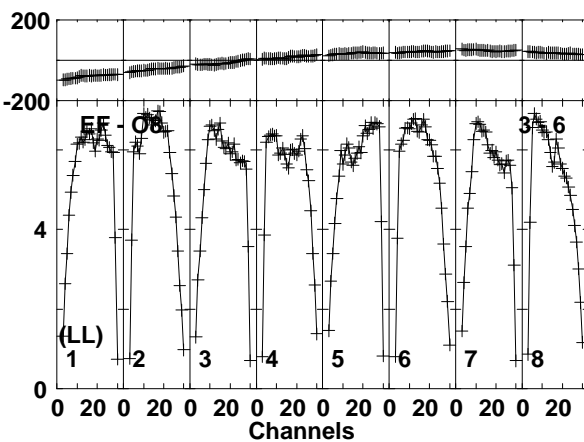
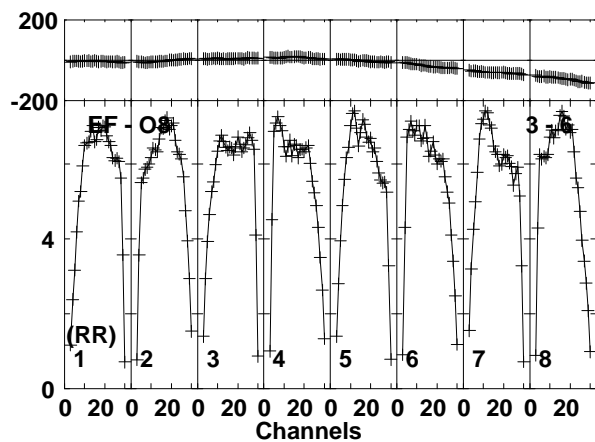
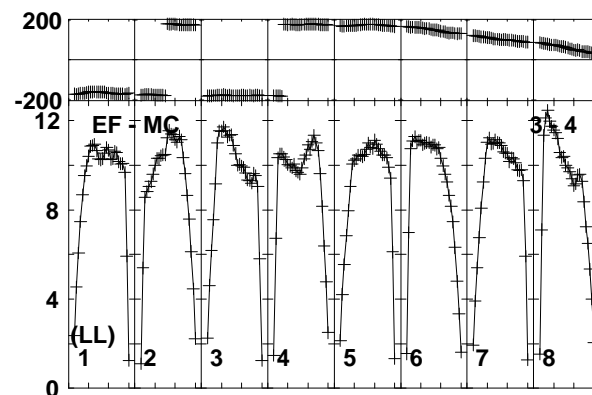
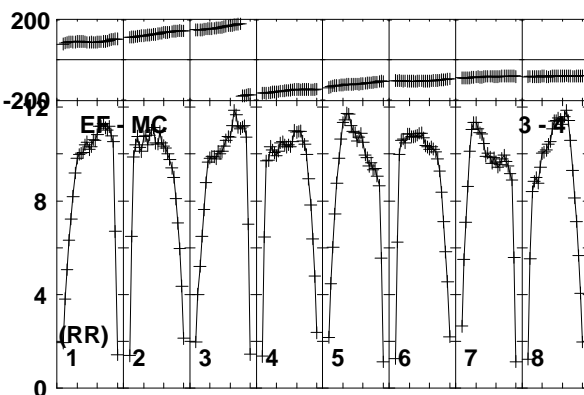
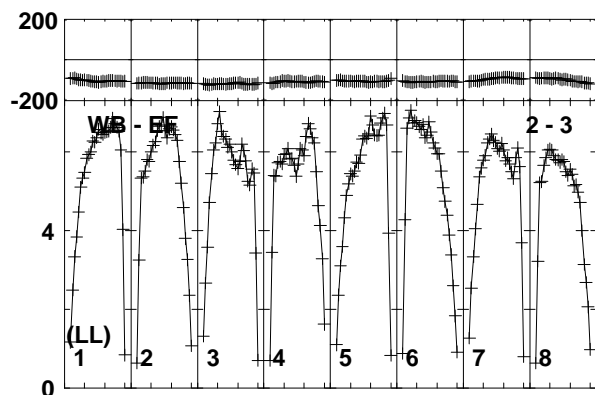
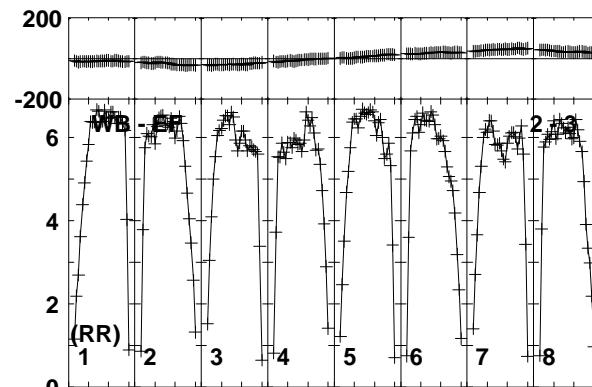
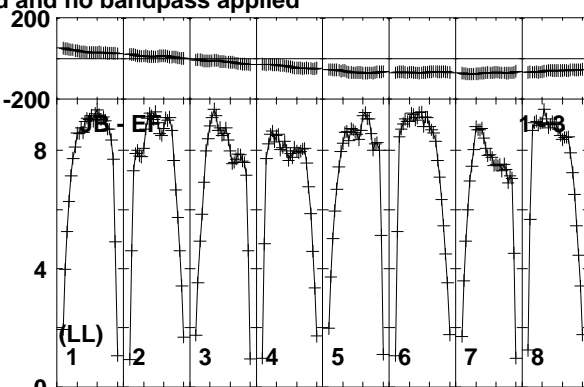
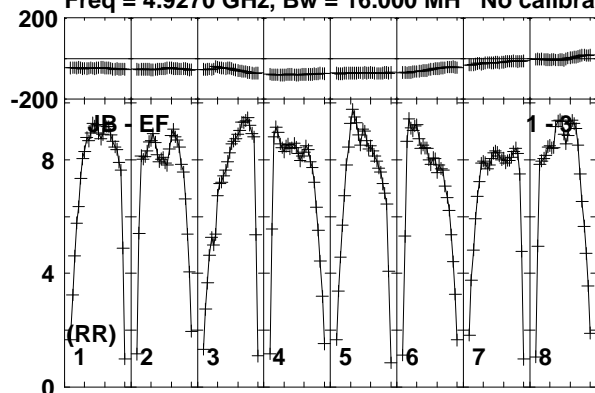

Lower frame: Milli Ampl Jy Top frame: Phas deg  
Vector averaged cross-power spectrum Baseline: JB (01) - EF (03)  
Timerange: 00/11:13:31 to 00/11:14:29

Plot file version 314 created 19-DEC-2018 17:58:33

J1619+2247 RY007C.UVDATA.1

Freq = 4.9270 GHz, Bw = 16.000 MH No calibration applied and no bandpass applied

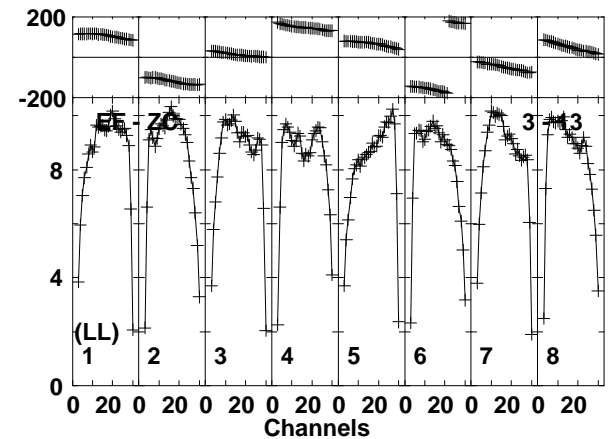
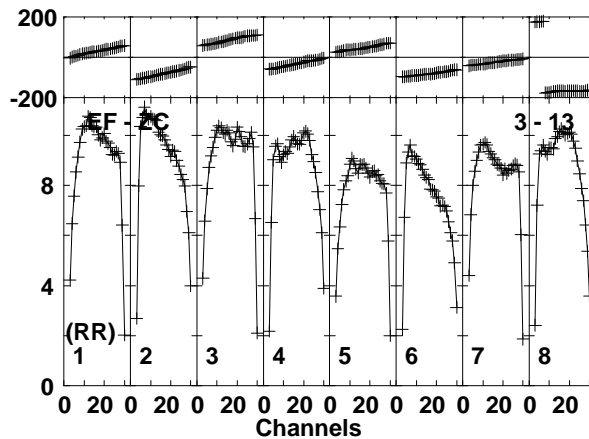
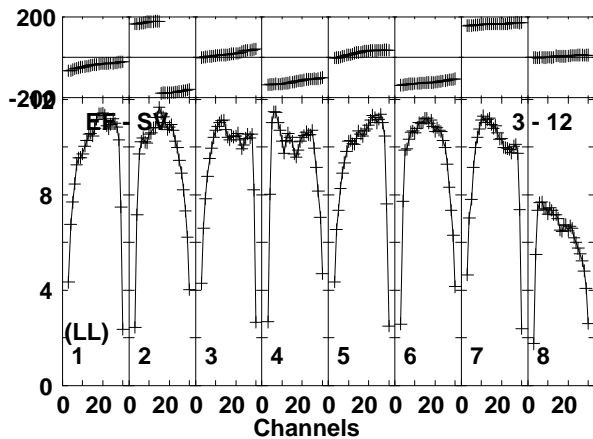
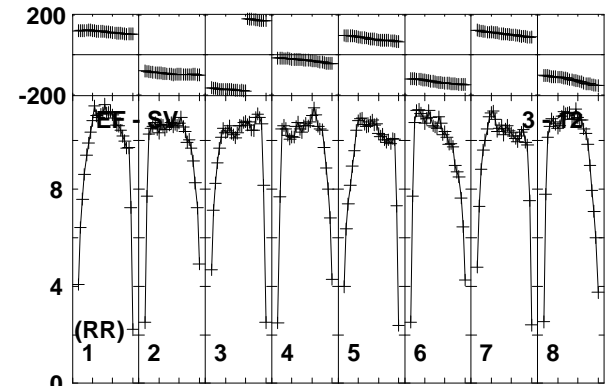
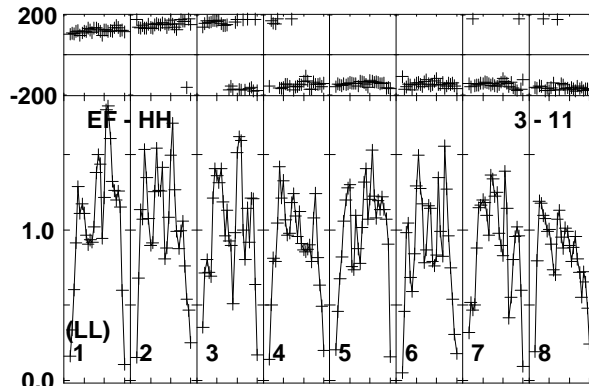
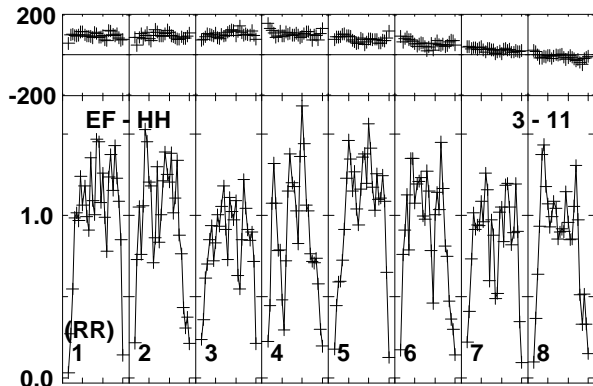
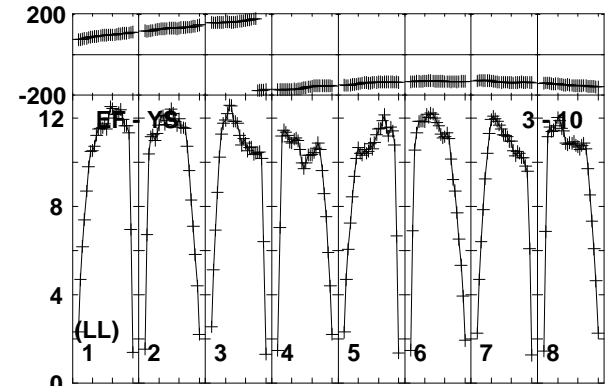
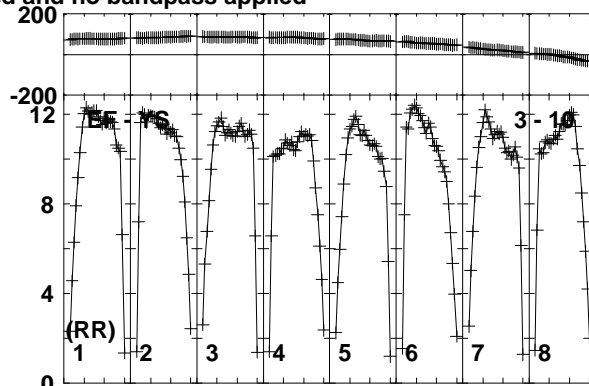
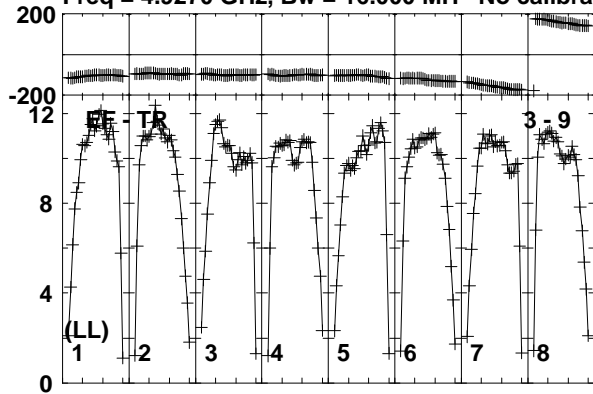

Lower frame: Milli Ampl Jy Top frame: Phas deg  
Vector averaged cross-power spectrum Baseline: EF (03) - TR (09)  
Timerange: 00/11:13:31 to 00/11:14:29



Plot file version 315 created 19-DEC-2018 17:58:33

J1619+2247 RY007C.UVDATA.1

Freq = 4.9270 GHz, Bw = 16.000 MH No calibration applied and no bandpass applied

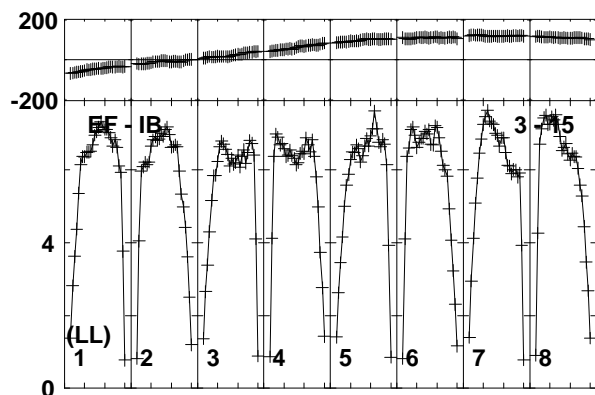
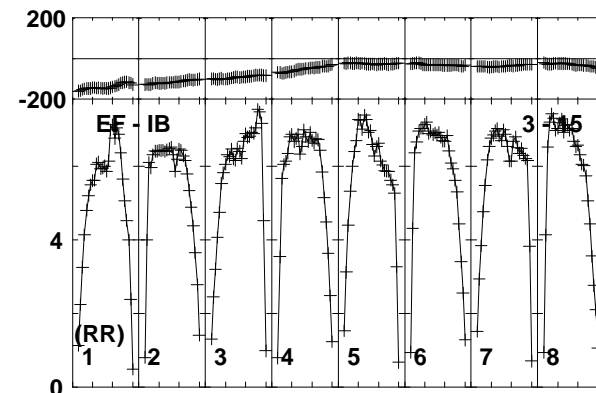
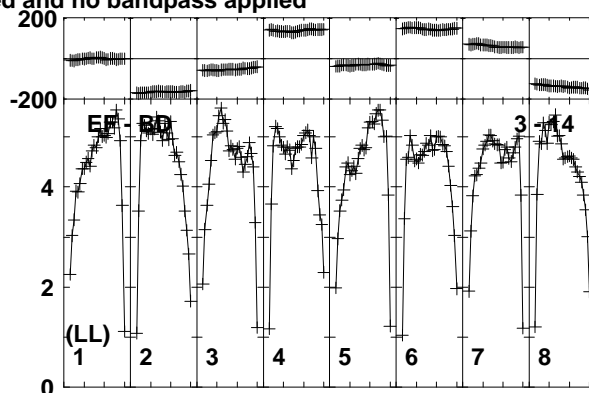
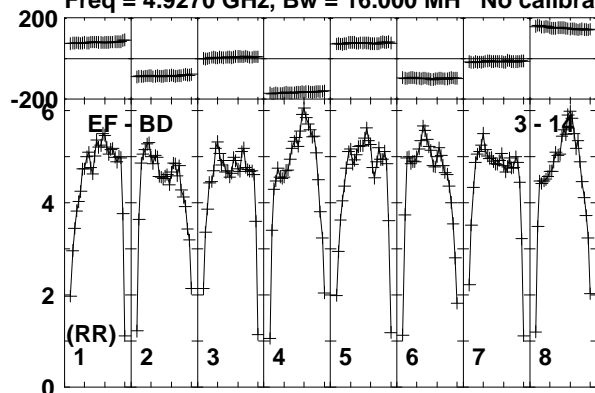

Lower frame: Milli Ampl Jy Top frame: Phas deg  
Vector averaged cross-power spectrum Baseline: EF (03) - BD (14)  
Timerange: 00/11:13:31 to 00/11:14:29

Plot file version 316 created 19-DEC-2018 17:58:33

VLA1 RY007C.UVDATA.1

Freq = 4.9270 GHz, Bw = 16.000 MH No calibration applied and no bandpass applied

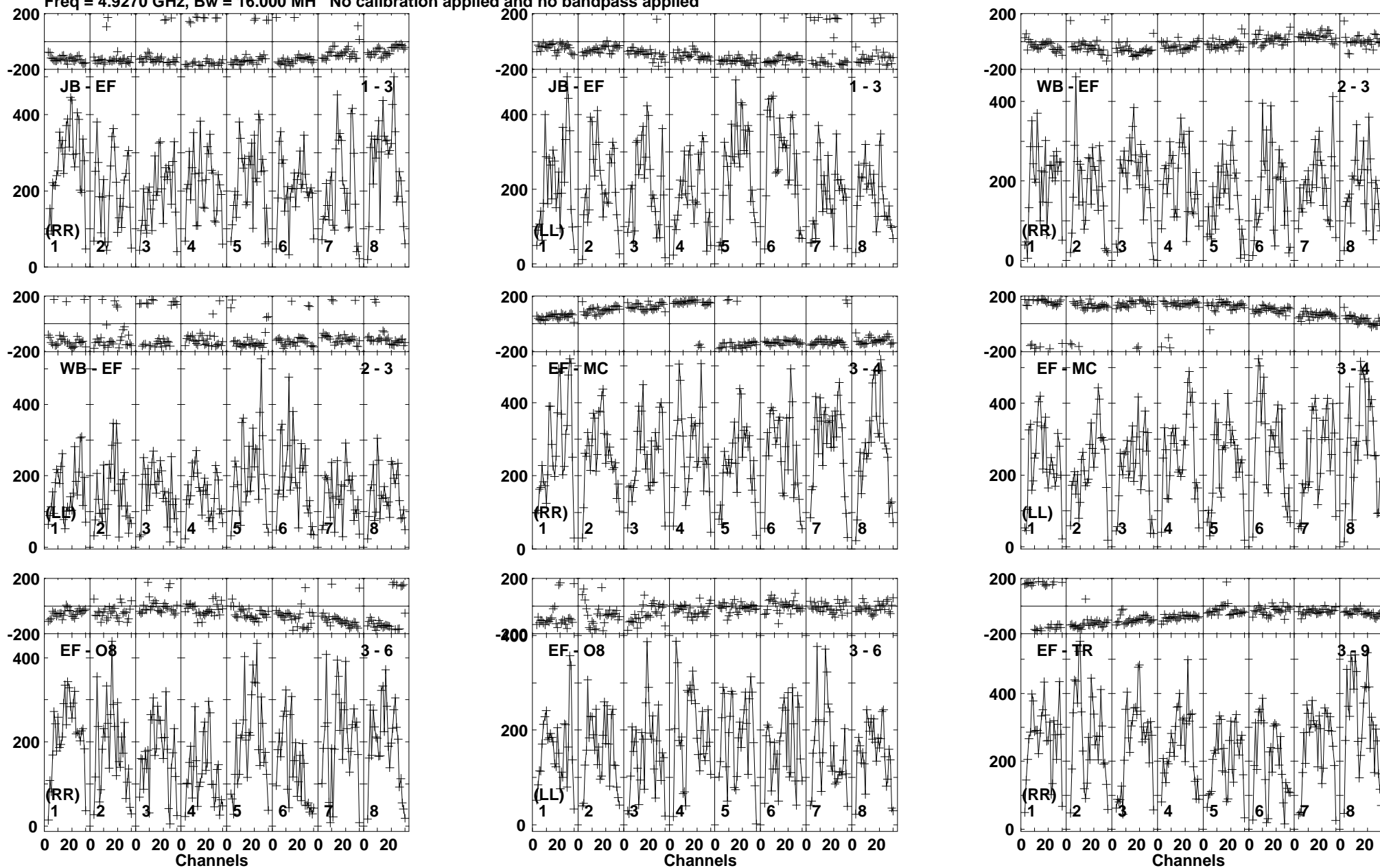

Lower frame: Micro Ampl Jy Top frame: Phas deg  
Vector averaged cross-power spectrum Baseline: JB (01) - EF (03)  
Timerange: 00/11:15:01 to 00/11:16:59

Plot file version 317 created 19-DEC-2018 17:58:33

VLA1 RY007C.UVDATA.1

Freq = 4.9270 GHz, Bw = 16.000 MH No calibration applied and no bandpass applied

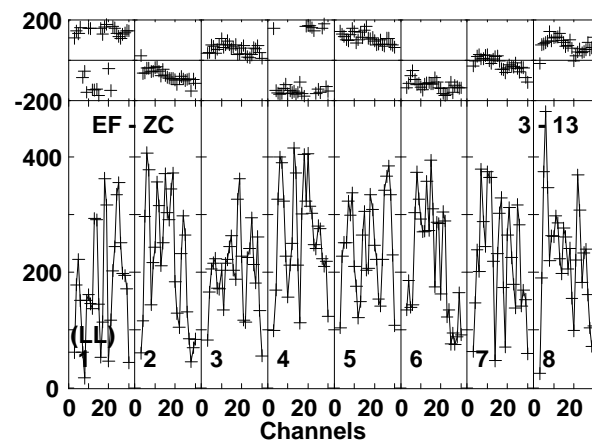
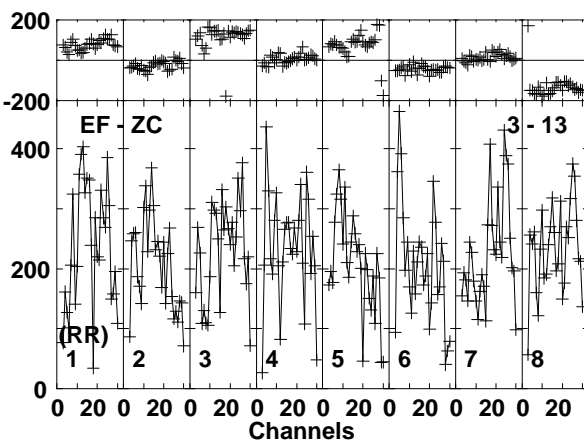
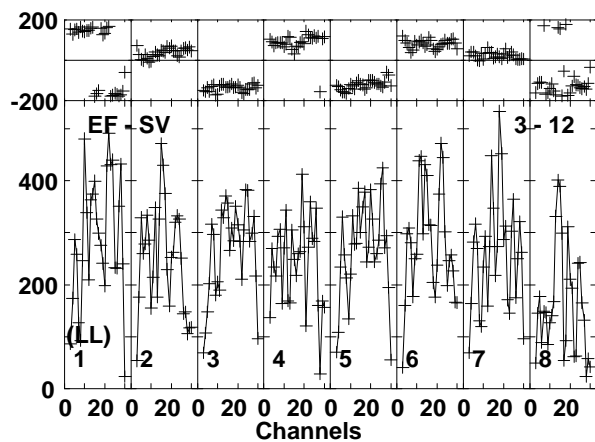
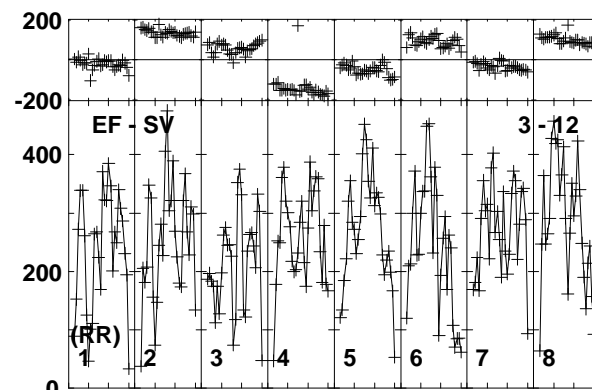
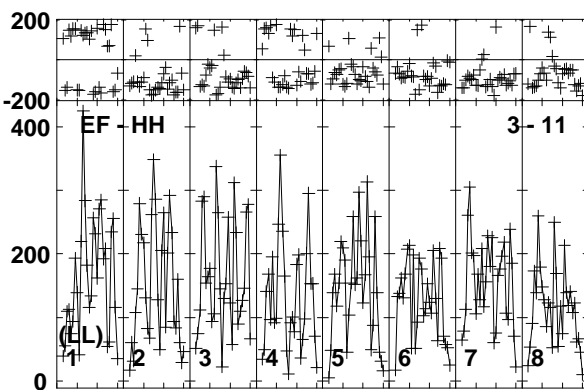
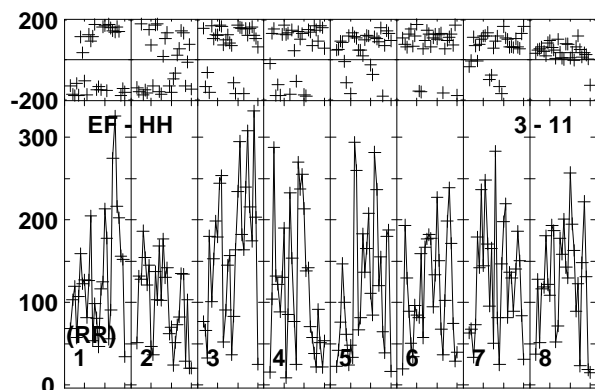
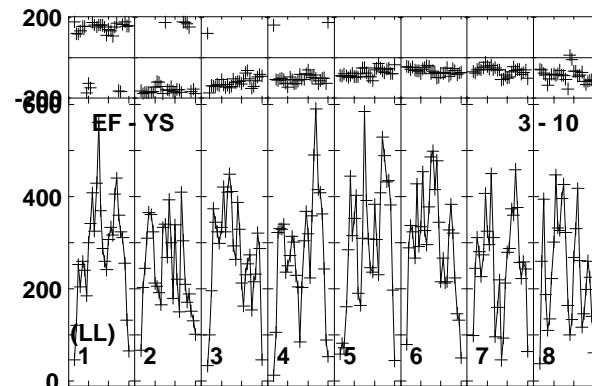
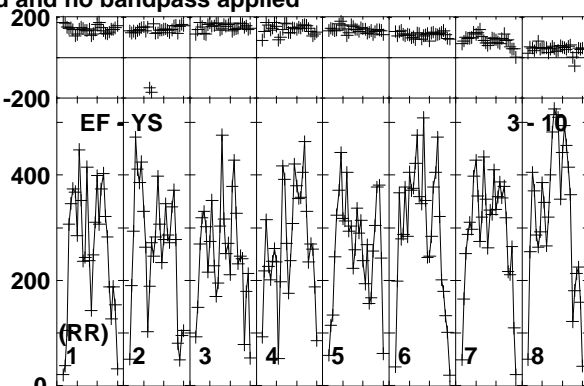
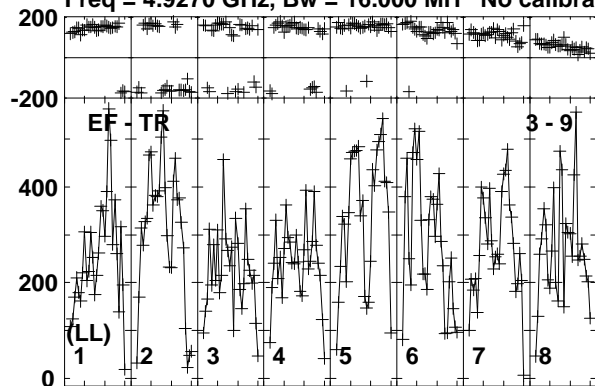

Lower frame: Micro Ampl Jy Top frame: Phas deg  
Vector averaged cross-power spectrum Baseline: EF (03) - TR (09)  
Timerange: 00/11:15:01 to 00/11:16:59

Plot file version 318 created 19-DEC-2018 17:58:33

VLA1 RY007C.UVDATA.1

Freq = 4.9270 GHz, Bw = 16.000 MH No calibration applied and no bandpass applied

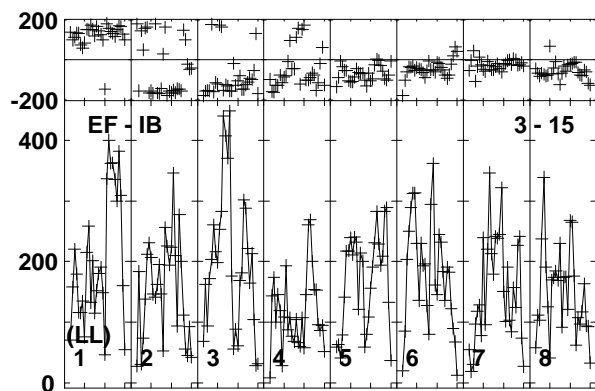
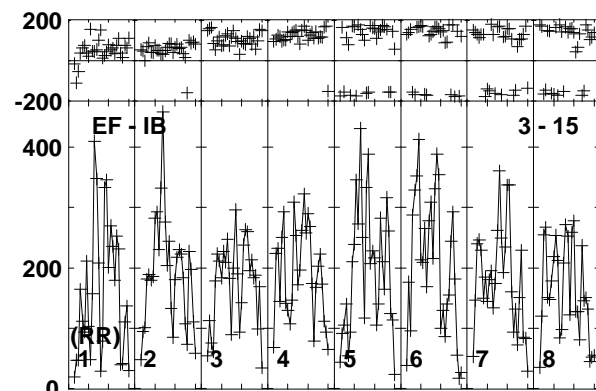
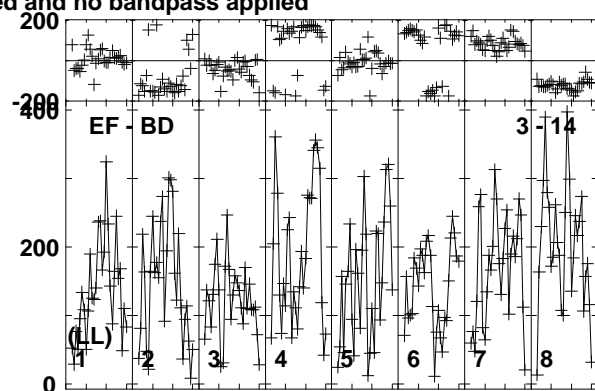
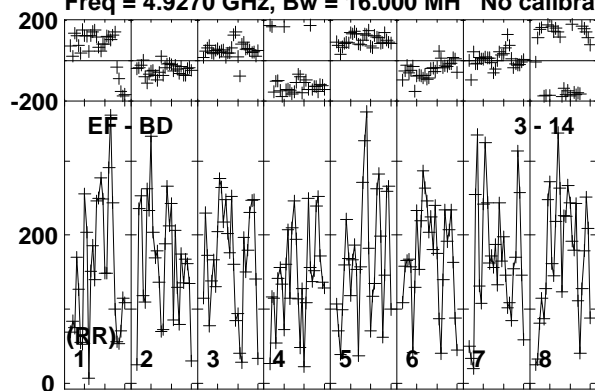

Lower frame: Micro Ampl Jy Top frame: Phas deg  
Vector averaged cross-power spectrum Baseline: EF (03) - BD (14)  
Timerange: 00/11:15:01 to 00/11:16:59

Plot file version 319 created 19-DEC-2018 17:58:33

J1619+2247 RY007C.UVDATA.1

Freq = 4.9270 GHz, Bw = 16.000 MH No calibration applied and no bandpass applied

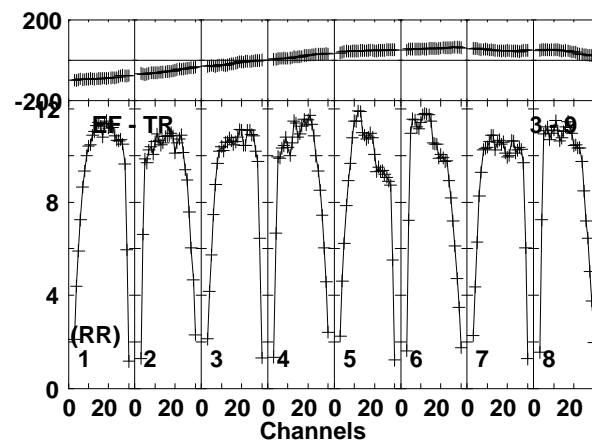
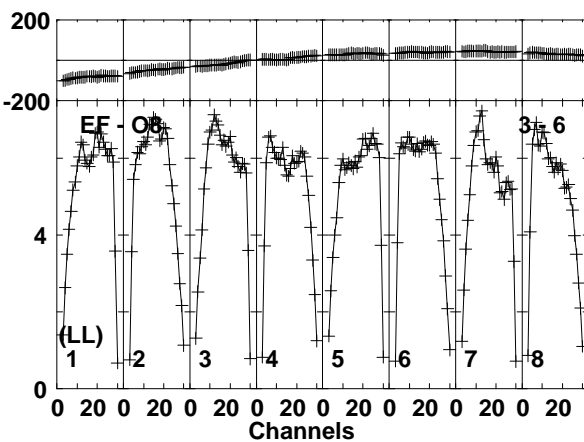
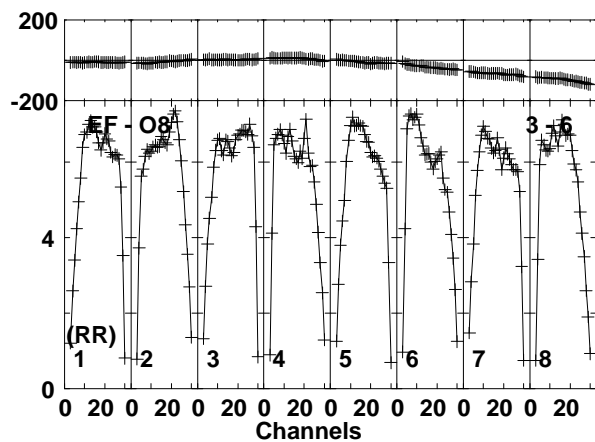
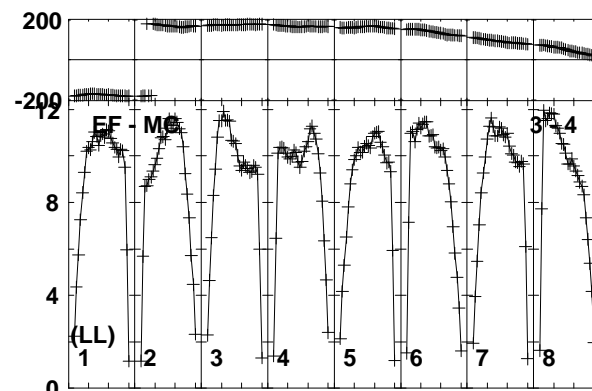
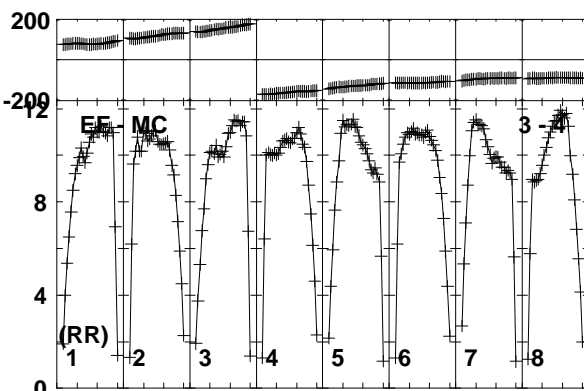
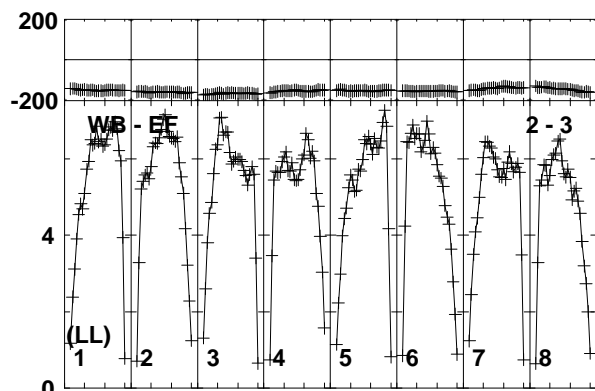
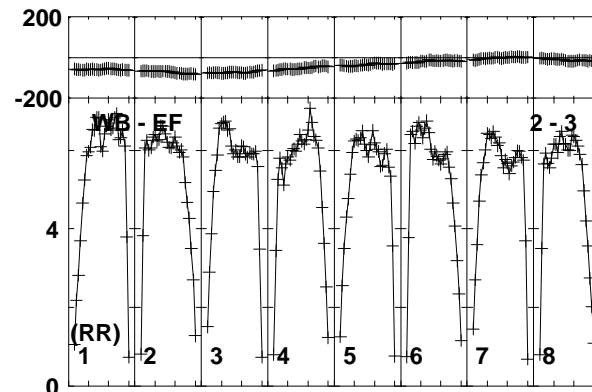
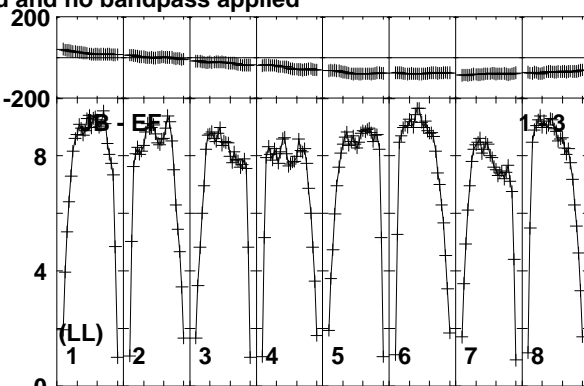
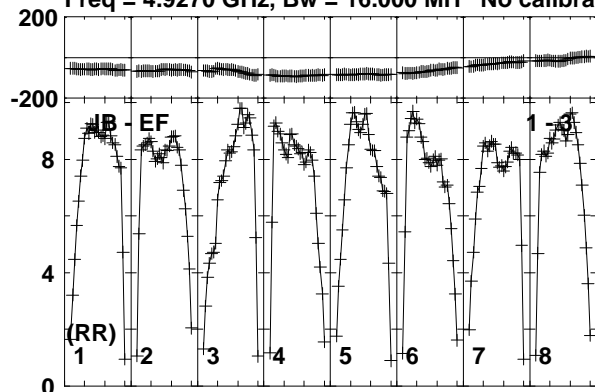

Lower frame: Milli Ampl Jy Top frame: Phas deg  
Vector averaged cross-power spectrum Baseline: JB (01) - EF (03)  
Timerange: 00/11:17:01 to 00/11:17:59

Plot file version 320 created 19-DEC-2018 17:58:33

J1619+2247 RY007C.UVDATA.1

Freq = 4.9270 GHz, Bw = 16.000 MH No calibration applied and no bandpass applied

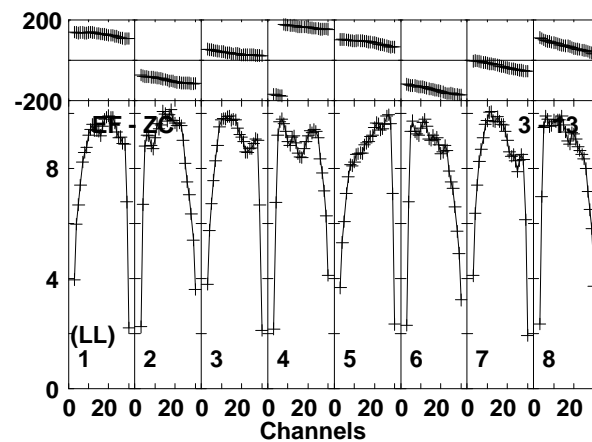
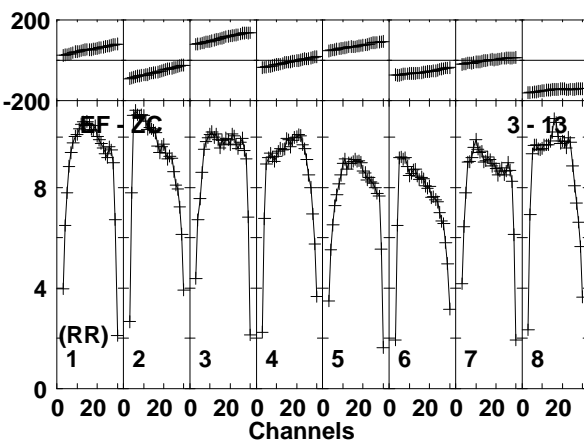
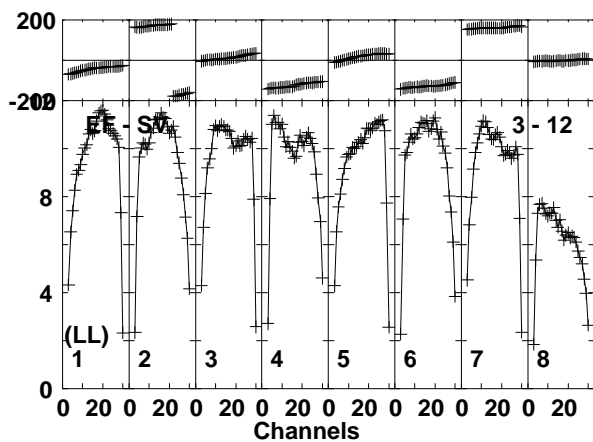
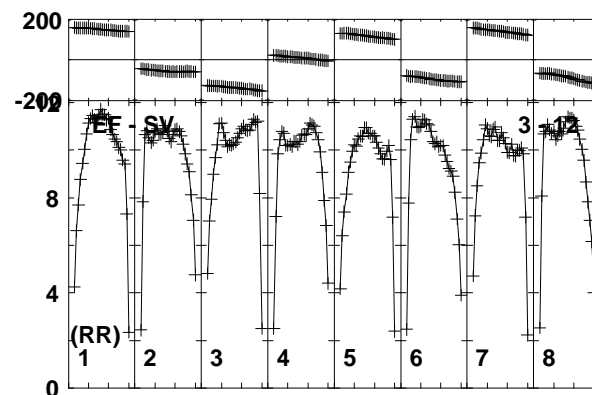
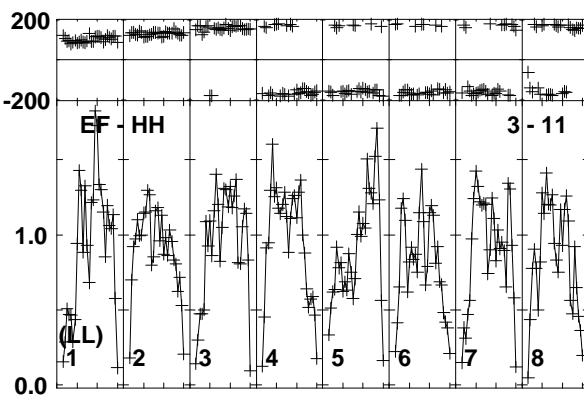
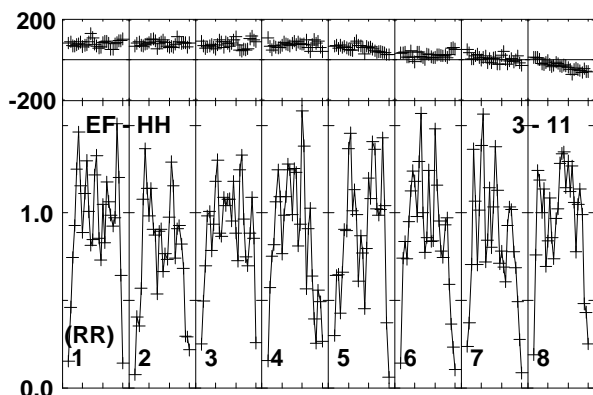
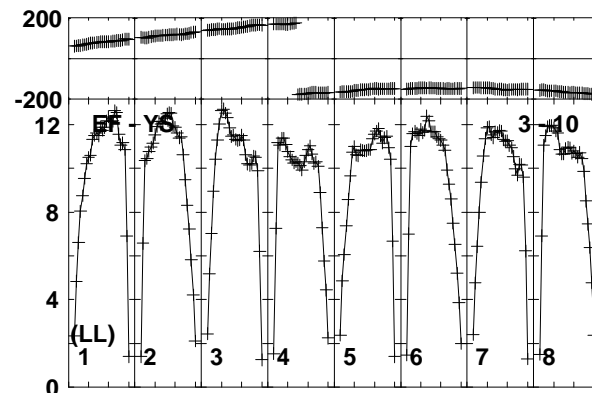
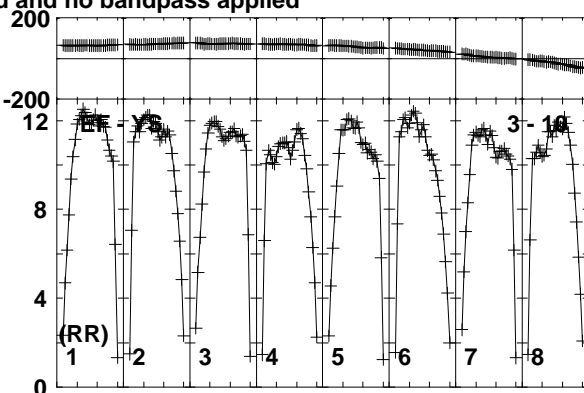
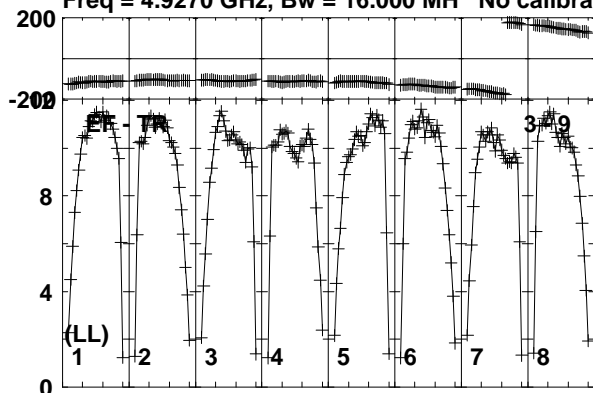

Lower frame: Milli Ampl Jy Top frame: Phas deg  
Vector averaged cross-power spectrum Baseline: EF (03) - TR (09)  
Timerange: 00/11:17:01 to 00/11:17:59

Plot file version 321 created 19-DEC-2018 17:58:34

J1619+2247 RY007C.UVDATA.1

Freq = 4.9270 GHz, Bw = 16.000 MH No calibration applied and no bandpass applied

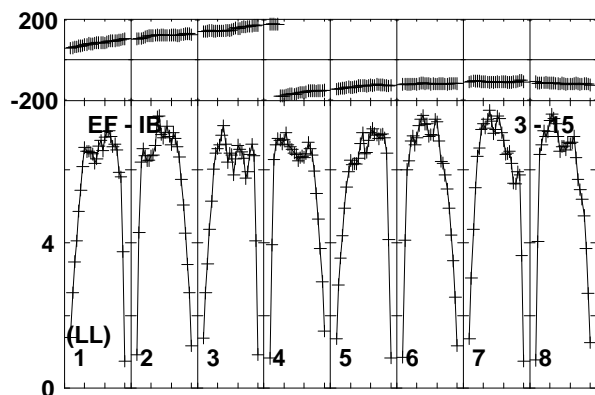
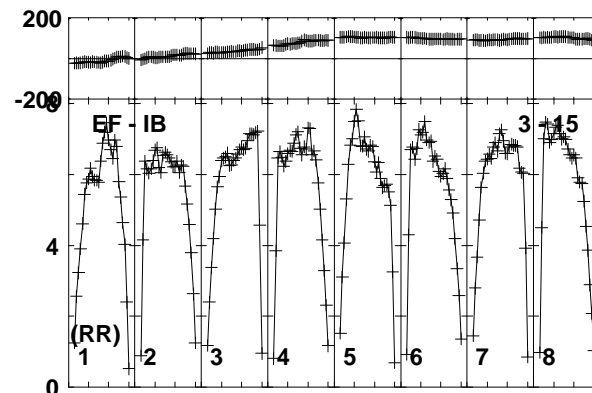
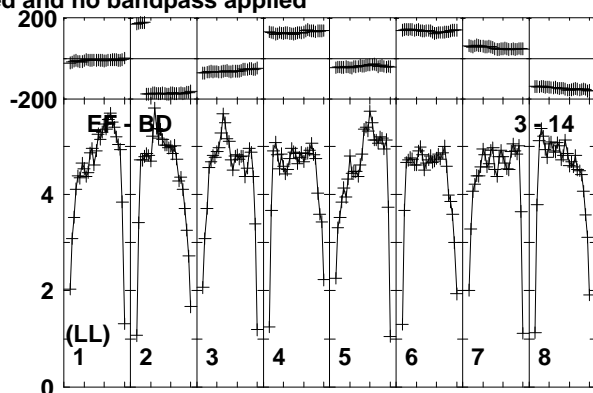
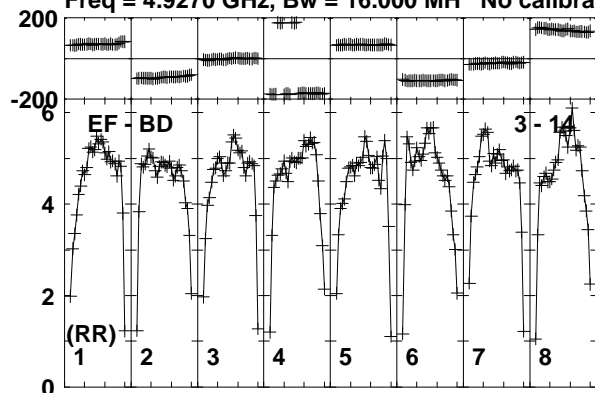

Lower frame: Milli Ampl Jy Top frame: Phas deg  
Vector averaged cross-power spectrum Baseline: EF (03) - BD (14)  
Timerange: 00/11:17:01 to 00/11:17:59

Plot file version 322 created 19-DEC-2018 17:58:34

AT2018\_RY007C.UVDATA.1

Freq = 4.9270 GHz, Bw = 16.000 MH No calibration applied and no bandpass applied

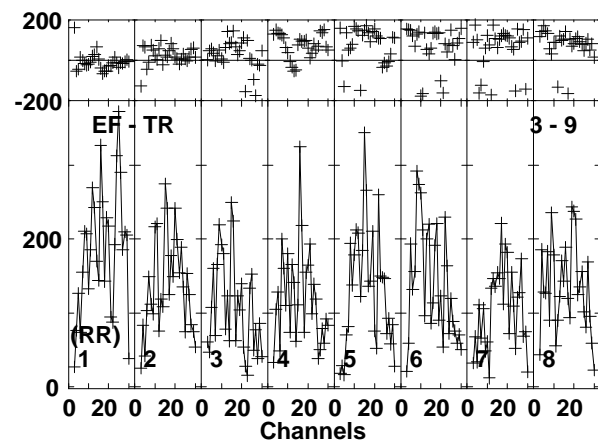
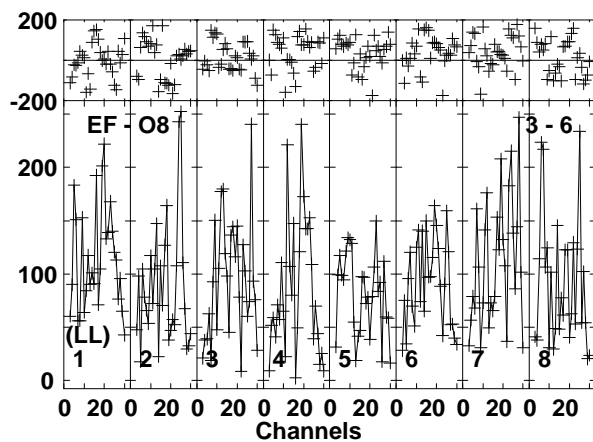
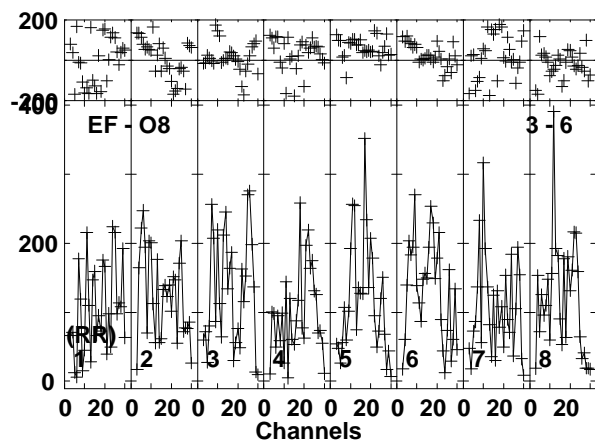
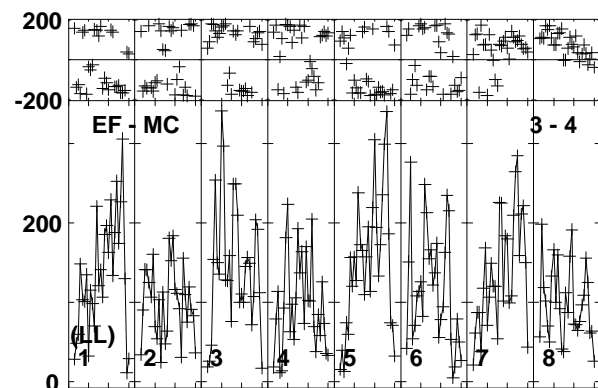
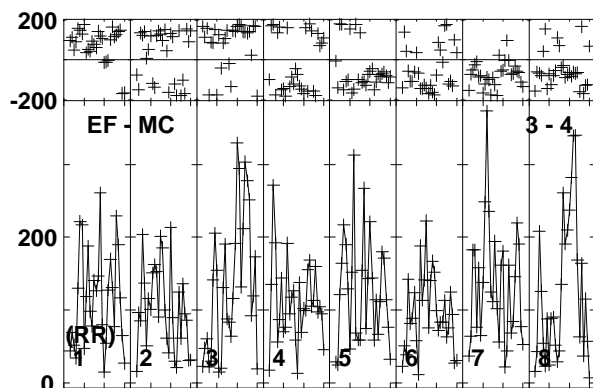
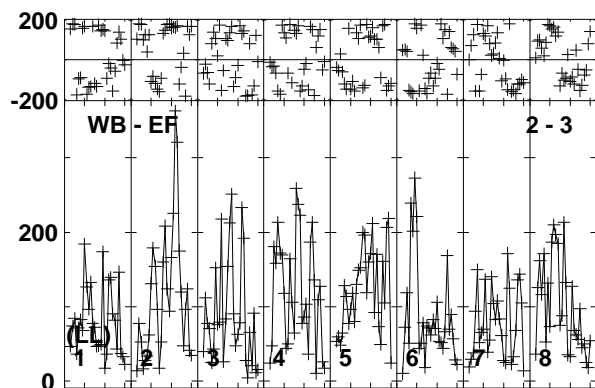
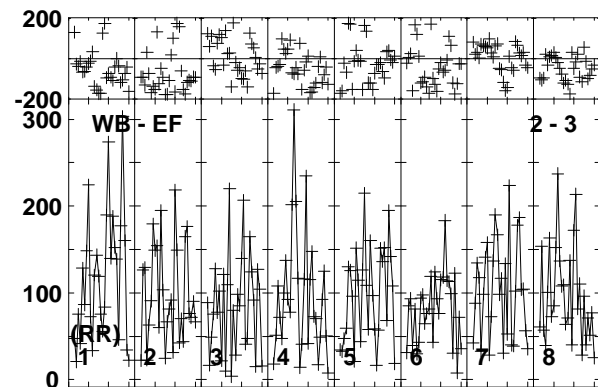
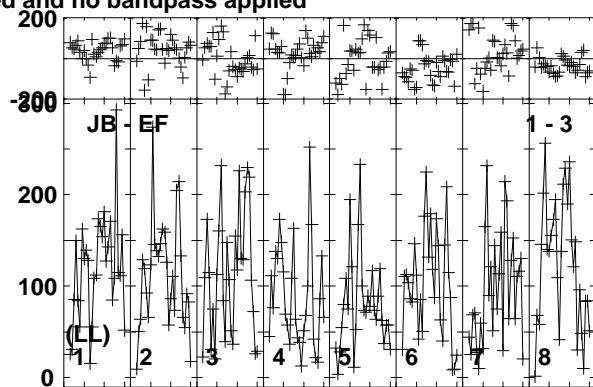
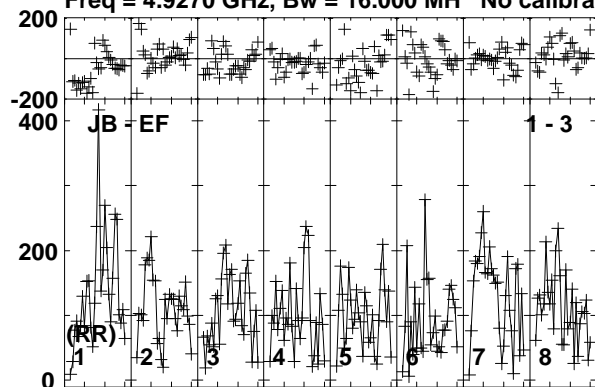

Lower frame: Micro Ampl Jy Top frame: Phas deg  
Vector averaged cross-power spectrum Baseline: JB (01) - EF (03)  
Timerange: 00/11:18:01 to 00/11:20:59



Plot file version 323 created 19-DEC-2018 17:58:34  
AT2018\_RY007C.UVDATA.1

Freq = 4.9270 GHz, Bw = 16.000 MH No calibration applied and no bandpass applied

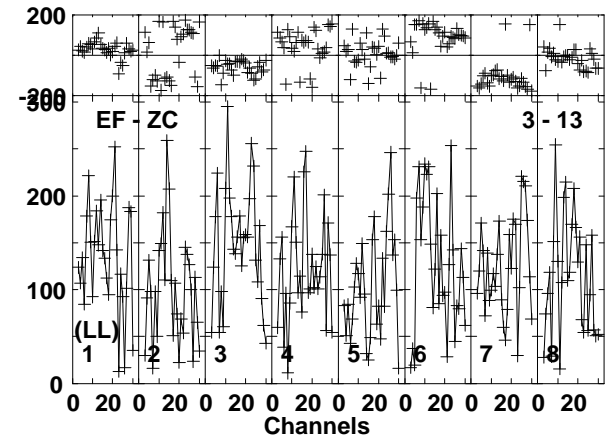
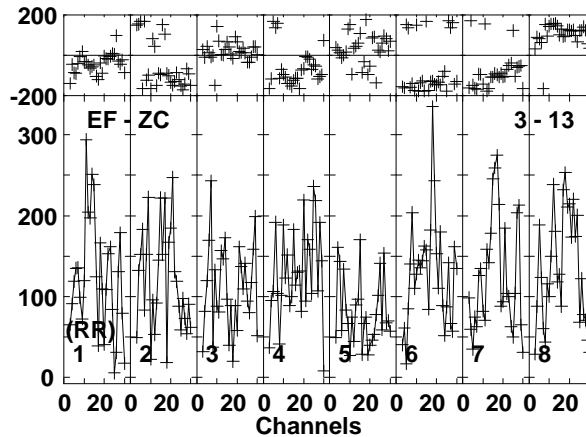
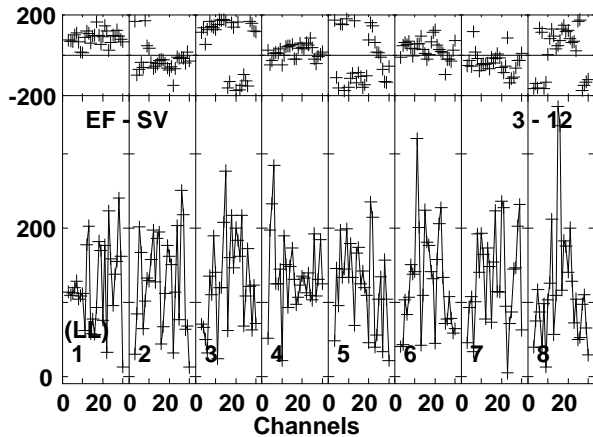
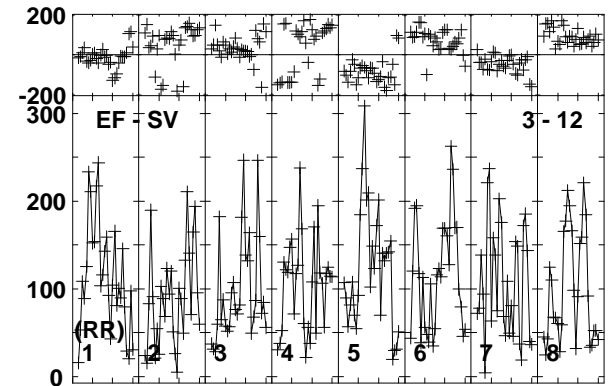
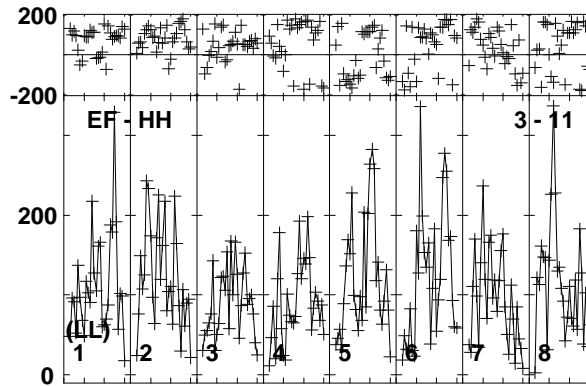
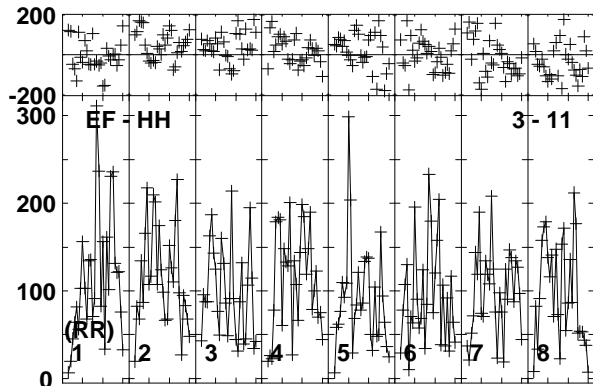
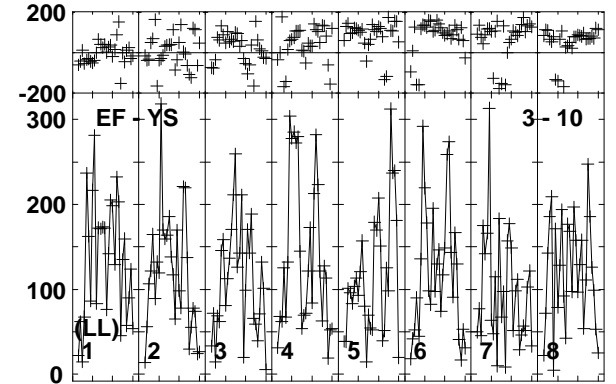
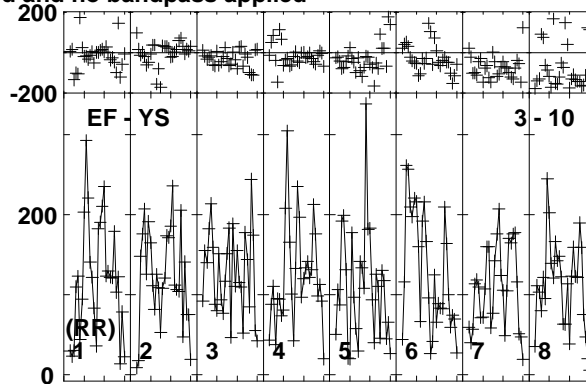
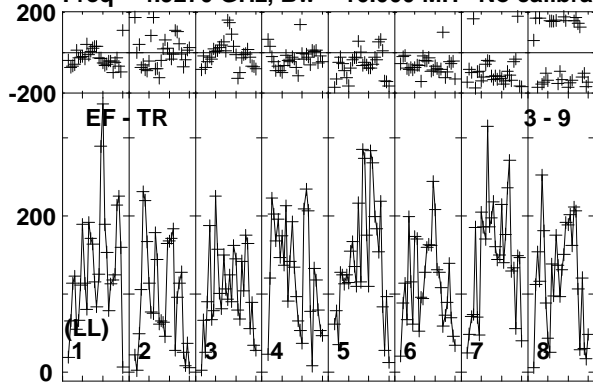

Lower frame: Micro Ampl Jy Top frame: Phas deg  
Vector averaged cross-power spectrum Baseline: EF (03) - TR (09)  
Timerange: 00/11:18:01 to 00/11:20:59

Plot file version 324 created 19-DEC-2018 17:58:34  
AT2018\_RY007C.UVDATA.1

Freq = 4.9270 GHz, Bw = 16.000 MH No calibration applied and no bandpass applied

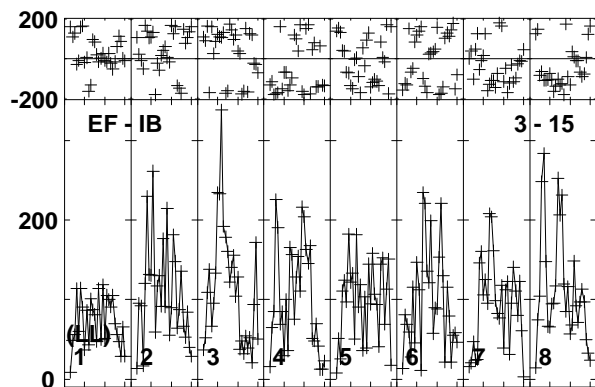
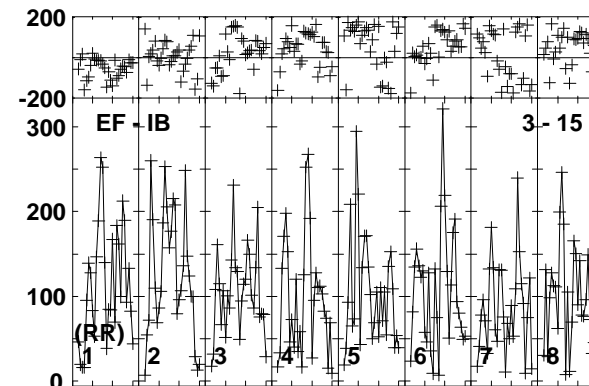
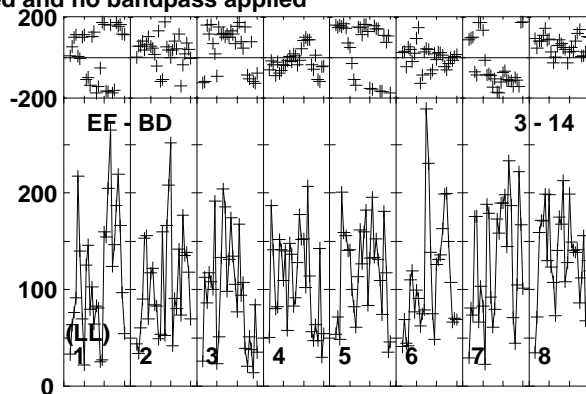
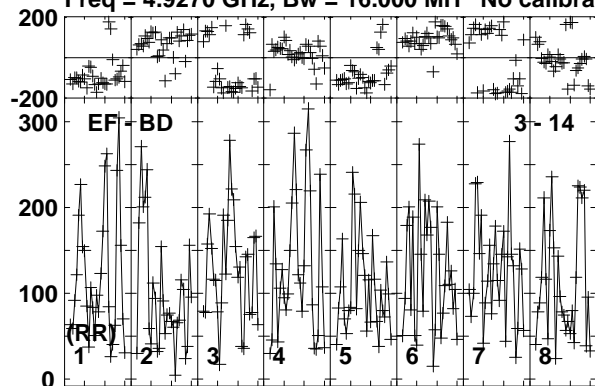

Lower frame: Micro Ampl Jy Top frame: Phas deg  
Vector averaged cross-power spectrum Baseline: EF (03) - BD (14)  
Timerange: 00/11:18:01 to 00/11:20:59

Plot file version 325 created 19-DEC-2018 17:58:34

J1619+2247 RY007C.UVDATA.1

Freq = 4.9270 GHz, Bw = 16.000 MH No calibration applied and no bandpass applied

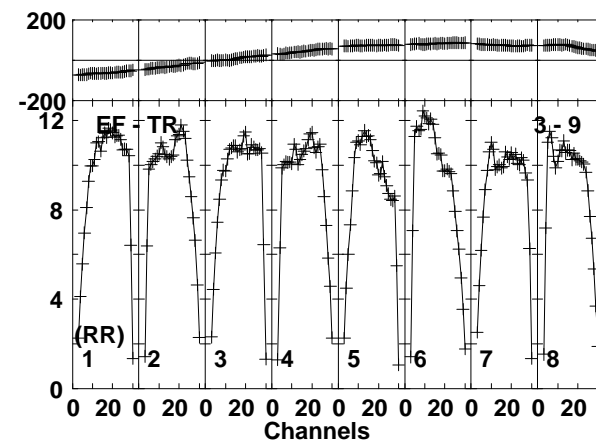
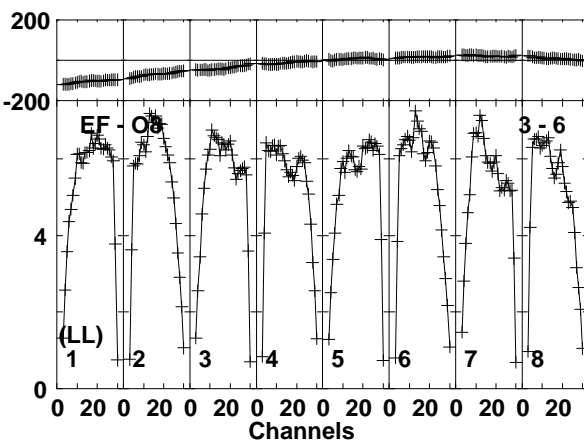
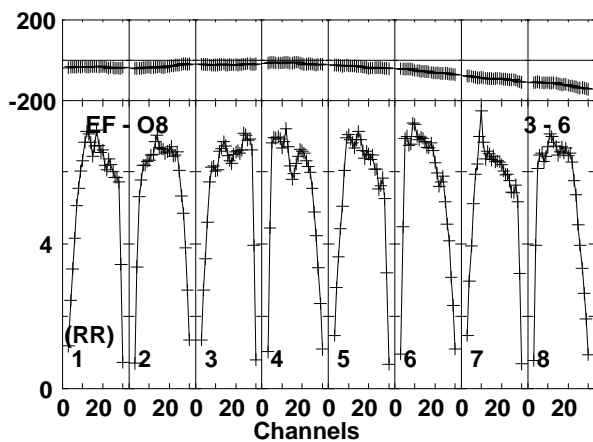
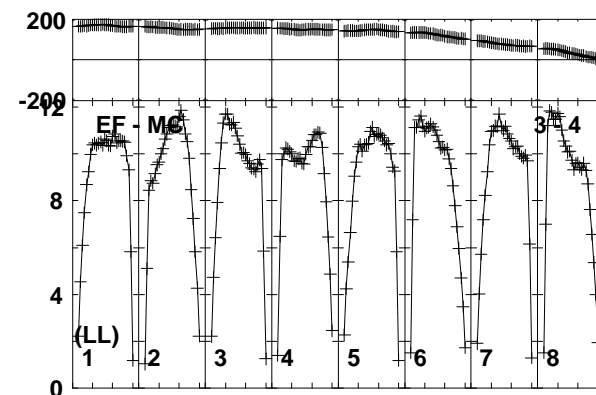
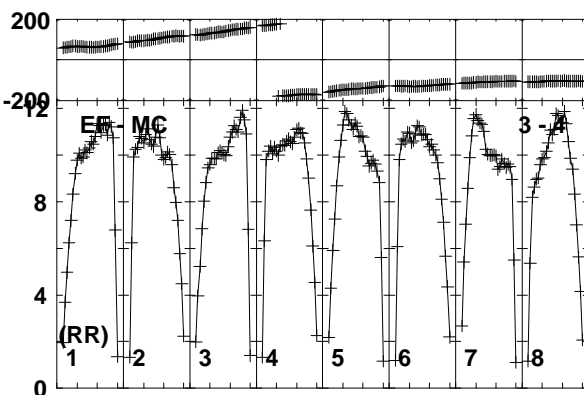
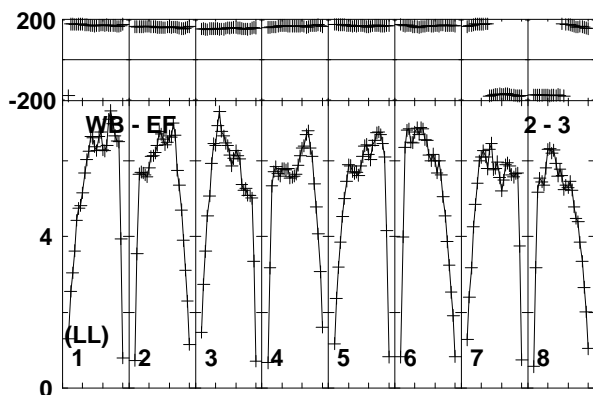
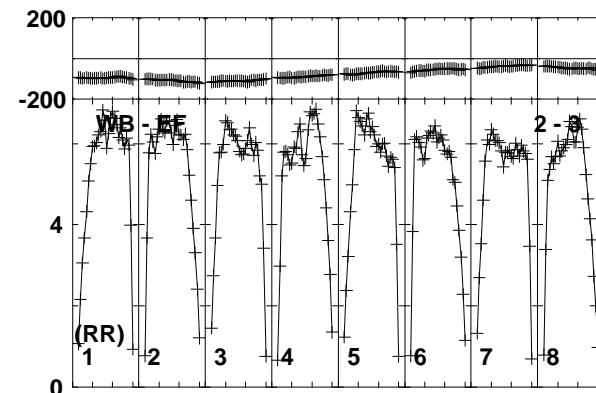
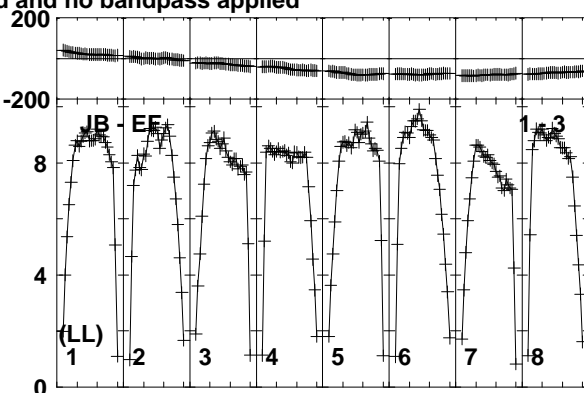
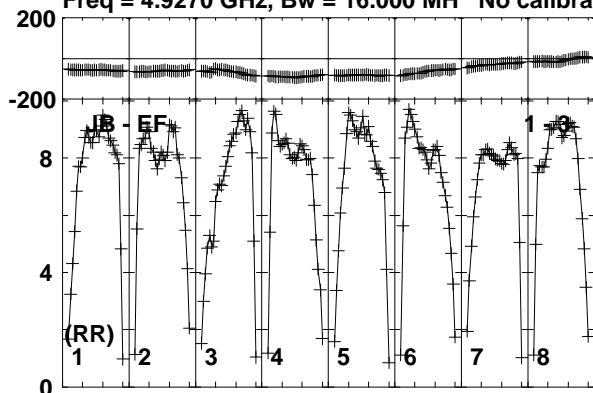

Lower frame: Milli Ampl Jy Top frame: Phas deg  
Vector averaged cross-power spectrum Baseline: JB (01) - EF (03)  
Timerange: 00/11:21:01 to 00/11:21:59

Plot file version 326 created 19-DEC-2018 17:58:34

J1619+2247 RY007C.UVDATA.1

Freq = 4.9270 GHz, Bw = 16.000 MH No calibration applied and no bandpass applied

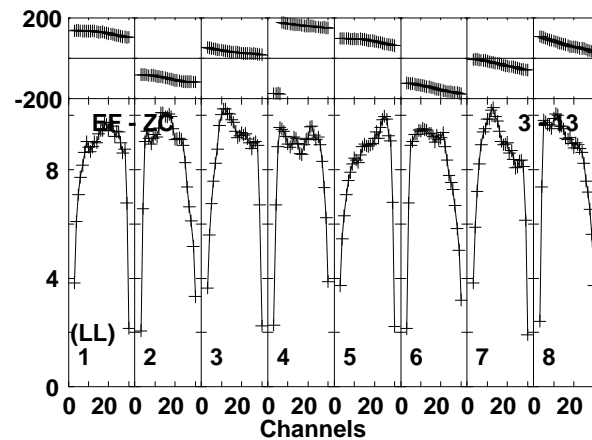
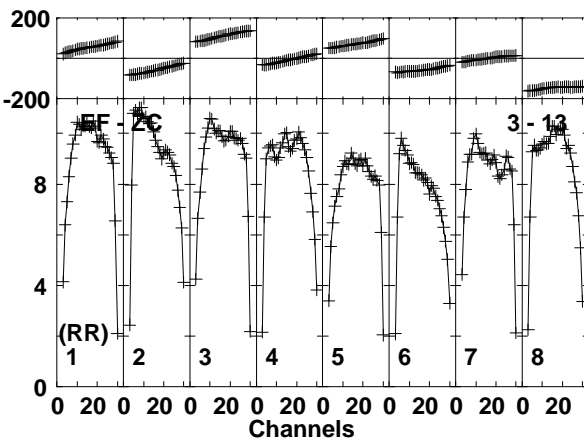
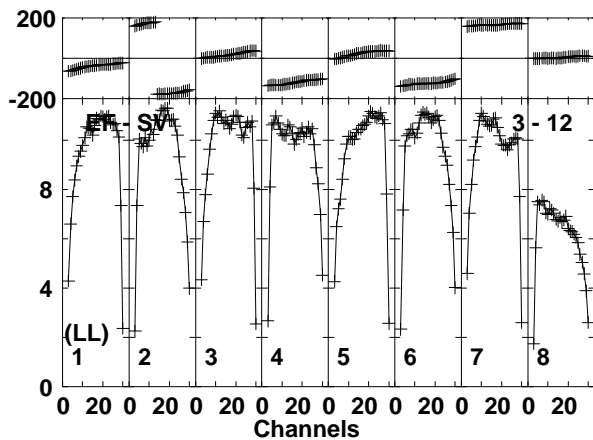
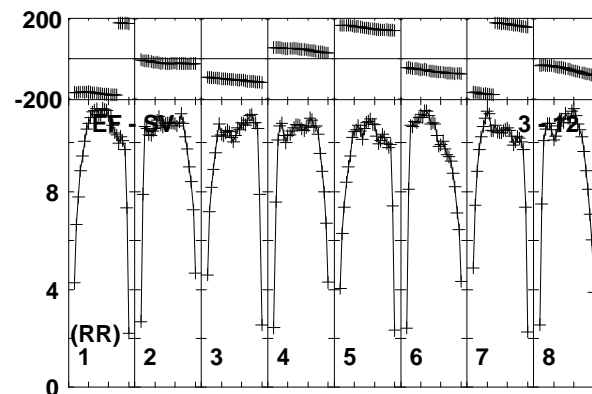
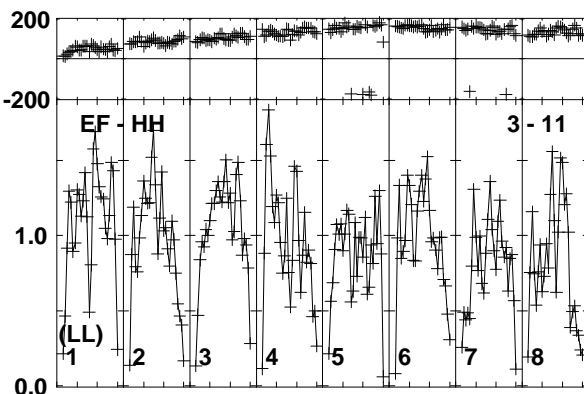
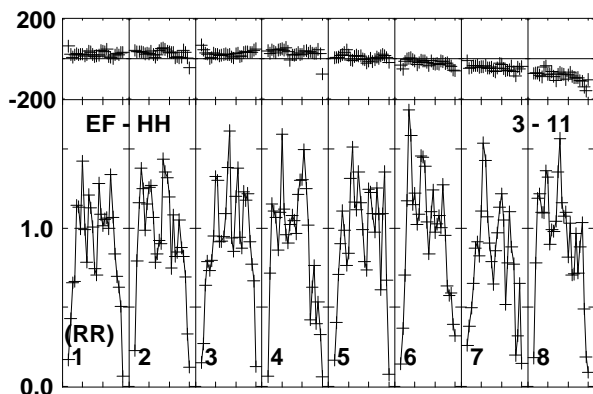
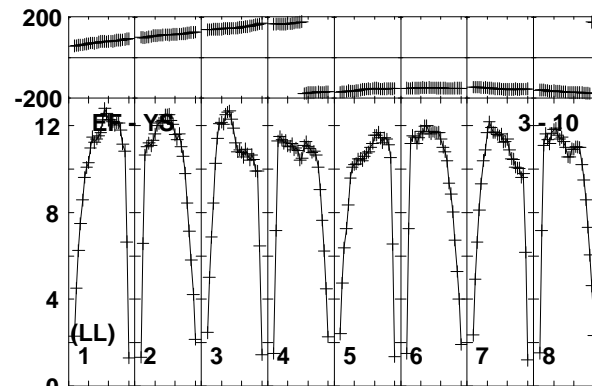
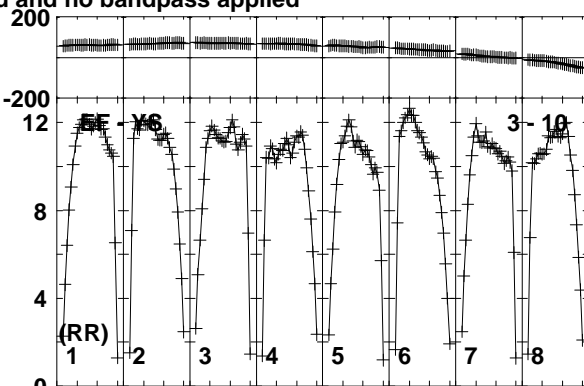
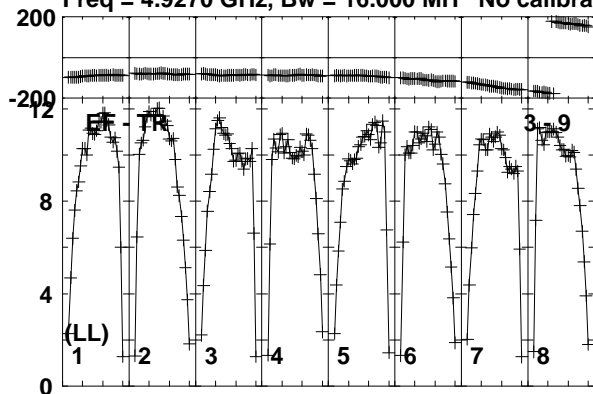

Lower frame: Milli Ampl Jy Top frame: Phas deg  
Vector averaged cross-power spectrum Baseline: EF (03) - TR (09)  
Timerange: 00/11:21:01 to 00/11:21:59

Plot file version 327 created 19-DEC-2018 17:58:34  
J1619+2247 RY007C.UVDATA.1

Freq = 4.9270 GHz, Bw = 16.000 MH No calibration applied and no bandpass applied

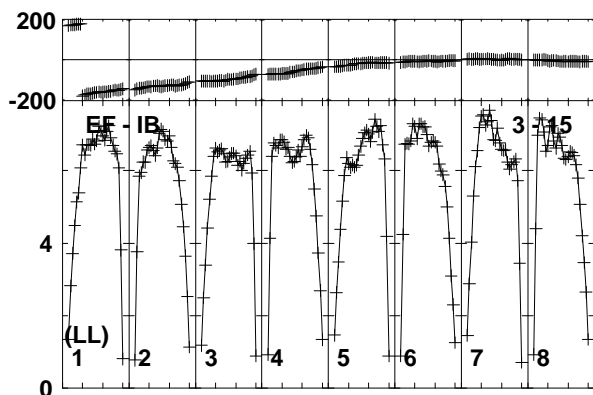
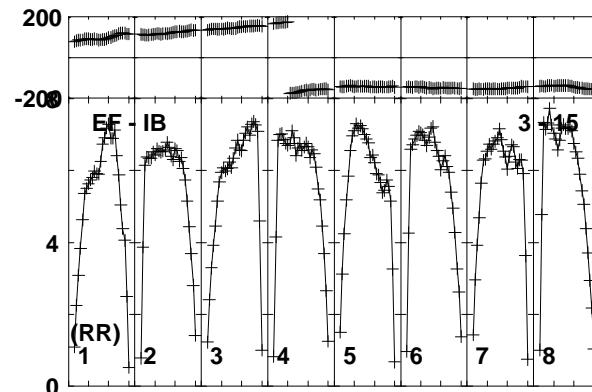
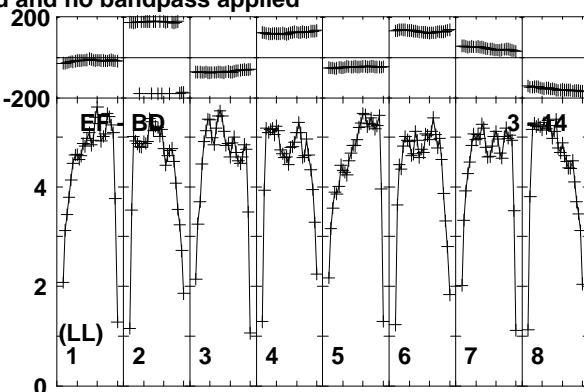
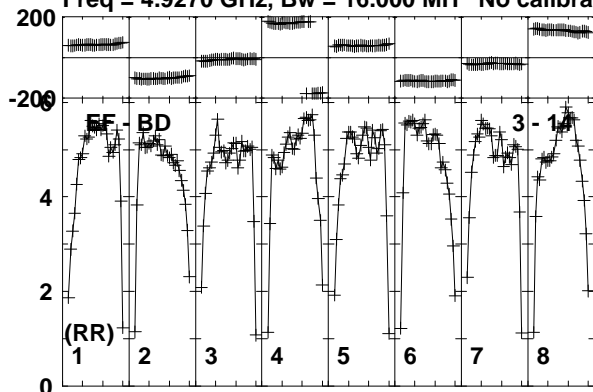

Lower frame: Milli Ampl Jy Top frame: Phas deg  
Vector averaged cross-power spectrum Baseline: EF (03) - BD (14)  
Timerange: 00/11:21:01 to 00/11:21:59

Plot file version 328 created 19-DEC-2018 17:58:34

AT2018\_RY007C.UVDATA.1

Freq = 4.9270 GHz, Bw = 16.000 MH No calibration applied and no bandpass applied

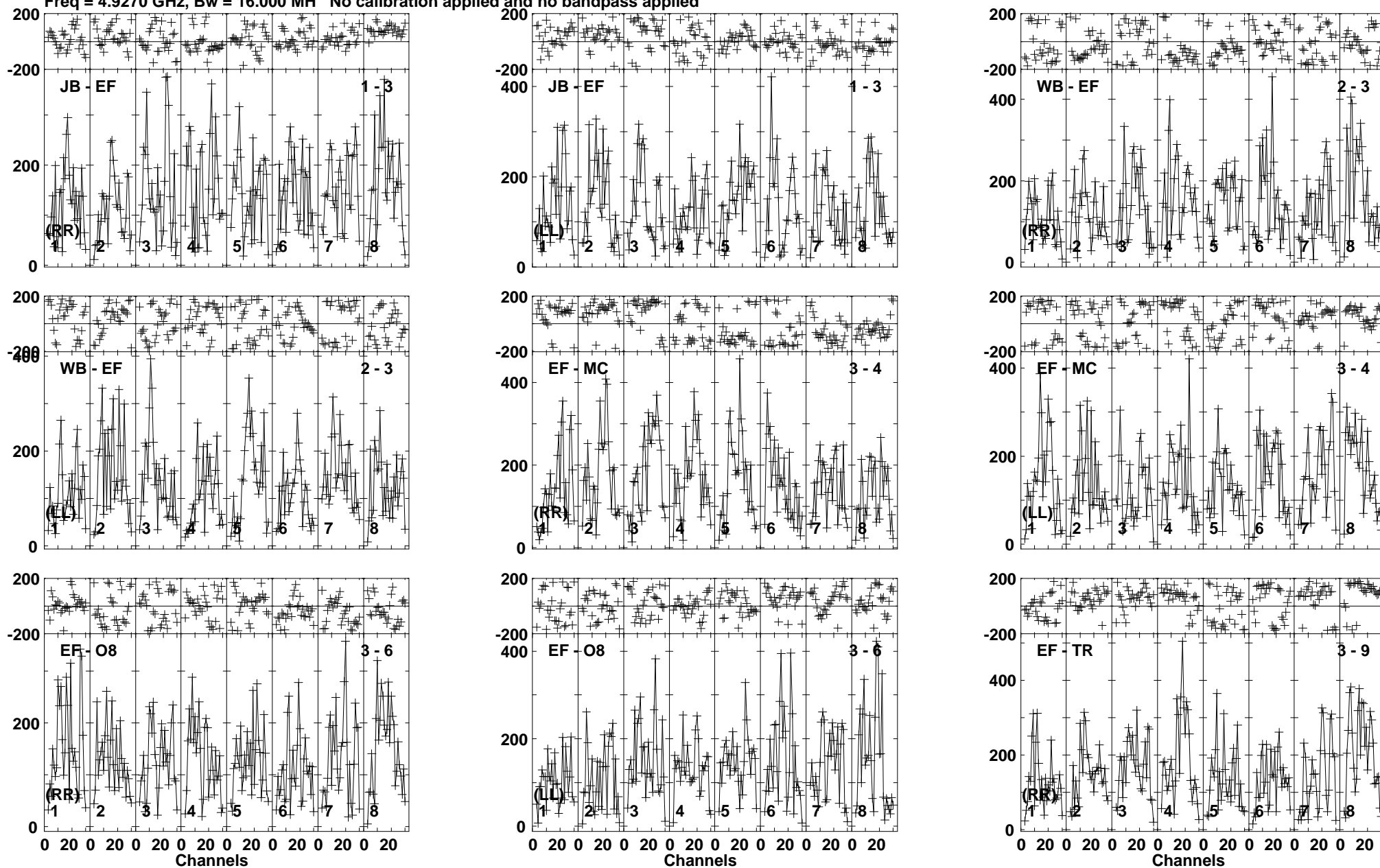

Lower frame: Micro Ampl Jy Top frame: Phas deg  
Vector averaged cross-power spectrum Baseline: JB (01) - EF (03)  
Timerange: 00/11:22:01 to 00/11:23:59

Plot file version 329 created 19-DEC-2018 17:58:34

AT2018\_RY007C.UVDATA.1

Freq = 4.9270 GHz, Bw = 16.000 MH No calibration applied and no bandpass applied

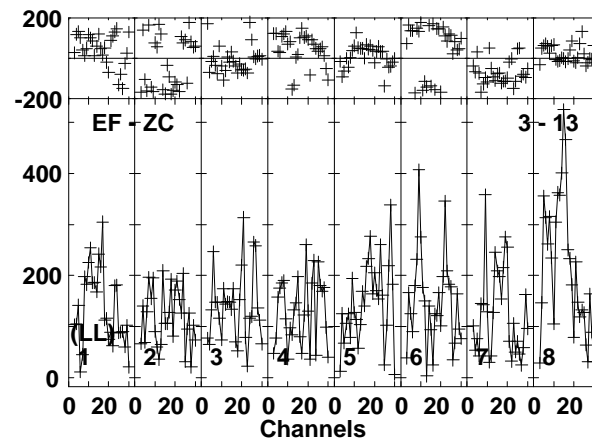
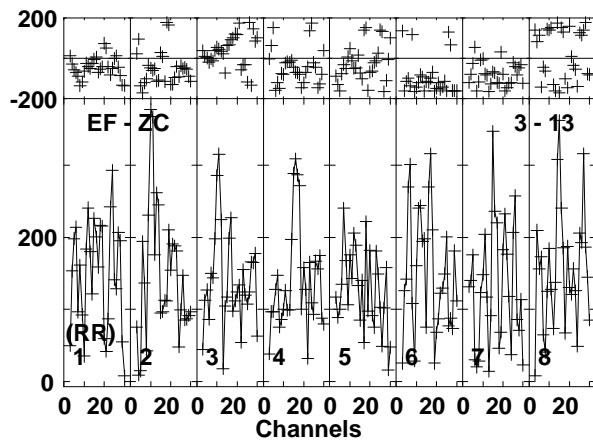
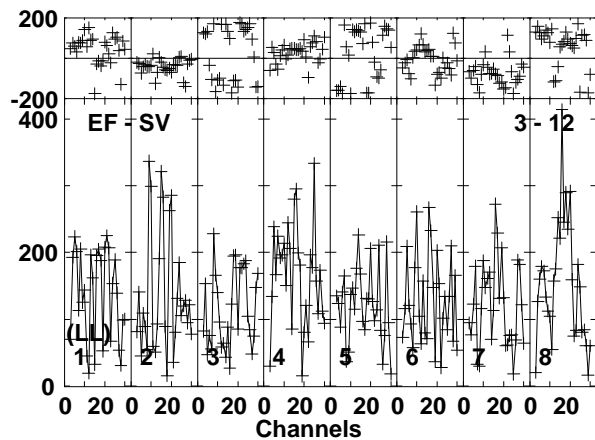
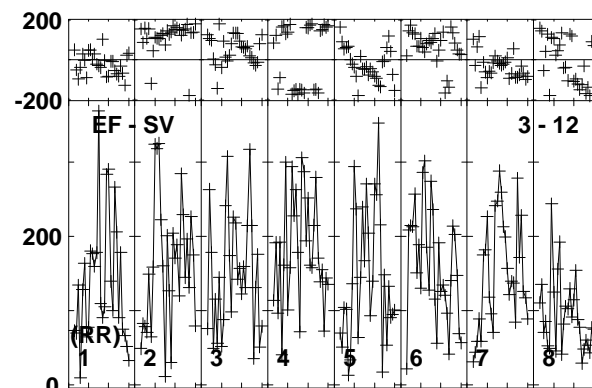
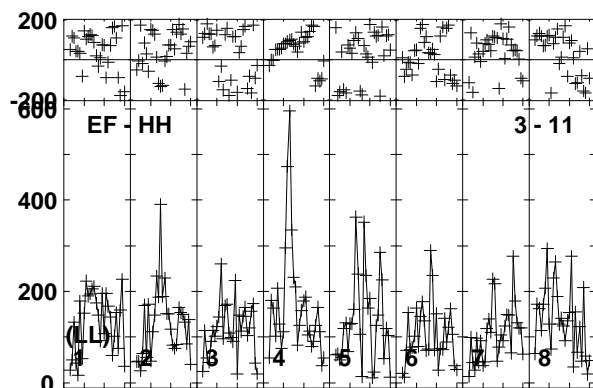
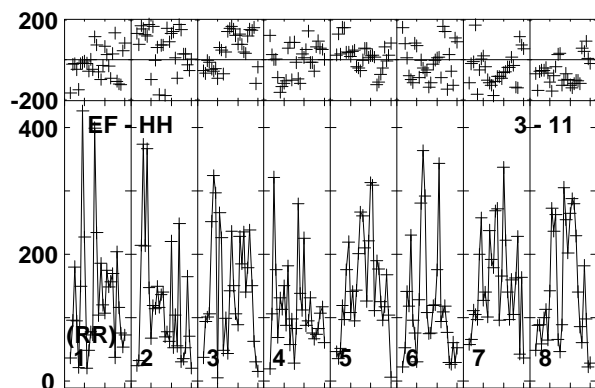
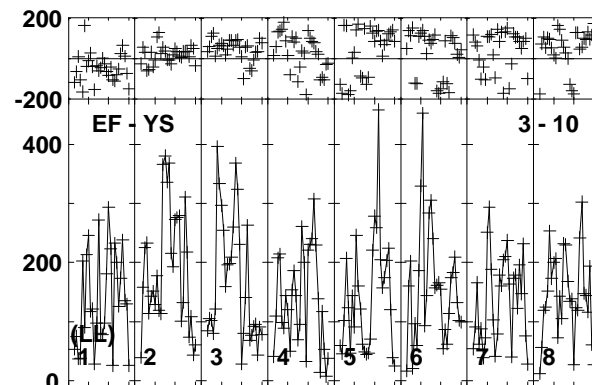
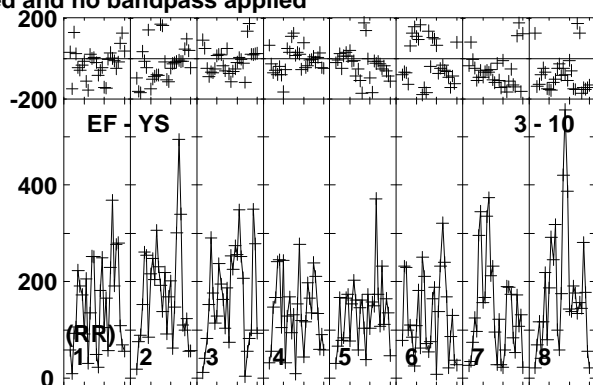
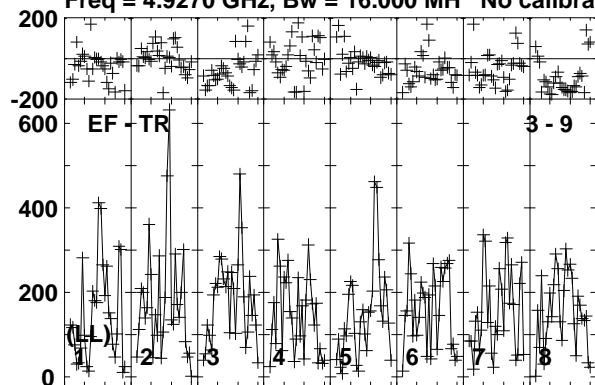

Lower frame: Micro Ampl Jy Top frame: Phas deg  
Vector averaged cross-power spectrum Baseline: EF (03) - TR (09)  
Timerange: 00/11:22:01 to 00/11:23:59

Plot file version 330 created 19-DEC-2018 17:58:34

AT2018\_RY007C.UVDATA.1

Freq = 4.9270 GHz, Bw = 16.000 MH No calibration applied and no bandpass applied

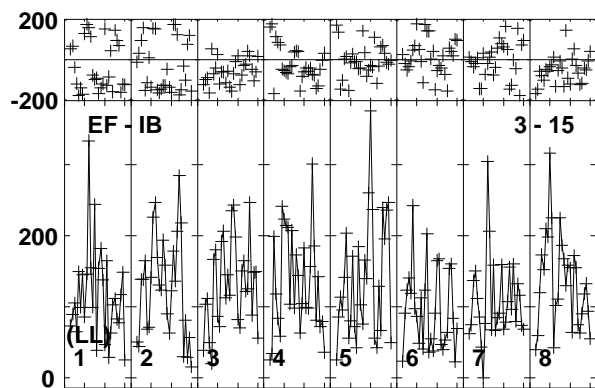
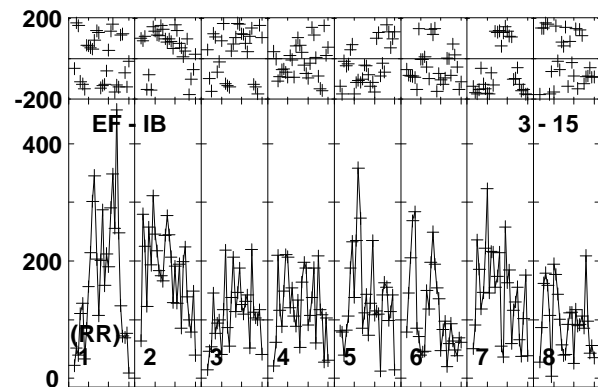
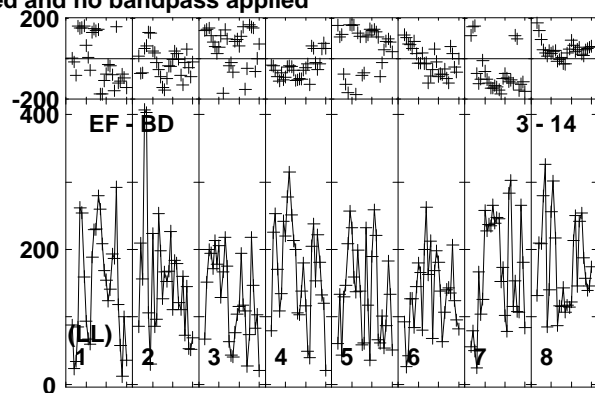
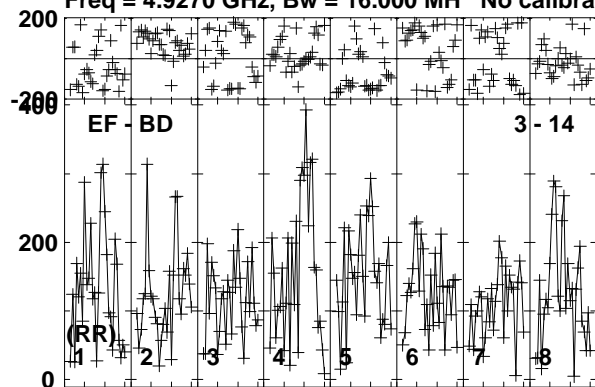

Lower frame: Micro Ampl Jy Top frame: Phas deg  
Vector averaged cross-power spectrum Baseline: EF (03) - BD (14)  
Timerange: 00/11:22:01 to 00/11:23:59



Plot file version 331 created 19-DEC-2018 17:58:34

VLA2\_RY007C.UVDATA.1

Freq = 4.9270 GHz, Bw = 16.000 MH No calibration applied and no bandpass applied

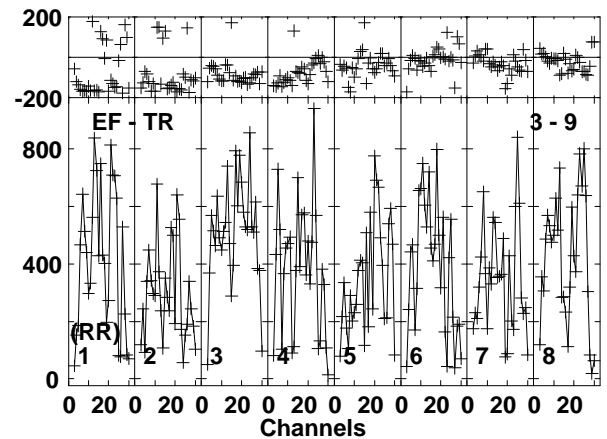
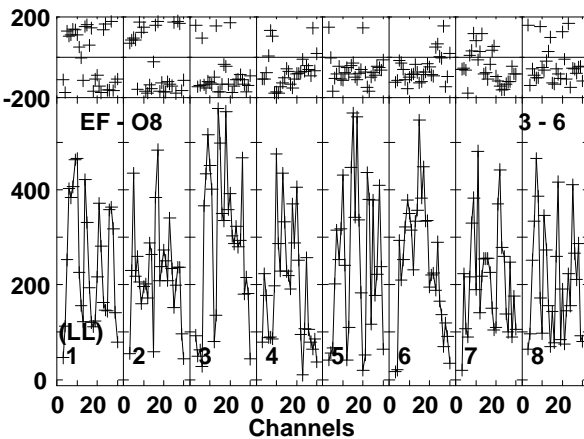
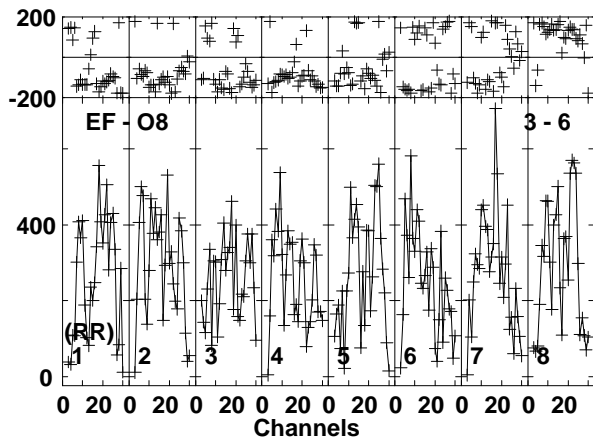
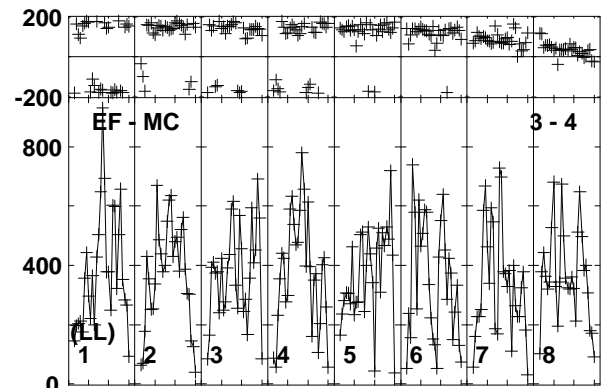
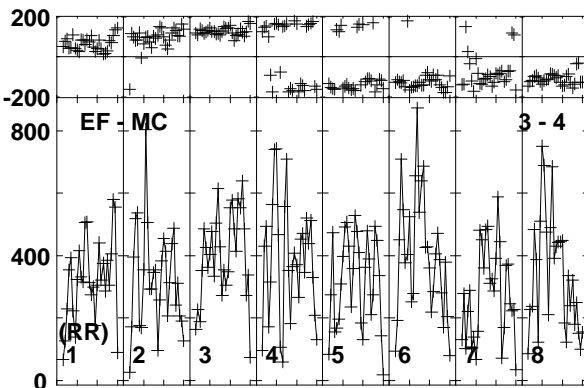
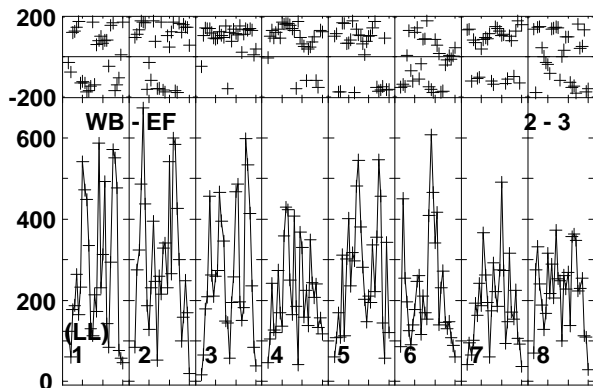
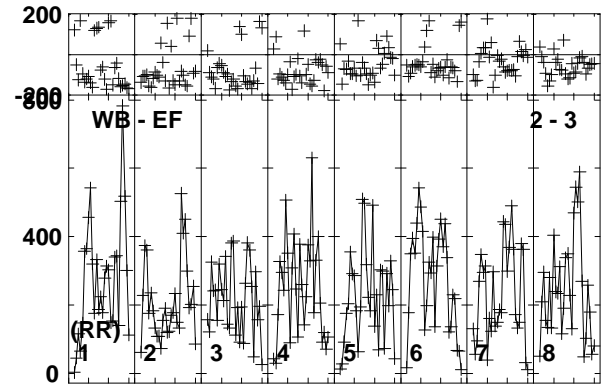
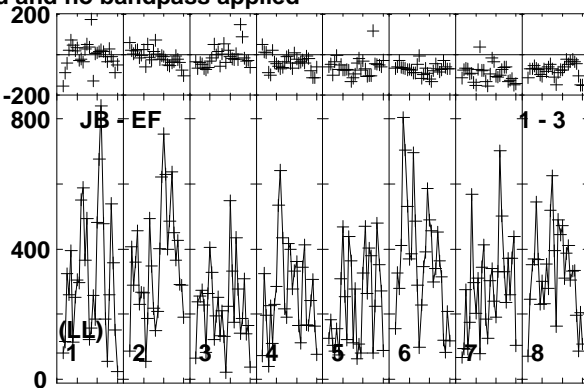
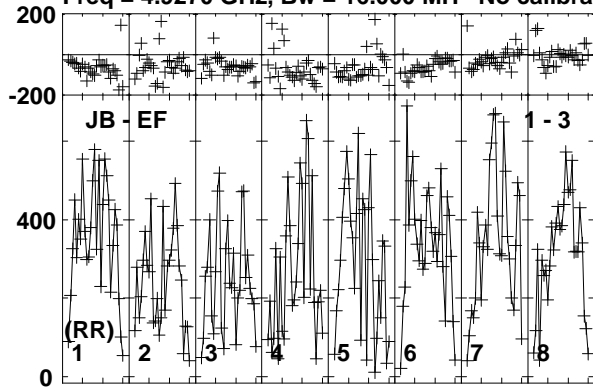

Lower frame: Micro Ampl Jy Top frame: Phas deg  
Vector averaged cross-power spectrum Baseline: JB (01) - EF (03)  
Timerange: 00/11:24:01 to 00/11:24:59

Plot file version 332 created 19-DEC-2018 17:58:36

VLA2 RY007C.UVDATA.1

Freq = 4.9270 GHz, Bw = 16.000 MH No calibration applied and no bandpass applied

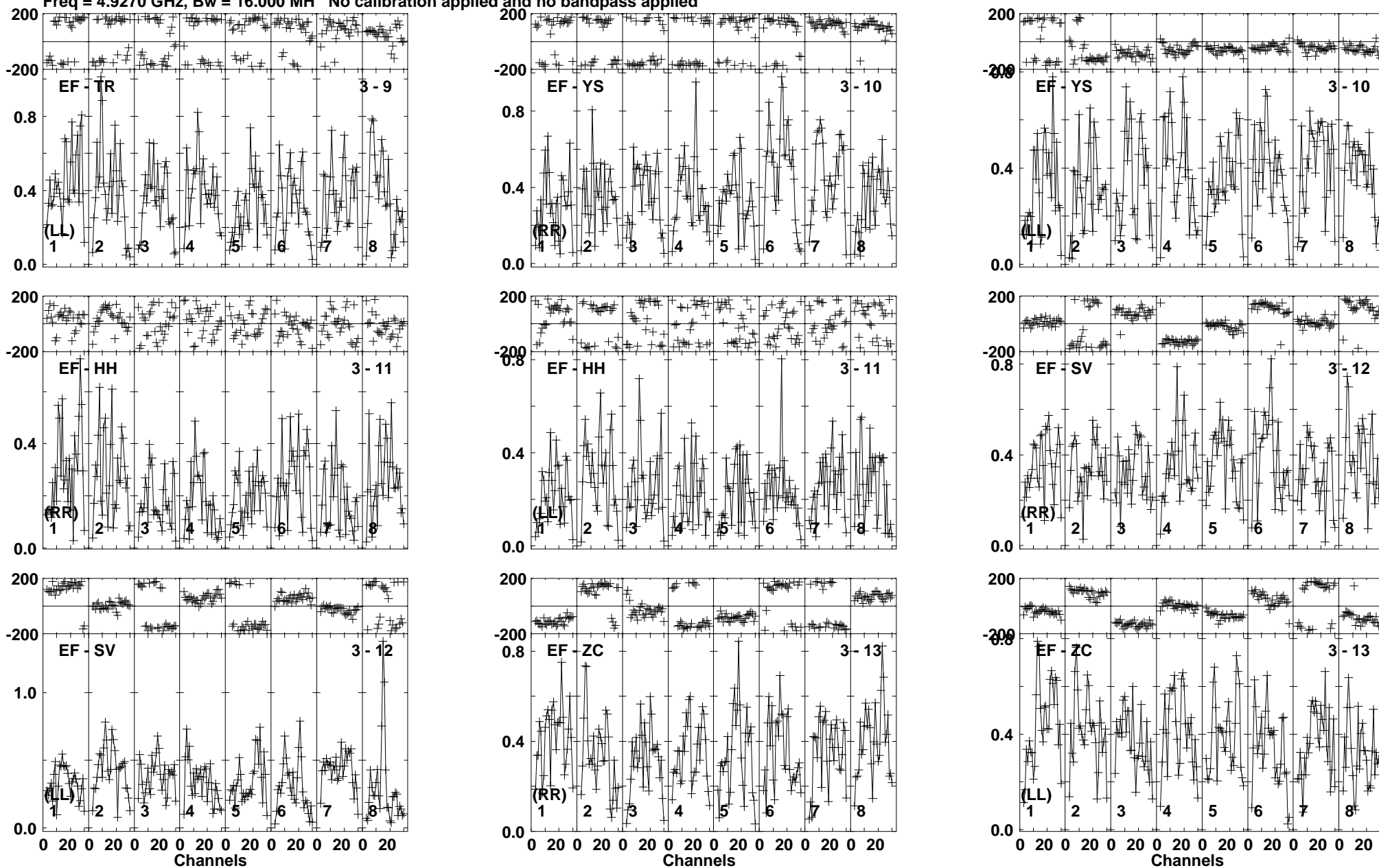

Lower frame: Milli Ampl Jy Top frame: Phas deg  
Vector averaged cross-power spectrum Baseline: EF (03) - TR (09)  
Timerange: 00/11:24:01 to 00/11:24:59

Plot file version 333 created 19-DEC-2018 17:58:36

VLA2 RY007C.UVDATA.1

Freq = 4.9270 GHz, Bw = 16.000 MH No calibration applied and no bandpass applied

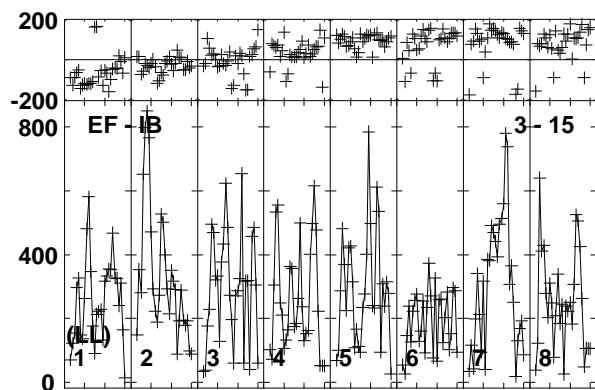
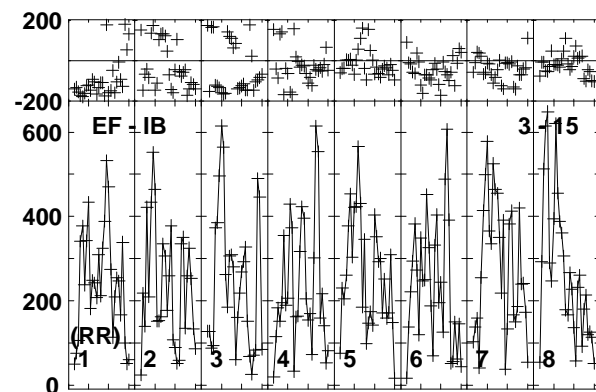
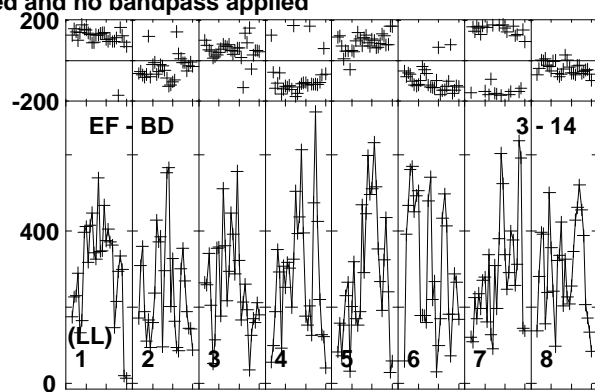
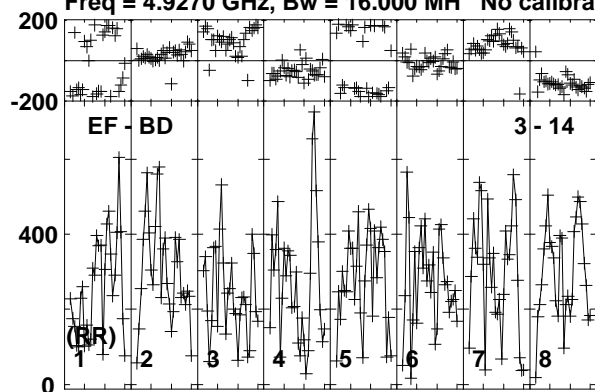

Lower frame: Micro Ampl Jy Top frame: Phas deg  
Vector averaged cross-power spectrum Baseline: EF (03) - BD (14)  
Timerange: 00/11:24:01 to 00/11:24:59

Plot file version 334 created 19-DEC-2018 17:58:36

J1619+2247 RY007C.UVDATA.1

Freq = 4.9270 GHz, Bw = 16.000 MH No calibration applied and no bandpass applied

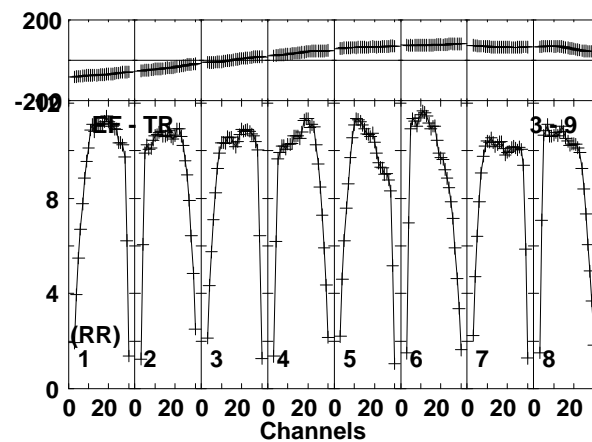
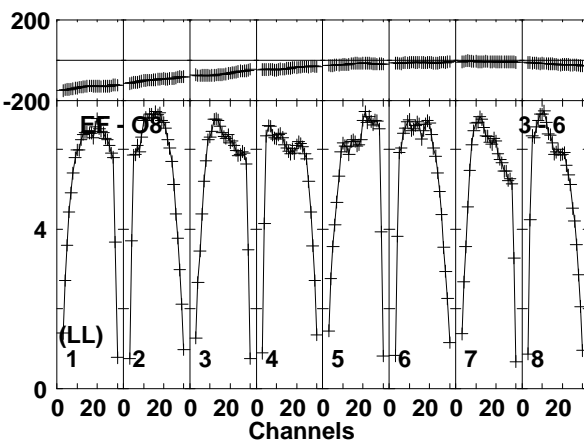
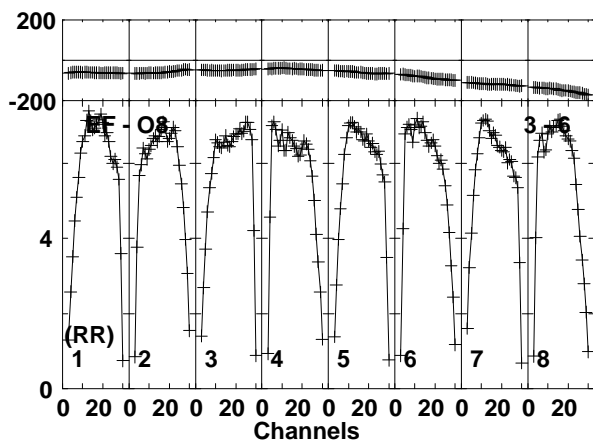
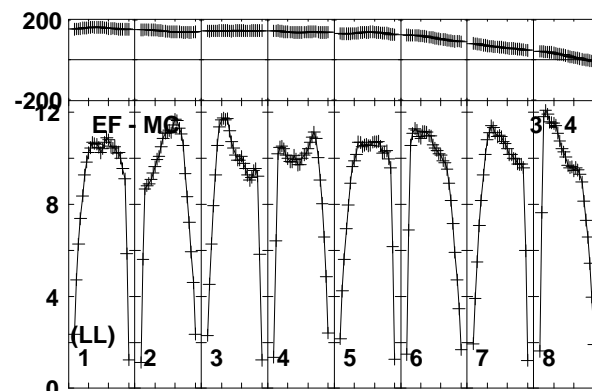
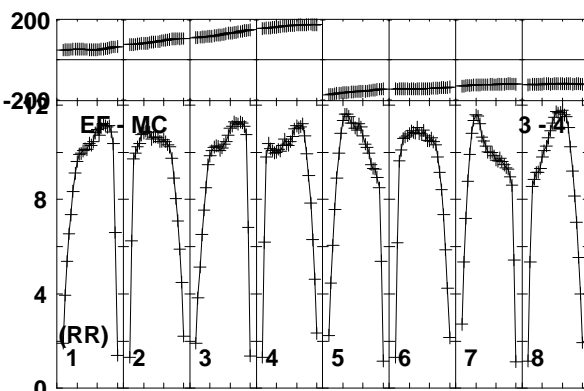
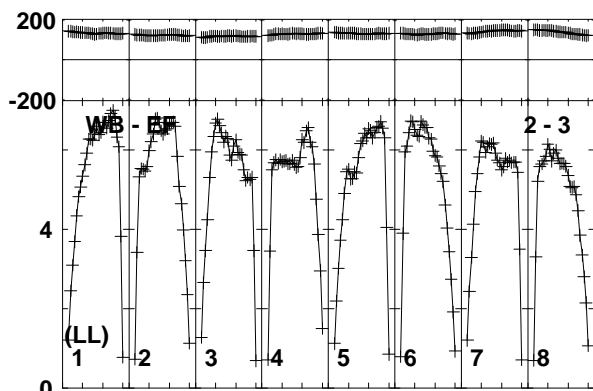
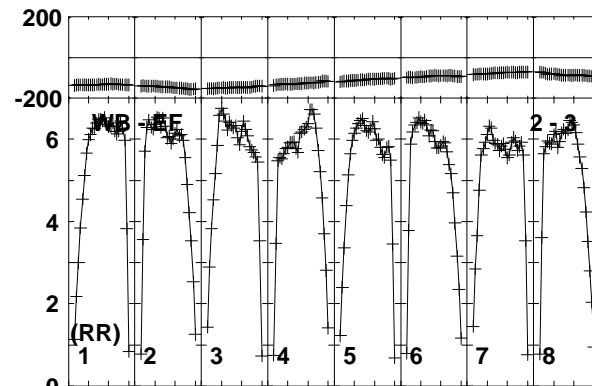
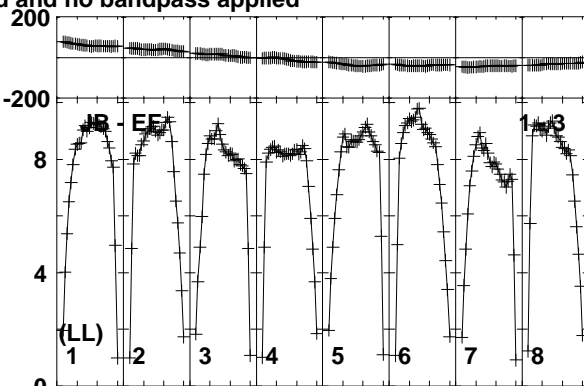
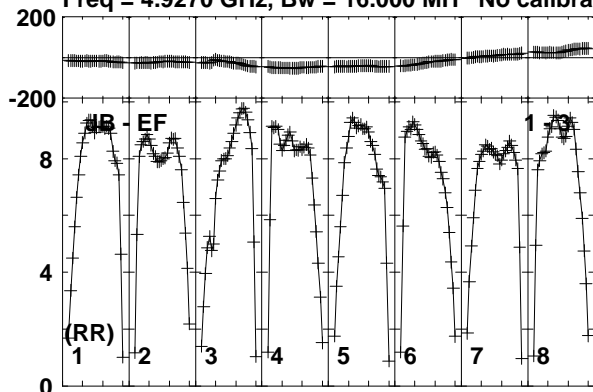

Lower frame: Milli Ampl Jy Top frame: Phas deg  
Vector averaged cross-power spectrum Baseline: JB (01) - EF (03)  
Timerange: 00/11:25:31 to 00/11:26:29

Plot file version 335 created 19-DEC-2018 17:58:36

J1619+2247 RY007C.UVDATA.1

Freq = 4.9270 GHz, Bw = 16.000 MH No calibration applied and no bandpass applied

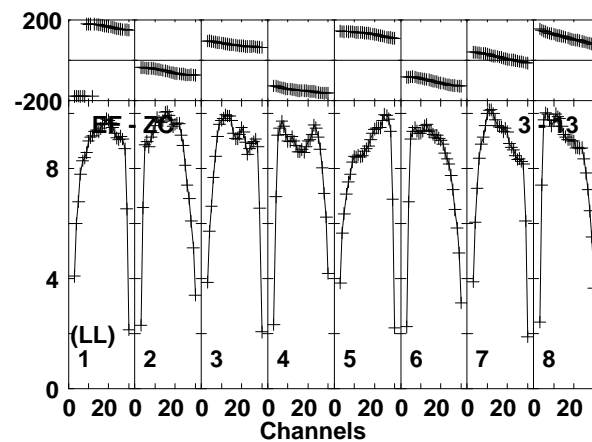
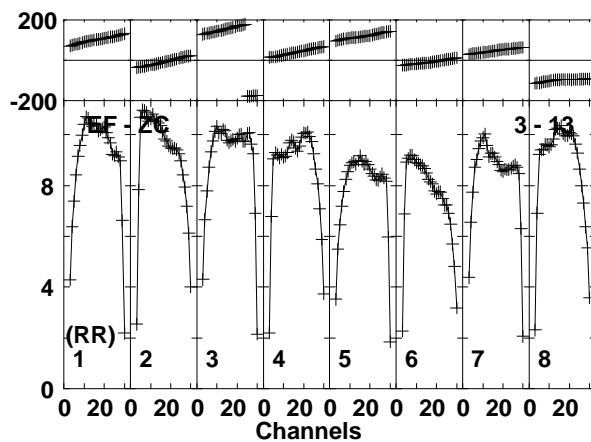
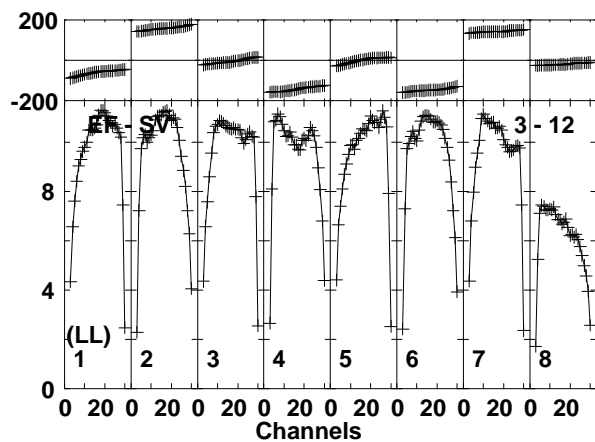
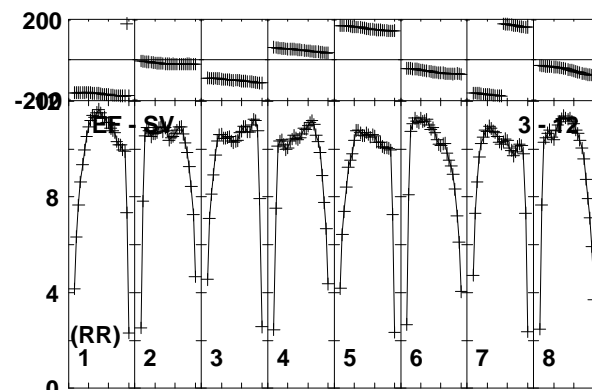
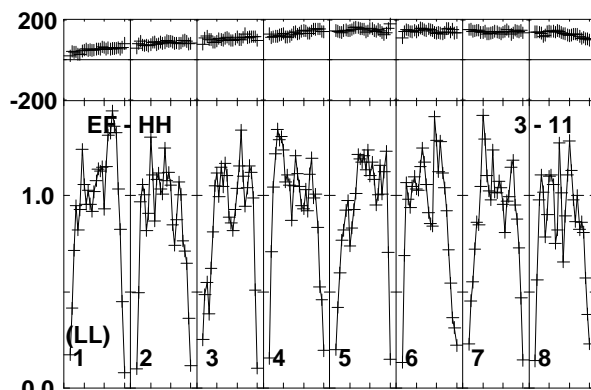
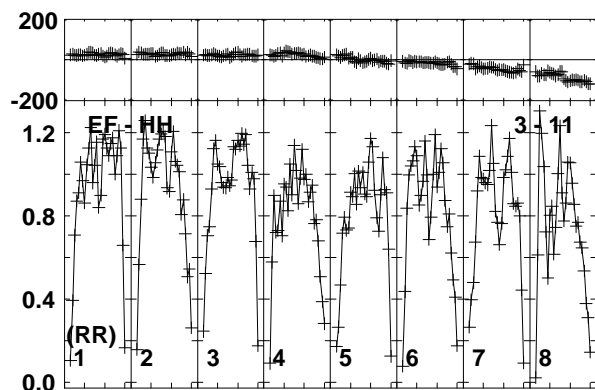
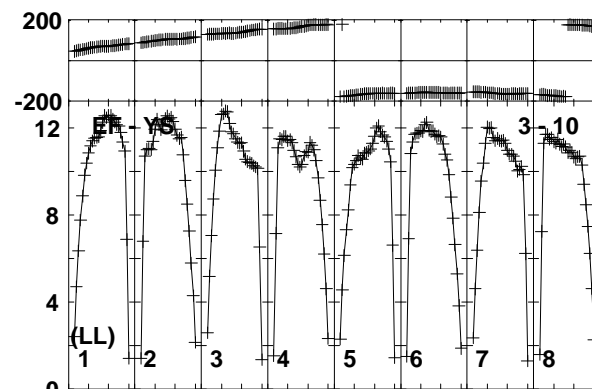
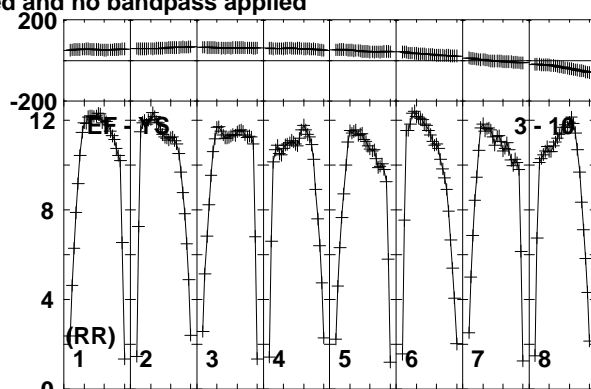
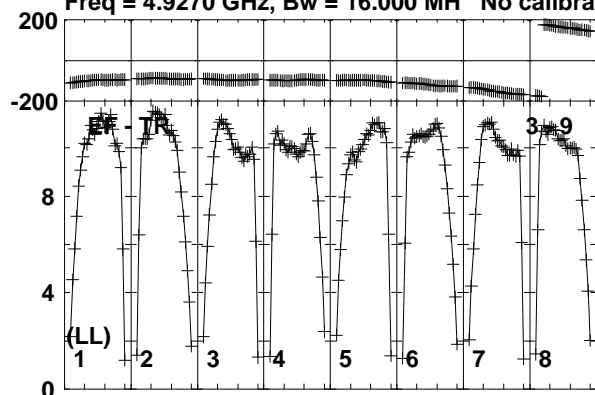

Lower frame: Milli Ampl Jy Top frame: Phas deg  
Vector averaged cross-power spectrum Baseline: EF (03) - TR (09)  
Timerange: 00/11:25:31 to 00/11:26:29

Plot file version 336 created 19-DEC-2018 17:58:36

J1619+2247 RY007C.UVDATA.1

Freq = 4.9270 GHz, Bw = 16.000 MH No calibration applied and no bandpass applied

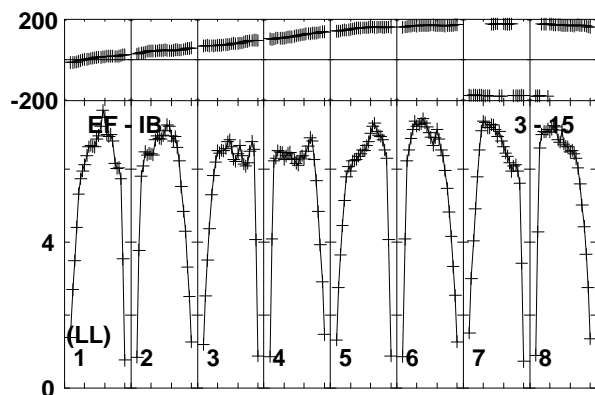
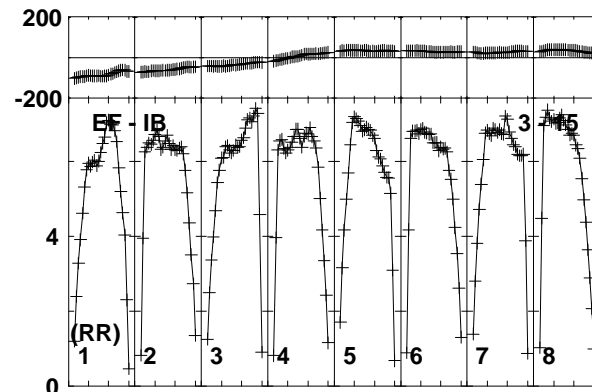
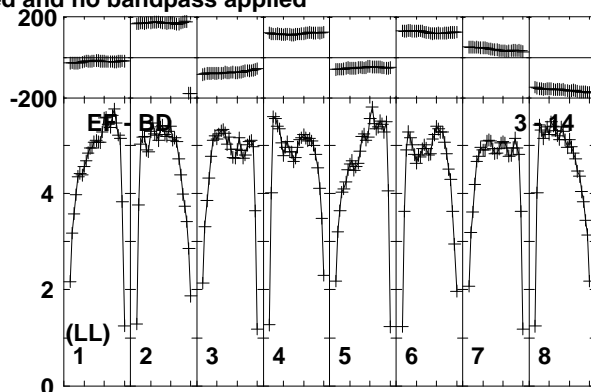
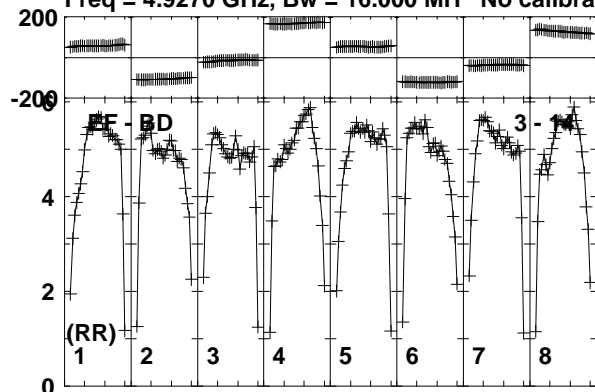

Lower frame: Milli Ampl Jy Top frame: Phas deg

Vector averaged cross-power spectrum Baseline: EF (03) - BD (14)

Timerange: 00/11:25:31 to 00/11:26:29

Plot file version 337 created 19-DEC-2018 17:58:36

AT2018\_RY007C.UVDATA.1

Freq = 4.9270 GHz, Bw = 16.000 MH No calibration applied and no bandpass applied

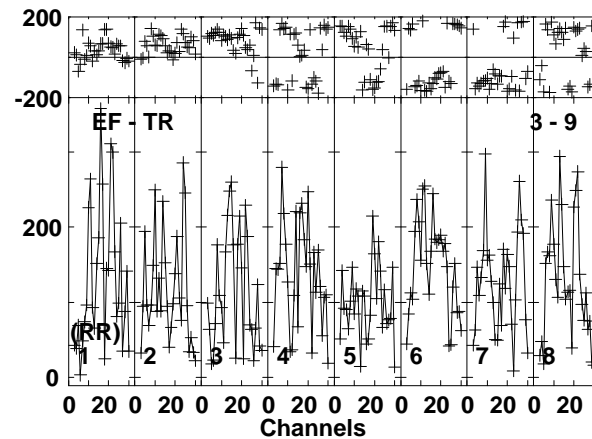
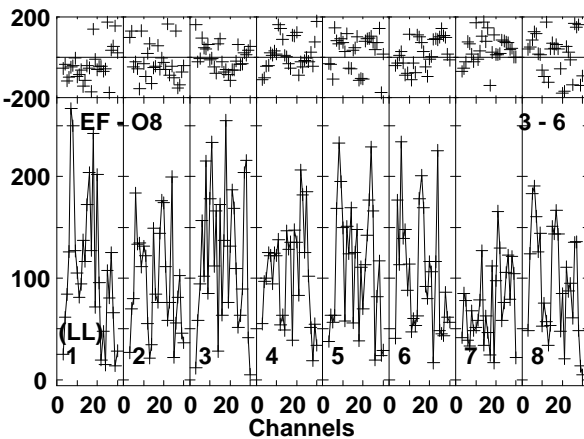
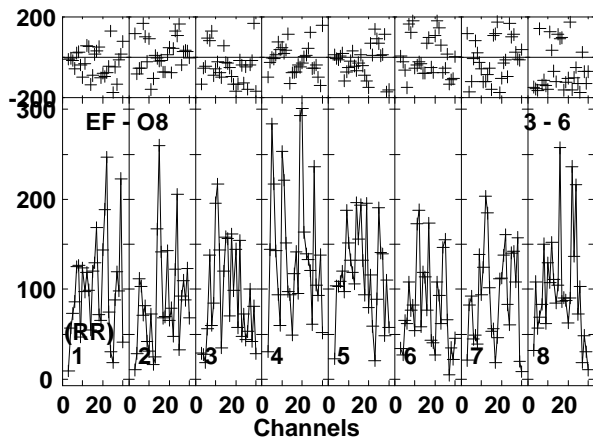
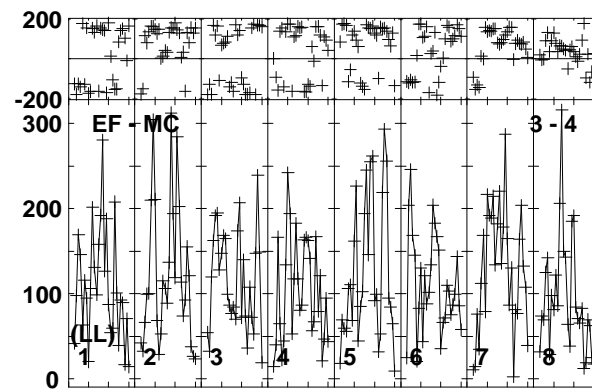
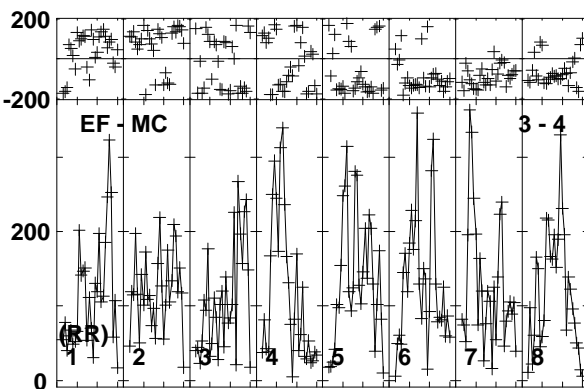
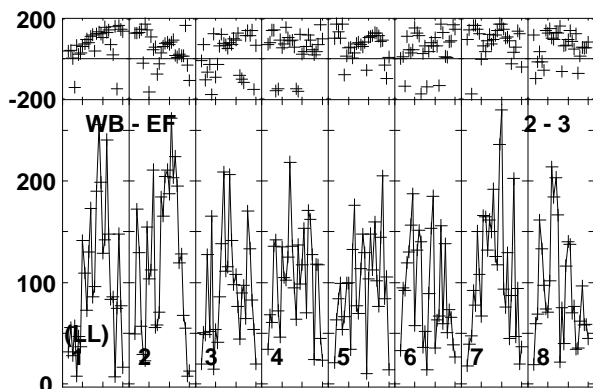
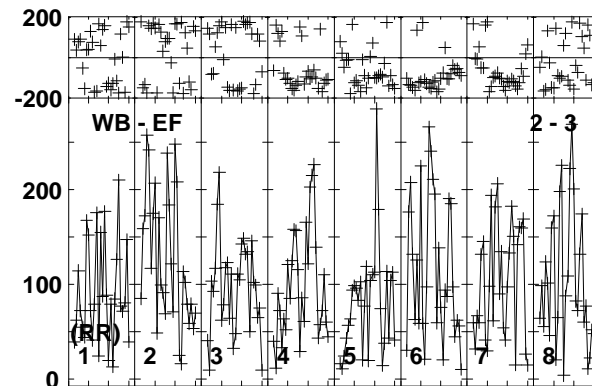
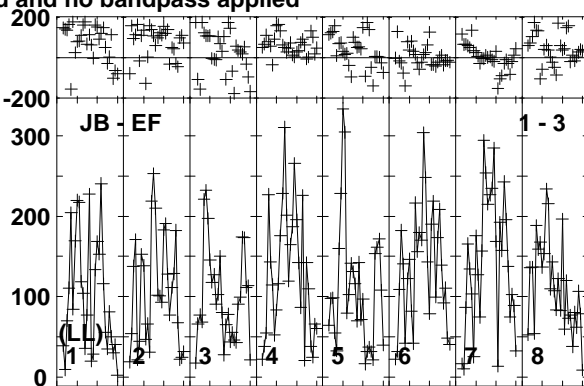
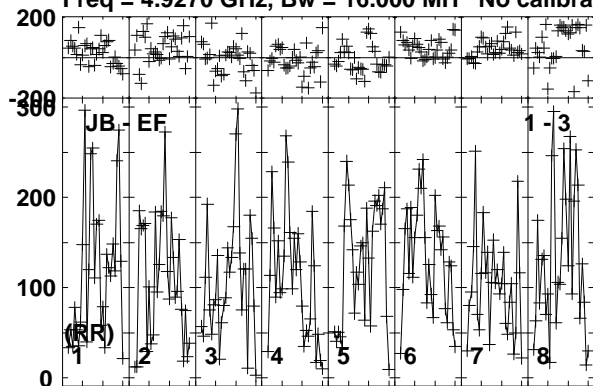

Lower frame: Micro Ampl Jy Top frame: Phas deg  
Vector averaged cross-power spectrum Baseline: JB (01) - EF (03)  
Timerange: 00/11:26:31 to 00/11:29:29

Plot file version 338 created 19-DEC-2018 17:58:36

AT2018\_RY007C.UVDATA.1

Freq = 4.9270 GHz, Bw = 16.000 MH No calibration applied and no bandpass applied

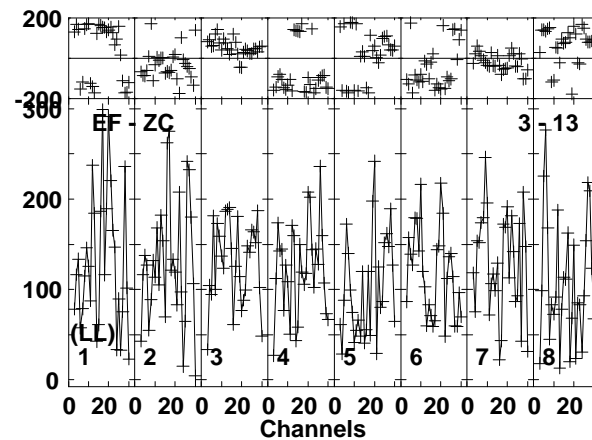
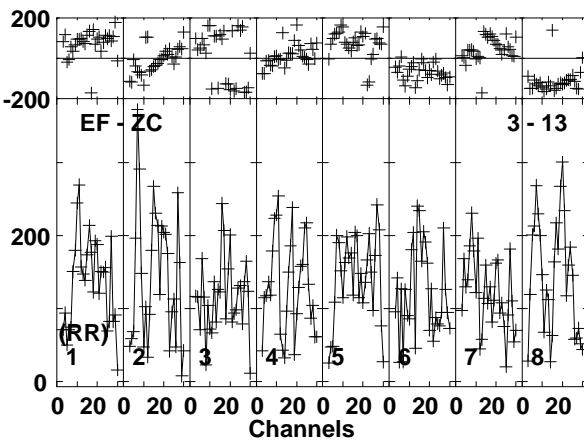
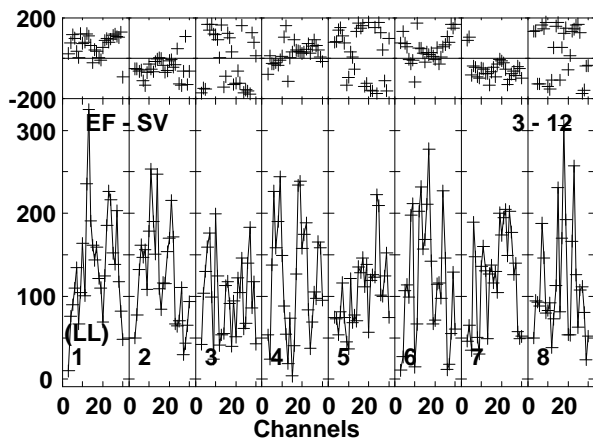
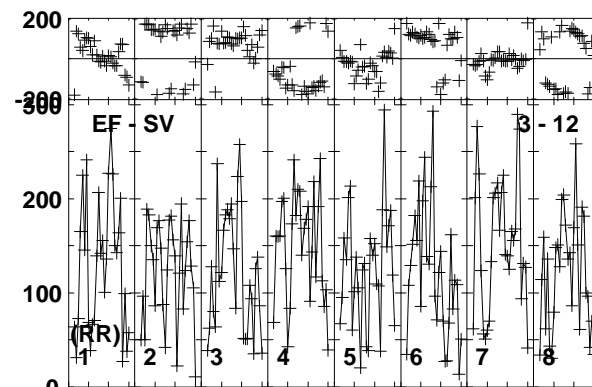
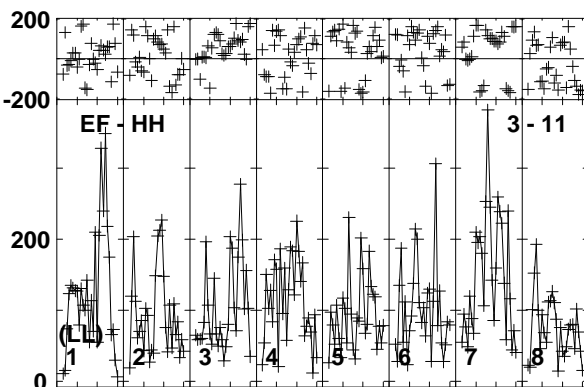
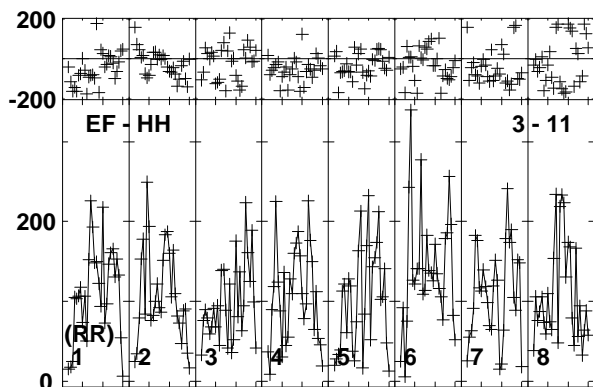
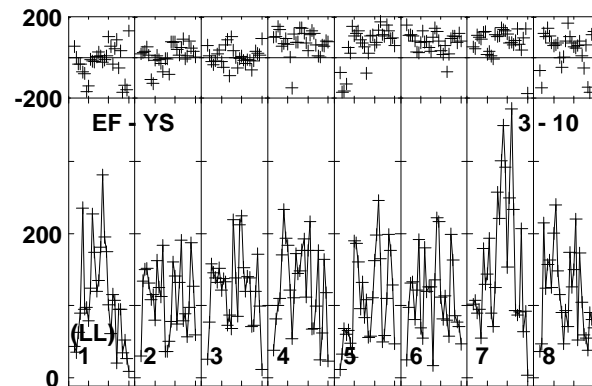
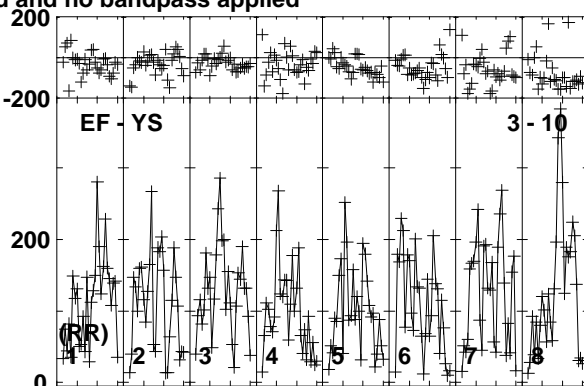
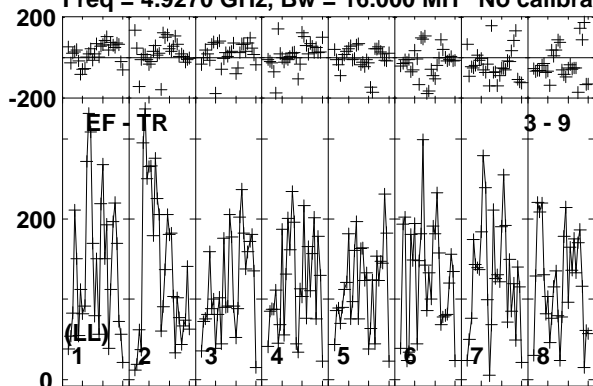

Lower frame: Micro Ampl Jy Top frame: Phas deg  
Vector averaged cross-power spectrum Baseline: EF (03) - TR (09)  
Timerange: 00/11:26:31 to 00/11:29:29



Plot file version 339 created 19-DEC-2018 17:58:36

AT2018\_RY007C.UVDATA.1

Freq = 4.9270 GHz, Bw = 16.000 MH No calibration applied and no bandpass applied

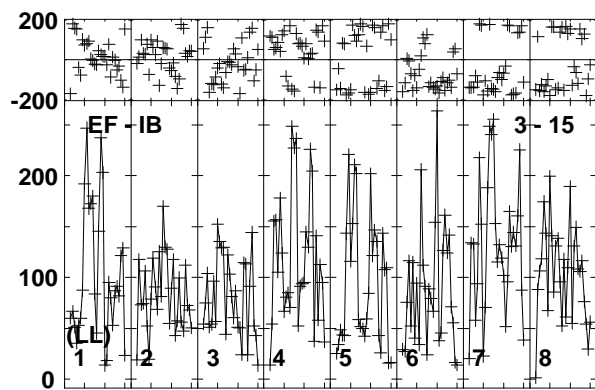
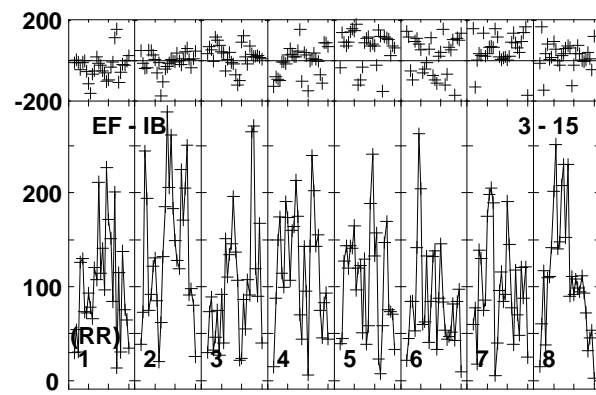
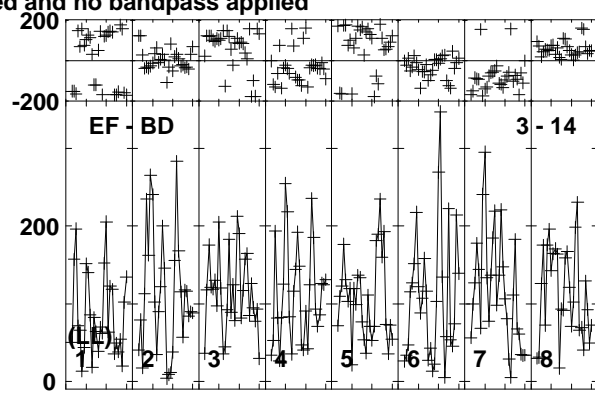
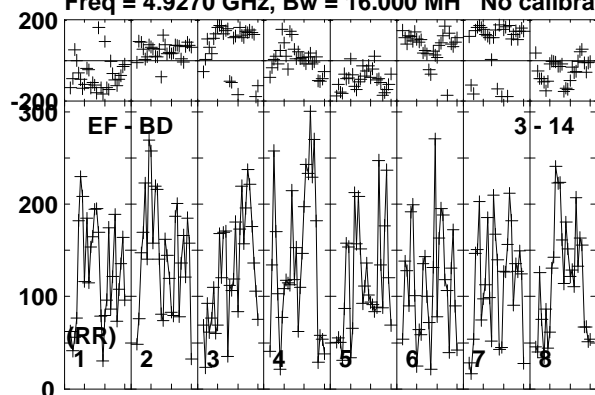

Lower frame: Micro Ampl Jy Top frame: Phas deg  
Vector averaged cross-power spectrum Baseline: EF (03) - BD (14)  
Timerange: 00/11:26:31 to 00/11:29:29

Plot file version 340 created 19-DEC-2018 17:58:36

J1619+2247 RY007C.UVDATA.1

Freq = 4.9270 GHz, Bw = 16.000 MH No calibration applied and no bandpass applied

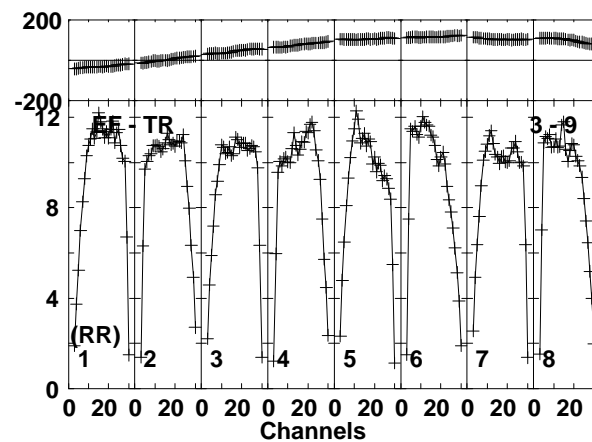
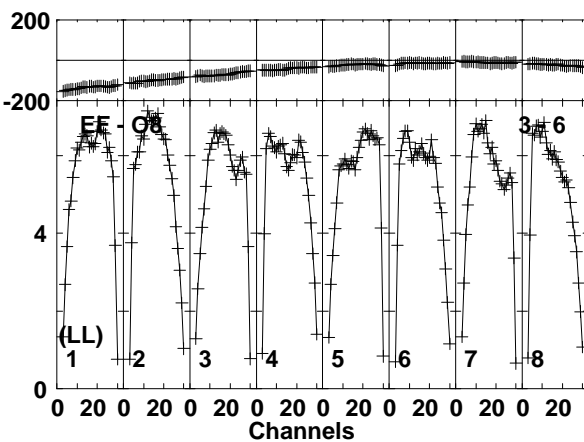
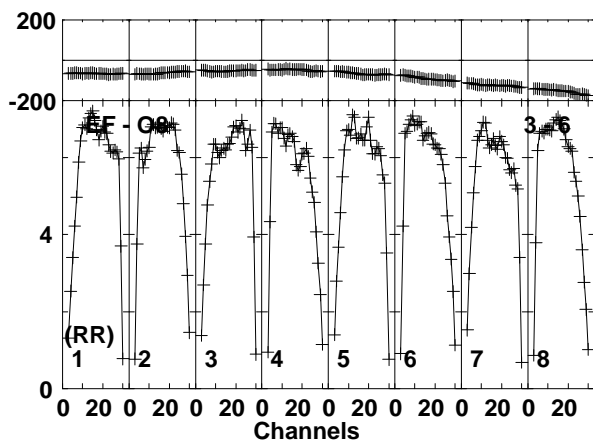
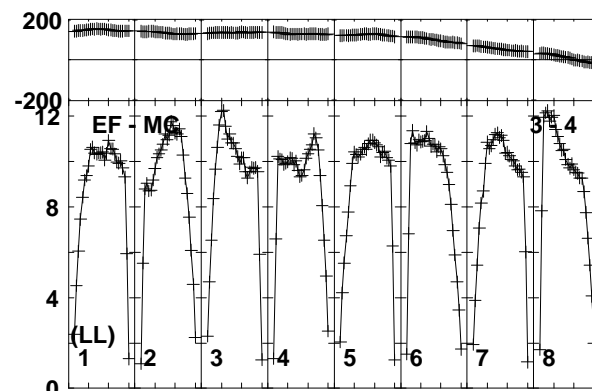
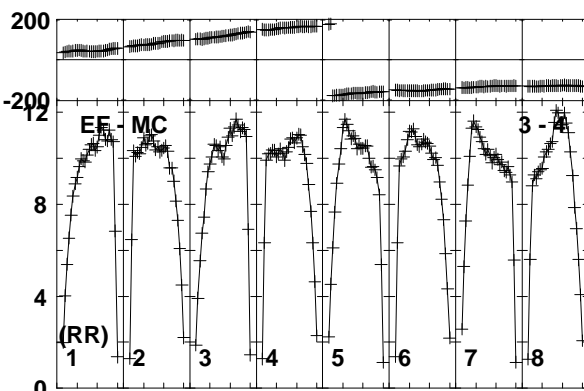
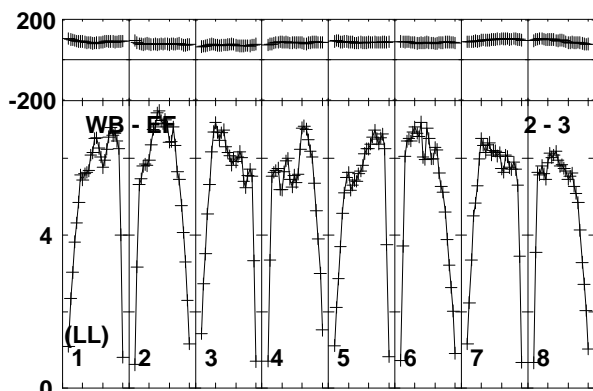
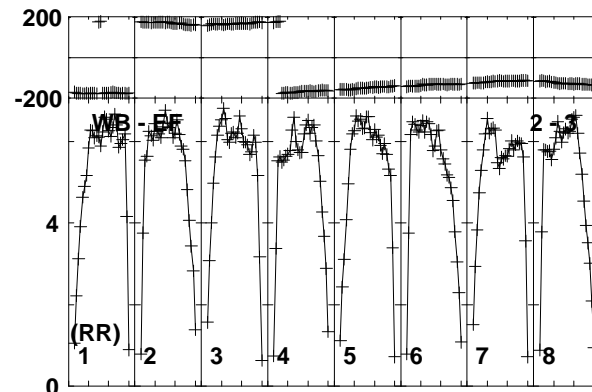
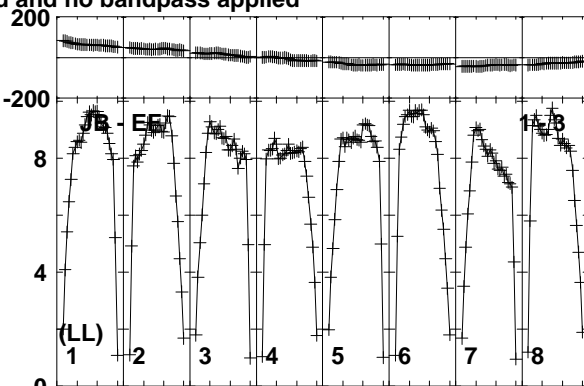
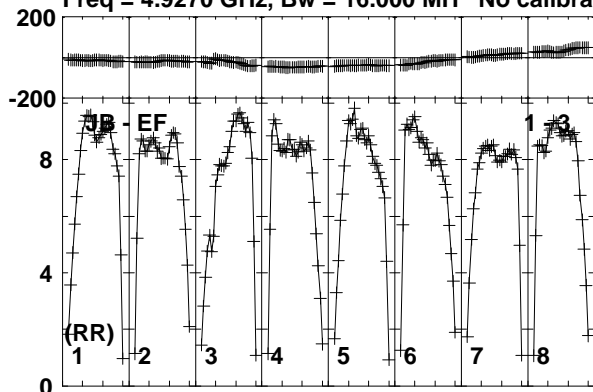

Lower frame: Milli Ampl Jy Top frame: Phas deg  
Vector averaged cross-power spectrum Baseline: JB (01) - EF (03)  
Timerange: 00/11:29:31 to 00/11:30:29

Plot file version 341 created 19-DEC-2018 17:58:36

J1619+2247 RY007C.UVDATA.1

Freq = 4.9270 GHz, Bw = 16.000 MH No calibration applied and no bandpass applied

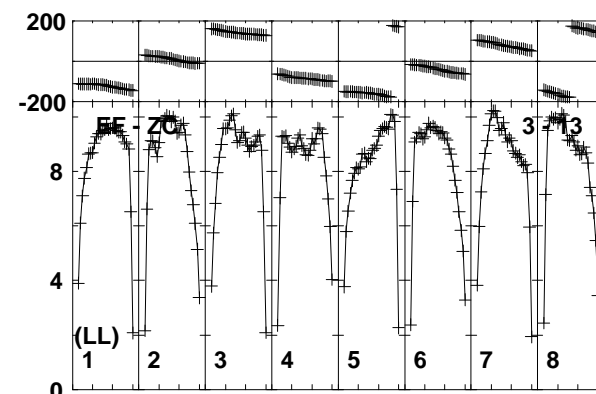
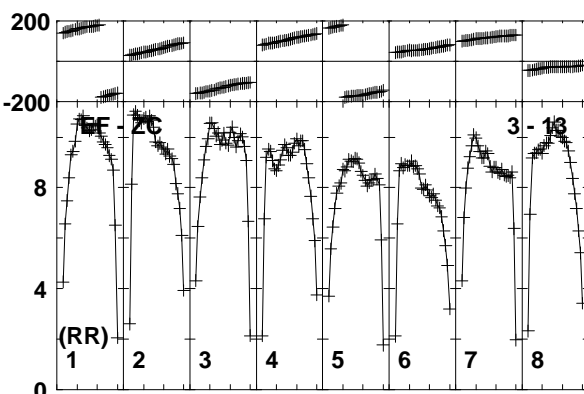
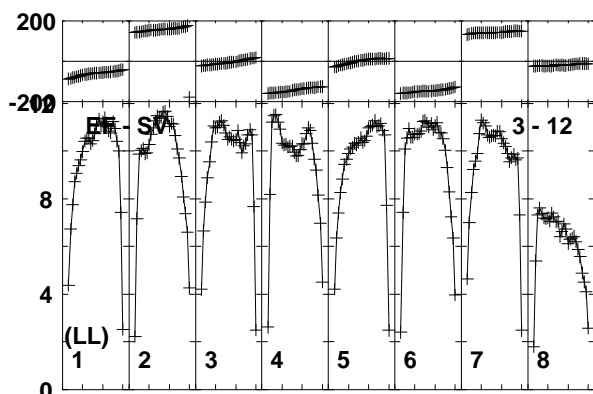
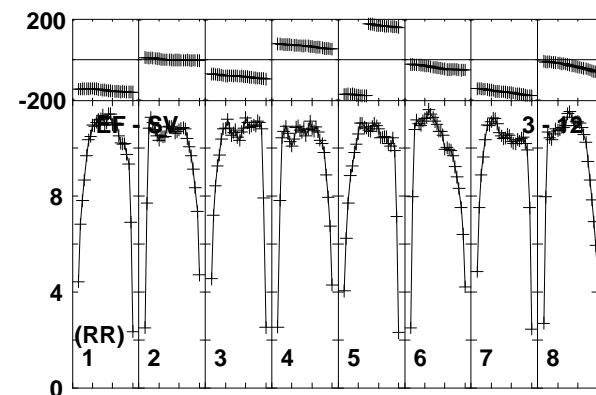
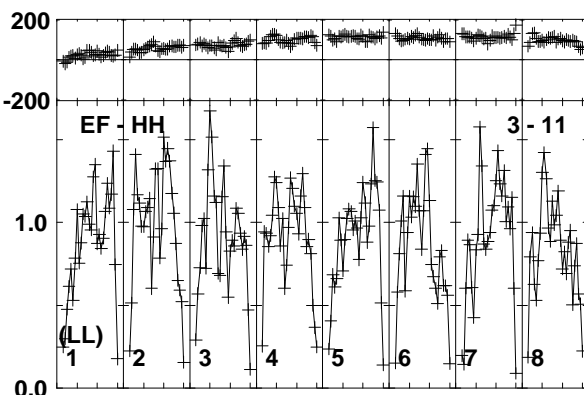
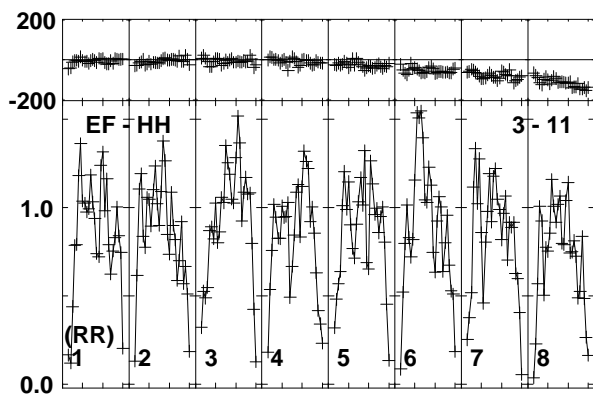
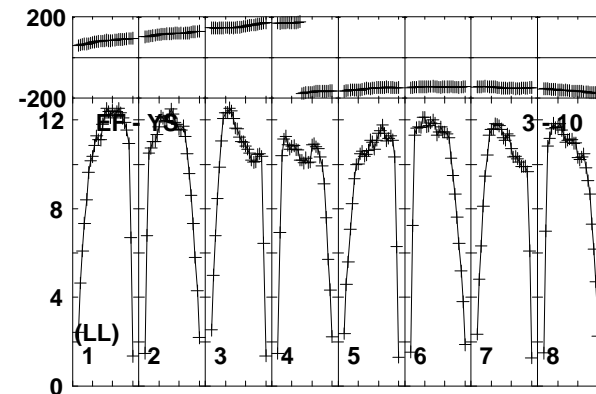
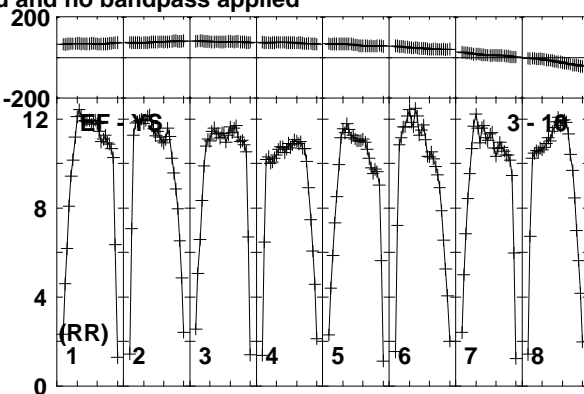
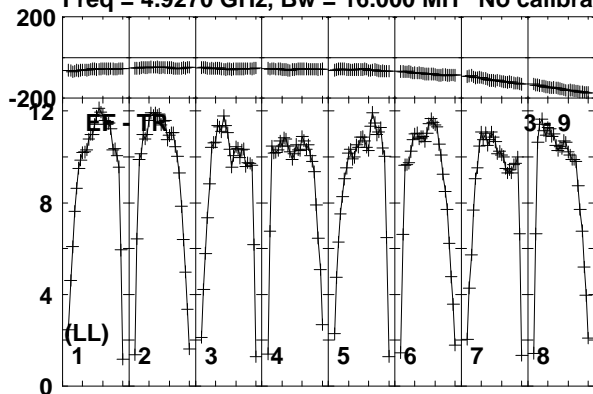

Lower frame: Milli Ampl Jy Top frame: Phas deg  
Vector averaged cross-power spectrum Baseline: EF (03) - TR (09)  
Timerange: 00/11:29:31 to 00/11:30:29

Plot file version 342 created 19-DEC-2018 17:58:37

J1619+2247 RY007C.UVDATA.1

Freq = 4.9270 GHz, Bw = 16.000 MH No calibration applied and no bandpass applied

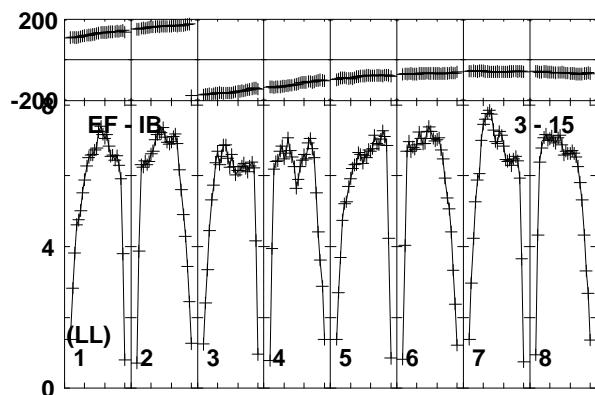
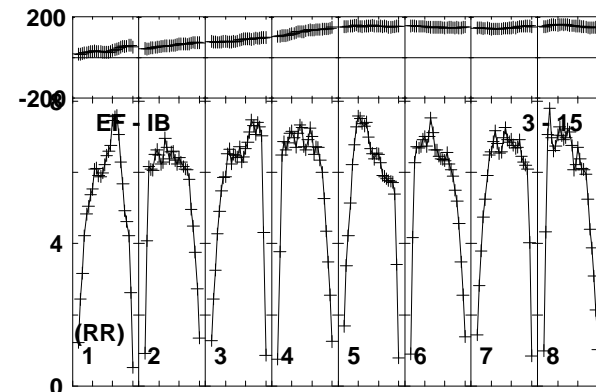
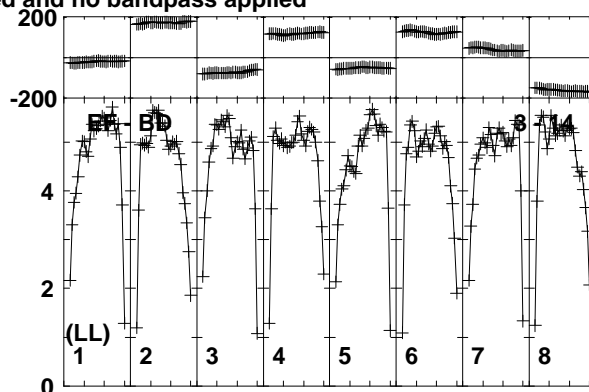
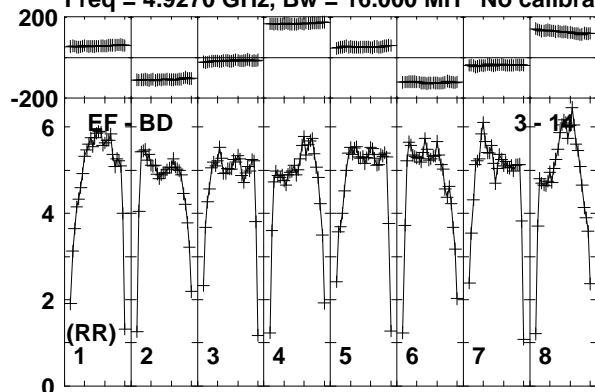

Lower frame: Milli Ampl Jy Top frame: Phas deg  
Vector averaged cross-power spectrum Baseline: EF (03) - BD (14)  
Timerange: 00/11:29:31 to 00/11:30:29

Plot file version 343 created 19-DEC-2018 17:58:37

AT2018\_RY007C.UVDATA.1

Freq = 4.9270 GHz, Bw = 16.000 MH No calibration applied and no bandpass applied

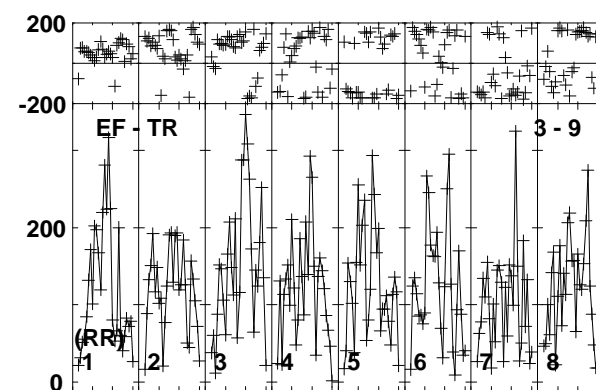
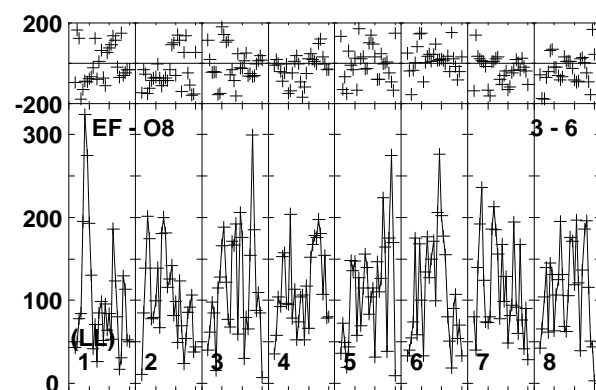
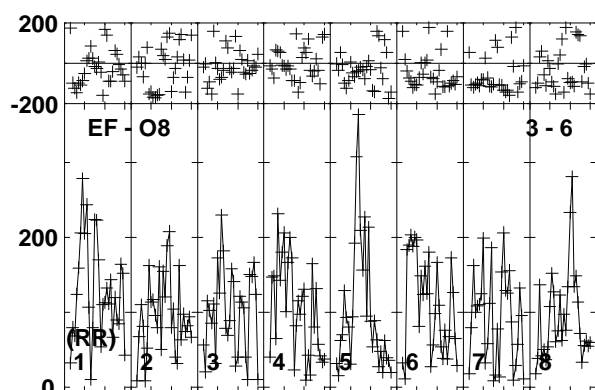
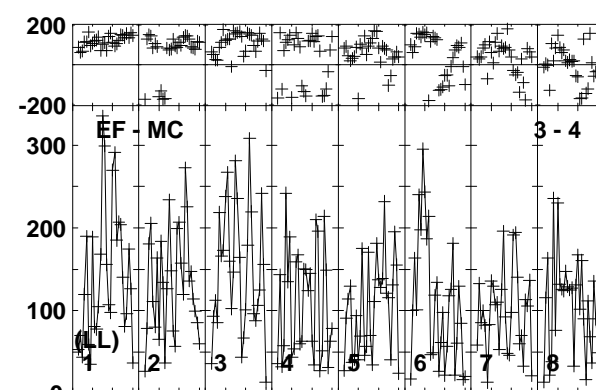
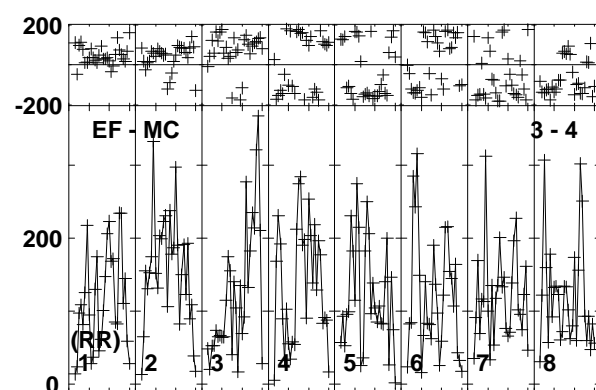
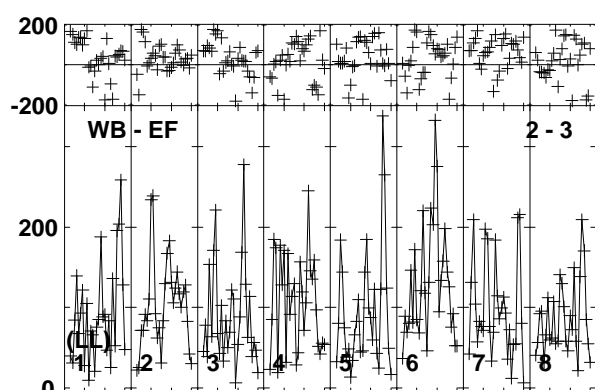
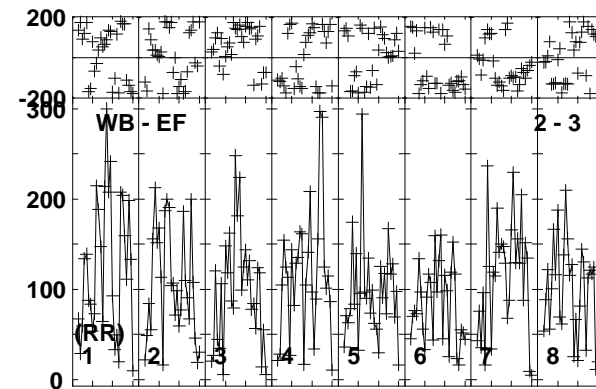
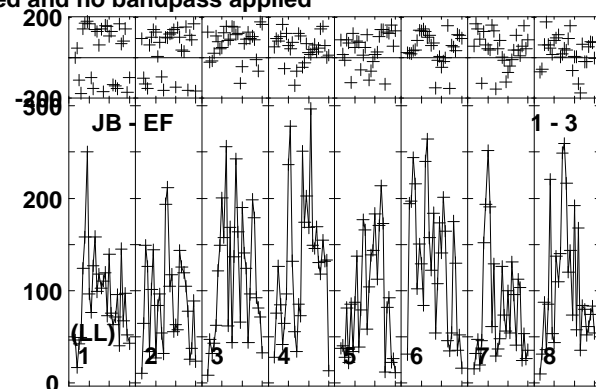
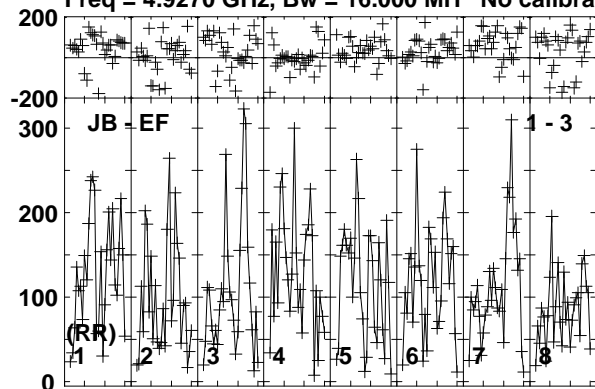

Lower frame: Micro Ampl Jy Top frame: Phas deg  
Vector averaged cross-power spectrum Baseline: JB (01) - EF (03)  
Timerange: 00/11:30:31 to 00/11:33:29

Plot file version 344 created 19-DEC-2018 17:58:37  
AT2018\_RY007C.UVDATA.1

Freq = 4.9270 GHz, Bw = 16.000 MH No calibration applied and no bandpass applied

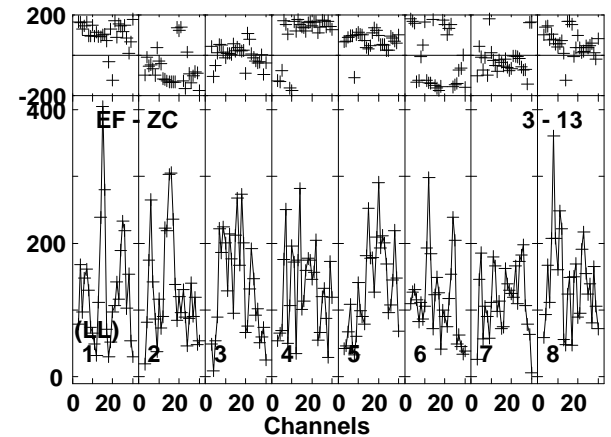
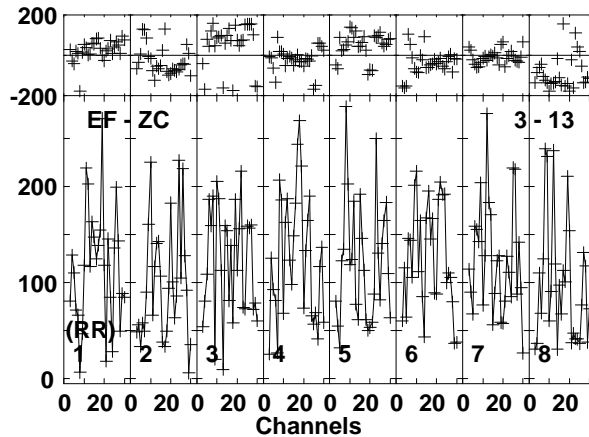
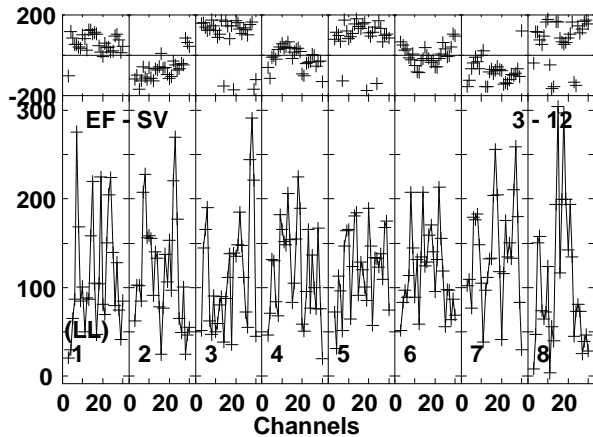
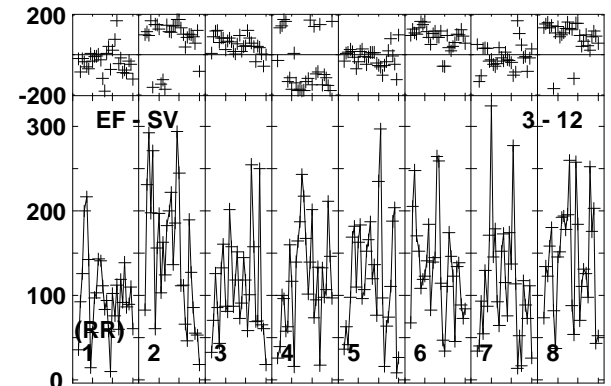
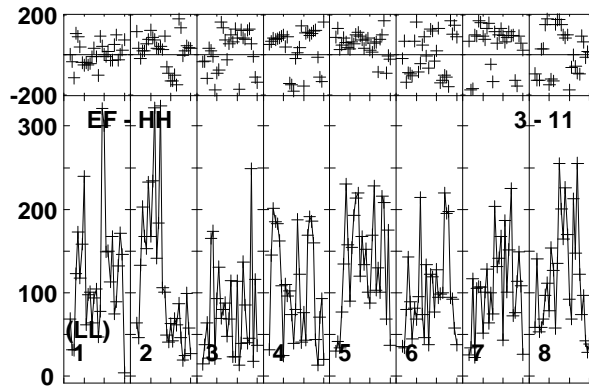
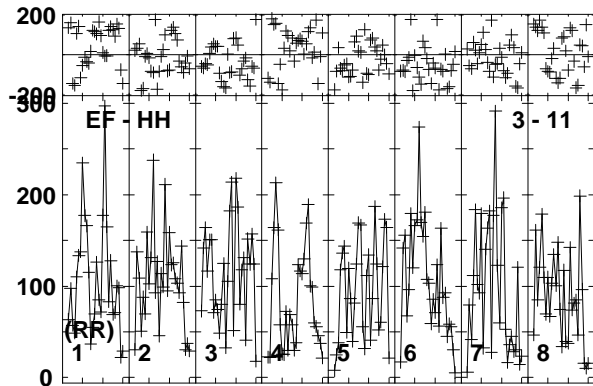
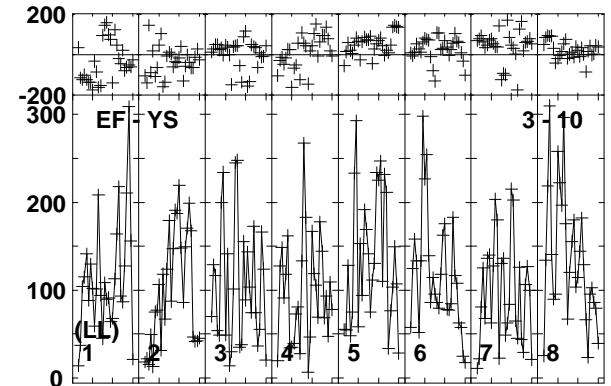
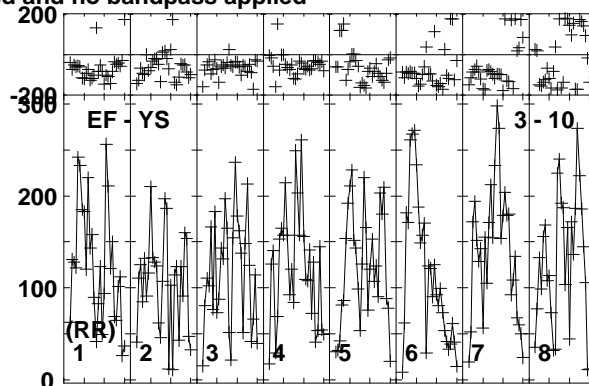
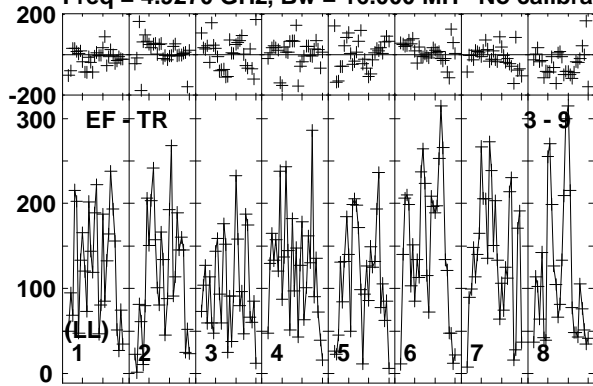

Lower frame: Micro Ampl Jy Top frame: Phas deg  
Vector averaged cross-power spectrum Baseline: EF (03) - TR (09)  
Timerange: 00/11:30:31 to 00/11:33:29

Plot file version 345 created 19-DEC-2018 17:58:37

AT2018\_RY007C.UVDATA.1

Freq = 4.9270 GHz, Bw = 16.000 MH No calibration applied and no bandpass applied

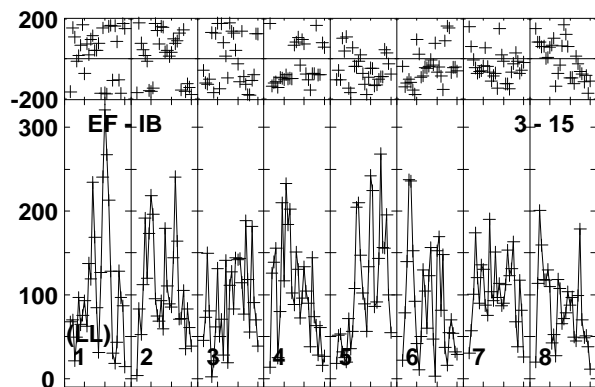
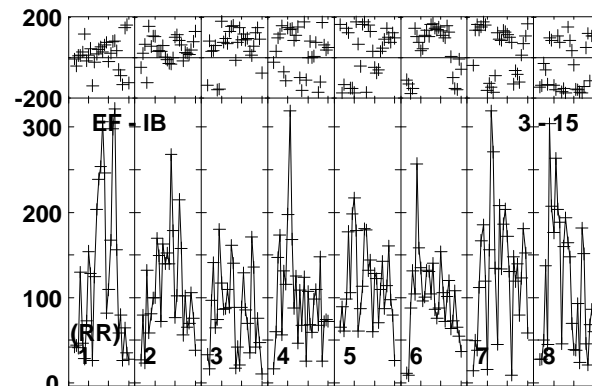
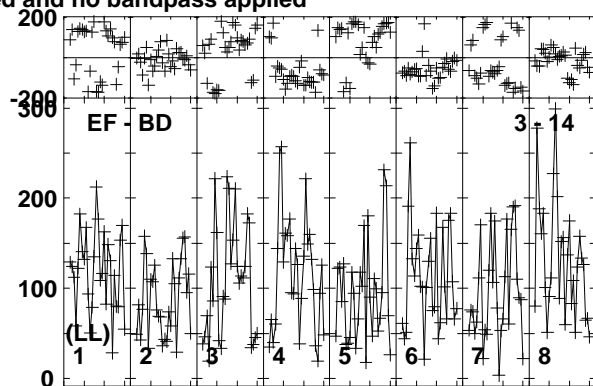
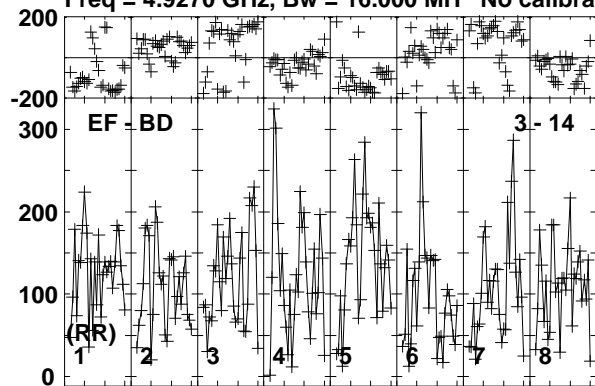

Lower frame: Micro Ampl Jy Top frame: Phas deg  
Vector averaged cross-power spectrum Baseline: EF (03) - BD (14)  
Timerange: 00/11:30:31 to 00/11:33:29

Plot file version 346 created 19-DEC-2018 17:58:37

J1619+2247 RY007C.UVDATA.1

Freq = 4.9270 GHz, Bw = 16.000 MH No calibration applied and no bandpass applied

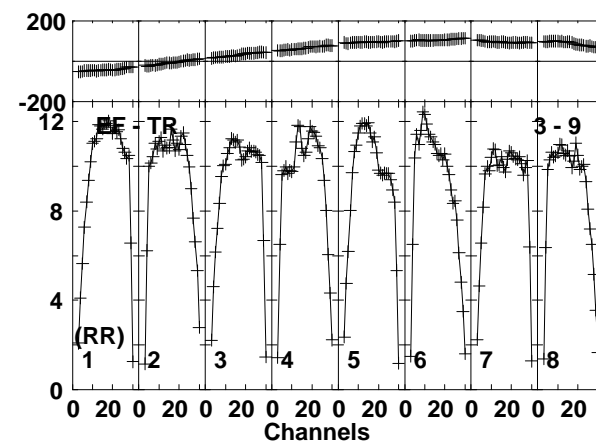
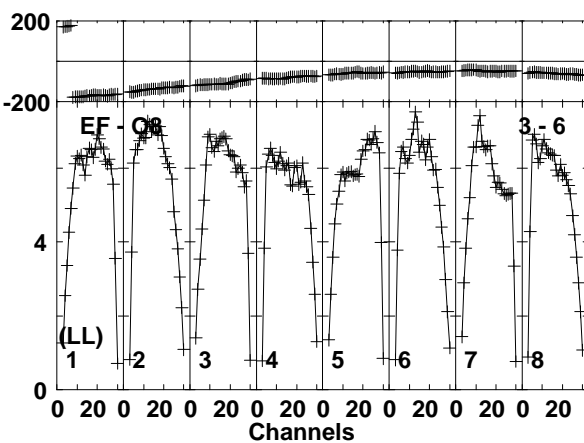
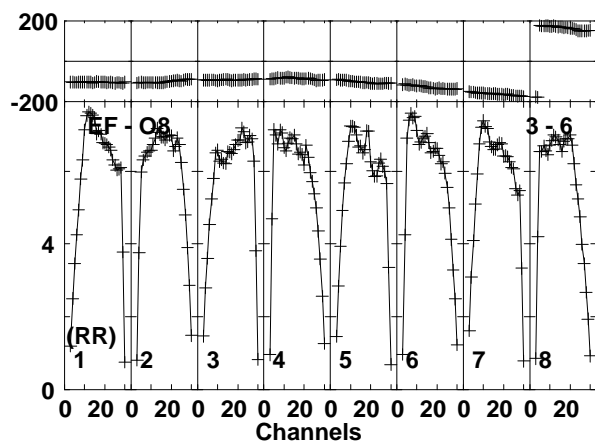
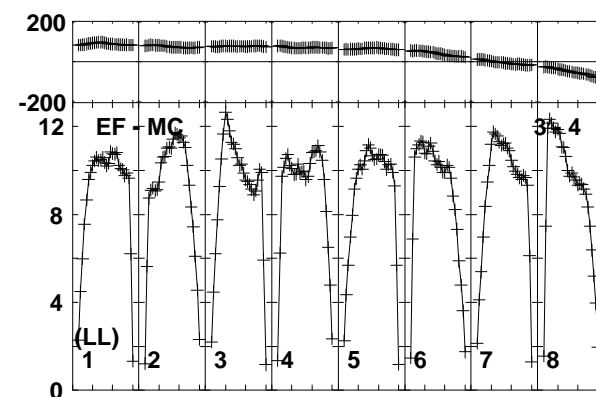
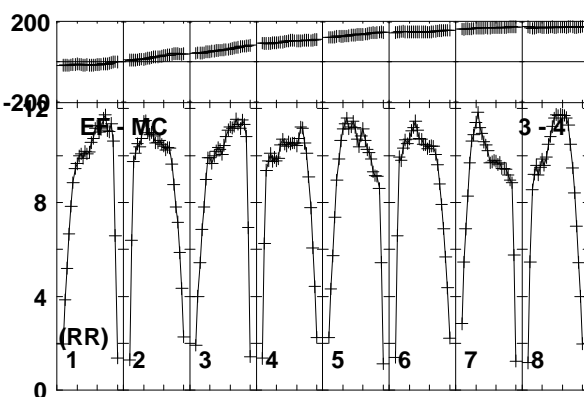
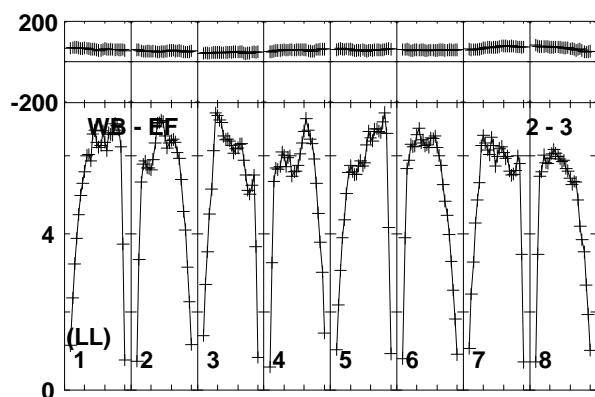
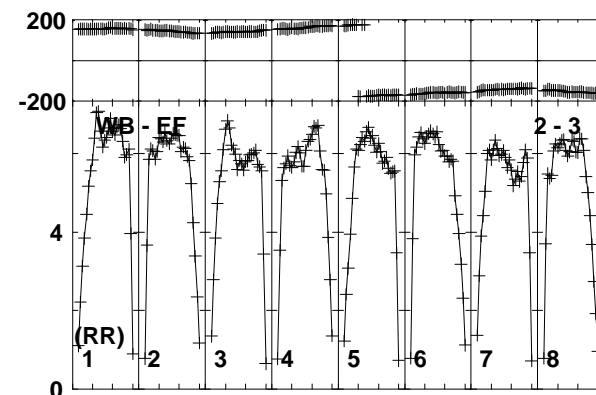
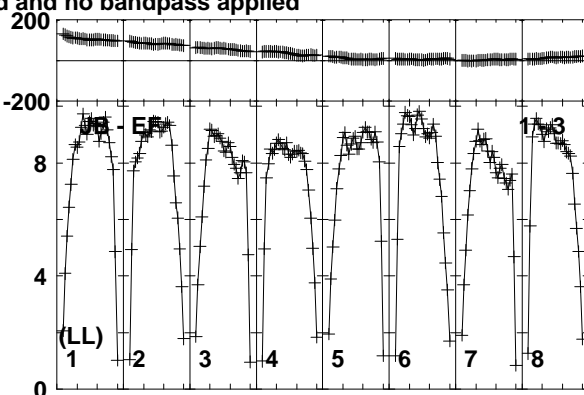
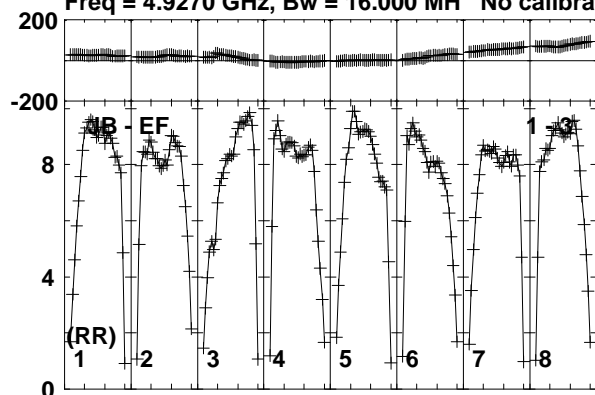

Lower frame: Milli Ampl Jy Top frame: Phas deg  
Vector averaged cross-power spectrum Baseline: JB (01) - EF (03)  
Timerange: 00/11:33:31 to 00/11:34:29



Plot file version 347 created 19-DEC-2018 17:58:37

J1619+2247 RY007C.UVDATA.1

Freq = 4.9270 GHz, Bw = 16.000 MH No calibration applied and no bandpass applied

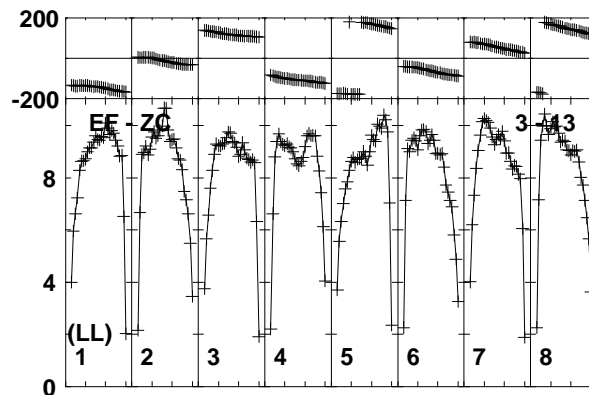
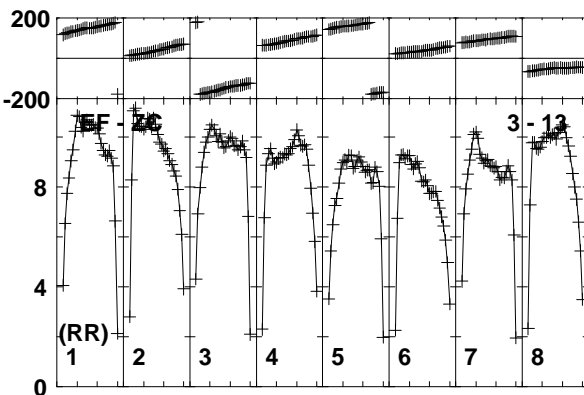
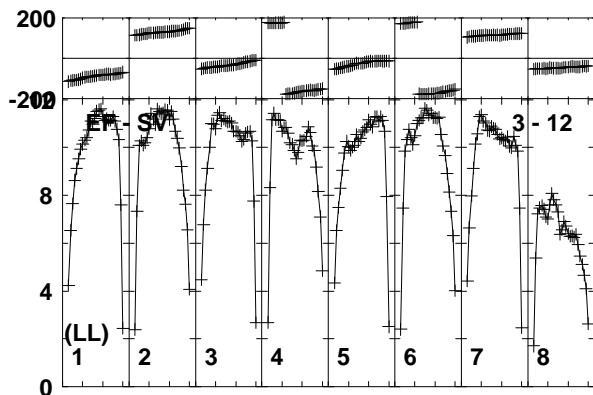
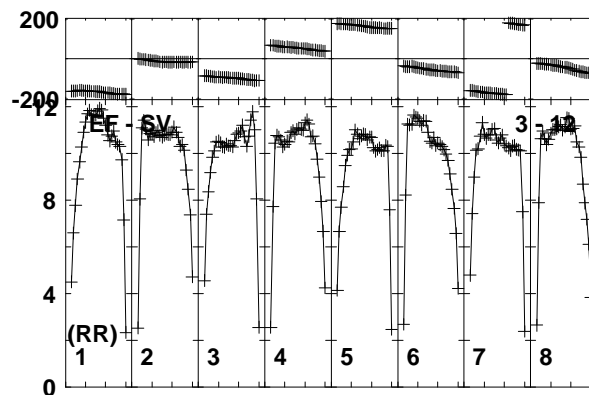
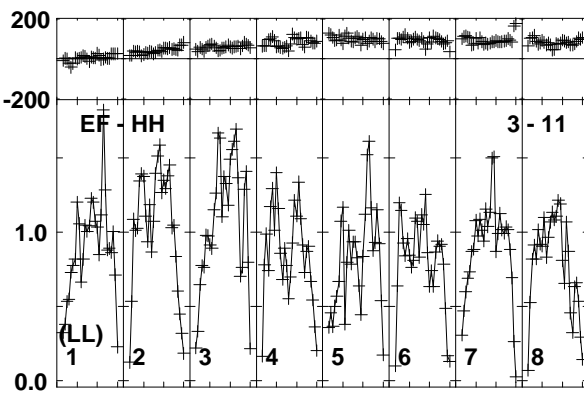
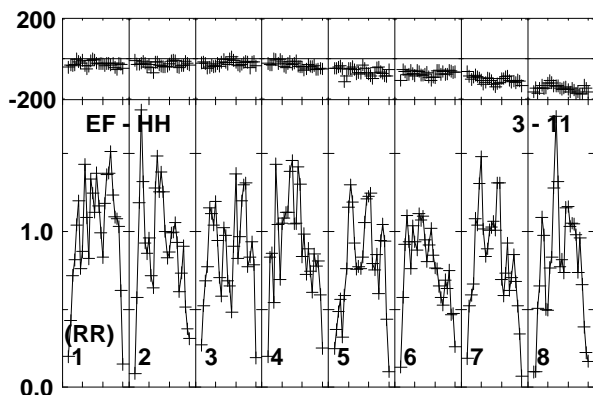
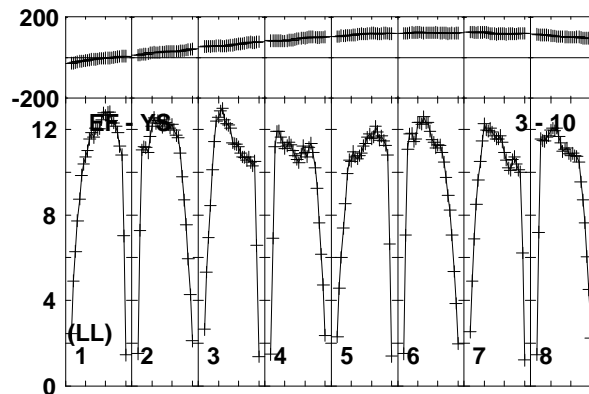
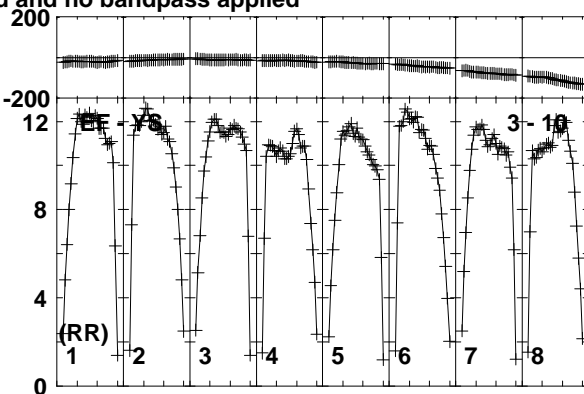
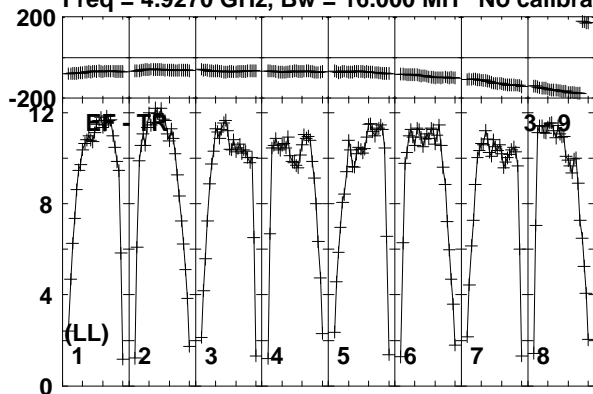

Lower frame: Milli Ampl Jy Top frame: Phas deg  
Vector averaged cross-power spectrum Baseline: EF (03) - TR (09)  
Timerange: 00/11:33:31 to 00/11:34:29

Plot file version 348 created 19-DEC-2018 17:58:37

J1619+2247 RY007C.UVDATA.1

Freq = 4.9270 GHz, Bw = 16.000 MH No calibration applied and no bandpass applied

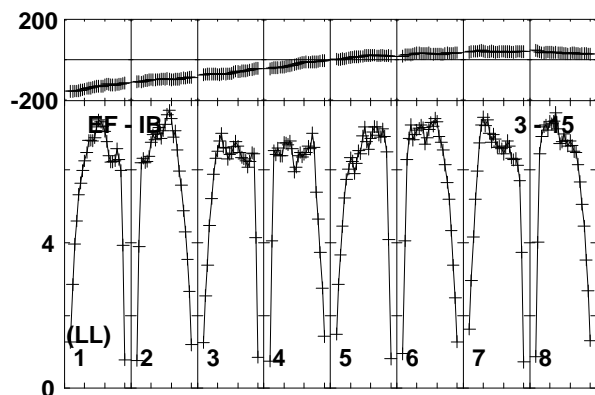
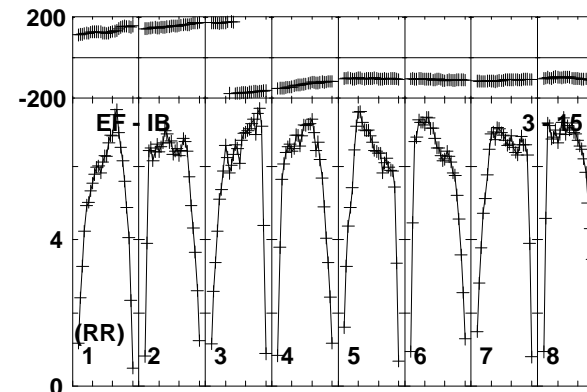
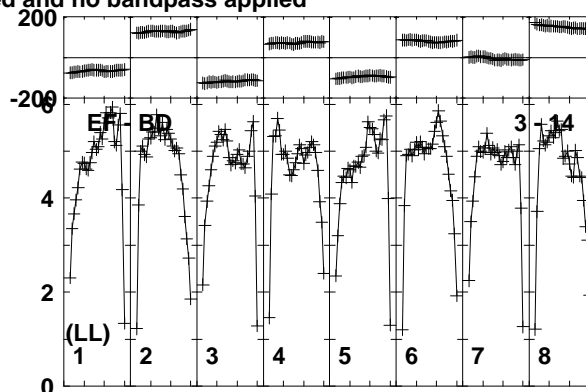
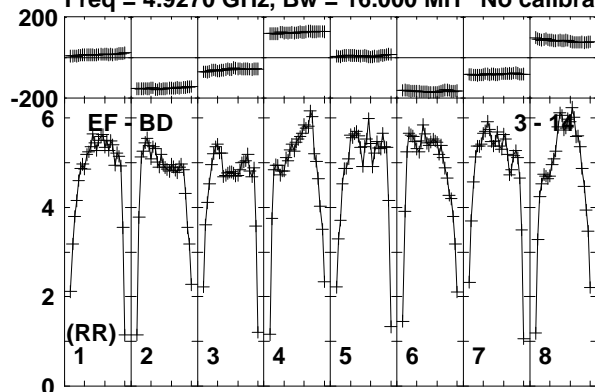

Lower frame: Milli Ampl Jy Top frame: Phas deg  
Vector averaged cross-power spectrum Baseline: EF (03) - BD (14)  
Timerange: 00/11:33:31 to 00/11:34:29

Plot file version 349 created 19-DEC-2018 17:58:37

VLA1 RY007C.UVDATA.1

Freq = 4.9270 GHz, Bw = 16.000 MH No calibration applied and no bandpass applied

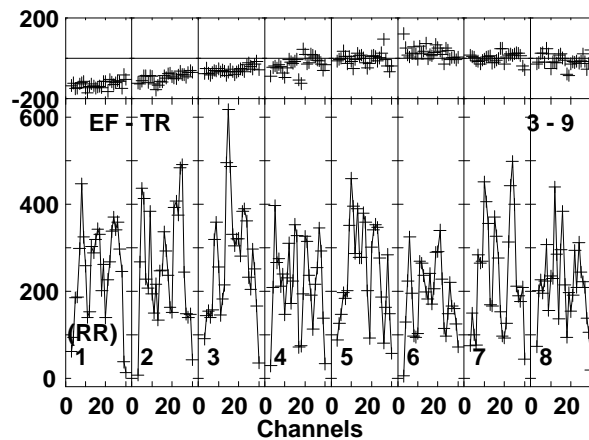
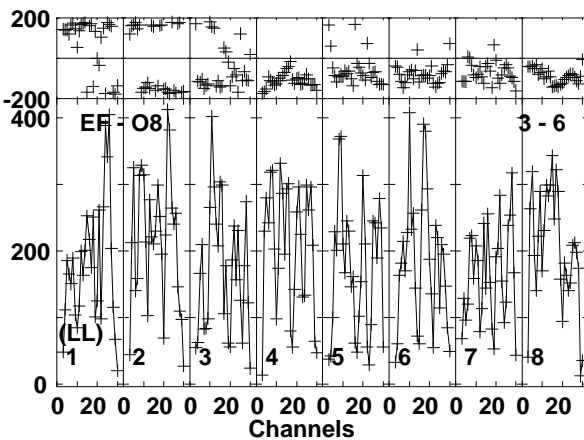
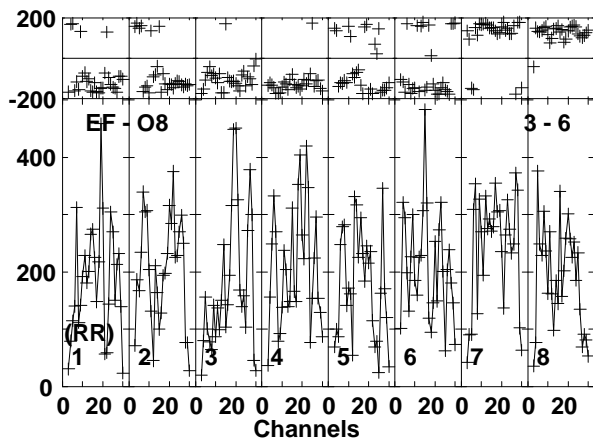
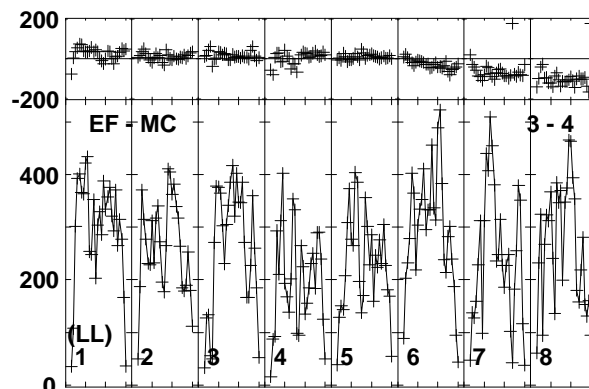
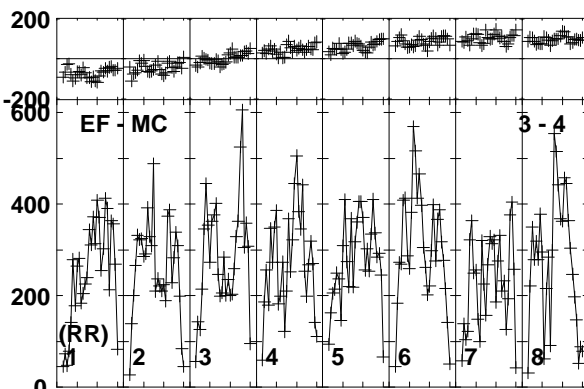
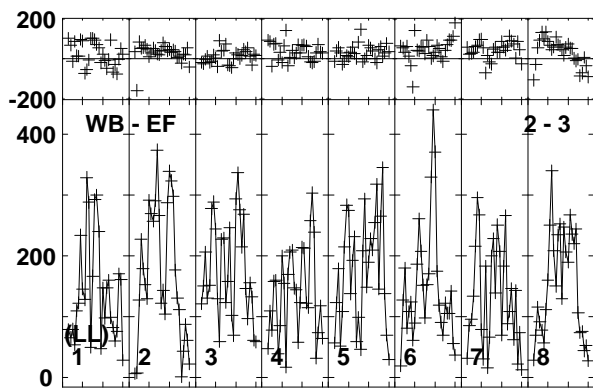
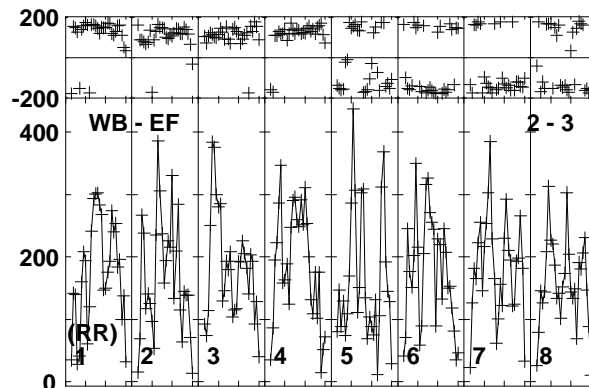
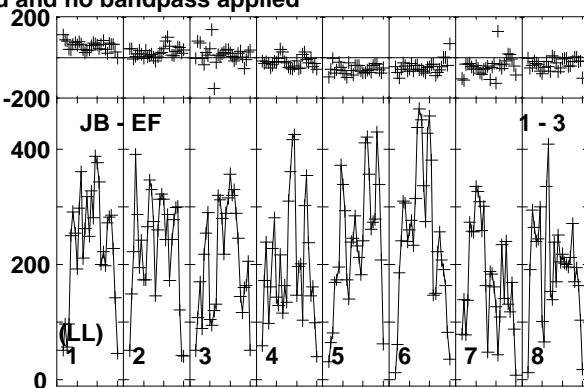
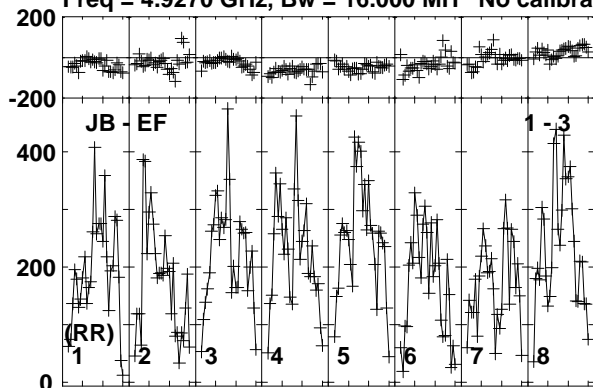

Lower frame: Micro Ampl Jy Top frame: Phas deg  
Vector averaged cross-power spectrum Baseline: JB (01) - EF (03)  
Timerange: 00/11:35:01 to 00/11:36:59

Plot file version 350 created 19-DEC-2018 17:58:37

VLA1 RY007C.UVDATA.1

Freq = 4.9270 GHz, Bw = 16.000 MH No calibration applied and no bandpass applied

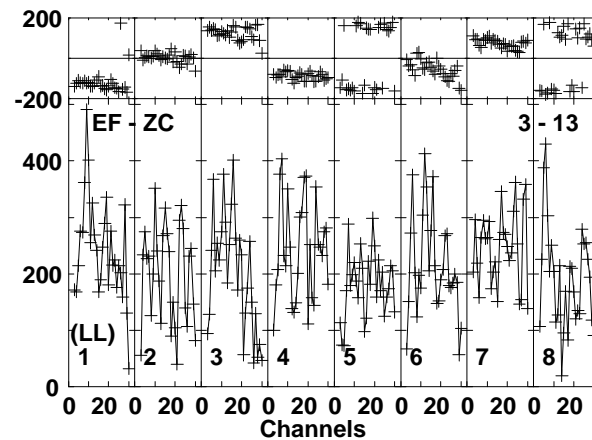
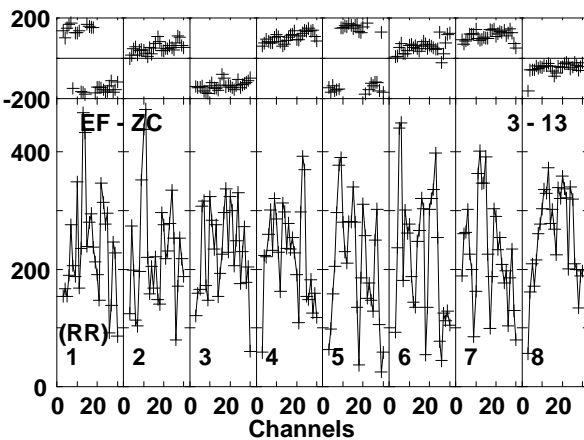
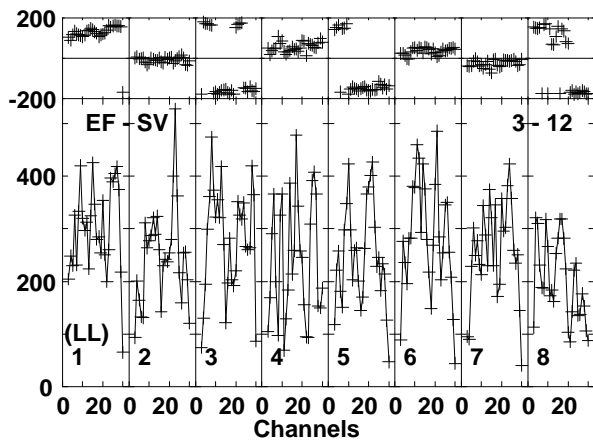
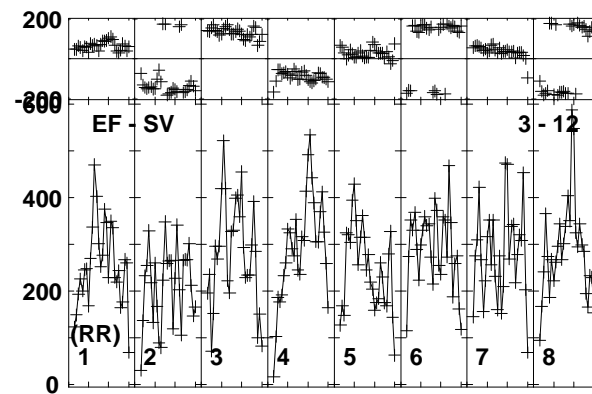
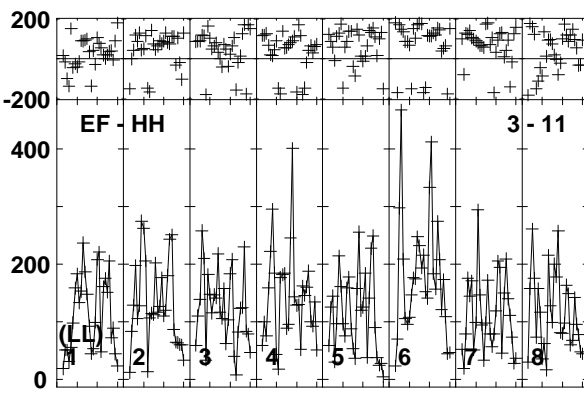
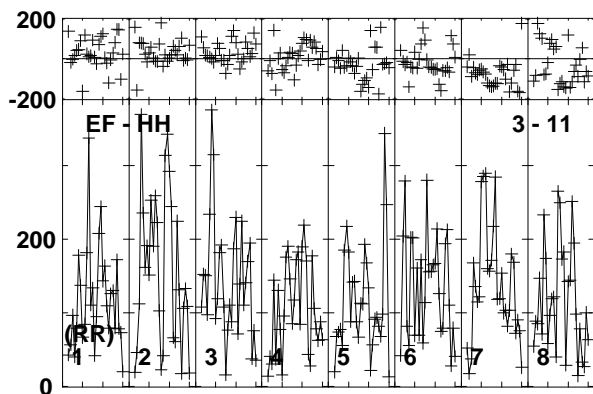
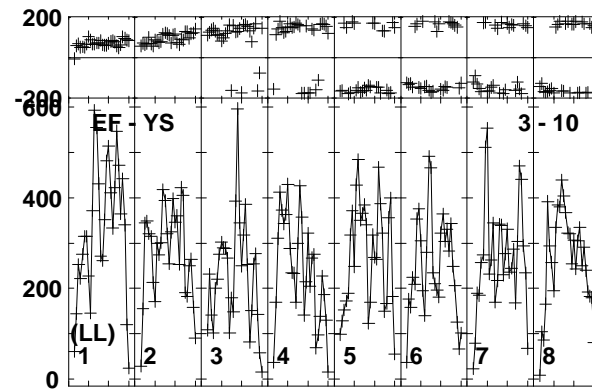
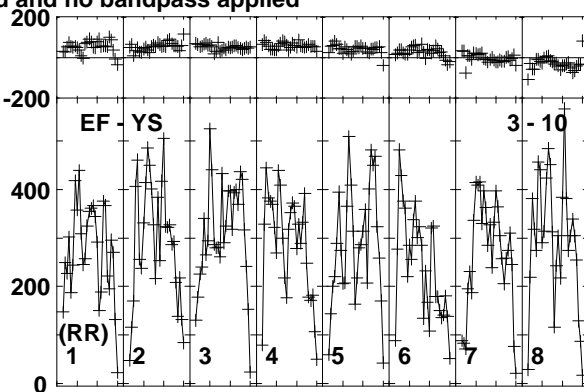
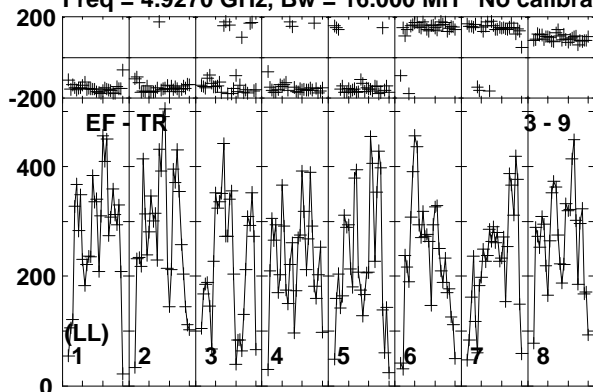

Lower frame: Micro Ampl Jy Top frame: Phas deg  
Vector averaged cross-power spectrum Baseline: EF (03) - TR (09)  
Timerange: 00/11:35:01 to 00/11:36:59

Plot file version 351 created 19-DEC-2018 17:58:37

VLA1 RY007C.UVDATA.1

Freq = 4.9270 GHz, Bw = 16.000 MH No calibration applied and no bandpass applied

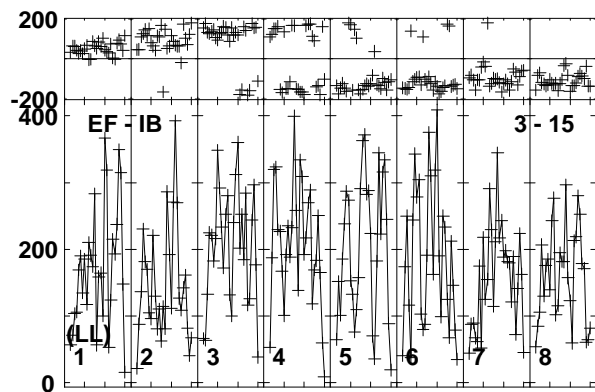
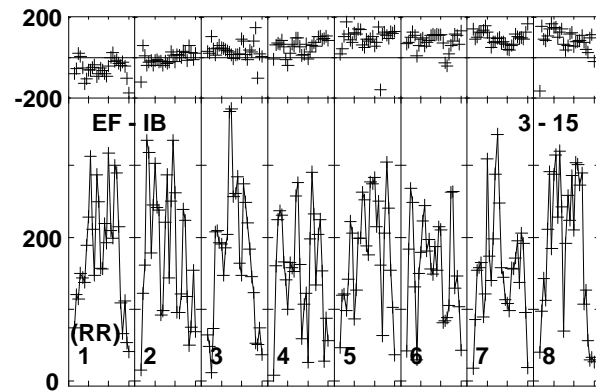
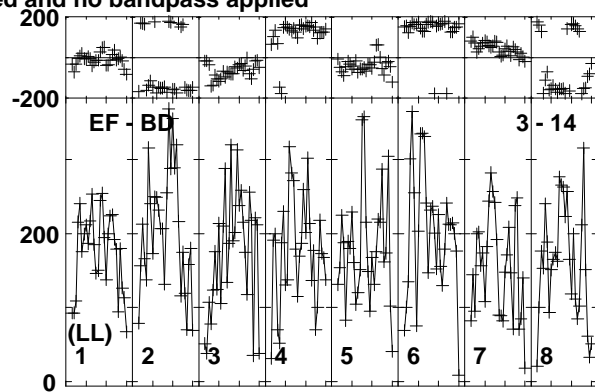
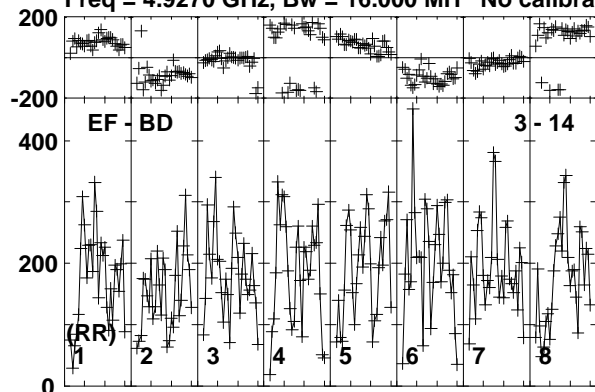

Lower frame: Micro Ampl Jy Top frame: Phas deg  
Vector averaged cross-power spectrum Baseline: EF (03) - BD (14)  
Timerange: 00/11:35:01 to 00/11:36:59

Plot file version 352 created 19-DEC-2018 17:58:37

J1619+2247 RY007C.UVDATA.1

Freq = 4.9270 GHz, Bw = 16.000 MH No calibration applied and no bandpass applied

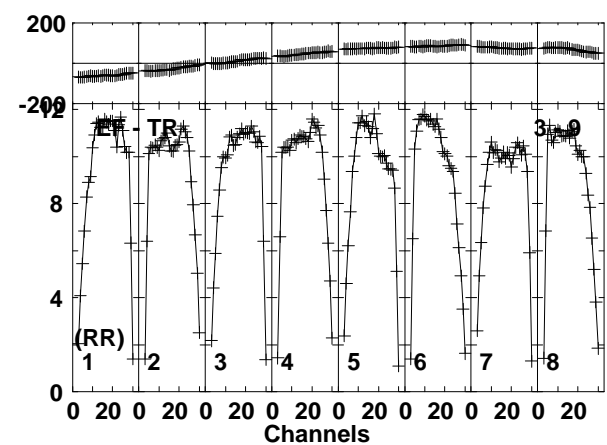
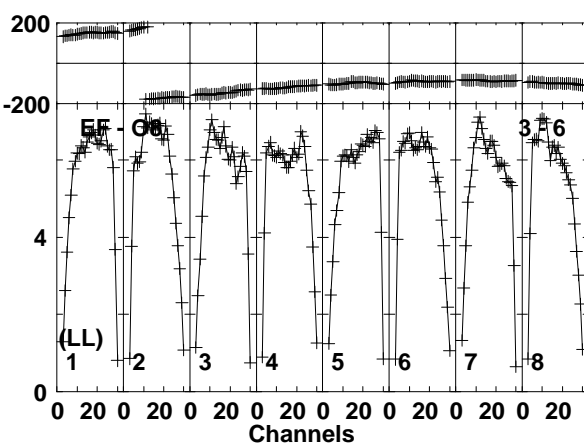
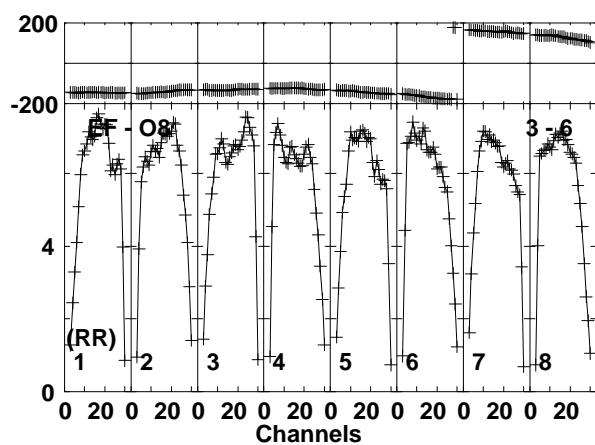
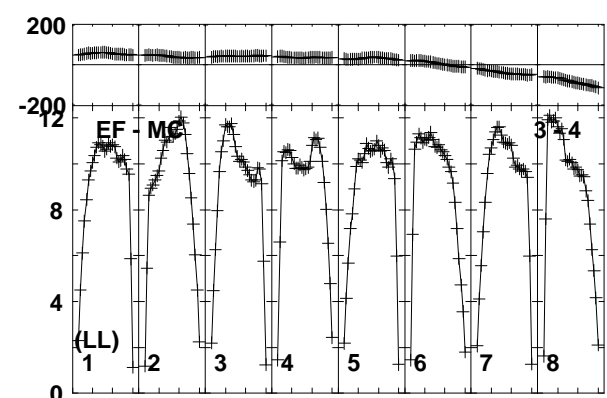
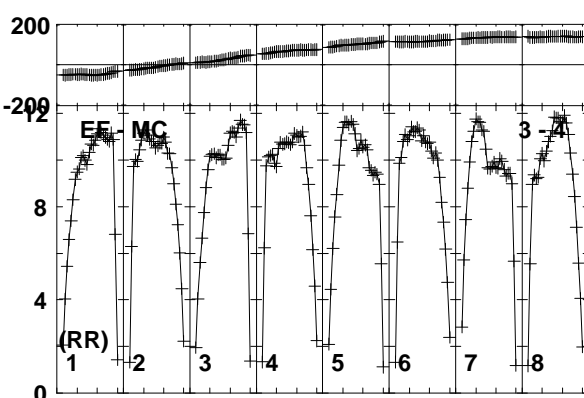
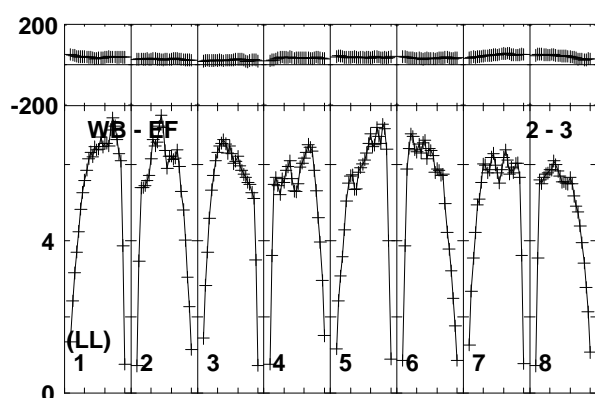
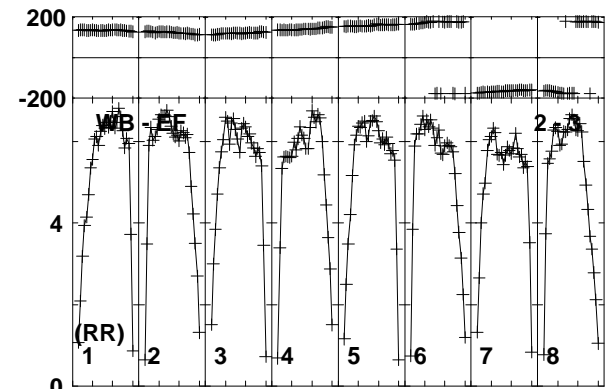
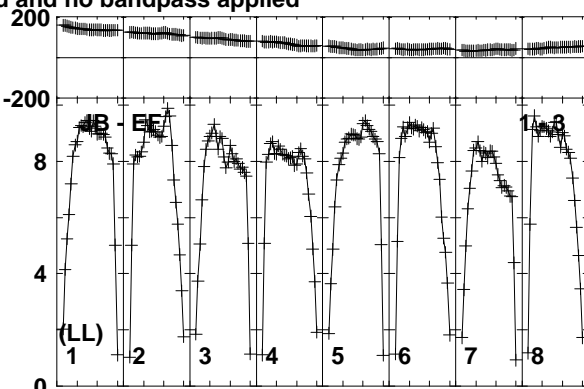
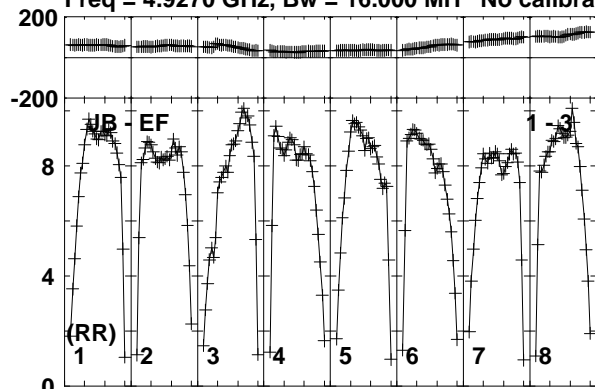

Lower frame: Milli Ampl Jy Top frame: Phas deg  
Vector averaged cross-power spectrum Baseline: JB (01) - EF (03)  
Timerange: 00/11:37:01 to 00/11:37:59

Plot file version 353 created 19-DEC-2018 17:58:37

J1619+2247 RY007C.UVDATA.1

Freq = 4.9270 GHz, Bw = 16.000 MH No calibration applied and no bandpass applied

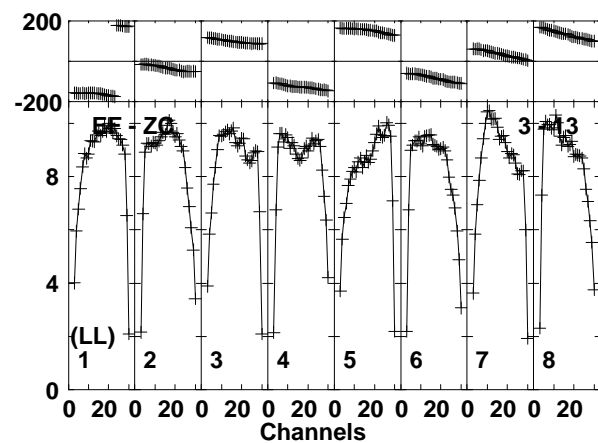
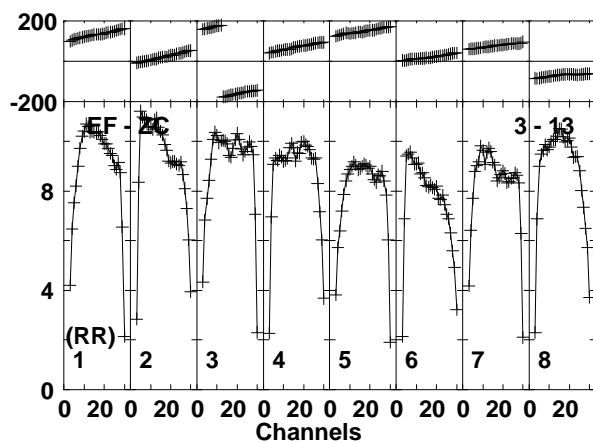
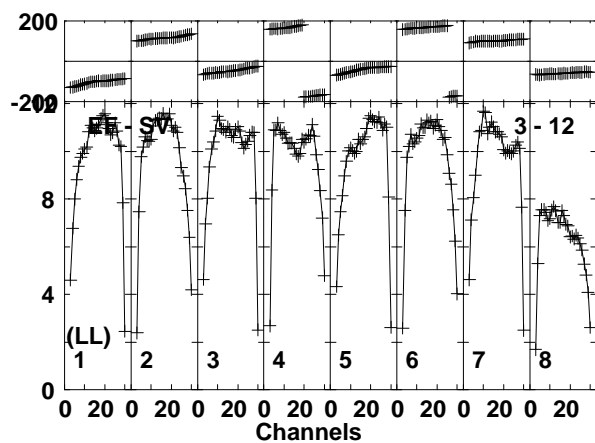
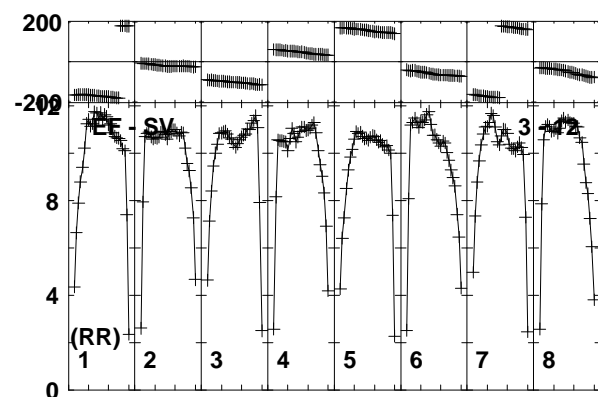
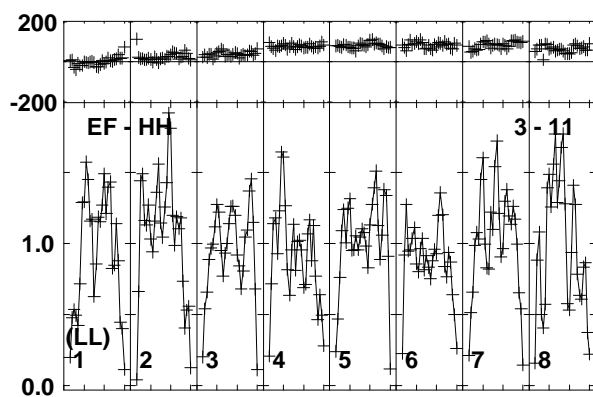
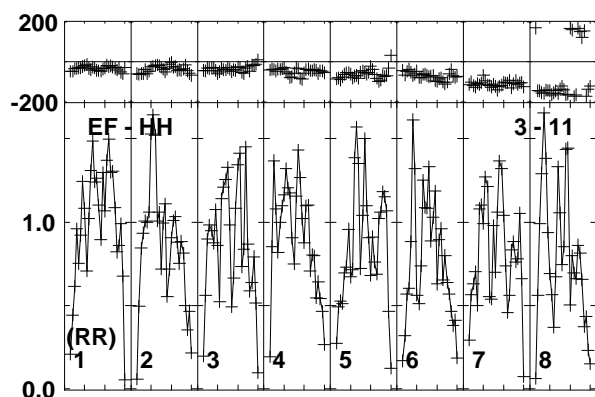
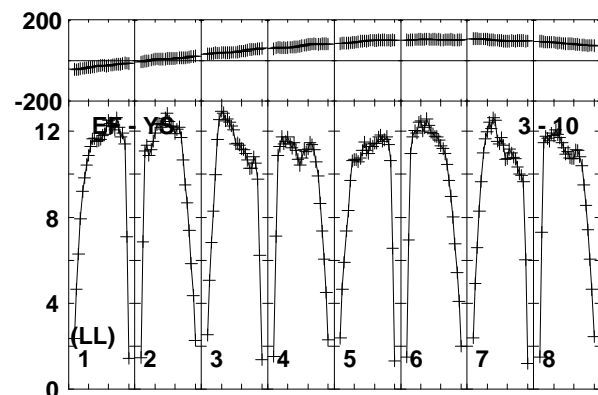
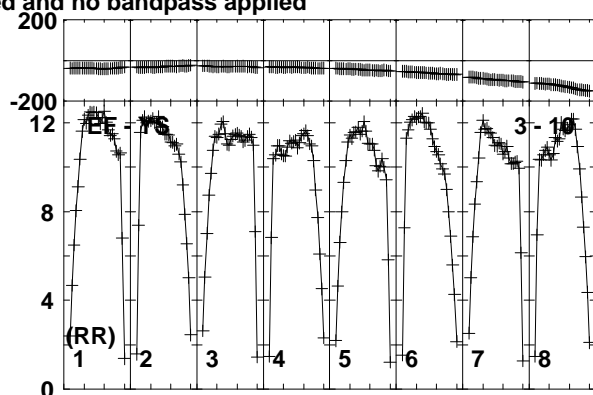
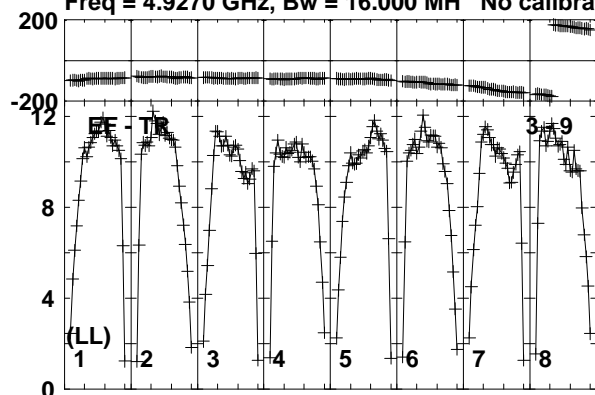

Lower frame: Milli Ampl Jy Top frame: Phas deg  
Vector averaged cross-power spectrum Baseline: EF (03) - TR (09)  
Timerange: 00/11:37:01 to 00/11:37:59

Plot file version 354 created 19-DEC-2018 17:58:37

J1619+2247 RY007C.UVDATA.1

Freq = 4.9270 GHz, Bw = 16.000 MH No calibration applied and no bandpass applied

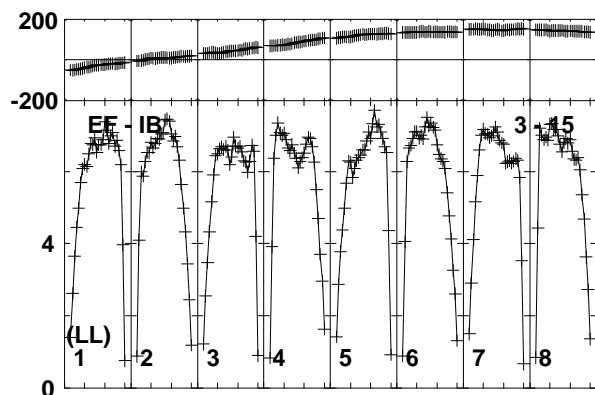
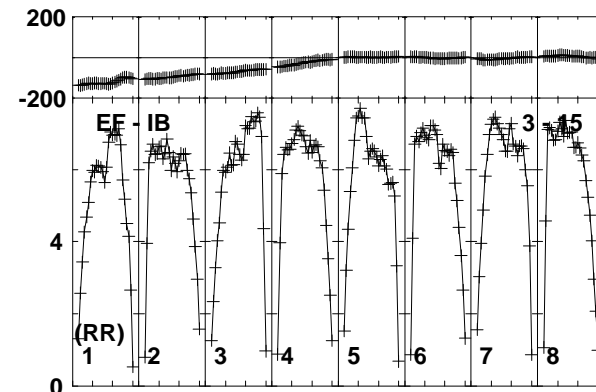
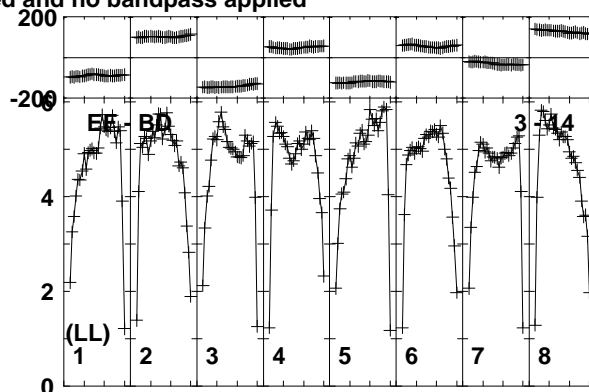
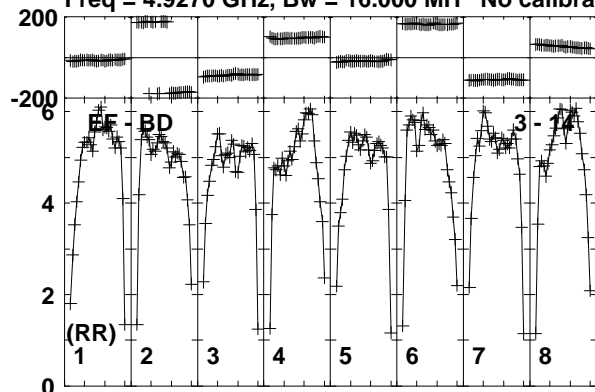

Lower frame: Milli Ampl Jy Top frame: Phas deg  
Vector averaged cross-power spectrum Baseline: EF (03) - BD (14)  
Timerange: 00/11:37:01 to 00/11:37:59



Plot file version 355 created 19-DEC-2018 17:58:37

AT2018\_RY007C.UVDATA.1

Freq = 4.9270 GHz, Bw = 16.000 MH No calibration applied and no bandpass applied

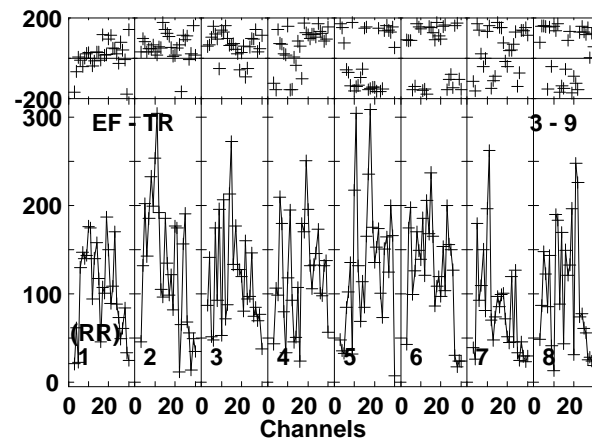
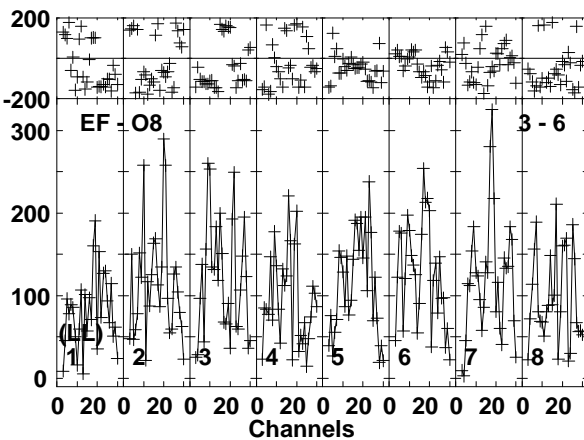
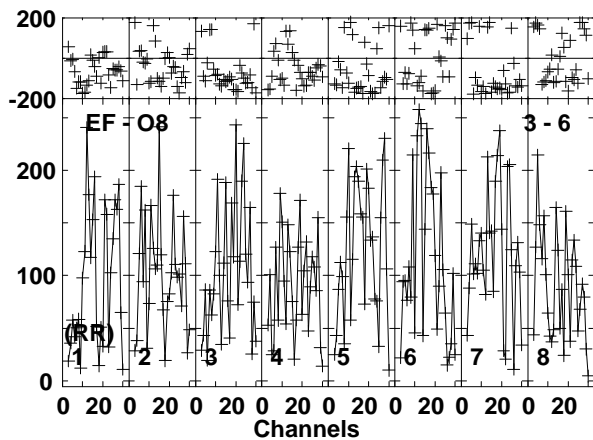
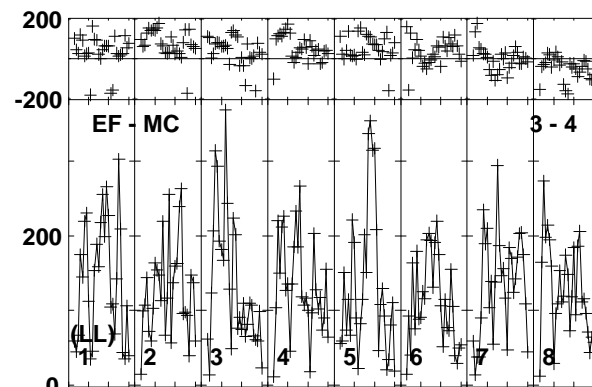
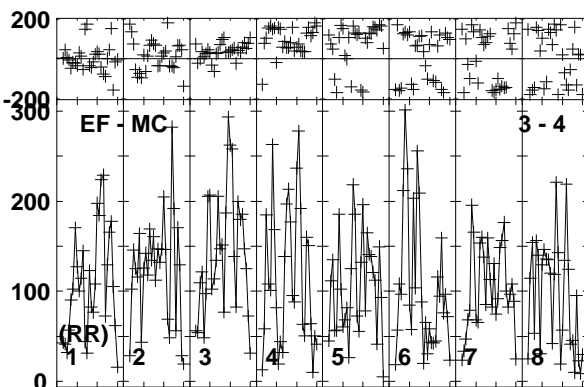
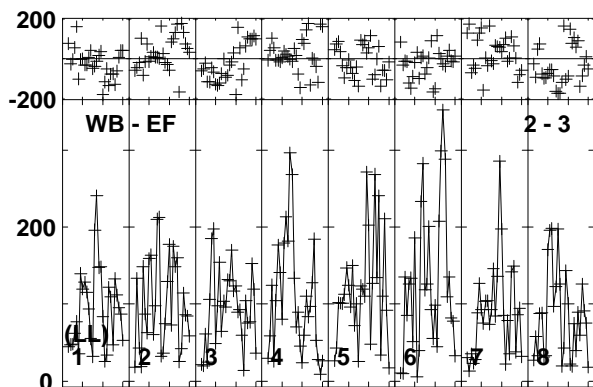
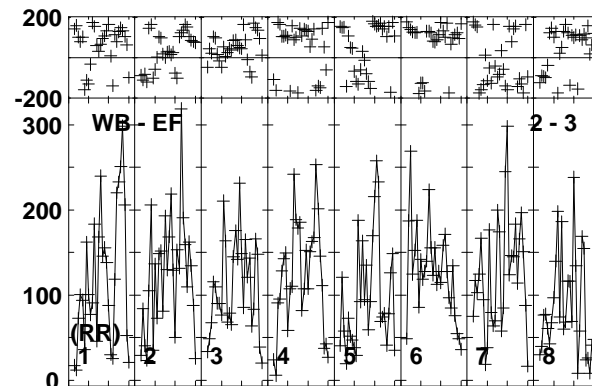
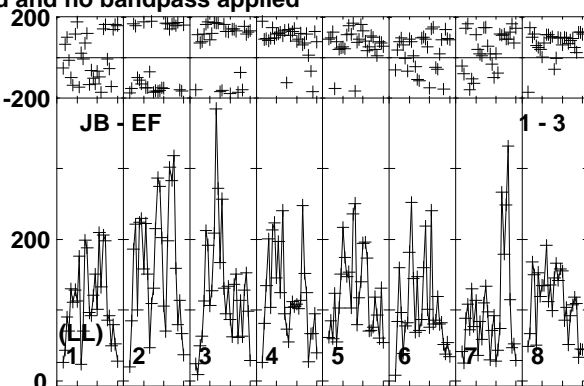
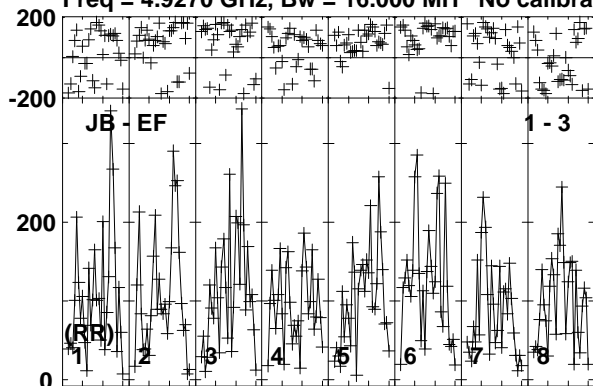

Lower frame: Micro Ampl Jy Top frame: Phas deg  
Vector averaged cross-power spectrum Baseline: JB (01) - EF (03)  
Timerange: 00/11:38:01 to 00/11:40:59

Plot file version 356 created 19-DEC-2018 17:58:37

AT2018\_RY007C.UVDATA.1

Freq = 4.9270 GHz, Bw = 16.000 MH No calibration applied and no bandpass applied

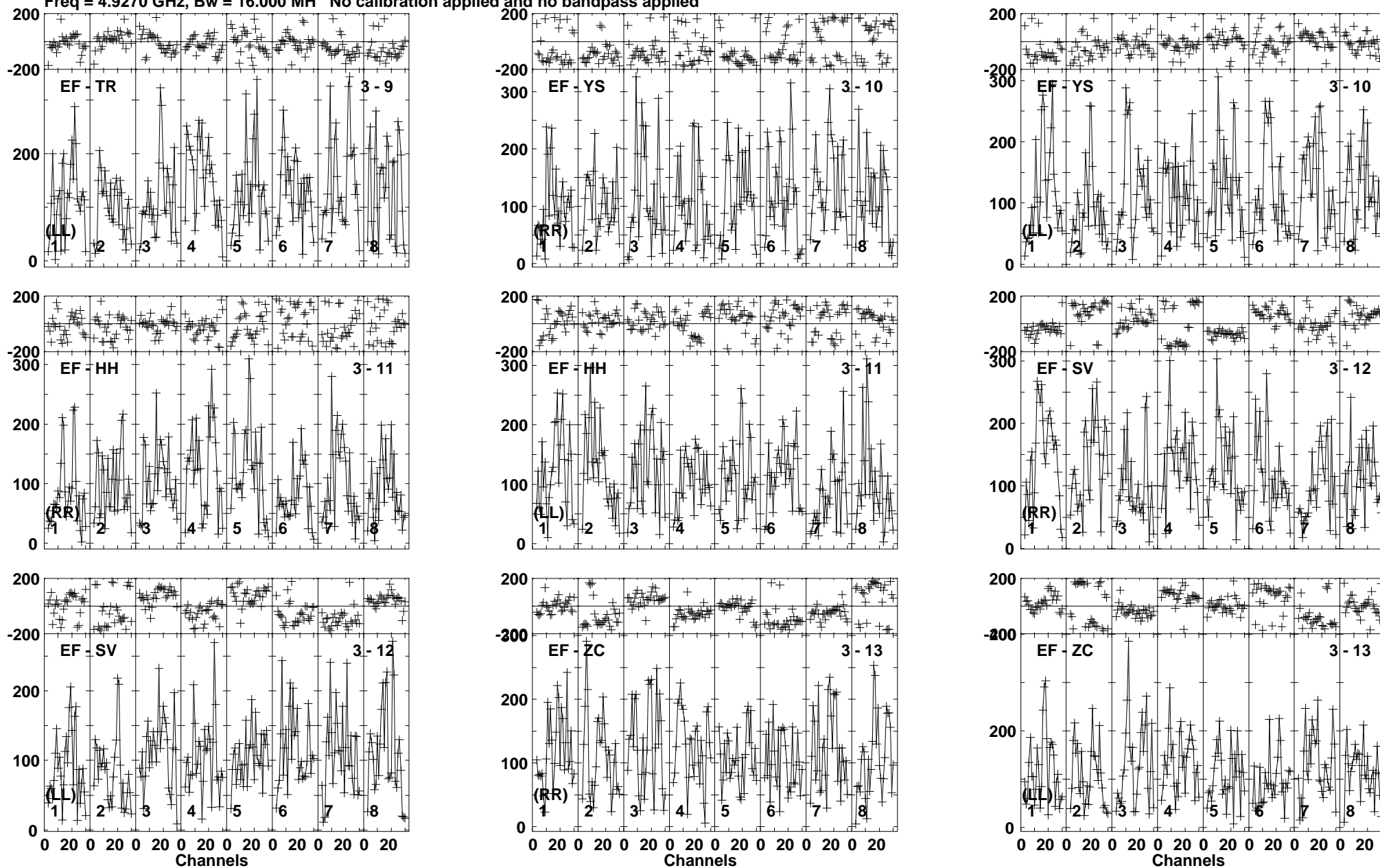

Lower frame: Micro Ampl Jy Top frame: Phas deg  
Vector averaged cross-power spectrum Baseline: EF (03) - TR (09)  
Timerange: 00/11:38:01 to 00/11:40:59

Plot file version 357 created 19-DEC-2018 17:58:37

AT2018\_RY007C.UVDATA.1

Freq = 4.9270 GHz, Bw = 16.000 MH No calibration applied and no bandpass applied

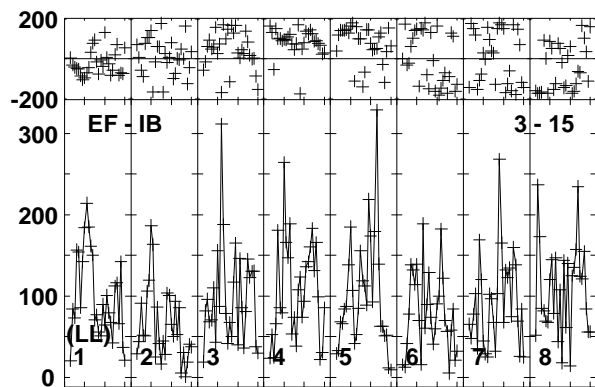
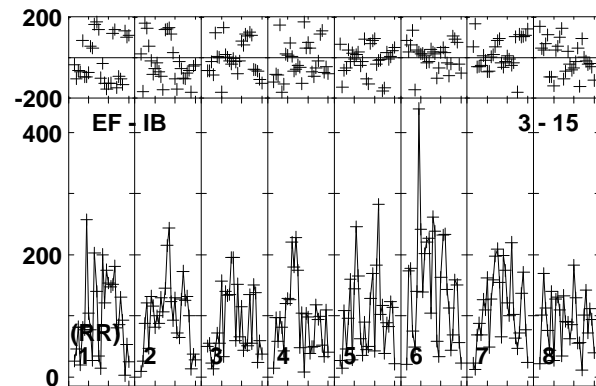
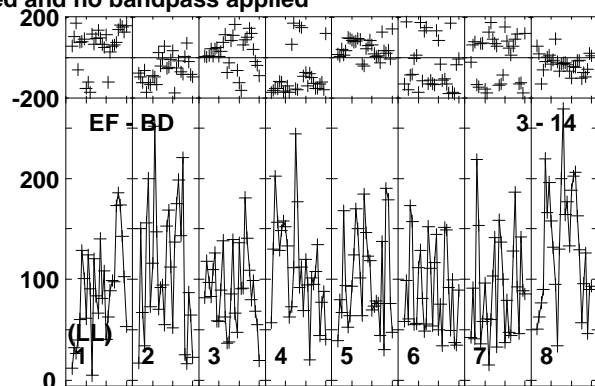
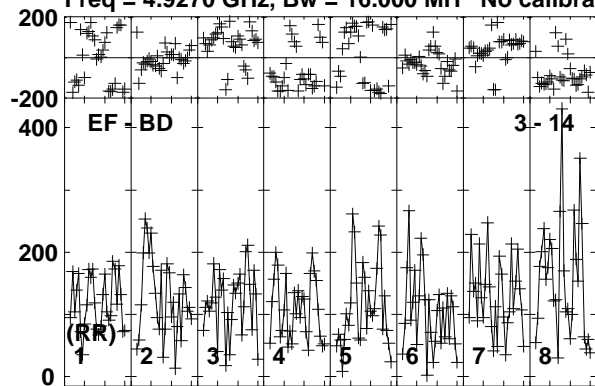

Lower frame: Micro Ampl Jy Top frame: Phas deg  
Vector averaged cross-power spectrum Baseline: EF (03) - BD (14)  
Timerange: 00/11:38:01 to 00/11:40:59

Plot file version 358 created 19-DEC-2018 17:58:37

J1619+2247 RY007C.UVDATA.1

Freq = 4.9270 GHz, Bw = 16.000 MH No calibration applied and no bandpass applied

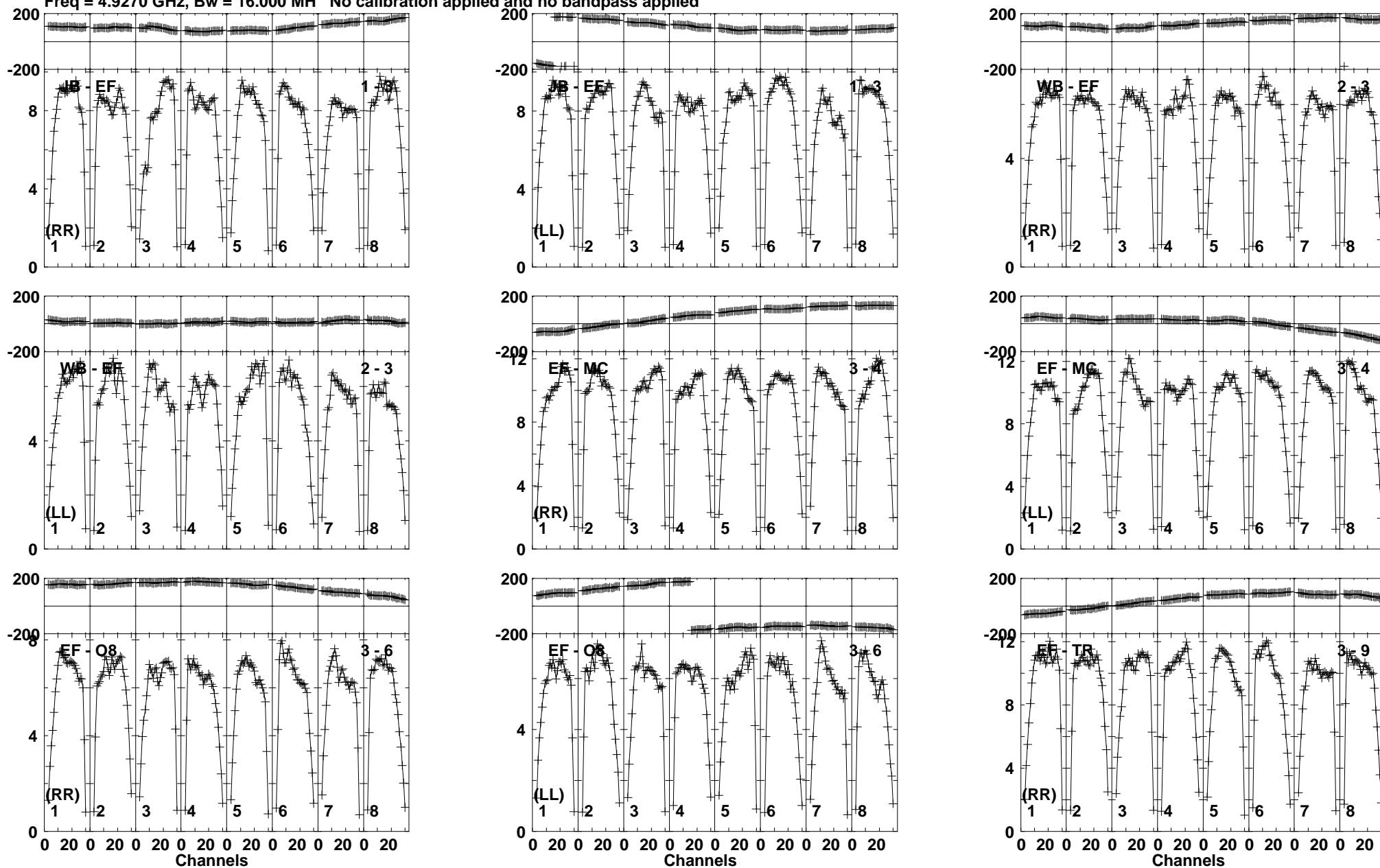

Lower frame: Milli Ampl Jy Top frame: Phas deg  
Vector averaged cross-power spectrum Baseline: JB (01) - EF (03)  
Timerange: 00/11:41:01 to 00/11:41:59

Plot file version 359 created 19-DEC-2018 17:58:37

J1619+2247 RY007C.UVDATA.1

Freq = 4.9270 GHz, Bw = 16.000 MH No calibration applied and no bandpass applied

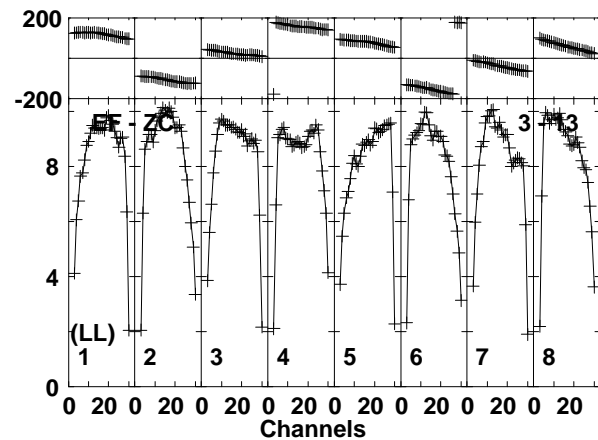
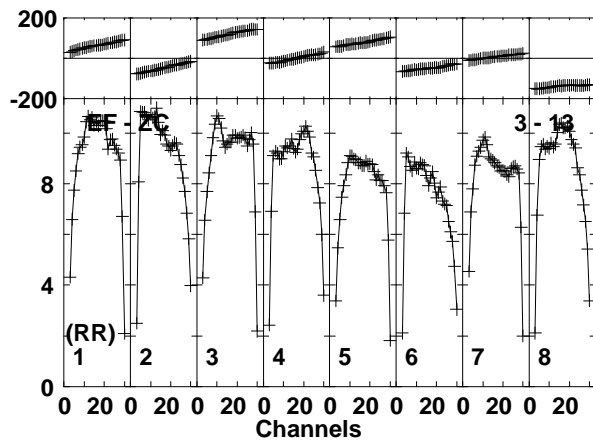
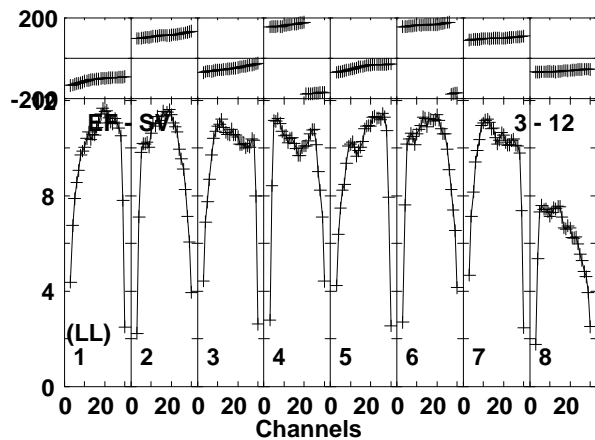
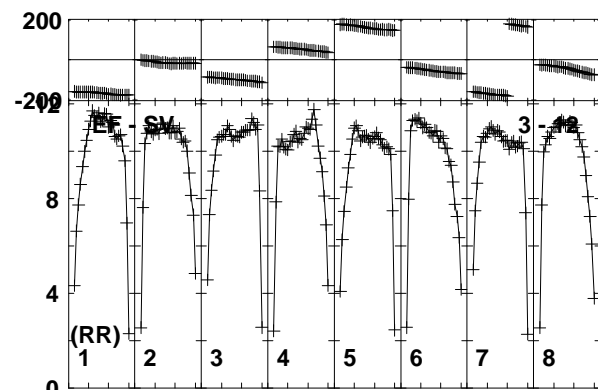
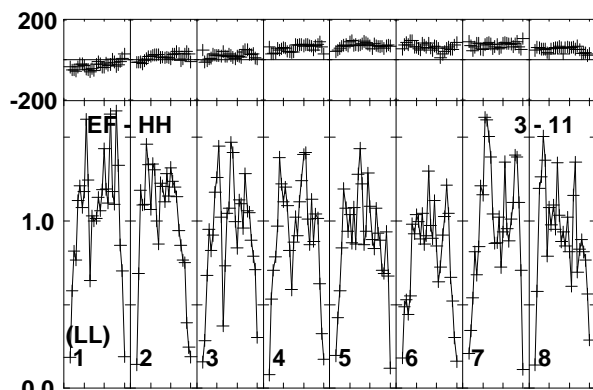
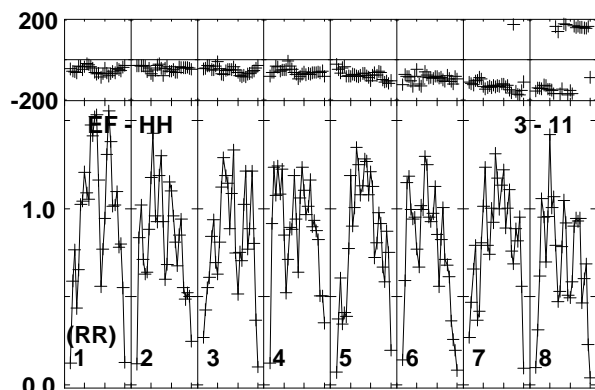
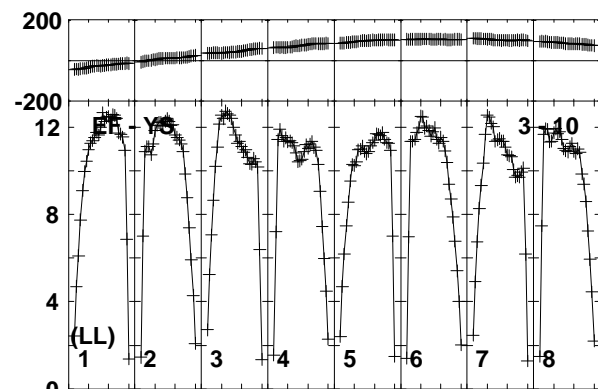
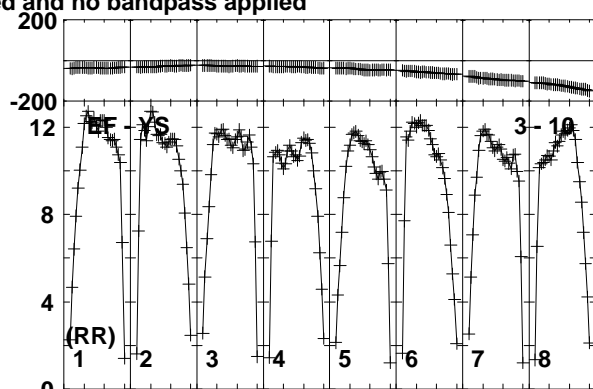
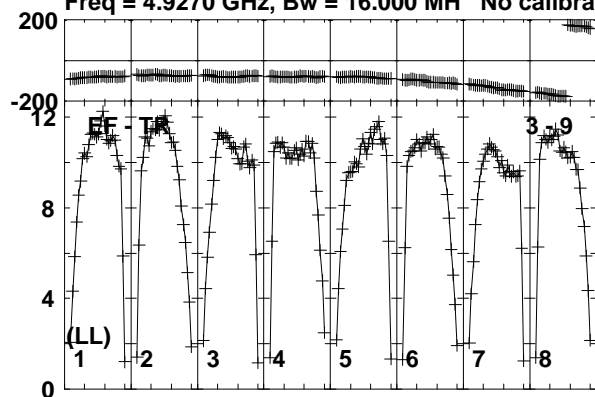

Lower frame: Milli Ampl Jy Top frame: Phas deg  
Vector averaged cross-power spectrum Baseline: EF (03) - TR (09)  
Timerange: 00/11:41:01 to 00/11:41:59

Plot file version 360 created 19-DEC-2018 17:58:37

J1619+2247 RY007C.UVDATA.1

Freq = 4.9270 GHz, Bw = 16.000 MH No calibration applied and no bandpass applied

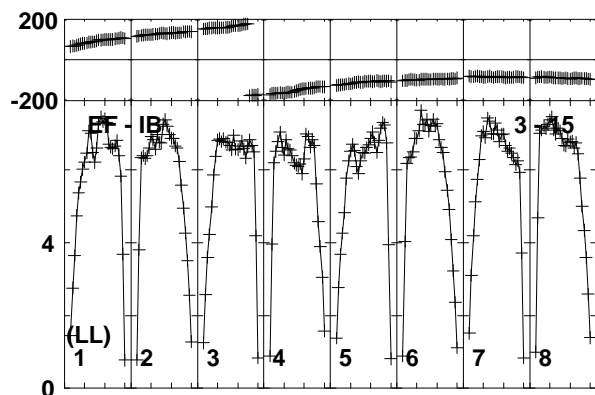
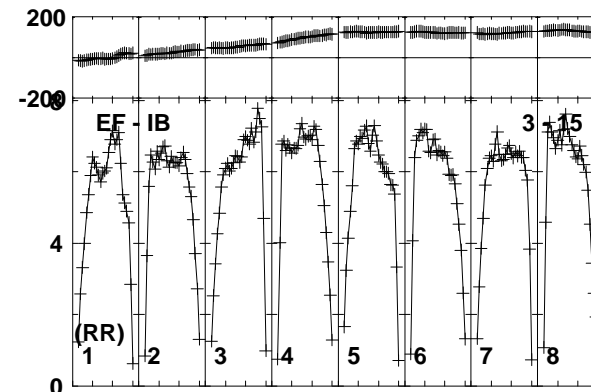
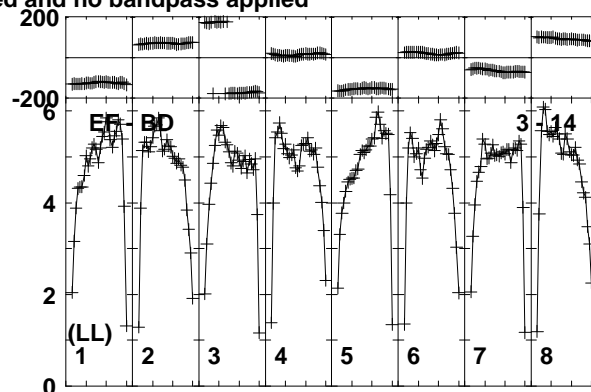
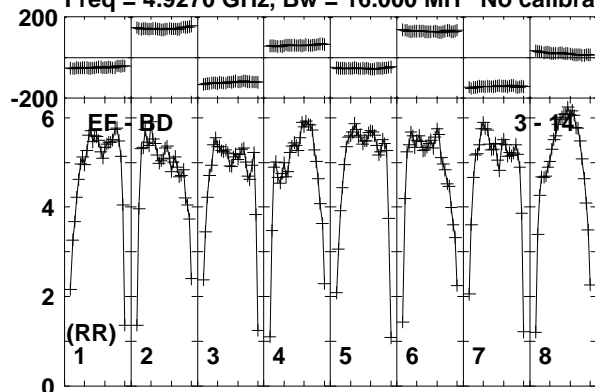

Lower frame: Milli Ampl Jy Top frame: Phas deg  
Vector averaged cross-power spectrum Baseline: EF (03) - BD (14)  
Timerange: 00/11:41:01 to 00/11:41:59

Plot file version 361 created 19-DEC-2018 17:58:37

AT2018\_RY007C.UVDATA.1

Freq = 4.9270 GHz, Bw = 16.000 MH No calibration applied and no bandpass applied

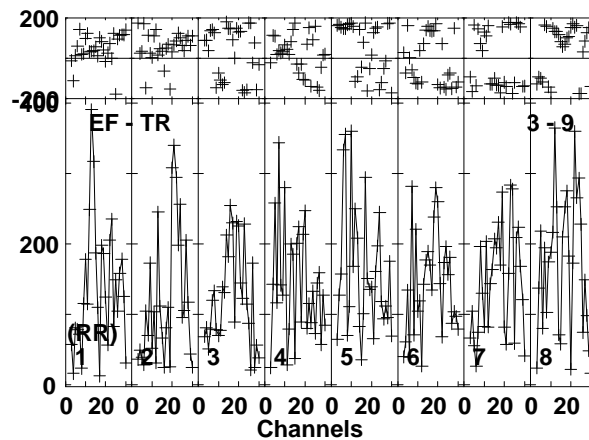
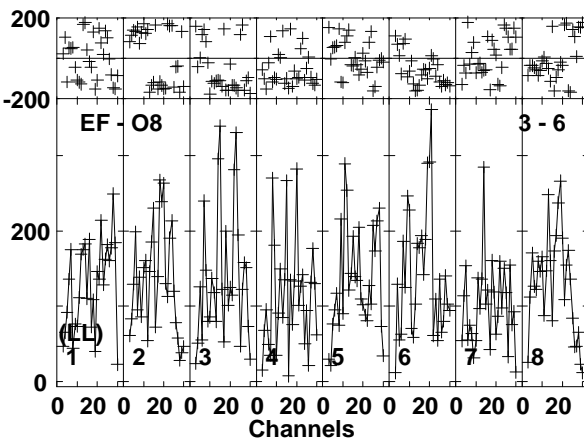
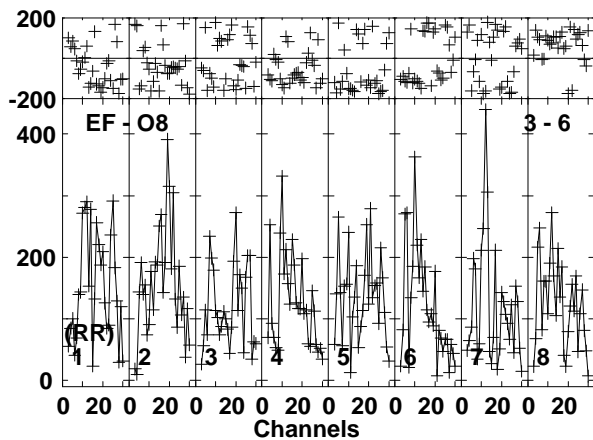
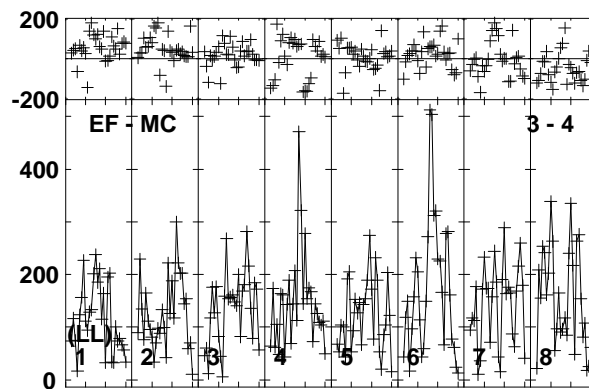
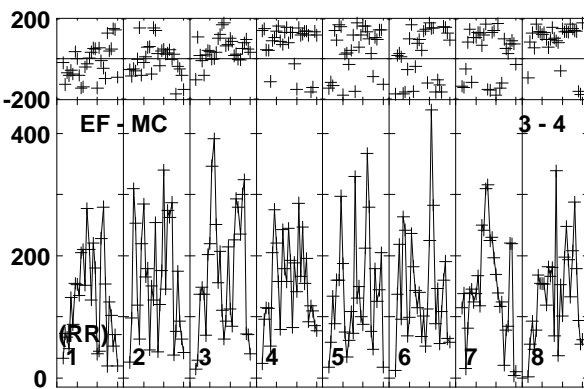
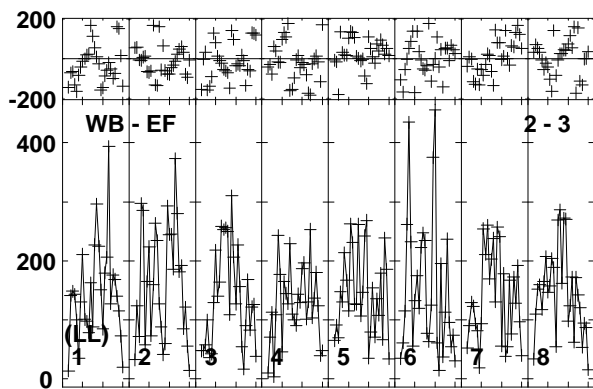
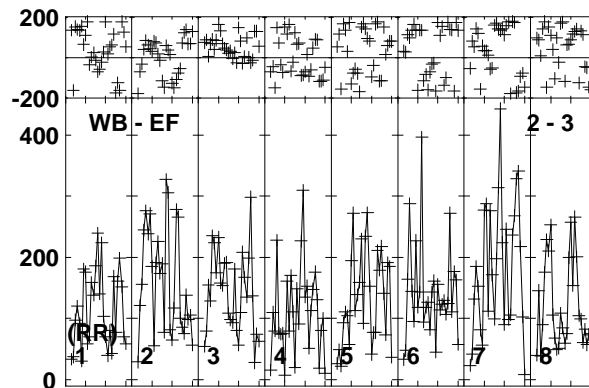
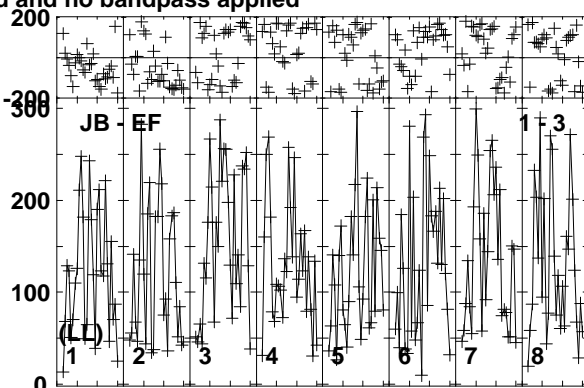
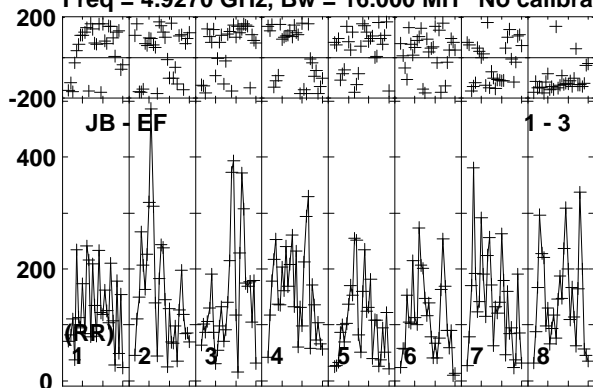

Lower frame: Micro Ampl Jy Top frame: Phas deg  
Vector averaged cross-power spectrum Baseline: JB (01) - EF (03)  
Timerange: 00/11:42:01 to 00/11:43:59

Plot file version 362 created 19-DEC-2018 17:58:37

AT2018\_RY007C.UVDATA.1

Freq = 4.9270 GHz, Bw = 16.000 MH No calibration applied and no bandpass applied

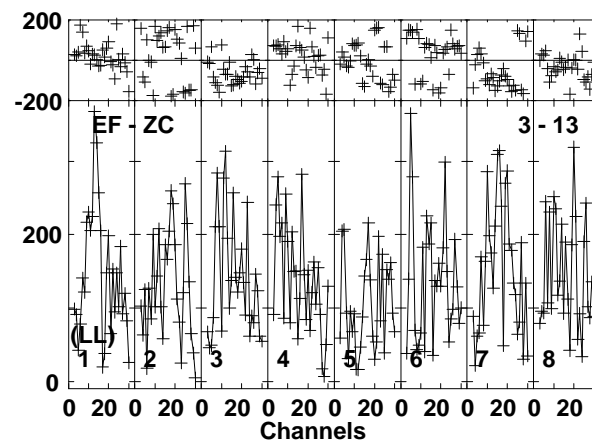
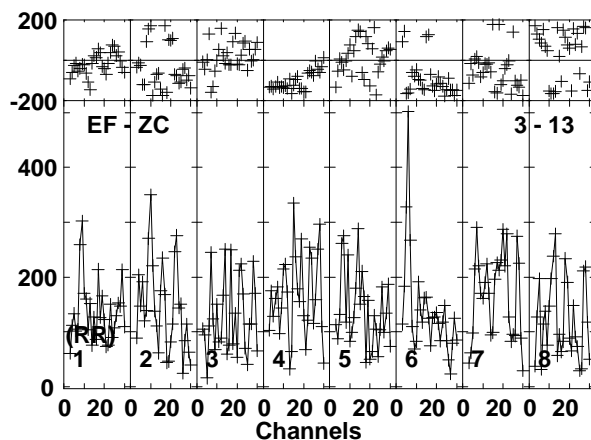
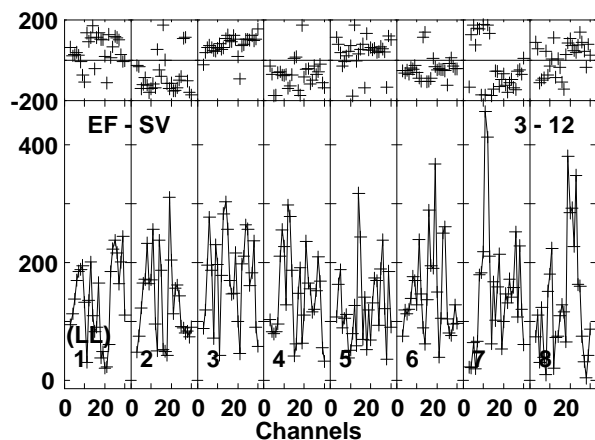
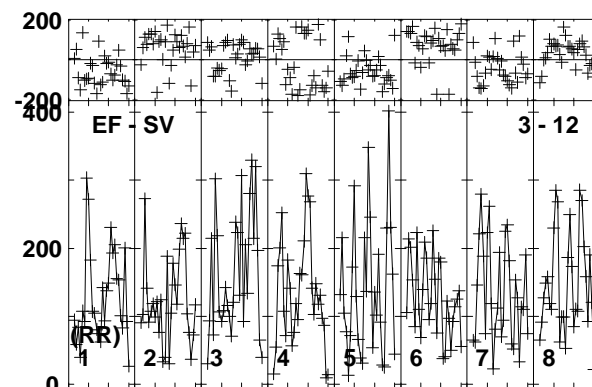
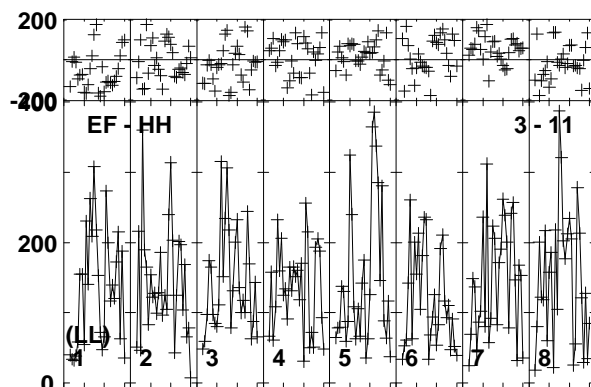
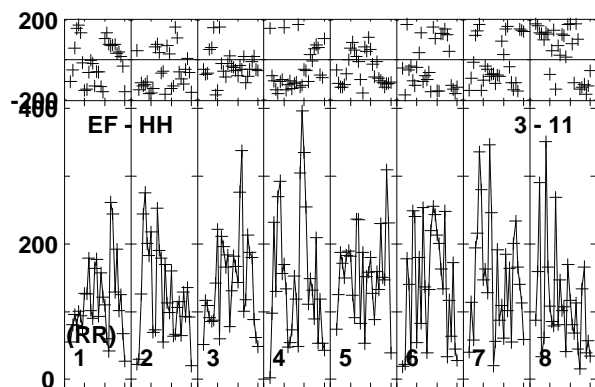
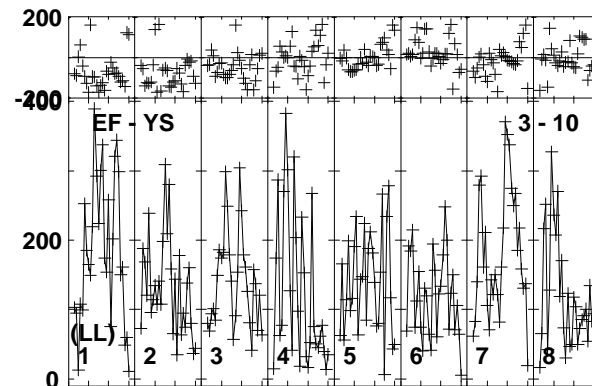
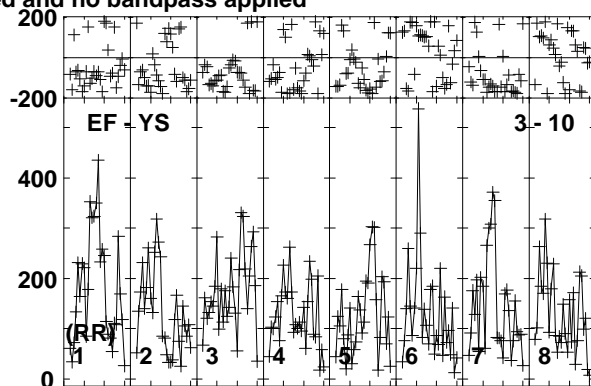
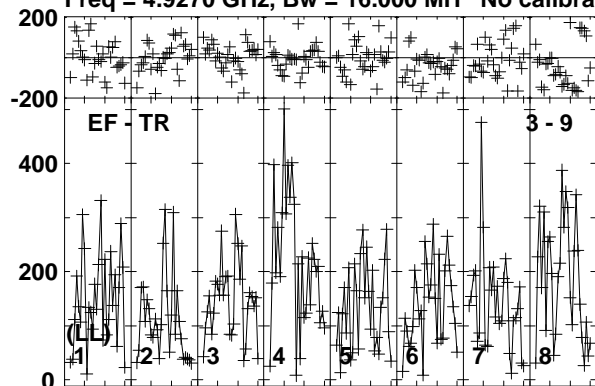

Lower frame: Micro Ampl Jy Top frame: Phas deg  
Vector averaged cross-power spectrum Baseline: EF (03) - TR (09)  
Timerange: 00/11:42:01 to 00/11:43:59



Plot file version 363 created 19-DEC-2018 17:58:37

AT2018\_RY007C.UVDATA.1

Freq = 4.9270 GHz, Bw = 16.000 MH No calibration applied and no bandpass applied

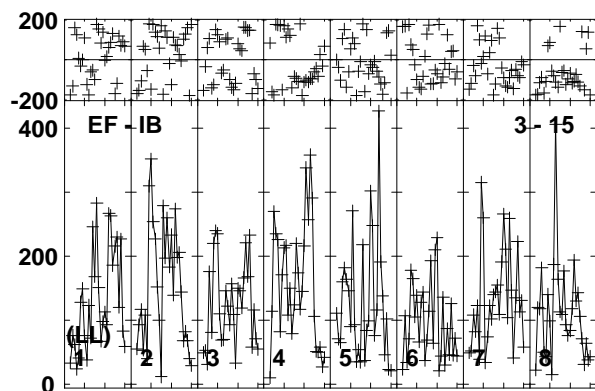
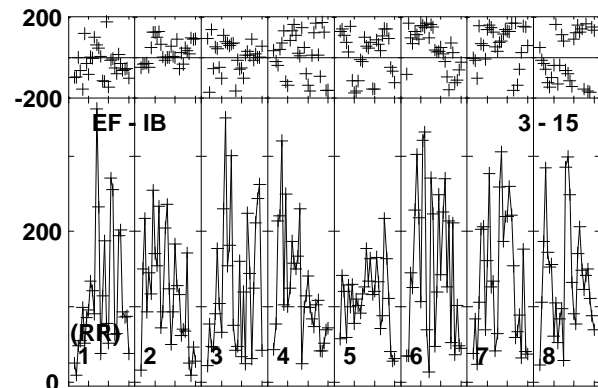
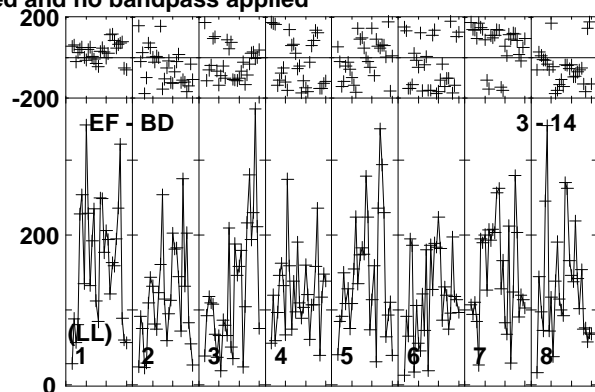
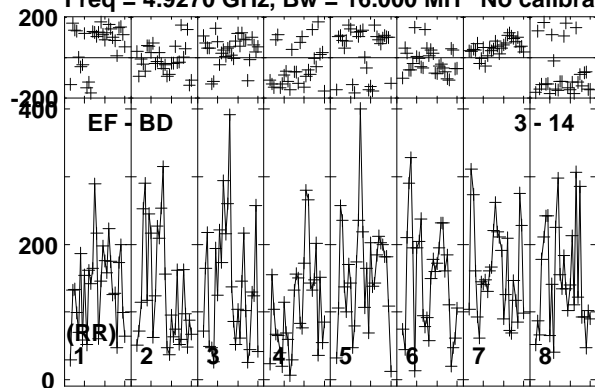

Lower frame: Micro Ampl Jy Top frame: Phas deg  
Vector averaged cross-power spectrum Baseline: EF (03) - BD (14)  
Timerange: 00/11:42:01 to 00/11:43:59

Plot file version 364 created 19-DEC-2018 17:58:37

VLA2 RY007C.UVDATA.1

Freq = 4.9270 GHz, Bw = 16.000 MH No calibration applied and no bandpass applied

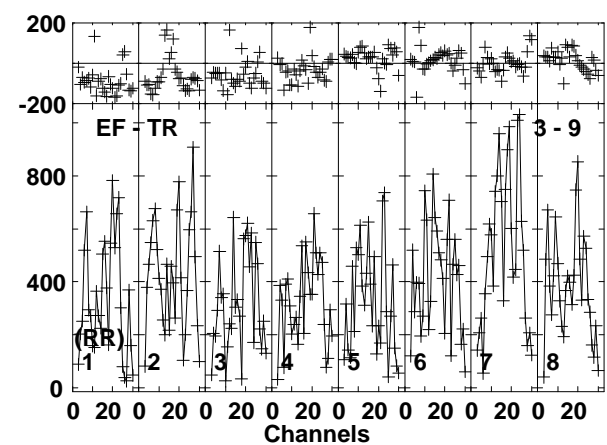
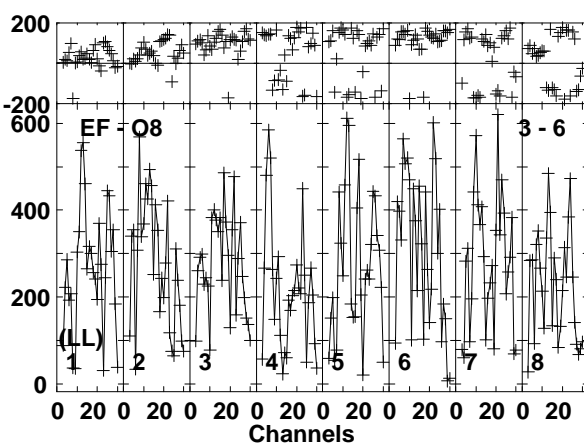
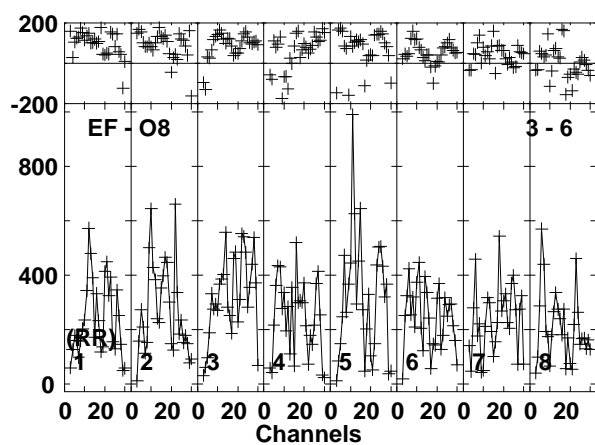
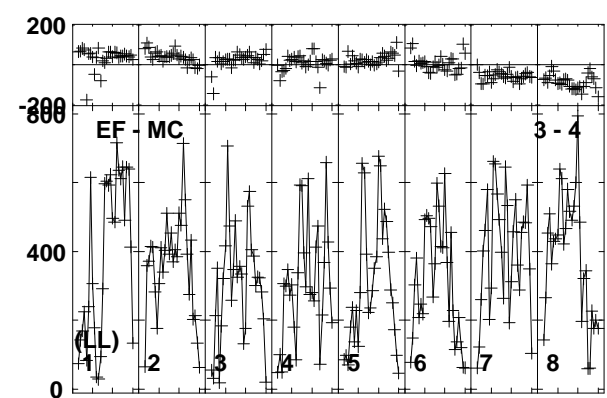
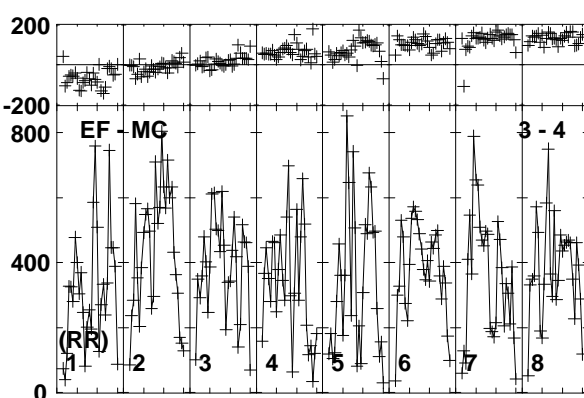
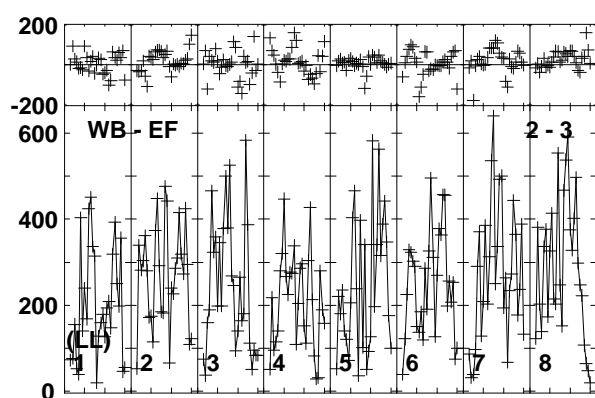
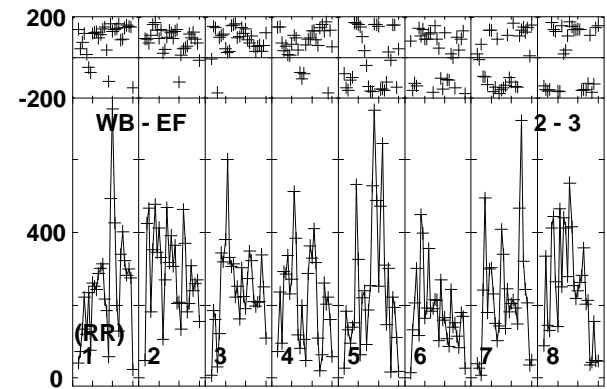
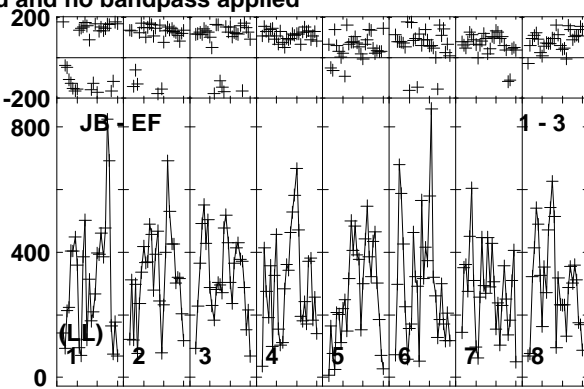
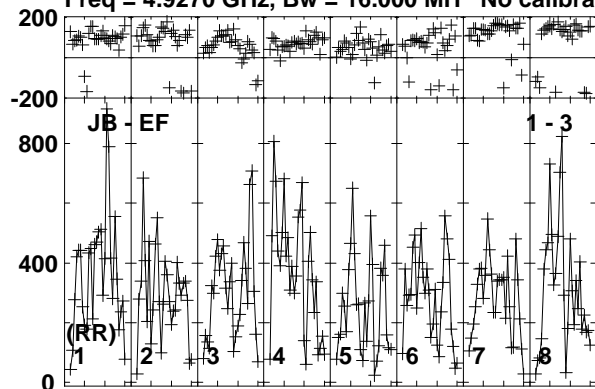

Lower frame: Micro Ampl Jy Top frame: Phas deg  
Vector averaged cross-power spectrum Baseline: JB (01) - EF (03)  
Timerange: 00/11:44:01 to 00/11:44:59

Plot file version 365 created 19-DEC-2018 17:58:38

VLA2 RY007C.UVDATA.1

Freq = 4.9270 GHz, Bw = 16.000 MH No calibration applied and no bandpass applied

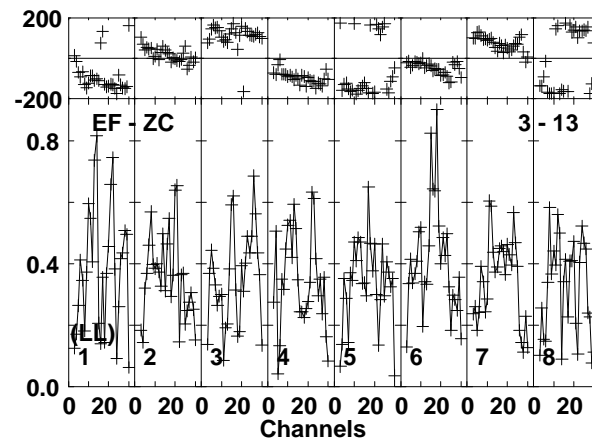
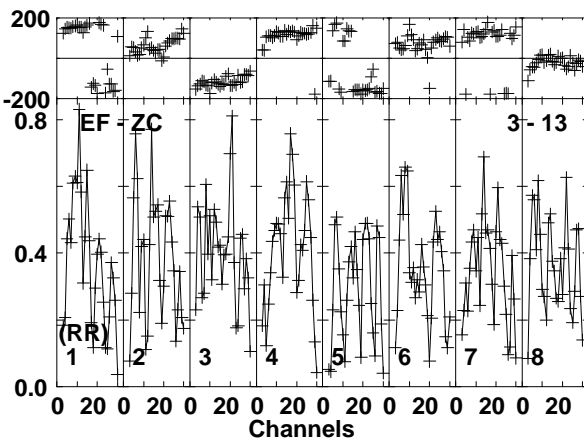
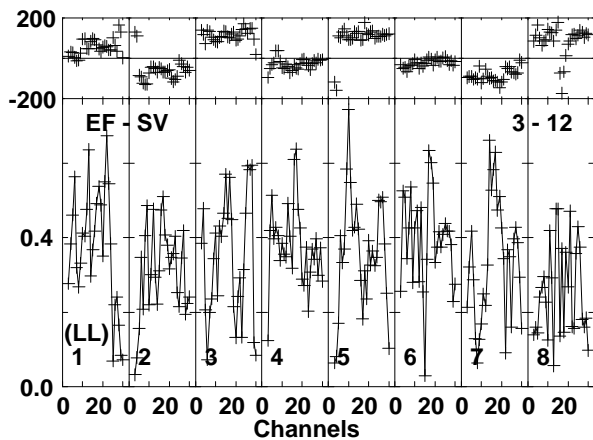
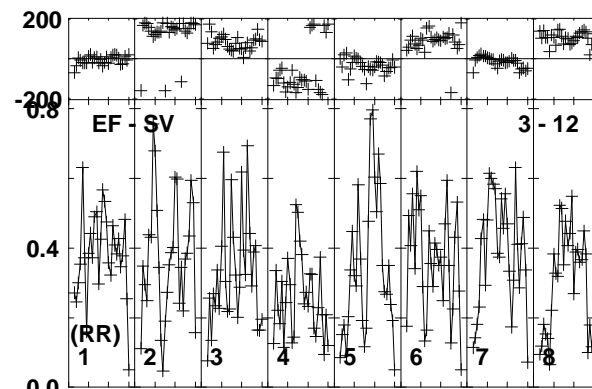
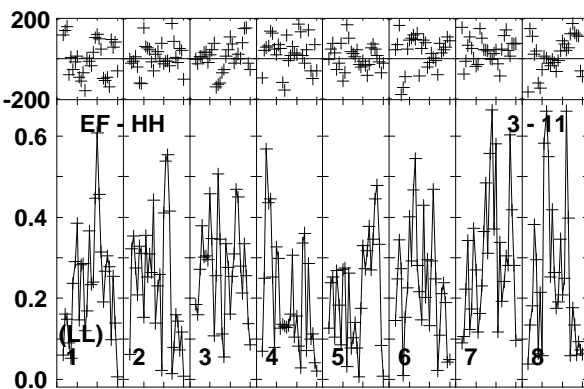
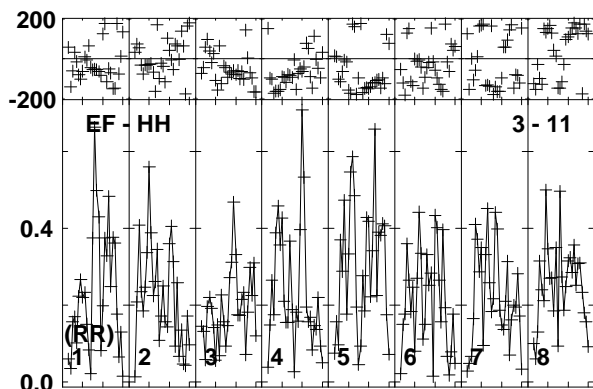
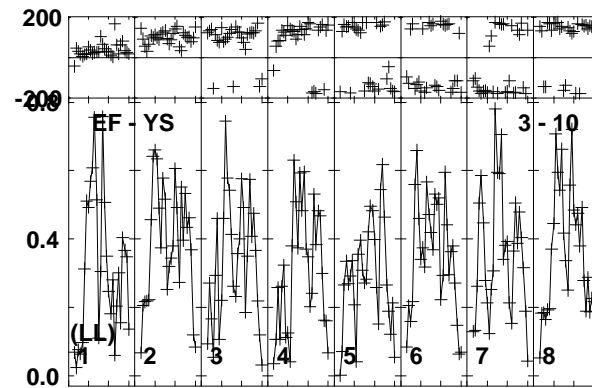
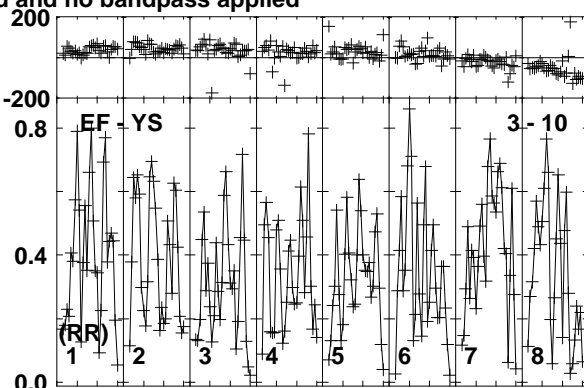
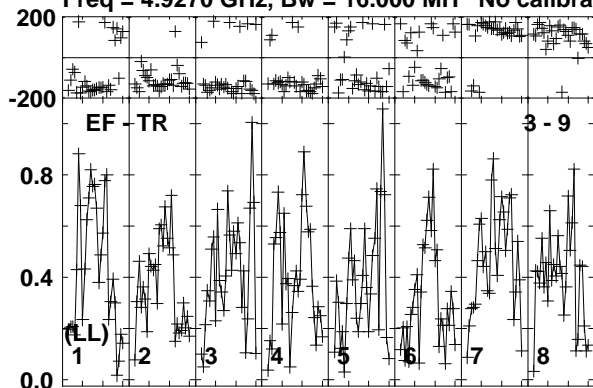

Lower frame: Milli Ampl Jy Top frame: Phas deg  
Vector averaged cross-power spectrum Baseline: EF (03) - TR (09)  
Timerange: 00/11:44:01 to 00/11:44:59

Plot file version 366 created 19-DEC-2018 17:58:38

VLA2 RY007C.UVDATA.1

Freq = 4.9270 GHz, Bw = 16.000 MH No calibration applied and no bandpass applied

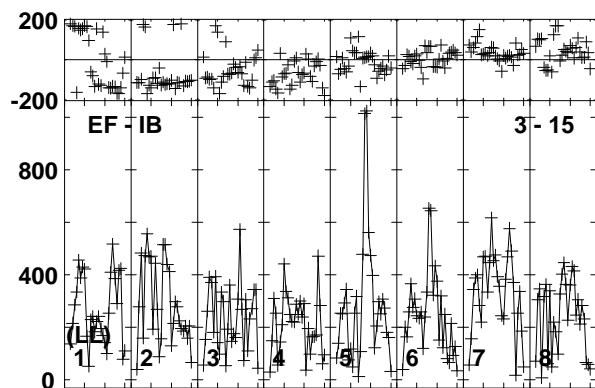
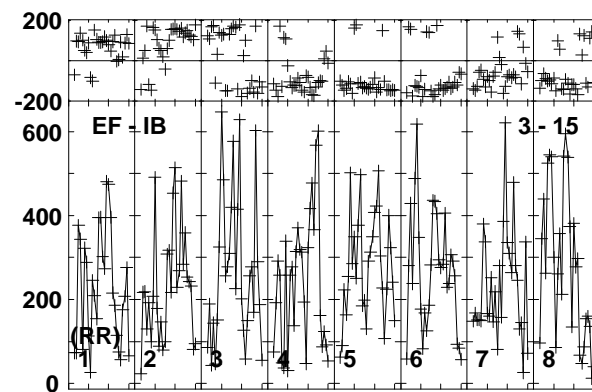
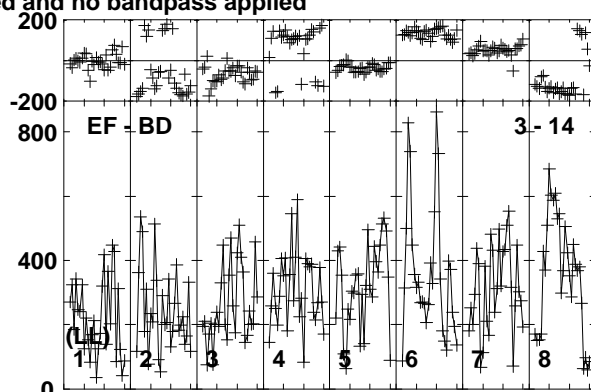
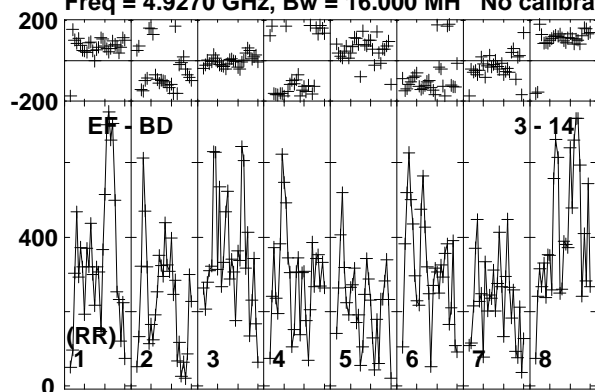

Lower frame: Micro Ampl Jy Top frame: Phas deg  
Vector averaged cross-power spectrum Baseline: EF (03) - BD (14)  
Timerange: 00/11:44:01 to 00/11:44:59

Plot file version 367 created 19-DEC-2018 17:58:38

J1619+2247 RY007C.UVDATA.1

Freq = 4.9270 GHz, Bw = 16.000 MH No calibration applied and no bandpass applied

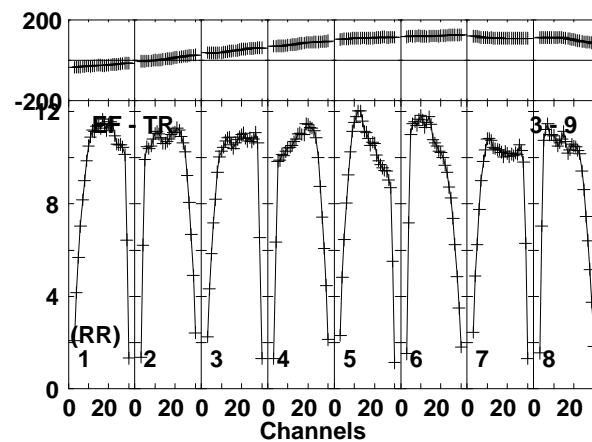
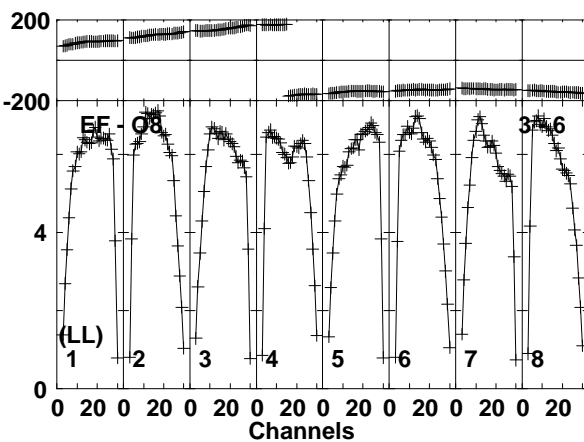
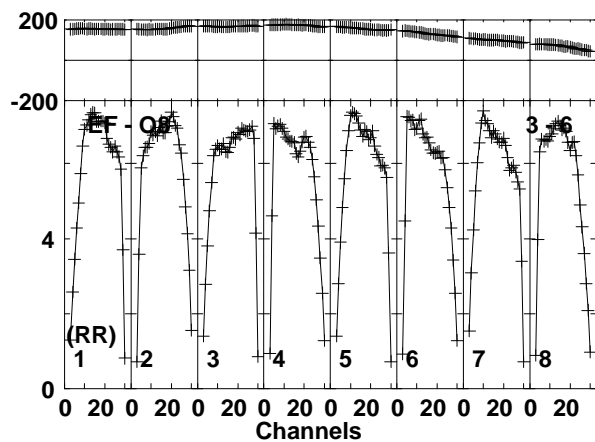
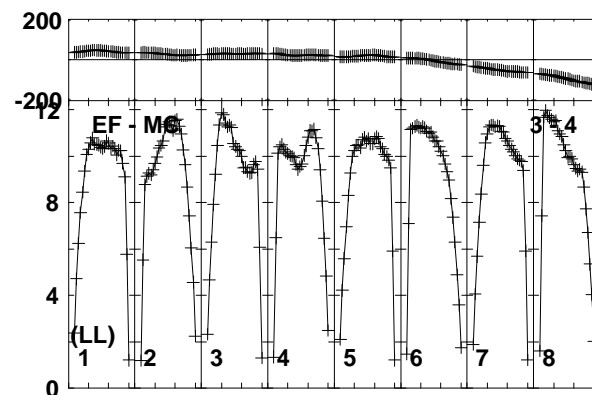
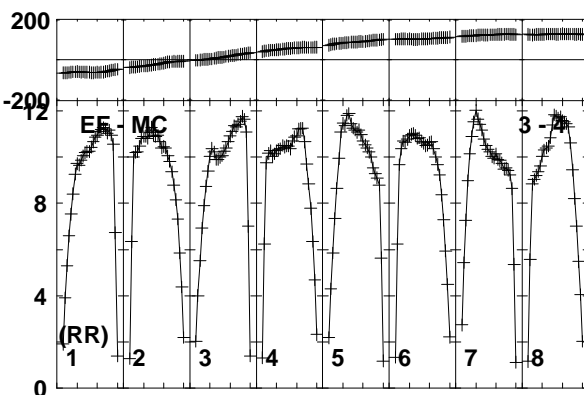
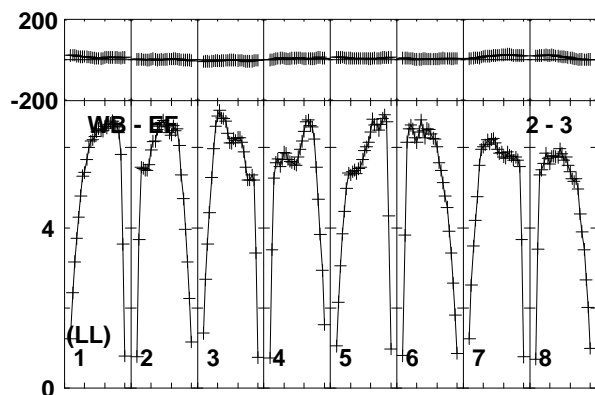
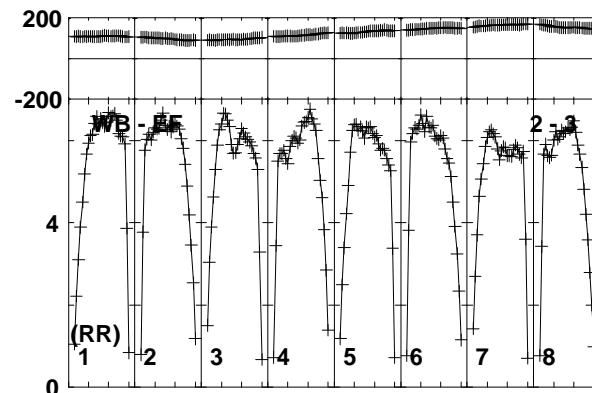
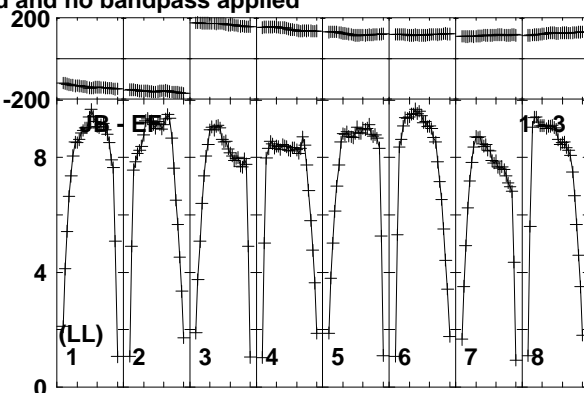
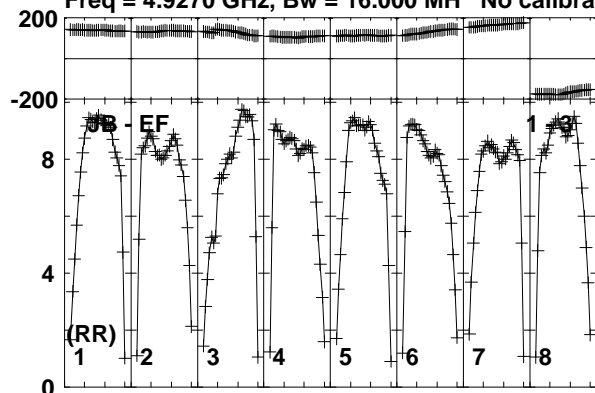

Lower frame: Milli Ampl Jy Top frame: Phas deg  
Vector averaged cross-power spectrum Baseline: JB (01) - EF (03)  
Timerange: 00/11:45:31 to 00/11:46:29

Plot file version 368 created 19-DEC-2018 17:58:38

J1619+2247 RY007C.UVDATA.1

Freq = 4.9270 GHz, Bw = 16.000 MH No calibration applied and no bandpass applied

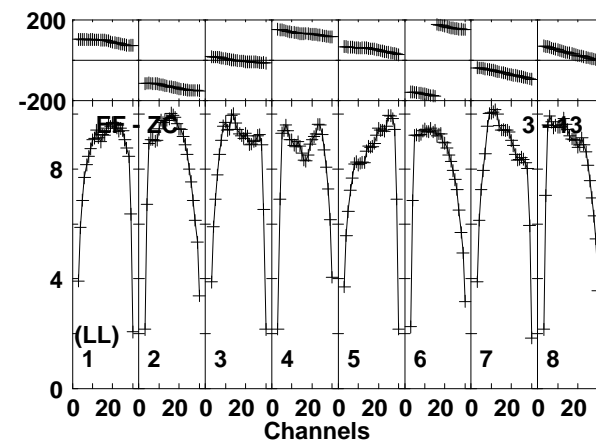
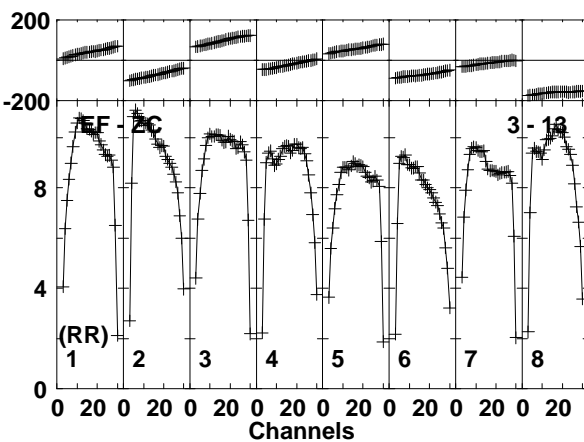
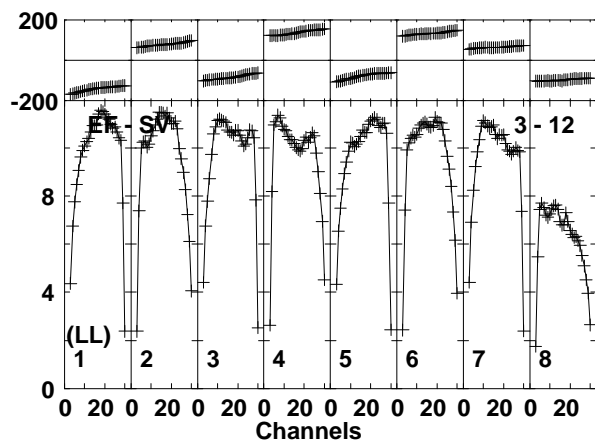
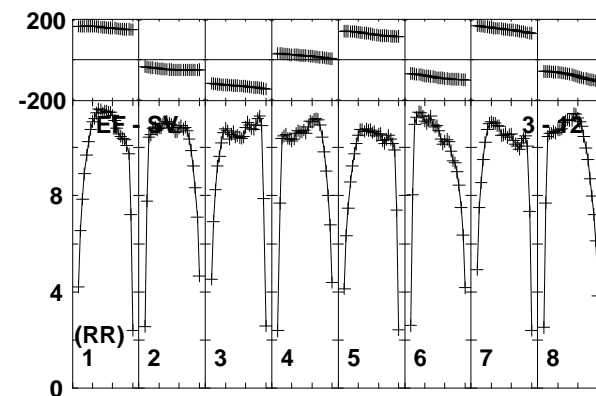
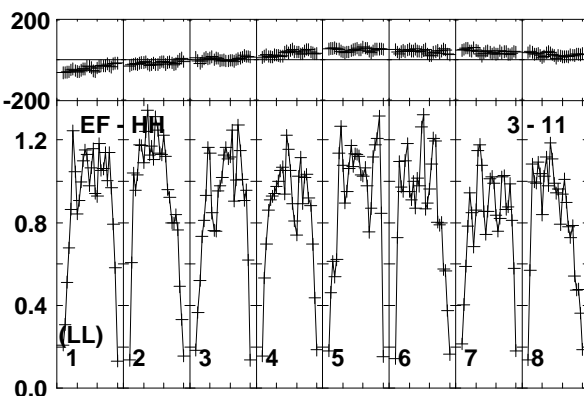
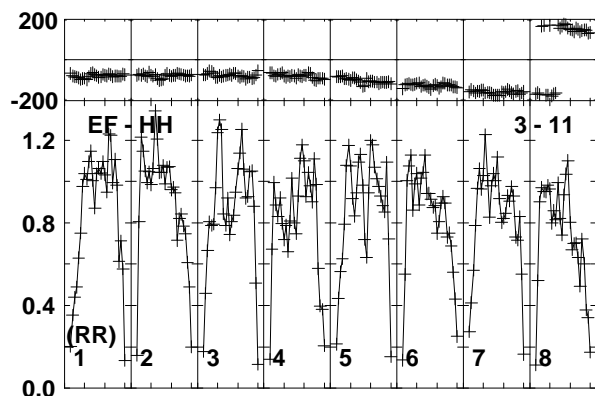
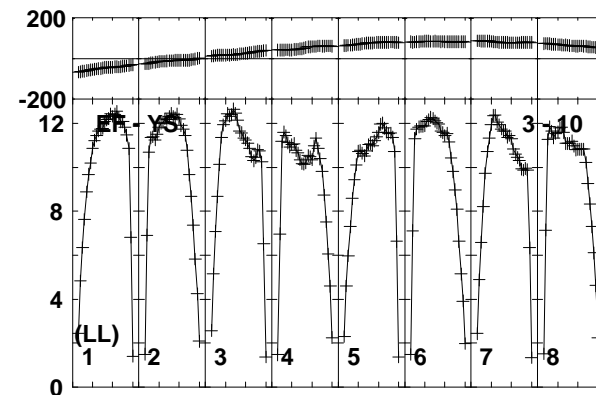
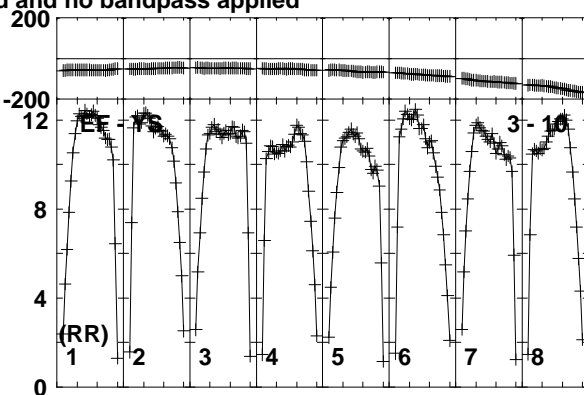
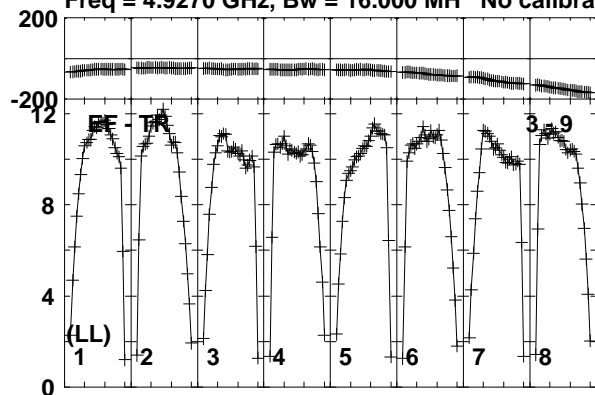

Lower frame: Milli Ampl Jy Top frame: Phas deg  
Vector averaged cross-power spectrum Baseline: EF (03) - TR (09)  
Timerange: 00/11:45:31 to 00/11:46:29

Plot file version 369 created 19-DEC-2018 17:58:40

J1619+2247 RY007C.UVDATA.1

Freq = 4.9270 GHz, Bw = 16.000 MH No calibration applied and no bandpass applied

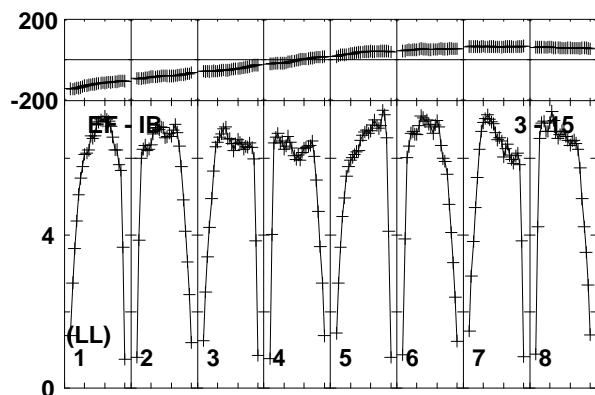
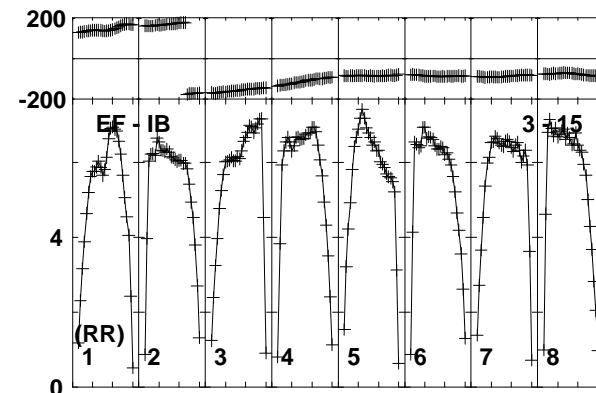
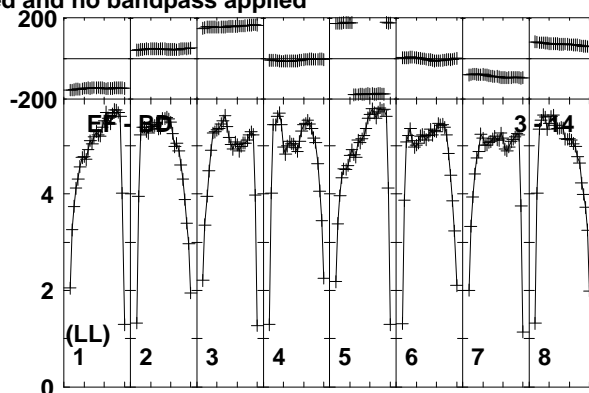
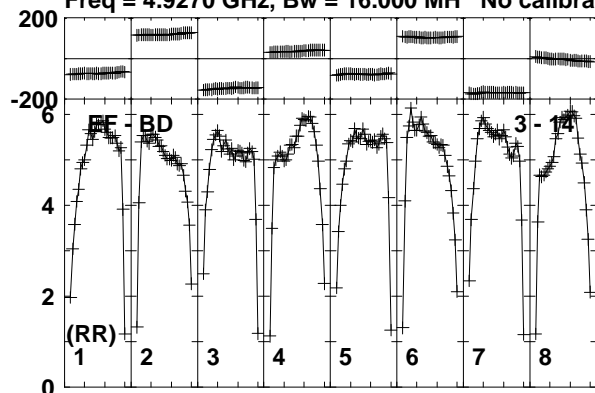

Lower frame: Milli Ampl Jy Top frame: Phas deg  
Vector averaged cross-power spectrum Baseline: EF (03) - BD (14)  
Timerange: 00/11:45:31 to 00/11:46:29

Plot file version 370 created 19-DEC-2018 17:58:40  
 AT2018\_RY007C.UVDATA.1

Freq = 4.9270 GHz, Bw = 16.000 MH No calibration applied and no bandpass applied

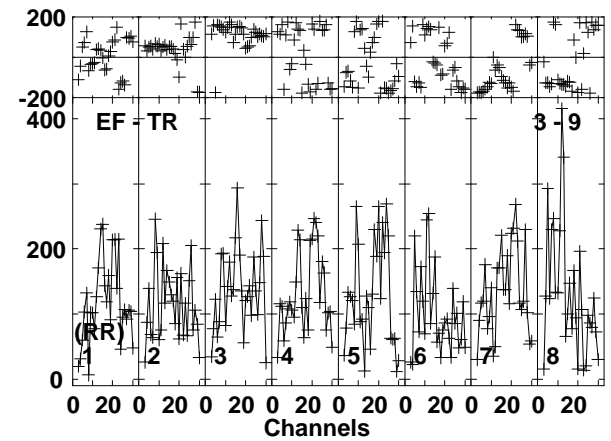
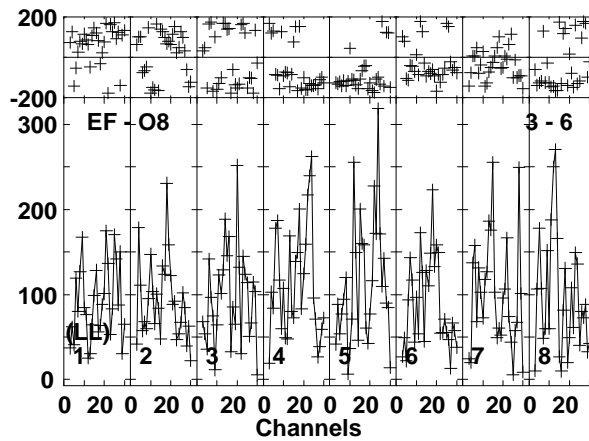
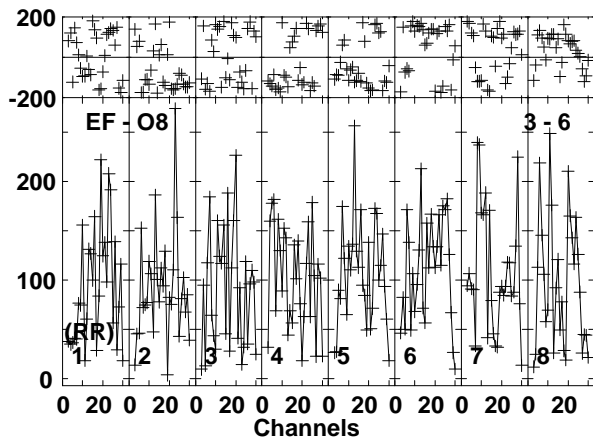
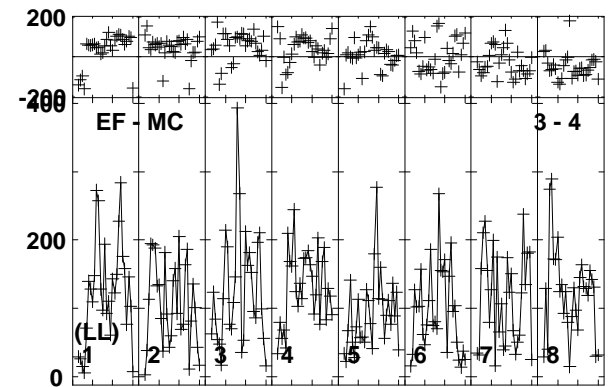
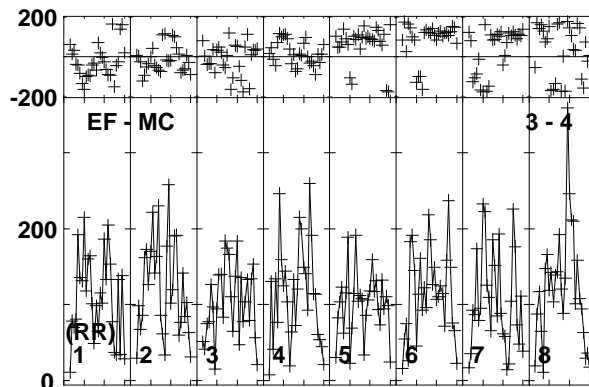
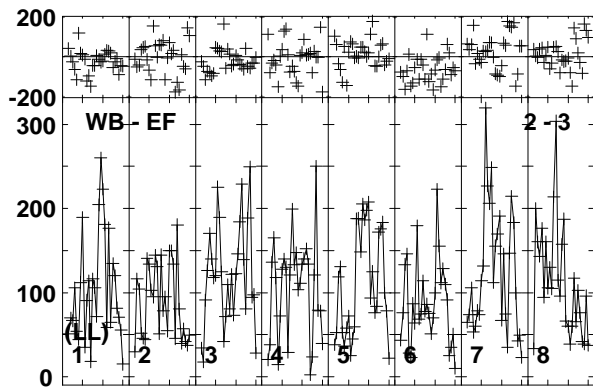
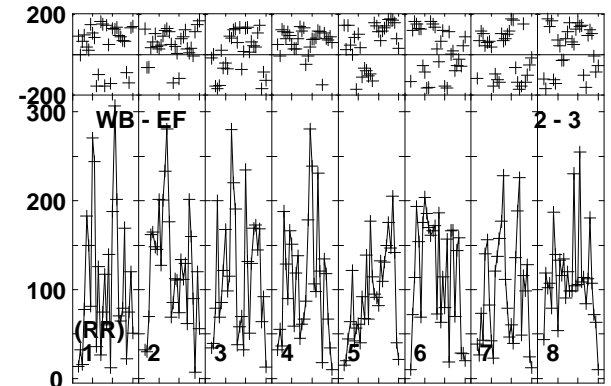
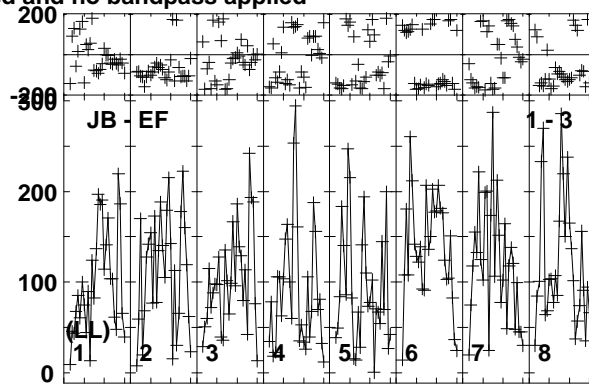
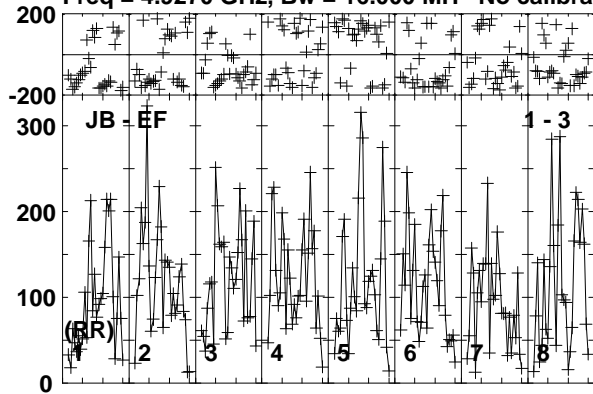

Lower frame: Micro Ampl Jy Top frame: Phas deg  
 Vector averaged cross-power spectrum Baseline: JB (01) - EF (03)  
 Timerange: 00/11:46:31 to 00/11:49:29



Plot file version 371 created 19-DEC-2018 17:58:40

AT2018\_RY007C.UVDATA.1

Freq = 4.9270 GHz, Bw = 16.000 MH No calibration applied and no bandpass applied

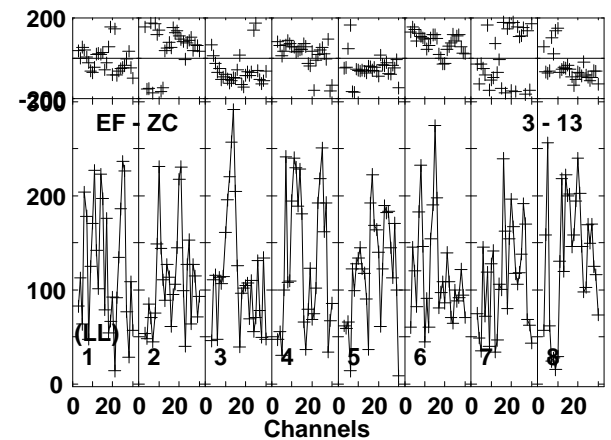
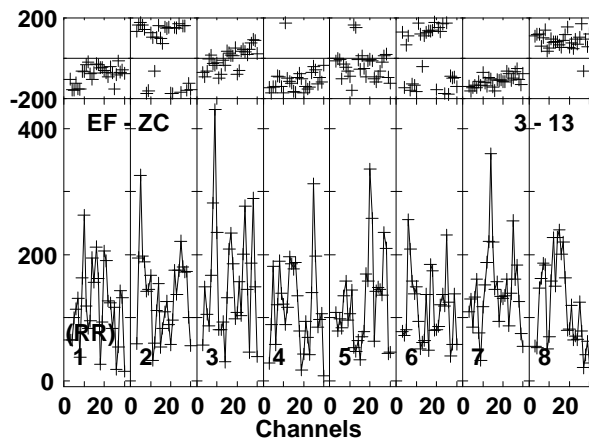
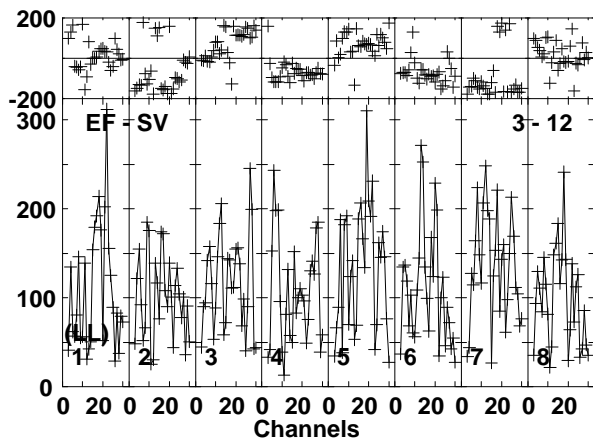
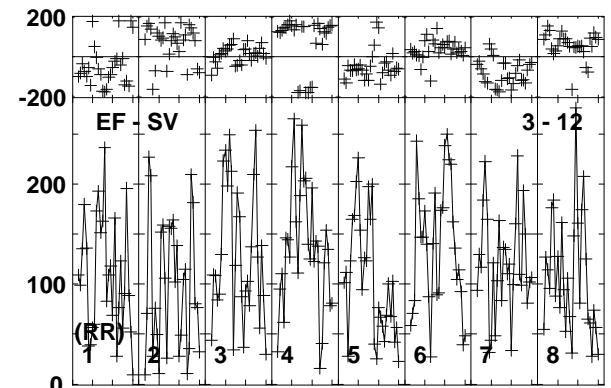
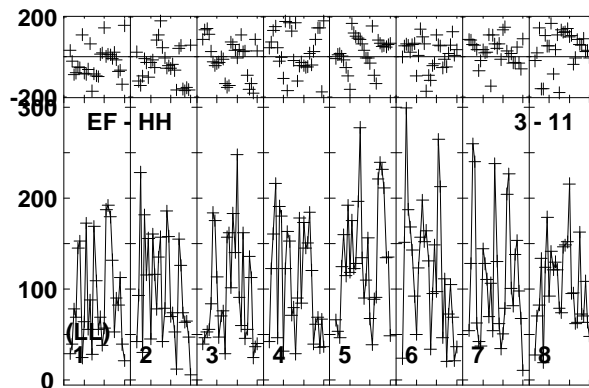
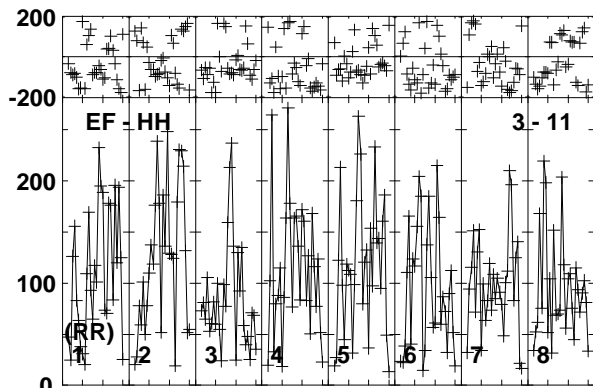
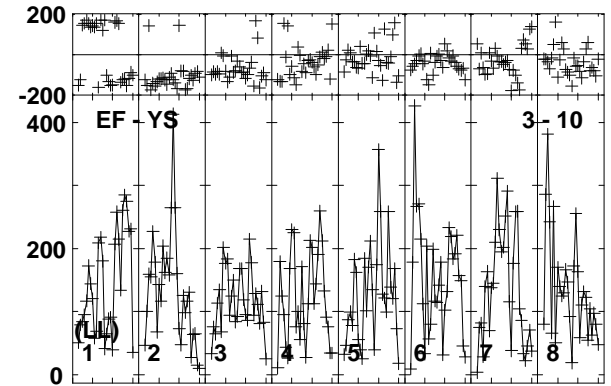
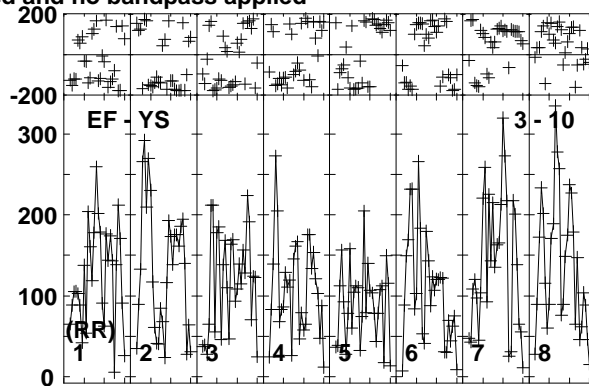
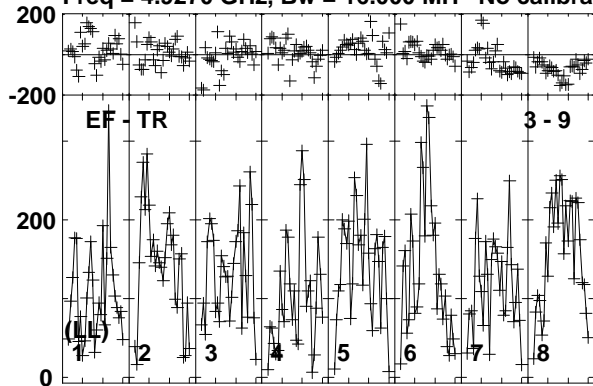

Lower frame: Micro Ampl Jy Top frame: Phas deg  
Vector averaged cross-power spectrum Baseline: EF (03) - TR (09)  
Timerange: 00/11:46:31 to 00/11:49:29

Plot file version 372 created 19-DEC-2018 17:58:40

AT2018\_RY007C.UVDATA.1

Freq = 4.9270 GHz, Bw = 16.000 MH No calibration applied and no bandpass applied

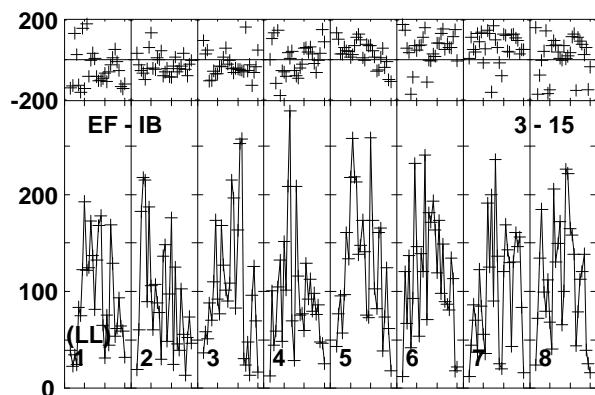
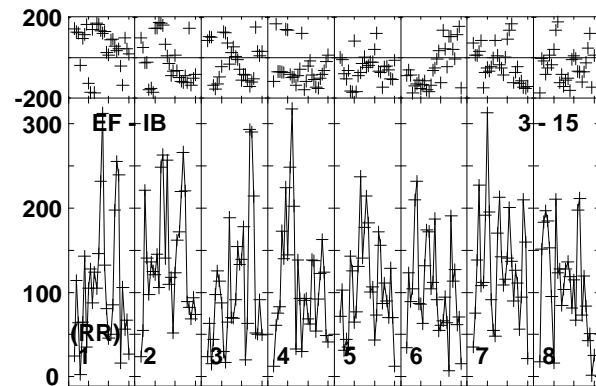
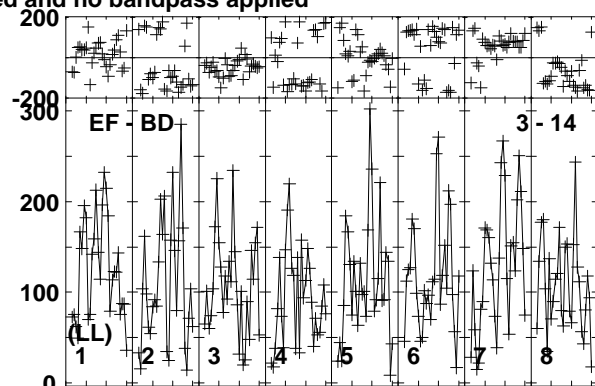
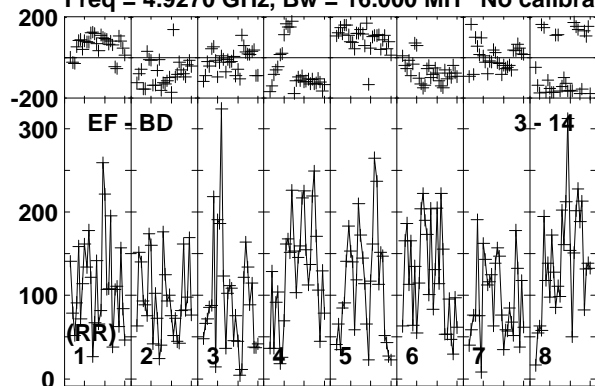

Lower frame: Micro Ampl Jy Top frame: Phas deg  
Vector averaged cross-power spectrum Baseline: EF (03) - BD (14)  
Timerange: 00/11:46:31 to 00/11:49:29

Plot file version 373 created 19-DEC-2018 17:58:40

J1619+2247 RY007C.UVDATA.1

Freq = 4.9270 GHz, Bw = 16.000 MH No calibration applied and no bandpass applied

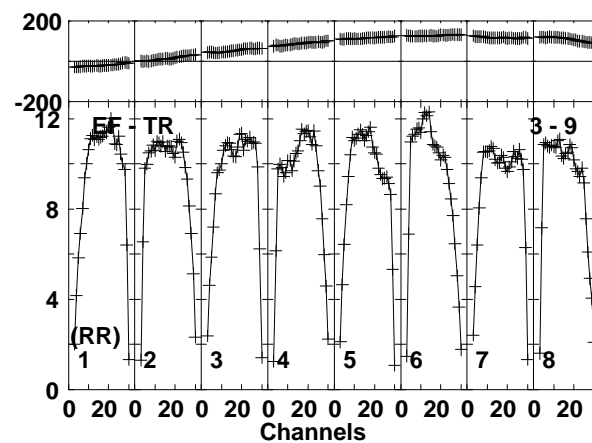
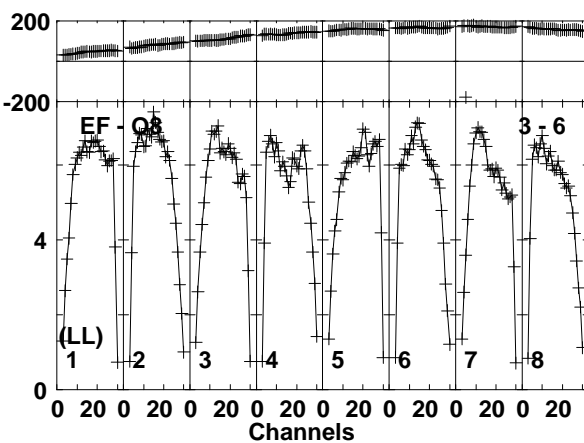
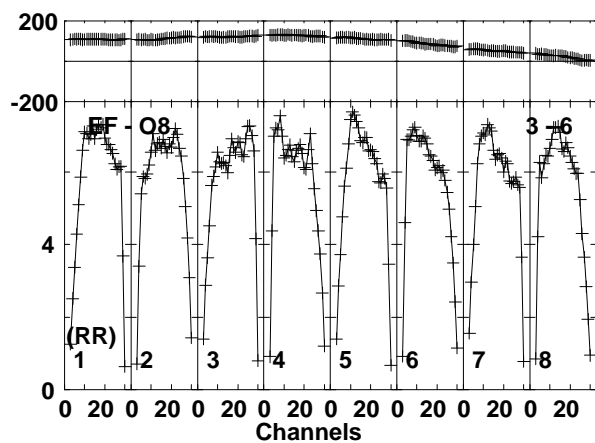
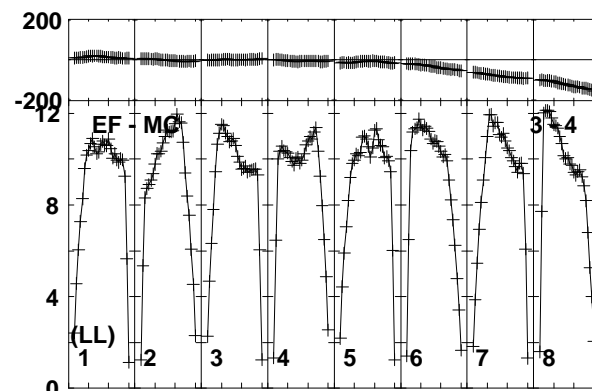
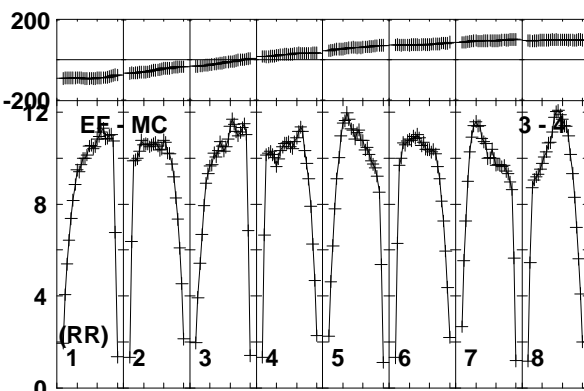
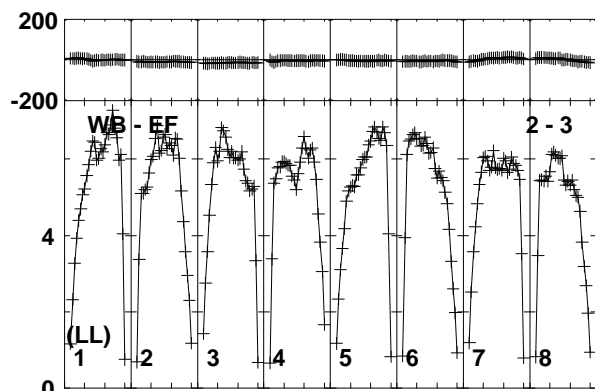
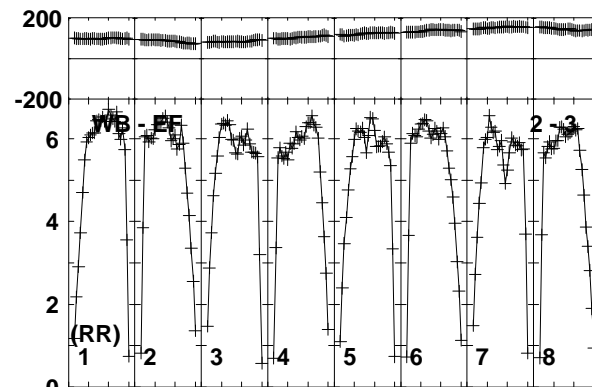
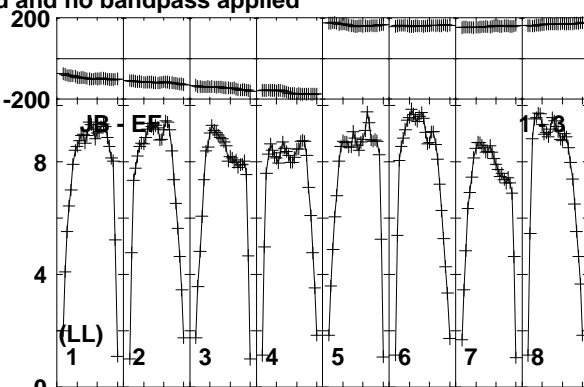
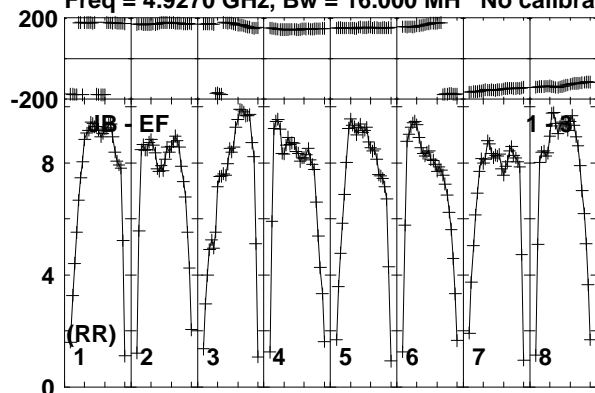

Lower frame: Milli Ampl Jy Top frame: Phas deg  
Vector averaged cross-power spectrum Baseline: JB (01) - EF (03)  
Timerange: 00/11:49:31 to 00/11:50:29

Plot file version 374 created 19-DEC-2018 17:58:40

J1619+2247 RY007C.UVDATA.1

Freq = 4.9270 GHz, Bw = 16.000 MH No calibration applied and no bandpass applied

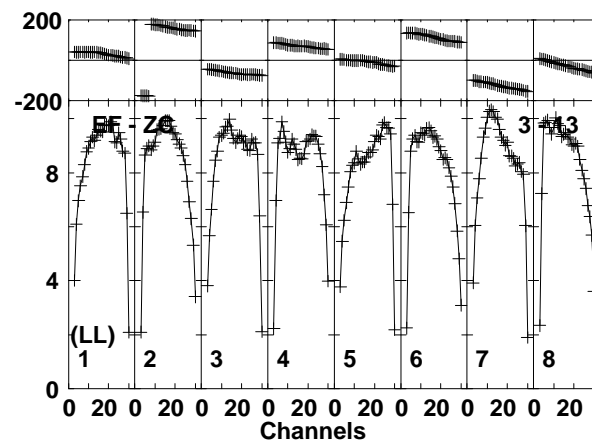
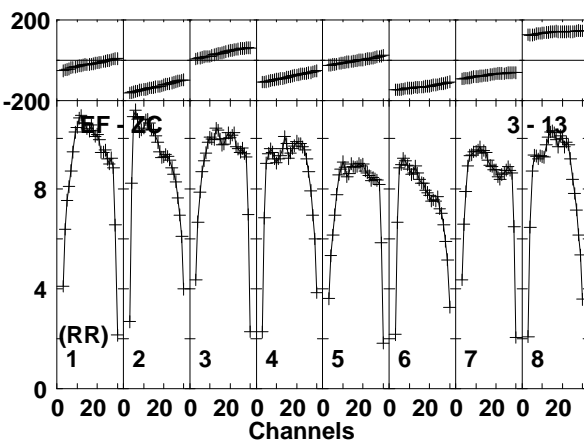
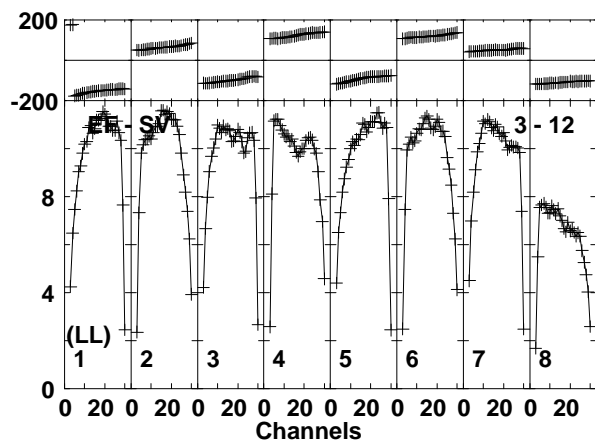
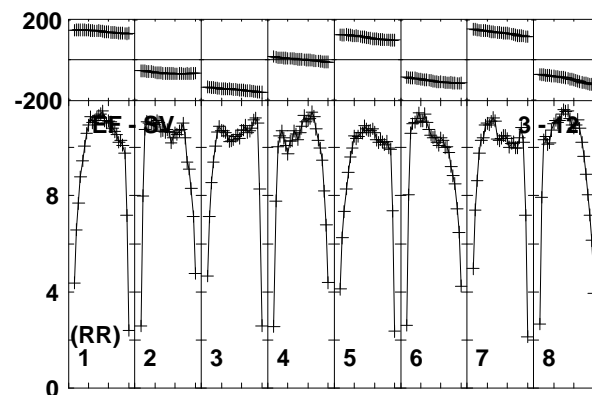
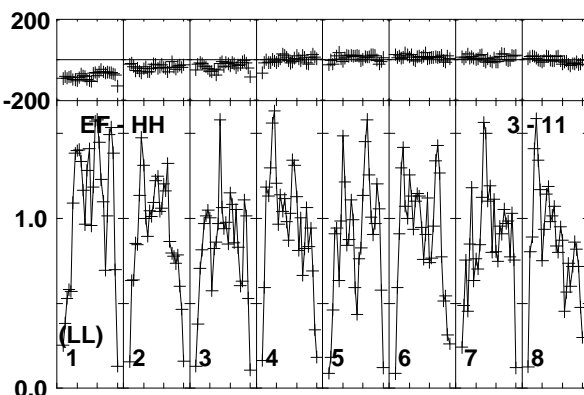
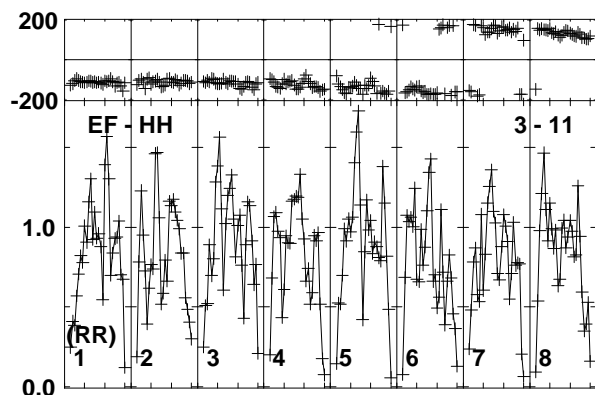
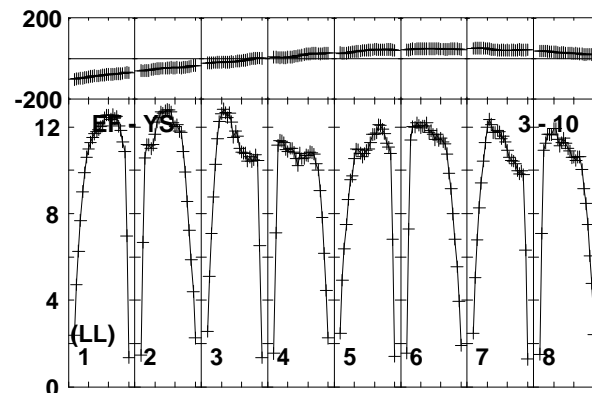
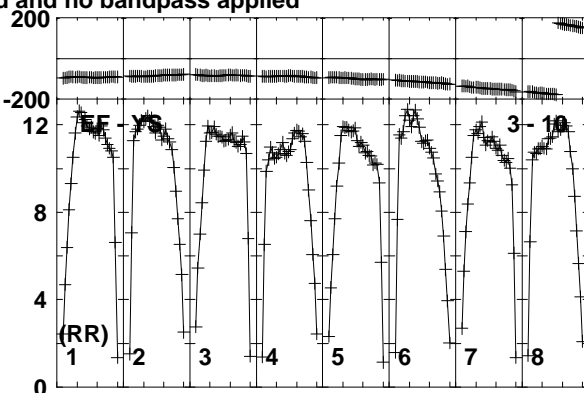
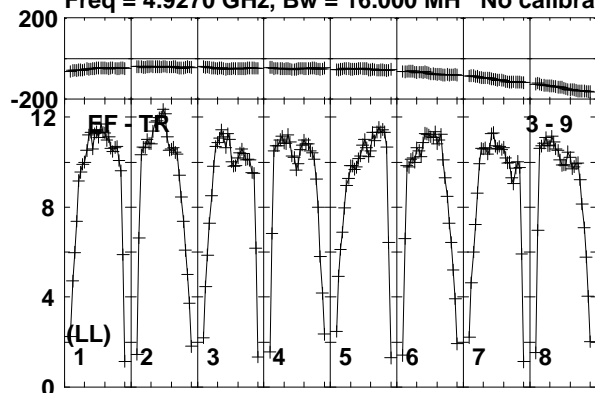

Lower frame: Milli Ampl Jy Top frame: Phas deg  
Vector averaged cross-power spectrum Baseline: EF (03) - TR (09)  
Timerange: 00/11:49:31 to 00/11:50:29

Plot file version 375 created 19-DEC-2018 17:58:40  
J1619+2247 RY007C.UVDATA.1

Freq = 4.9270 GHz, Bw = 16.000 MH No calibration applied and no bandpass applied

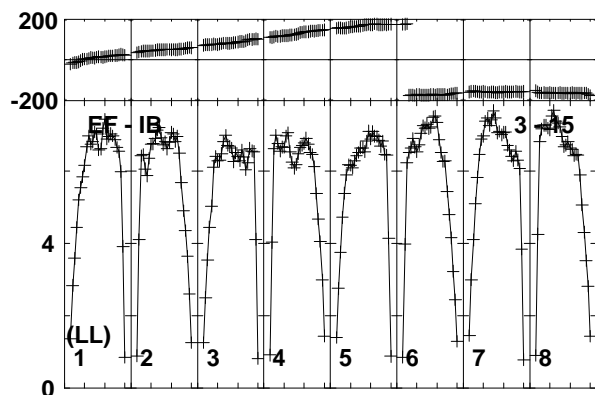
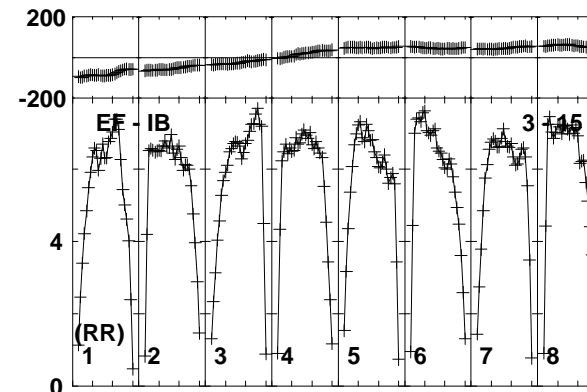
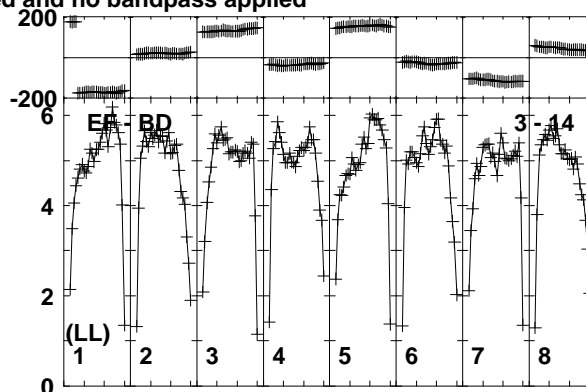
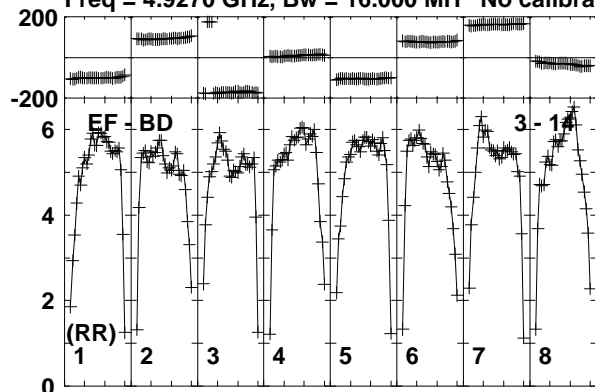

Lower frame: Milli Ampl Jy Top frame: Phas deg  
Vector averaged cross-power spectrum Baseline: EF (03) - BD (14)  
Timerange: 00/11:49:31 to 00/11:50:29

Plot file version 376 created 19-DEC-2018 17:58:40

AT2018\_RY007C.UVDATA.1

Freq = 4.9270 GHz, Bw = 16.000 MH No calibration applied and no bandpass applied

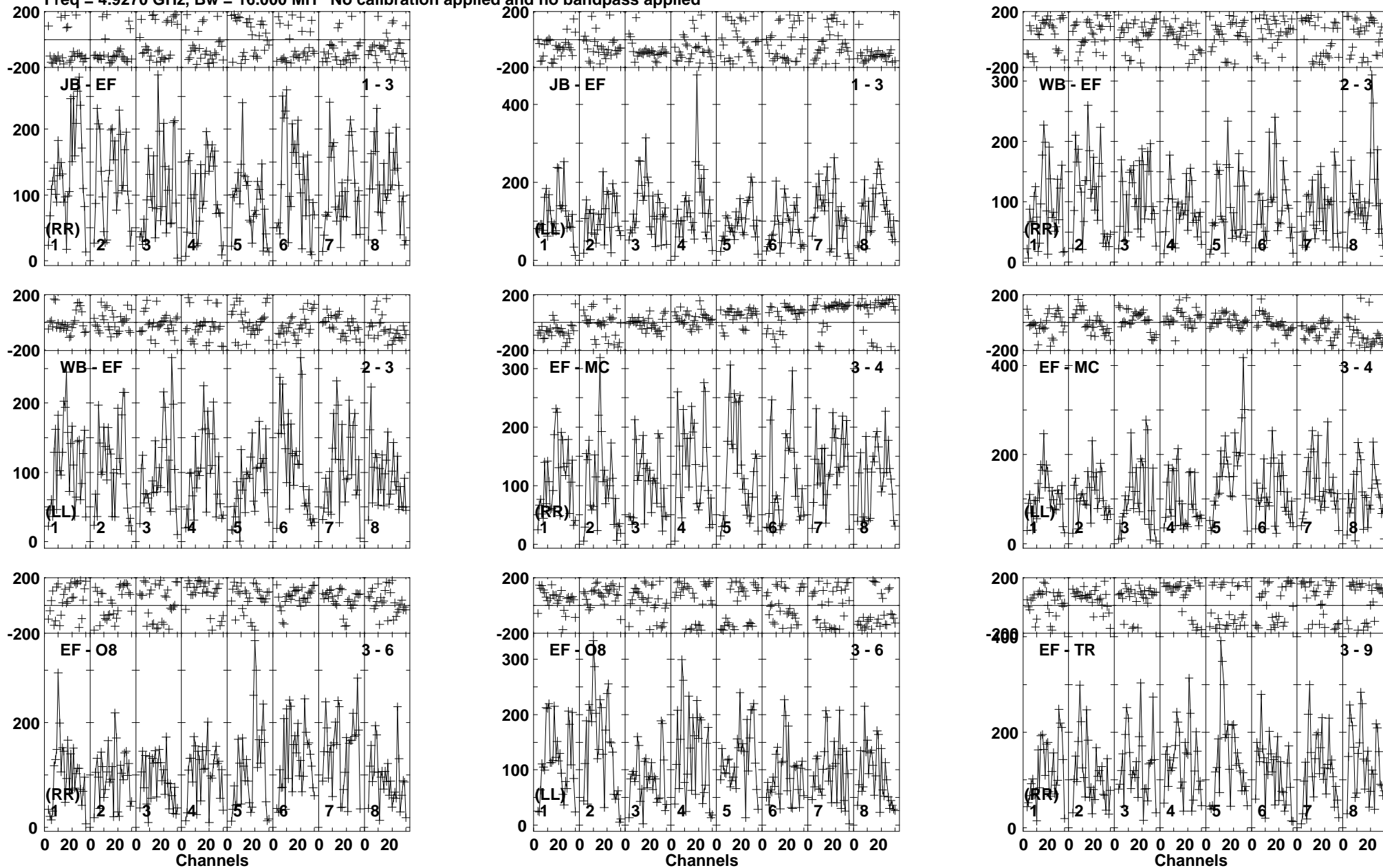

Lower frame: Micro Ampl Jy Top frame: Phas deg  
Vector averaged cross-power spectrum Baseline: JB (01) - EF (03)  
Timerange: 00/11:50:31 to 00/11:53:29

Plot file version 377 created 19-DEC-2018 17:58:40

AT2018\_RY007C.UVDATA.1

Freq = 4.9270 GHz, Bw = 16.000 MH No calibration applied and no bandpass applied

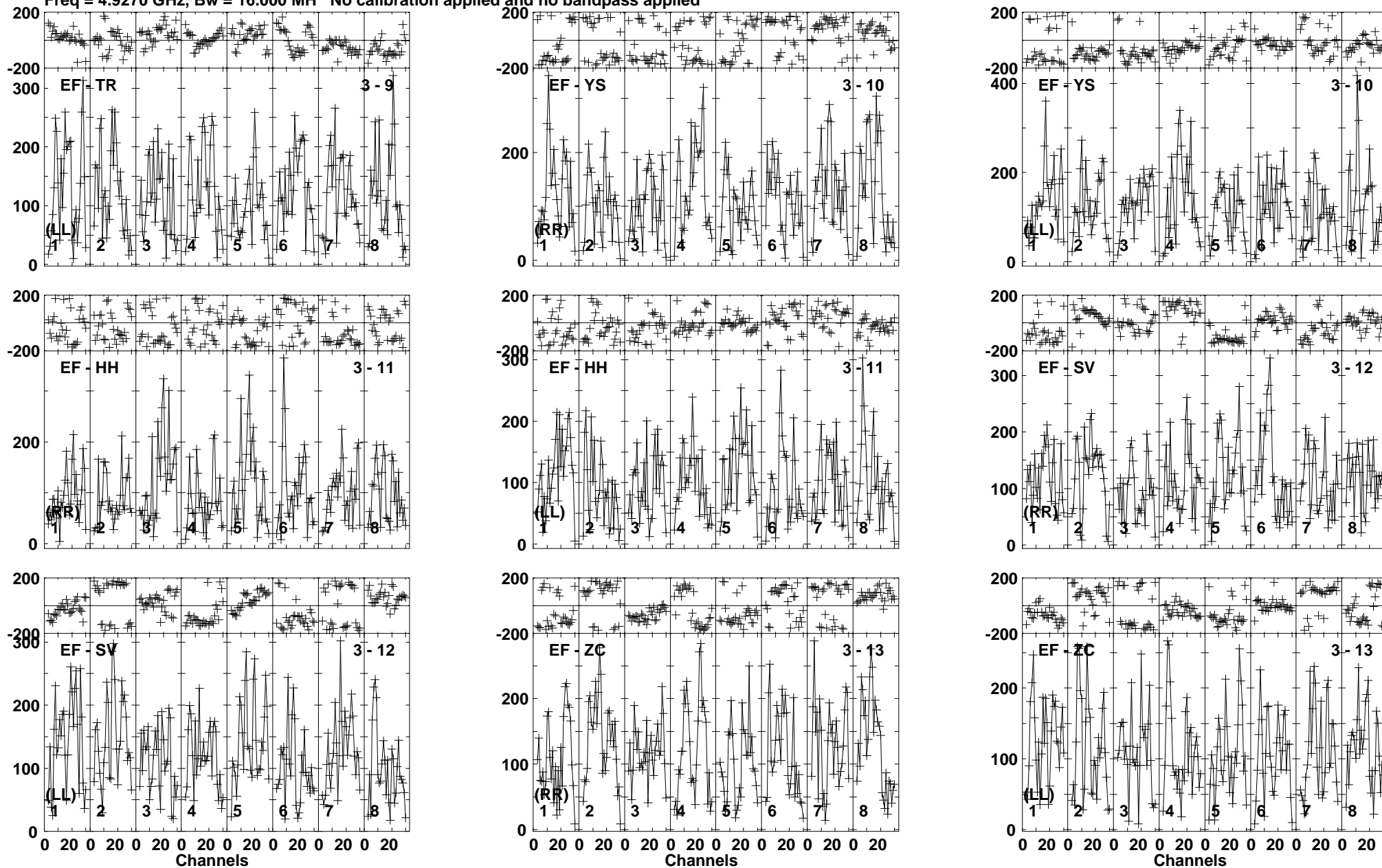

Lower frame: Micro Ampl Jy Top frame: Phas deg  
Vector averaged cross-power spectrum Baseline: EF (03) - TR (09)  
Timerange: 00/11:50:31 to 00/11:53:29

Plot file version 378 created 19-DEC-2018 17:58:40

AT2018\_RY007C.UVDATA.1

Freq = 4.9270 GHz, Bw = 16.000 MH No calibration applied and no bandpass applied

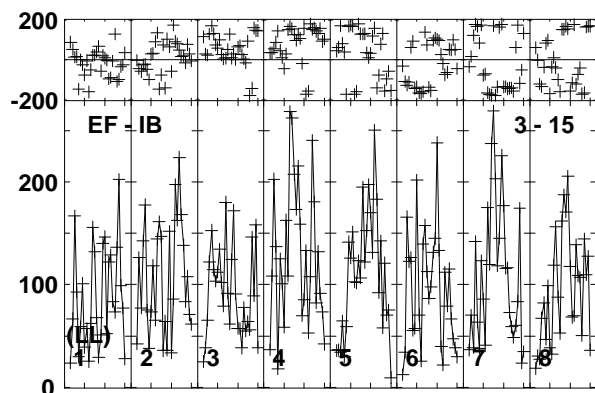
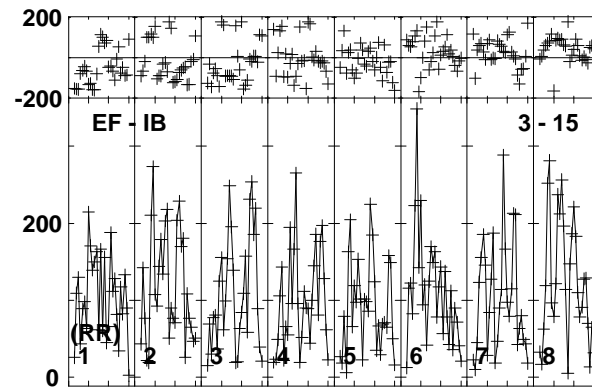
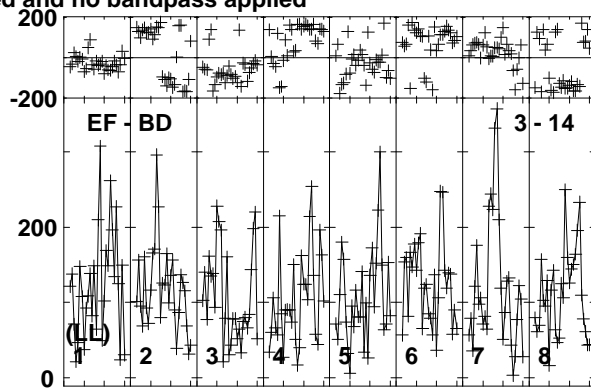
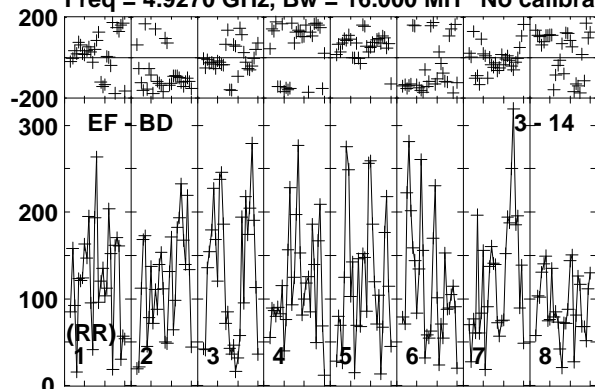

Lower frame: Micro Ampl Jy Top frame: Phas deg  
Vector averaged cross-power spectrum Baseline: EF (03) - BD (14)  
Timerange: 00/11:50:31 to 00/11:53:29



Plot file version 379 created 19-DEC-2018 17:58:40

J1619+2247 RY007C.UVDATA.1

Freq = 4.9270 GHz, Bw = 16.000 MH No calibration applied and no bandpass applied

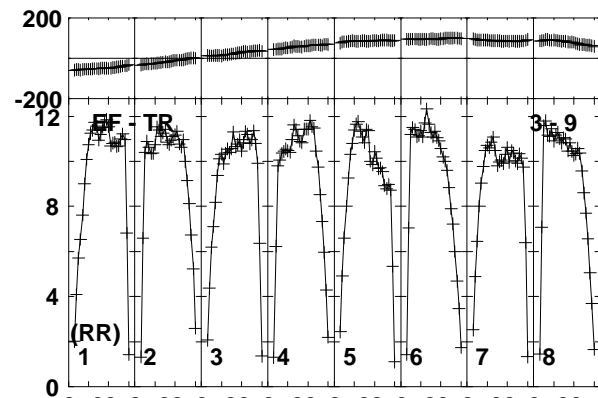
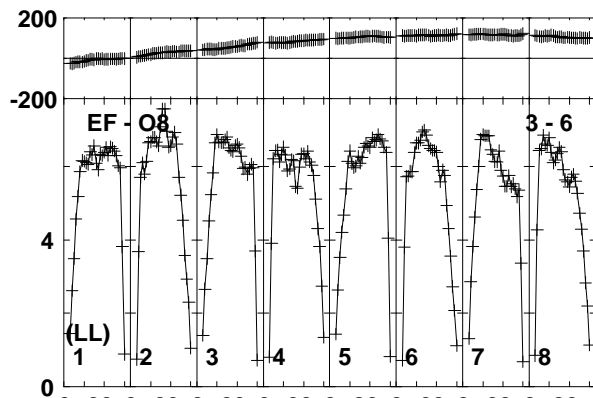
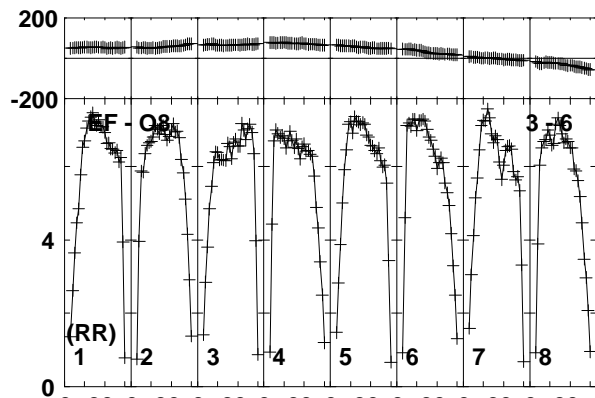
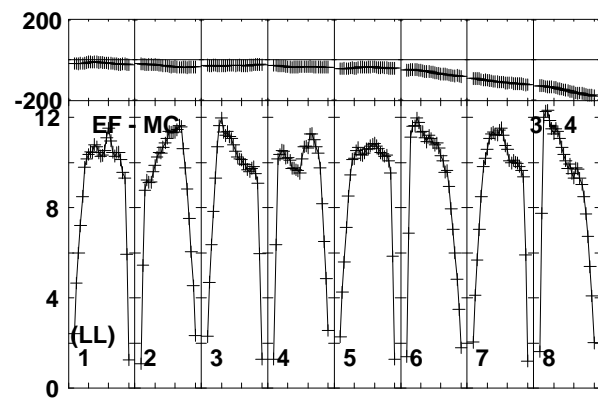
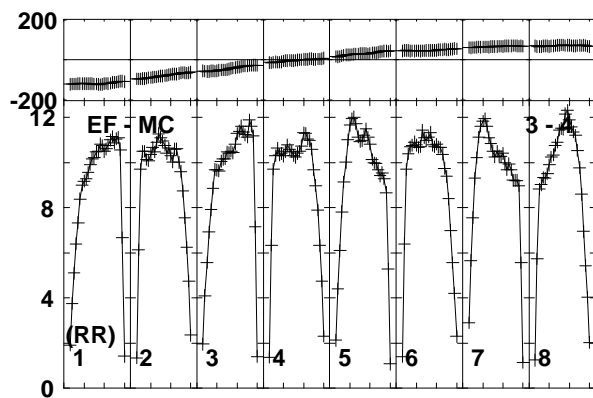
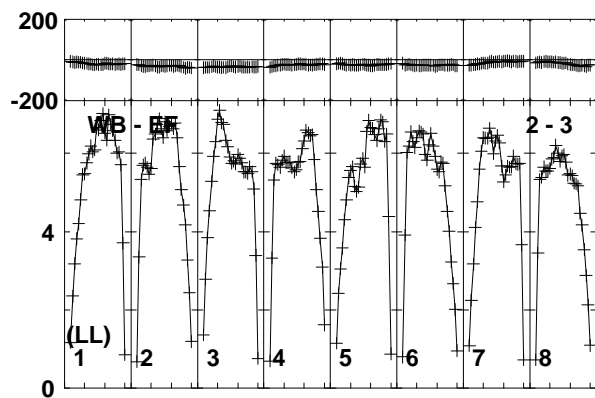
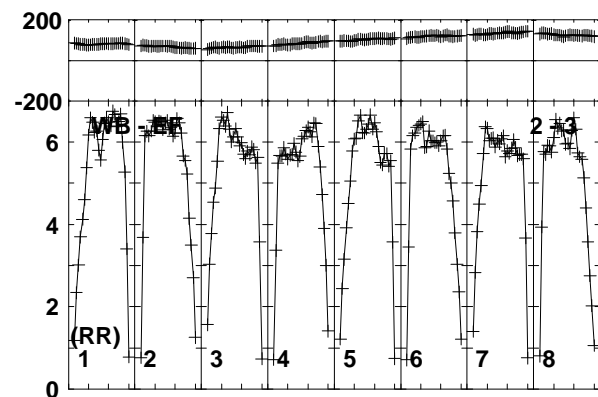
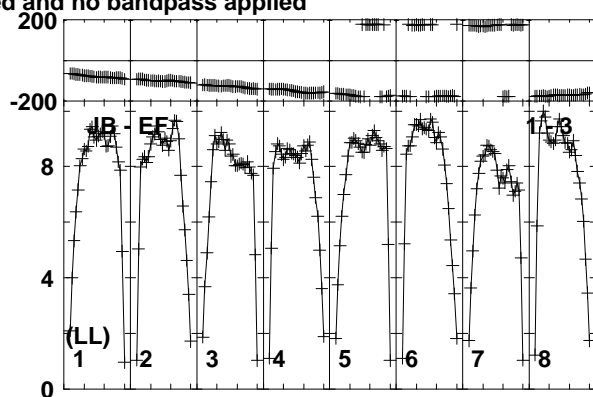
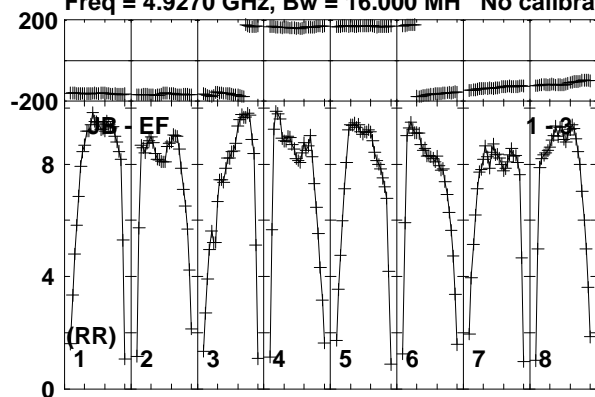

Lower frame: Milli Ampl Jy Top frame: Phas deg  
Vector averaged cross-power spectrum Baseline: JB (01) - EF (03)  
Timerange: 00/11:53:31 to 00/11:54:29

Plot file version 380 created 19-DEC-2018 17:58:40

J1619+2247 RY007C.UVDATA.1

Freq = 4.9270 GHz, Bw = 16.000 MH No calibration applied and no bandpass applied

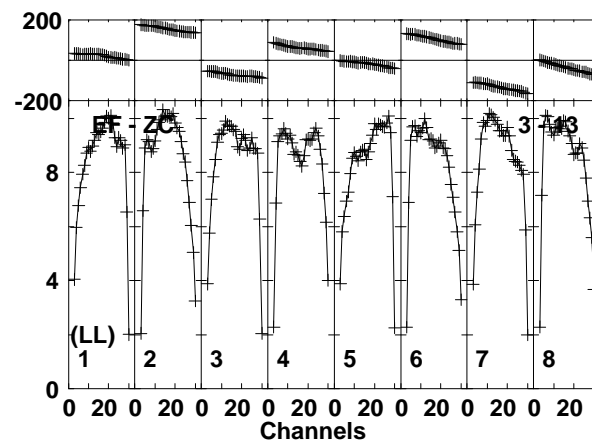
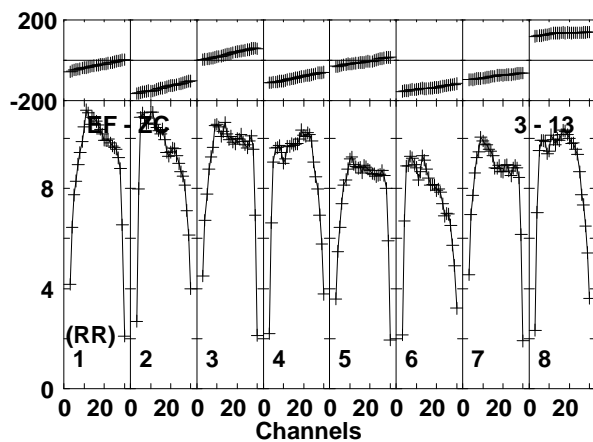
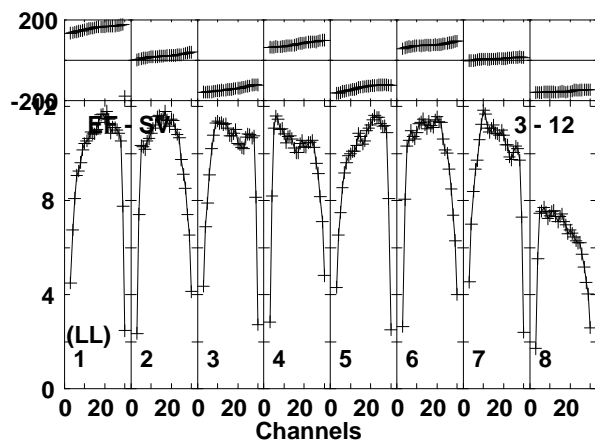
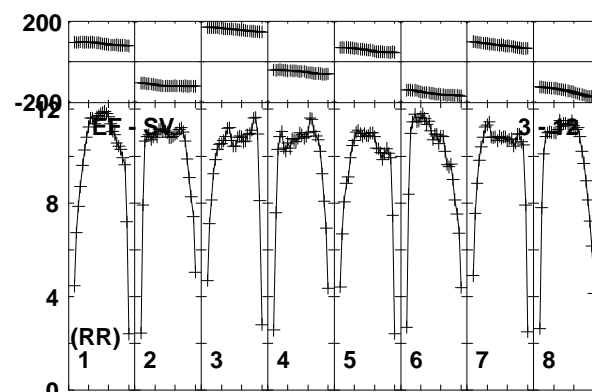
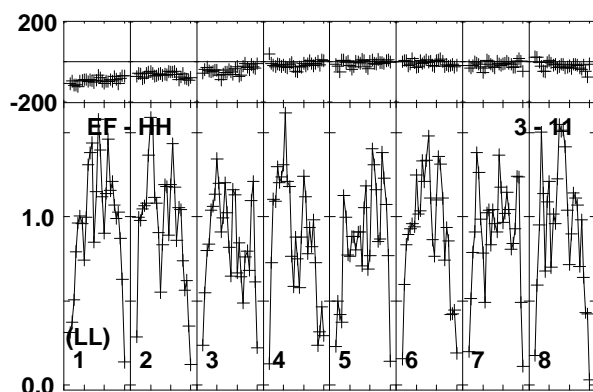
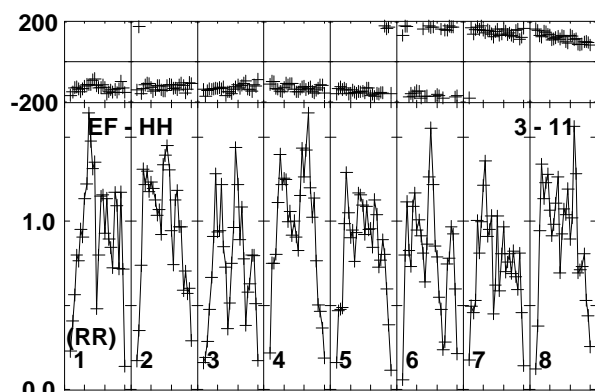
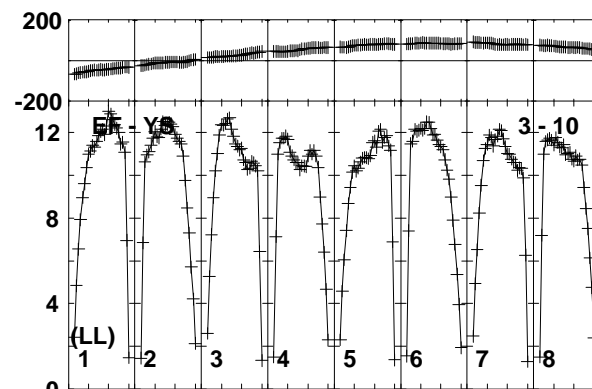
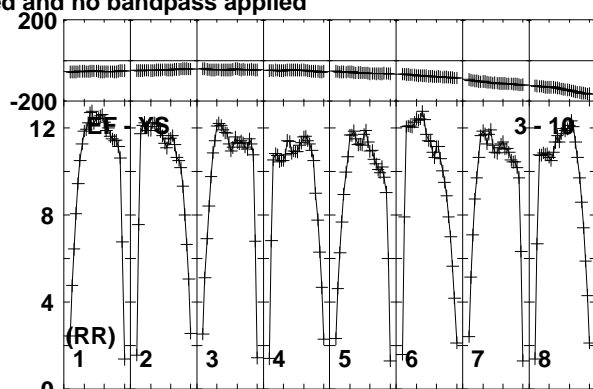
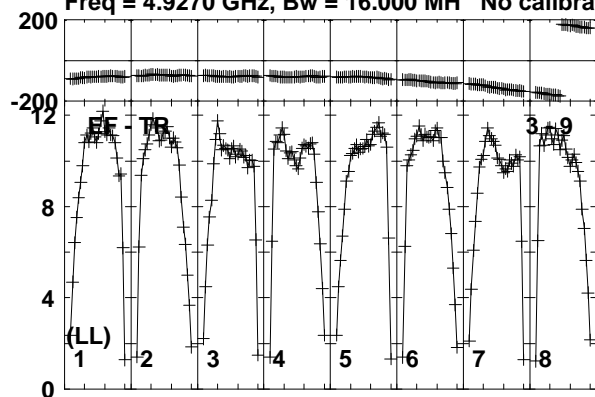

Lower frame: Milli Ampl Jy Top frame: Phas deg  
Vector averaged cross-power spectrum Baseline: EF (03) - TR (09)  
Timerange: 00/11:53:31 to 00/11:54:29

Plot file version 381 created 19-DEC-2018 17:58:40

J1619+2247 RY007C.UVDATA.1

Freq = 4.9270 GHz, Bw = 16.000 MH No calibration applied and no bandpass applied

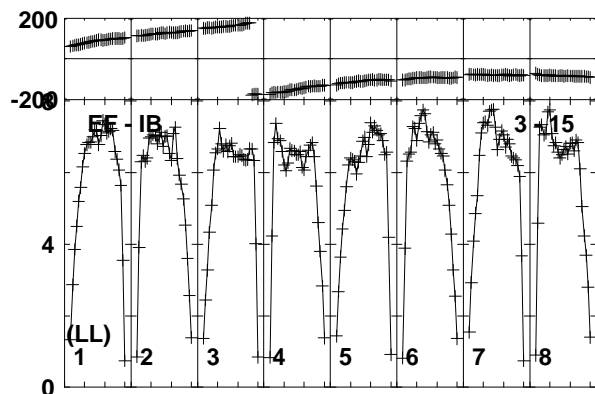
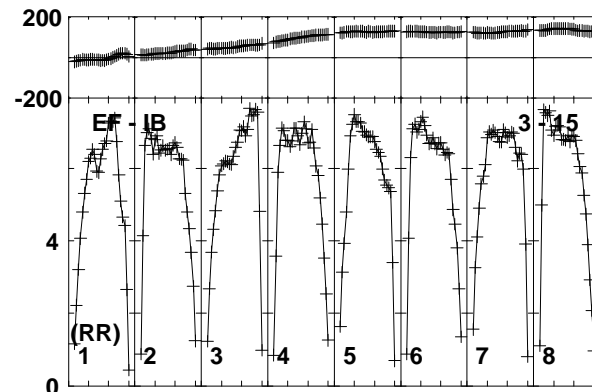
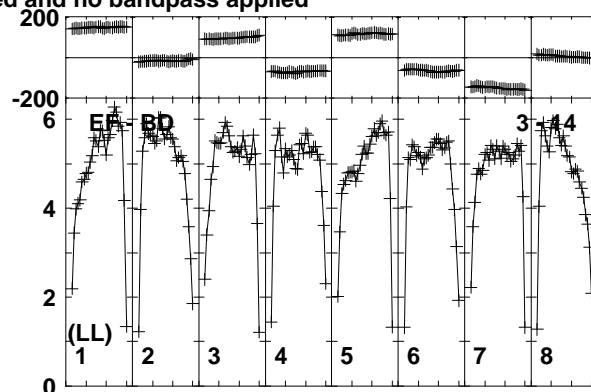
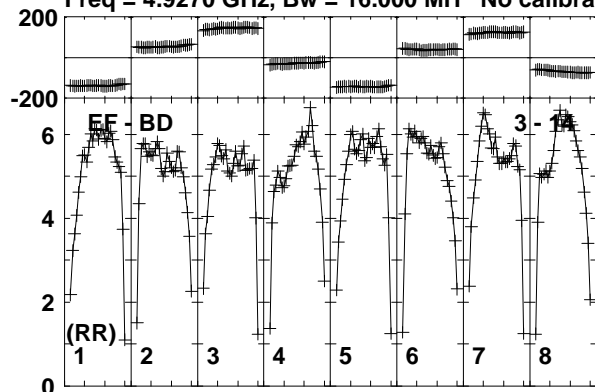

Lower frame: Milli Ampl Jy Top frame: Phas deg  
Vector averaged cross-power spectrum Baseline: EF (03) - BD (14)  
Timerange: 00/11:53:31 to 00/11:54:29

Plot file version 382 created 19-DEC-2018 17:58:40

VLA1 RY007C.UVDATA.1

Freq = 4.9270 GHz, Bw = 16.000 MH No calibration applied and no bandpass applied

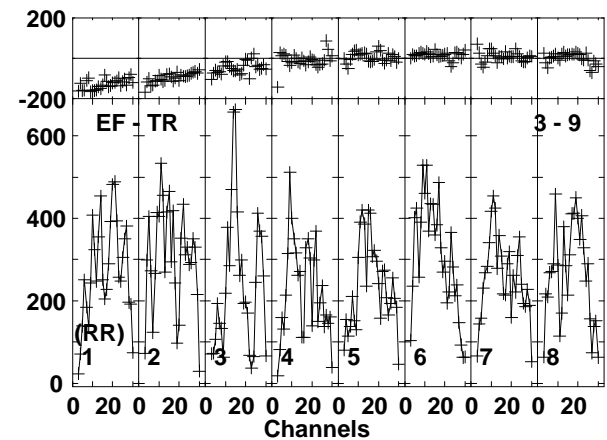
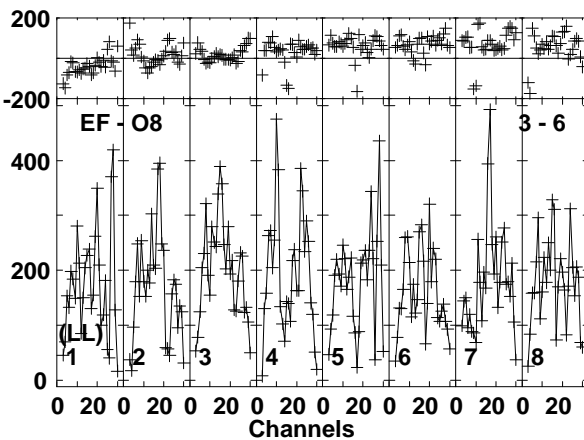
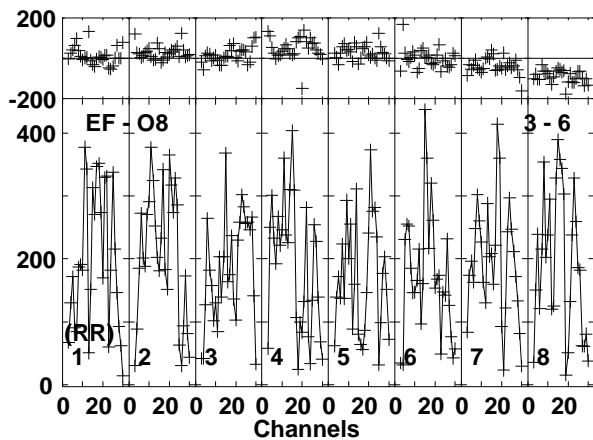
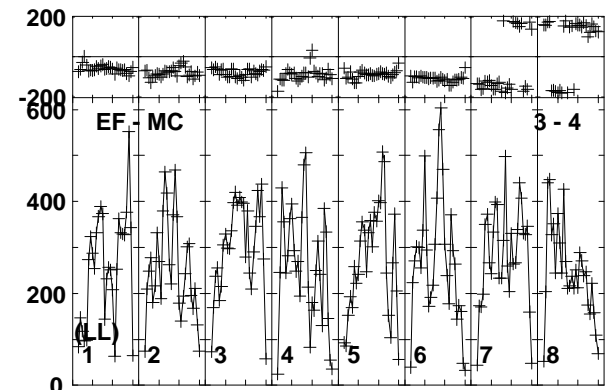
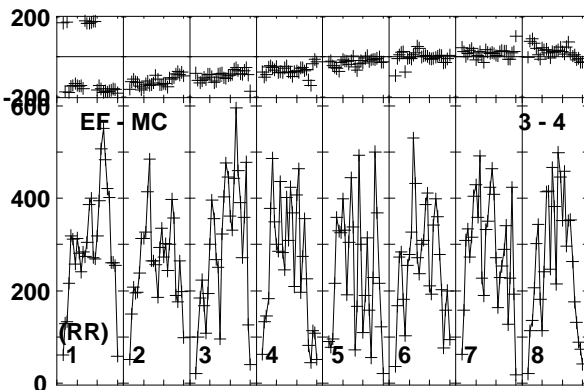
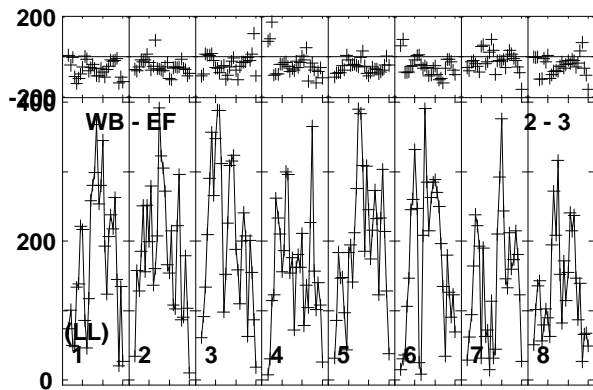
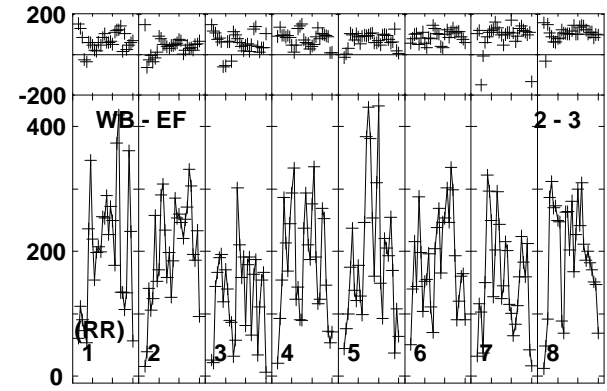
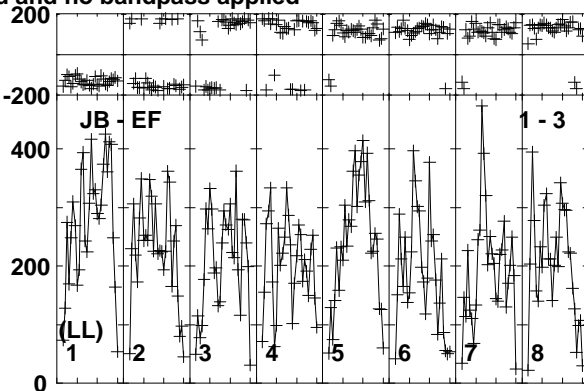
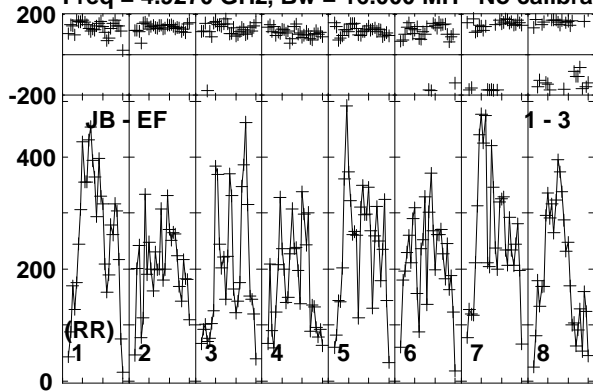

Lower frame: Micro Ampl Jy Top frame: Phas deg  
Vector averaged cross-power spectrum Baseline: JB (01) - EF (03)  
Timerange: 00/11:55:01 to 00/11:56:59

Plot file version 383 created 19-DEC-2018 17:58:40

VLA1 RY007C.UVDATA.1

Freq = 4.9270 GHz, Bw = 16.000 MH No calibration applied and no bandpass applied

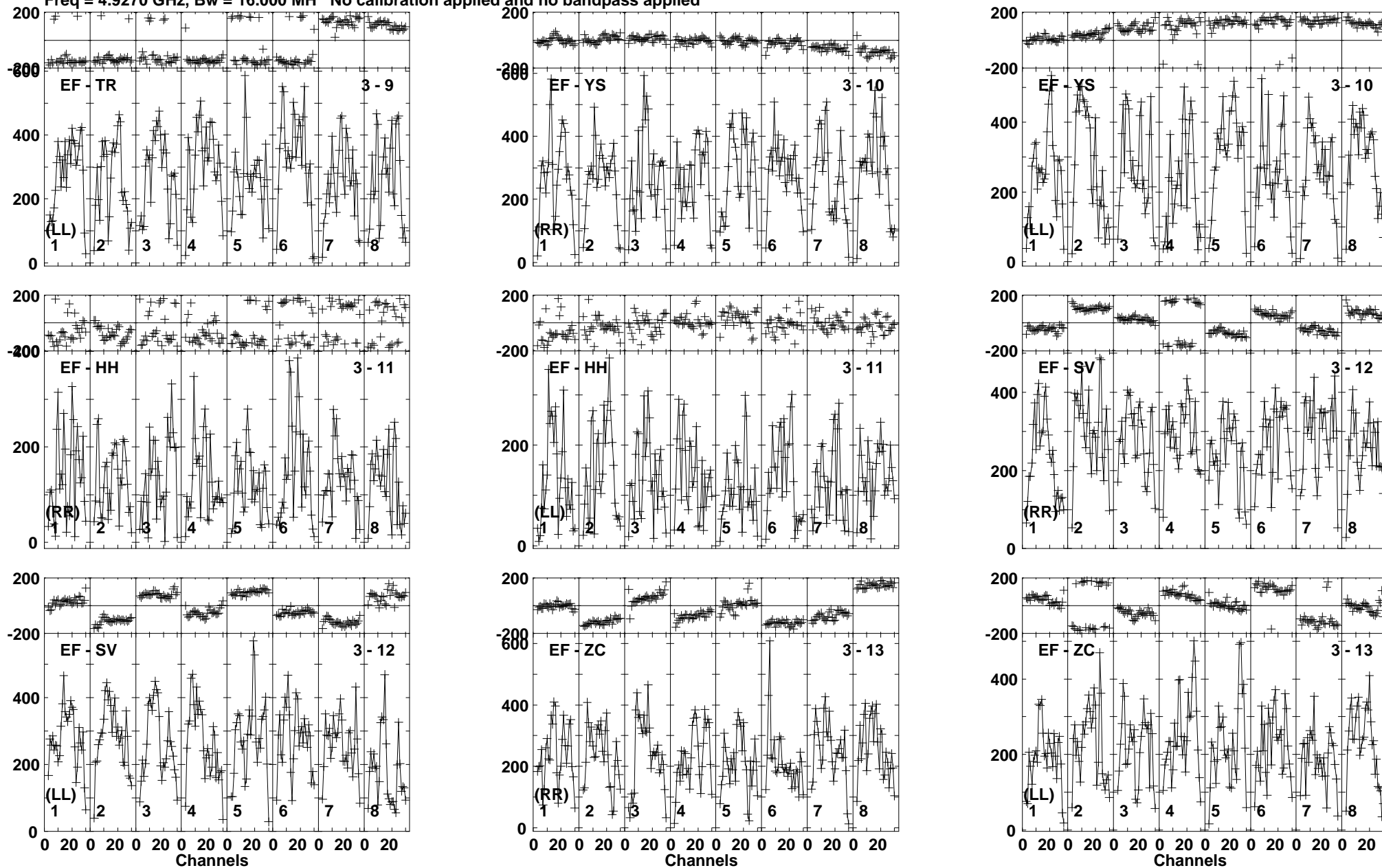

Lower frame: Micro Ampl Jy Top frame: Phas deg  
Vector averaged cross-power spectrum Baseline: EF (03) - TR (09)  
Timerange: 00/11:55:01 to 00/11:56:59

Plot file version 384 created 19-DEC-2018 17:58:41

VLA1 RY007C.UVDATA.1

Freq = 4.9270 GHz, Bw = 16.000 MH No calibration applied and no bandpass applied

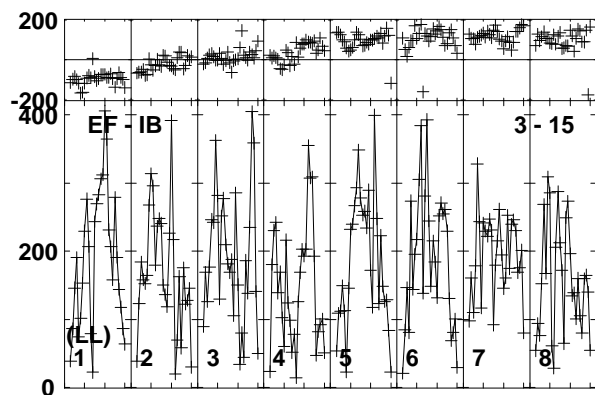
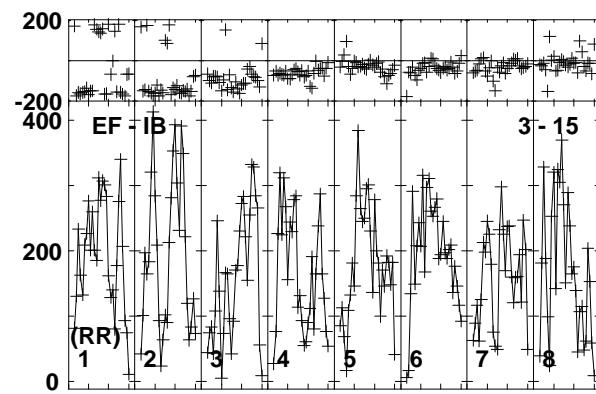
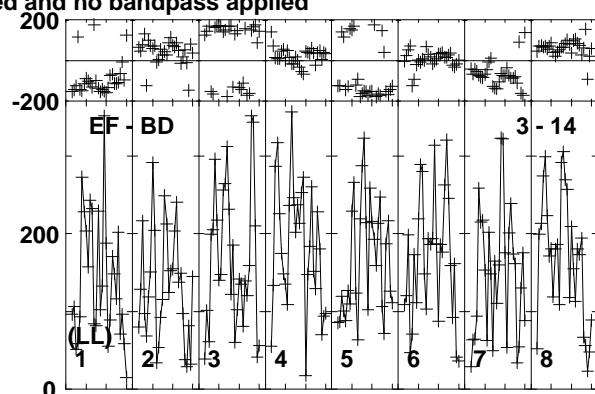
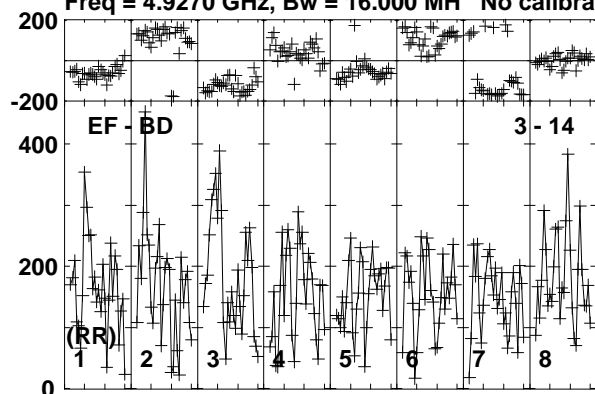

Lower frame: Micro Ampl Jy Top frame: Phas deg  
Vector averaged cross-power spectrum Baseline: EF (03) - BD (14)  
Timerange: 00/11:55:01 to 00/11:56:59

Plot file version 385 created 19-DEC-2018 17:58:41

J1619+2247 RY007C.UVDATA.1

Freq = 4.9270 GHz, Bw = 16.000 MH No calibration applied and no bandpass applied

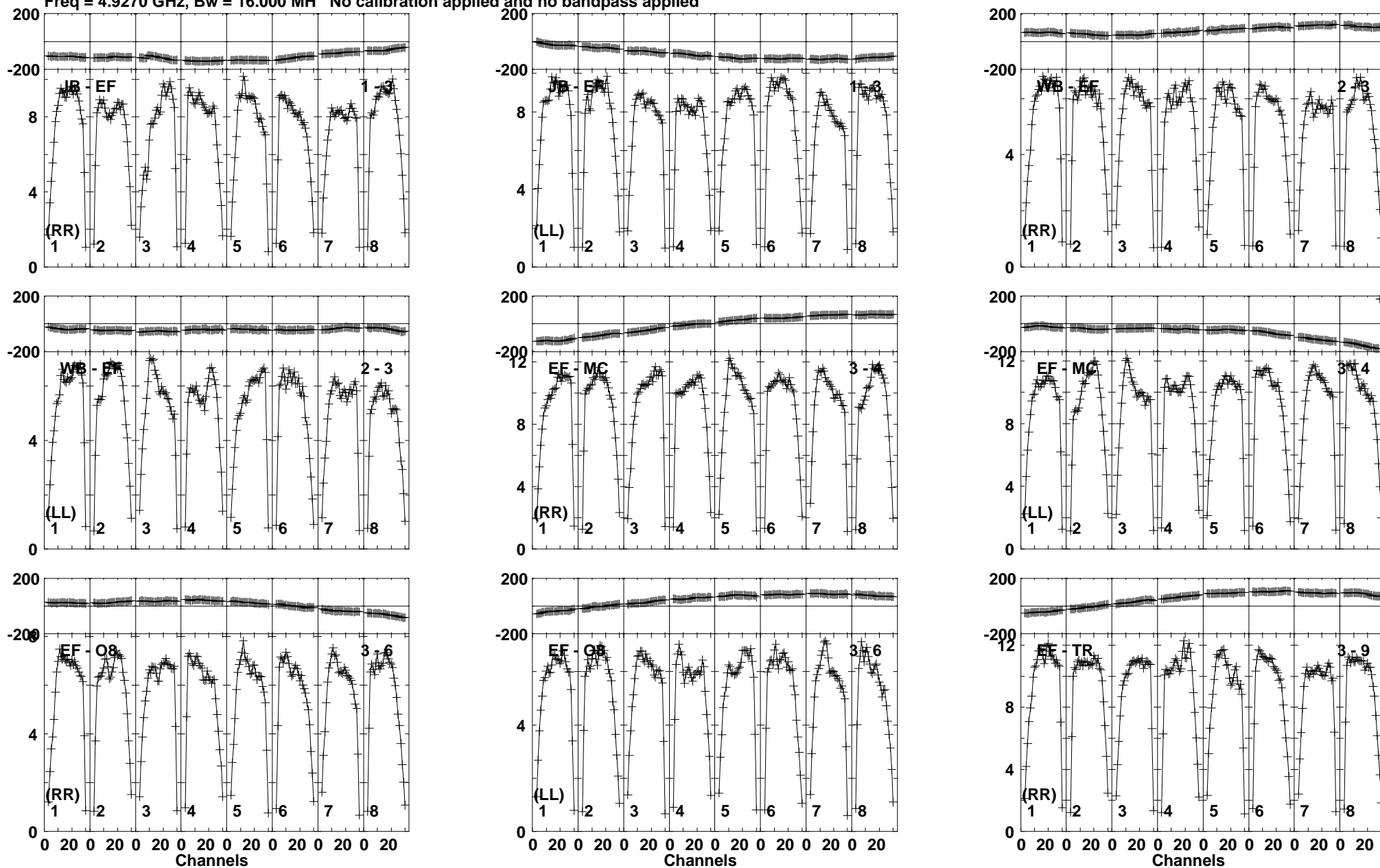

Lower frame: Milli Ampl Jy Top frame: Phas deg  
Vector averaged cross-power spectrum Baseline: JB (01) - EF (03)  
Timerange: 00/11:57:01 to 00/11:57:59

Plot file version 386 created 19-DEC-2018 17:58:41

J1619+2247 RY007C.UVDATA.1

Freq = 4.9270 GHz, Bw = 16.000 MH No calibration applied and no bandpass applied

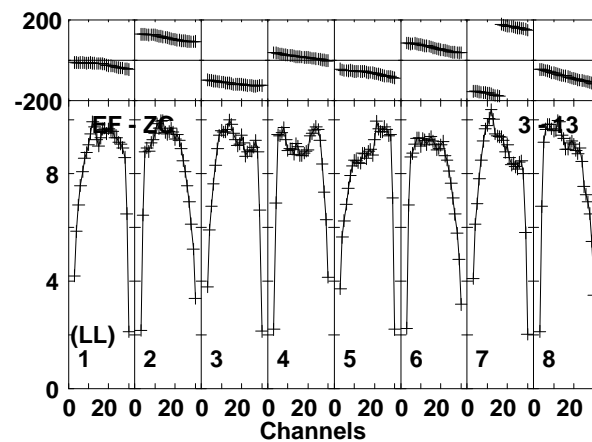
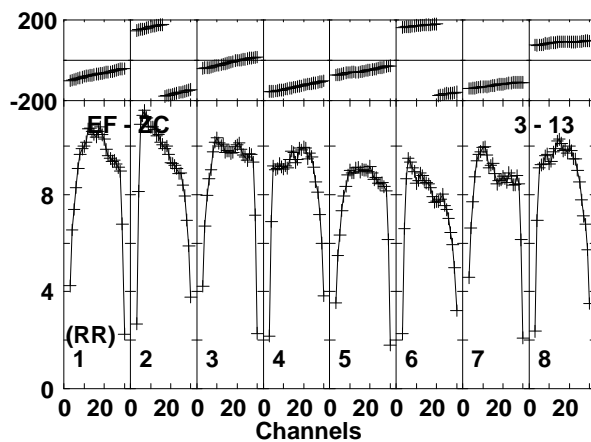
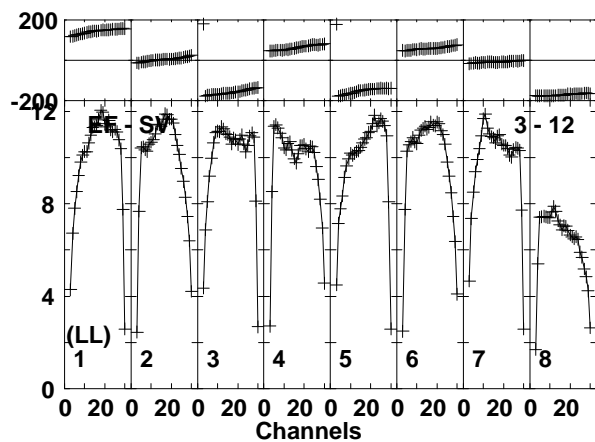
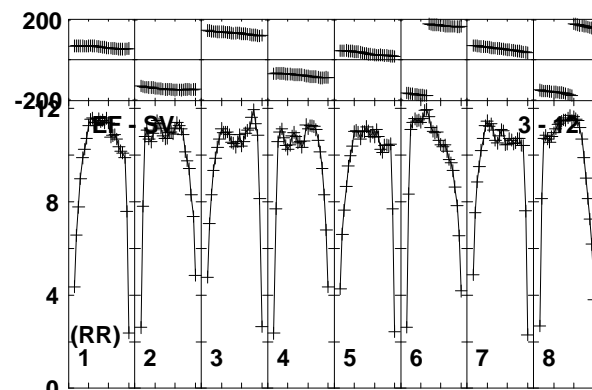
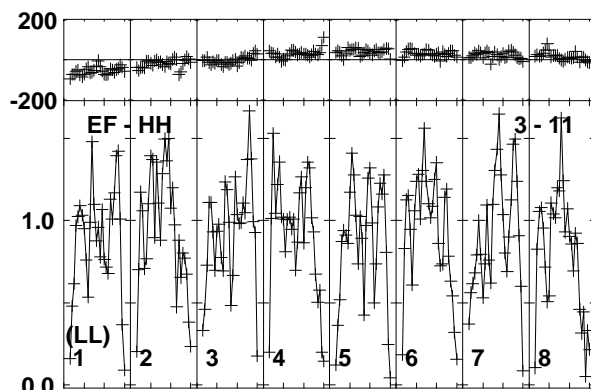
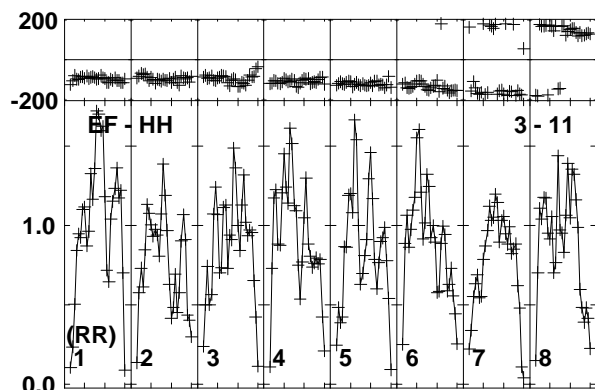
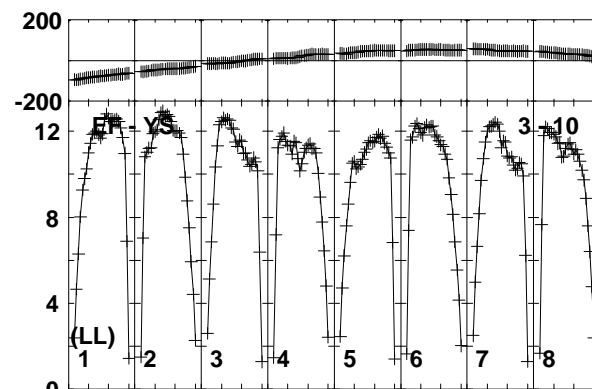
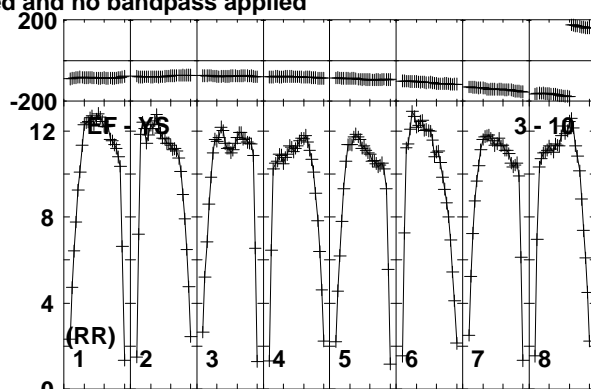
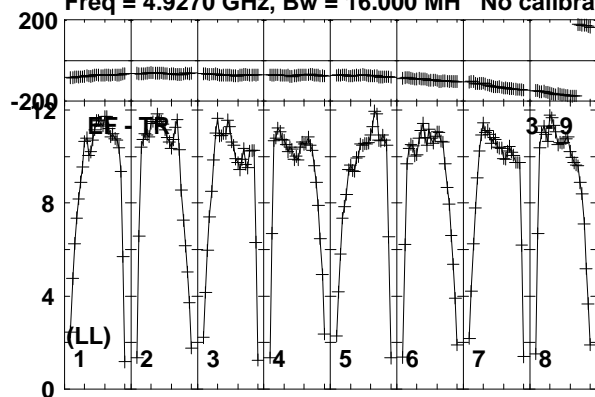

Lower frame: Milli Ampl Jy Top frame: Phas deg  
Vector averaged cross-power spectrum Baseline: EF (03) - TR (09)  
Timerange: 00/11:57:01 to 00/11:57:59



Plot file version 387 created 19-DEC-2018 17:58:41

J1619+2247 RY007C.UVDATA.1

Freq = 4.9270 GHz, Bw = 16.000 MH No calibration applied and no bandpass applied

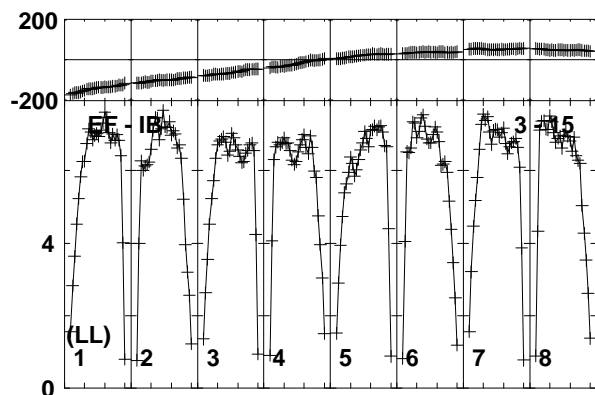
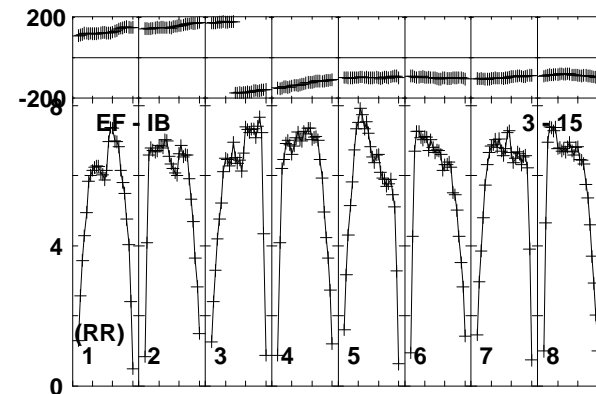
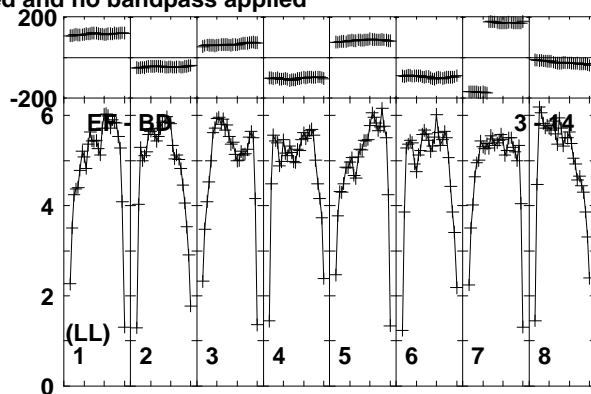
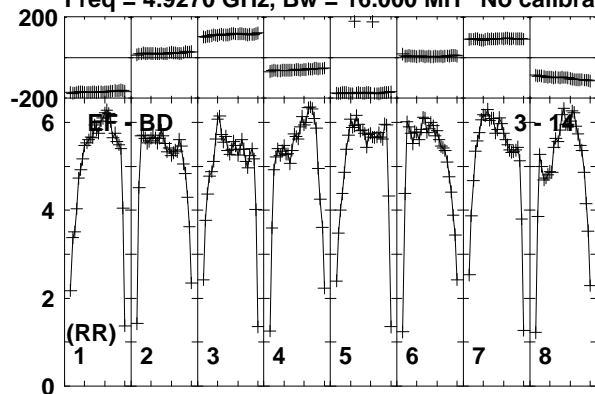

Lower frame: Milli Ampl Jy Top frame: Phas deg  
Vector averaged cross-power spectrum Baseline: EF (03) - BD (14)  
Timerange: 00/11:57:01 to 00/11:57:59

Plot file version 388 created 19-DEC-2018 17:58:41

AT2018\_RY007C.UVDATA.1

Freq = 4.9270 GHz, Bw = 16.000 MH No calibration applied and no bandpass applied

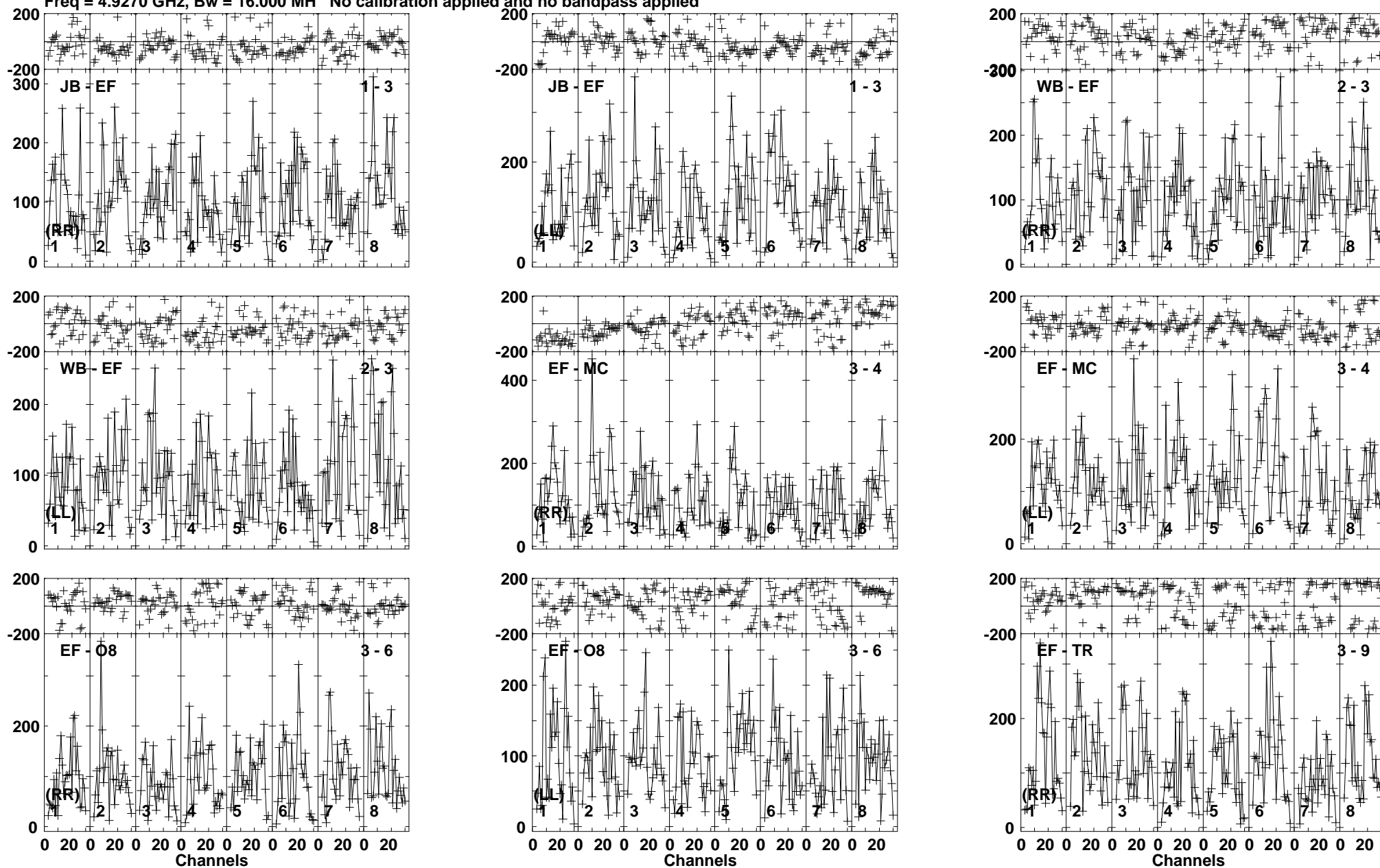

Lower frame: Micro Ampl Jy Top frame: Phas deg  
Vector averaged cross-power spectrum Baseline: JB (01) - EF (03)  
Timerange: 00/11:58:01 to 00/12:00:59

Plot file version 389 created 19-DEC-2018 17:58:41  
AT2018\_RY007C.UVDATA.1

Freq = 4.9270 GHz, Bw = 16.000 MH No calibration applied and no bandpass applied

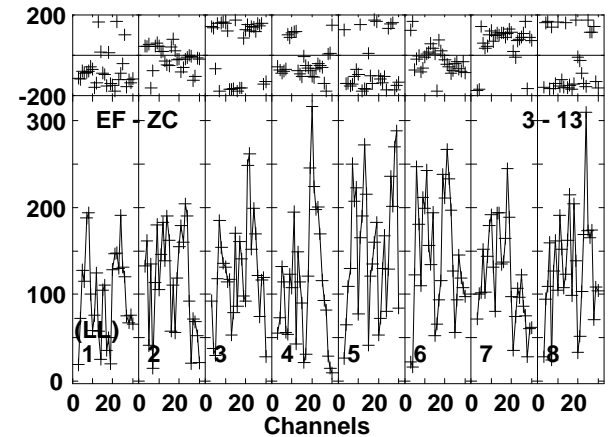
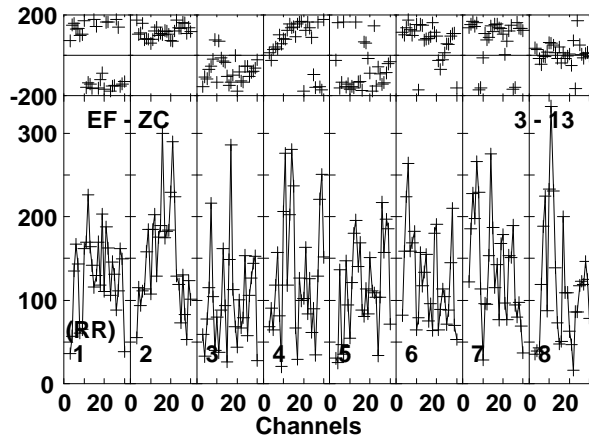
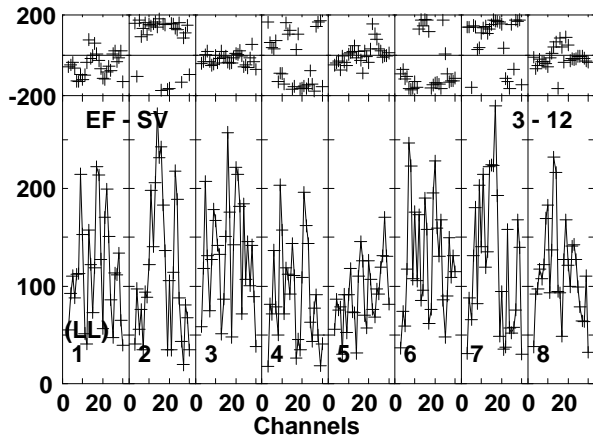
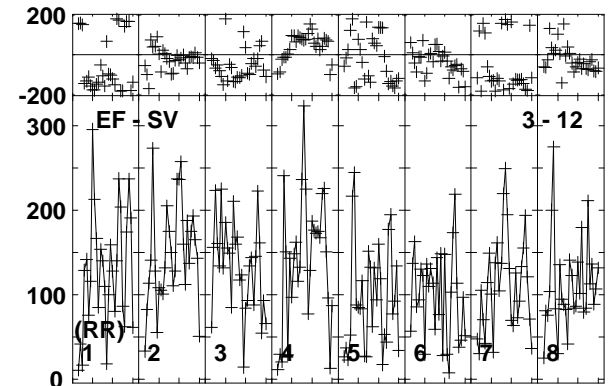
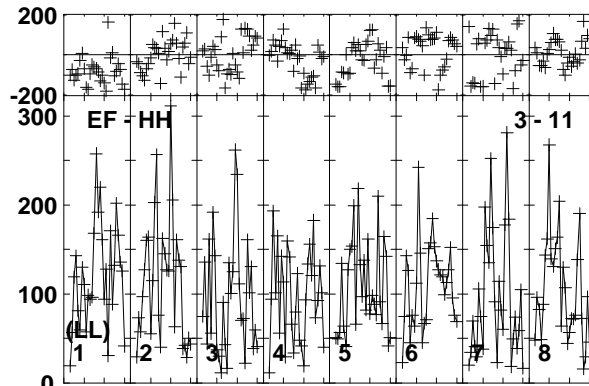
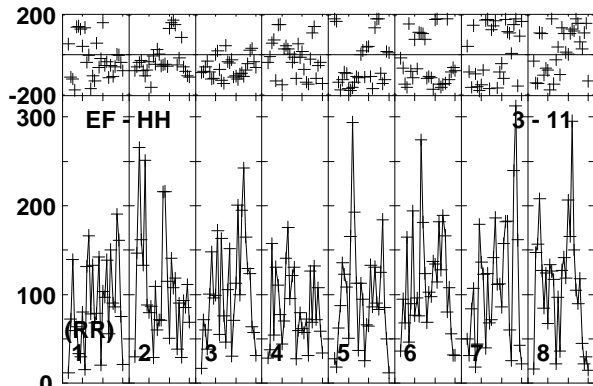
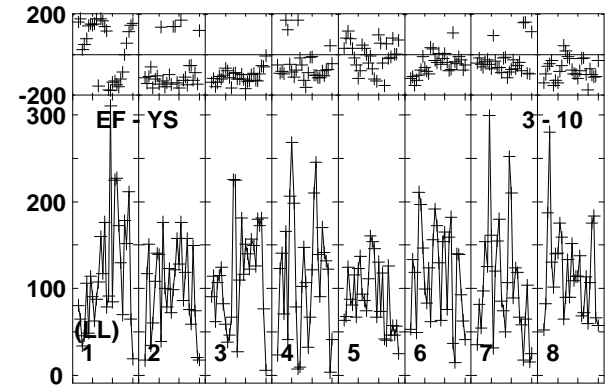
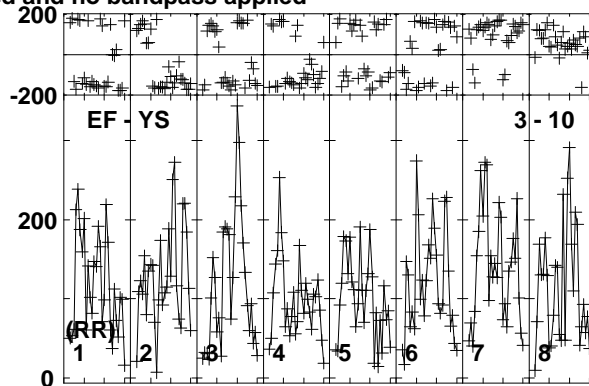
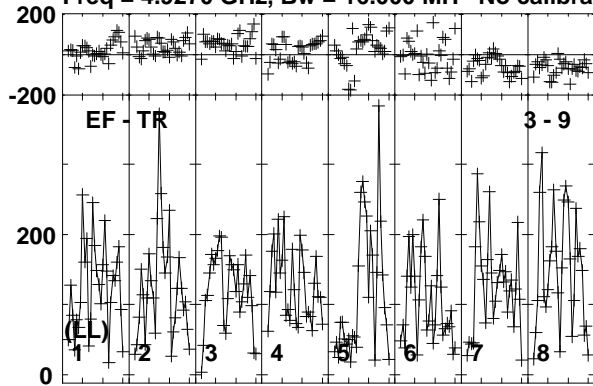

Lower frame: Micro Ampl Jy Top frame: Phas deg  
Vector averaged cross-power spectrum Baseline: EF (03) - TR (09)  
Timerange: 00/11:58:01 to 00/12:00:59

Plot file version 390 created 19-DEC-2018 17:58:41

AT2018\_RY007C.UVDATA.1

Freq = 4.9270 GHz, Bw = 16.000 MH No calibration applied and no bandpass applied

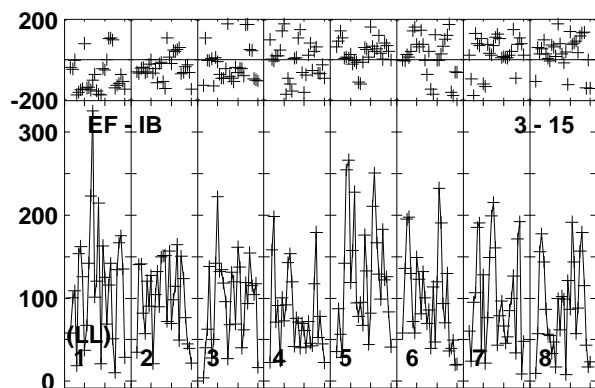
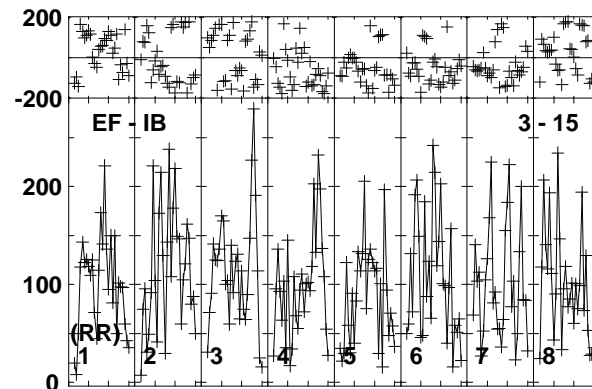
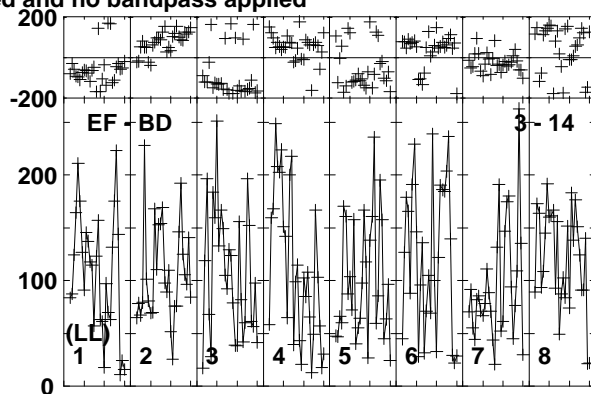
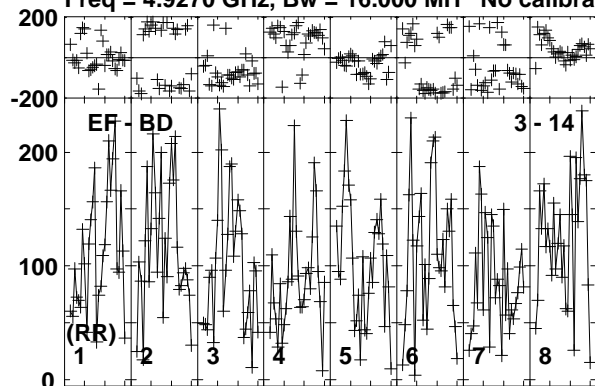

Lower frame: Micro Ampl Jy Top frame: Phas deg  
Vector averaged cross-power spectrum Baseline: EF (03) - BD (14)  
Timerange: 00/11:58:01 to 00/12:00:59

Plot file version 391 created 19-DEC-2018 17:58:41

J1619+2247 RY007C.UVDATA.1

Freq = 4.9270 GHz, Bw = 16.000 MH No calibration applied and no bandpass applied

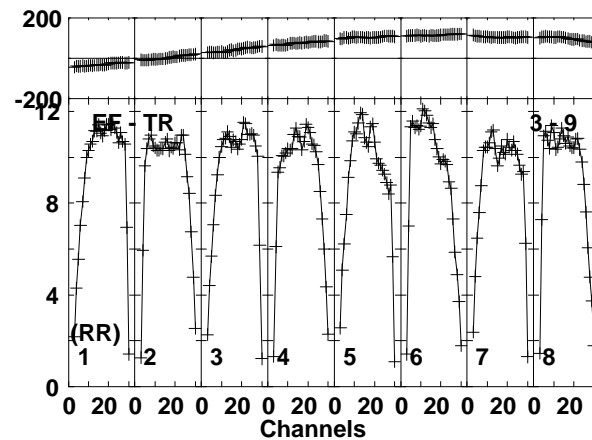
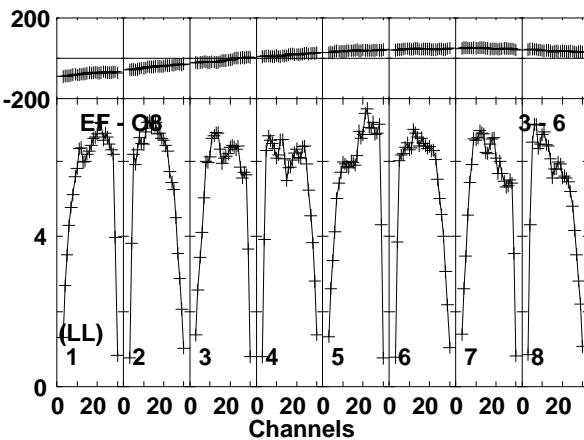
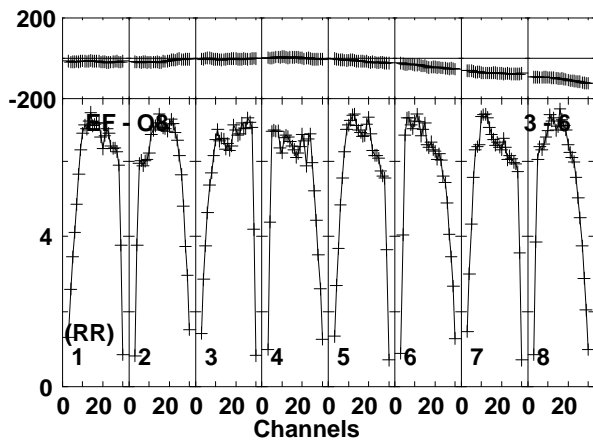
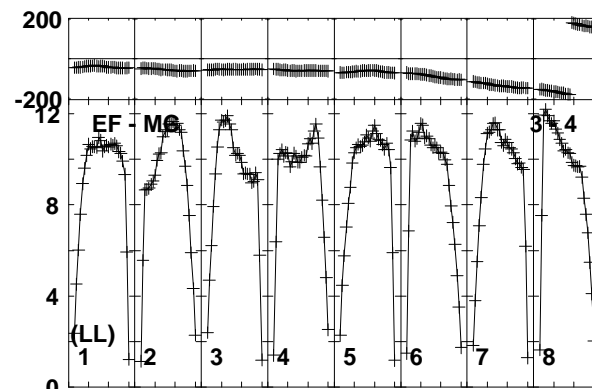
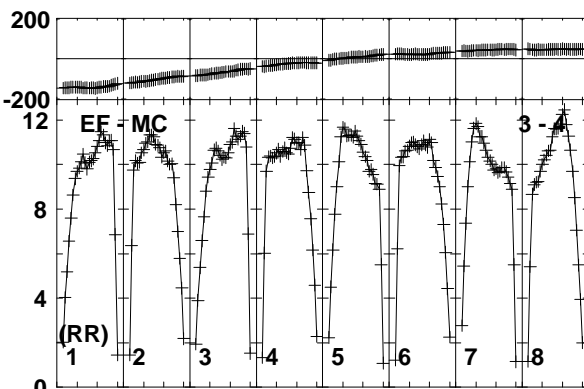
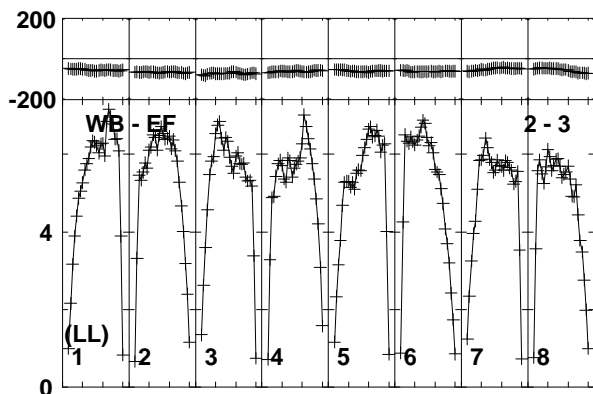
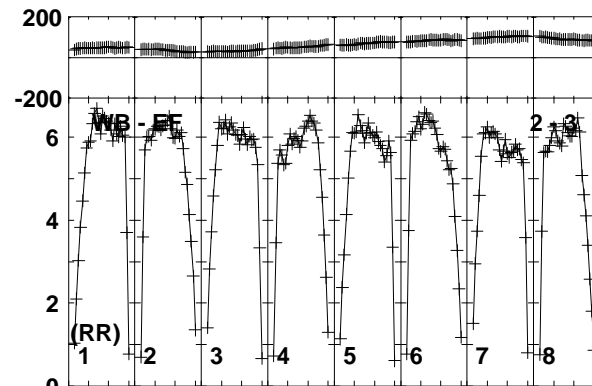
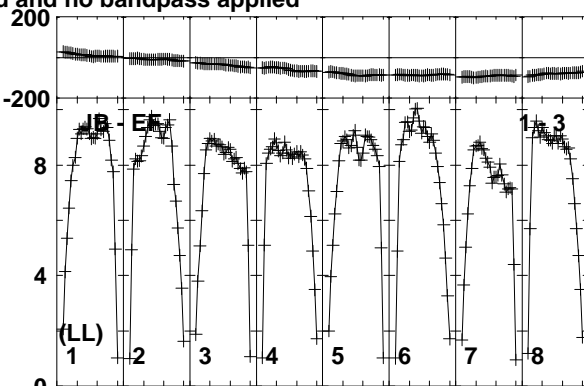
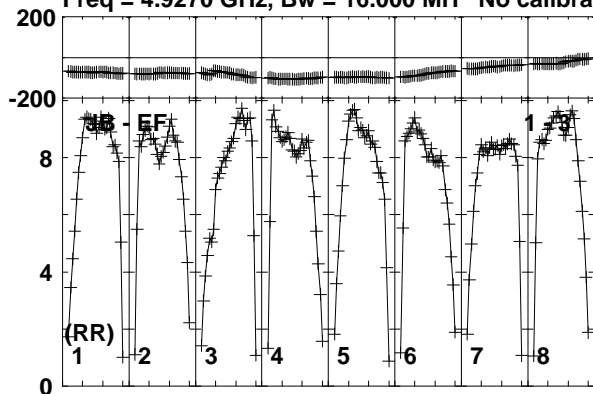

Lower frame: Milli Ampl Jy Top frame: Phas deg  
Vector averaged cross-power spectrum Baseline: JB (01) - EF (03)  
Timerange: 00/12:01:01 to 00/12:01:59

Plot file version 392 created 19-DEC-2018 17:58:41

J1619+2247 RY007C.UVDATA.1

Freq = 4.9270 GHz, Bw = 16.000 MH No calibration applied and no bandpass applied

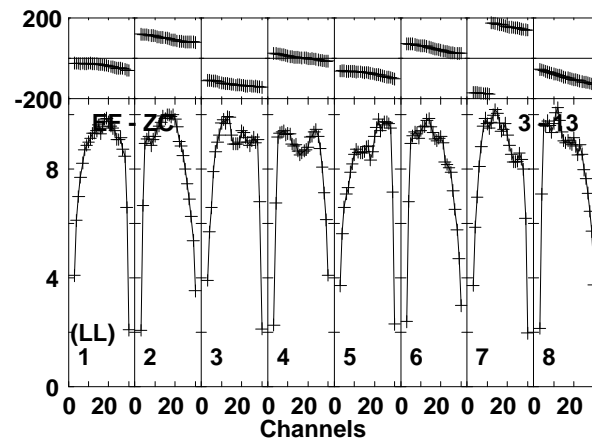
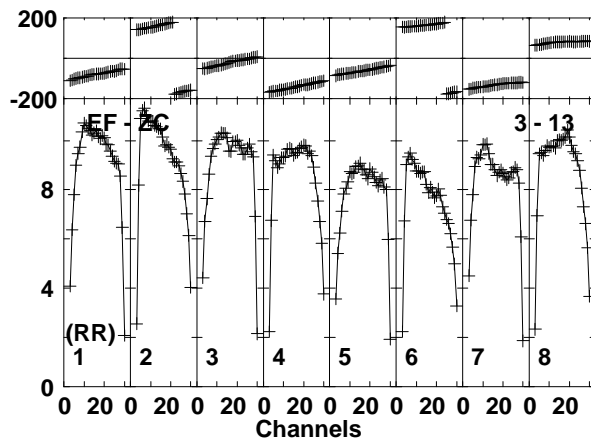
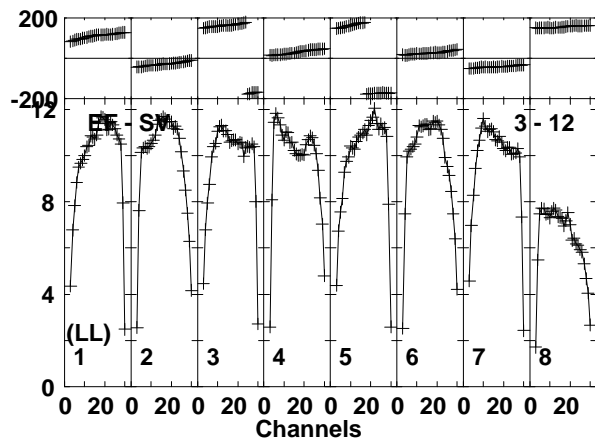
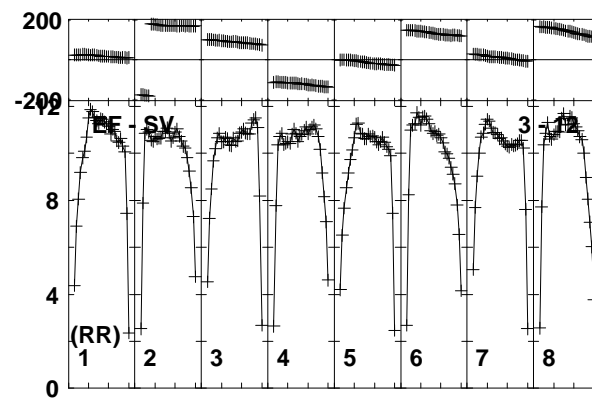
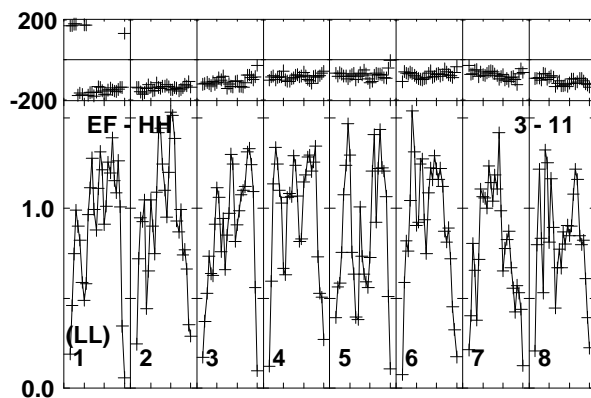
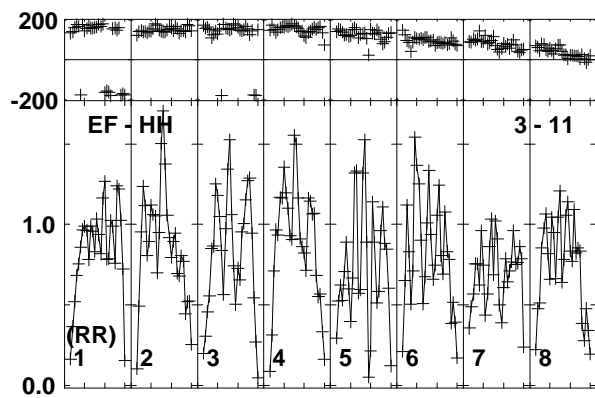
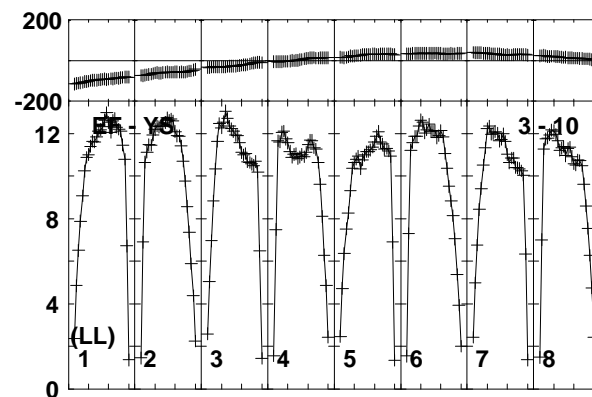
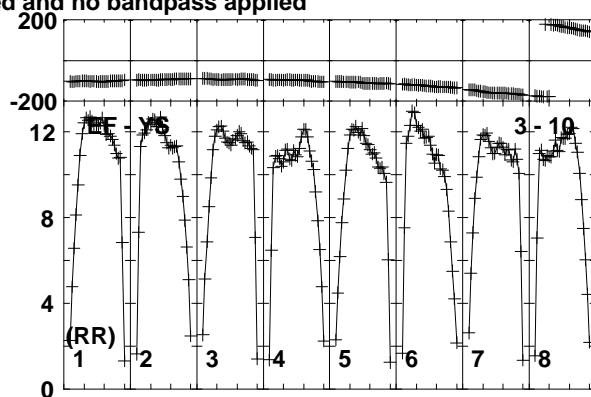
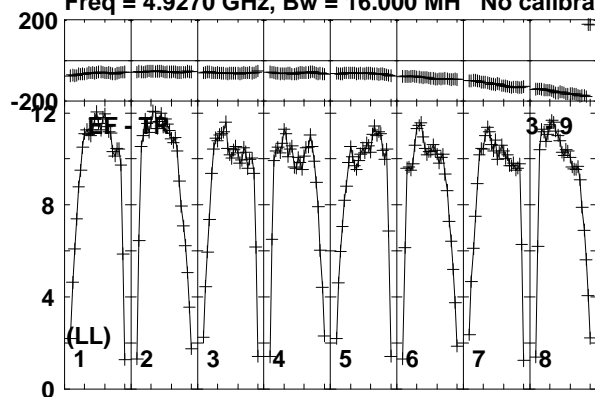

Lower frame: Milli Ampl Jy Top frame: Phas deg  
Vector averaged cross-power spectrum Baseline: EF (03) - TR (09)  
Timerange: 00:12:01:01 to 00:12:01:59

Plot file version 393 created 19-DEC-2018 17:58:41

J1619+2247 RY007C.UVDATA.1

Freq = 4.9270 GHz, Bw = 16.000 MH No calibration applied and no bandpass applied

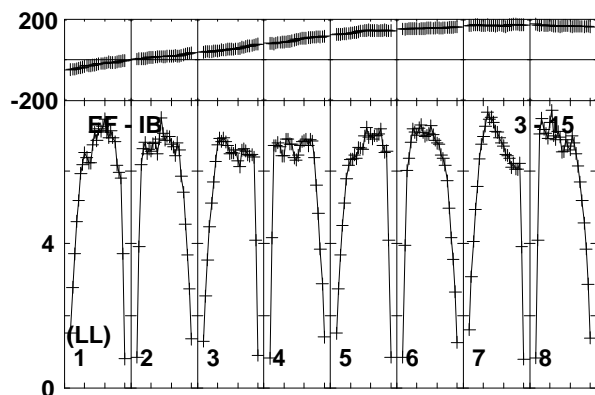
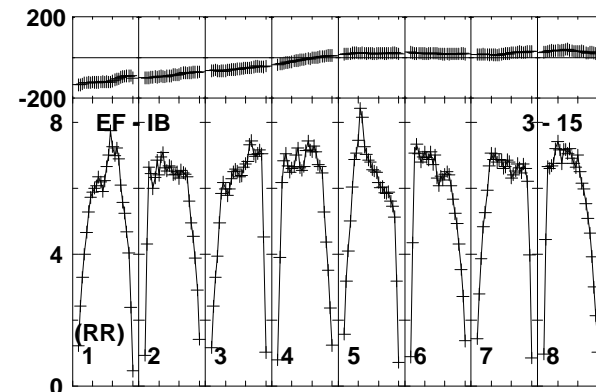
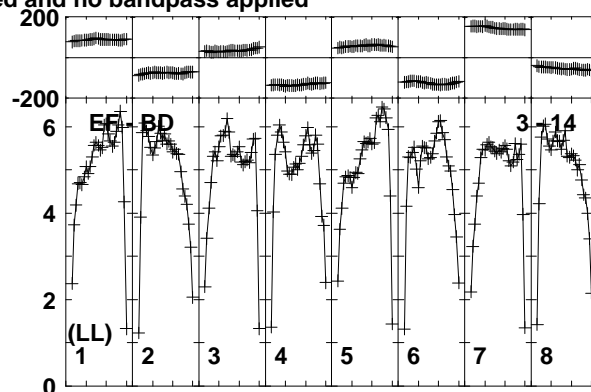
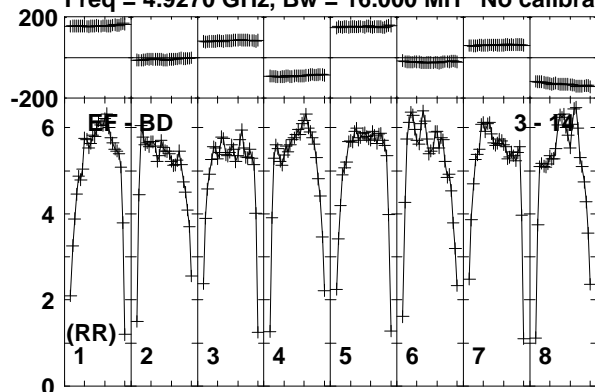

Lower frame: Milli Ampl Jy Top frame: Phas deg  
Vector averaged cross-power spectrum Baseline: EF (03) - BD (14)  
Timerange: 00/12:01:01 to 00/12:01:59

Plot file version 394 created 19-DEC-2018 17:58:41

AT2018\_RY007C.UVDATA.1

Freq = 4.9270 GHz, Bw = 16.000 MH No calibration applied and no bandpass applied

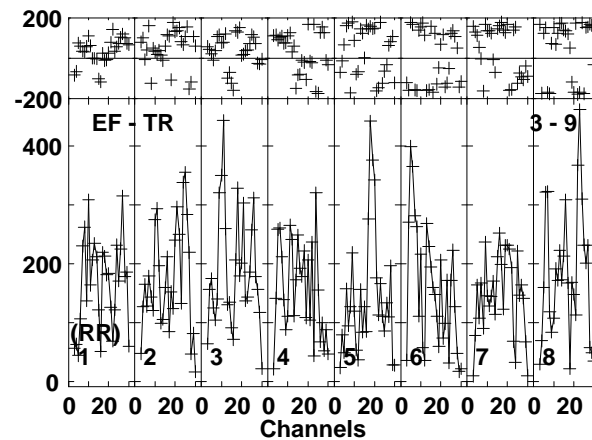
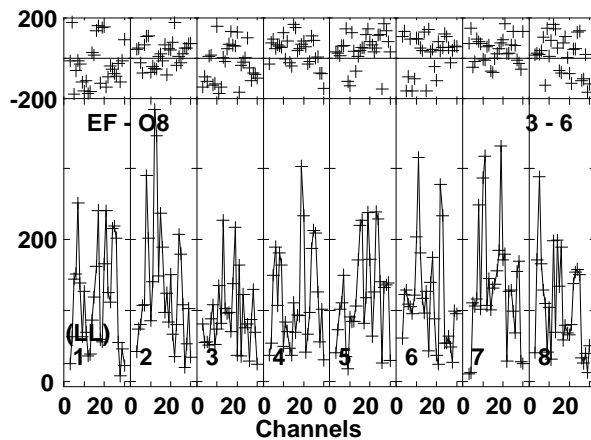
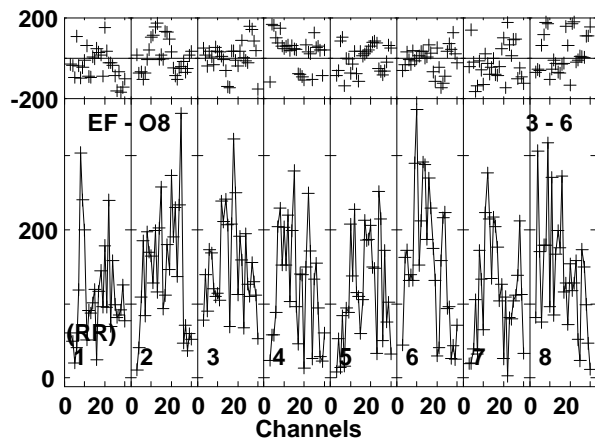
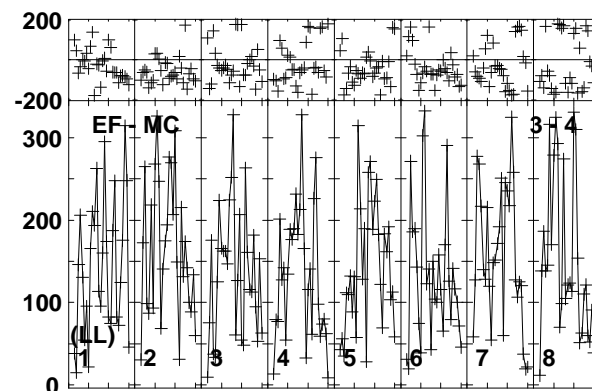
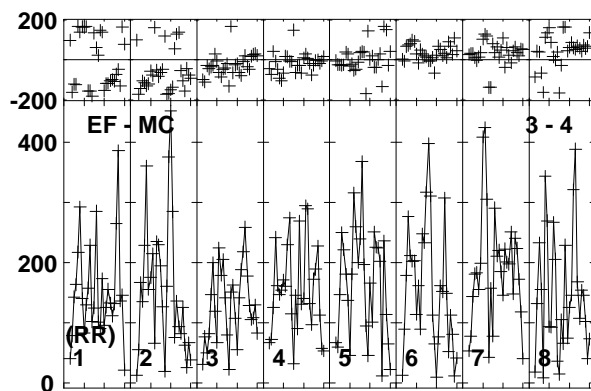
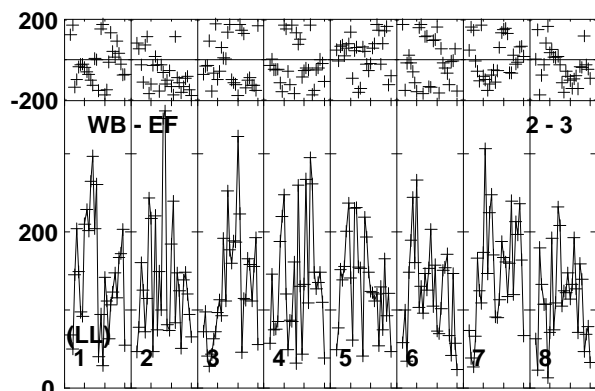
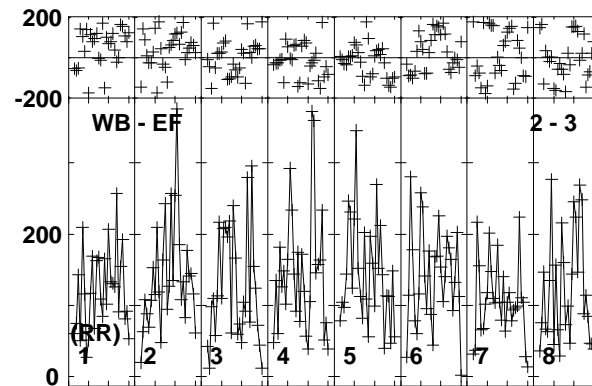
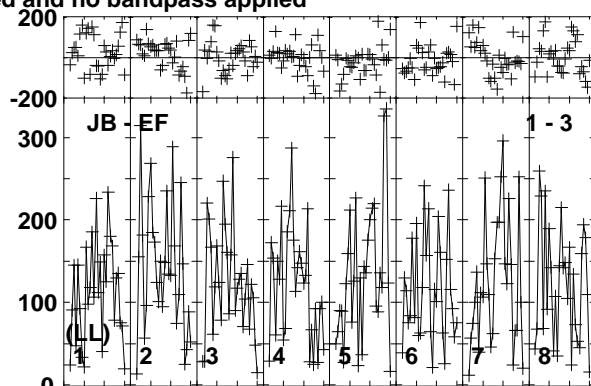
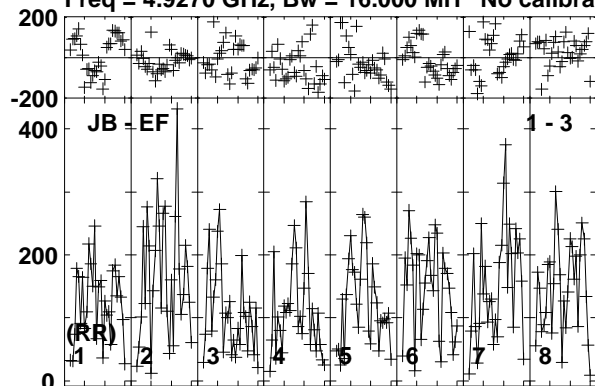

Lower frame: Micro Ampl Jy Top frame: Phas deg  
Vector averaged cross-power spectrum Baseline: JB (01) - EF (03)  
Timerange: 00/12:02:01 to 00/12:03:59



Plot file version 395 created 19-DEC-2018 17:58:41

AT2018\_RY007C.UVDATA.1

Freq = 4.9270 GHz, Bw = 16.000 MH No calibration applied and no bandpass applied

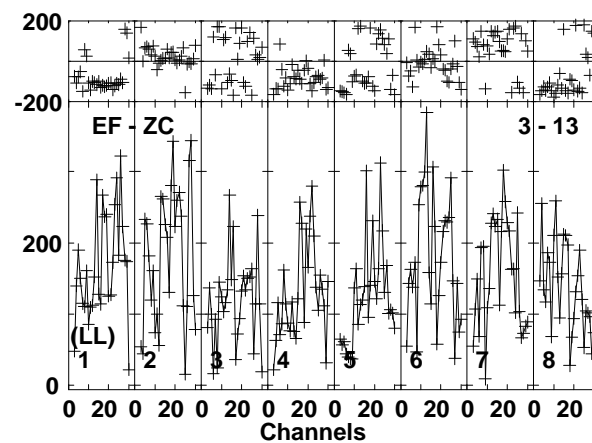
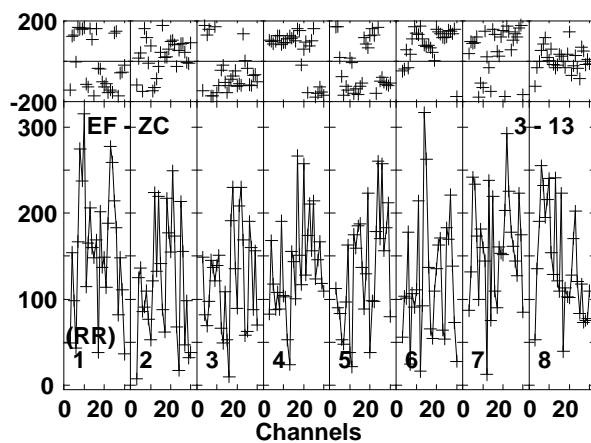
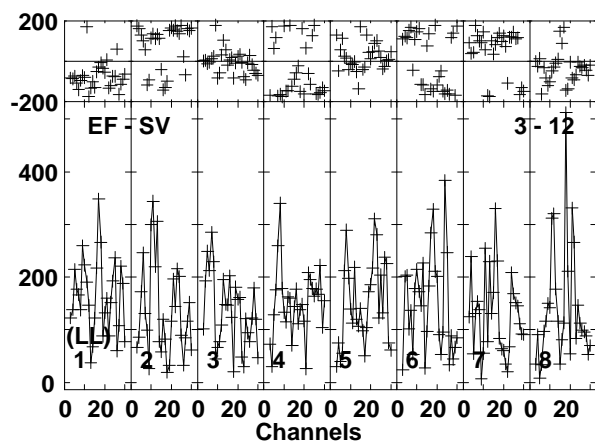
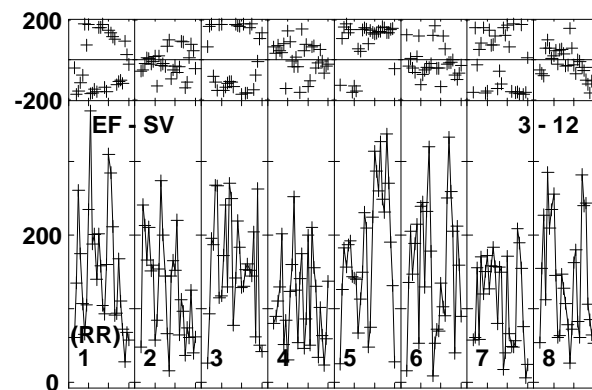
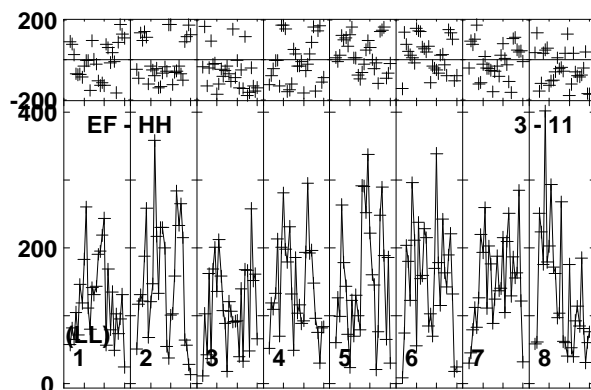
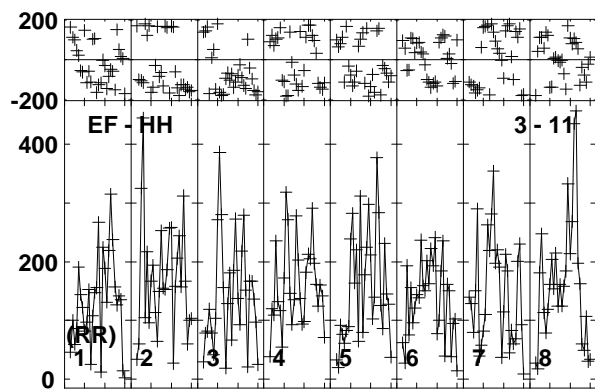
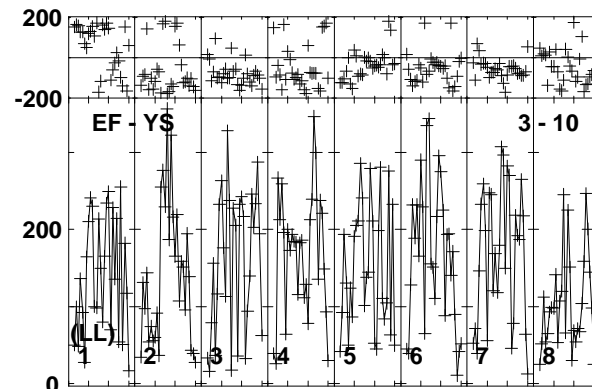
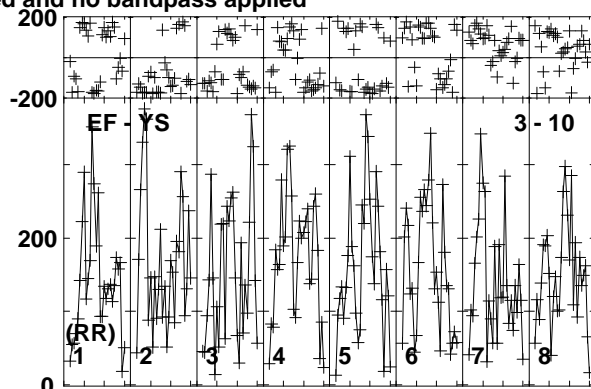
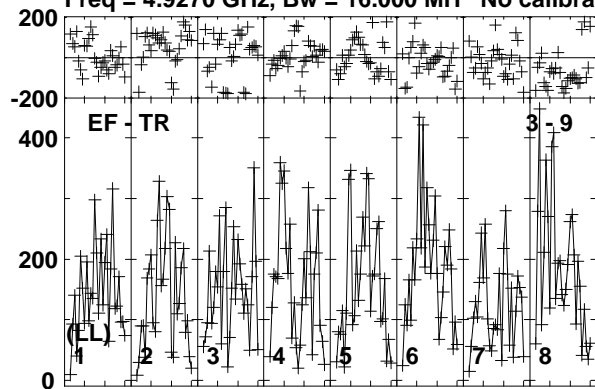

Lower frame: Micro Ampl Jy Top frame: Phas deg  
Vector averaged cross-power spectrum Baseline: EF (03) - TR (09)  
Timerange: 00:12:02:01 to 00:12:03:59

Plot file version 396 created 19-DEC-2018 17:58:41

AT2018\_RY007C.UVDATA.1

Freq = 4.9270 GHz, Bw = 16.000 MH No calibration applied and no bandpass applied

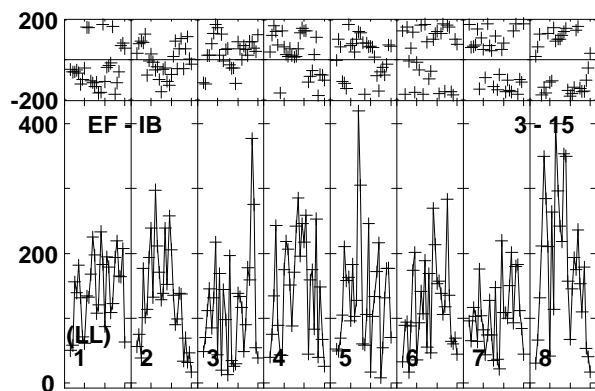
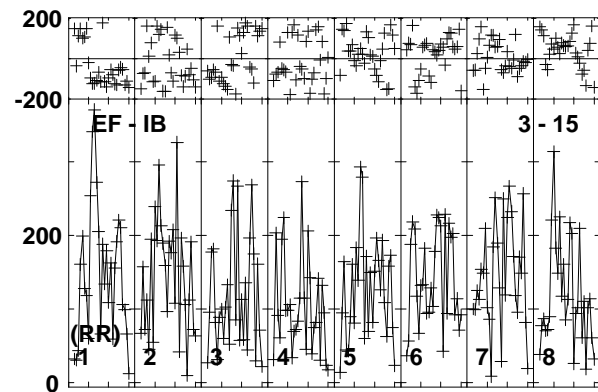
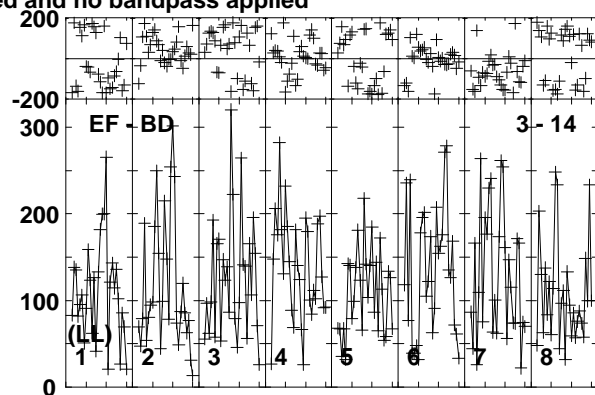
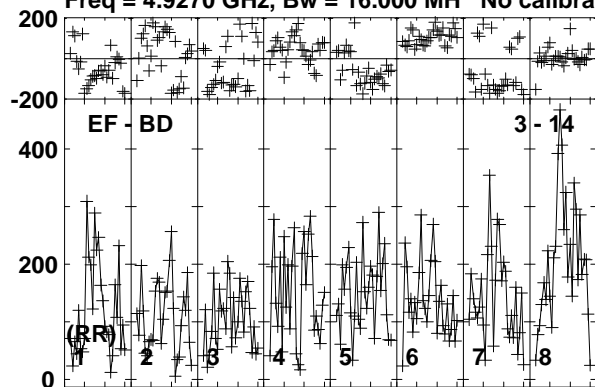

Lower frame: Micro Ampl Jy Top frame: Phas deg  
Vector averaged cross-power spectrum Baseline: EF (03) - BD (14)  
Timerange: 00/12:02:01 to 00/12:03:59

Plot file version 397 created 19-DEC-2018 17:58:41

VLA2 RY007C.UVDATA.1

Freq = 4.9270 GHz, Bw = 16.000 MH No calibration applied and no bandpass applied

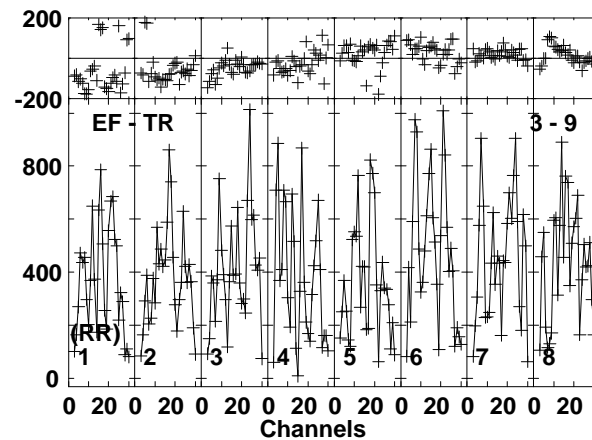
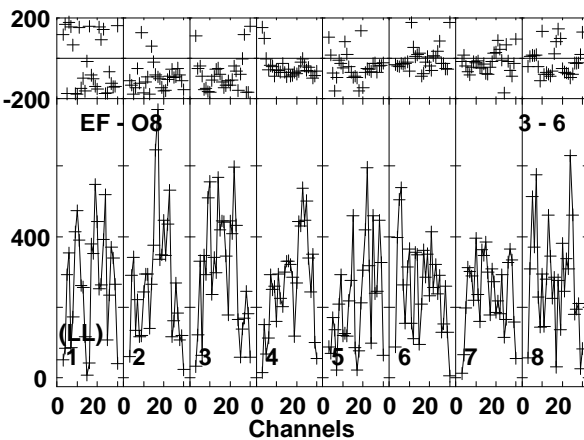
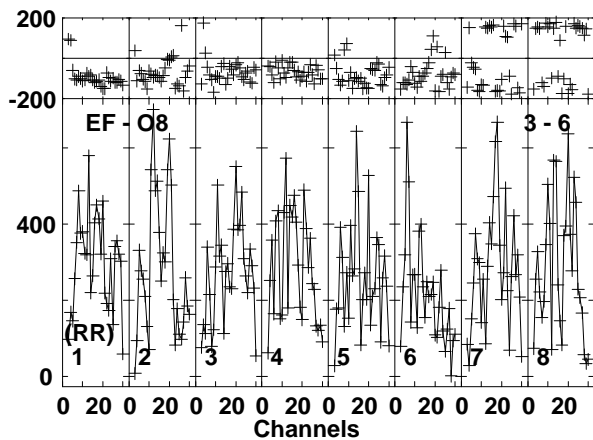
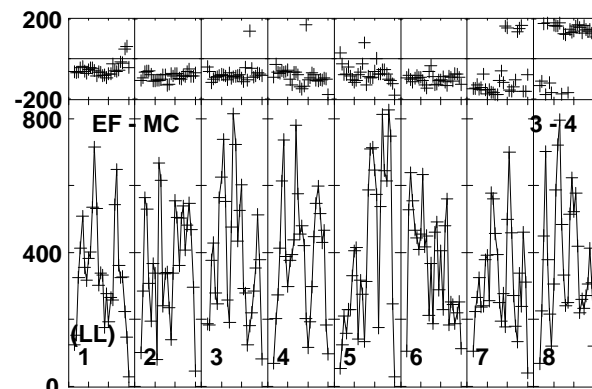
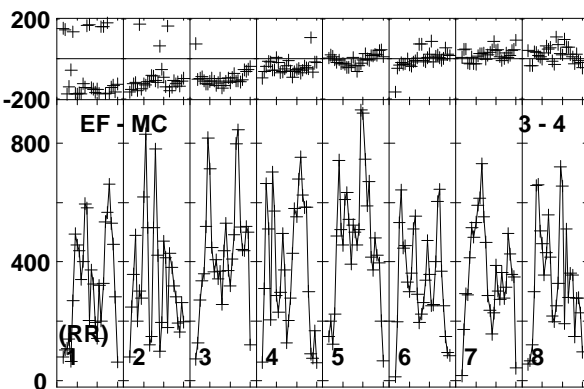
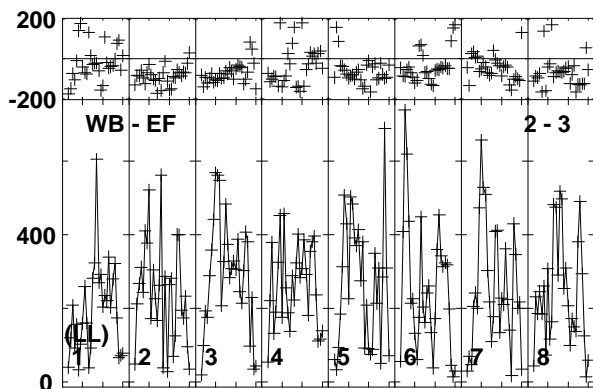
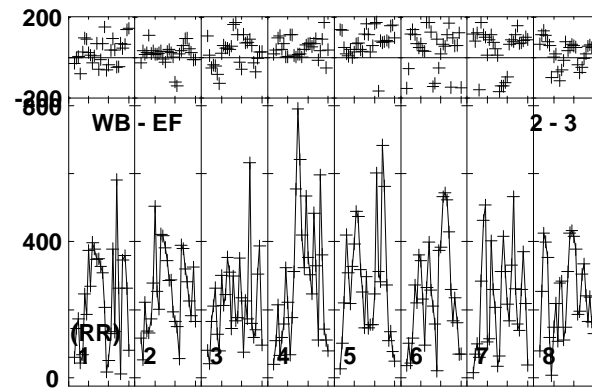
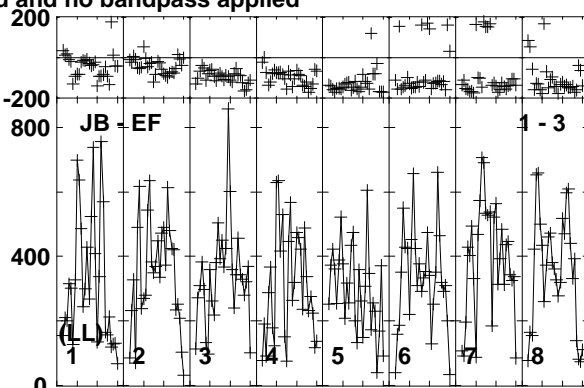
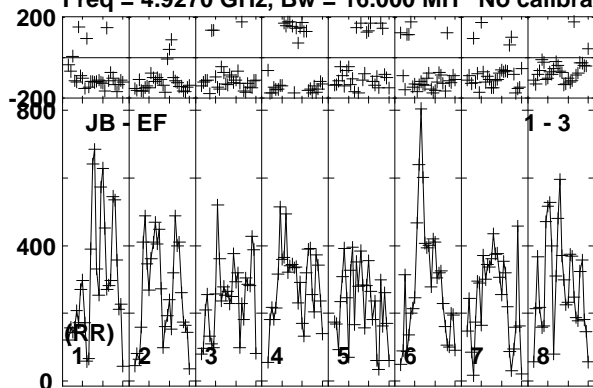

Lower frame: Micro Ampl Jy Top frame: Phas deg  
Vector averaged cross-power spectrum Baseline: JB (01) - EF (03)  
Timerange: 00/12:04:01 to 00/12:04:59

Plot file version 398 created 19-DEC-2018 17:58:41

VLA2 RY007C.UVDATA.1

Freq = 4.9270 GHz, Bw = 16.000 MH No calibration applied and no bandpass applied

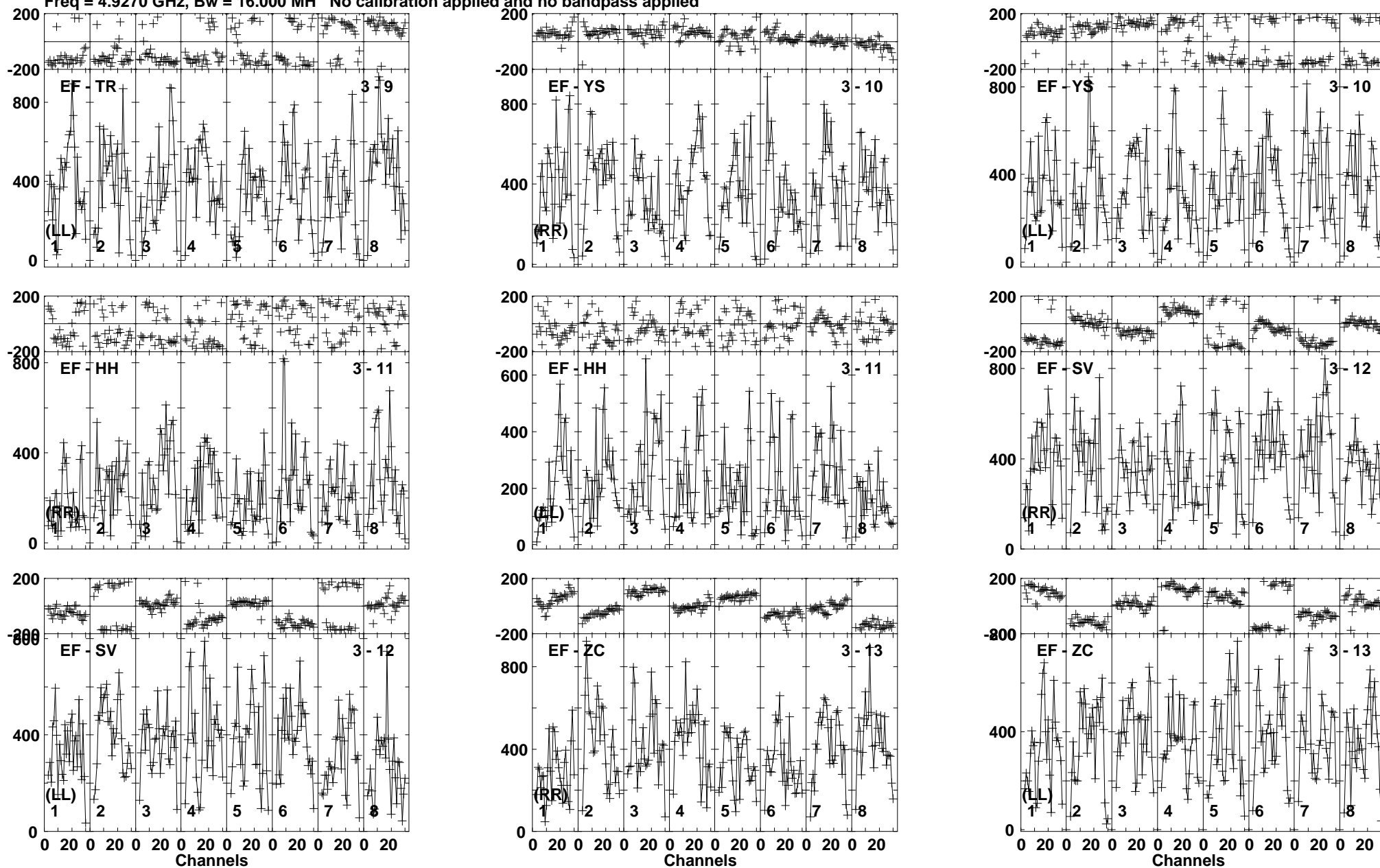

Lower frame: Micro Ampl Jy Top frame: Phas deg  
Vector averaged cross-power spectrum Baseline: EF (03) - TR (09)  
Timerange: 00/12:04:01 to 00/12:04:59

Plot file version 399 created 19-DEC-2018 17:58:41

VLA2 RY007C.UVDATA.1

Freq = 4.9270 GHz, Bw = 16.000 MH No calibration applied and no bandpass applied

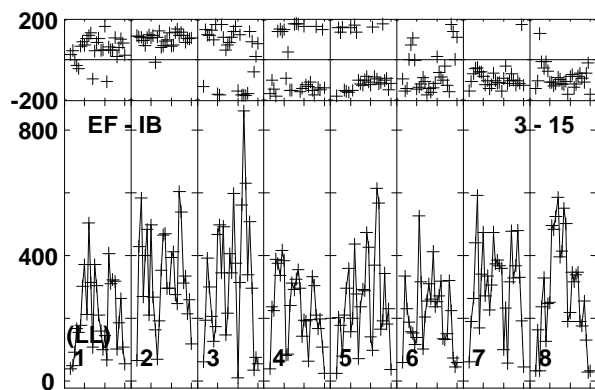
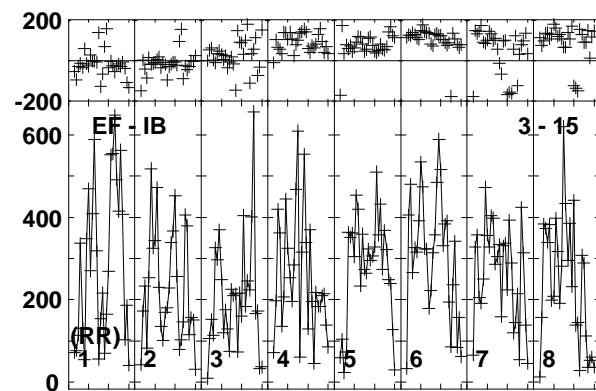
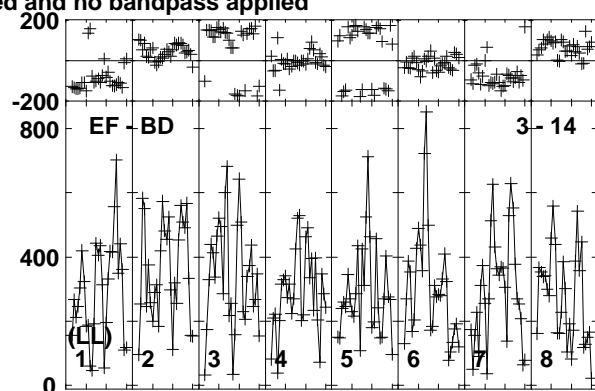
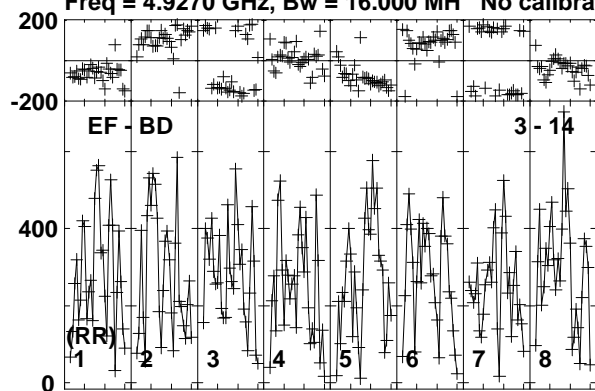

Lower frame: Micro Ampl Jy Top frame: Phas deg  
Vector averaged cross-power spectrum Baseline: EF (03) - BD (14)  
Timerange: 00/12:04:01 to 00/12:04:59

Plot file version 400 created 19-DEC-2018 17:58:41

J1619+2247 RY007C.UVDATA.1

Freq = 4.9270 GHz, Bw = 16.000 MH No calibration applied and no bandpass applied

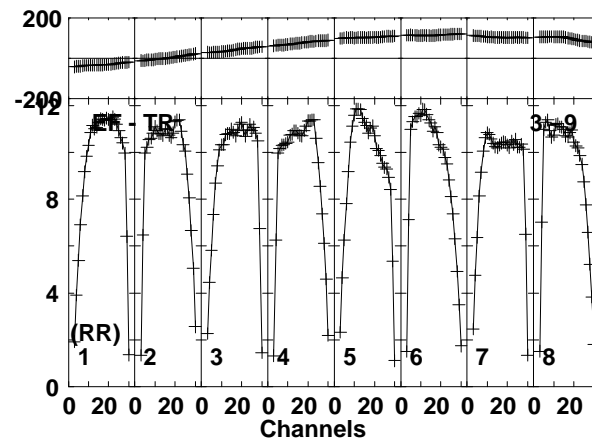
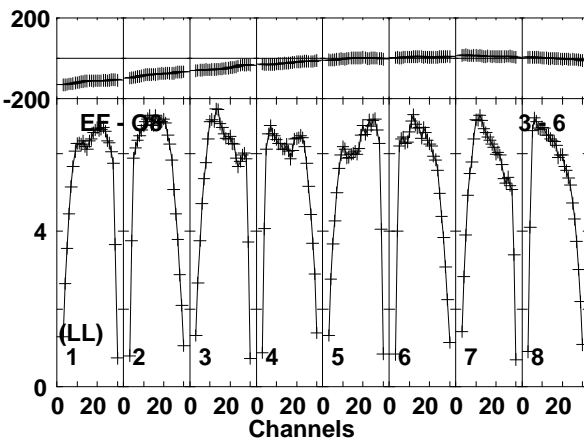
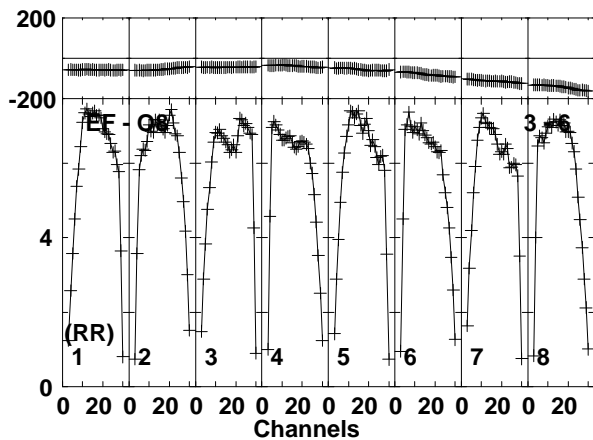
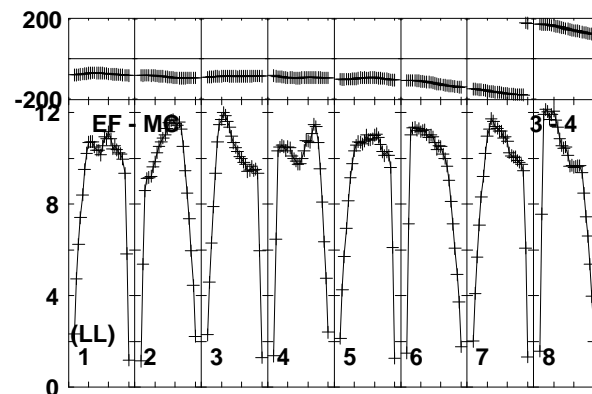
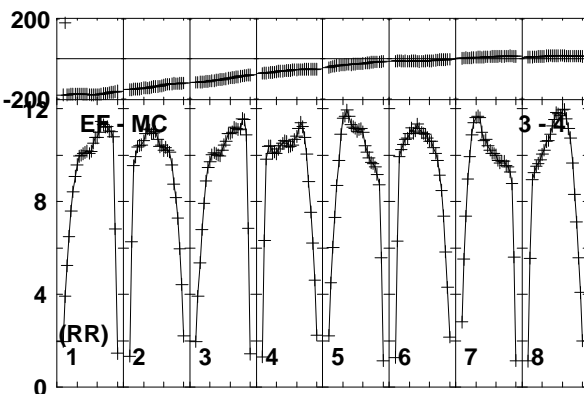
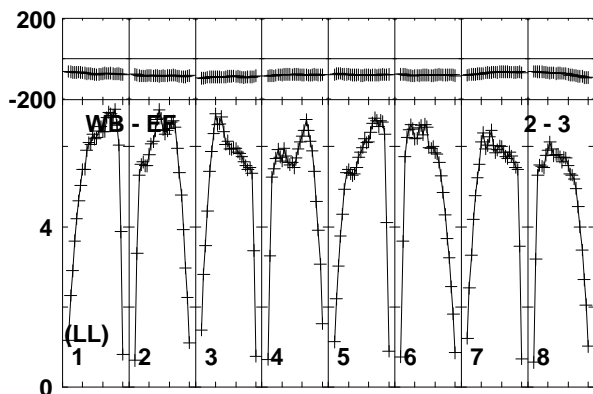
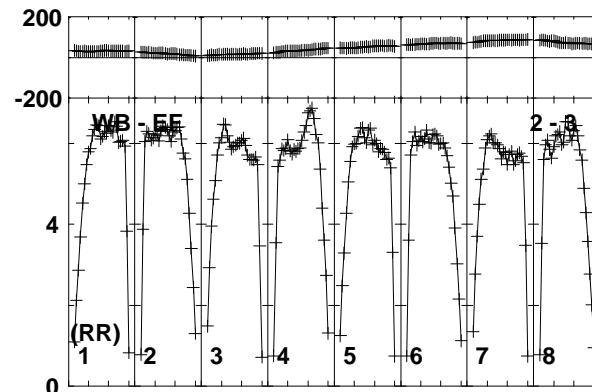
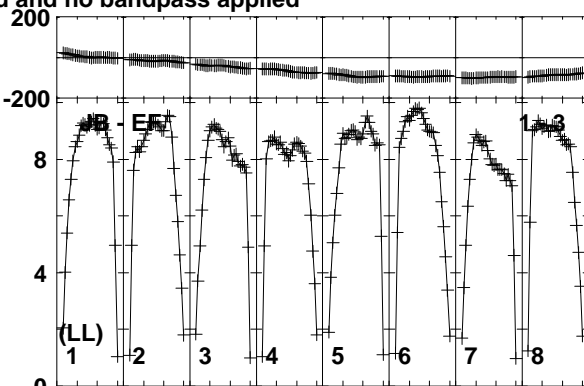
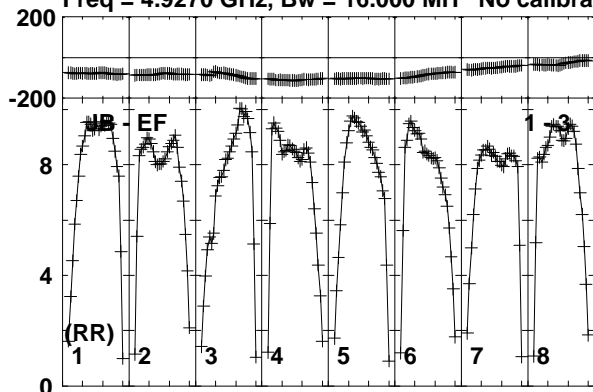

Lower frame: Milli Ampl Jy Top frame: Phas deg  
Vector averaged cross-power spectrum Baseline: JB (01) - EF (03)  
Timerange: 00/12:05:31 to 00/12:06:29

Plot file version 401 created 19-DEC-2018 17:58:41

J1619+2247 RY007C.UVDATA.1

Freq = 4.9270 GHz, Bw = 16.000 MH No calibration applied and no bandpass applied

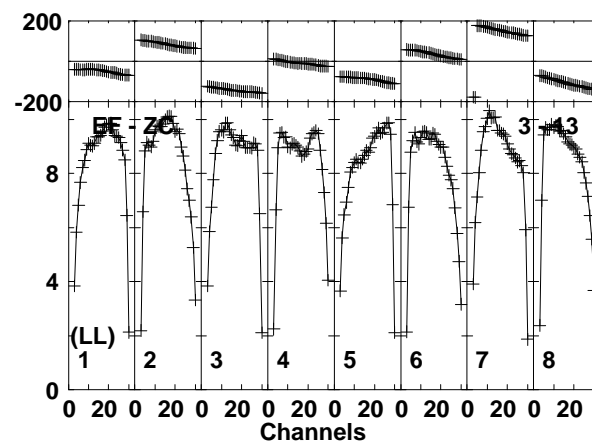
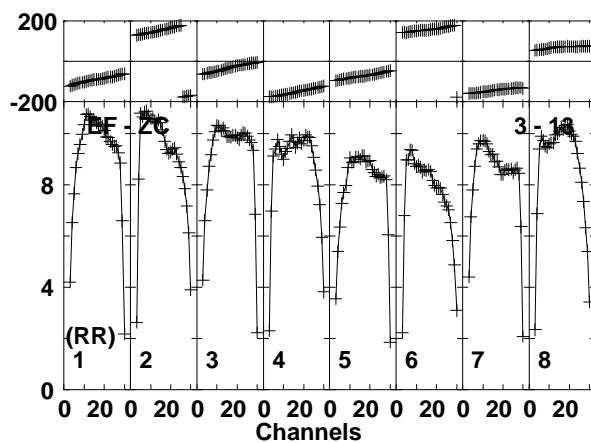
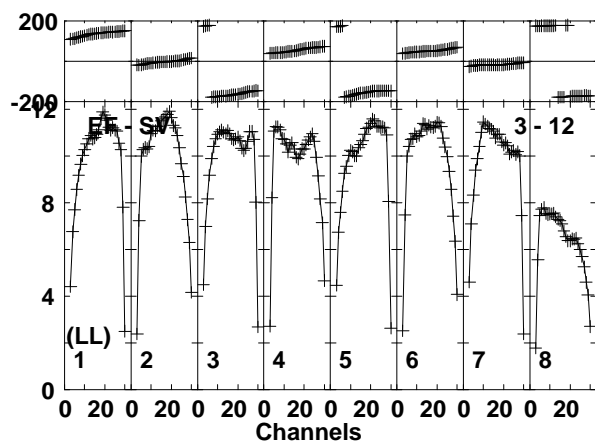
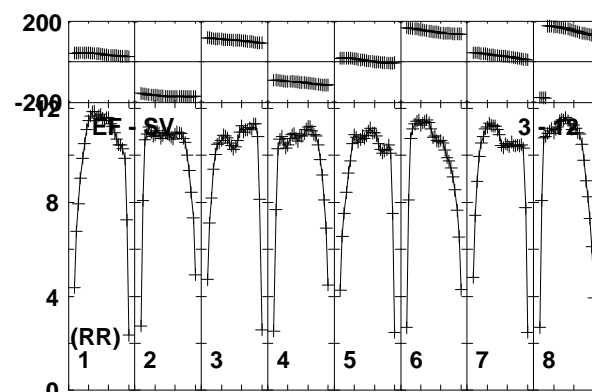
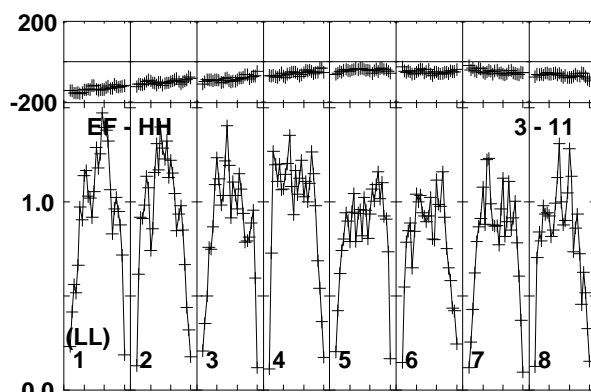
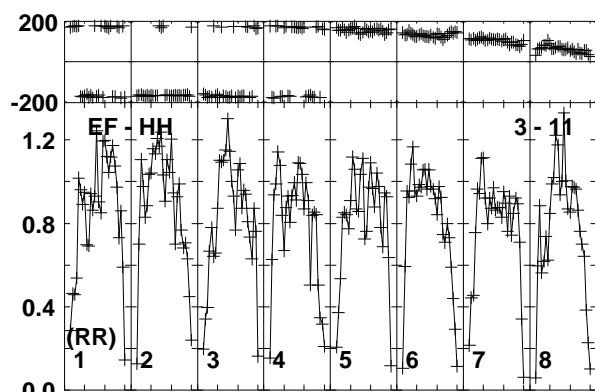
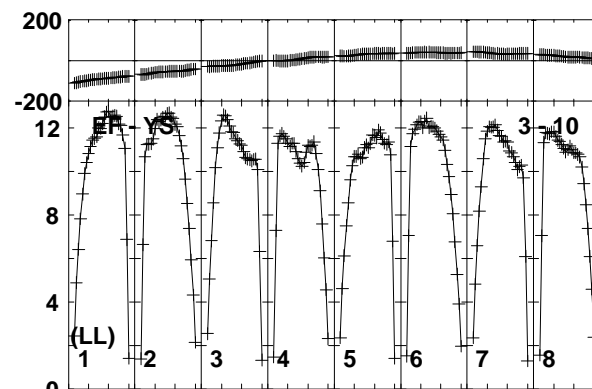
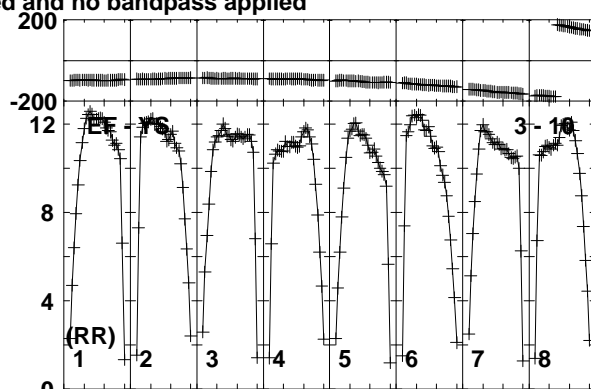
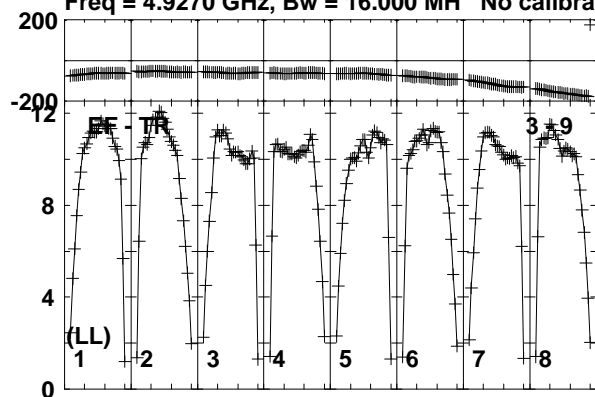

Lower frame: Milli Ampl Jy Top frame: Phas deg  
Vector averaged cross-power spectrum Baseline: EF (03) - TR (09)  
Timerange: 00:12:05:31 to 00:12:06:29

Plot file version 402 created 19-DEC-2018 17:58:42

J1619+2247 RY007C.UVDATA.1

Freq = 4.9270 GHz, Bw = 16.000 MH No calibration applied and no bandpass applied

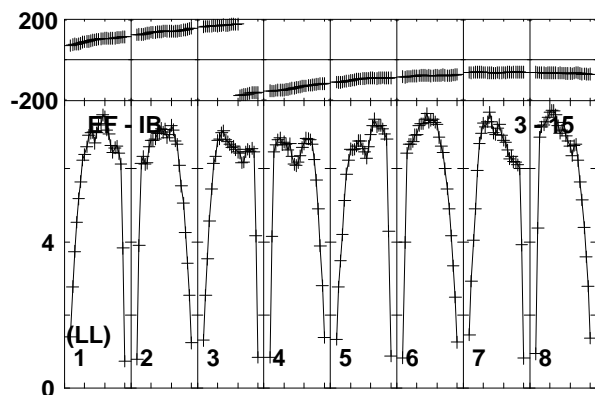
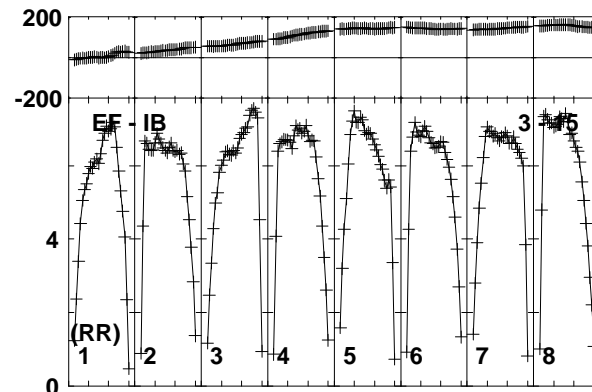
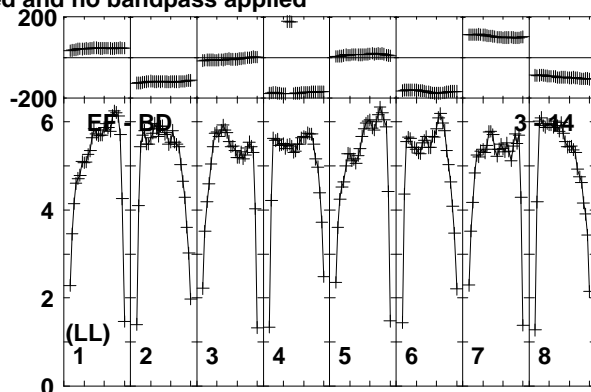
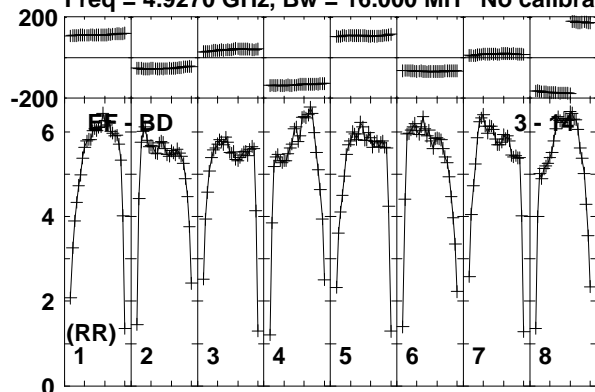

Lower frame: Milli Ampl Jy Top frame: Phas deg

Vector averaged cross-power spectrum Baseline: EF (03) - BD (14)

Timerange: 00/12:05:31 to 00/12:06:29



Plot file version 403 created 19-DEC-2018 17:58:42

AT2018\_RY007C.UVDATA.1

Freq = 4.9270 GHz, Bw = 16.000 MH No calibration applied and no bandpass applied

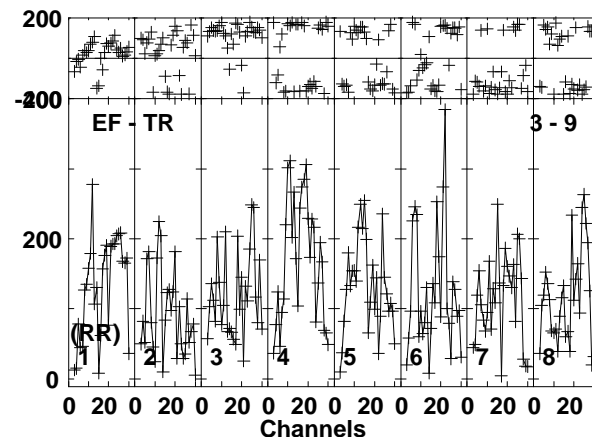
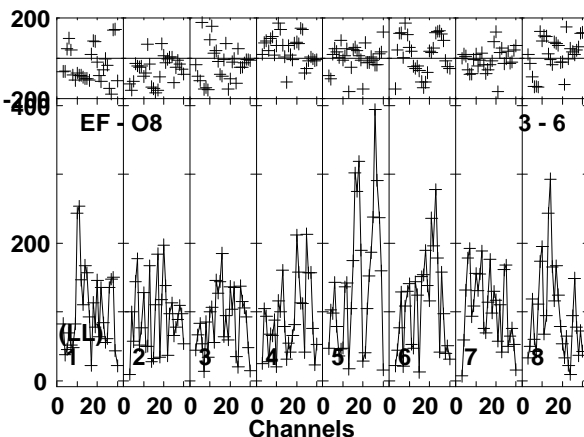
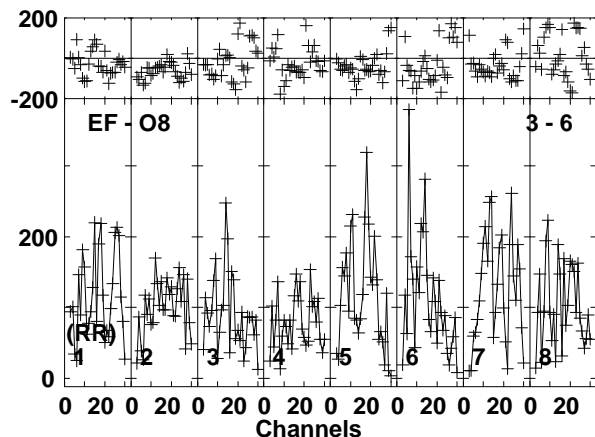
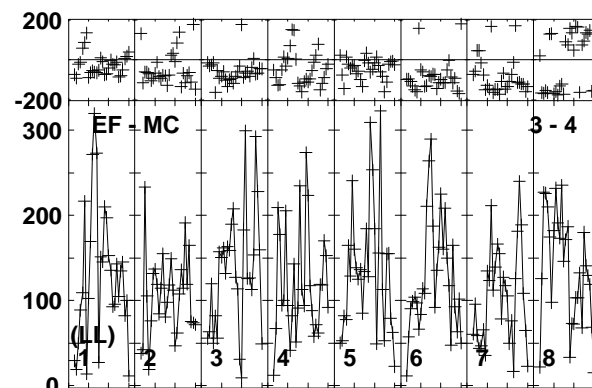
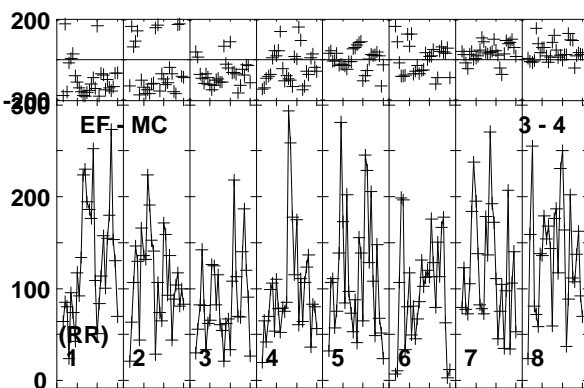
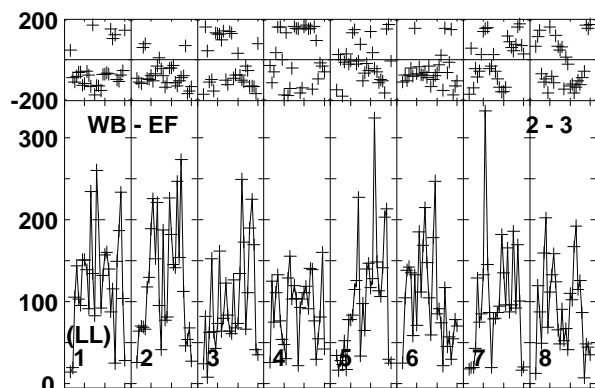
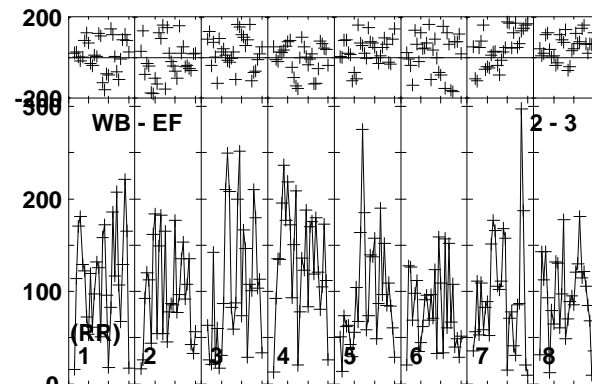
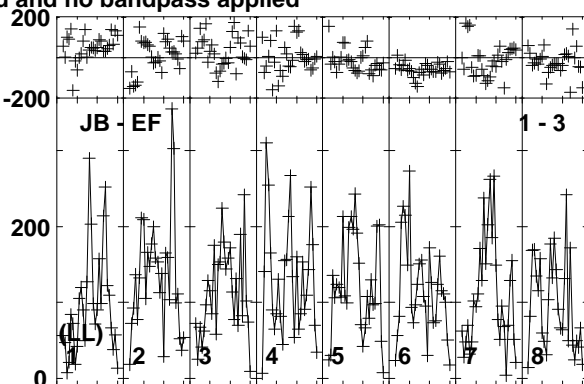
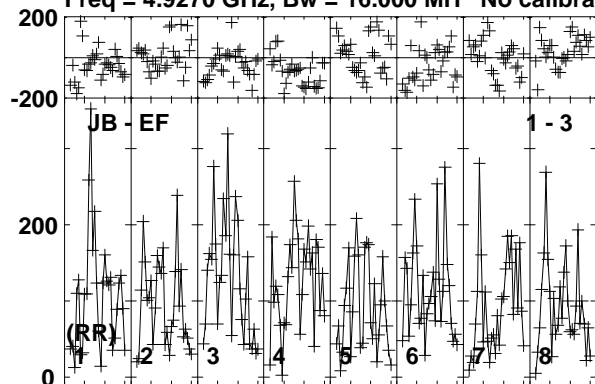

Lower frame: Micro Ampl Jy Top frame: Phas deg  
Vector averaged cross-power spectrum Baseline: JB (01) - EF (03)  
Timerange: 00/12:06:31 to 00/12:09:29

Plot file version 404 created 19-DEC-2018 17:58:42

AT2018\_RY007C.UVDATA.1

Freq = 4.9270 GHz, Bw = 16.000 MH No calibration applied and no bandpass applied

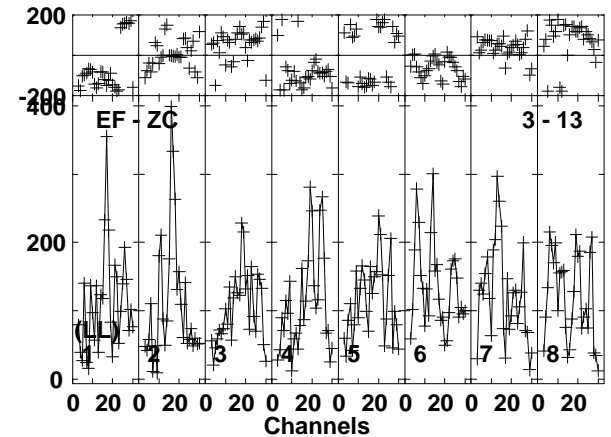
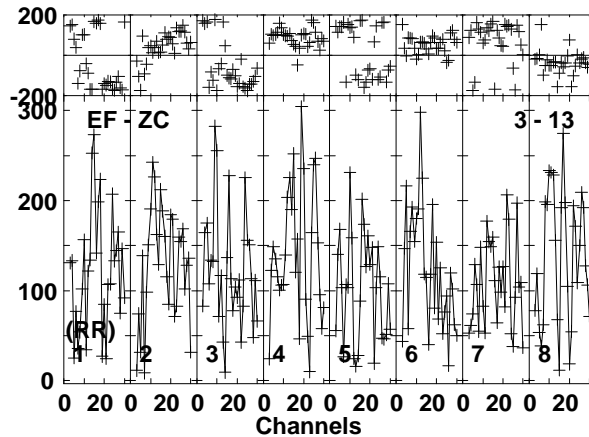
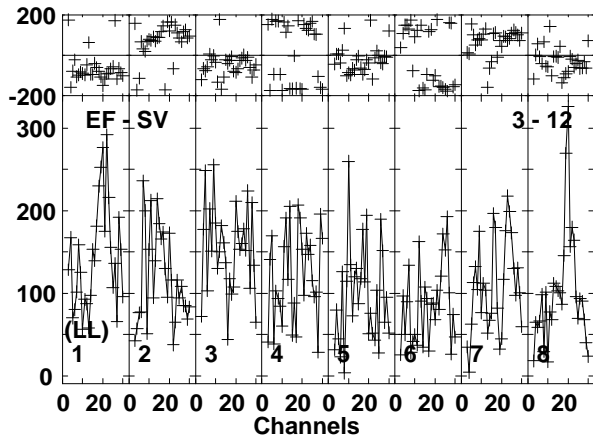
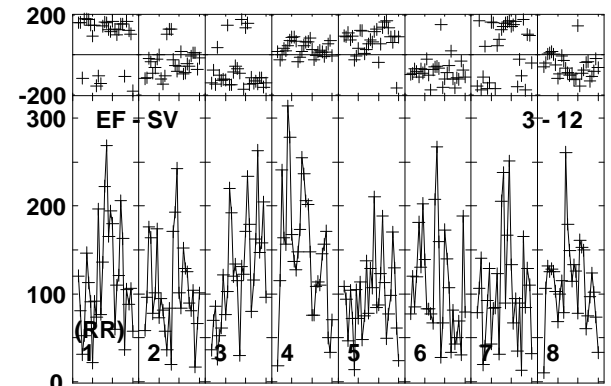
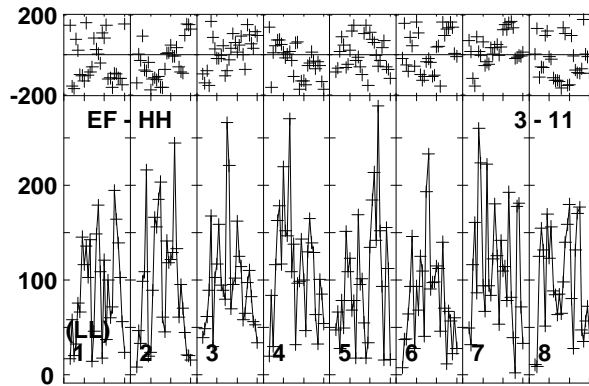
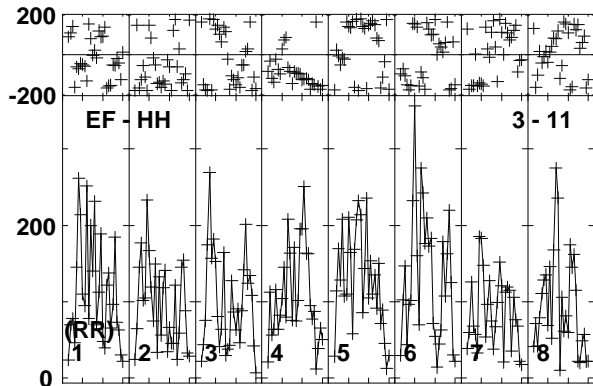
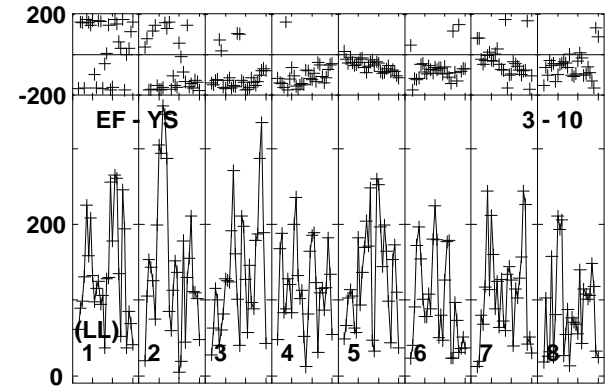
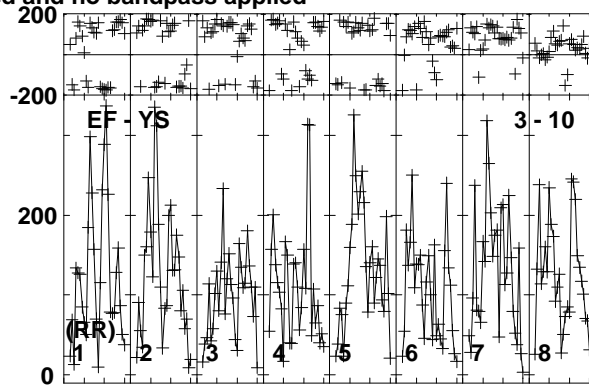
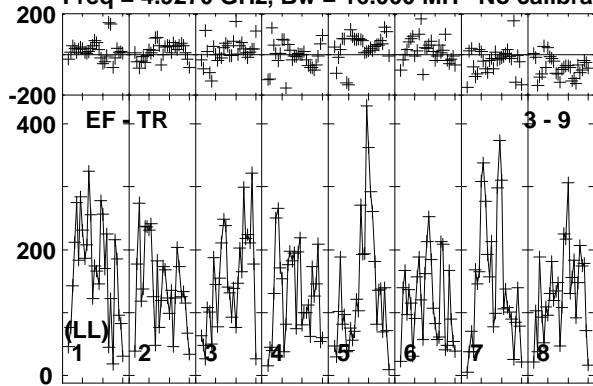

Lower frame: Micro Ampl Jy Top frame: Phas deg  
Vector averaged cross-power spectrum Baseline: EF (03) - TR (09)  
Timerange: 00/12:06:31 to 00/12:09:29

Plot file version 405 created 19-DEC-2018 17:58:42

AT2018\_RY007C.UVDATA.1

Freq = 4.9270 GHz, Bw = 16.000 MH No calibration applied and no bandpass applied

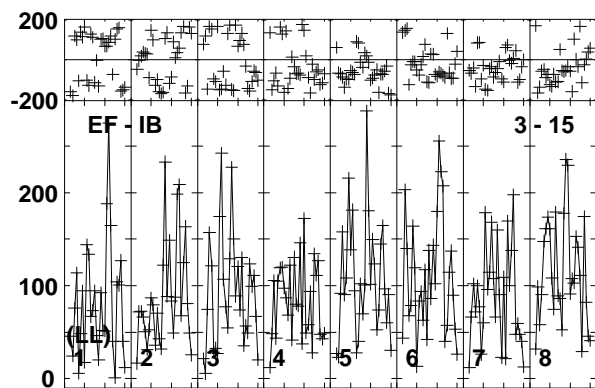
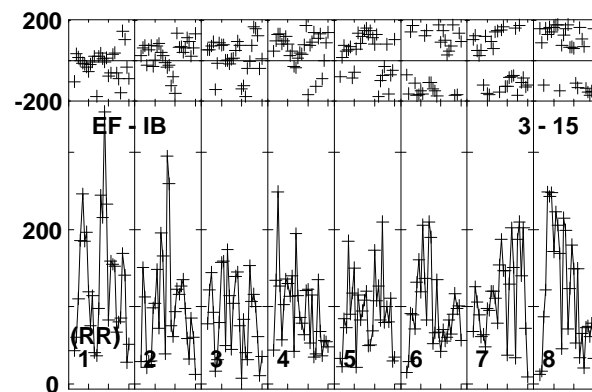
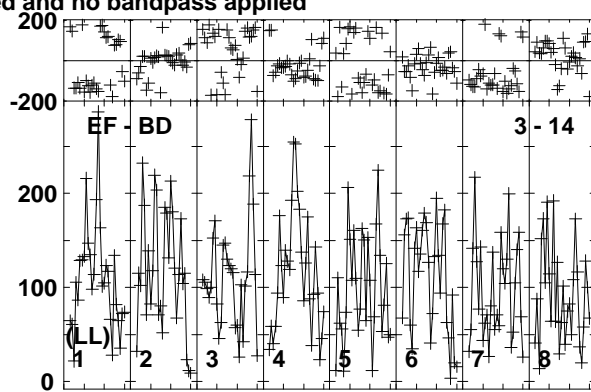
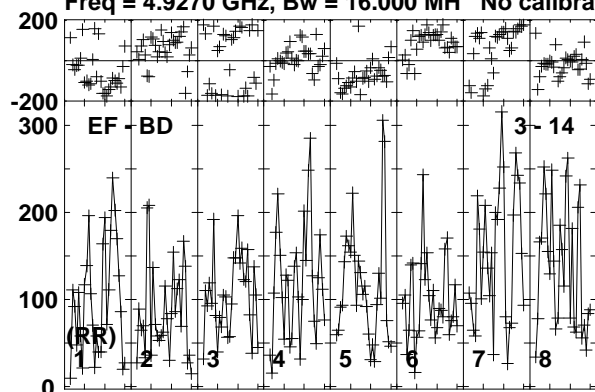

Lower frame: Micro Ampl Jy Top frame: Phas deg  
Vector averaged cross-power spectrum Baseline: EF (03) - BD (14)  
Timerange: 00/12:06:31 to 00/12:09:29

Plot file version 406 created 19-DEC-2018 17:58:42

J1619+2247 RY007C.UVDATA.1

Freq = 4.9270 GHz, Bw = 16.000 MH No calibration applied and no bandpass applied

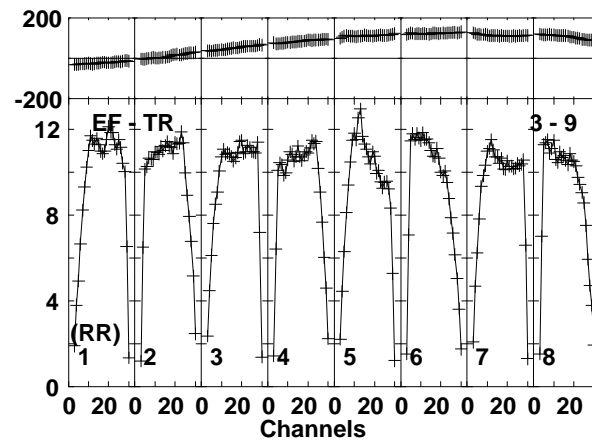
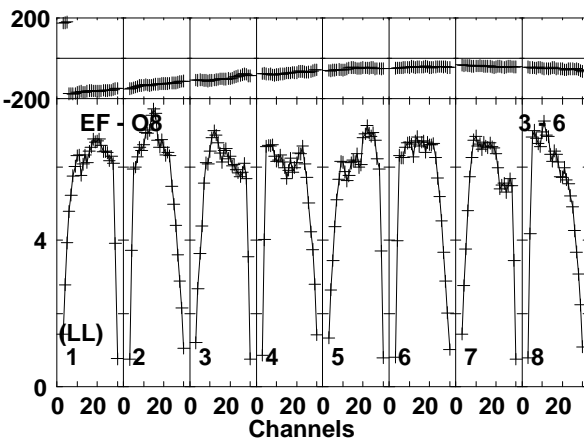
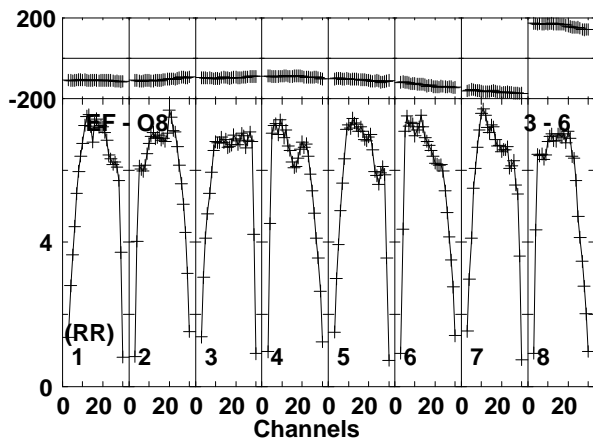
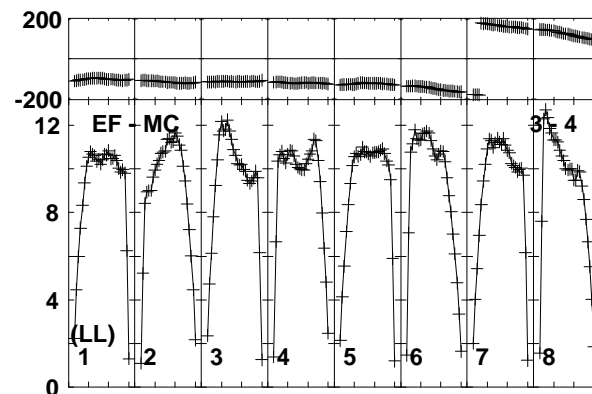
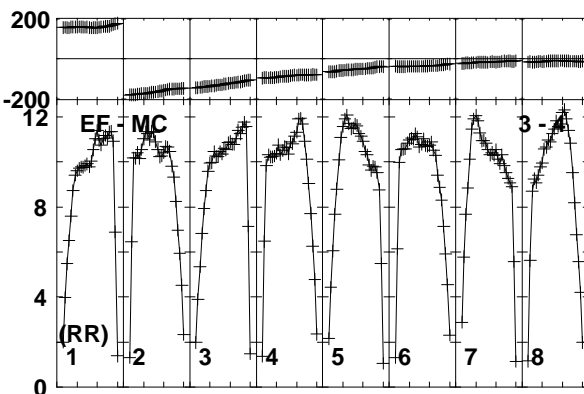
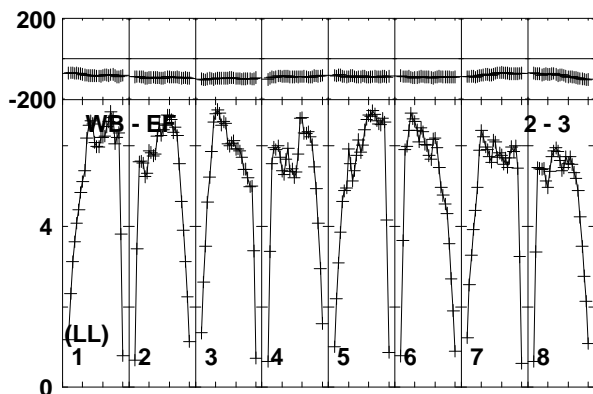
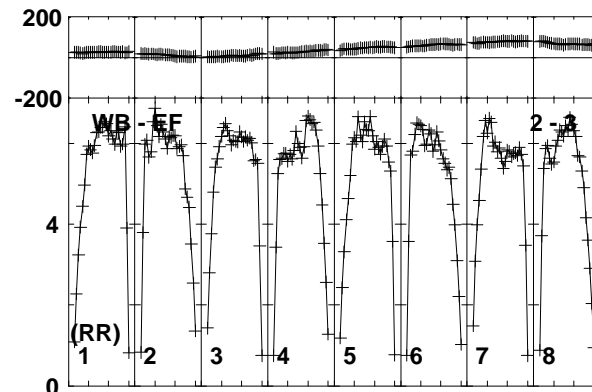
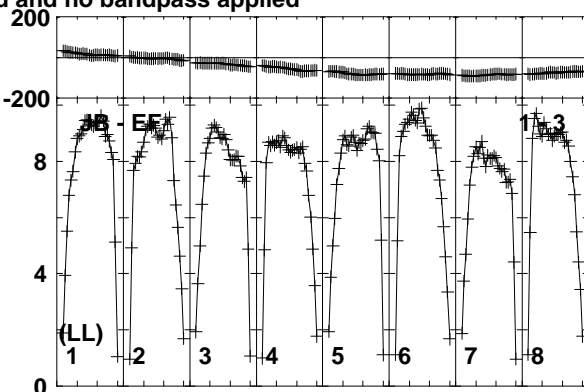
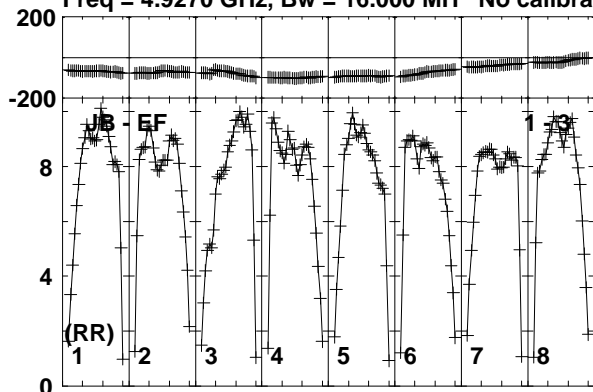

Lower frame: Milli Ampl Jy Top frame: Phas deg  
Vector averaged cross-power spectrum Baseline: JB (01) - EF (03)  
Timerange: 00/12:09:31 to 00/12:10:29

Plot file version 407 created 19-DEC-2018 17:58:42

J1619+2247 RY007C.UVDATA.1

Freq = 4.9270 GHz, Bw = 16.000 MH No calibration applied and no bandpass applied

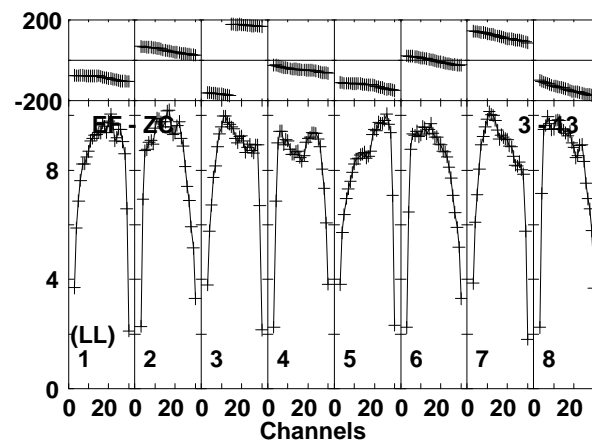
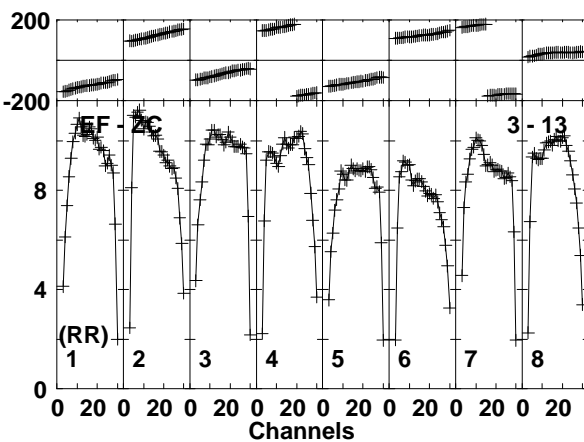
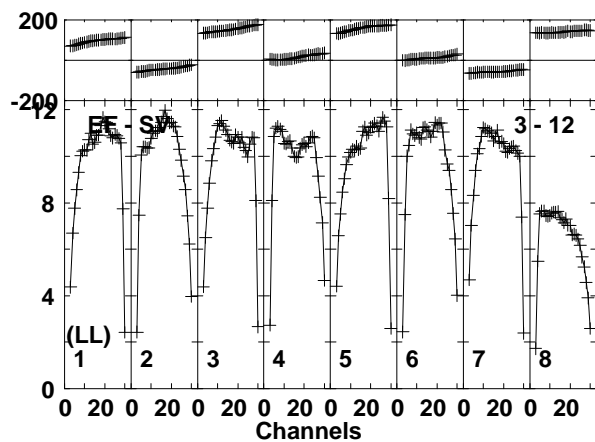
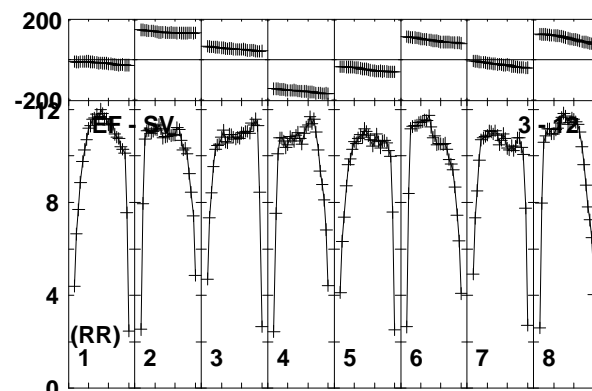
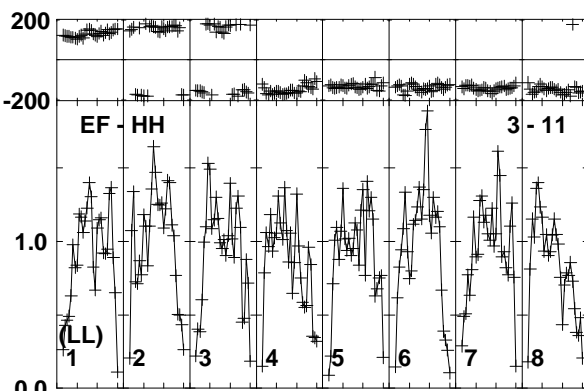
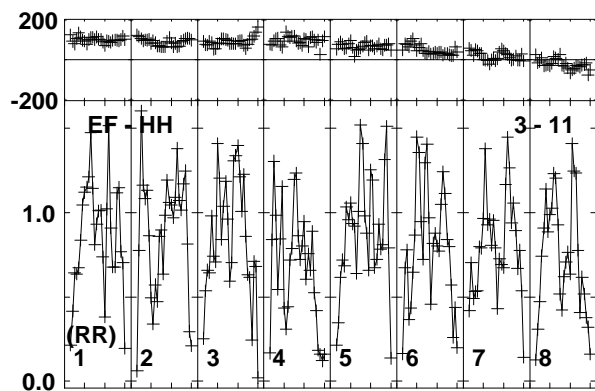
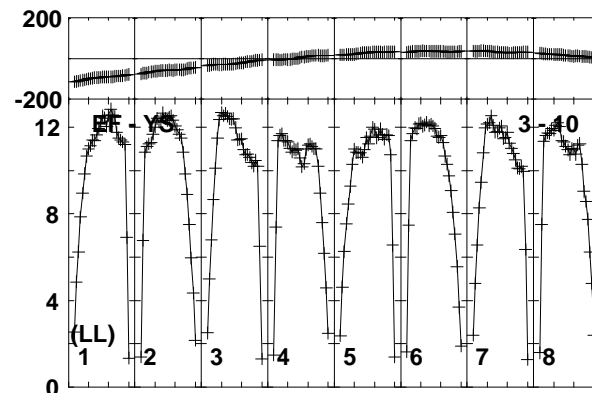
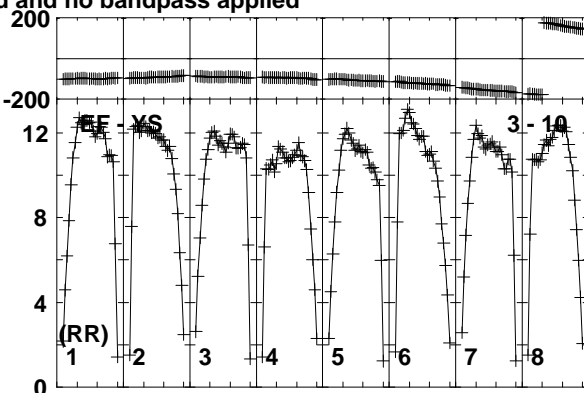
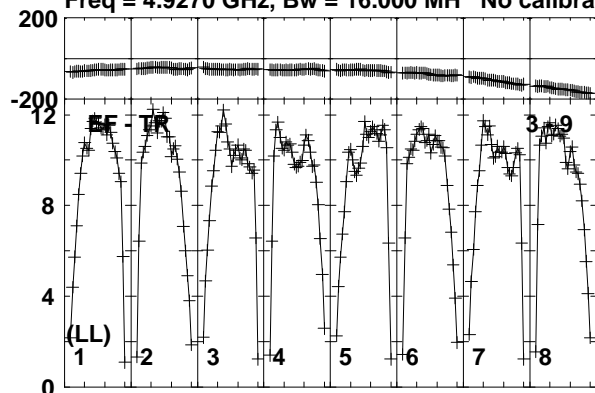

Lower frame: Milli Ampl Jy Top frame: Phas deg  
Vector averaged cross-power spectrum Baseline: EF (03) - TR (09)  
Timerange: 00:12:09:31 to 00:12:10:29

Plot file version 408 created 19-DEC-2018 17:58:42

J1619+2247 RY007C.UVDATA.1

Freq = 4.9270 GHz, Bw = 16.000 MH No calibration applied and no bandpass applied

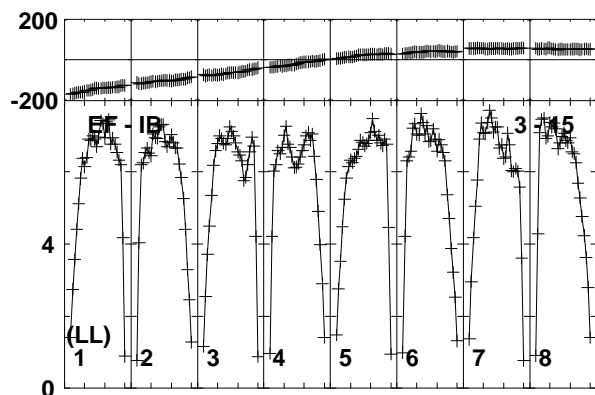
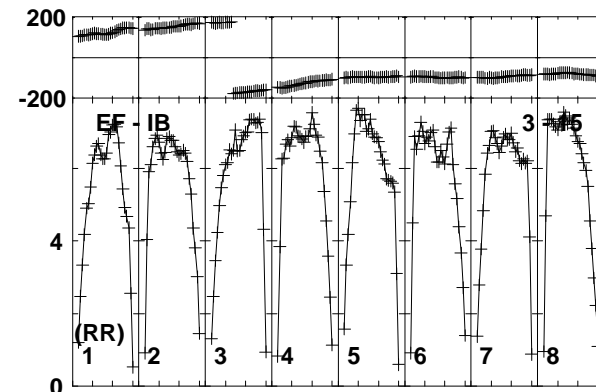
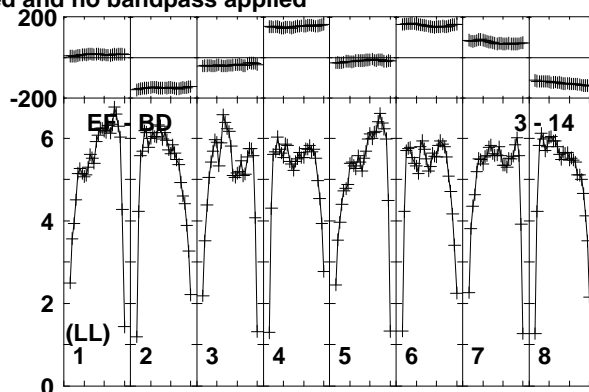
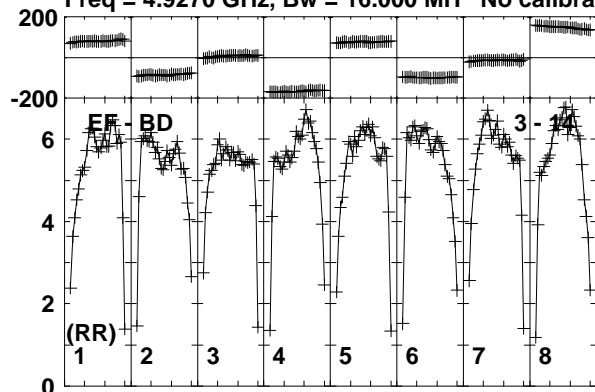

Lower frame: Milli Ampl Jy Top frame: Phas deg  
Vector averaged cross-power spectrum Baseline: EF (03) - BD (14)  
Timerange: 00:12:09:31 to 00:12:10:29

Plot file version 409 created 19-DEC-2018 17:58:42

AT2018\_RY007C.UVDATA.1

Freq = 4.9270 GHz, Bw = 16.000 MH No calibration applied and no bandpass applied

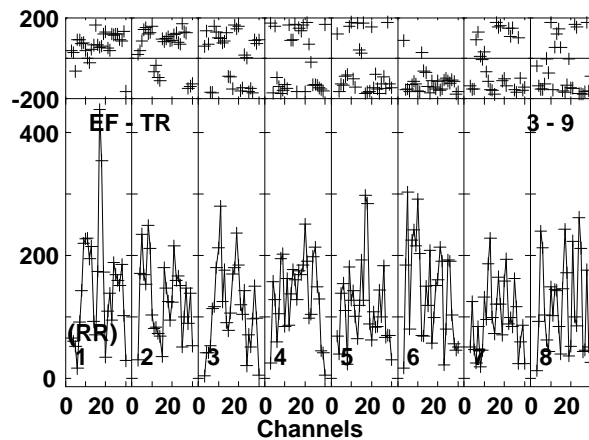
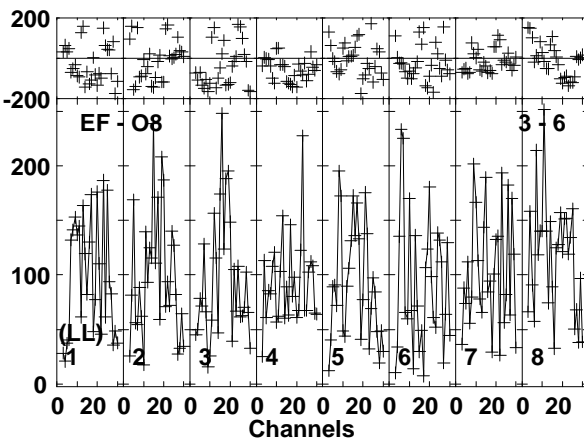
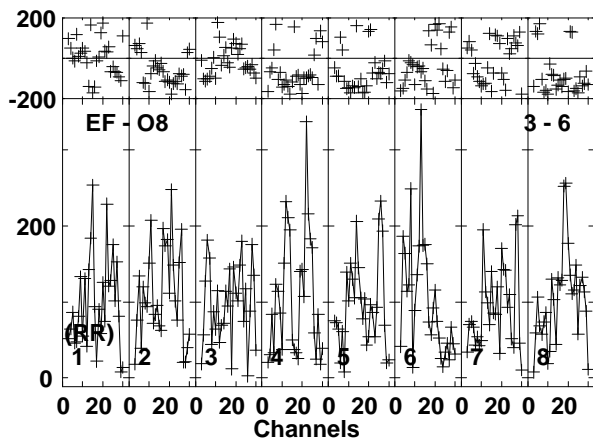
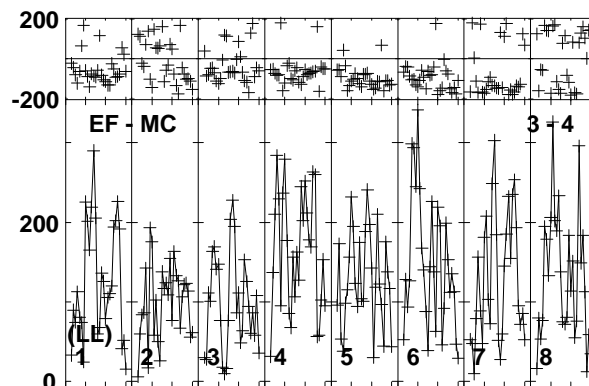
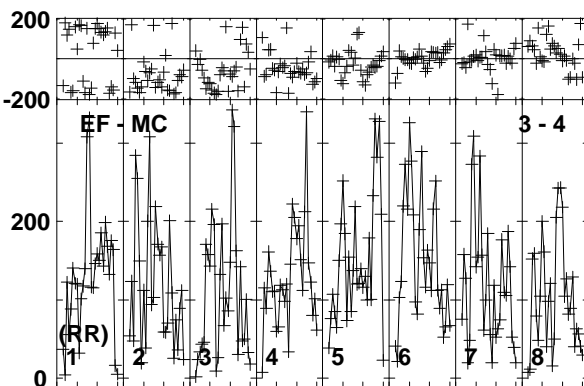
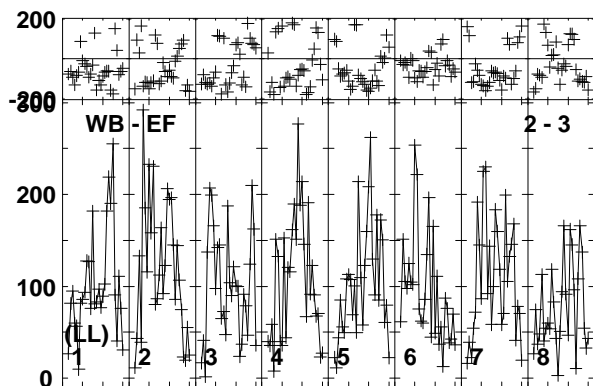
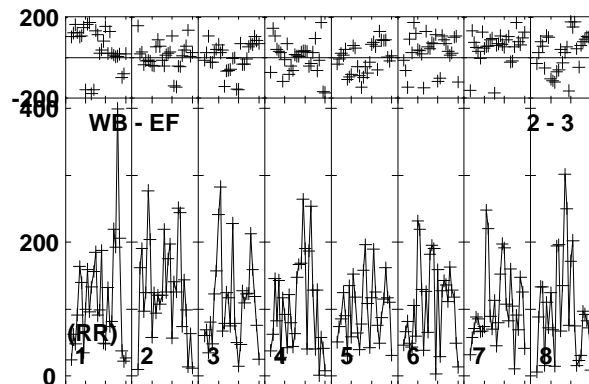
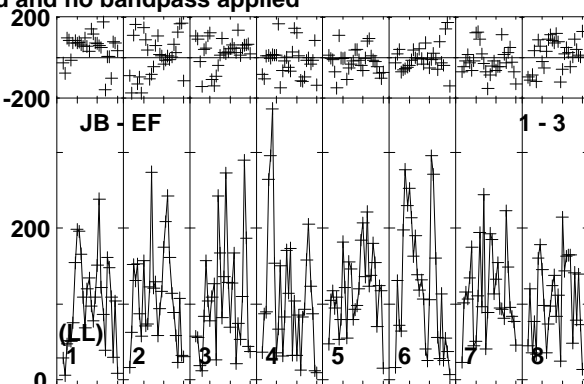
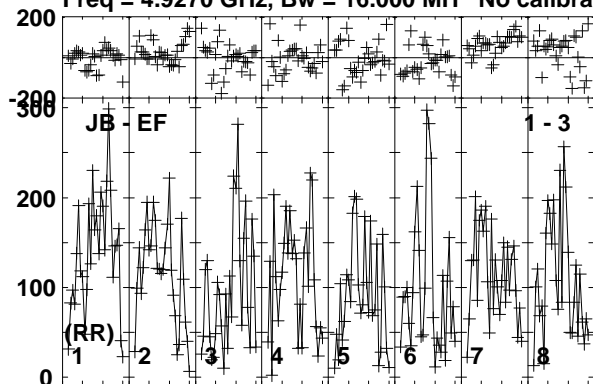

Lower frame: Micro Ampl Jy Top frame: Phas deg  
Vector averaged cross-power spectrum Baseline: JB (01) - EF (03)  
Timerange: 00/12:10:31 to 00/12:13:29

Plot file version 410 created 19-DEC-2018 17:58:42

AT2018\_RY007C.UVDATA.1

Freq = 4.9270 GHz, Bw = 16.000 MH No calibration applied and no bandpass applied

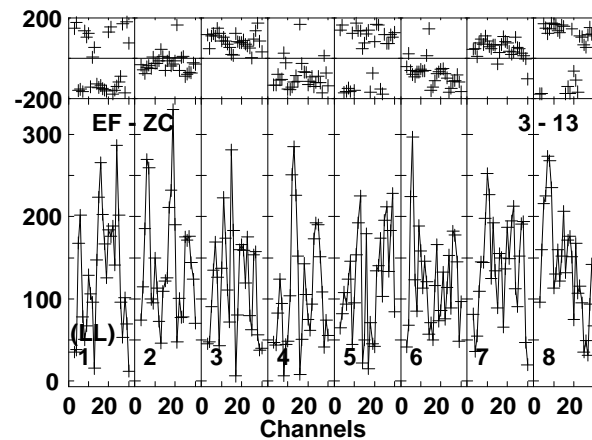
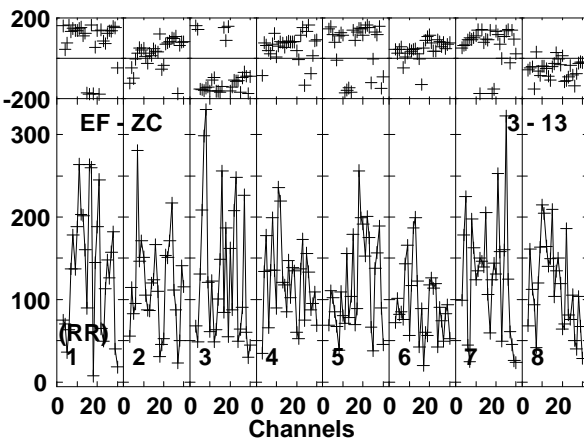
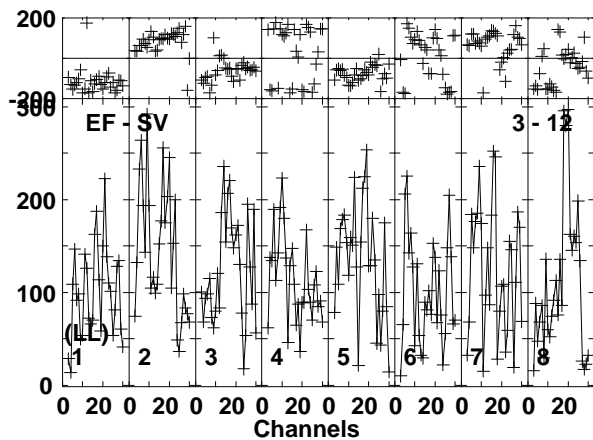
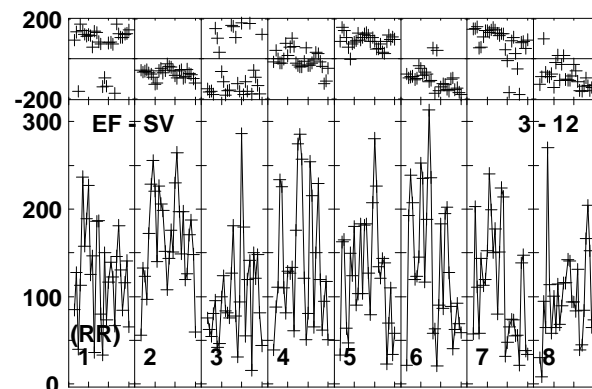
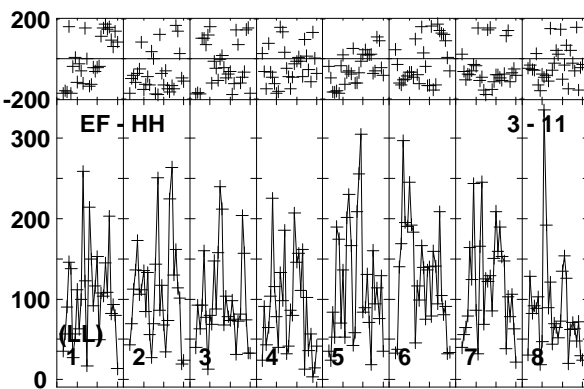
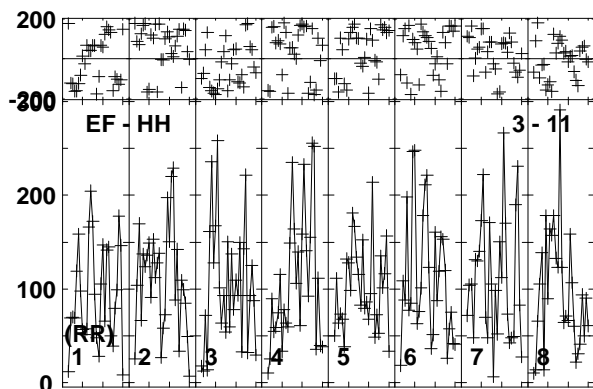
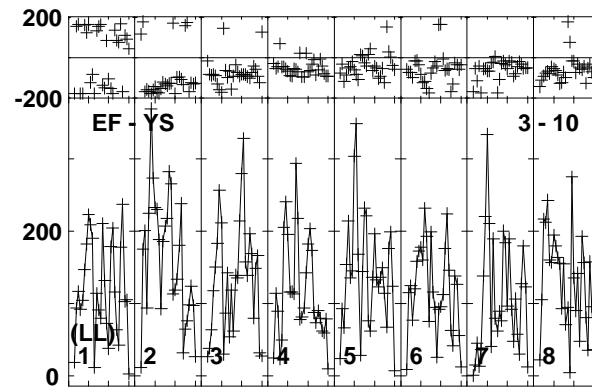
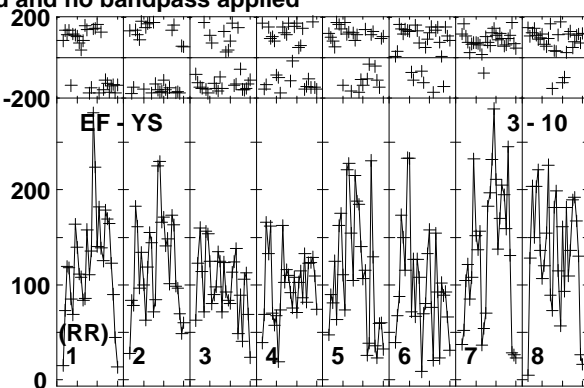
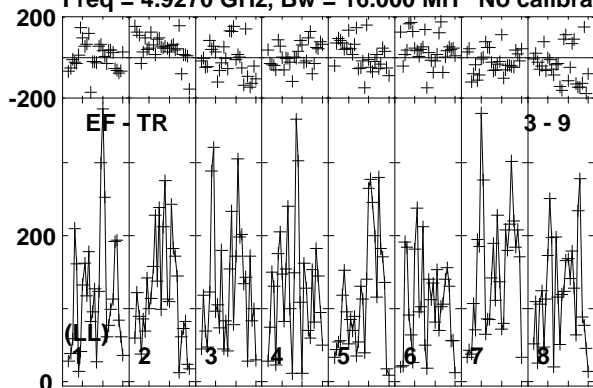

Lower frame: Micro Ampl Jy Top frame: Phas deg  
Vector averaged cross-power spectrum Baseline: EF (03) - TR (09)  
Timerange: 00/12:10:31 to 00/12:13:29



Plot file version 411 created 19-DEC-2018 17:58:42

AT2018\_RY007C.UVDATA.1

Freq = 4.9270 GHz, Bw = 16.000 MH No calibration applied and no bandpass applied

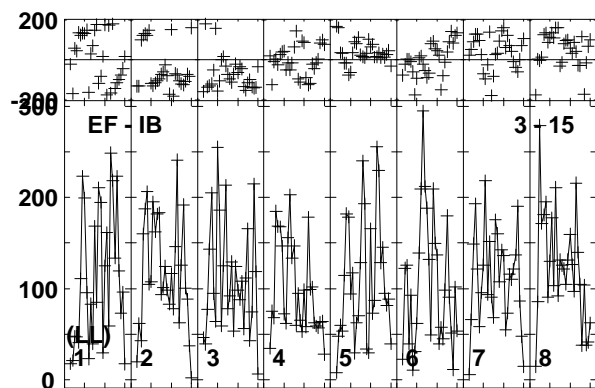
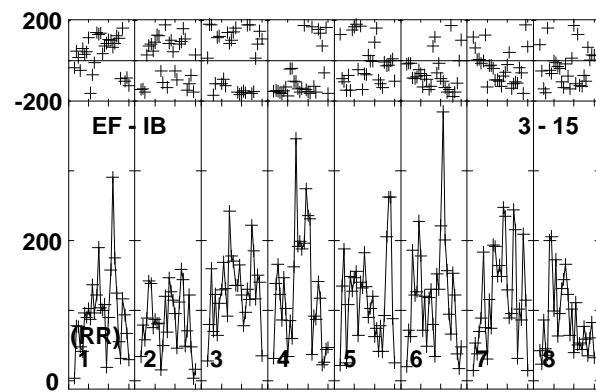
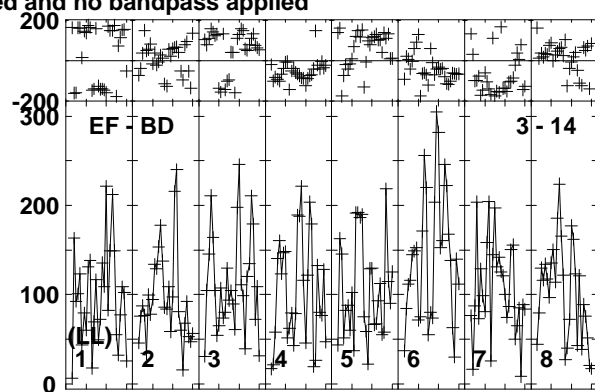
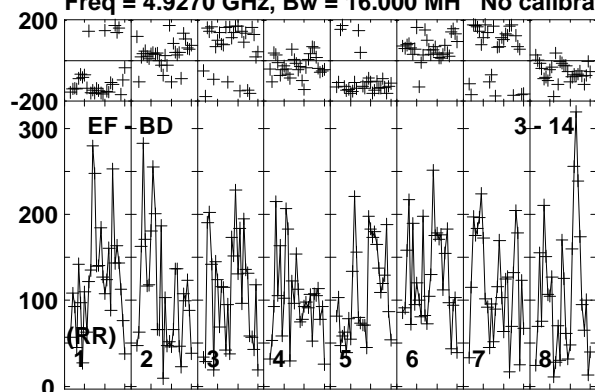

Lower frame: Micro Ampl Jy Top frame: Phas deg  
Vector averaged cross-power spectrum Baseline: EF (03) - BD (14)  
Timerange: 00/12:10:31 to 00/12:13:29

Plot file version 412 created 19-DEC-2018 17:58:42

J1619+2247 RY007C.UVDATA.1

Freq = 4.9270 GHz, Bw = 16.000 MH No calibration applied and no bandpass applied

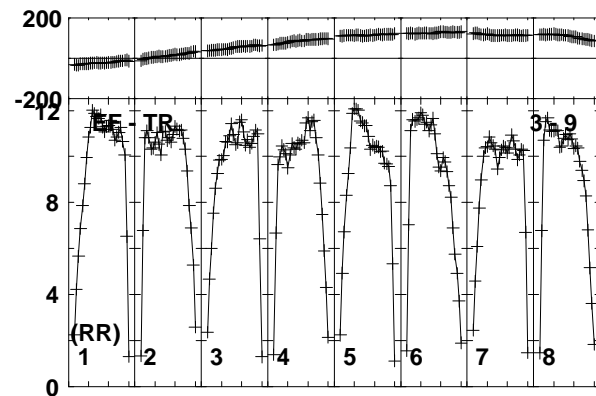
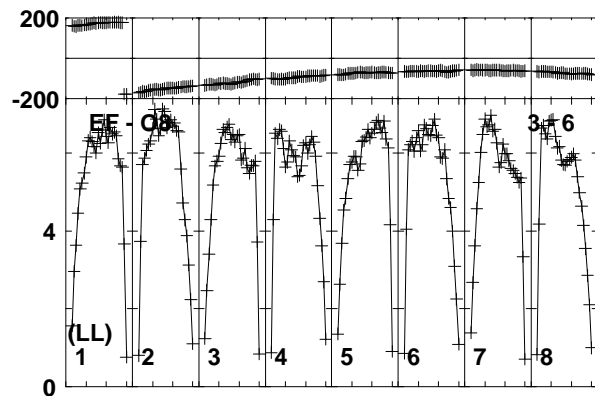
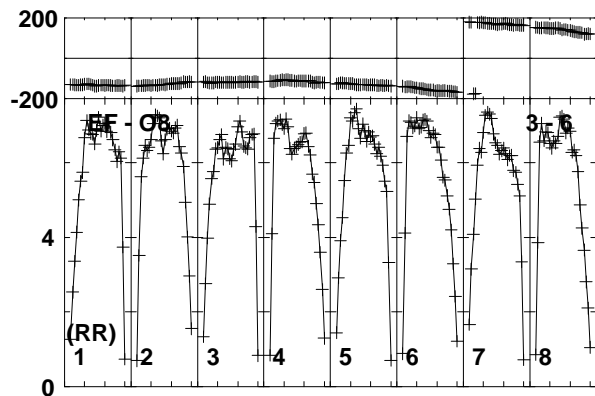
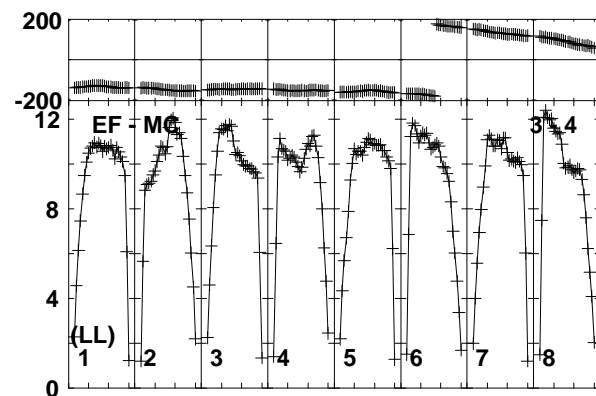
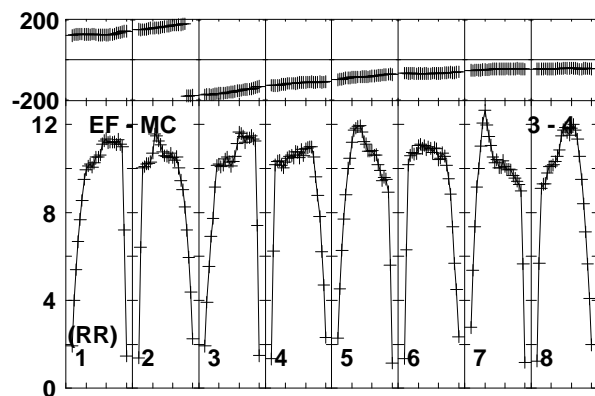
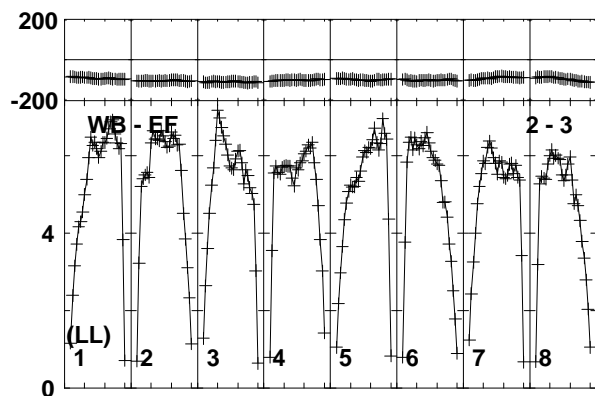
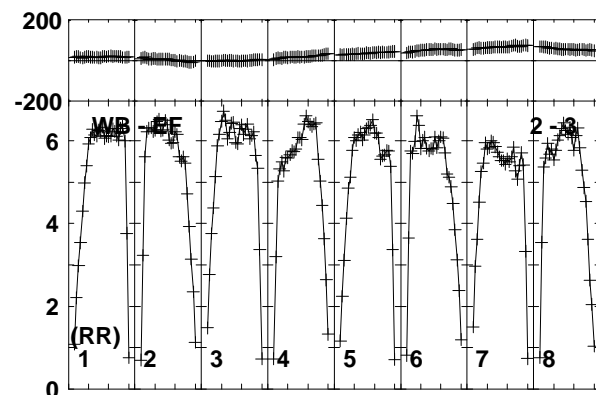
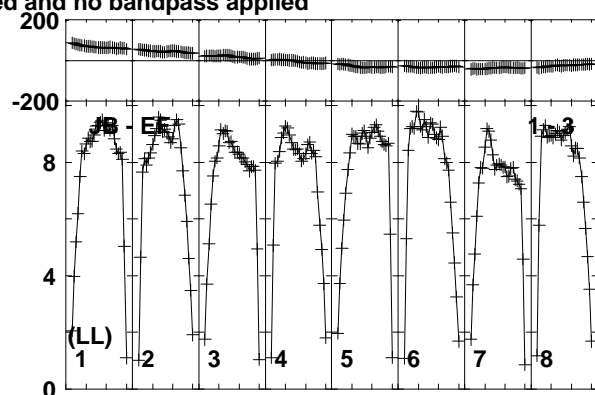
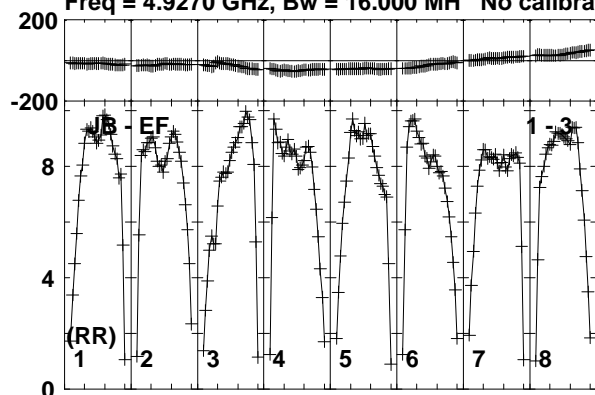

Lower frame: Milli Ampl Jy Top frame: Phas deg  
Vector averaged cross-power spectrum Baseline: JB (01) - EF (03)  
Timerange: 00:12:13:31 to 00:12:14:29

Plot file version 413 created 19-DEC-2018 17:58:42

J1619+2247 RY007C.UVDATA.1

Freq = 4.9270 GHz, Bw = 16.000 MH No calibration applied and no bandpass applied

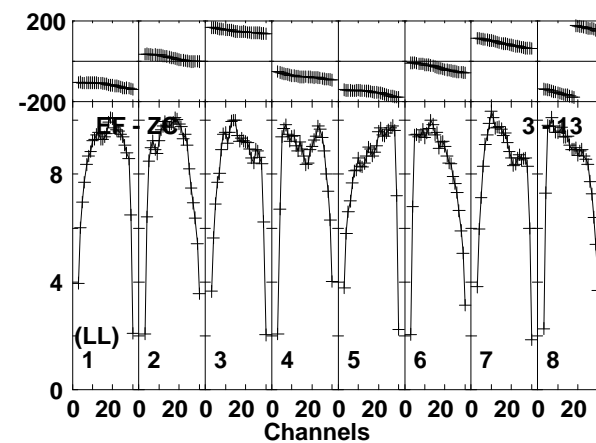
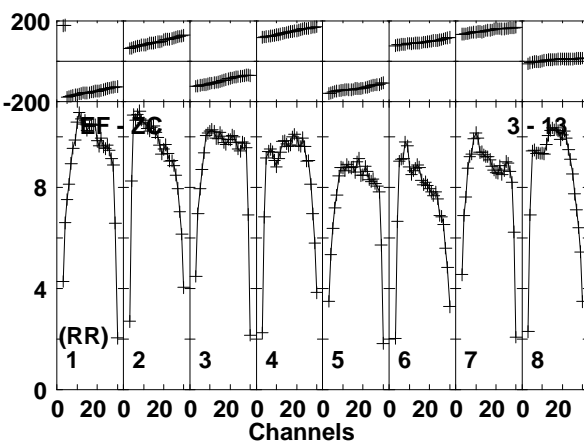
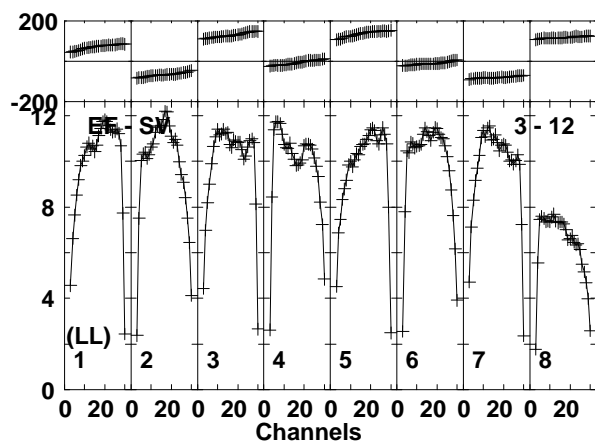
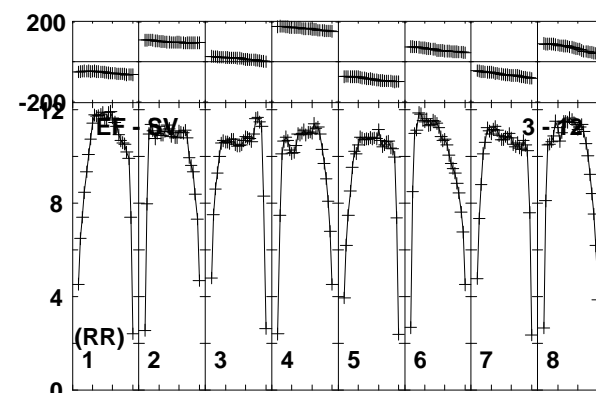
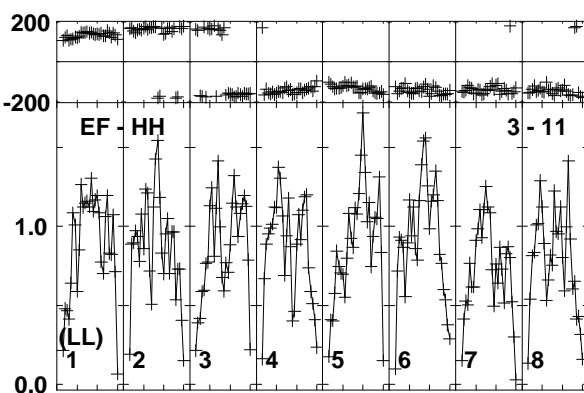
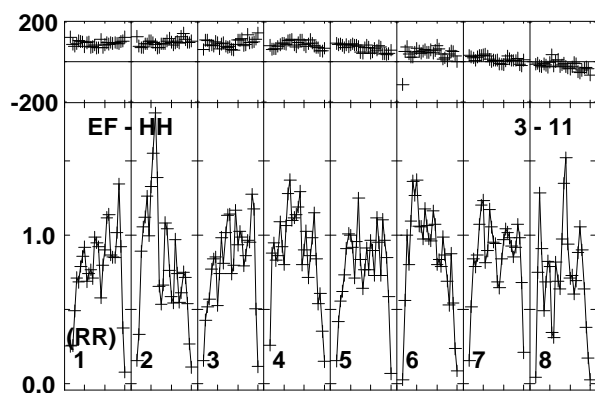
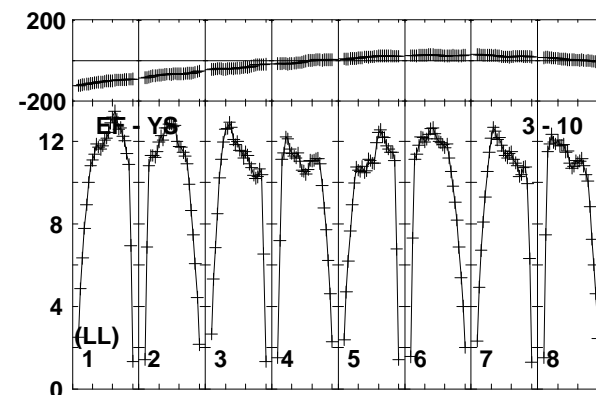
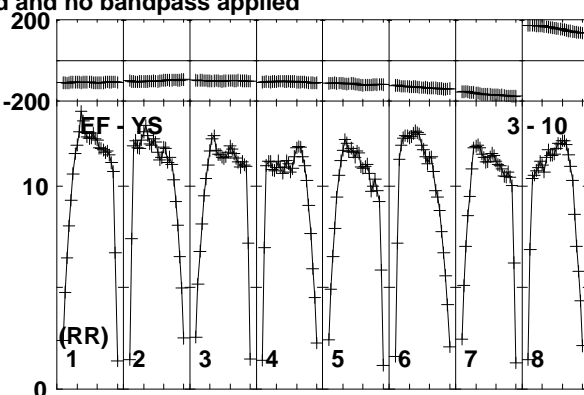
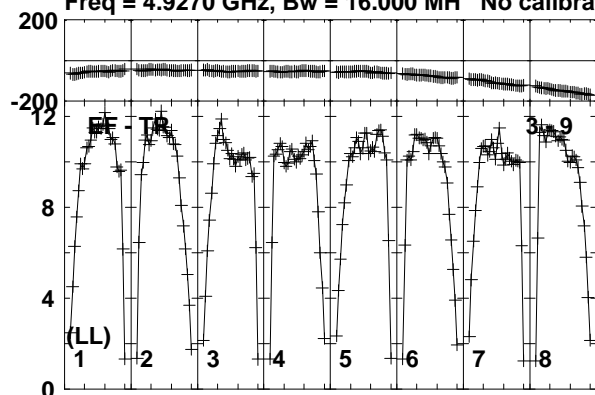

Lower frame: Milli Ampl Jy Top frame: Phas deg  
Vector averaged cross-power spectrum Baseline: EF (03) - TR (09)  
Timerange: 00:12:13:31 to 00:12:14:29

Plot file version 414 created 19-DEC-2018 17:58:42

J1619+2247 RY007C.UVDATA.1

Freq = 4.9270 GHz, Bw = 16.000 MH No calibration applied and no bandpass applied

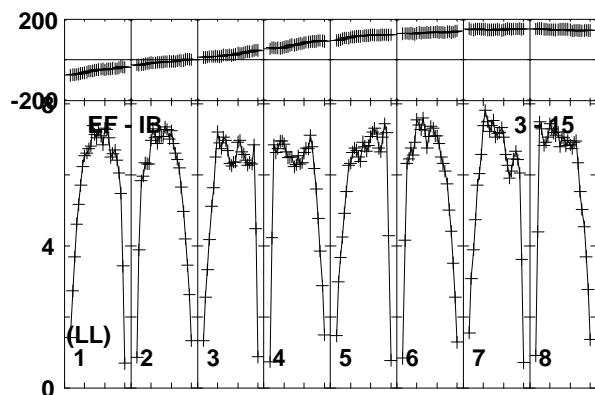
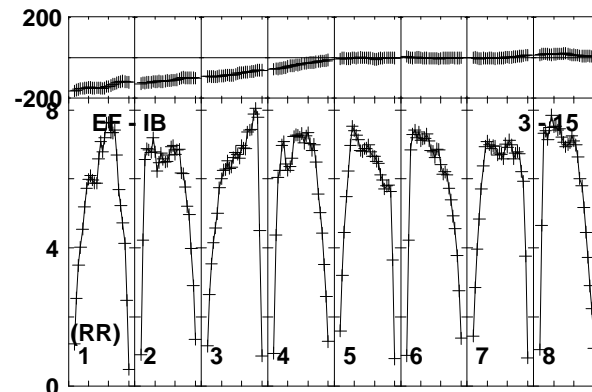
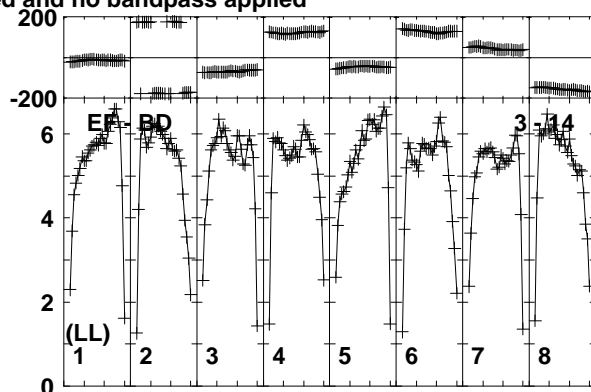
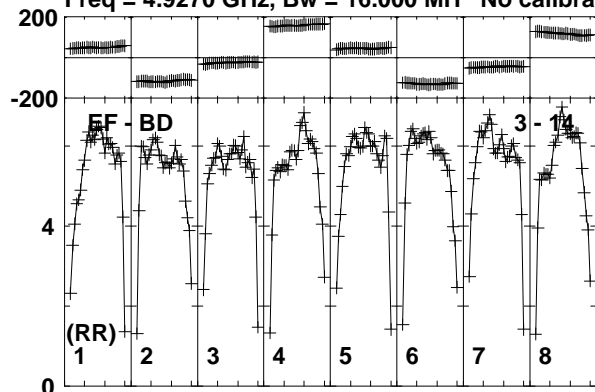

Lower frame: Milli Ampl Jy Top frame: Phas deg  
Vector averaged cross-power spectrum Baseline: EF (03) - BD (14)  
Timerange: 00:12:13:31 to 00:12:14:29

Plot file version 415 created 19-DEC-2018 17:58:42

VLA1 RY007C.UVDATA.1

Freq = 4.9270 GHz, Bw = 16.000 MH No calibration applied and no bandpass applied

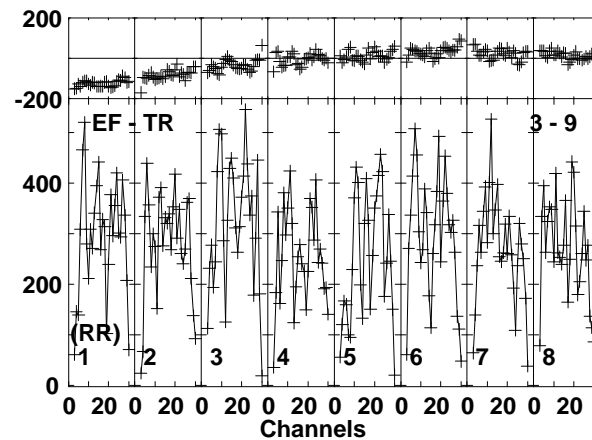
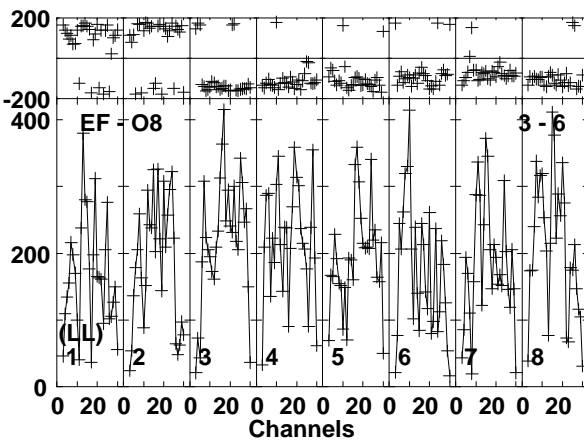
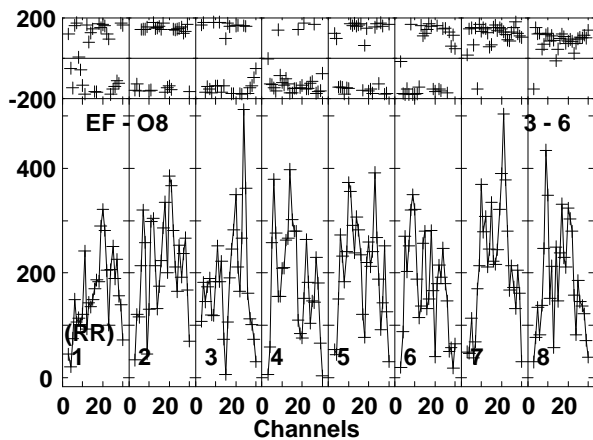
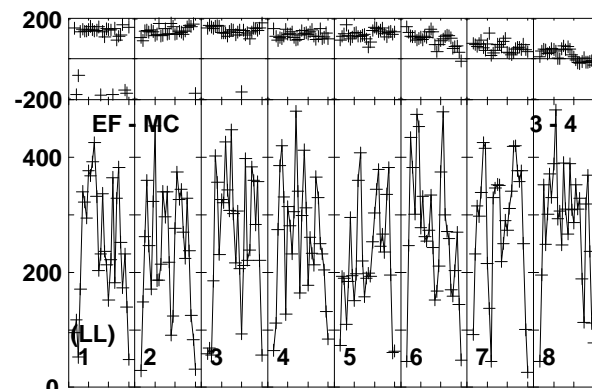
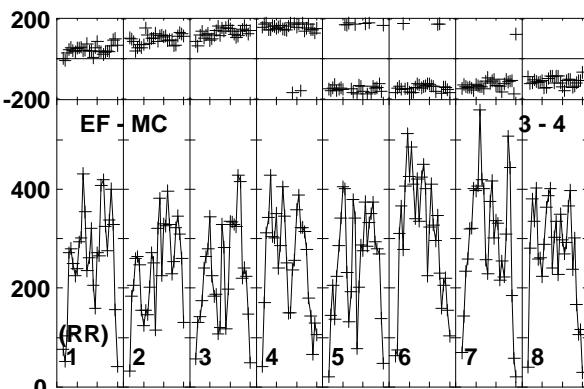
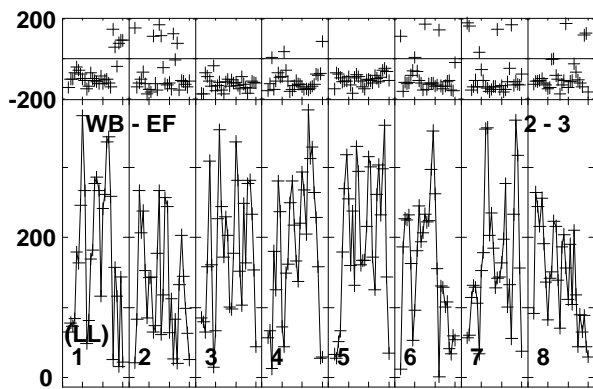
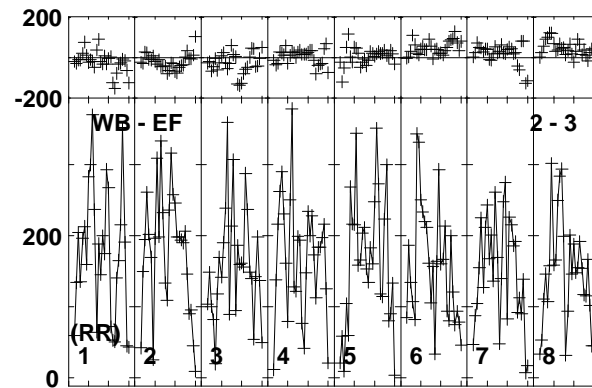
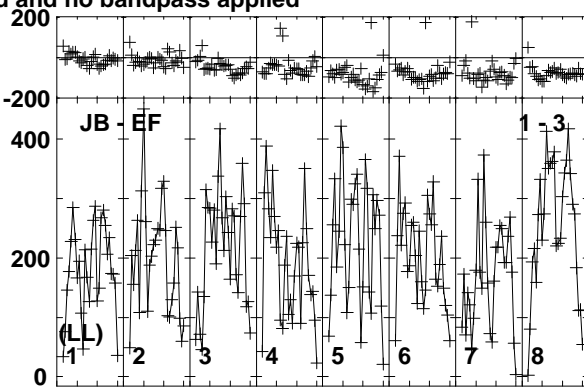
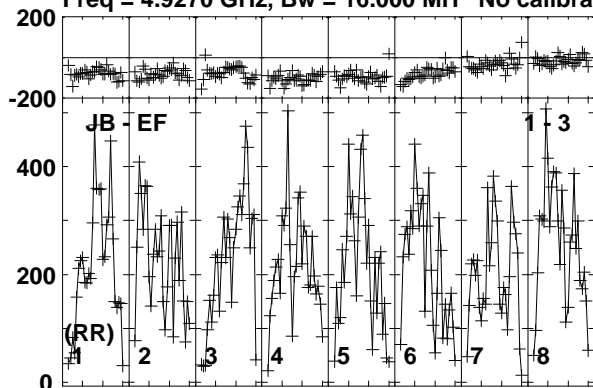

Lower frame: Micro Ampl Jy Top frame: Phas deg  
Vector averaged cross-power spectrum Baseline: JB (01) - EF (03)  
Timerange: 00/12:15:01 to 00/12:16:59

Plot file version 416 created 19-DEC-2018 17:58:42

VLA1 RY007C.UVDATA.1

Freq = 4.9270 GHz, Bw = 16.000 MH No calibration applied and no bandpass applied

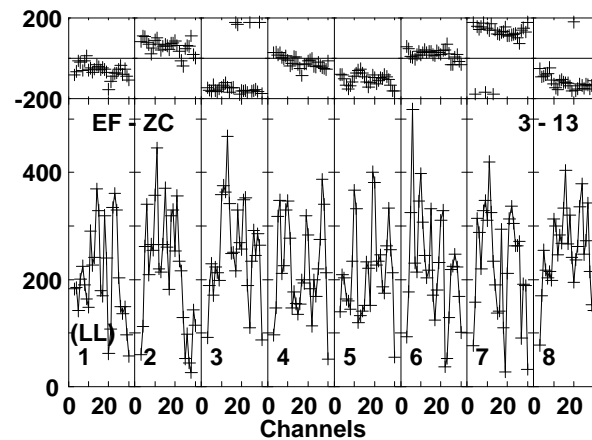
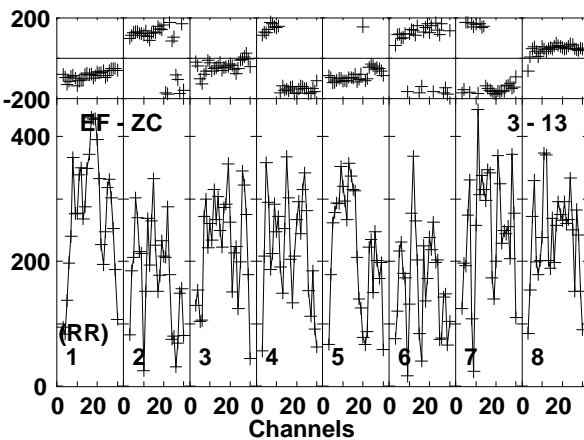
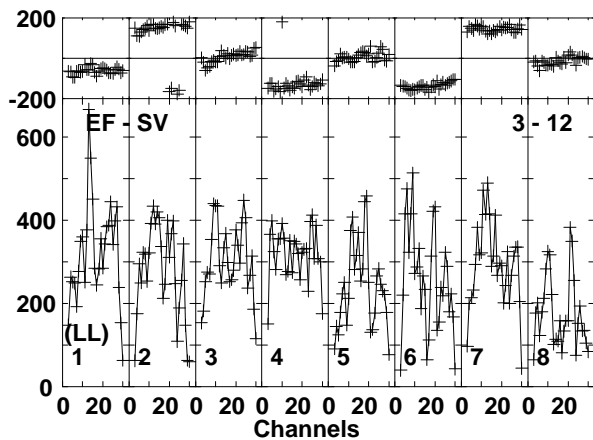
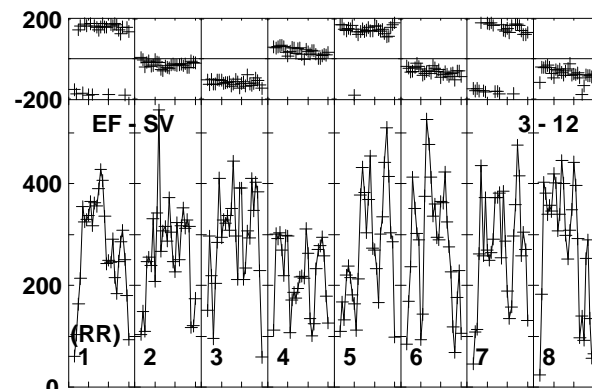
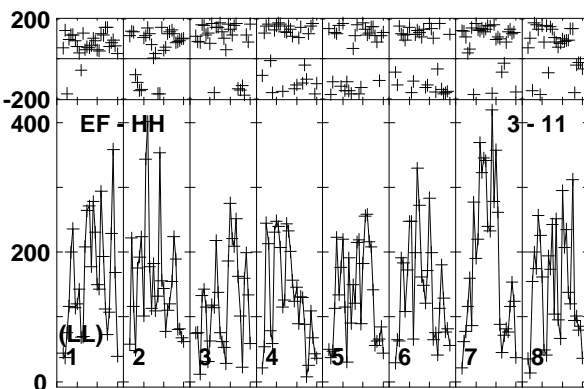
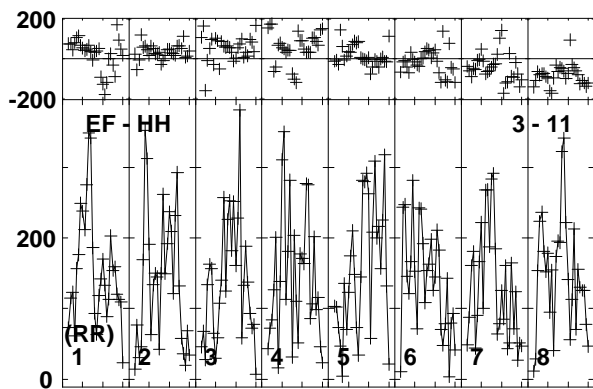
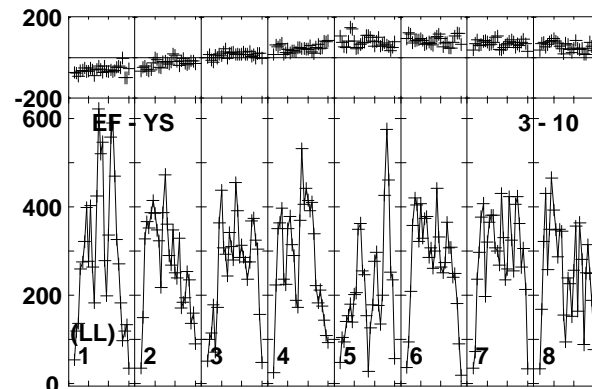
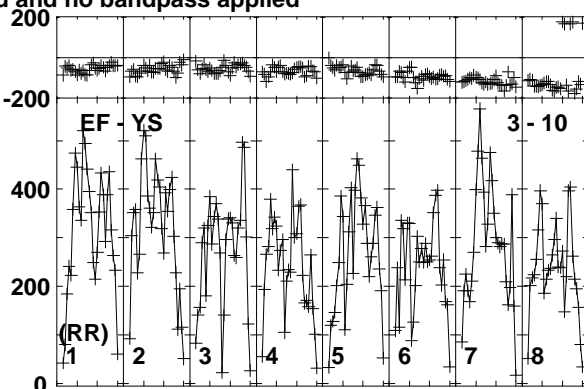
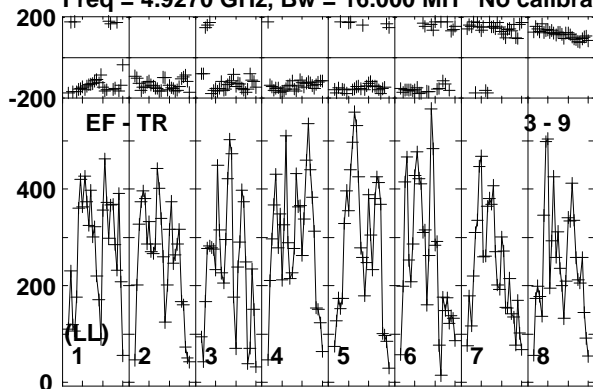

Lower frame: Micro Ampl Jy Top frame: Phas deg  
Vector averaged cross-power spectrum Baseline: EF (03) - TR (09)  
Timerange: 00/12:15:01 to 00/12:16:59

Plot file version 417 created 19-DEC-2018 17:58:42

VLA1 RY007C.UVDATA.1

Freq = 4.9270 GHz, Bw = 16.000 MH No calibration applied and no bandpass applied

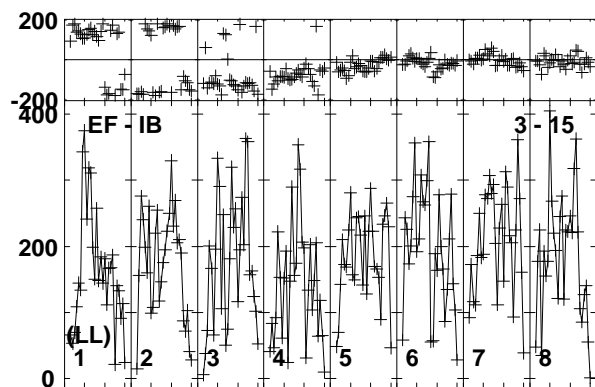
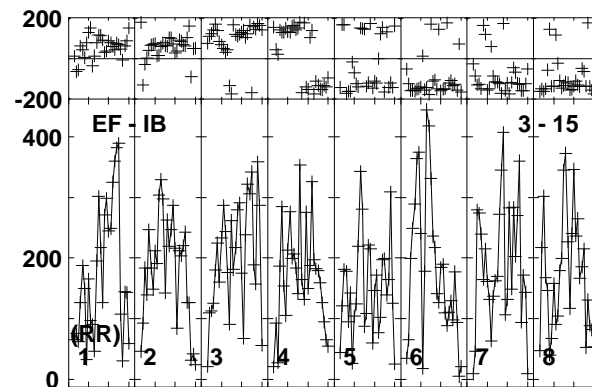
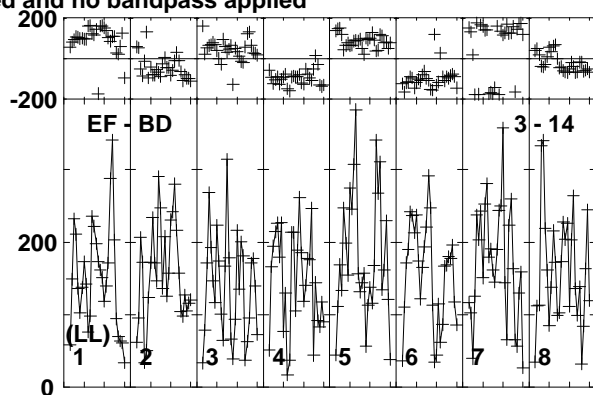
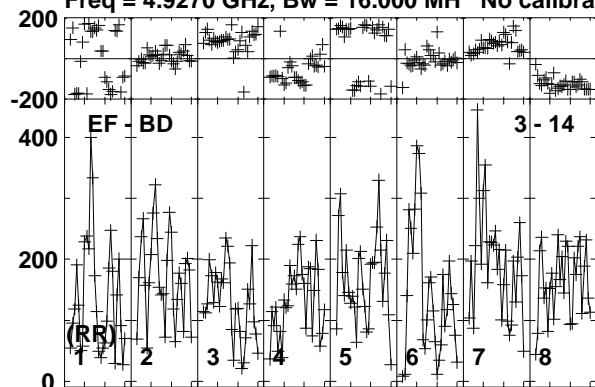

Lower frame: Micro Ampl Jy Top frame: Phas deg  
Vector averaged cross-power spectrum Baseline: EF (03) - BD (14)  
Timerange: 00/12:15:01 to 00/12:16:59

Plot file version 418 created 19-DEC-2018 17:58:42

J1619+2247 RY007C.UVDATA.1

Freq = 4.9270 GHz, Bw = 16.000 MH No calibration applied and no bandpass applied

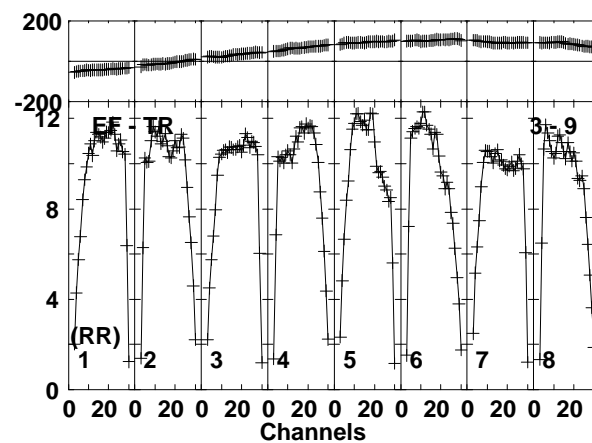
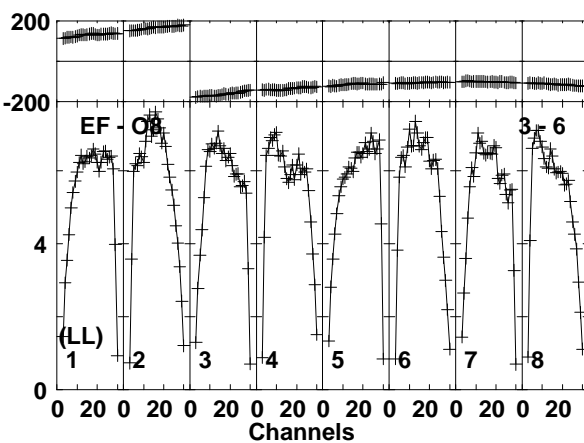
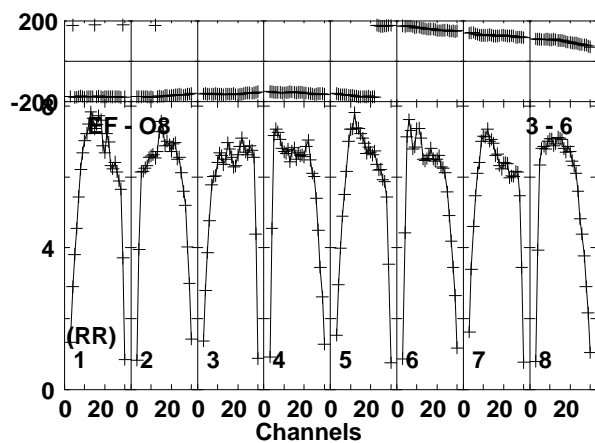
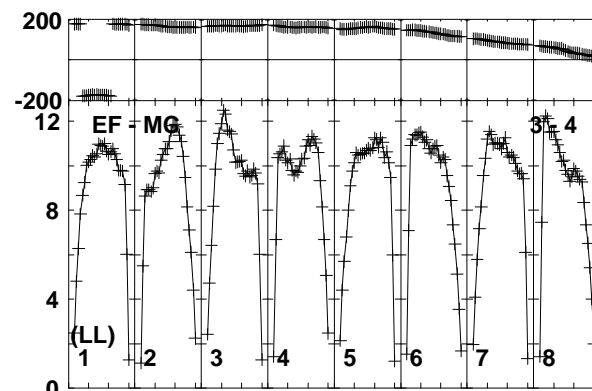
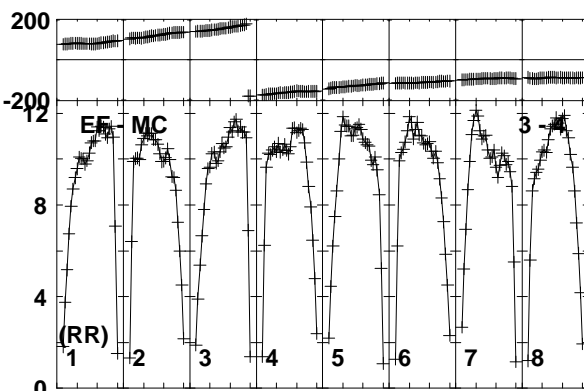
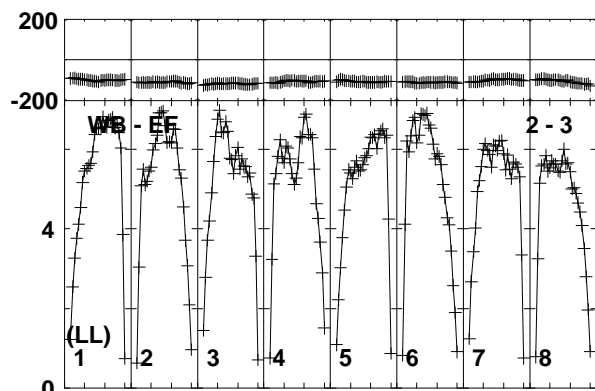
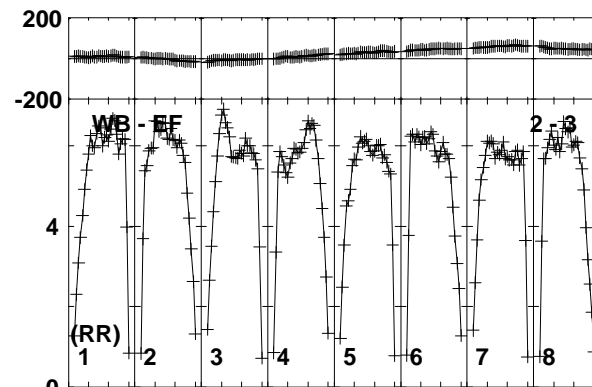
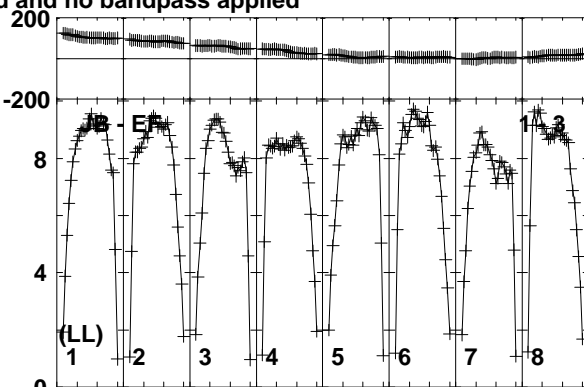
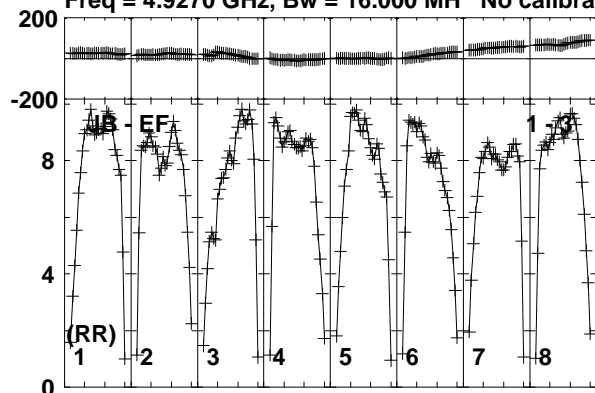

Lower frame: Milli Ampl Jy Top frame: Phas deg  
Vector averaged cross-power spectrum Baseline: JB (01) - EF (03)  
Timerange: 00:12:17:01 to 00:12:17:59



Plot file version 419 created 19-DEC-2018 17:58:42

J1619+2247 RY007C.UVDATA.1

Freq = 4.9270 GHz, Bw = 16.000 MH No calibration applied and no bandpass applied

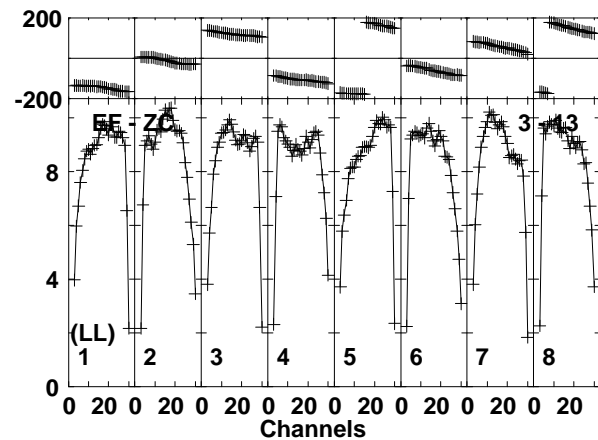
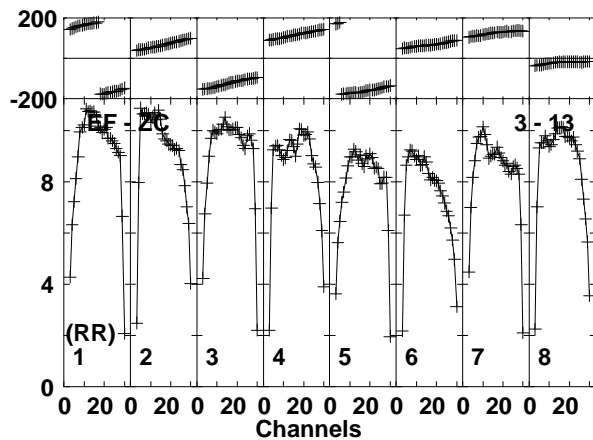
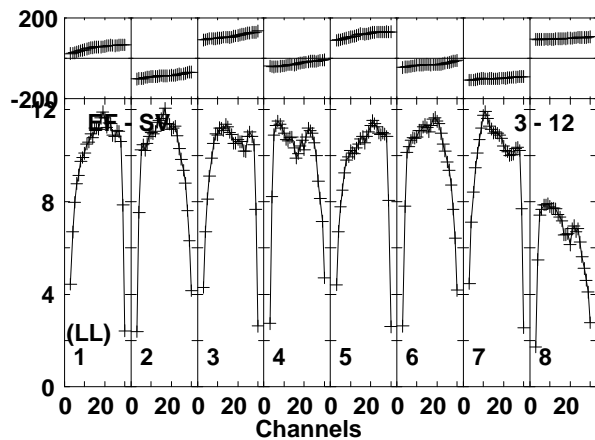
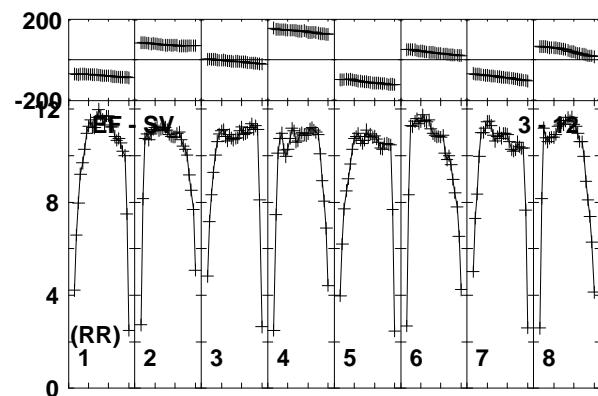
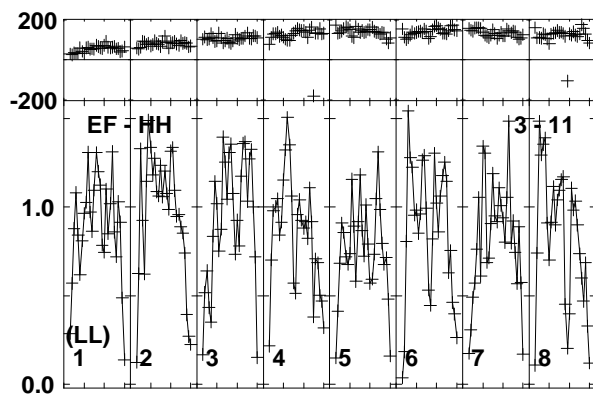
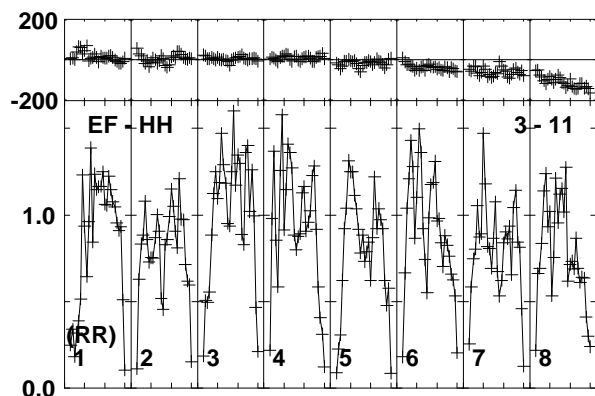
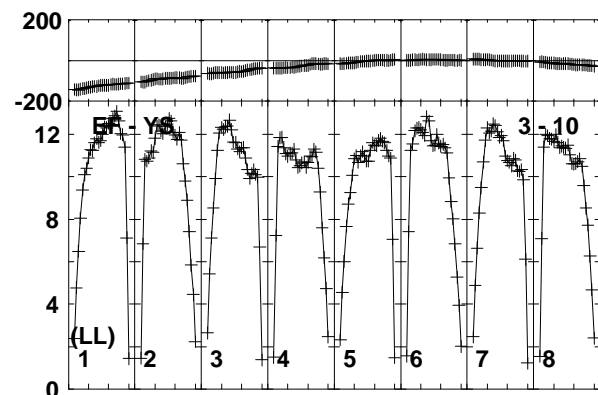
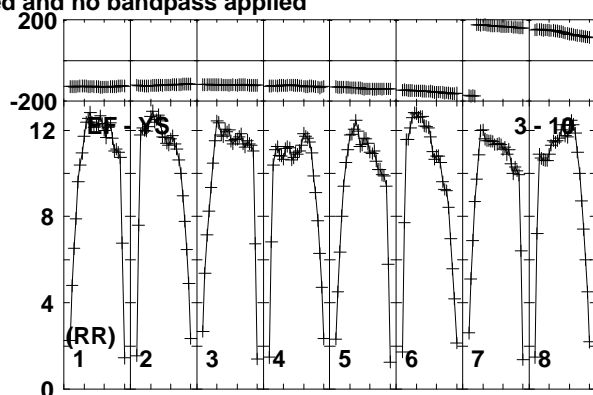
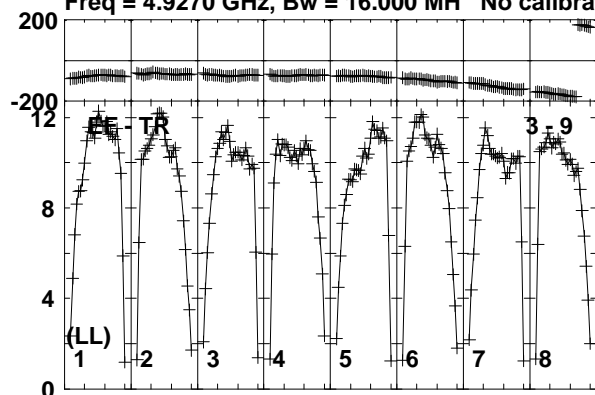

Lower frame: Milli Ampl Jy Top frame: Phas deg  
Vector averaged cross-power spectrum Baseline: EF (03) - TR (09)  
Timerange: 00:12:17:01 to 00:12:17:59

Plot file version 420 created 19-DEC-2018 17:58:42

J1619+2247 RY007C.UVDATA.1

Freq = 4.9270 GHz, Bw = 16.000 MH No calibration applied and no bandpass applied

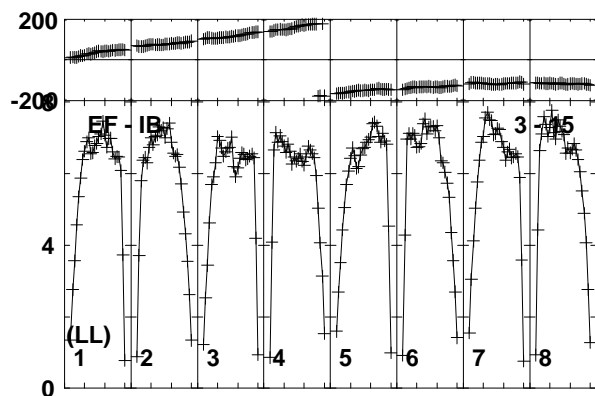
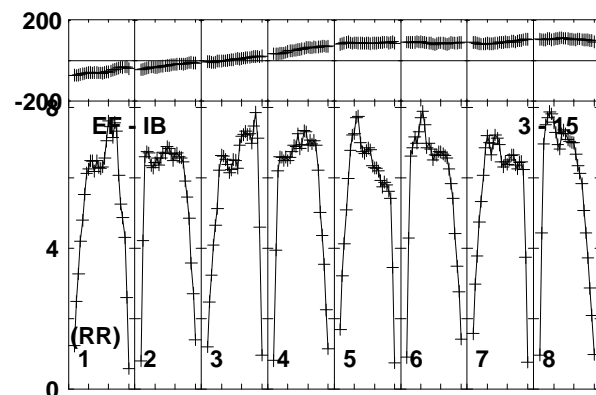
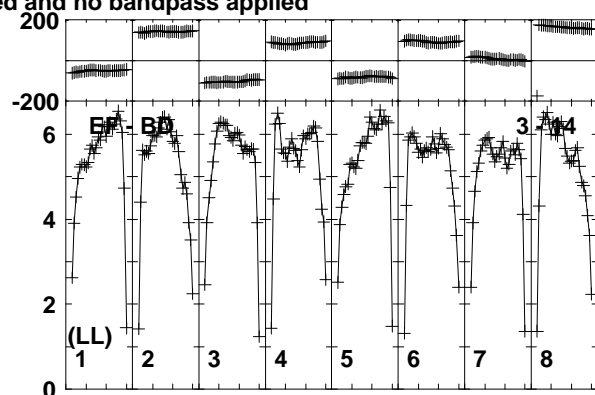
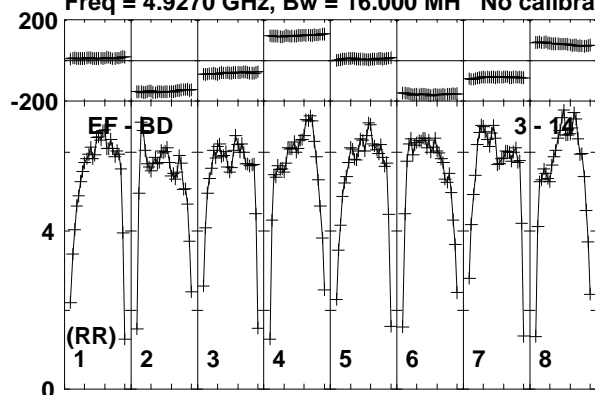

Lower frame: Milli Ampl Jy Top frame: Phas deg

Vector averaged cross-power spectrum Baseline: EF (03) - BD (14)

Timerange: 00:12:17:01 to 00:12:17:59

Plot file version 421 created 19-DEC-2018 17:58:43

AT2018\_RY007C.UVDATA.1

Freq = 4.9270 GHz, Bw = 16.000 MH No calibration applied and no bandpass applied

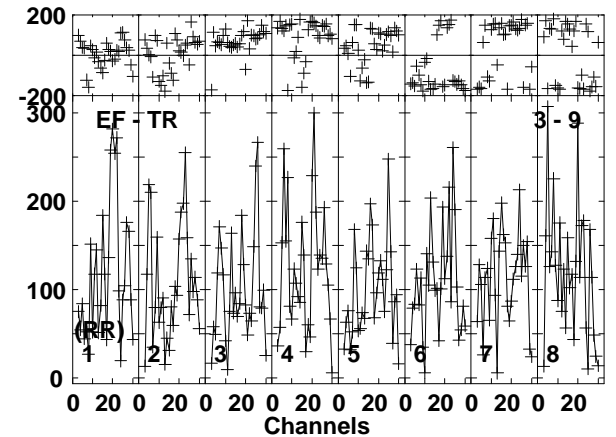
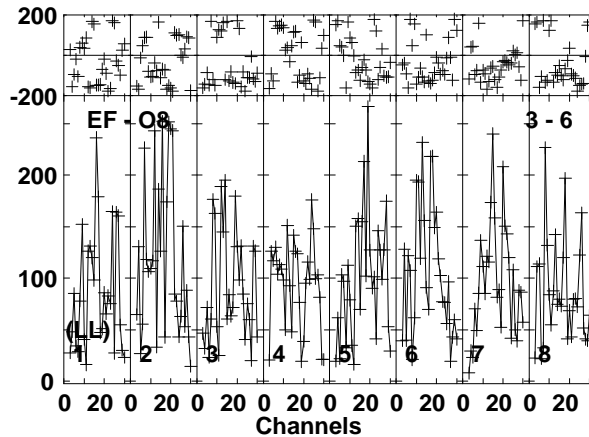
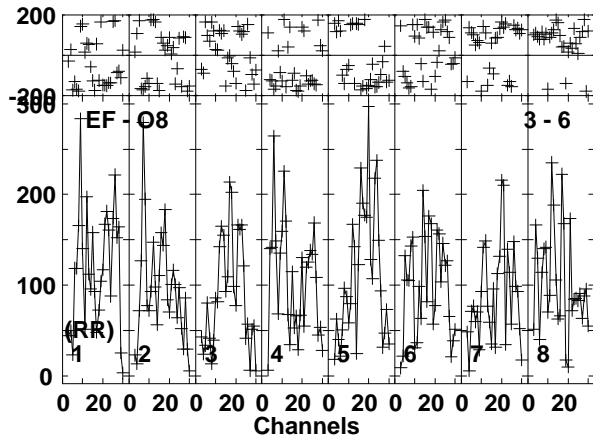
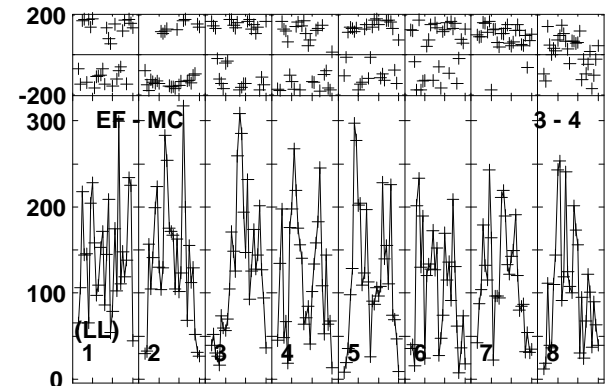
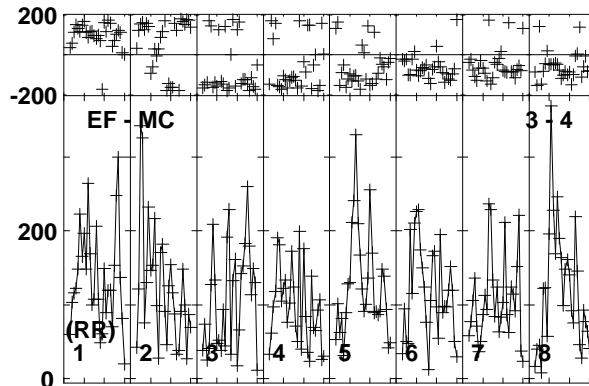
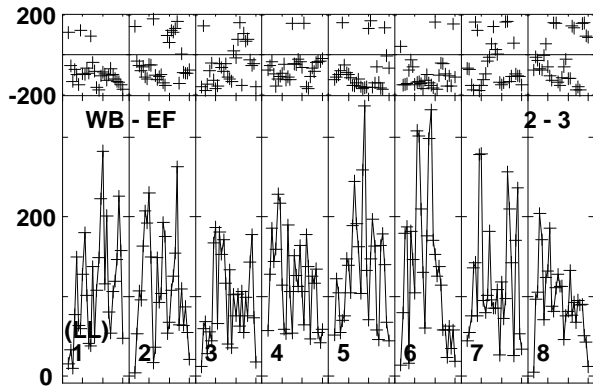
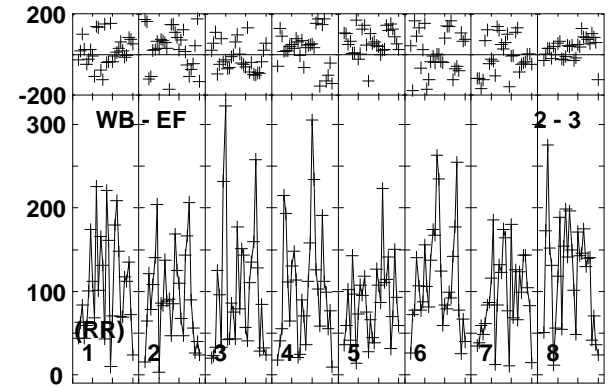
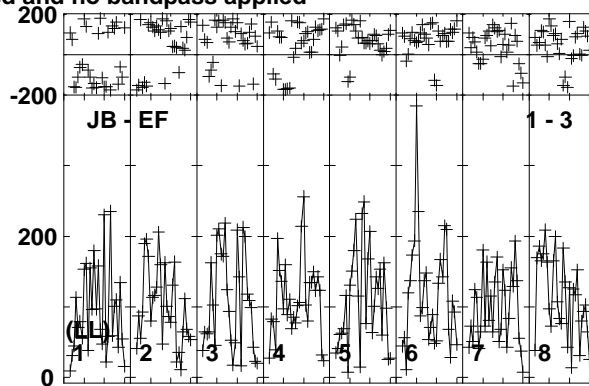
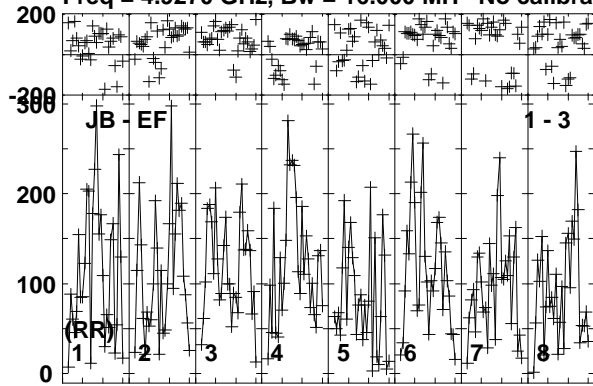

Lower frame: Micro Ampl Jy Top frame: Phas deg  
Vector averaged cross-power spectrum Baseline: JB (01) - EF (03)  
Timerange: 00/12:18:01 to 00/12:20:59

Plot file version 422 created 19-DEC-2018 17:58:43

AT2018\_RY007C.UVDATA.1

Freq = 4.9270 GHz, Bw = 16.000 MH No calibration applied and no bandpass applied

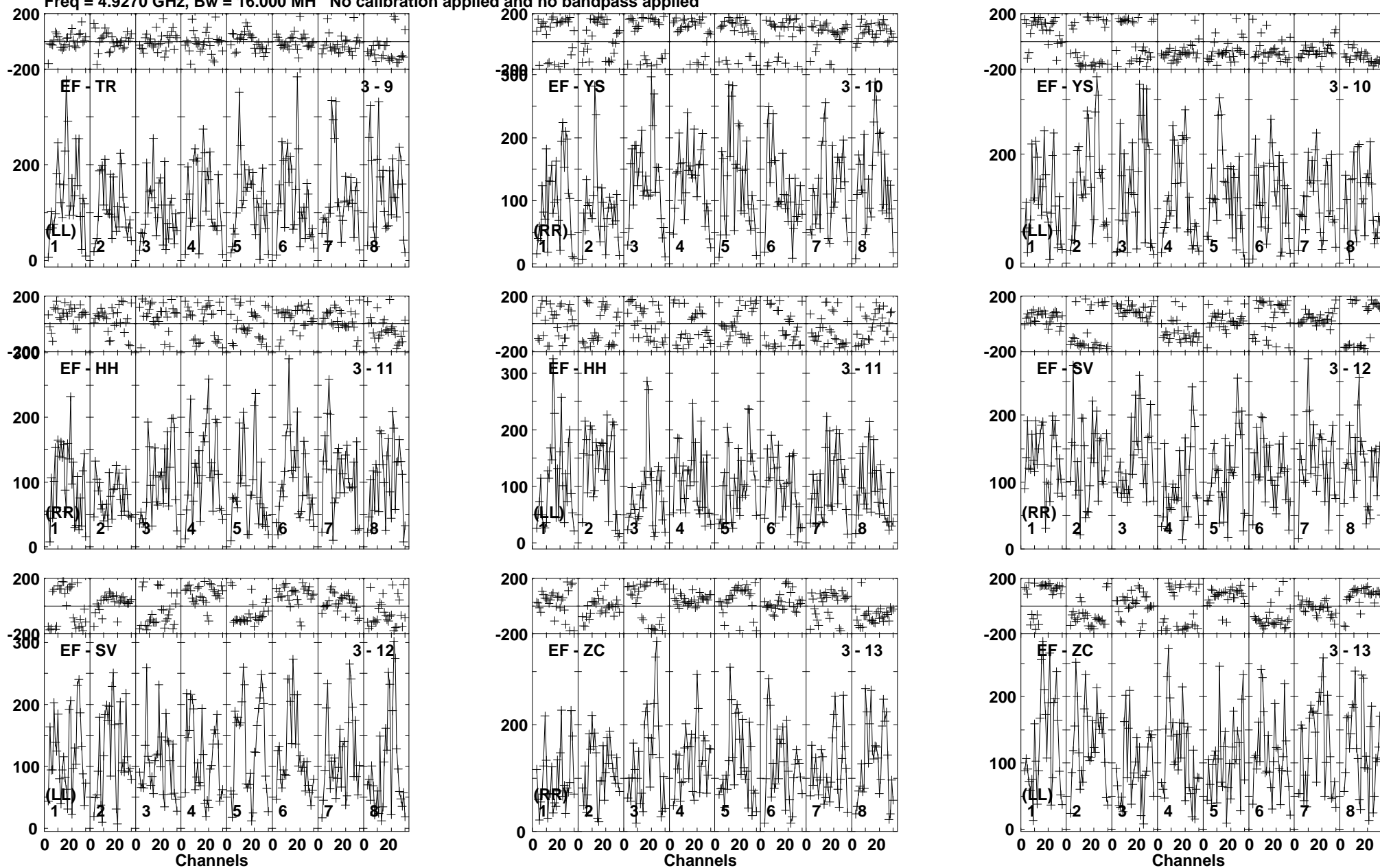

Lower frame: Micro Ampl Jy Top frame: Phas deg  
Vector averaged cross-power spectrum Baseline: EF (03) - TR (09)  
Timerange: 00:12:18:01 to 00:12:20:59

Plot file version 423 created 19-DEC-2018 17:58:43

AT2018\_RY007C.UVDATA.1

Freq = 4.9270 GHz, Bw = 16.000 MH No calibration applied and no bandpass applied

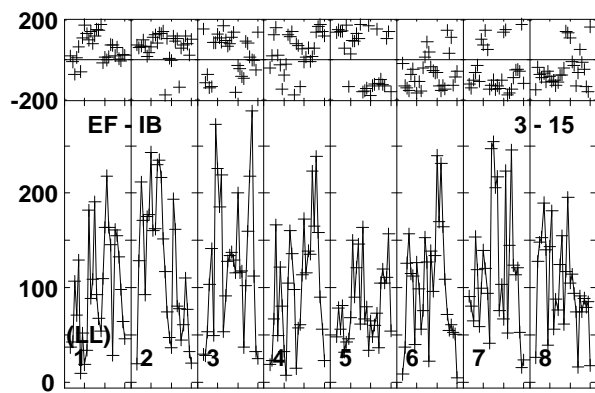
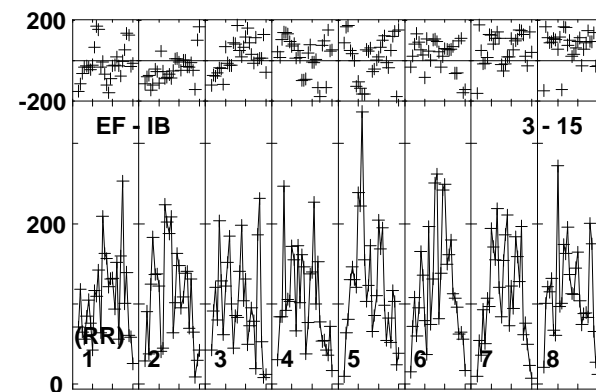
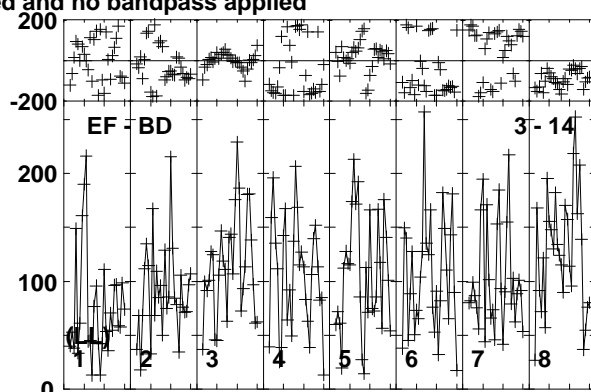
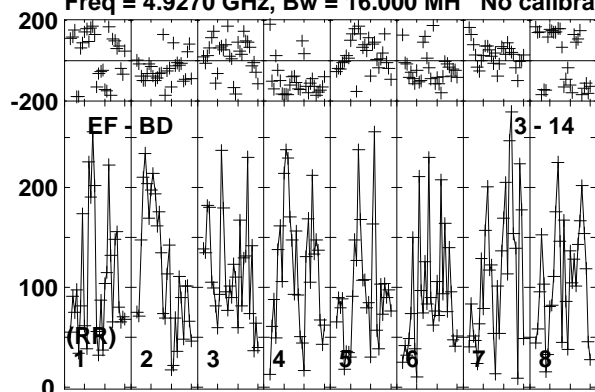

Lower frame: Micro Ampl Jy Top frame: Phas deg  
Vector averaged cross-power spectrum Baseline: EF (03) - BD (14)  
Timerange: 00/12:18:01 to 00/12:20:59

Plot file version 424 created 19-DEC-2018 17:58:43

J1619+2247 RY007C.UVDATA.1

Freq = 4.9270 GHz, Bw = 16.000 MH No calibration applied and no bandpass applied

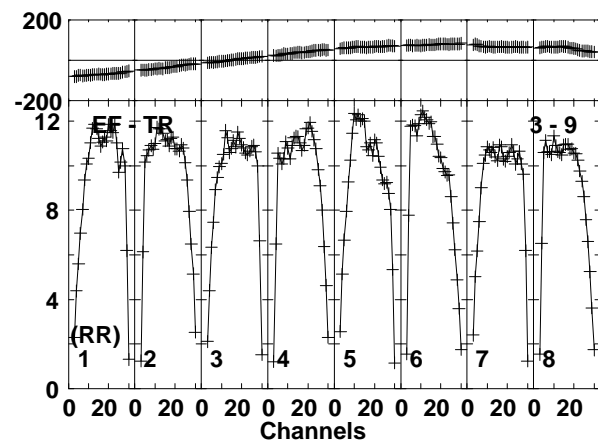
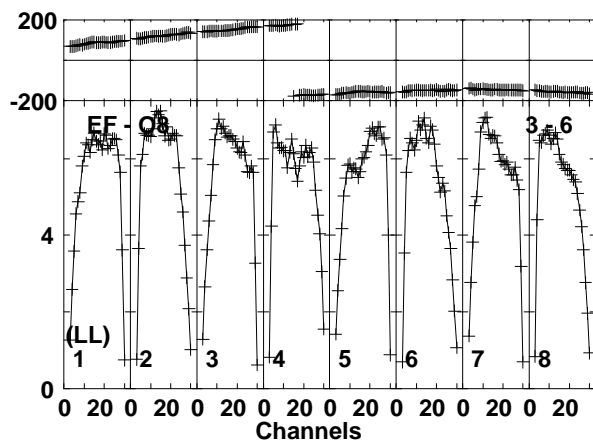
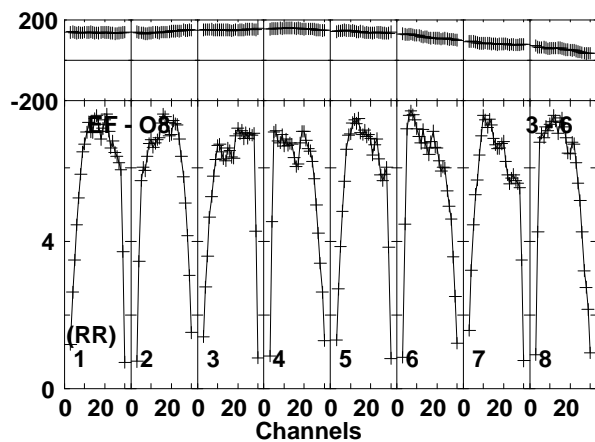
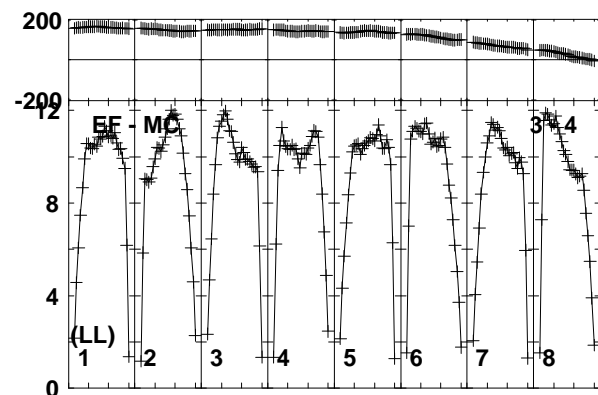
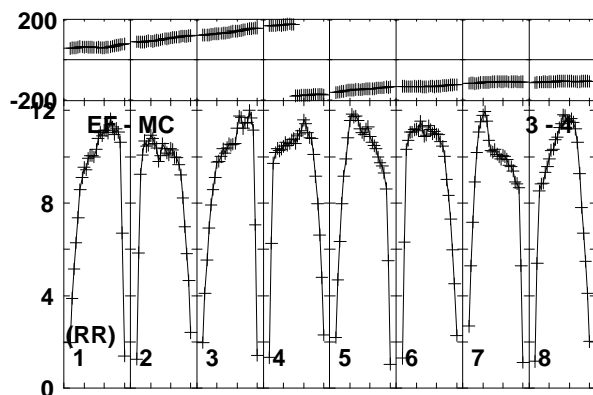
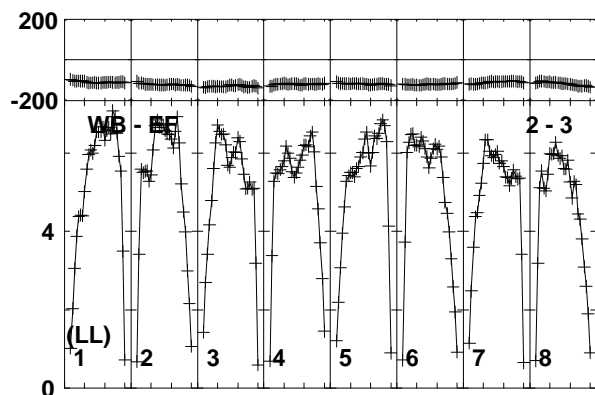
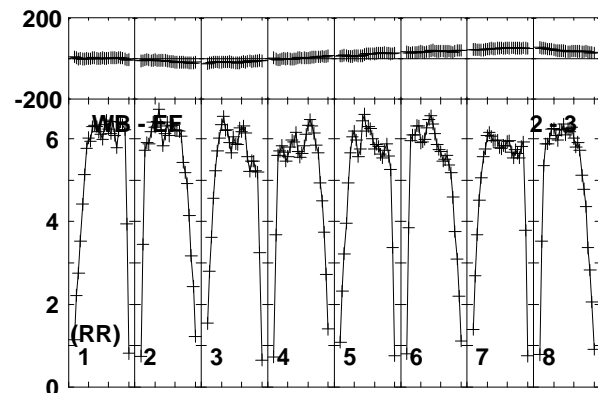
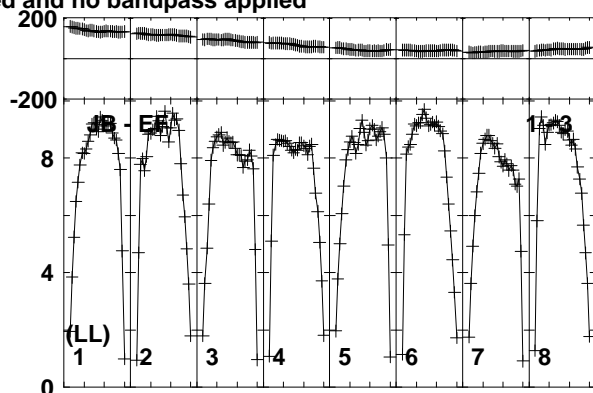
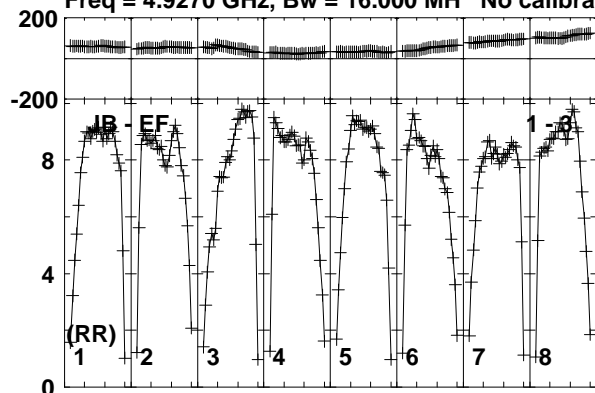

Lower frame: Milli Ampl Jy Top frame: Phas deg  
Vector averaged cross-power spectrum Baseline: JB (01) - EF (03)  
Timerange: 00/12:21:01 to 00/12:21:59

Plot file version 425 created 19-DEC-2018 17:58:43

J1619+2247 RY007C.UVDATA.1

Freq = 4.9270 GHz, Bw = 16.000 MH No calibration applied and no bandpass applied

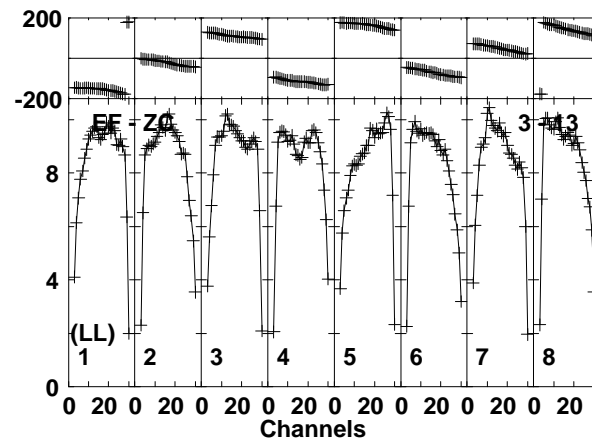
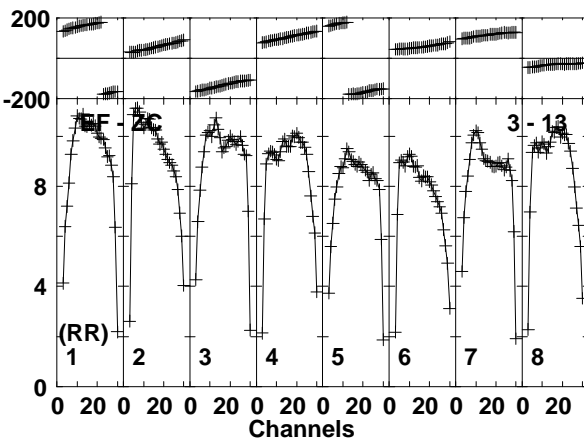
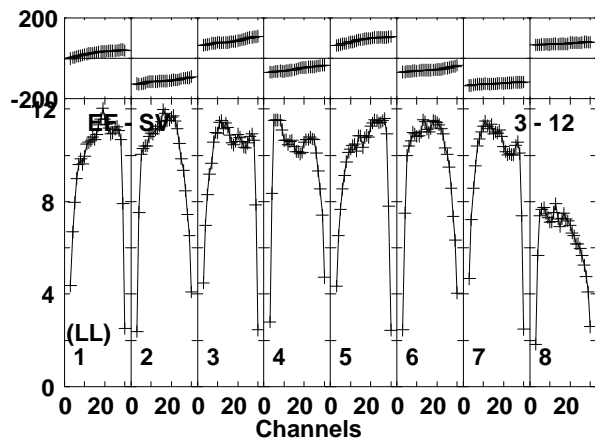
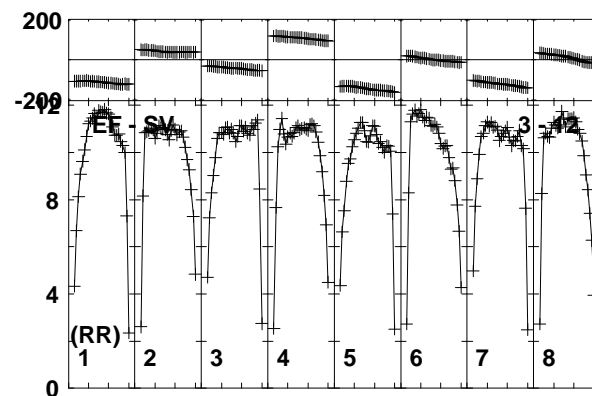
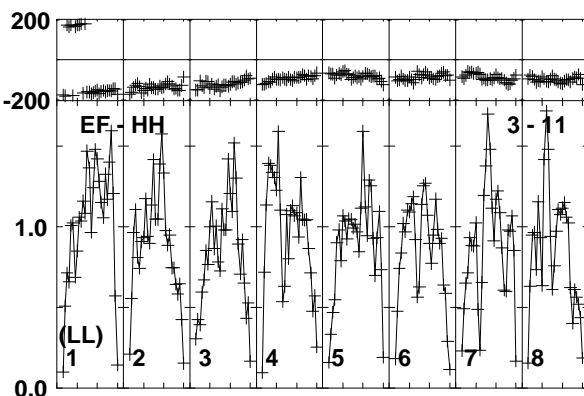
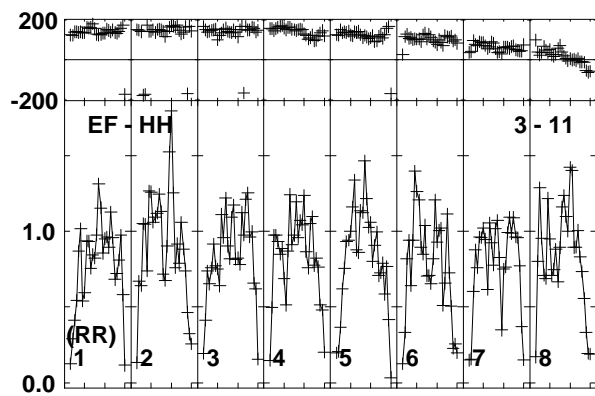
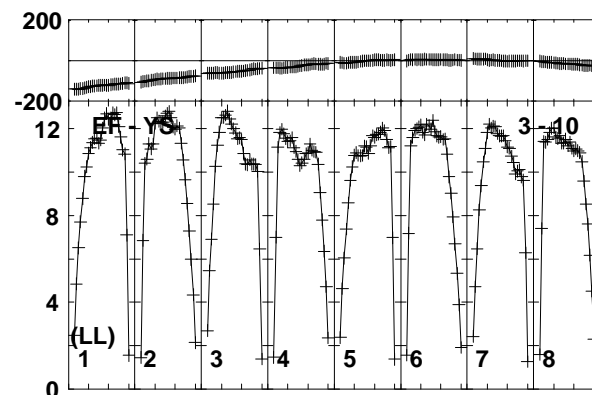
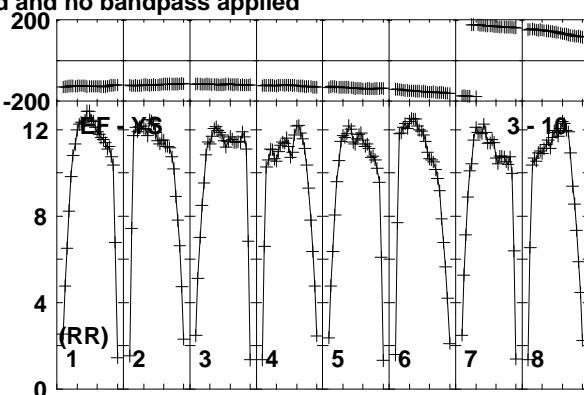
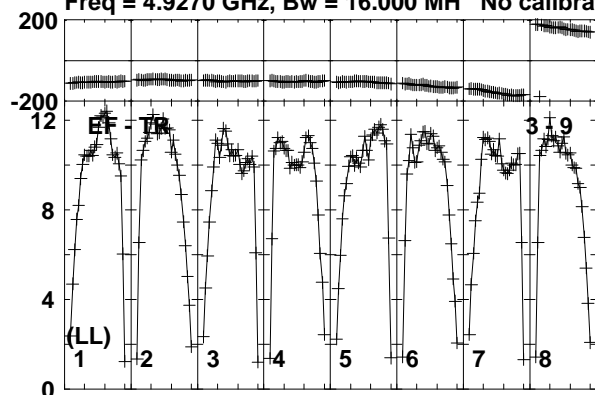

Lower frame: Milli Ampl Jy Top frame: Phas deg  
Vector averaged cross-power spectrum Baseline: EF (03) - TR (09)  
Timerange: 00/12:21:01 to 00/12:21:59

Plot file version 426 created 19-DEC-2018 17:58:43

J1619+2247 RY007C.UVDATA.1

Freq = 4.9270 GHz, Bw = 16.000 MH No calibration applied and no bandpass applied

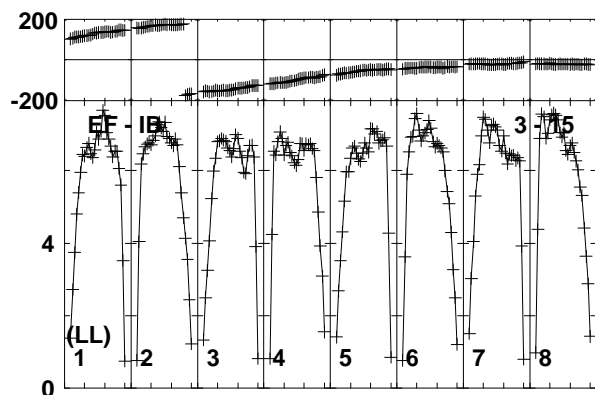
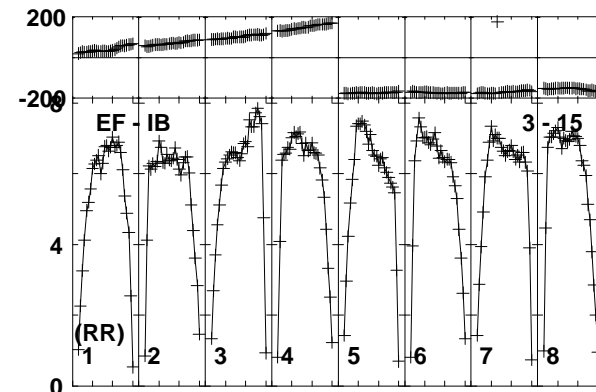
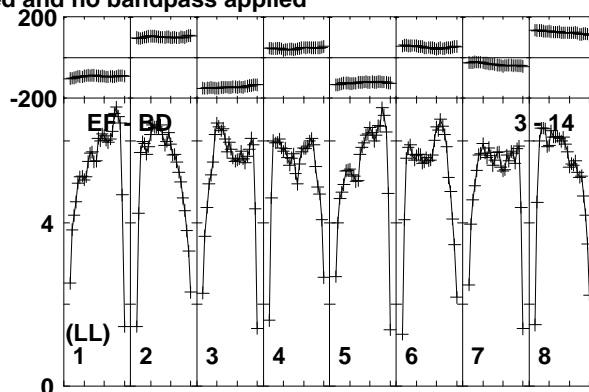
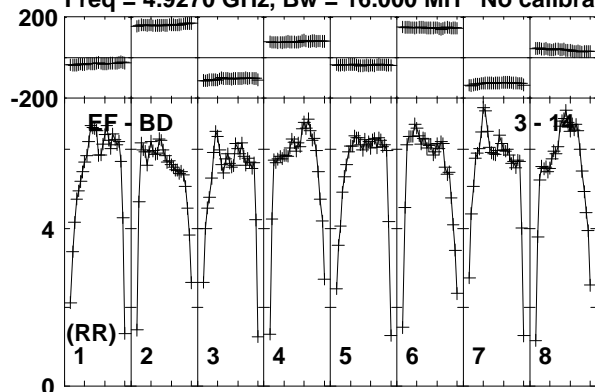

Lower frame: Milli Ampl Jy Top frame: Phas deg

Vector averaged cross-power spectrum Baseline: EF (03) - BD (14)

Timerange: 00:12:21:01 to 00:12:21:59



Plot file version 427 created 19-DEC-2018 17:58:43

AT2018\_RY007C.UVDATA.1

Freq = 4.9270 GHz, Bw = 16.000 MH No calibration applied and no bandpass applied

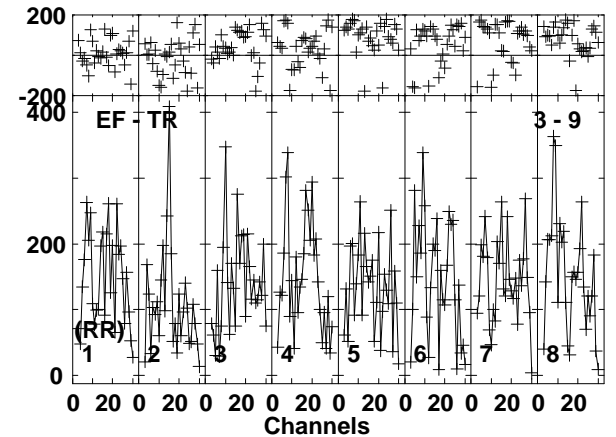
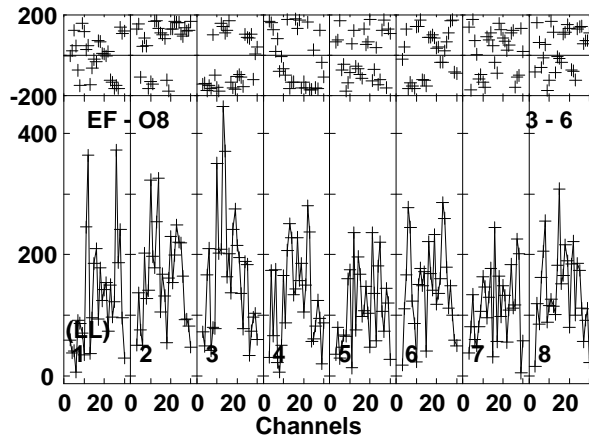
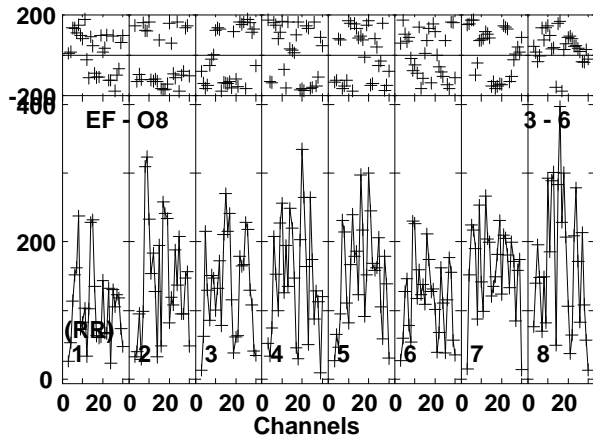
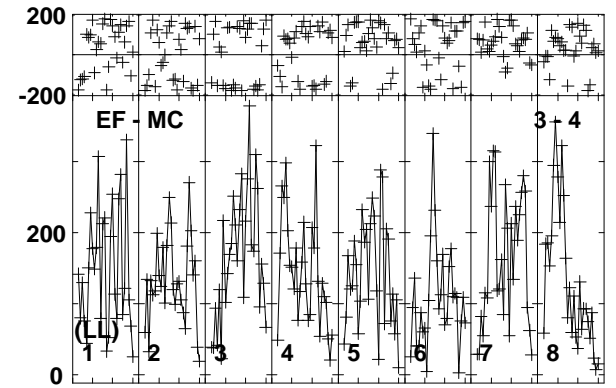
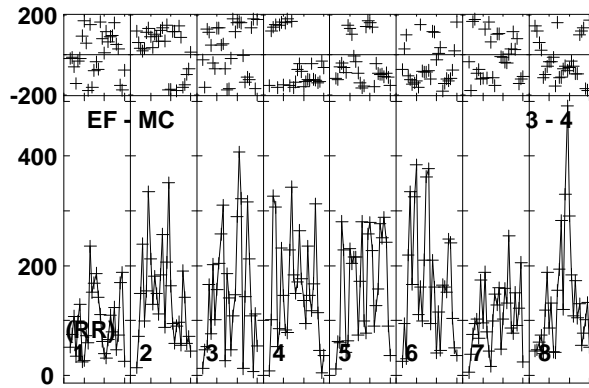
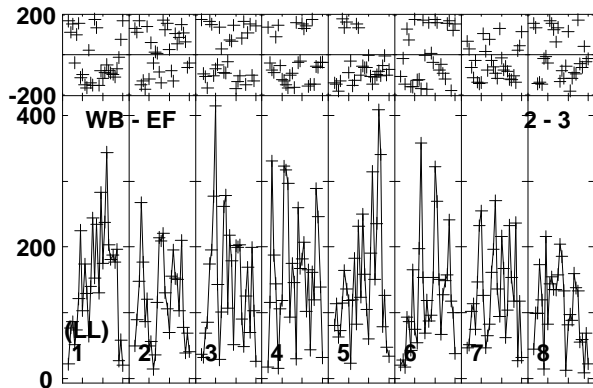
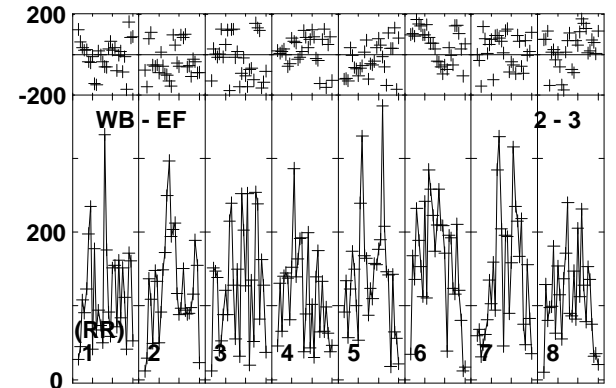
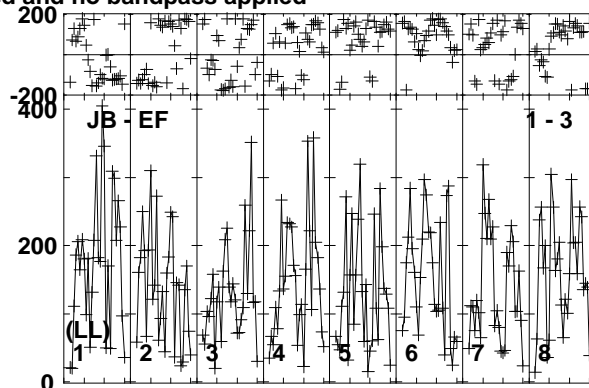
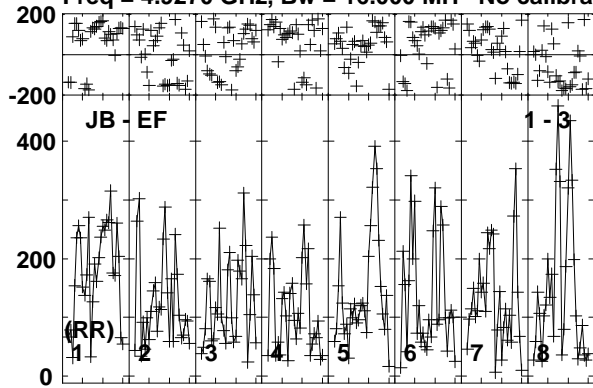

Lower frame: Micro Ampl Jy Top frame: Phas deg  
Vector averaged cross-power spectrum Baseline: JB (01) - EF (03)  
Timerange: 00:12:22:01 to 00:12:23:59

Plot file version 428 created 19-DEC-2018 17:58:43

AT2018\_RY007C.UVDATA.1

Freq = 4.9270 GHz, Bw = 16.000 MH No calibration applied and no bandpass applied

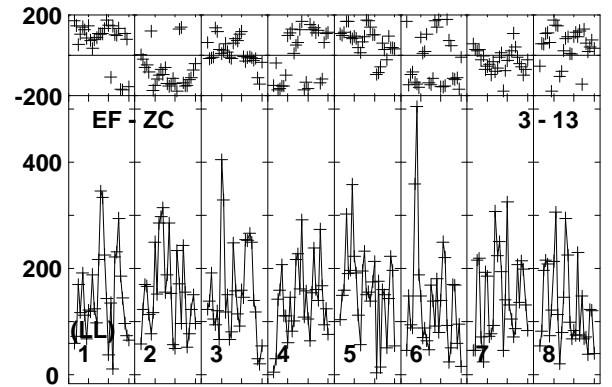
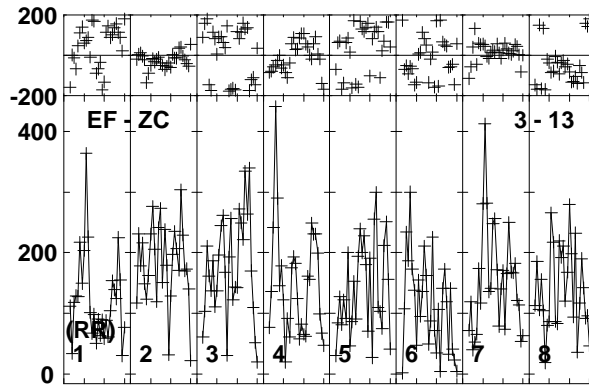
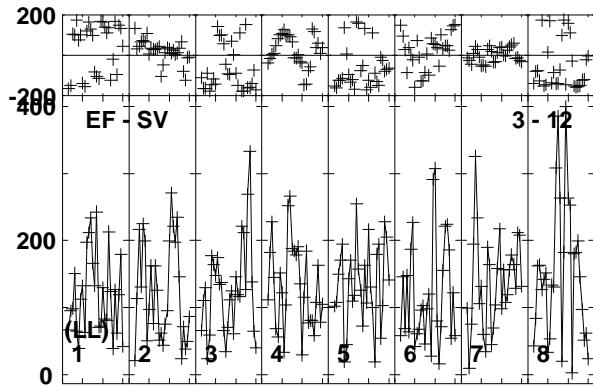
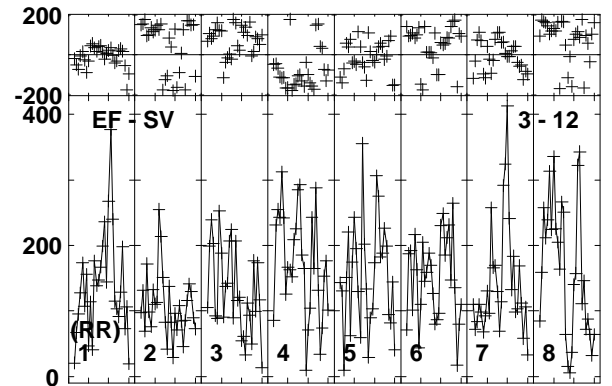
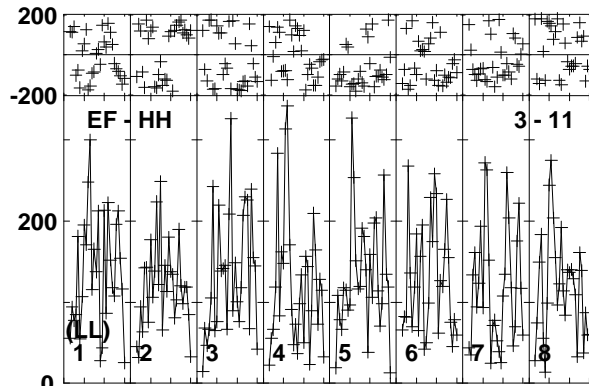
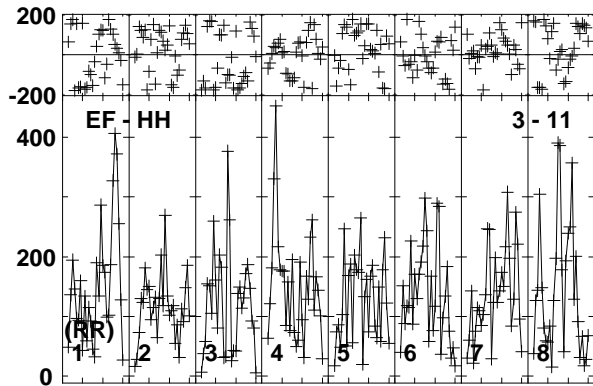
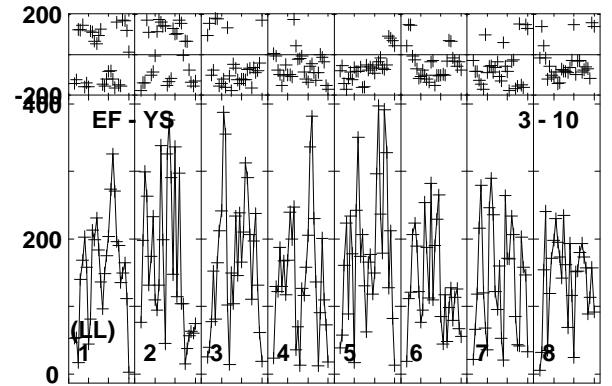
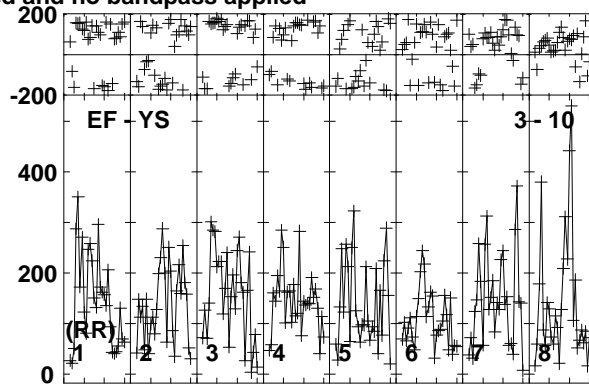
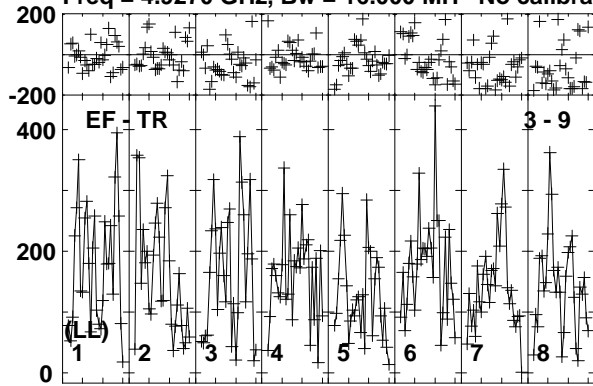

Lower frame: Micro Ampl Jy Top frame: Phas deg  
Vector averaged cross-power spectrum Baseline: EF (03) - TR (09)  
Timerange: 00/12:22:01 to 00/12:23:59

Plot file version 429 created 19-DEC-2018 17:58:43

AT2018\_RY007C.UVDATA.1

Freq = 4.9270 GHz, Bw = 16.000 MH No calibration applied and no bandpass applied

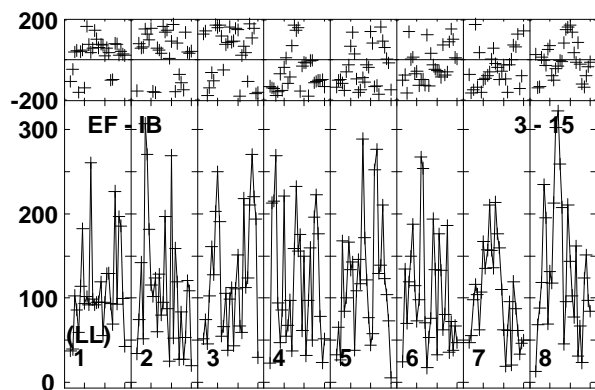
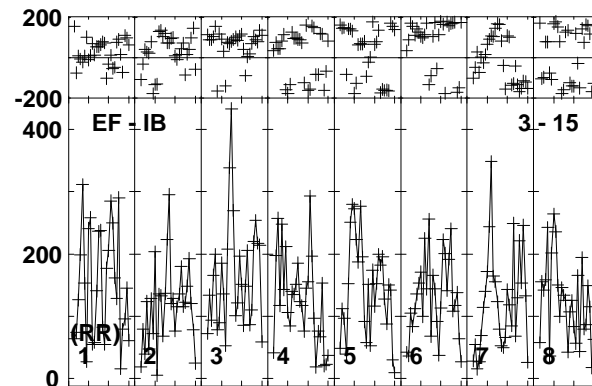
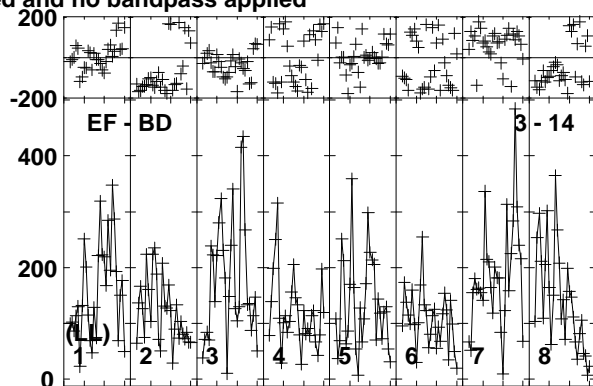
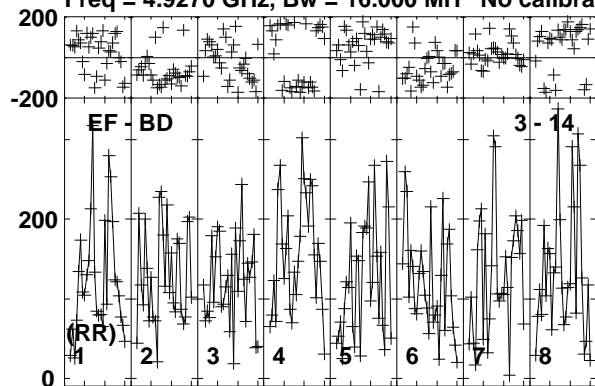

Lower frame: Micro Ampl Jy Top frame: Phas deg  
Vector averaged cross-power spectrum Baseline: EF (03) - BD (14)  
Timerange: 00/12:22:01 to 00/12:23:59

Plot file version 430 created 19-DEC-2018 17:58:43

VLA2 RY007C.UVDATA.1

Freq = 4.9270 GHz, Bw = 16.000 MH No calibration applied and no bandpass applied

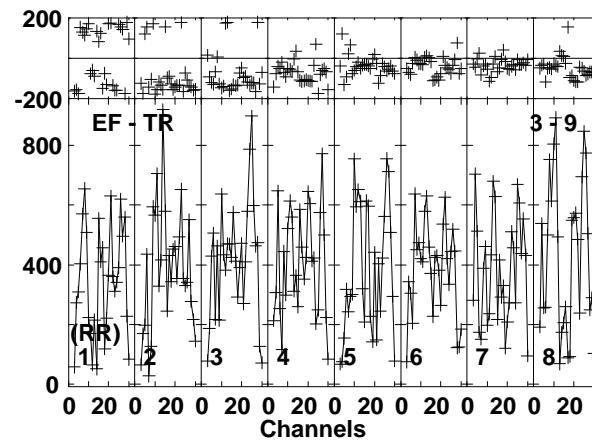
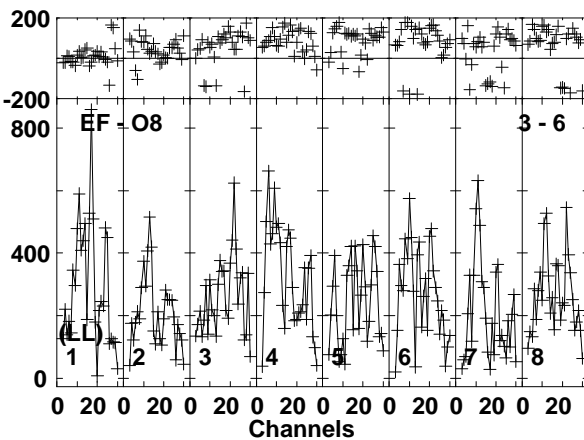
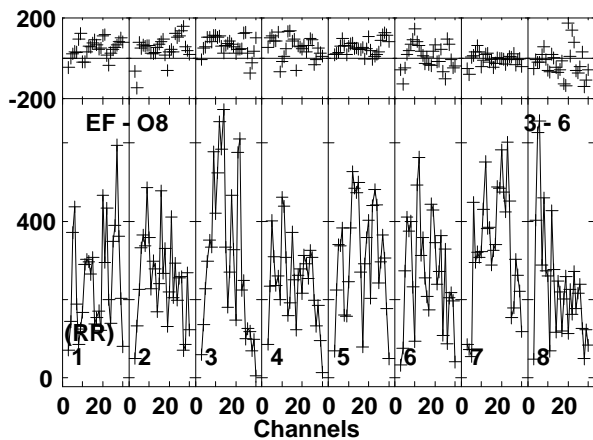
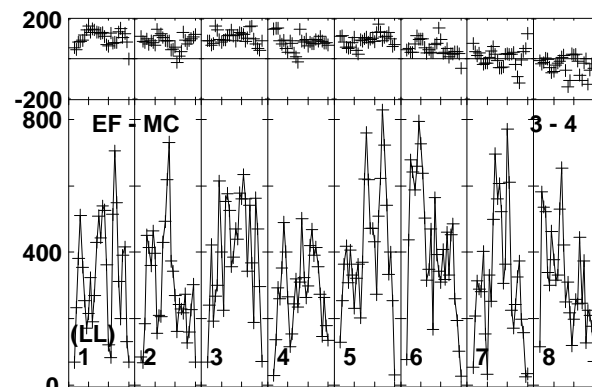
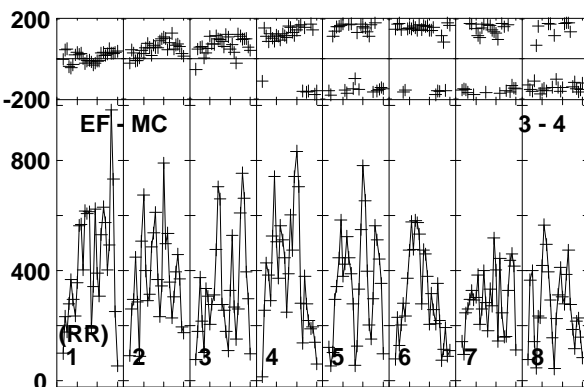
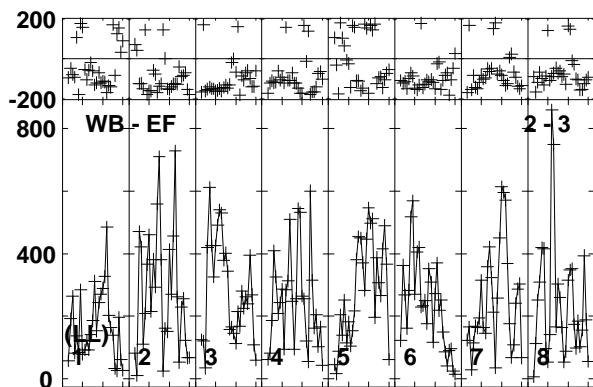
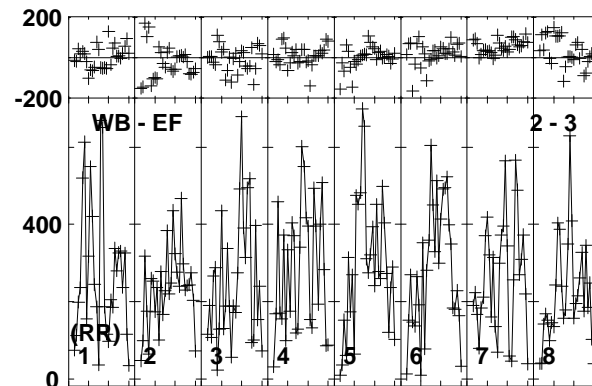
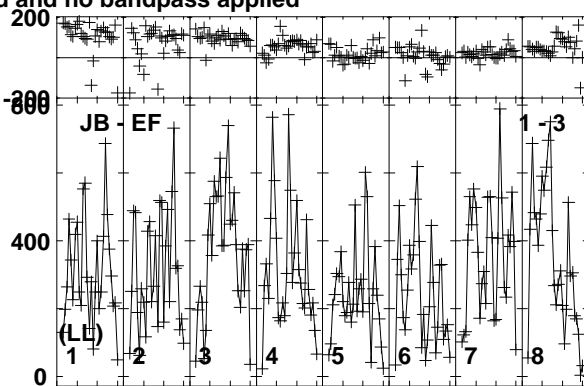
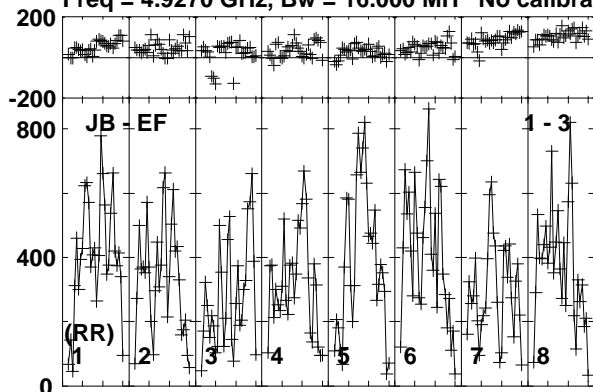

Lower frame: Micro Ampl Jy Top frame: Phas deg  
Vector averaged cross-power spectrum Baseline: JB (01) - EF (03)  
Timerange: 00/12:24:01 to 00/12:24:59

Plot file version 431 created 19-DEC-2018 17:58:43

VLA2\_RY007C.UVDATA.1

Freq = 4.9270 GHz, Bw = 16.000 MH No calibration applied and no bandpass applied

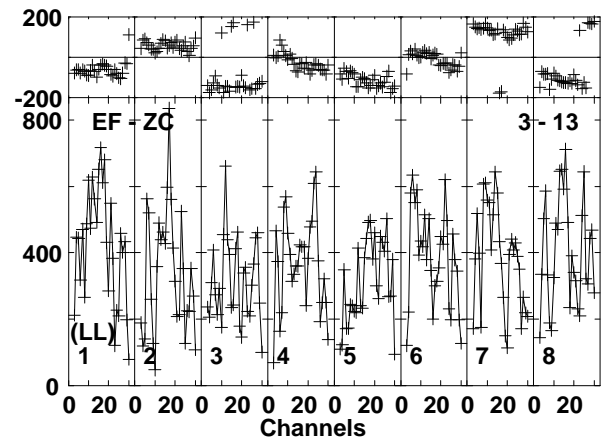
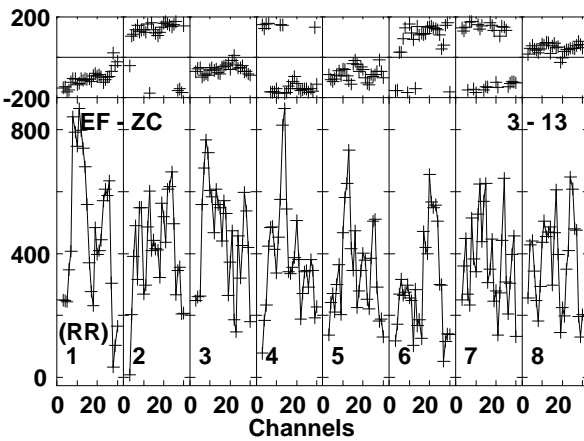
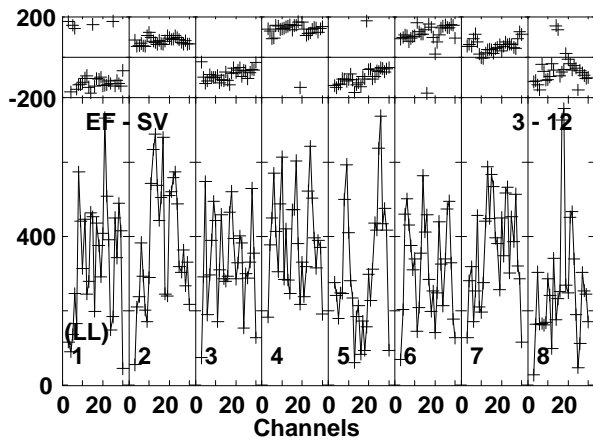
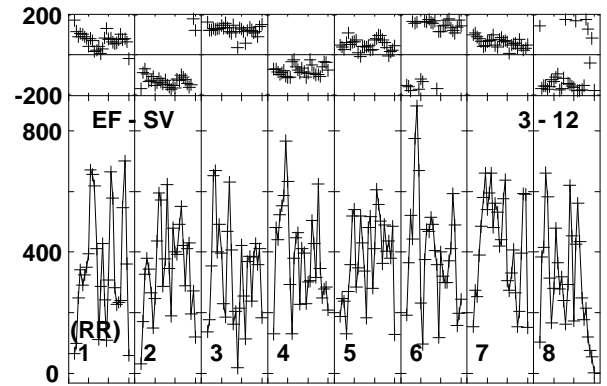
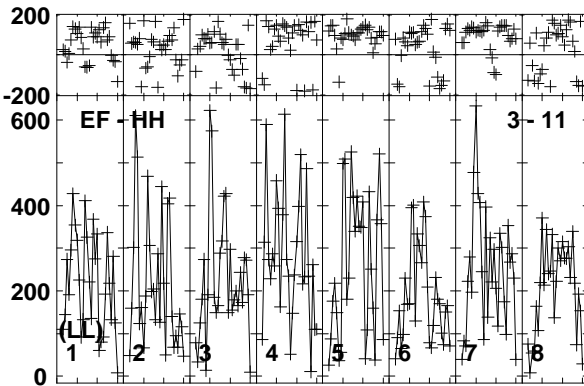
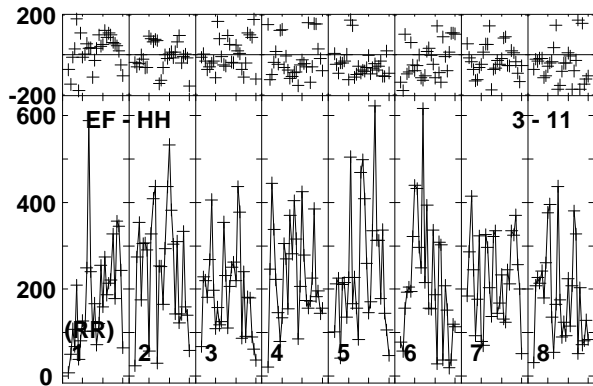
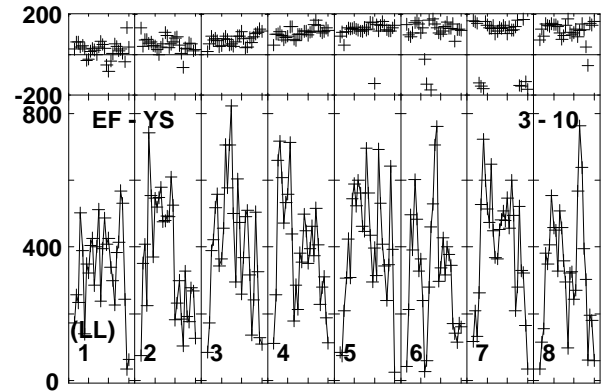
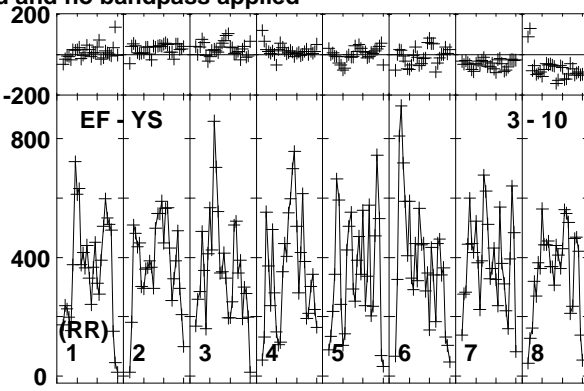
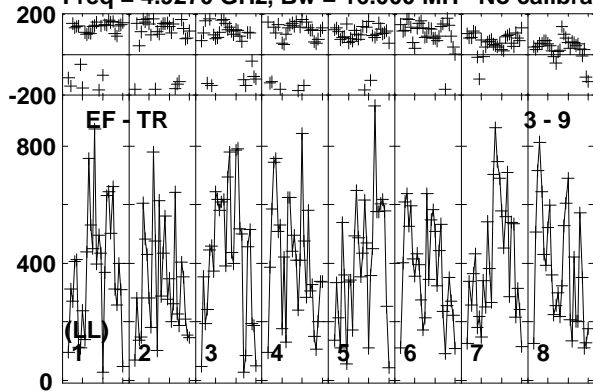

Lower frame: Micro Ampl Jy Top frame: Phas deg  
Vector averaged cross-power spectrum Baseline: EF (03) - TR (09)  
Timerange: 00:12:24:01 to 00:12:24:59

Plot file version 432 created 19-DEC-2018 17:58:43

VLA2 RY007C.UVDATA.1

Freq = 4.9270 GHz, Bw = 16.000 MH No calibration applied and no bandpass applied

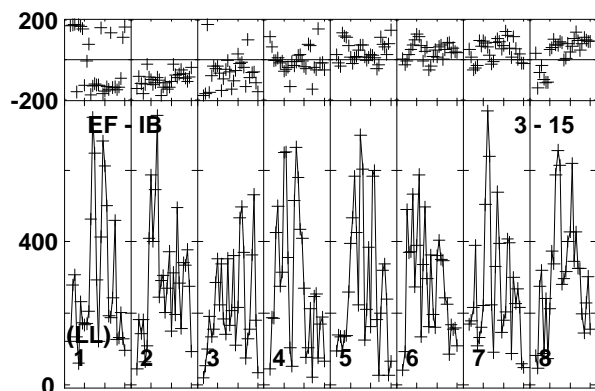
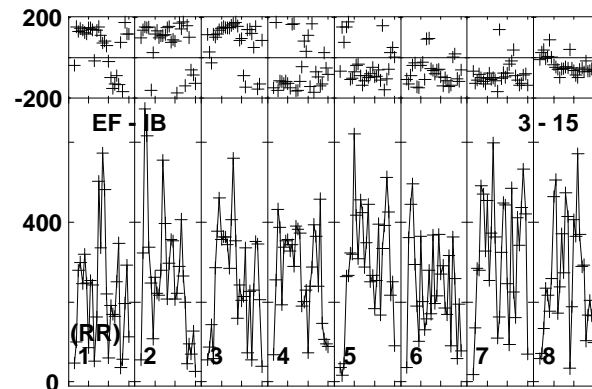
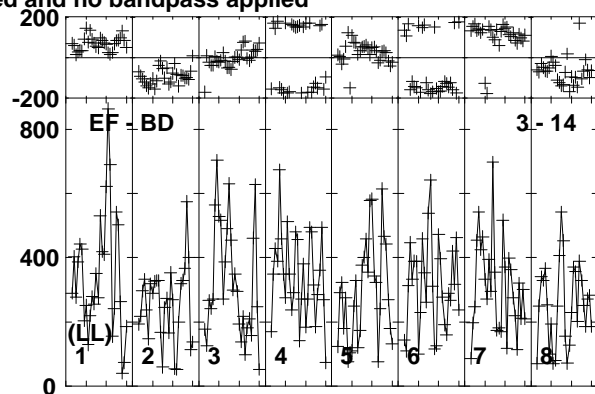
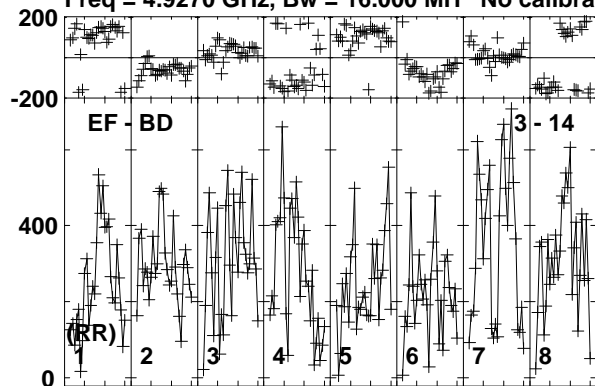

Lower frame: Micro Ampl Jy Top frame: Phas deg  
Vector averaged cross-power spectrum Baseline: EF (03) - BD (14)  
Timerange: 00/12:24:01 to 00/12:24:59

Plot file version 433 created 19-DEC-2018 17:58:43

J1619+2247 RY007C.UVDATA.1

Freq = 4.9270 GHz, Bw = 16.000 MH No calibration applied and no bandpass applied

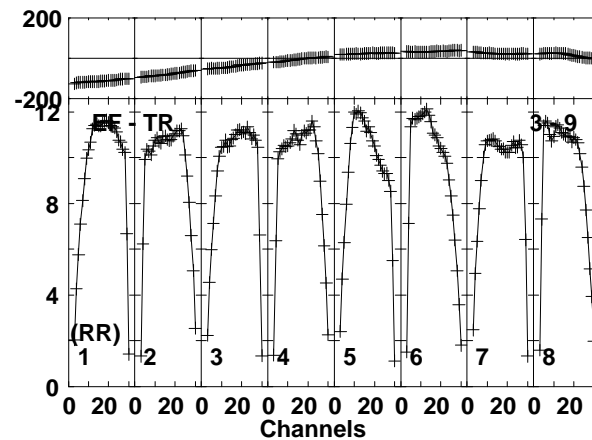
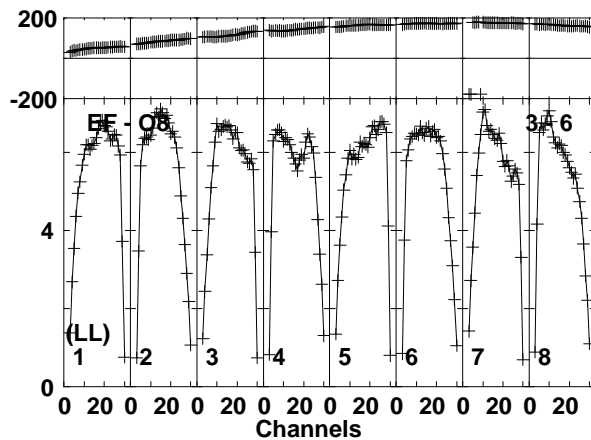
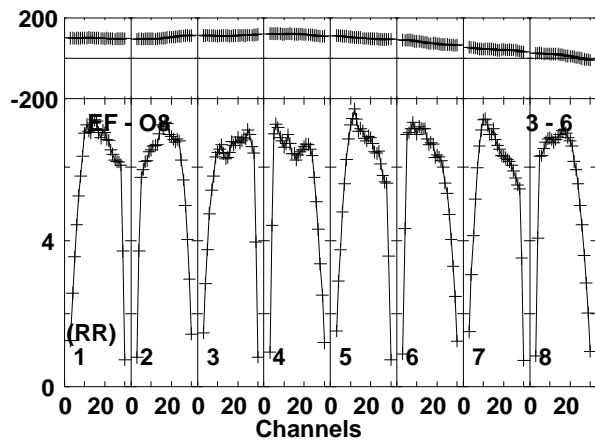
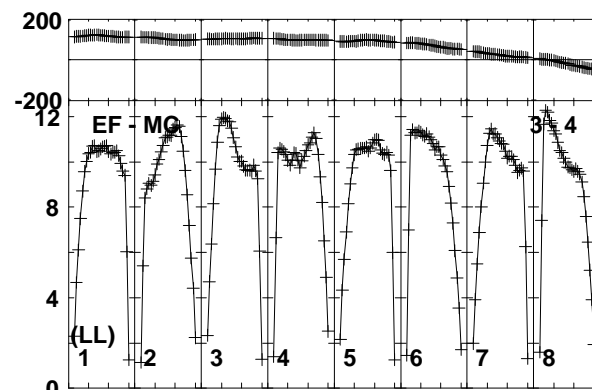
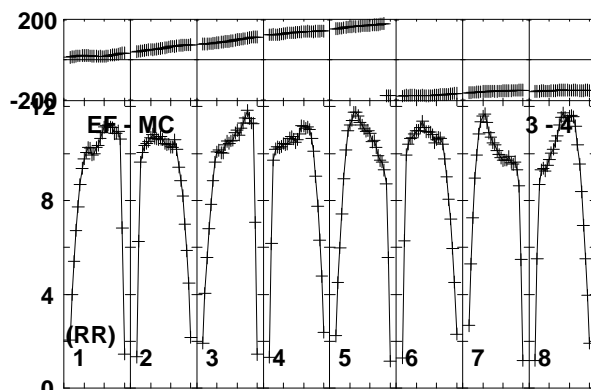
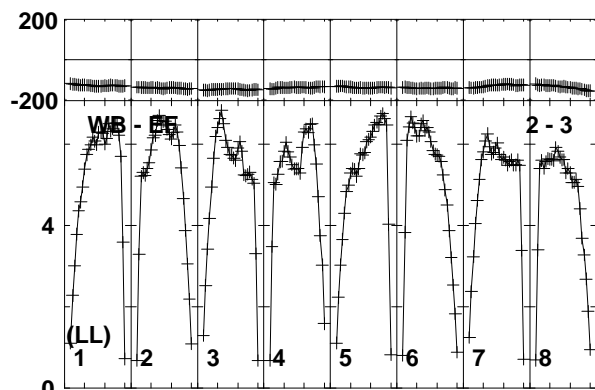
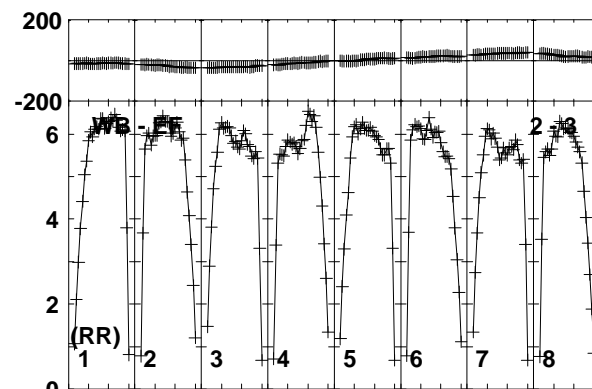
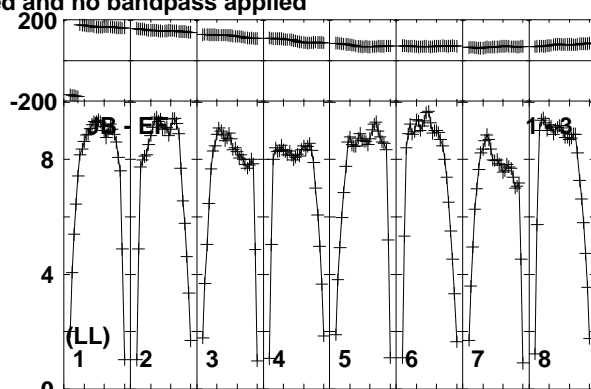
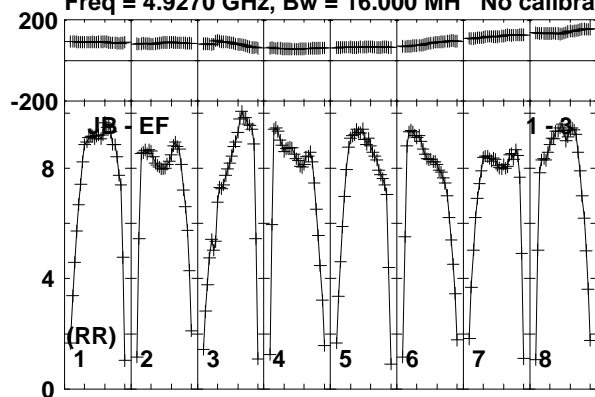

Lower frame: Milli Ampl Jy Top frame: Phas deg  
Vector averaged cross-power spectrum Baseline: JB (01) - EF (03)  
Timerange: 00/12:25:31 to 00/12:26:29

Plot file version 434 created 19-DEC-2018 17:58:43

J1619+2247 RY007C.UVDATA.1

Freq = 4.9270 GHz, Bw = 16.000 MH No calibration applied and no bandpass applied

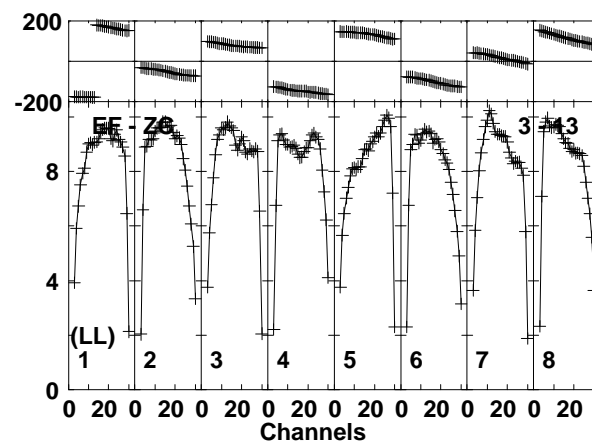
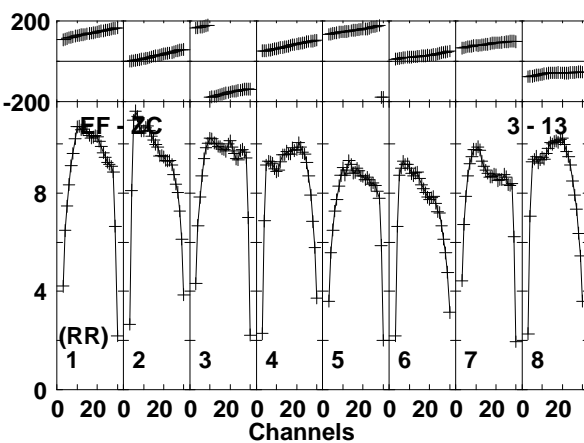
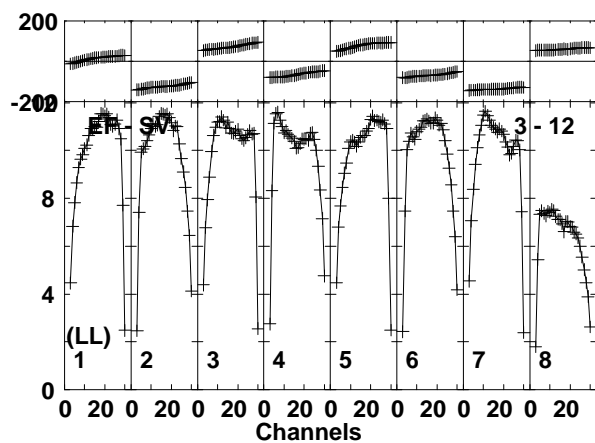
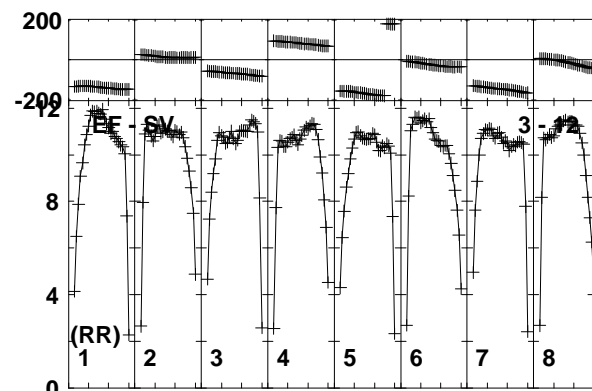
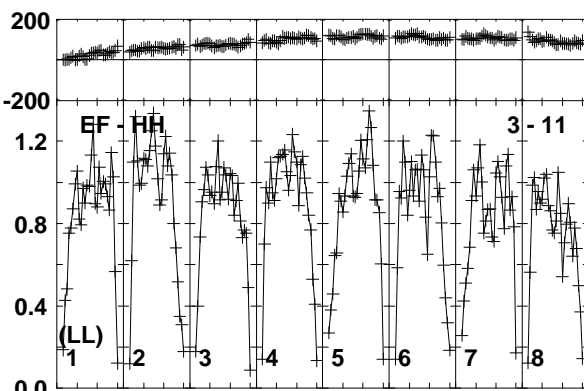
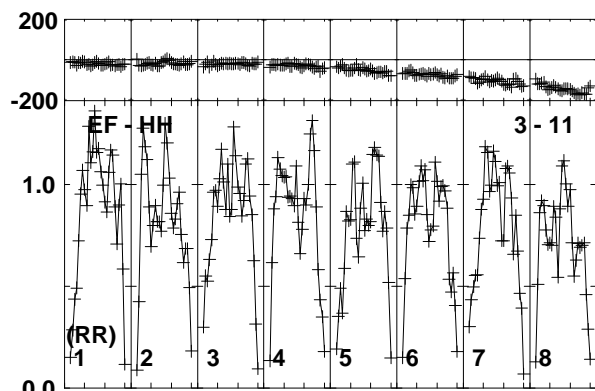
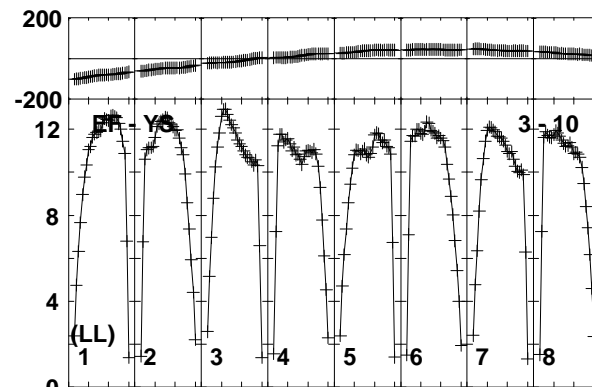
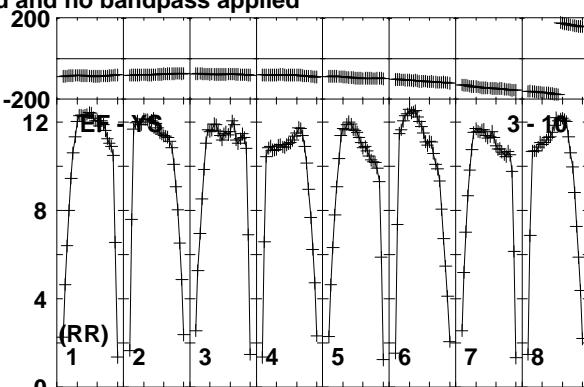
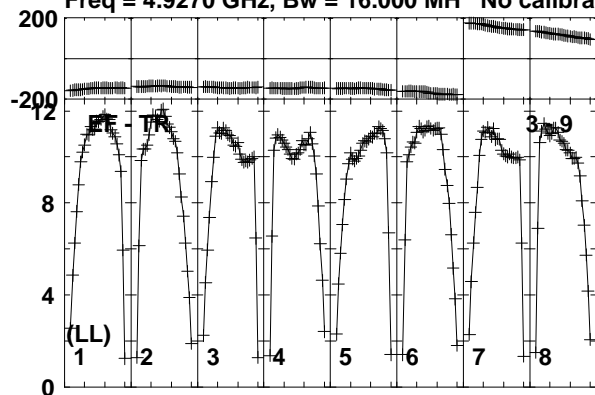

Lower frame: Milli Ampl Jy Top frame: Phas deg  
Vector averaged cross-power spectrum Baseline: EF (03) - TR (09)  
Timerange: 00:12:25:31 to 00:12:26:29



Plot file version 435 created 19-DEC-2018 17:58:45

J1619+2247 RY007C.UVDATA.1

Freq = 4.9270 GHz, Bw = 16.000 MH No calibration applied and no bandpass applied

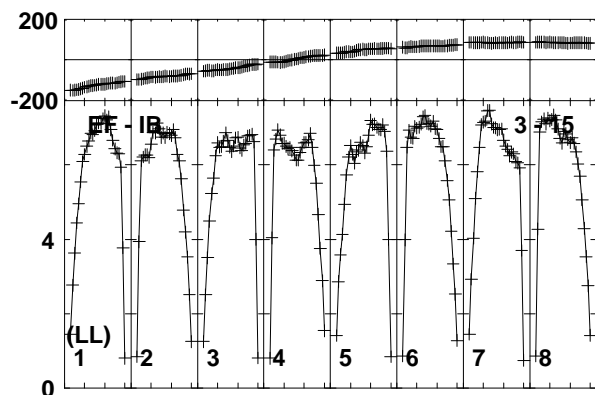
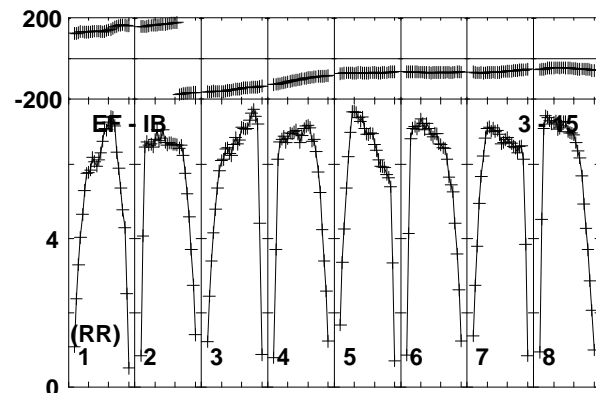
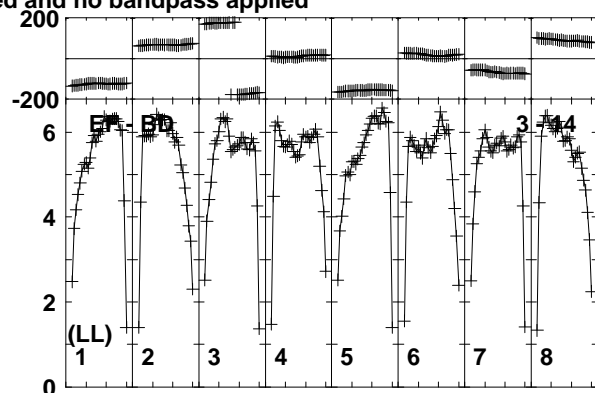
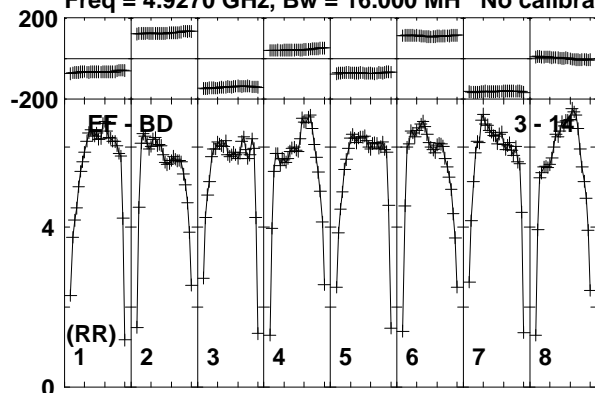

Lower frame: Milli Ampl Jy Top frame: Phas deg  
Vector averaged cross-power spectrum Baseline: EF (03) - BD (14)  
Timerange: 00/12:25:31 to 00/12:26:29

Plot file version 436 created 19-DEC-2018 17:58:45  
AT2018\_RY007C.UVDATA.1

Freq = 4.9270 GHz, Bw = 16.000 MH No calibration applied and no bandpass applied

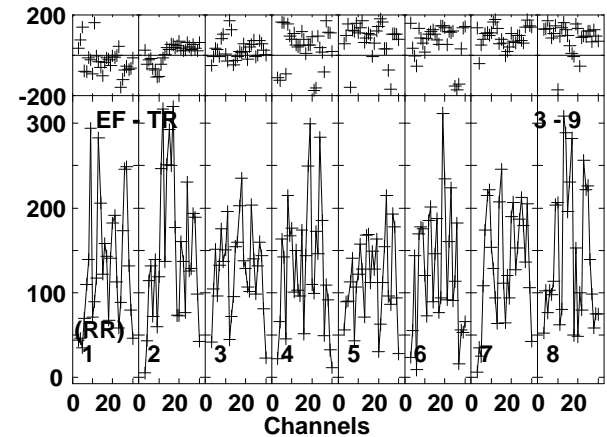
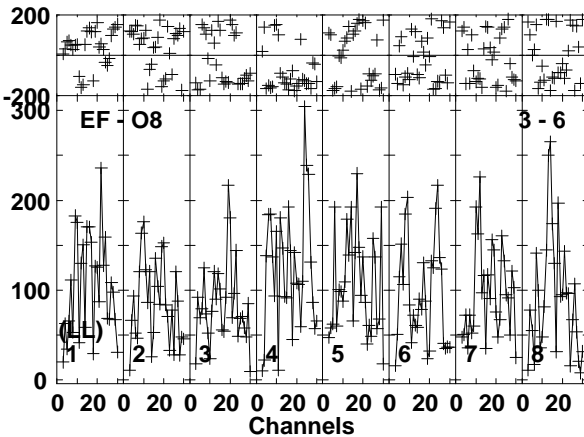
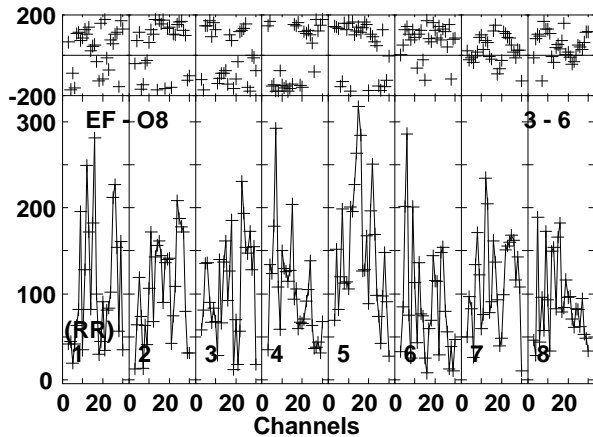
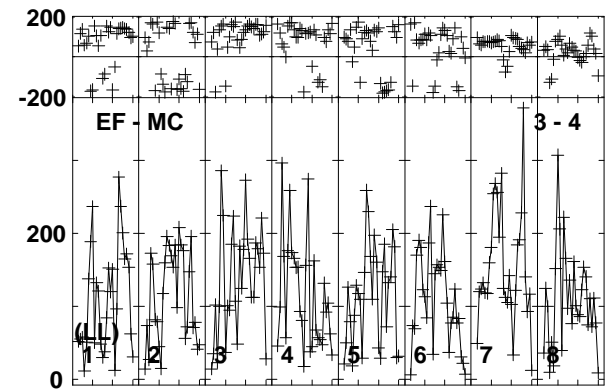
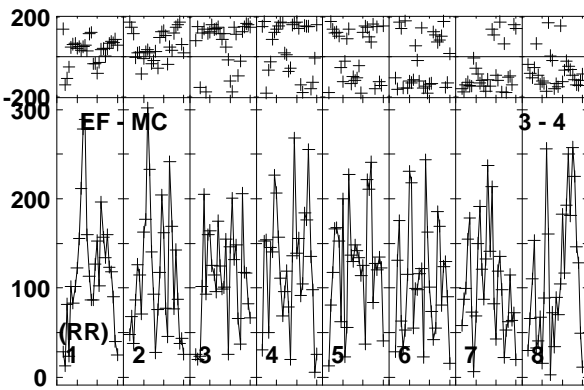
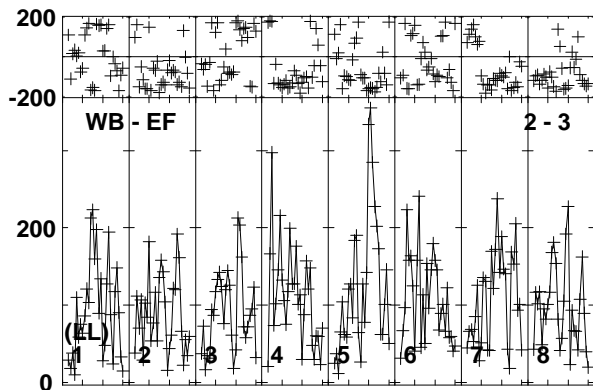
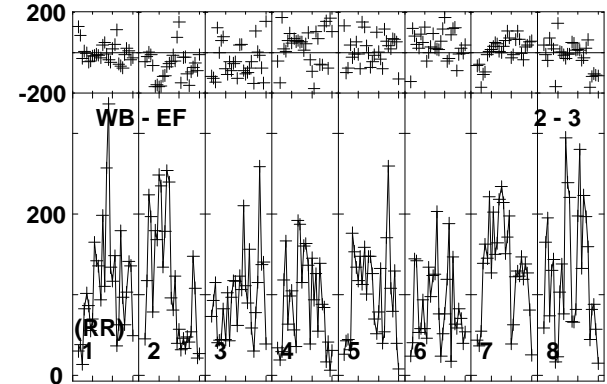
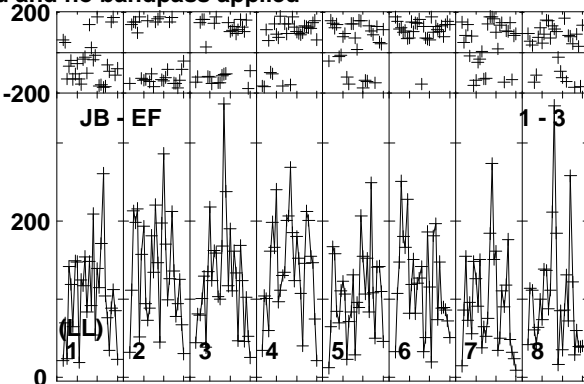
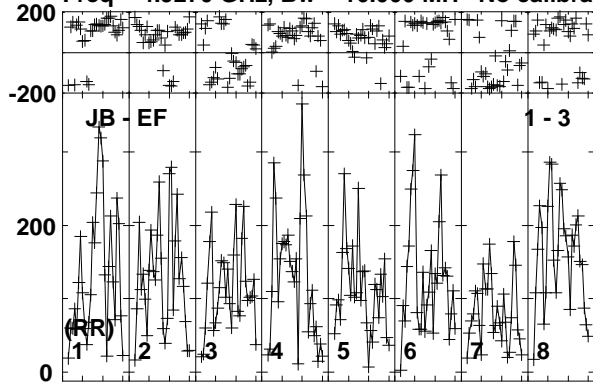

Lower frame: Micro Ampl Jy Top frame: Phas deg  
Vector averaged cross-power spectrum Baseline: JB (01) - EF (03)  
Timerange: 00/12:26:31 to 00/12:29:29

Plot file version 437 created 19-DEC-2018 17:58:45

AT2018\_RY007C.UVDATA.1

Freq = 4.9270 GHz, Bw = 16.000 MH No calibration applied and no bandpass applied

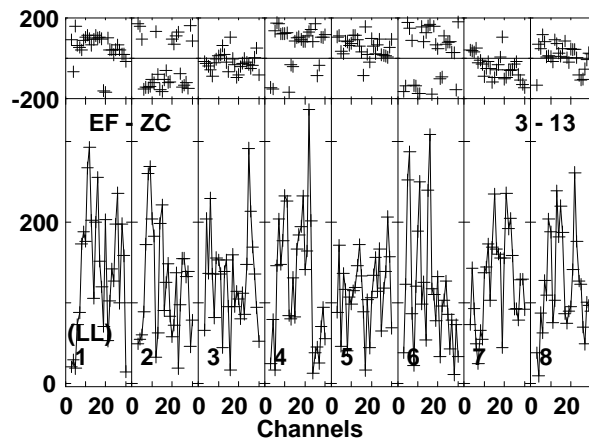
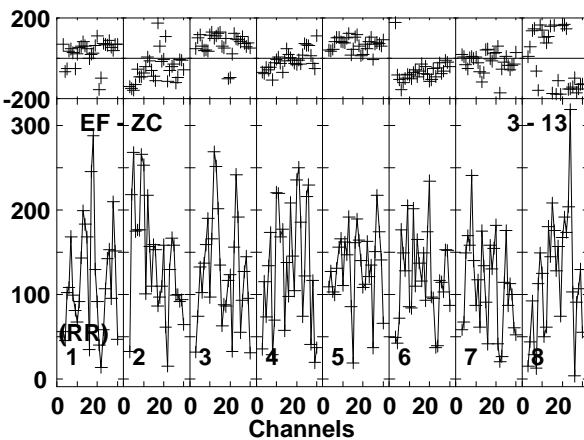
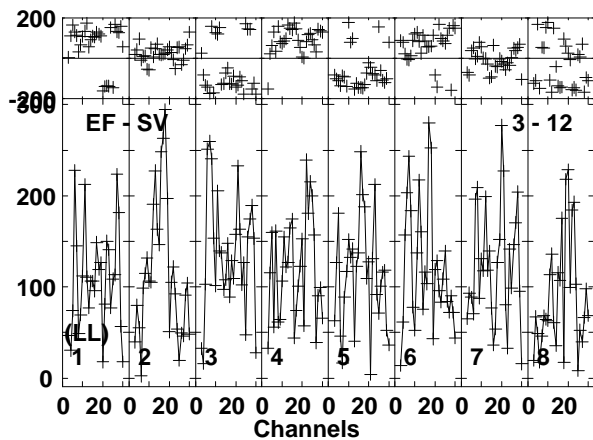
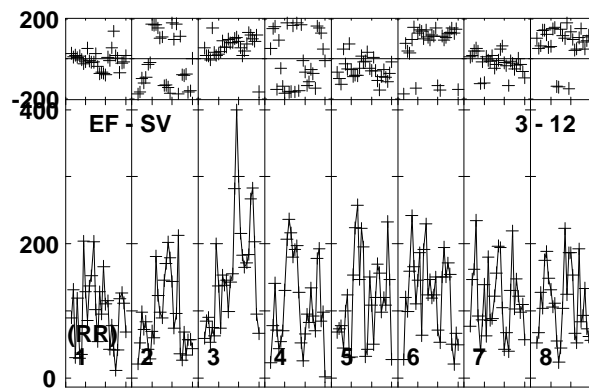
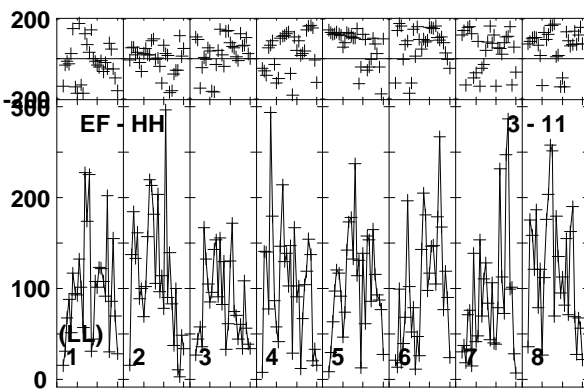
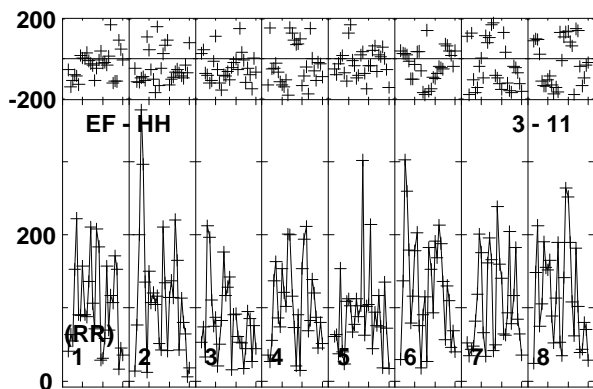
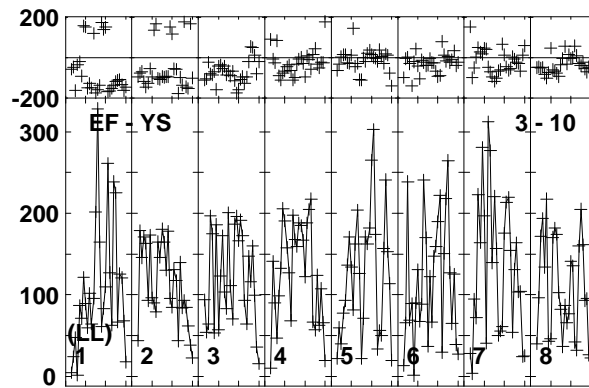
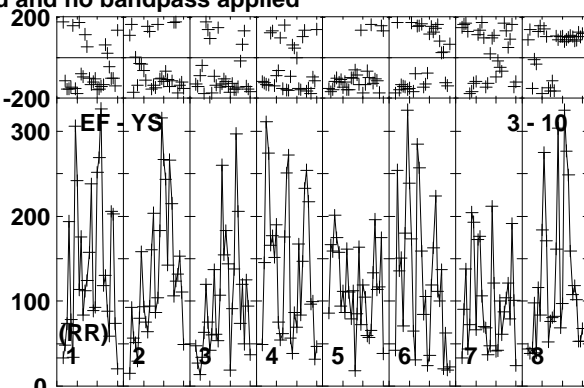
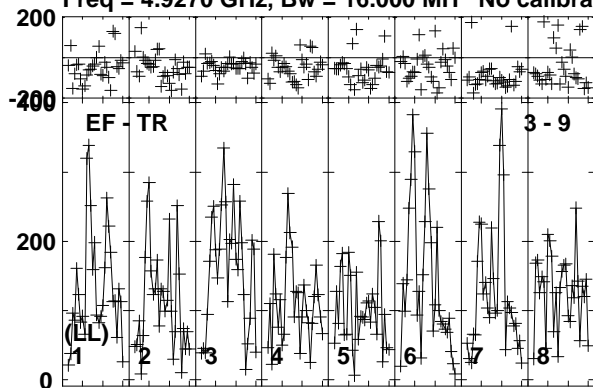

Lower frame: Micro Ampl Jy Top frame: Phas deg  
Vector averaged cross-power spectrum Baseline: EF (03) - TR (09)  
Timerange: 00/12:26:31 to 00/12:29:29

Plot file version 438 created 19-DEC-2018 17:58:45

AT2018\_RY007C.UVDATA.1

Freq = 4.9270 GHz, Bw = 16.000 MH No calibration applied and no bandpass applied

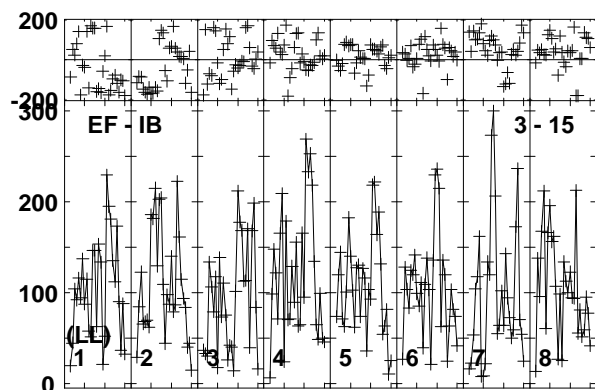
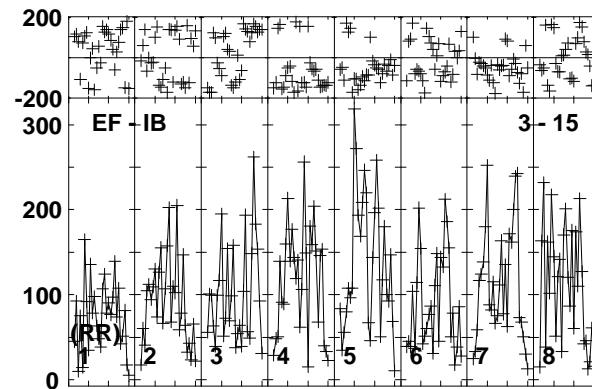
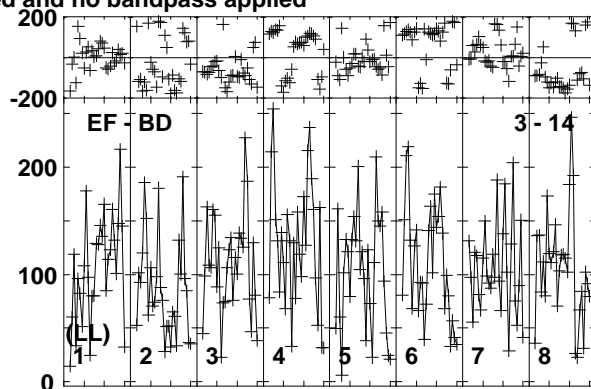
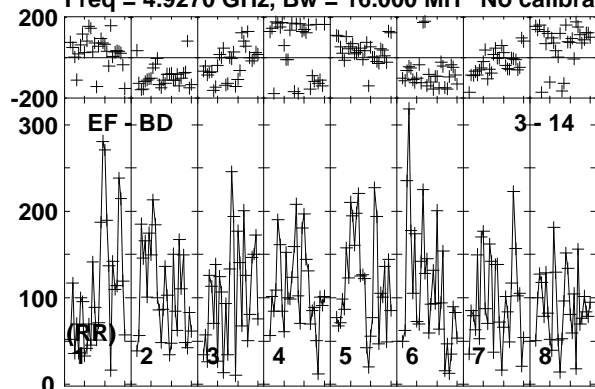

Lower frame: Micro Ampl Jy Top frame: Phas deg  
Vector averaged cross-power spectrum Baseline: EF (03) - BD (14)  
Timerange: 00/12:26:31 to 00/12:29:29

Plot file version 439 created 19-DEC-2018 17:58:45

J1619+2247 RY007C.UVDATA.1

Freq = 4.9270 GHz, Bw = 16.000 MH No calibration applied and no bandpass applied

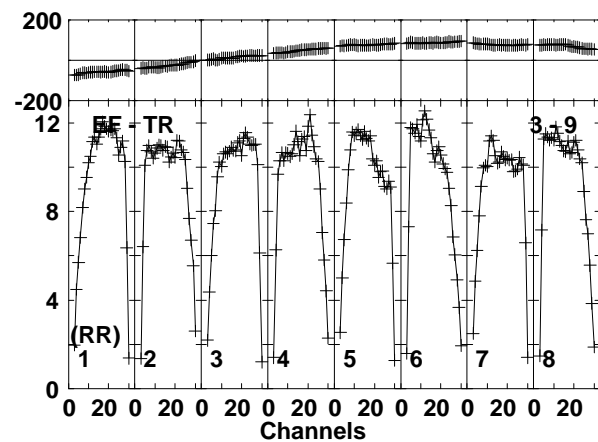
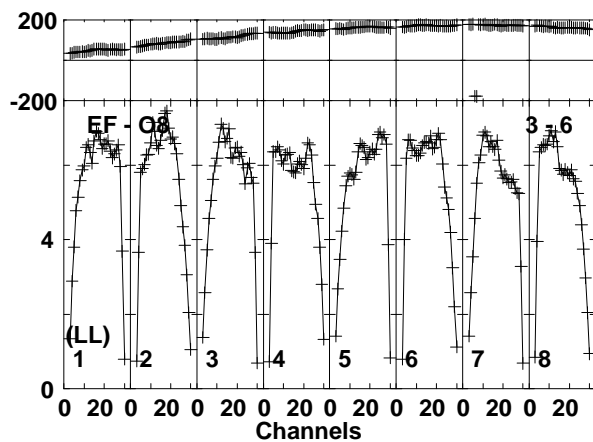
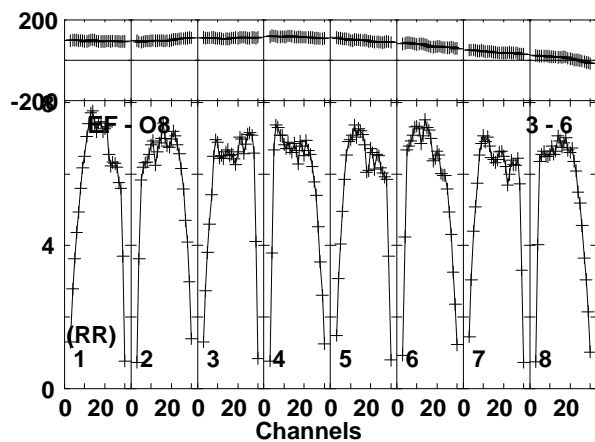
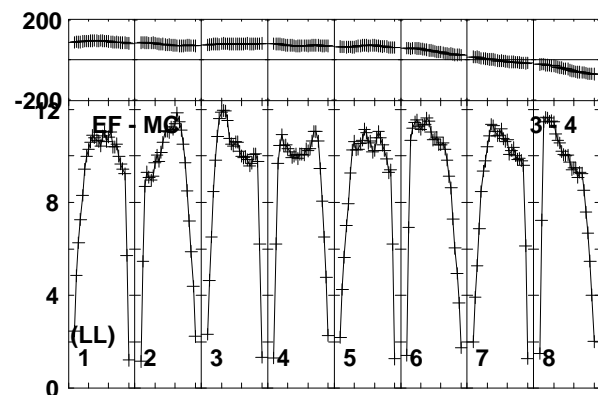
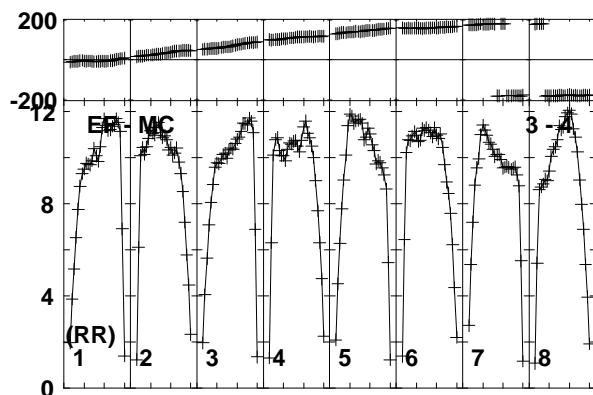
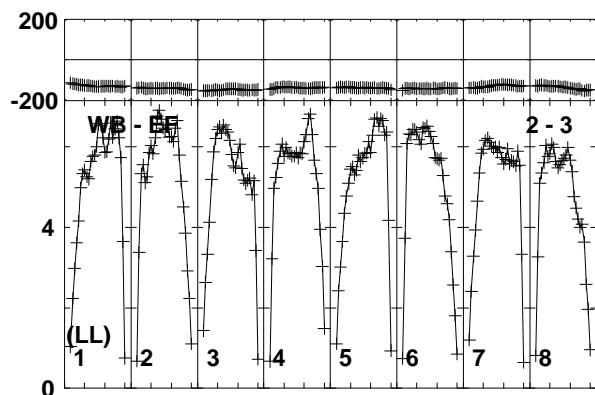
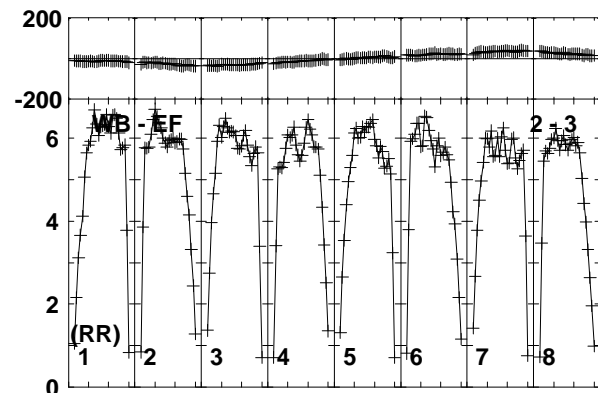
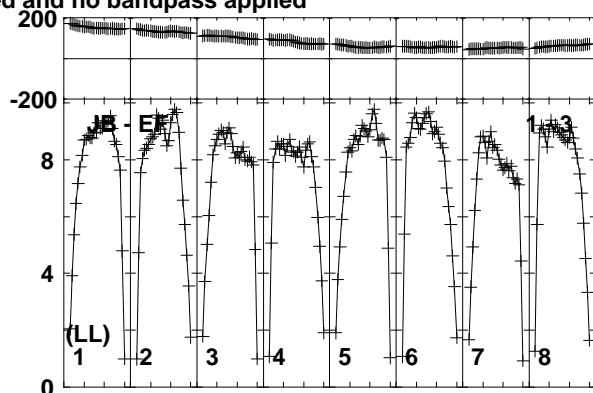
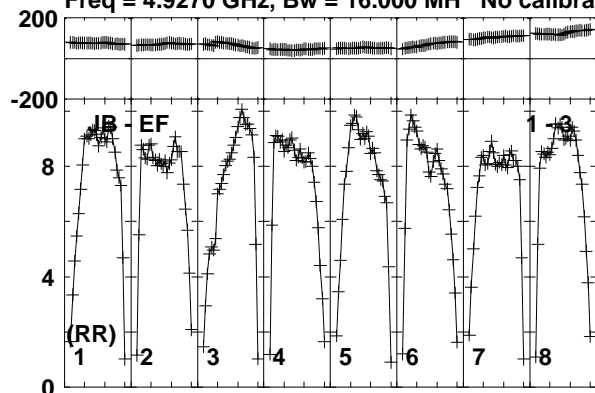

Lower frame: Milli Ampl Jy Top frame: Phas deg  
Vector averaged cross-power spectrum Baseline: JB (01) - EF (03)  
Timerange: 00/12:29:31 to 00/12:30:29

Plot file version 440 created 19-DEC-2018 17:58:45

J1619+2247 RY007C.UVDATA.1

Freq = 4.9270 GHz, Bw = 16.000 MH No calibration applied and no bandpass applied

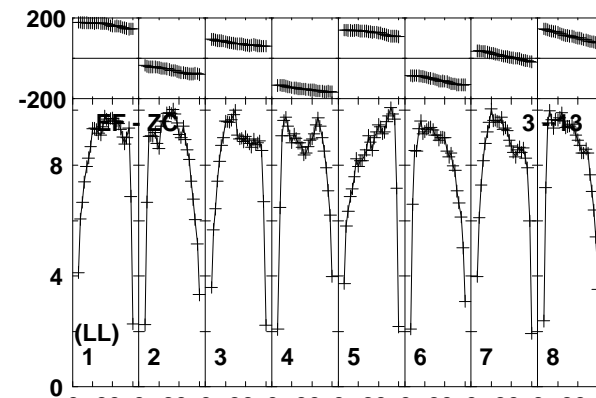
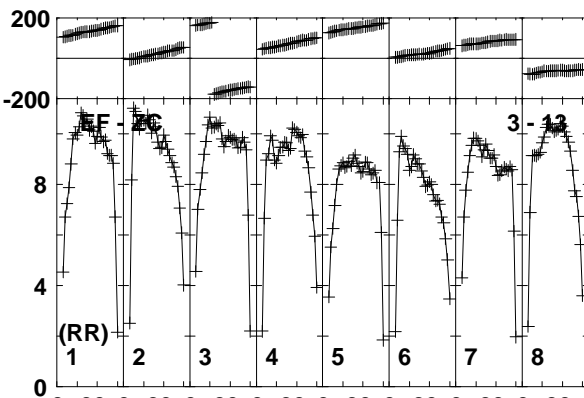
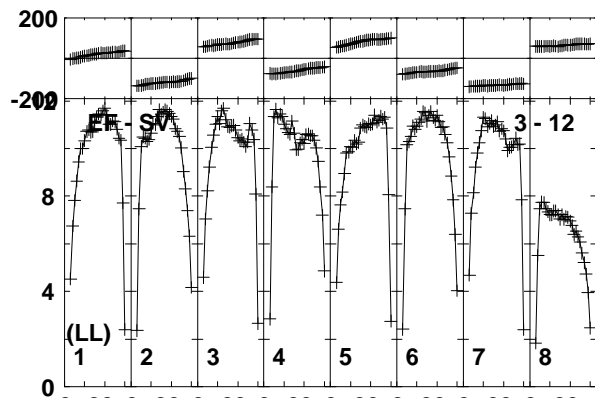
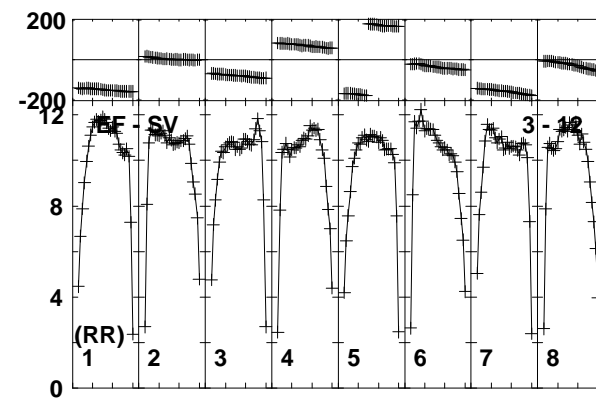
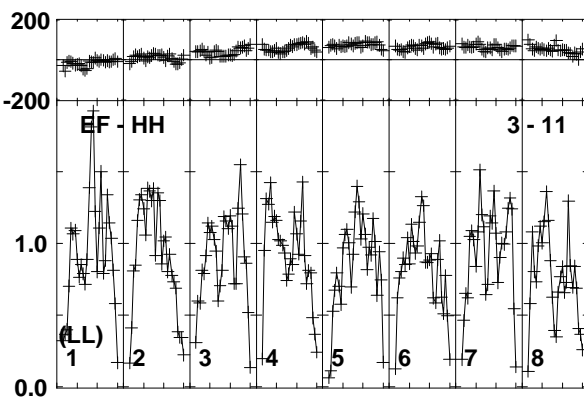
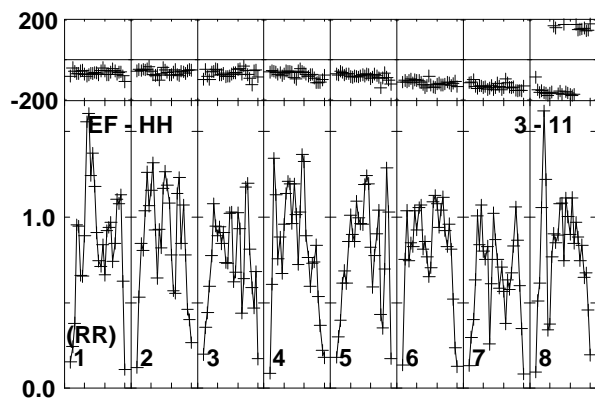
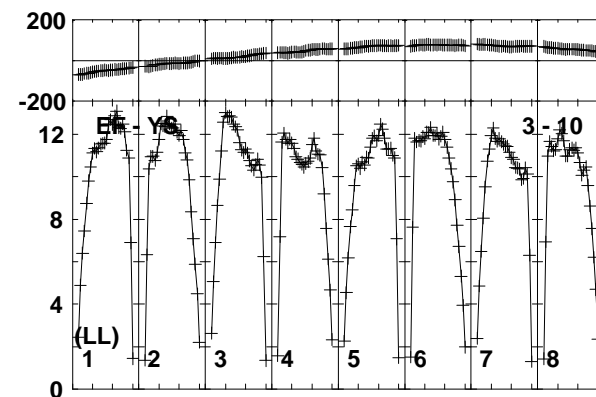
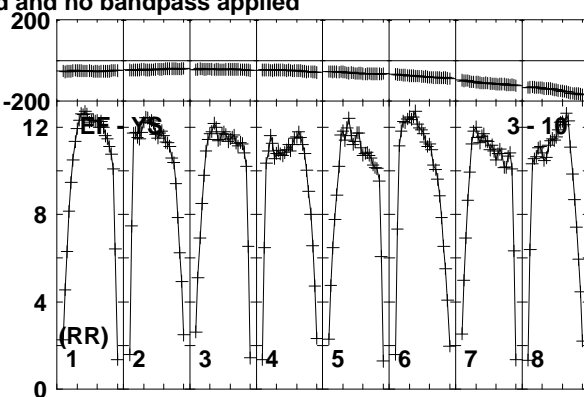
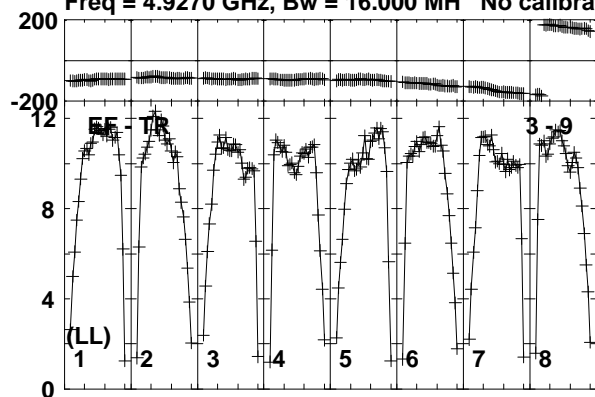

Lower frame: Milli Ampl Jy Top frame: Phas deg  
Vector averaged cross-power spectrum Baseline: EF (03) - TR (09)  
Timerange: 00/12:29:31 to 00/12:30:29

Plot file version 441 created 19-DEC-2018 17:58:45

J1619+2247 RY007C.UVDATA.1

Freq = 4.9270 GHz, Bw = 16.000 MH No calibration applied and no bandpass applied

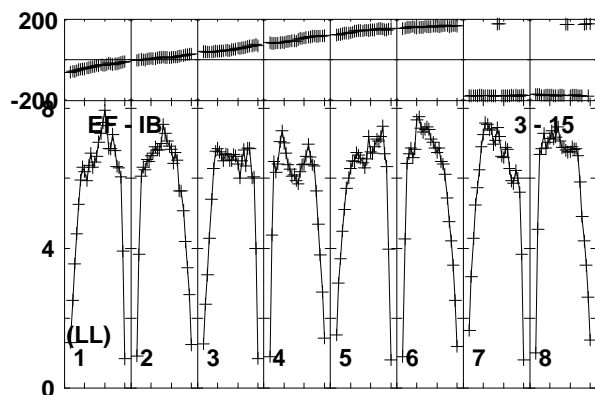
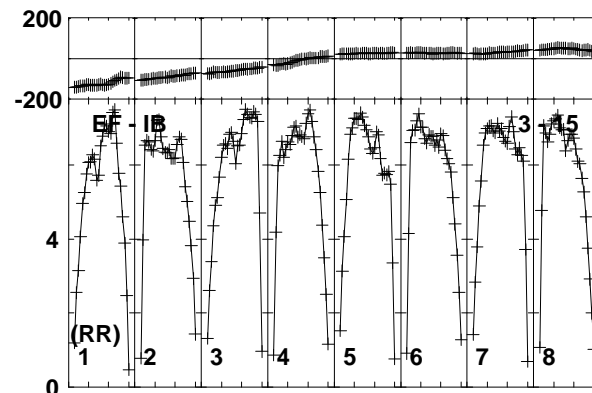
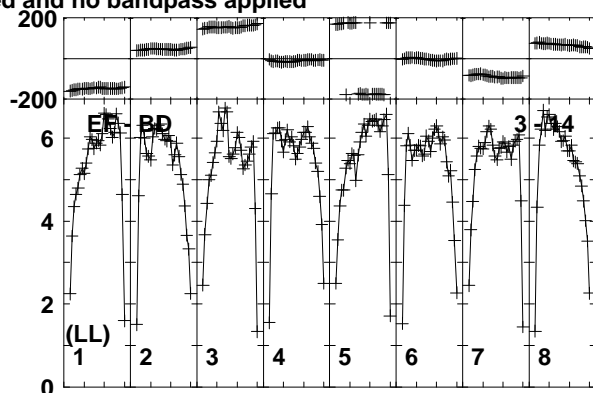
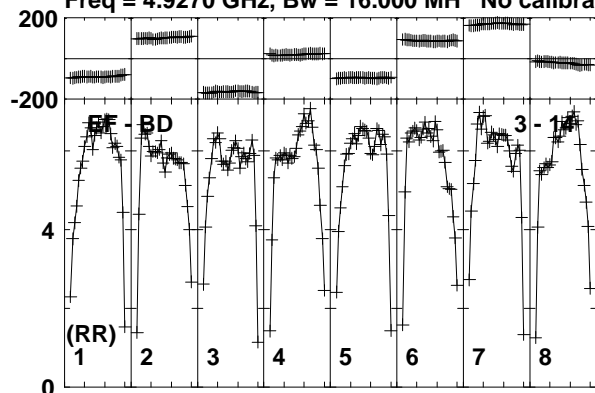

Lower frame: Milli Ampl Jy Top frame: Phas deg  
Vector averaged cross-power spectrum Baseline: EF (03) - BD (14)  
Timerange: 00/12:29:31 to 00/12:30:29

Plot file version 442 created 19-DEC-2018 17:58:45

AT2018\_RY007C.UVDATA.1

Freq = 4.9270 GHz, Bw = 16.000 MH No calibration applied and no bandpass applied

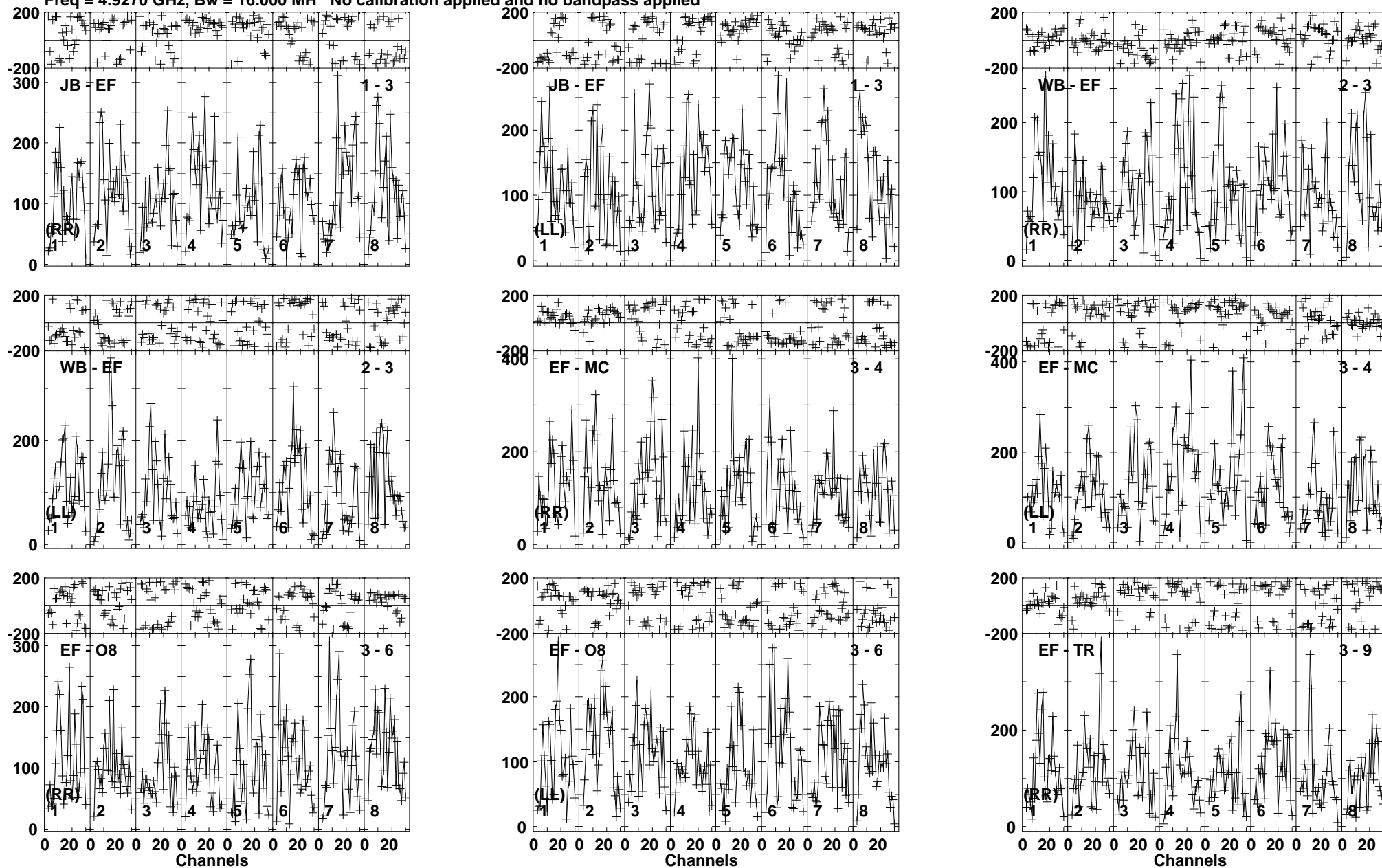

Lower frame: Micro Ampl Jy Top frame: Phas deg  
Vector averaged cross-power spectrum Baseline: JB (01) - EF (03)  
Timerange: 00/12:30:31 to 00/12:33:29



Plot file version 443 created 19-DEC-2018 17:58:46

AT2018\_RY007C.UVDATA.1

Freq = 4.9270 GHz, Bw = 16.000 MH No calibration applied and no bandpass applied

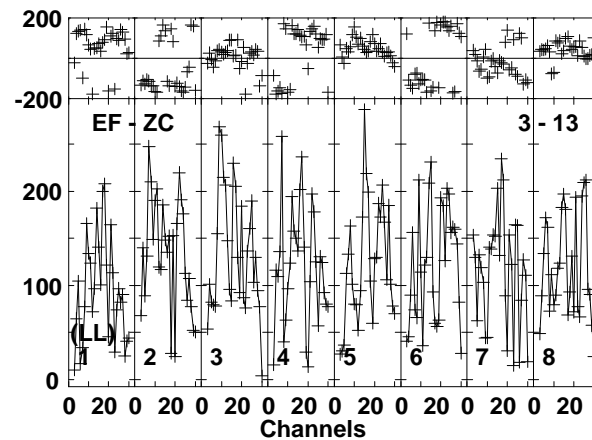
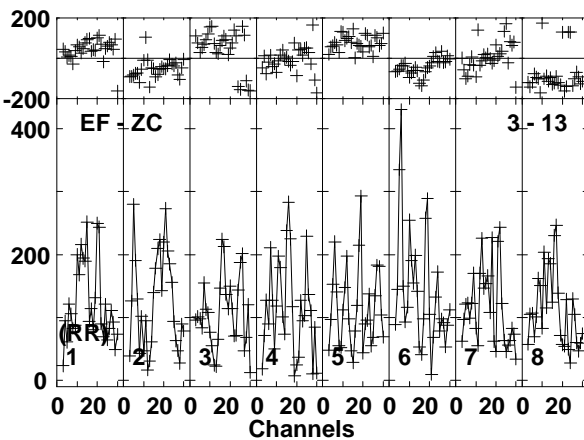
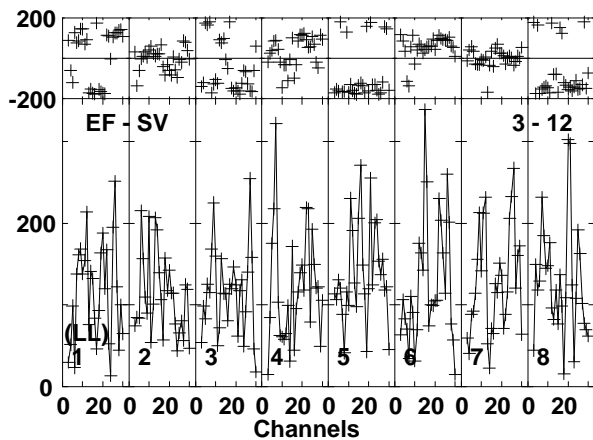
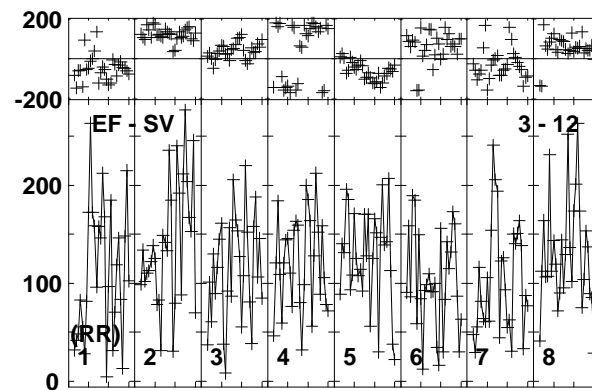
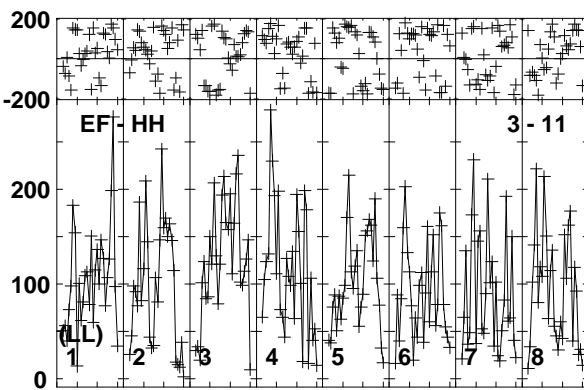
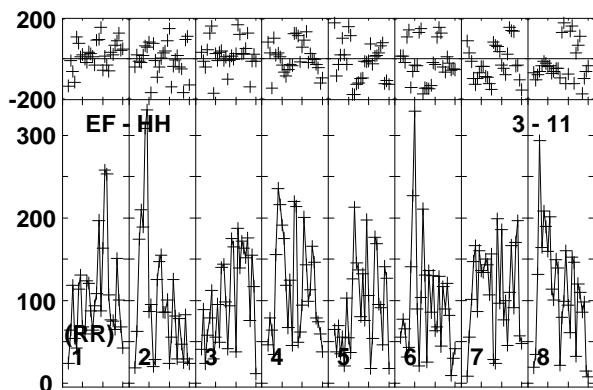
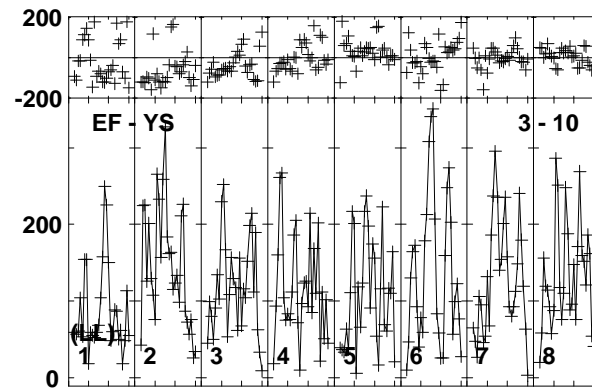
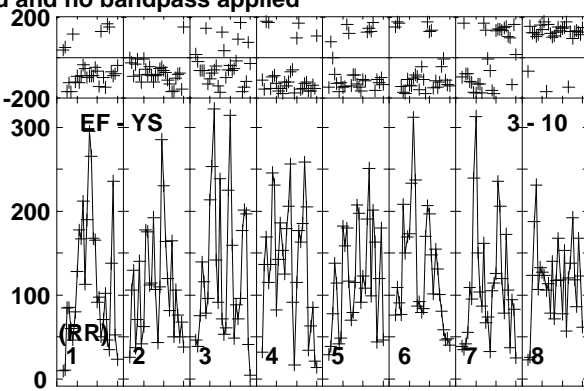
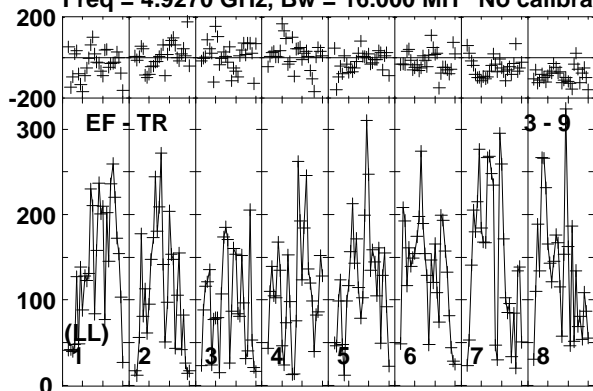

Lower frame: Micro Ampl Jy Top frame: Phas deg  
Vector averaged cross-power spectrum Baseline: EF (03) - TR (09)  
Timerange: 00/12:30:31 to 00/12:33:29

Plot file version 444 created 19-DEC-2018 17:58:46

AT2018\_RY007C.UVDATA.1

Freq = 4.9270 GHz, Bw = 16.000 MH No calibration applied and no bandpass applied

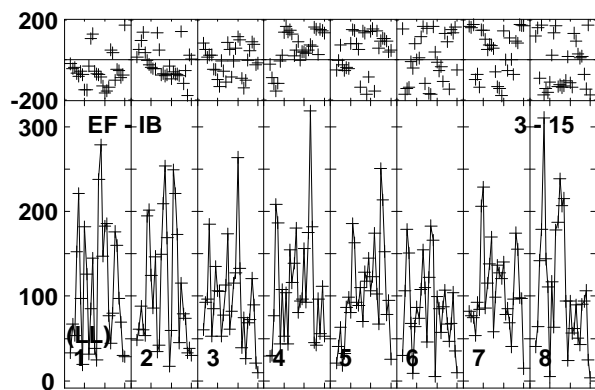
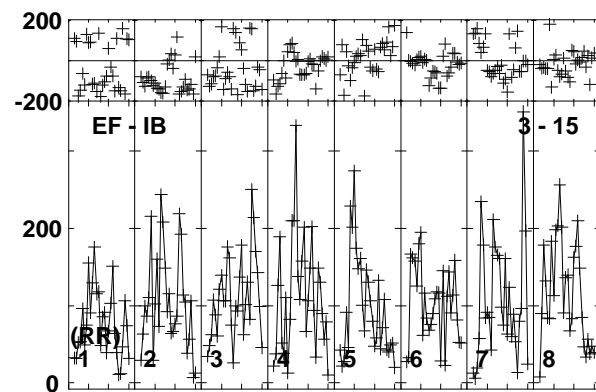
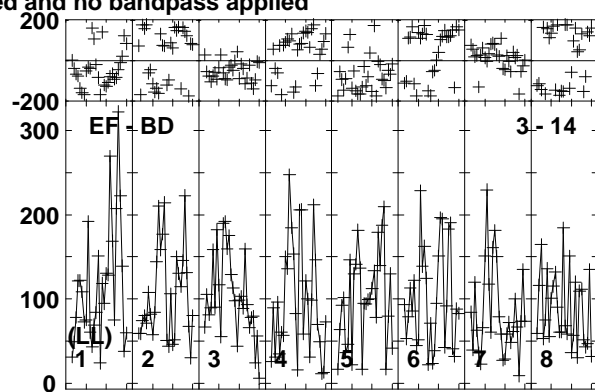
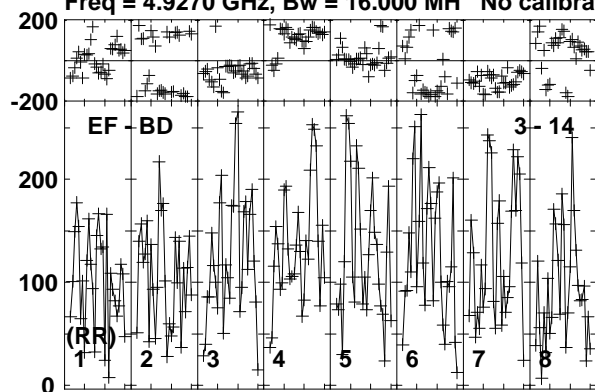

Lower frame: Micro Ampl Jy Top frame: Phas deg  
Vector averaged cross-power spectrum Baseline: EF (03) - BD (14)  
Timerange: 00/12:30:31 to 00/12:33:29

Plot file version 445 created 19-DEC-2018 17:58:46

J1619+2247 RY007C.UVDATA.1

Freq = 4.9270 GHz, Bw = 16.000 MH No calibration applied and no bandpass applied

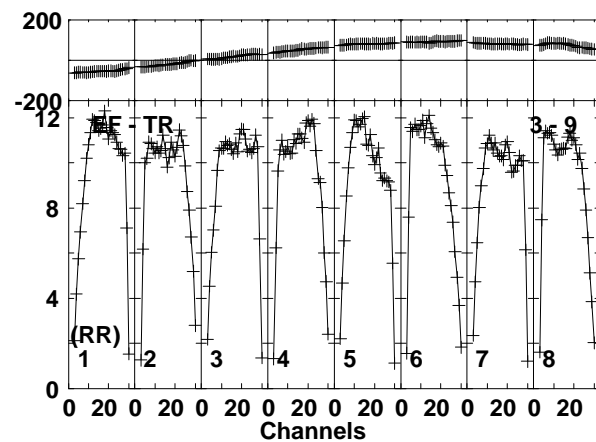
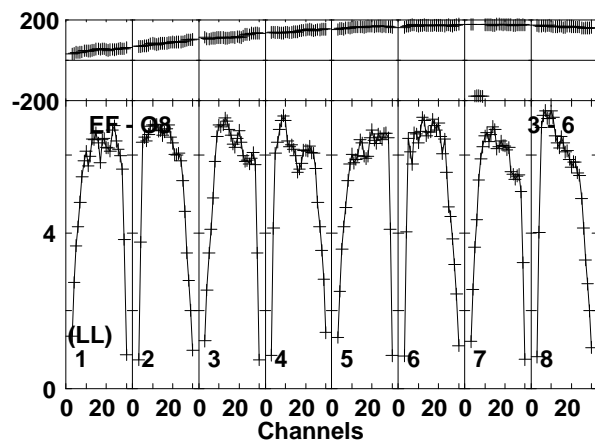
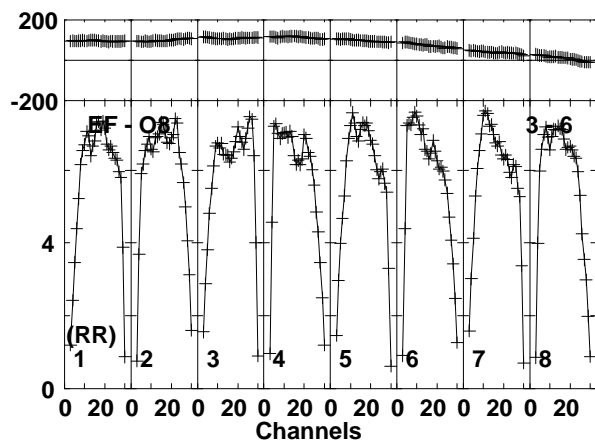
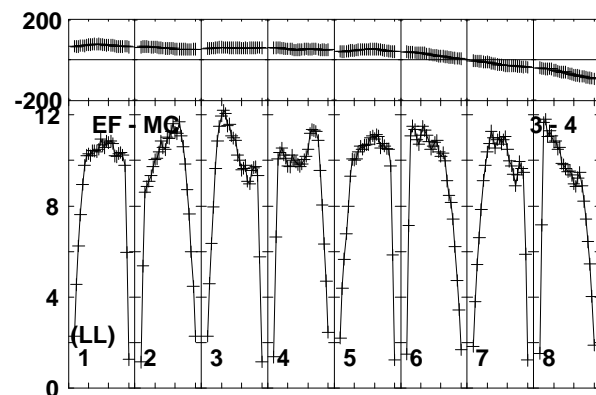
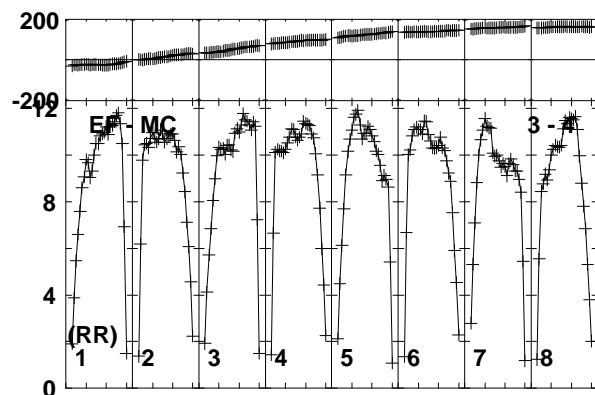
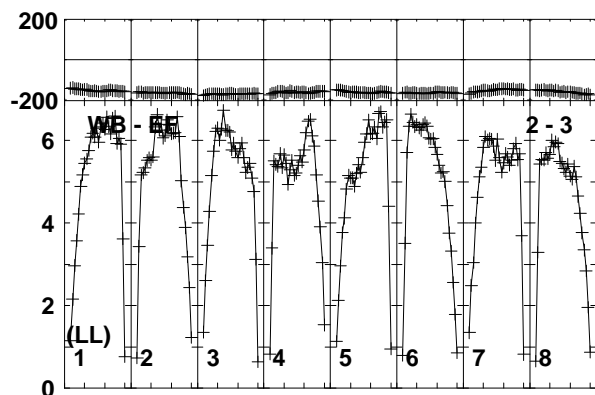
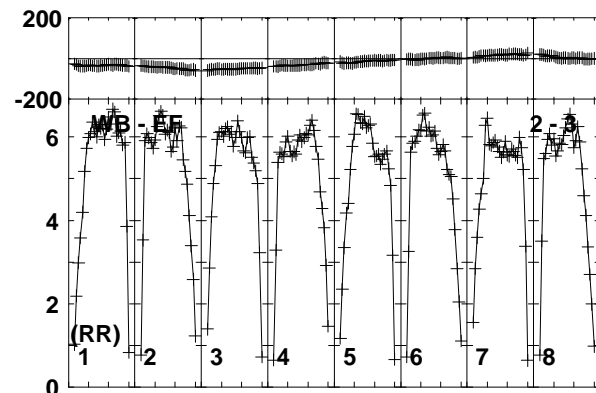
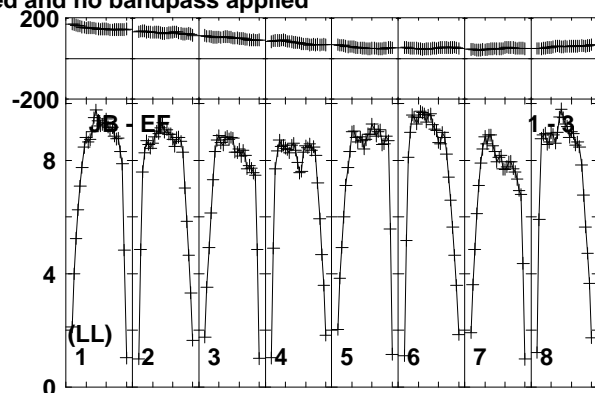
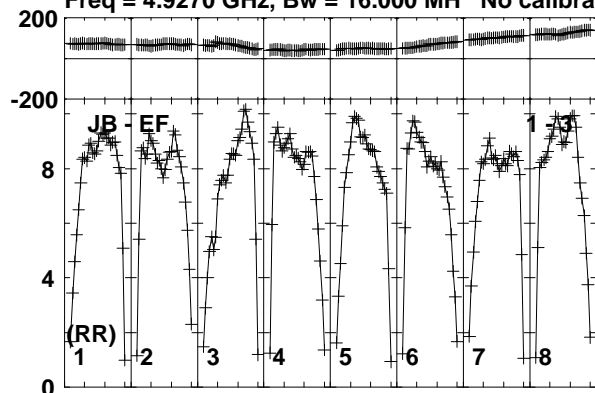

Lower frame: Milli Ampl Jy Top frame: Phas deg  
Vector averaged cross-power spectrum Baseline: JB (01) - EF (03)  
Timerange: 00:12:33:31 to 00:12:34:29

Plot file version 446 created 19-DEC-2018 17:58:46

J1619+2247 RY007C.UVDATA.1

Freq = 4.9270 GHz, Bw = 16.000 MH No calibration applied and no bandpass applied

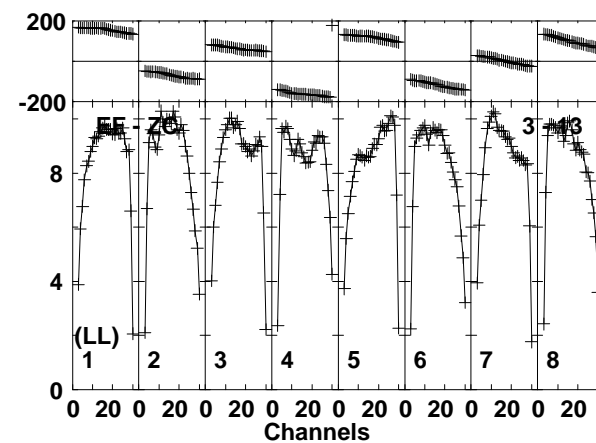
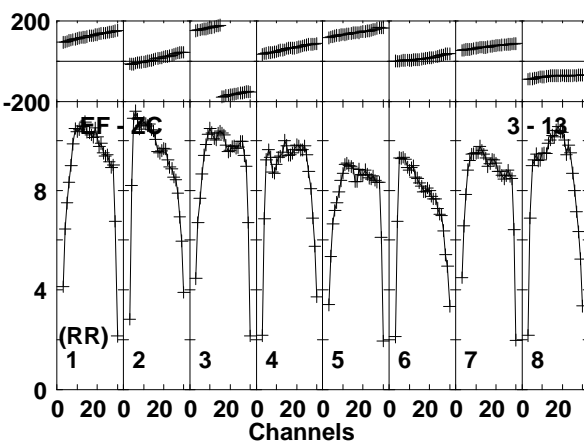
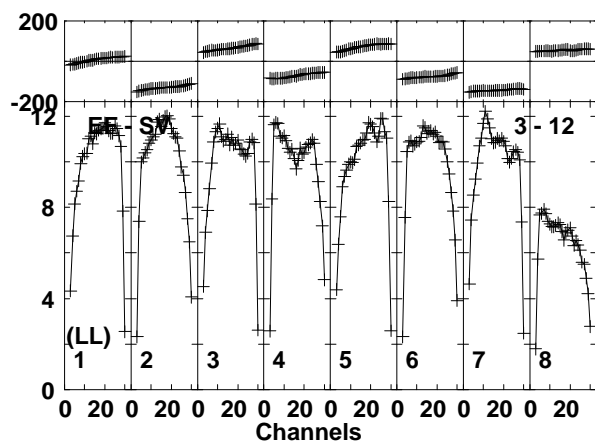
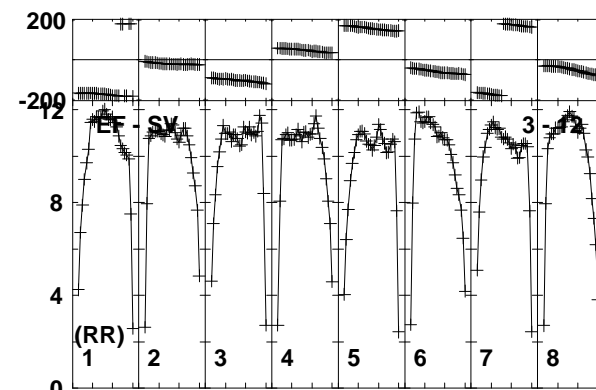
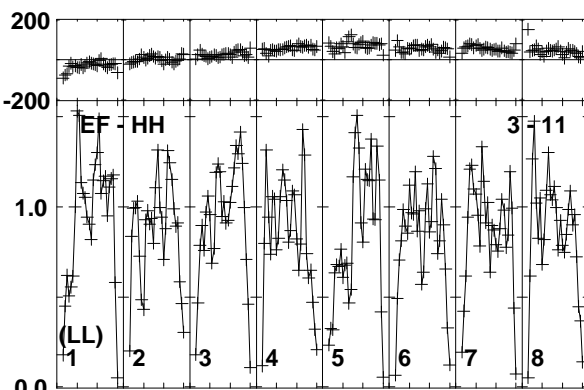
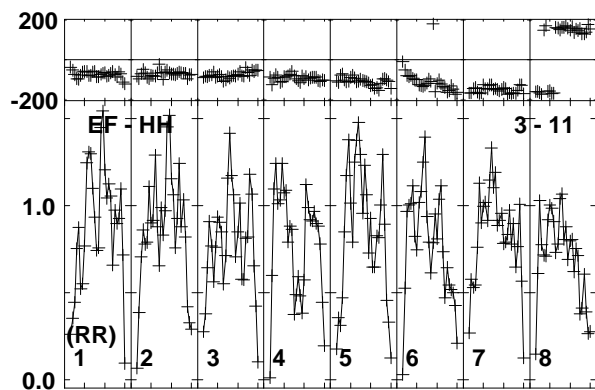
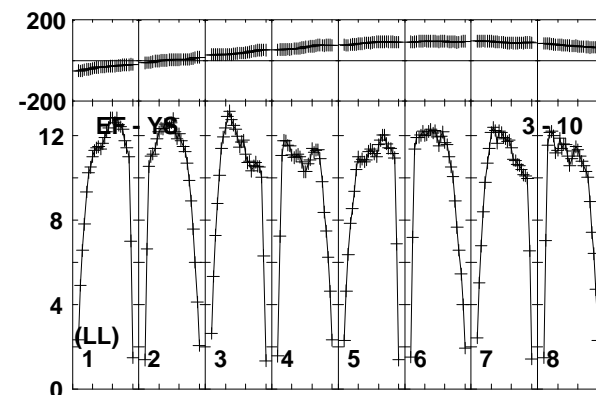
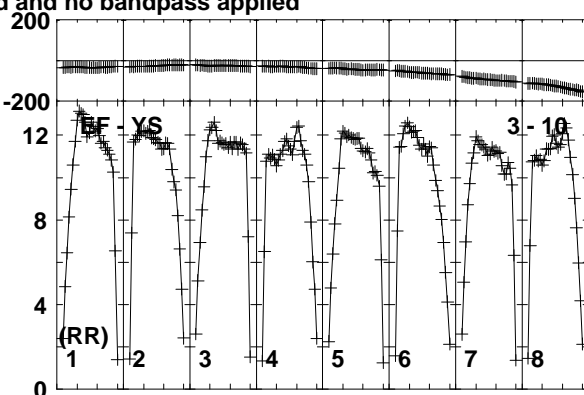
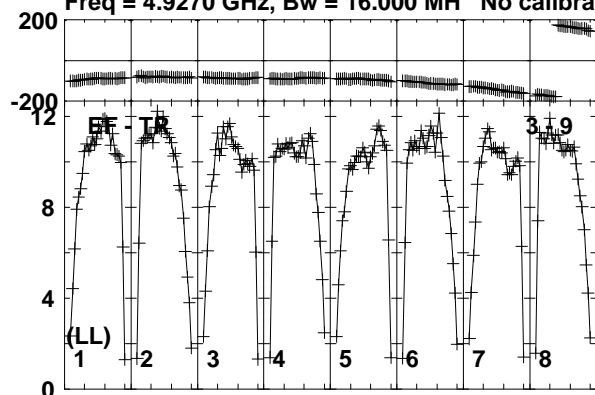

Lower frame: Milli Ampl Jy Top frame: Phas deg  
Vector averaged cross-power spectrum Baseline: EF (03) - TR (09)  
Timerange: 00:12:33:31 to 00:12:34:29

Plot file version 447 created 19-DEC-2018 17:58:46

J1619+2247 RY007C.UVDATA.1

Freq = 4.9270 GHz, Bw = 16.000 MH No calibration applied and no bandpass applied

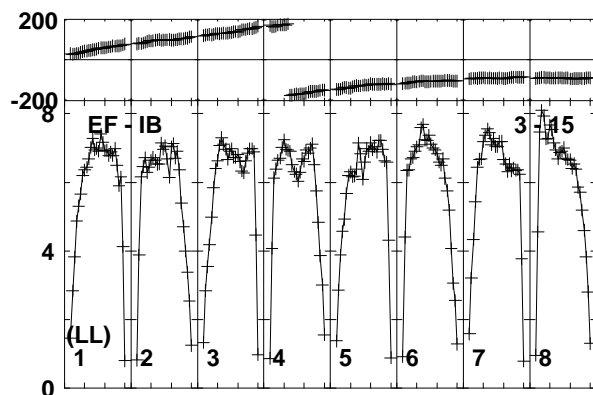
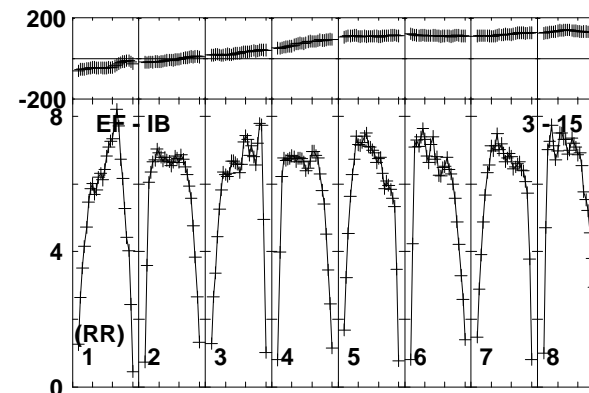
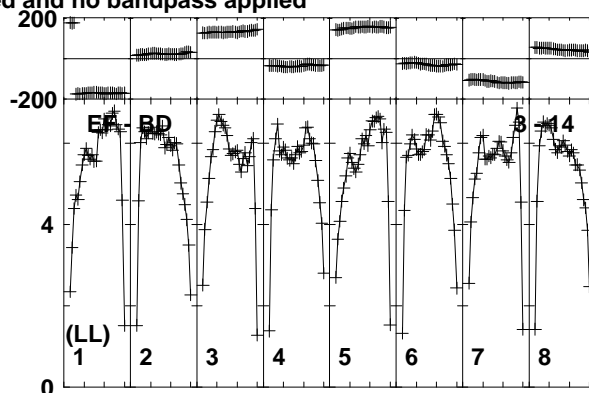
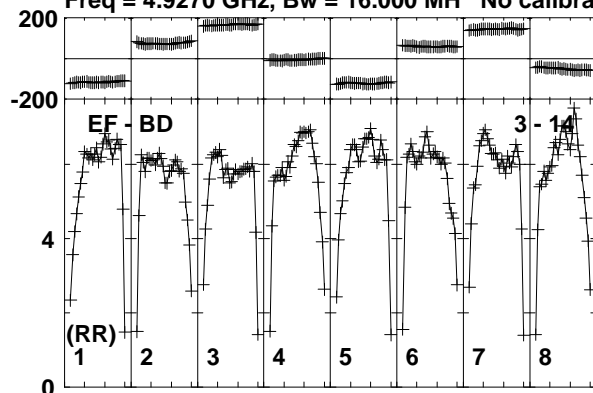

Lower frame: Milli Ampl Jy Top frame: Phas deg  
Vector averaged cross-power spectrum Baseline: EF (03) - BD (14)  
Timerange: 00/12:33:31 to 00/12:34:29

Plot file version 448 created 19-DEC-2018 17:58:46

VLA1 RY007C.UVDATA.1

Freq = 4.9270 GHz, Bw = 16.000 MH No calibration applied and no bandpass applied

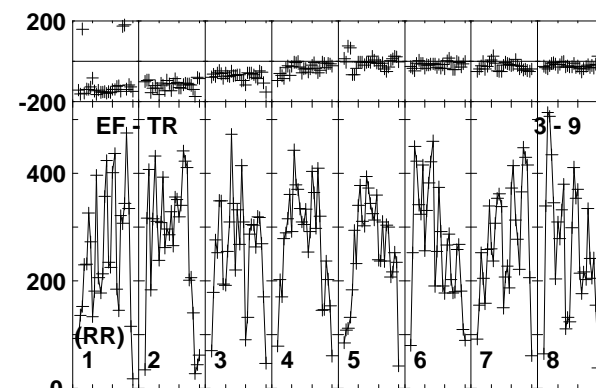
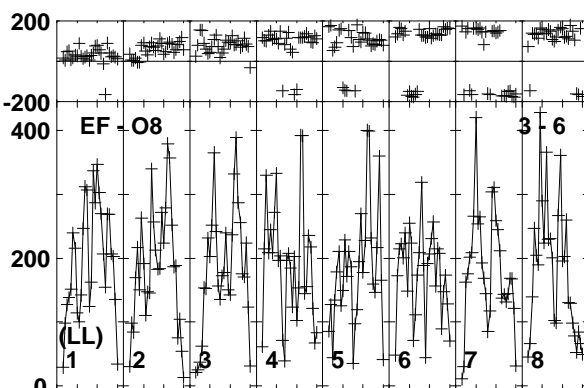
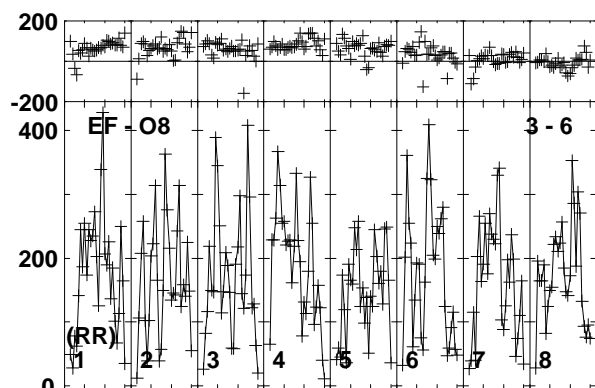
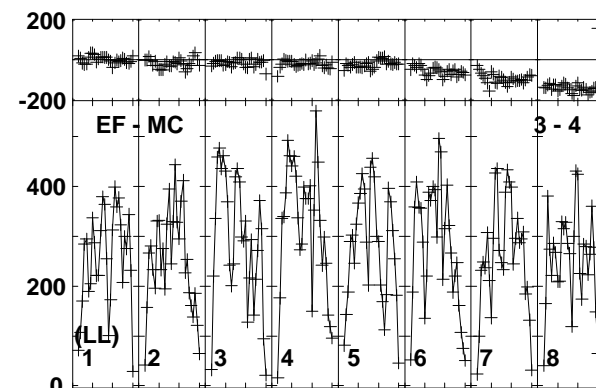
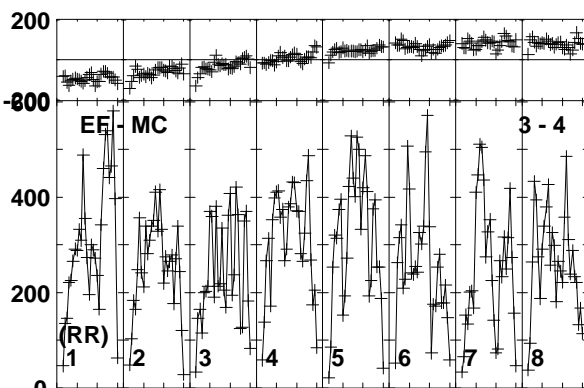
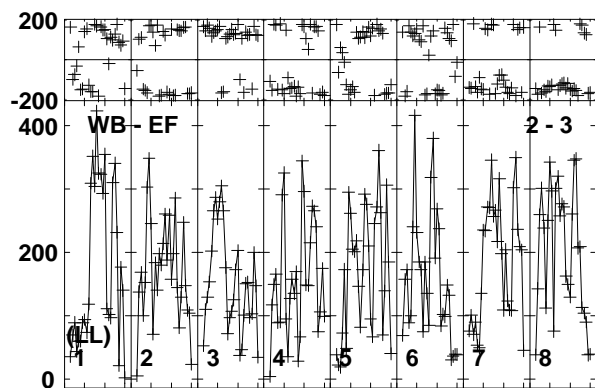
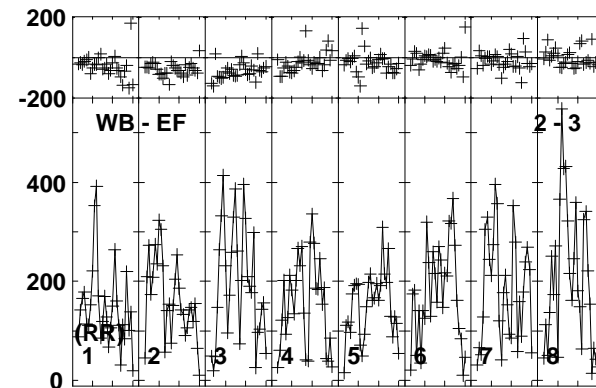
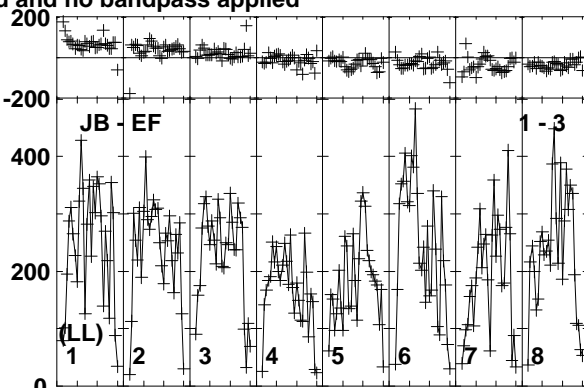
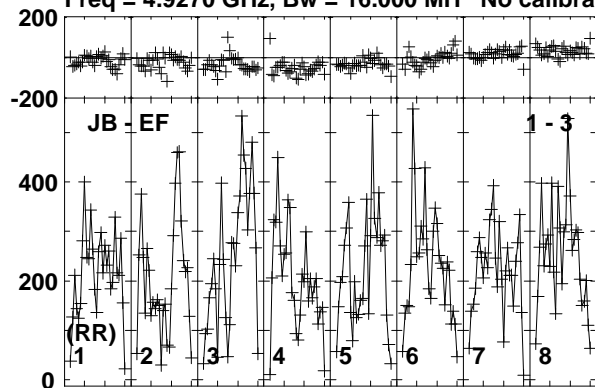

Lower frame: Micro Ampl Jy Top frame: Phas deg  
Vector averaged cross-power spectrum Baseline: JB (01) - EF (03)  
Timerange: 00/12:35:01 to 00/12:36:59

Plot file version 449 created 19-DEC-2018 17:58:46

VLA1 RY007C.UVDATA.1

Freq = 4.9270 GHz, Bw = 16.000 MH No calibration applied and no bandpass applied

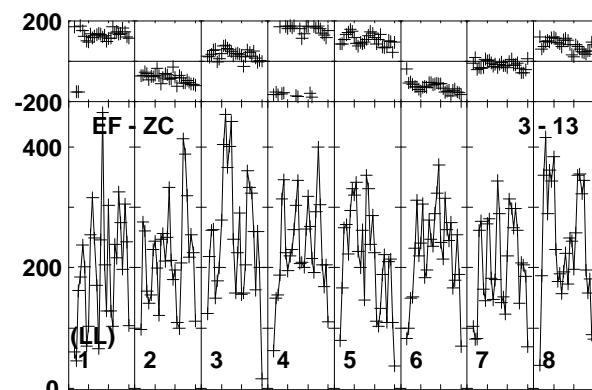
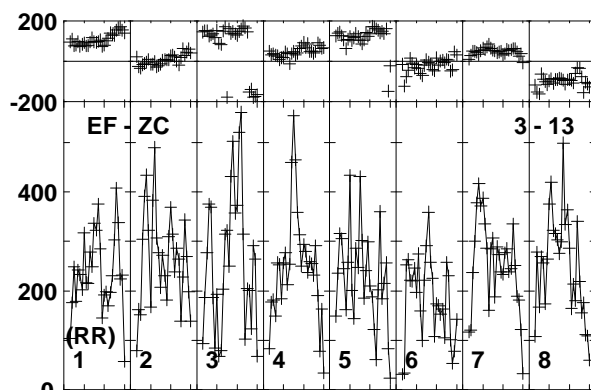
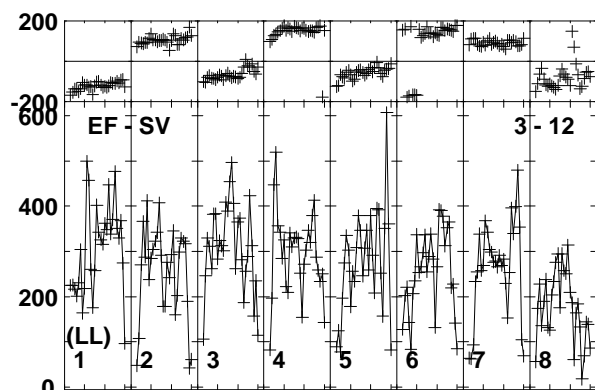
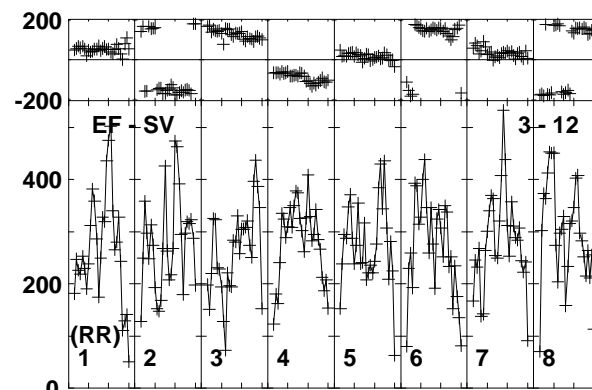
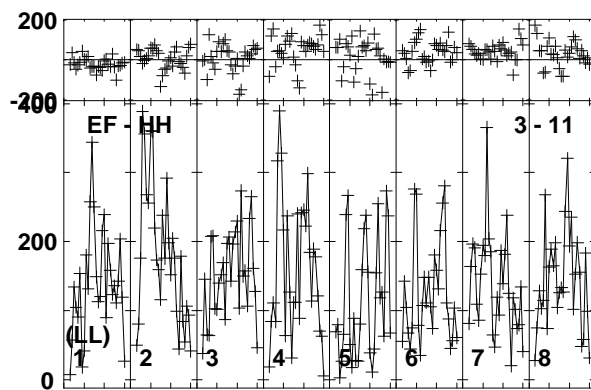
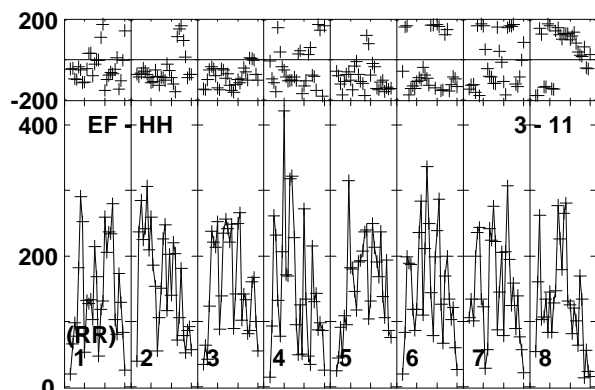
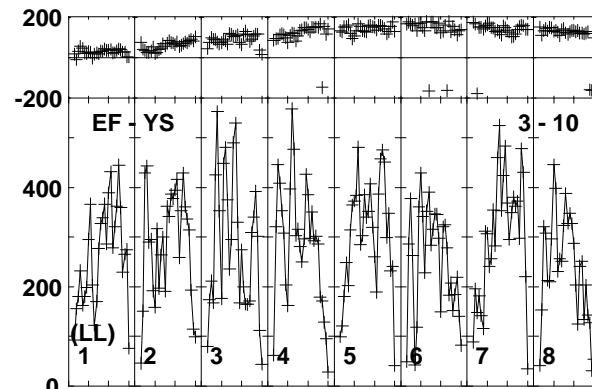
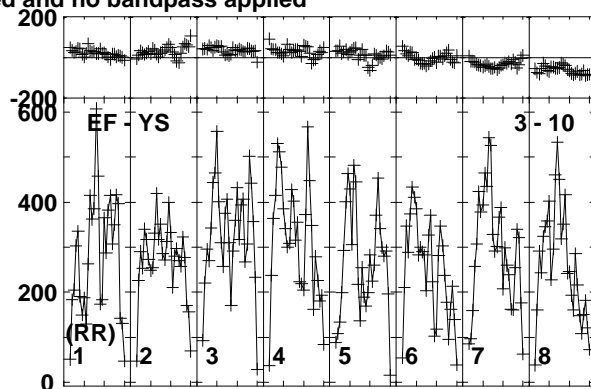
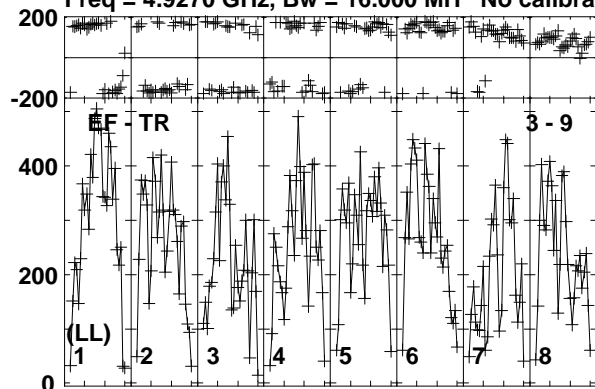

Lower frame: Micro Ampl Jy Top frame: Phas deg  
Vector averaged cross-power spectrum Baseline: EF (03) - TR (09)  
Timerange: 00:12:35:01 to 00:12:36:59

Plot file version 450 created 19-DEC-2018 17:58:46

VLA1 RY007C.UVDATA.1

Freq = 4.9270 GHz, Bw = 16.000 MH No calibration applied and no bandpass applied

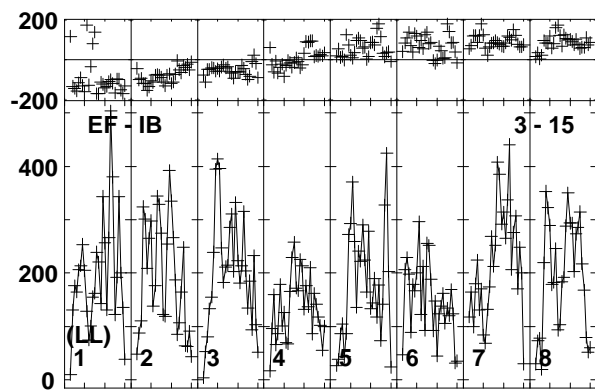
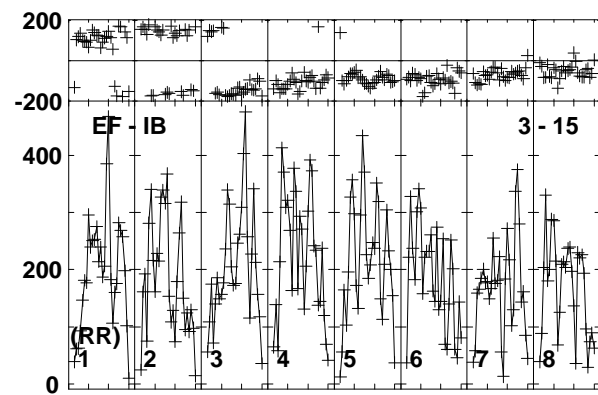
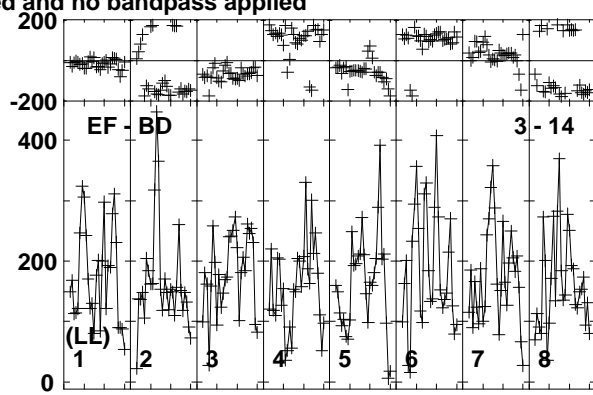
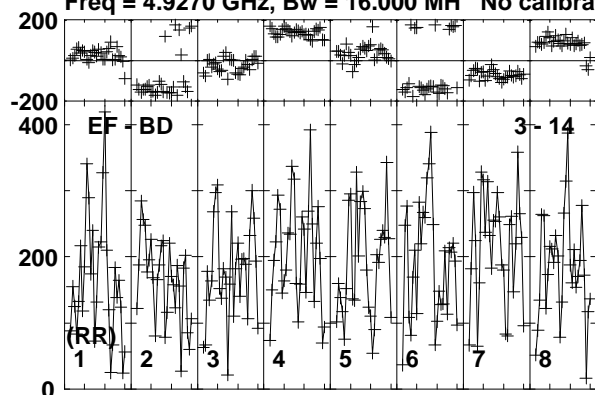

Lower frame: Micro Ampl Jy Top frame: Phas deg  
Vector averaged cross-power spectrum Baseline: EF (03) - BD (14)  
Timerange: 00/12:35:01 to 00/12:36:59



Plot file version 451 created 19-DEC-2018 17:58:46

J1619+2247 RY007C.UVDATA.1

Freq = 4.9270 GHz, Bw = 16.000 MH No calibration applied and no bandpass applied

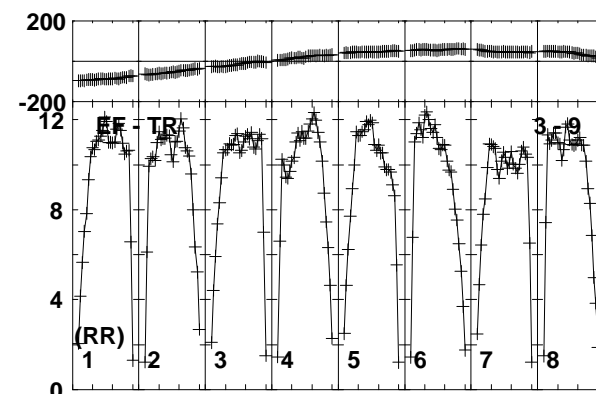
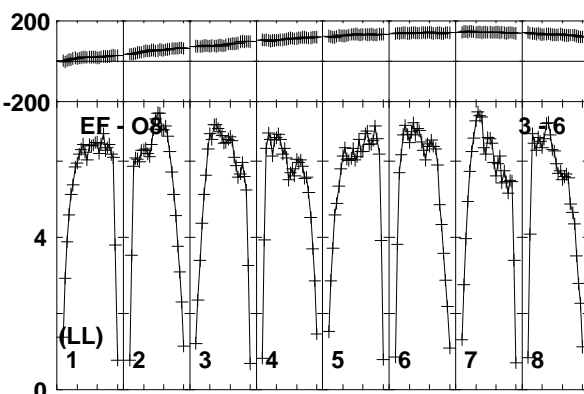
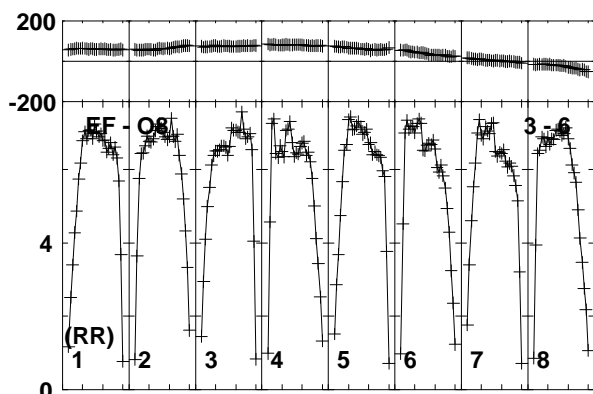
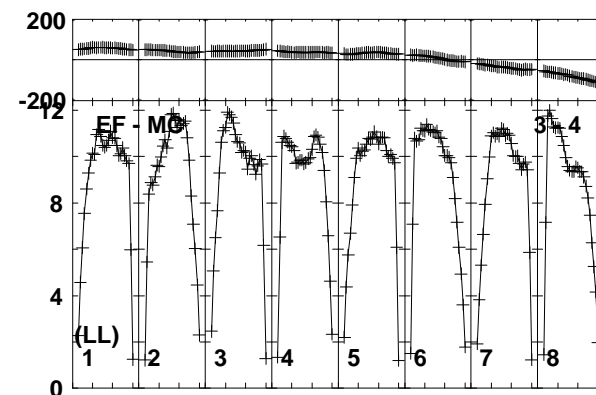
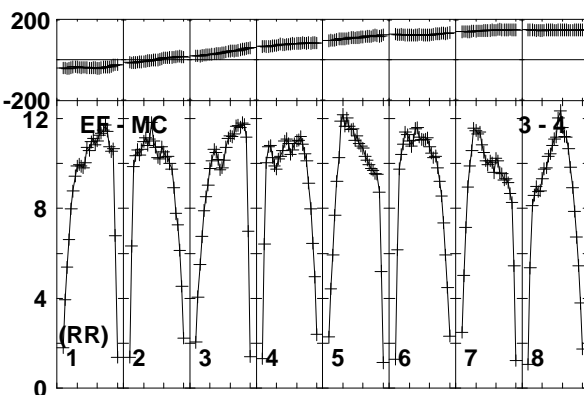
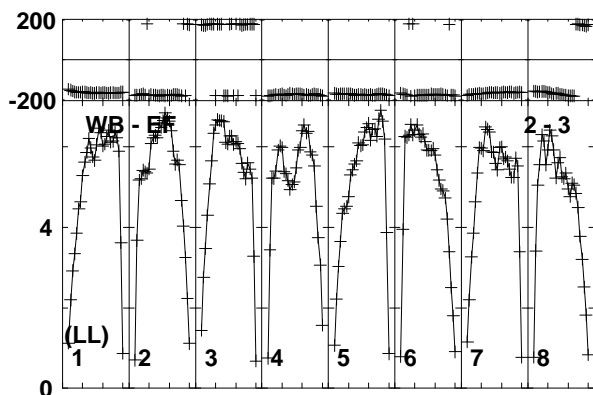
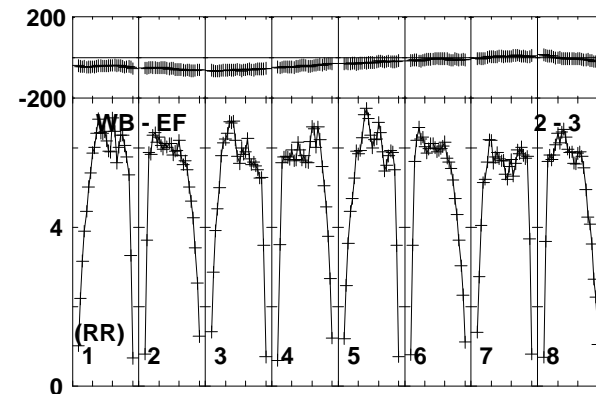
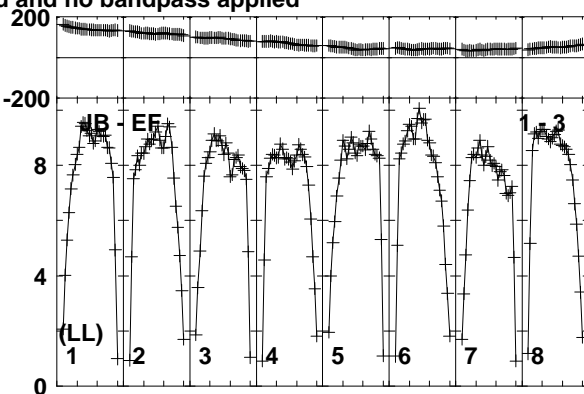
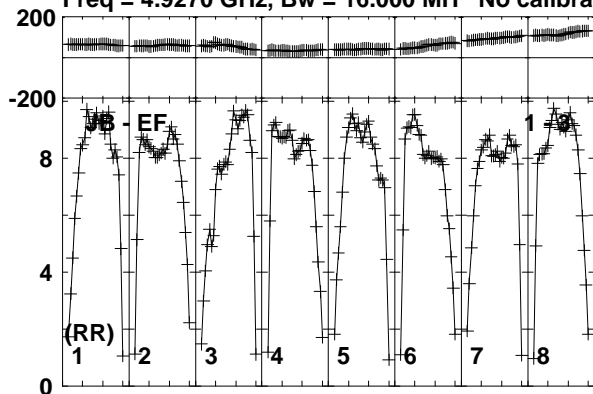

Lower frame: Milli Ampl Jy Top frame: Phas deg  
Vector averaged cross-power spectrum Baseline: JB (01) - EF (03)  
Timerange: 00:12:37:01 to 00:12:37:59

Plot file version 452 created 19-DEC-2018 17:58:46

J1619+2247 RY007C.UVDATA.1

Freq = 4.9270 GHz, Bw = 16.000 MH No calibration applied and no bandpass applied

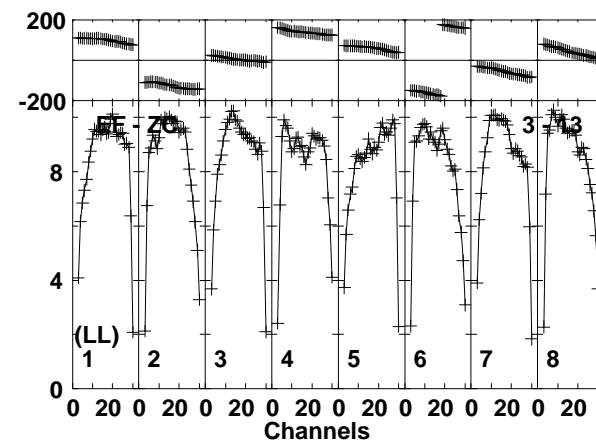
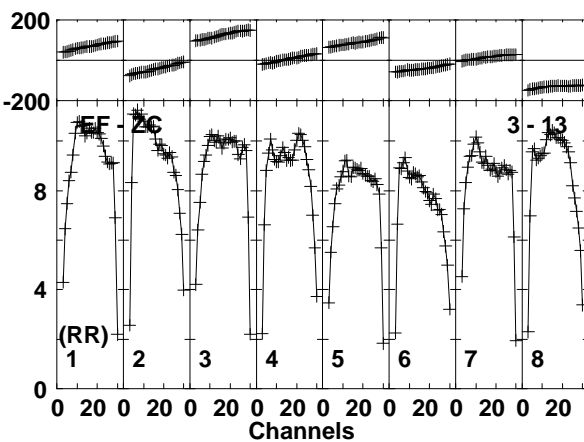
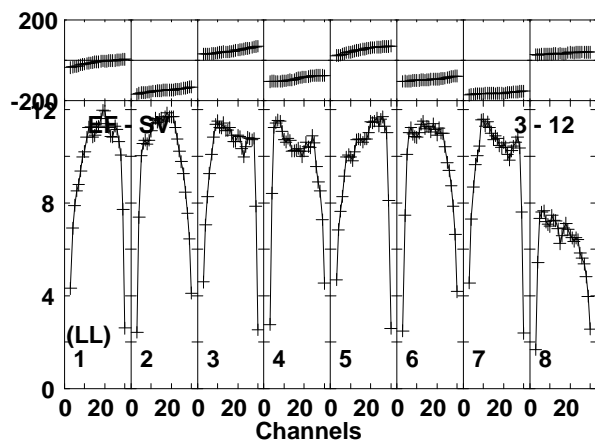
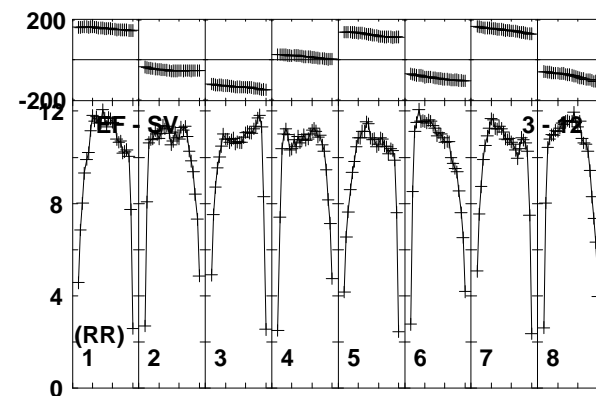
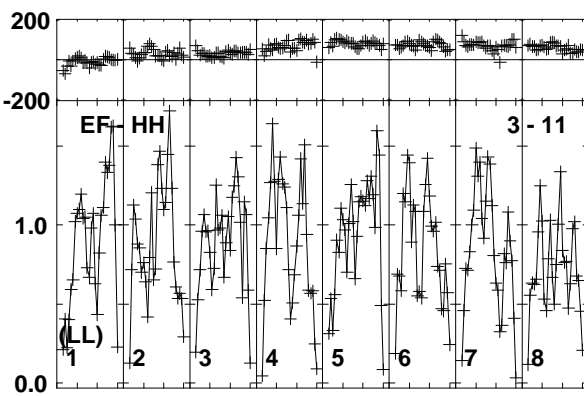
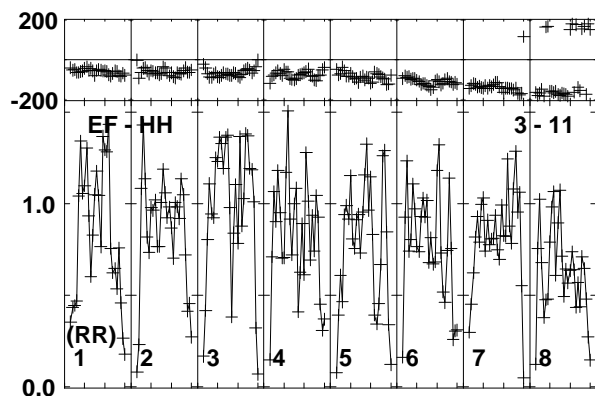
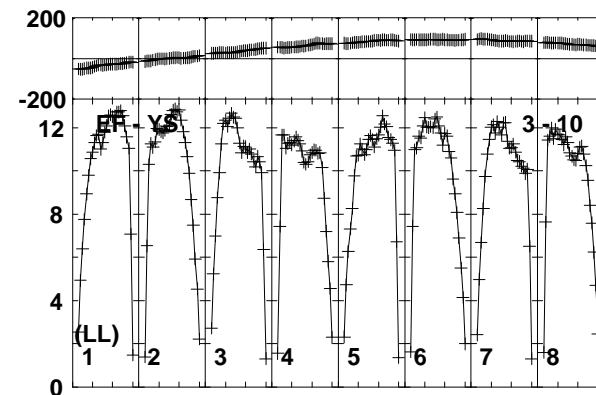
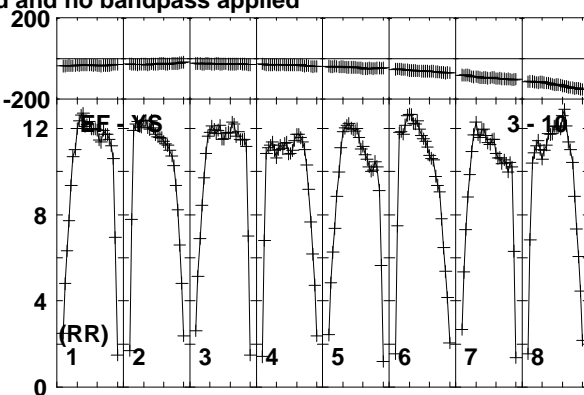
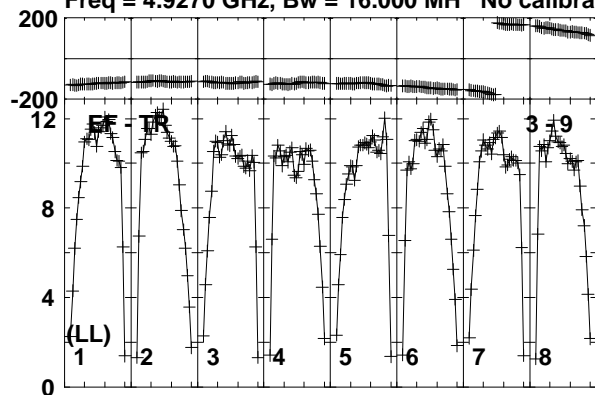

Lower frame: Milli Ampl Jy Top frame: Phas deg  
Vector averaged cross-power spectrum Baseline: EF (03) - TR (09)  
Timerange: 00:12:37:01 to 00:12:37:59

Plot file version 453 created 19-DEC-2018 17:58:46

J1619+2247 RY007C.UVDATA.1

Freq = 4.9270 GHz, Bw = 16.000 MH No calibration applied and no bandpass applied

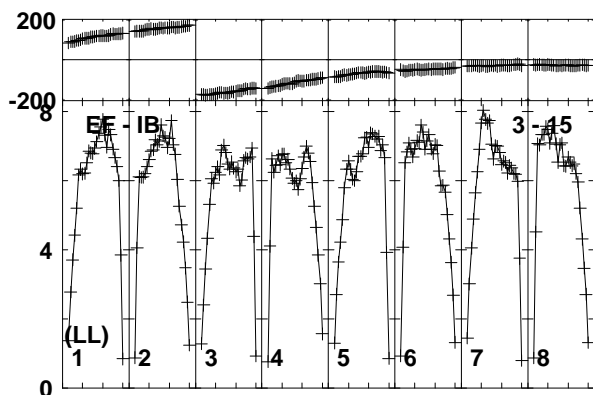
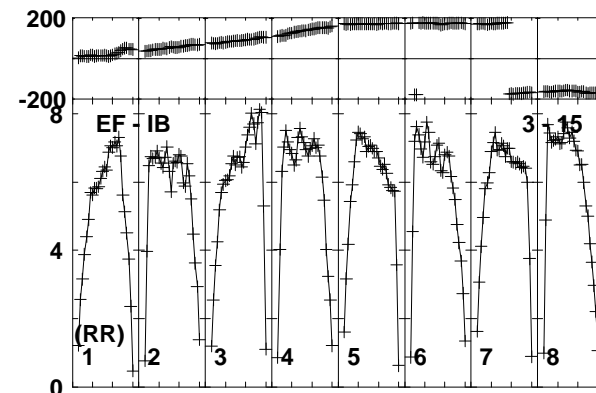
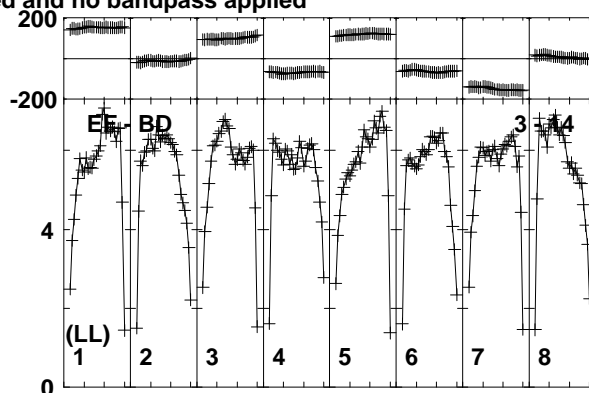
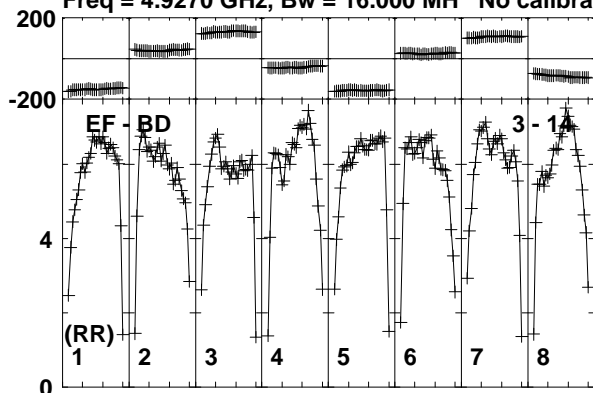

Lower frame: Milli Ampl Jy Top frame: Phas deg  
Vector averaged cross-power spectrum Baseline: EF (03) - BD (14)  
Timerange: 00/12:37:01 to 00/12:37:59

Plot file version 454 created 19-DEC-2018 17:58:46

AT2018\_RY007C.UVDATA.1

Freq = 4.9270 GHz, Bw = 16.000 MH No calibration applied and no bandpass applied

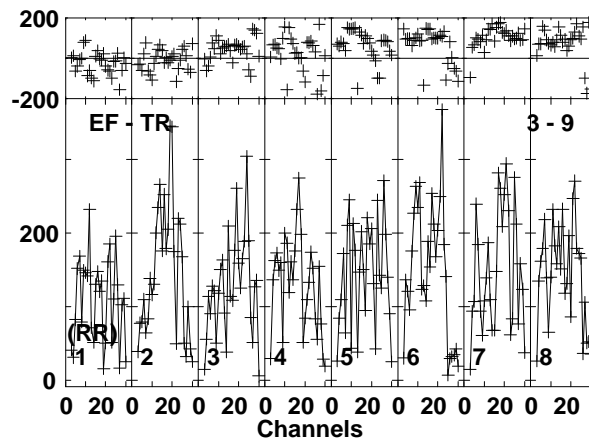
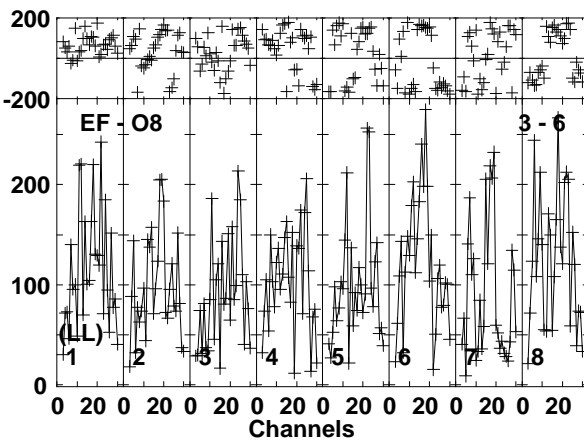
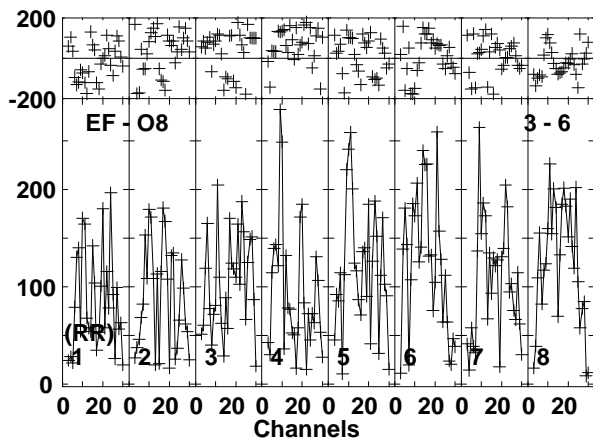
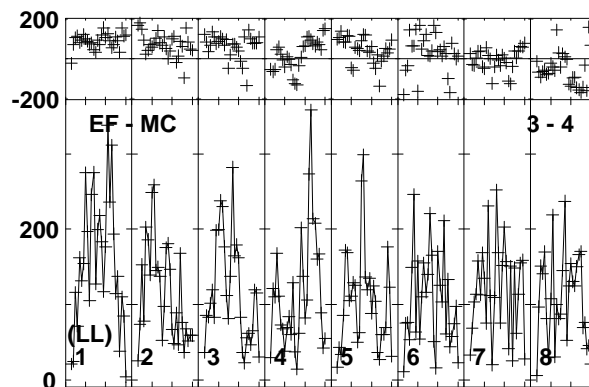
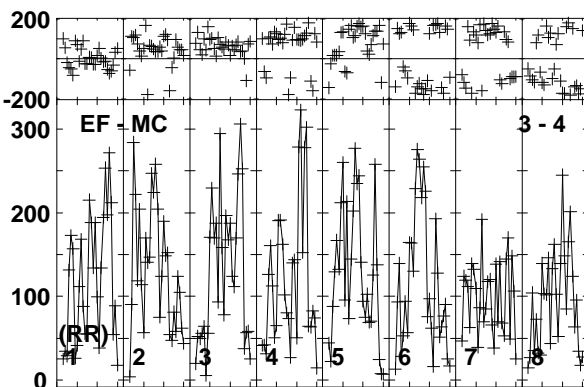
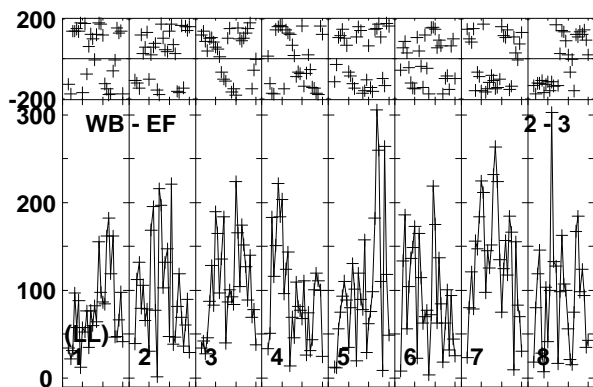
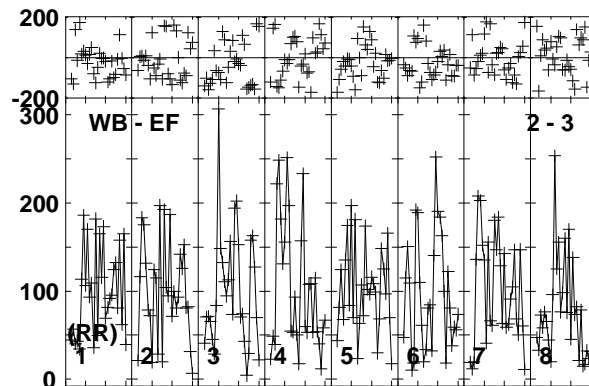
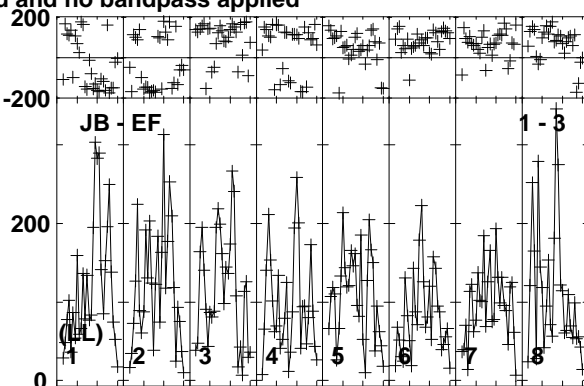
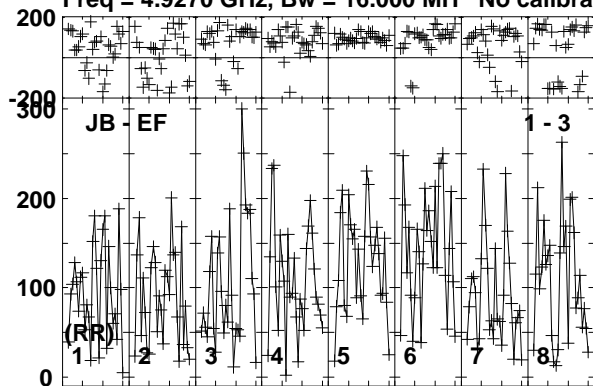

Lower frame: Micro Ampl Jy Top frame: Phas deg  
Vector averaged cross-power spectrum Baseline: JB (01) - EF (03)  
Timerange: 00:12:38:01 to 00:12:40:59

Plot file version 455 created 19-DEC-2018 17:58:46

AT2018\_RY007C.UVDATA.1

Freq = 4.9270 GHz, Bw = 16.000 MH No calibration applied and no bandpass applied

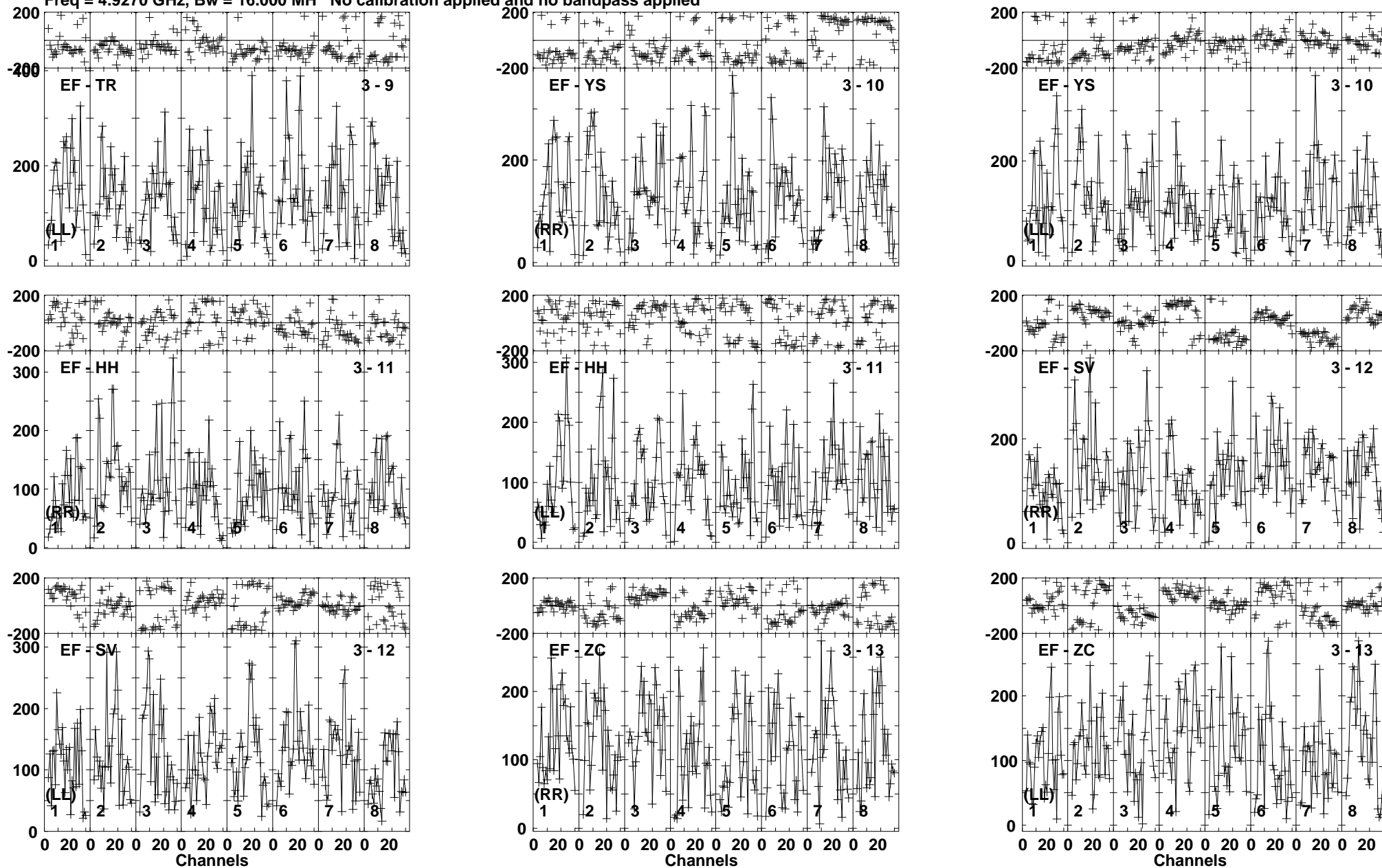

Lower frame: Micro Ampl Jy Top frame: Phas deg  
Vector averaged cross-power spectrum Baseline: EF (03) - TR (09)  
Timerange: 00:12:38:01 to 00:12:40:59

Plot file version 456 created 19-DEC-2018 17:58:46

AT2018\_RY007C.UVDATA.1

Freq = 4.9270 GHz, Bw = 16.000 MH No calibration applied and no bandpass applied

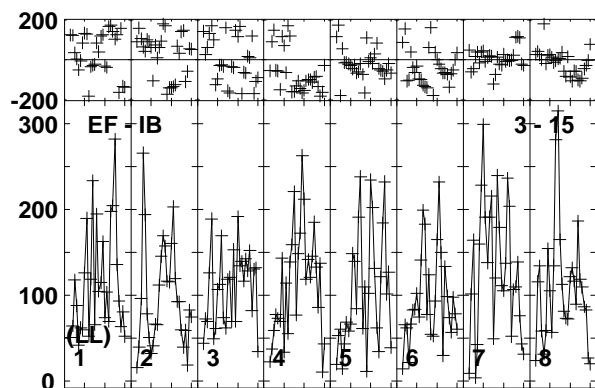
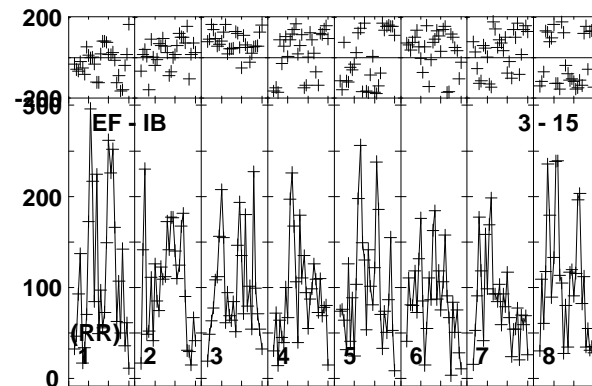
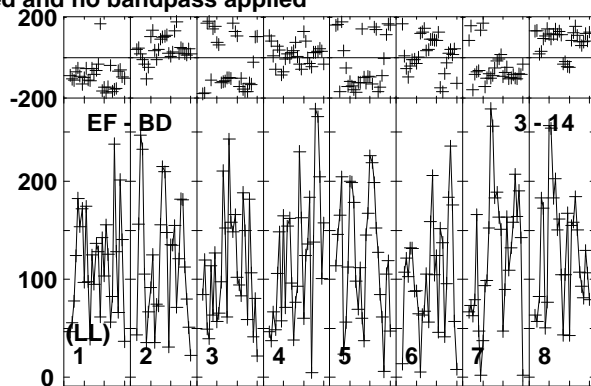
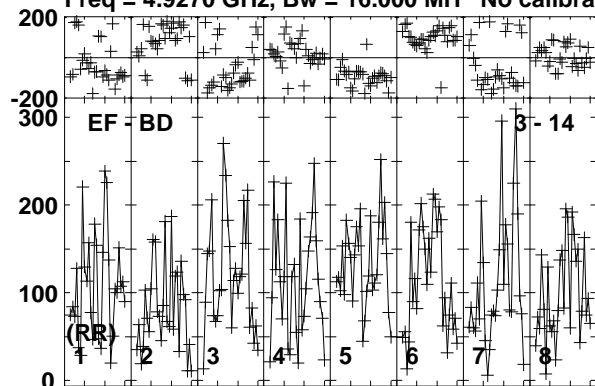

Lower frame: Micro Ampl Jy Top frame: Phas deg  
Vector averaged cross-power spectrum Baseline: EF (03) - BD (14)  
Timerange: 00/12:38:01 to 00/12:40:59

Plot file version 457 created 19-DEC-2018 17:58:46

J1619+2247 RY007C.UVDATA.1

Freq = 4.9270 GHz, Bw = 16.000 MH No calibration applied and no bandpass applied

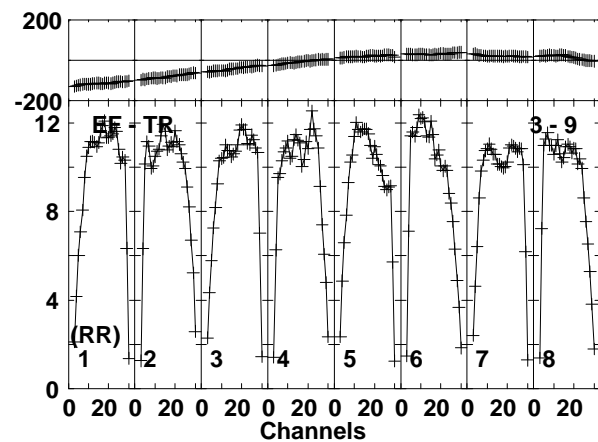
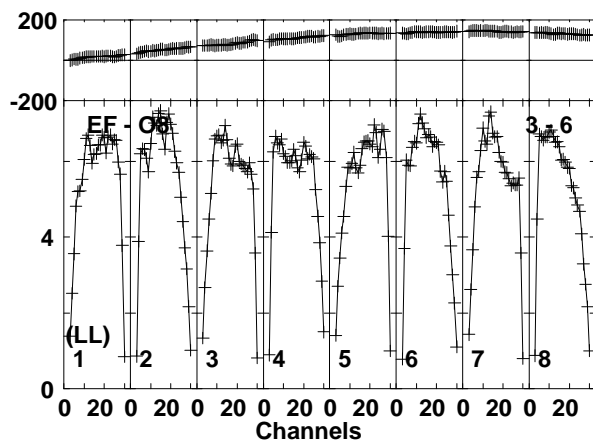
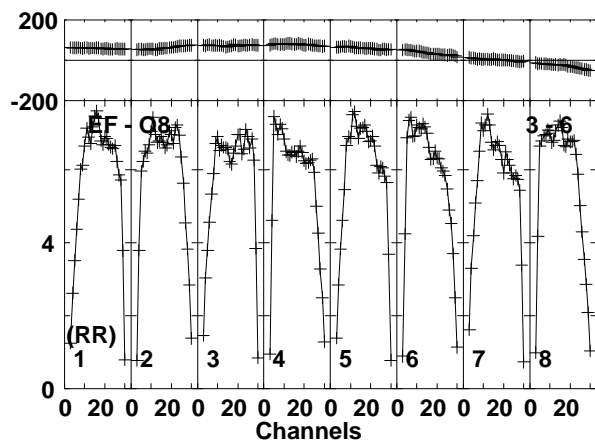
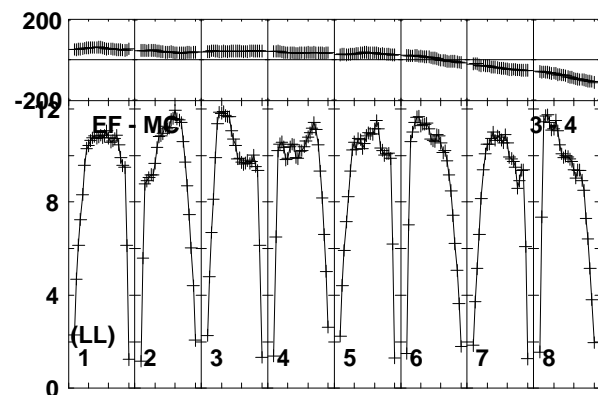
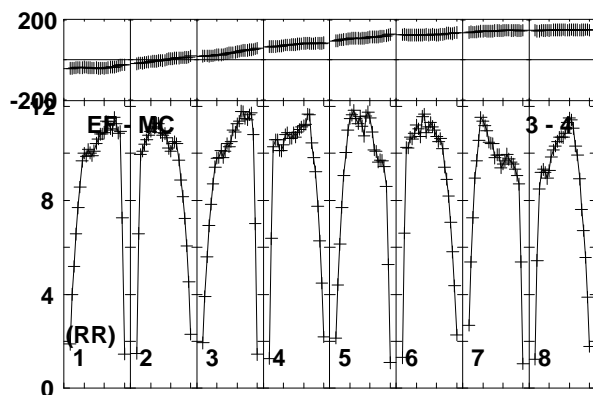
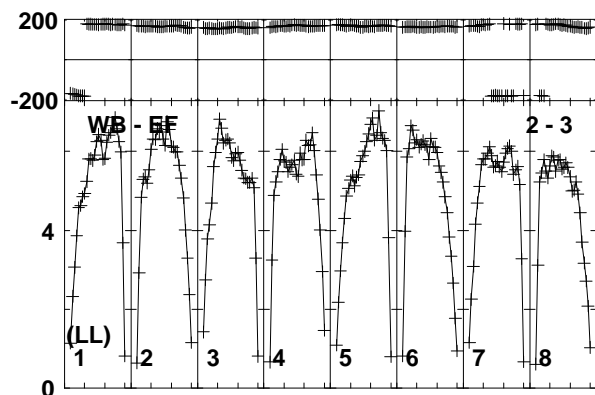
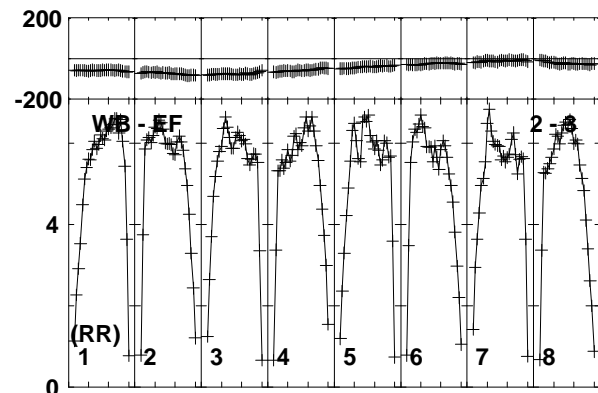
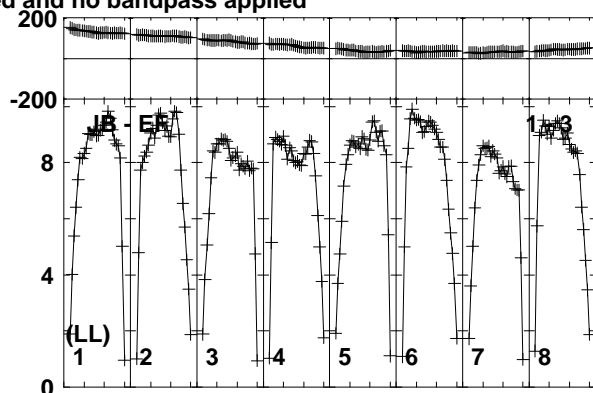
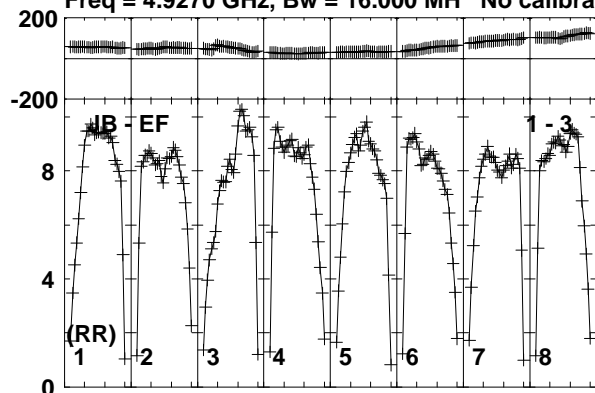

Lower frame: Milli Ampl Jy Top frame: Phas deg  
Vector averaged cross-power spectrum Baseline: JB (01) - EF (03)  
Timerange: 00:12:41:01 to 00:12:41:59

Plot file version 458 created 19-DEC-2018 17:58:46

J1619+2247 RY007C.UVDATA.1

Freq = 4.9270 GHz, Bw = 16.000 MH No calibration applied and no bandpass applied

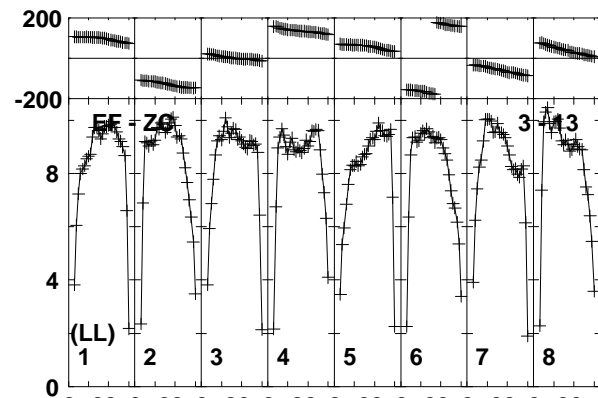
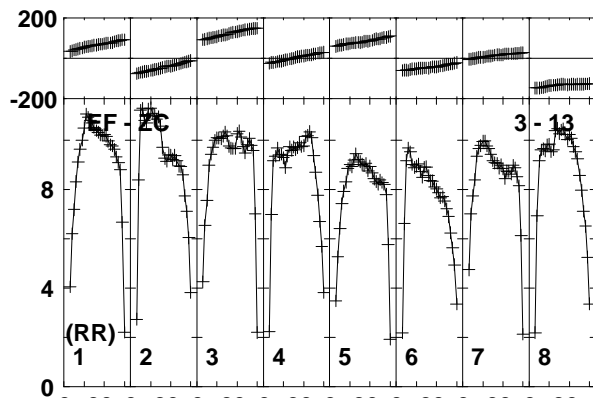
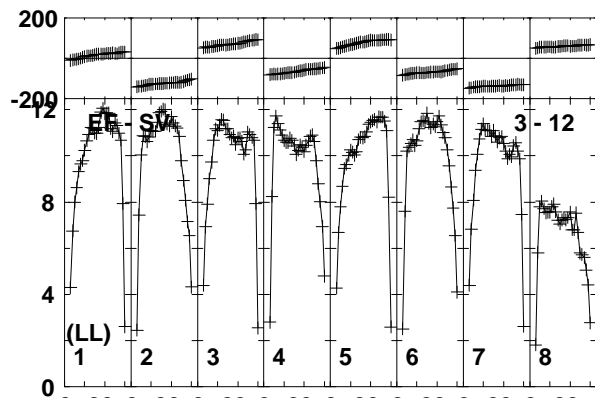
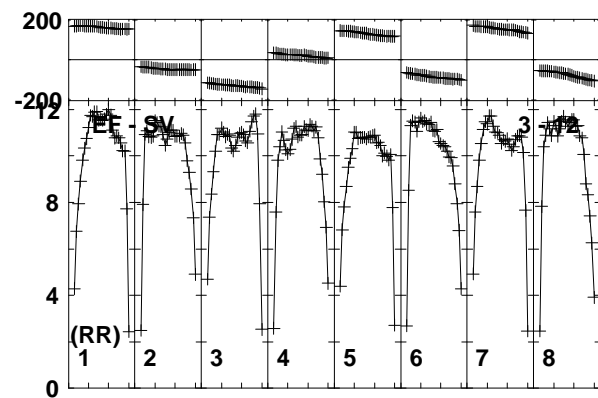
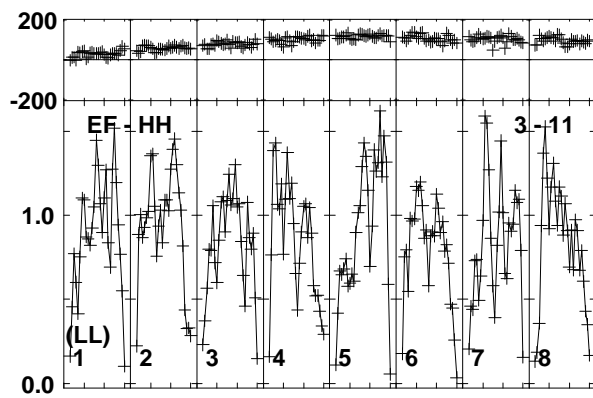
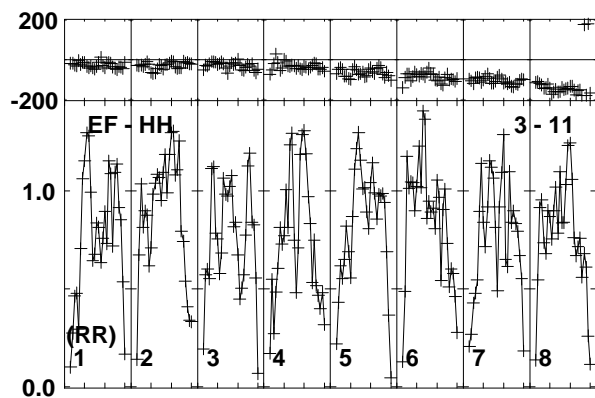
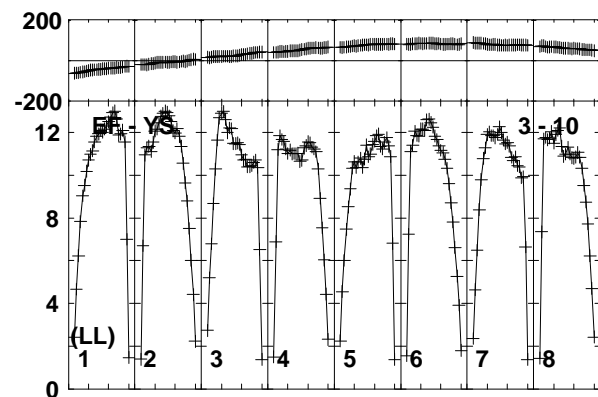
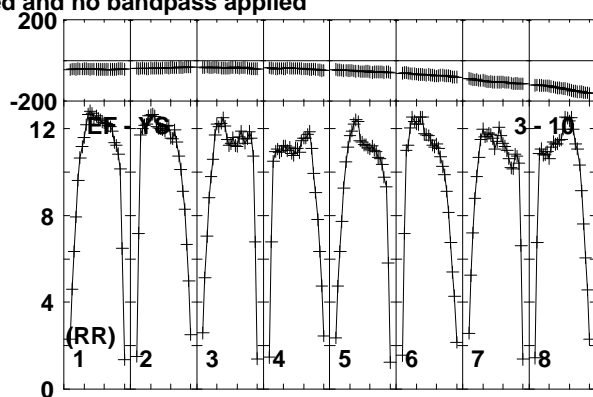
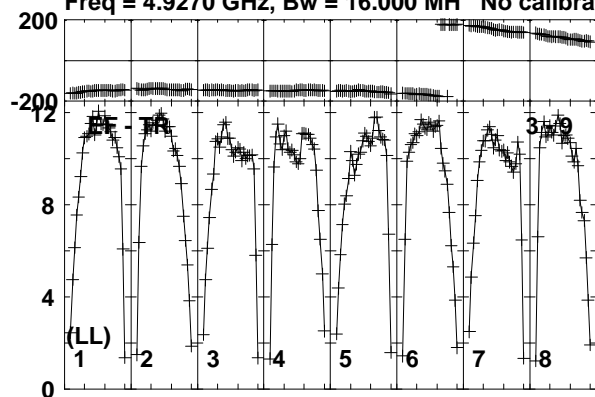

Lower frame: Milli Ampl Jy Top frame: Phas deg  
Vector averaged cross-power spectrum Baseline: EF (03) - TR (09)  
Timerange: 00:12:41:01 to 00:12:41:59



Plot file version 459 created 19-DEC-2018 17:58:46

J1619+2247 RY007C.UVDATA.1

Freq = 4.9270 GHz, Bw = 16.000 MH No calibration applied and no bandpass applied

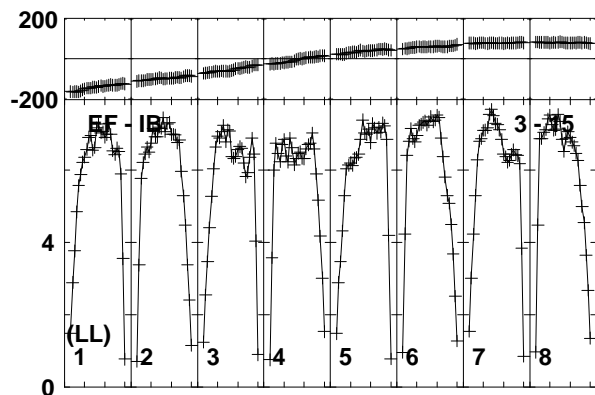
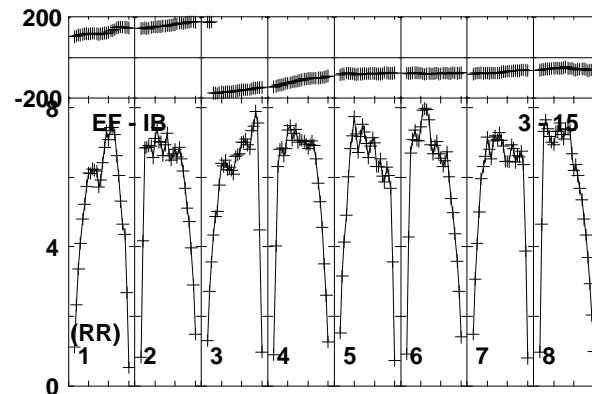
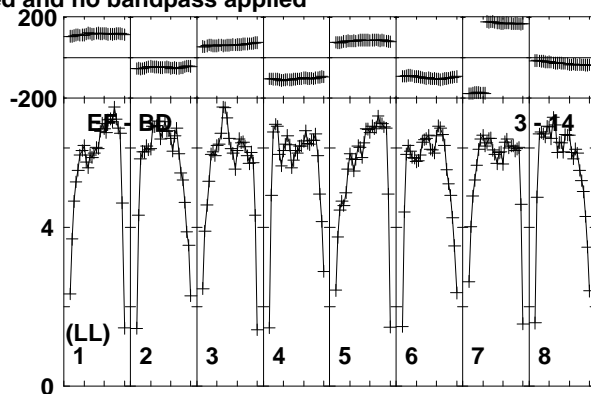
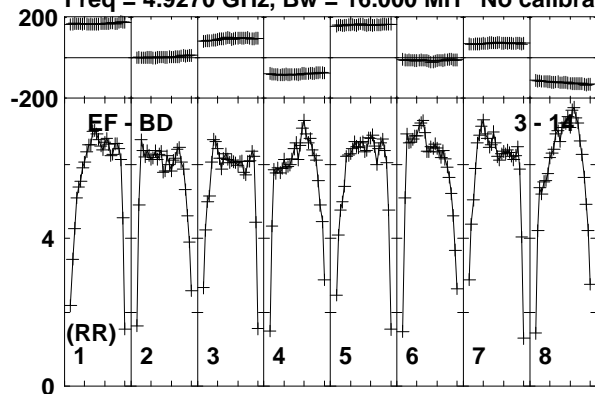

Lower frame: Milli Ampl Jy Top frame: Phas deg  
Vector averaged cross-power spectrum Baseline: EF (03) - BD (14)  
Timerange: 00/12:41:01 to 00/12:41:59

Plot file version 460 created 19-DEC-2018 17:58:46

AT2018\_RY007C.UVDATA.1

Freq = 4.9270 GHz, Bw = 16.000 MH No calibration applied and no bandpass applied

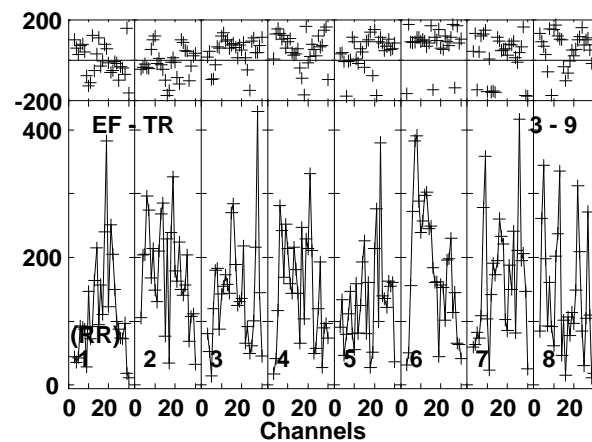
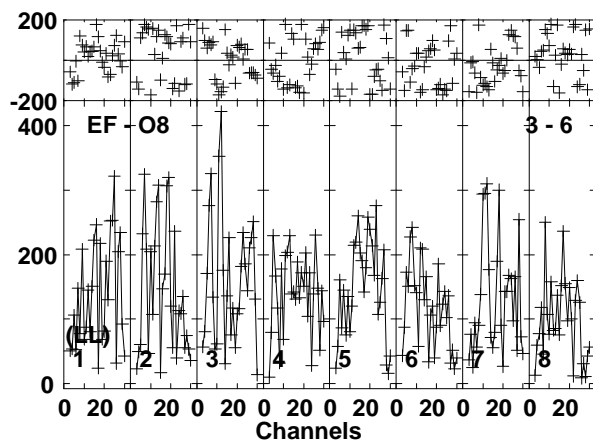
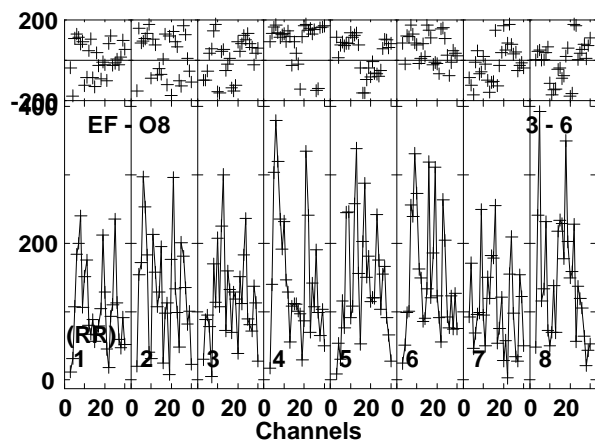
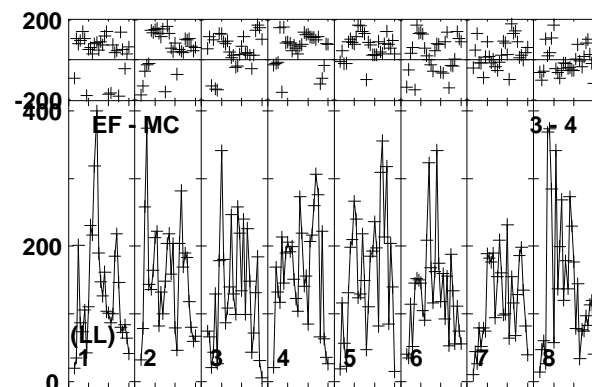
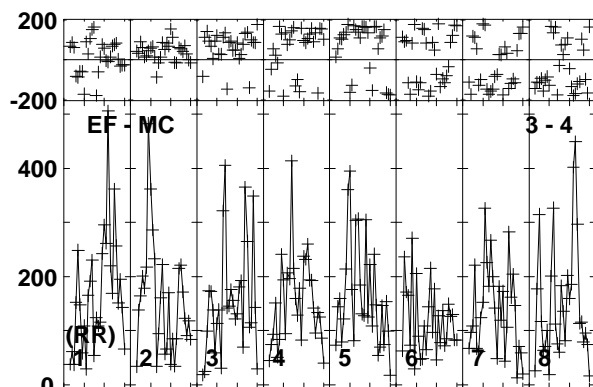
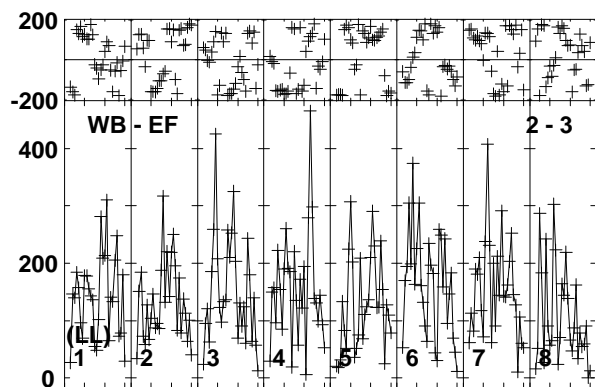
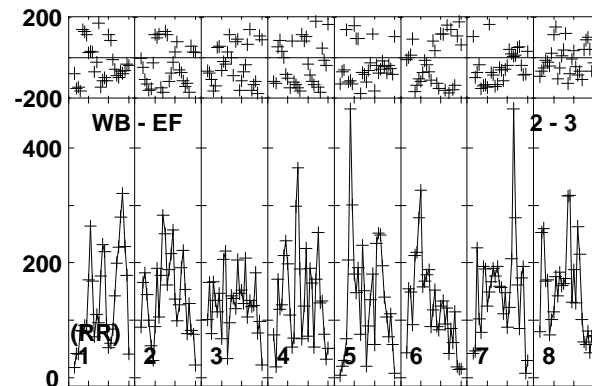
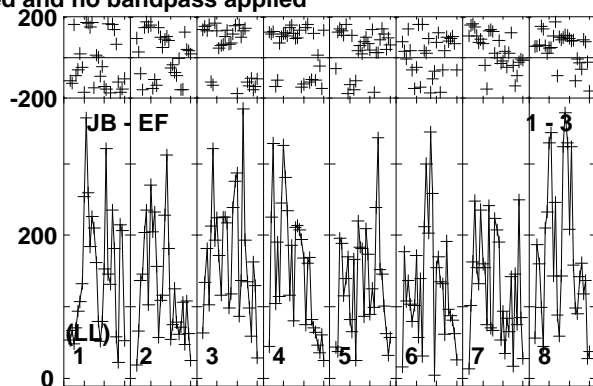
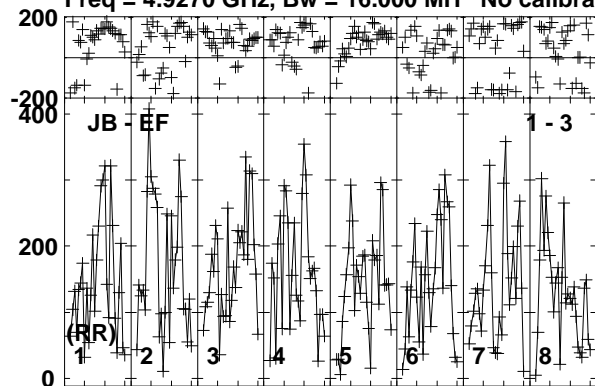

Lower frame: Micro Ampl Jy Top frame: Phas deg  
Vector averaged cross-power spectrum Baseline: JB (01) - EF (03)  
Timerange: 00/12:42:01 to 00/12:43:59

Plot file version 461 created 19-DEC-2018 17:58:46

AT2018\_RY007C.UVDATA.1

Freq = 4.9270 GHz, Bw = 16.000 MH No calibration applied and no bandpass applied

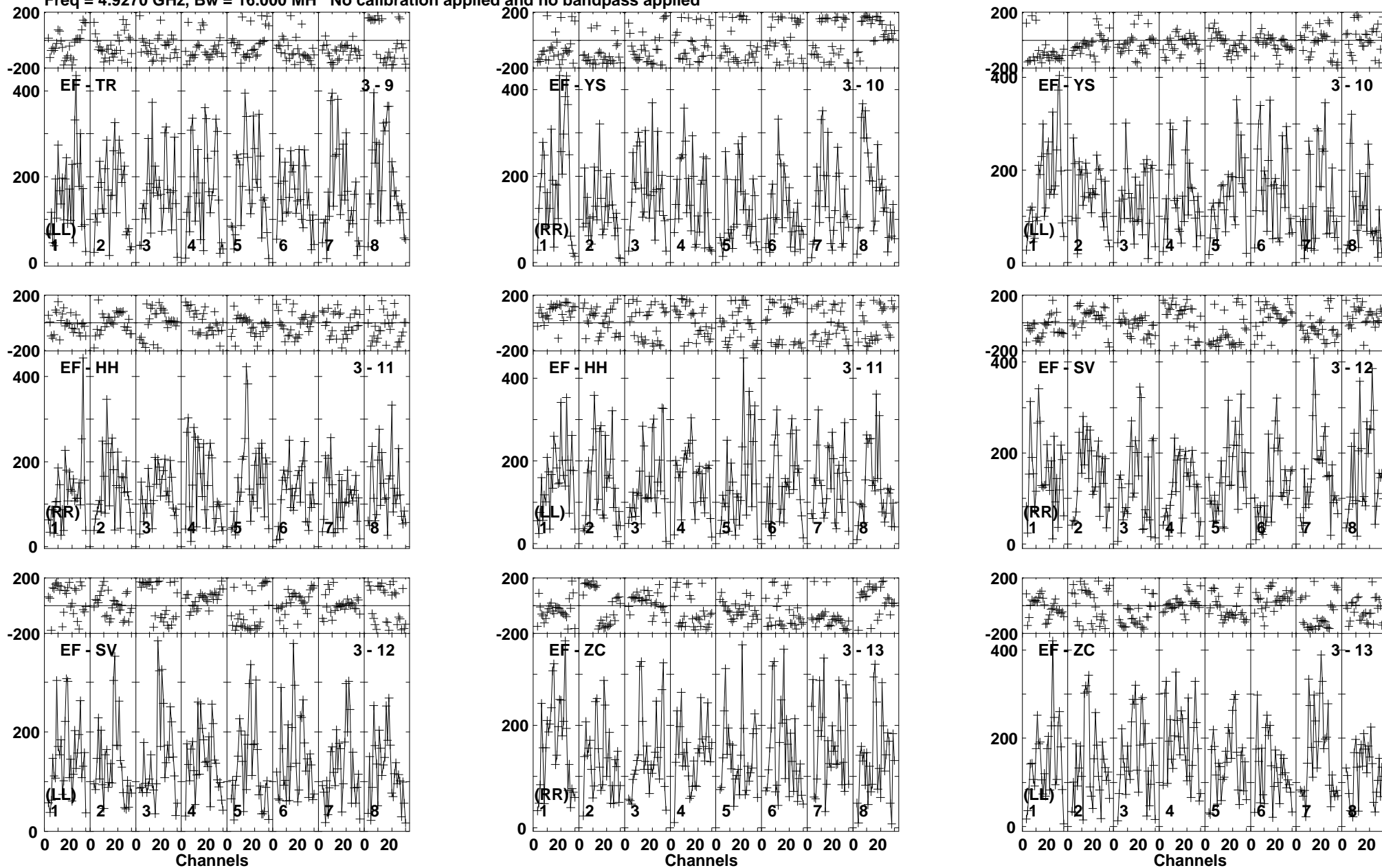

Lower frame: Micro Ampl Jy Top frame: Phas deg  
Vector averaged cross-power spectrum Baseline: EF (03) - TR (09)  
Timerange: 00:12:42:01 to 00:12:43:59

Plot file version 462 created 19-DEC-2018 17:58:46

AT2018\_RY007C.UVDATA.1

Freq = 4.9270 GHz, Bw = 16.000 MH No calibration applied and no bandpass applied

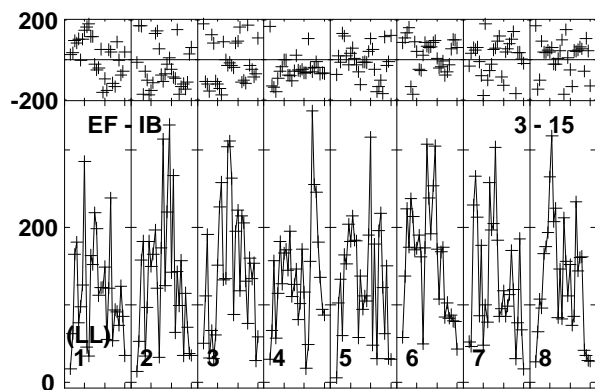
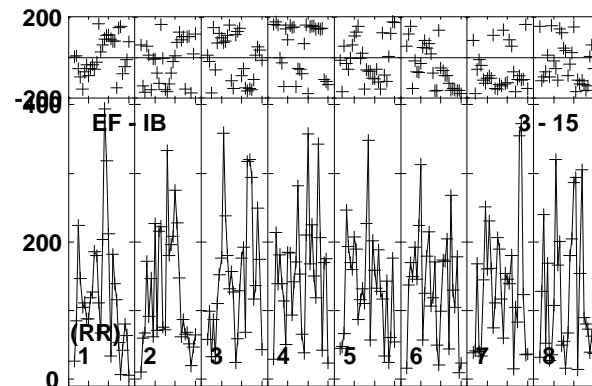
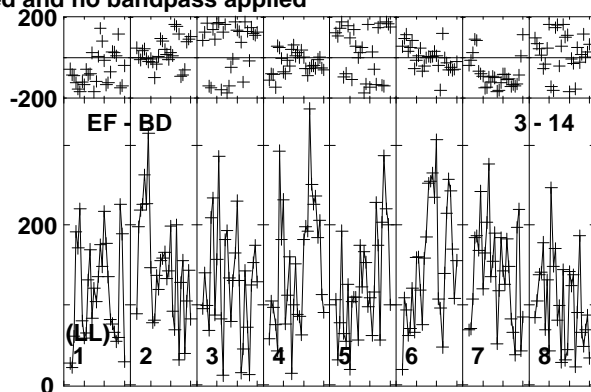
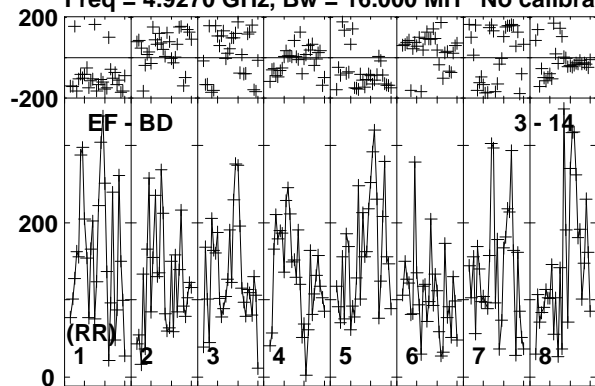

Lower frame: Micro Ampl Jy Top frame: Phas deg  
Vector averaged cross-power spectrum Baseline: EF (03) - BD (14)  
Timerange: 00:12:42:01 to 00:12:43:59

Plot file version 463 created 19-DEC-2018 17:58:47

VLA2 RY007C.UVDATA.1

Freq = 4.9270 GHz, Bw = 16.000 MH No calibration applied and no bandpass applied

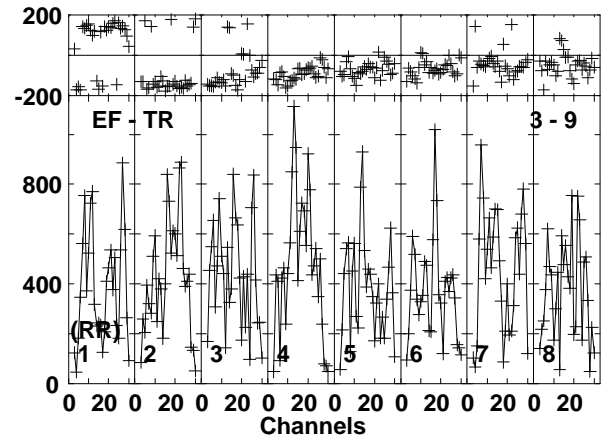
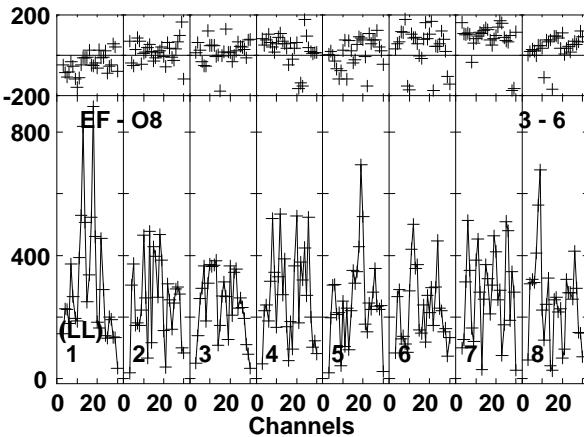
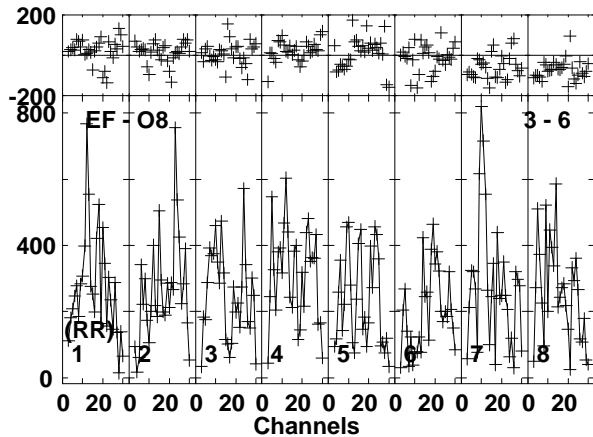
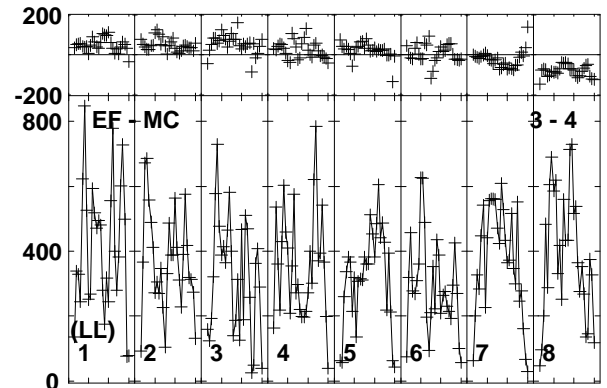
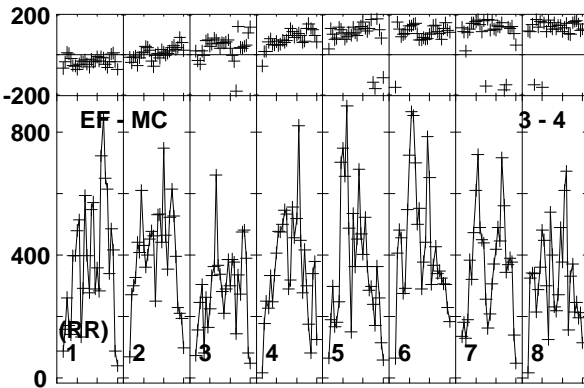
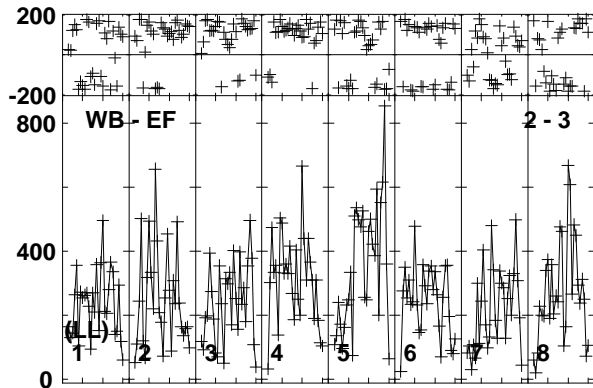
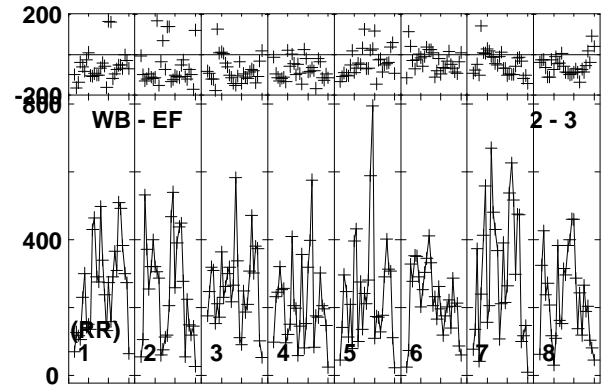
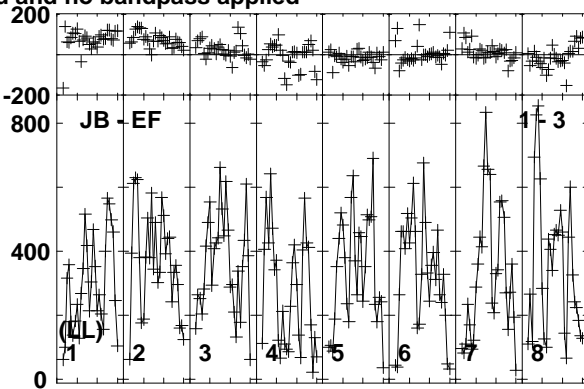
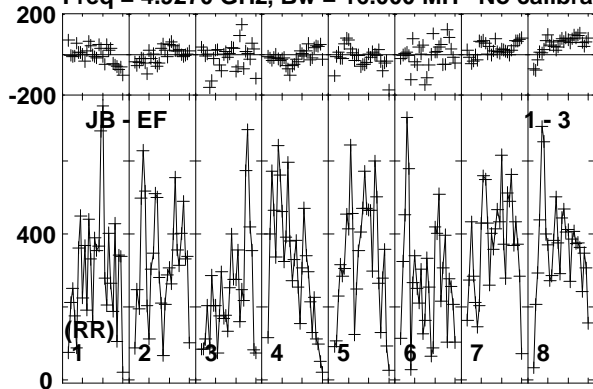

Lower frame: Micro Ampl Jy Top frame: Phas deg  
Vector averaged cross-power spectrum Baseline: JB (01) - EF (03)  
Timerange: 00:12:44:01 to 00:12:44:59

Plot file version 464 created 19-DEC-2018 17:58:47

VLA2\_RY007C.UVDATA.1

Freq = 4.9270 GHz, Bw = 16.000 MH No calibration applied and no bandpass applied

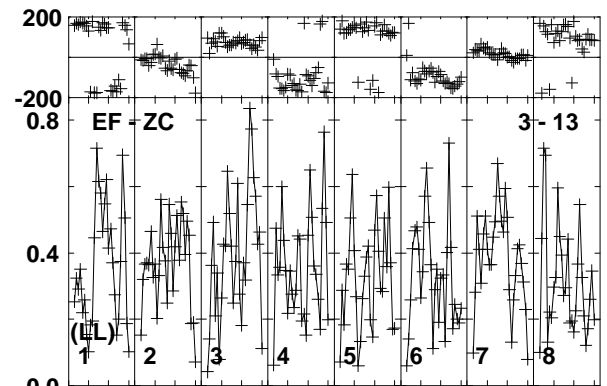
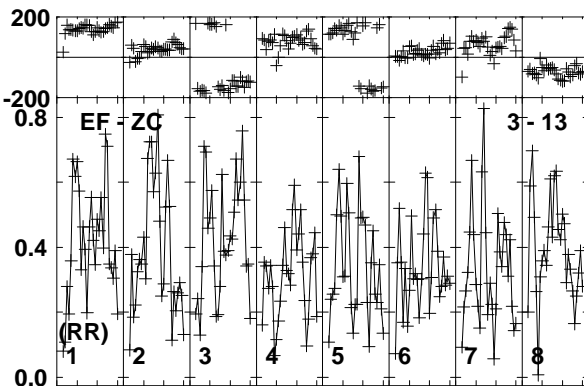
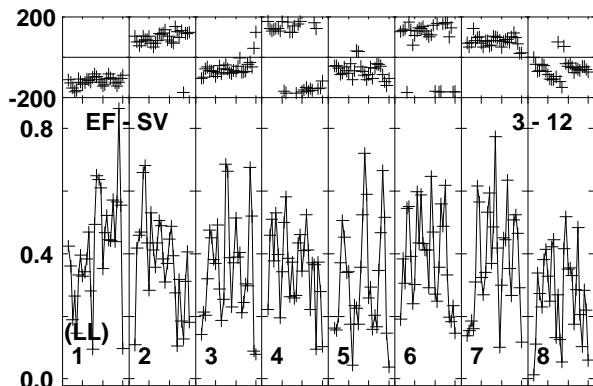
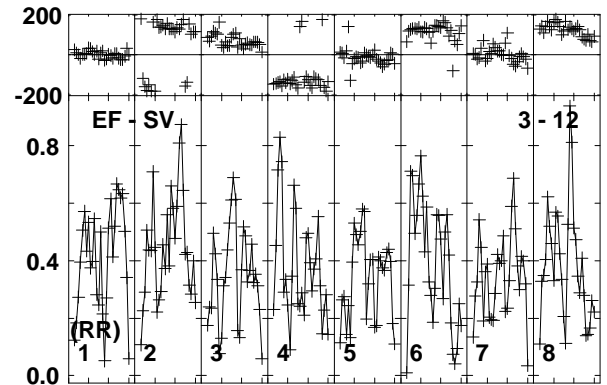
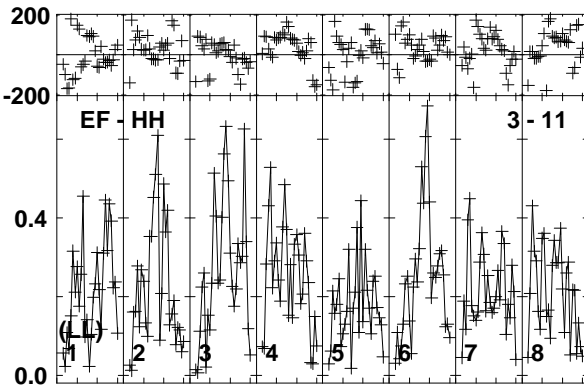
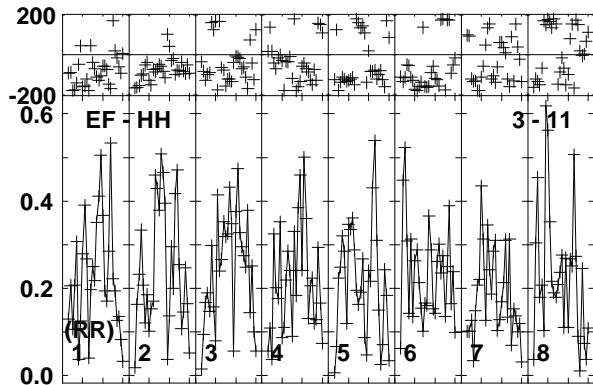
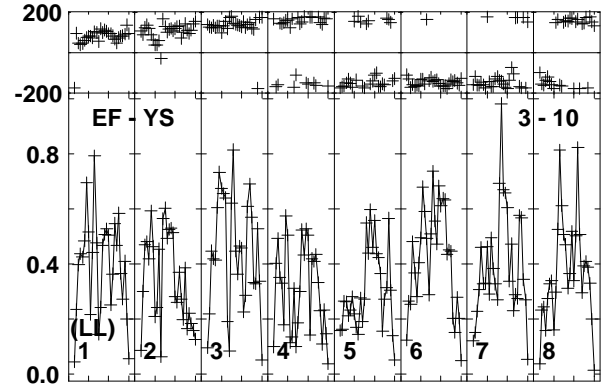
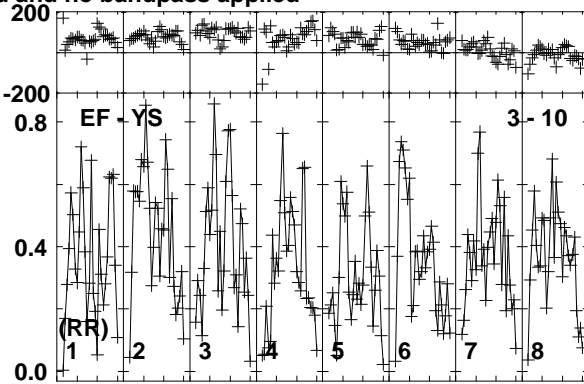
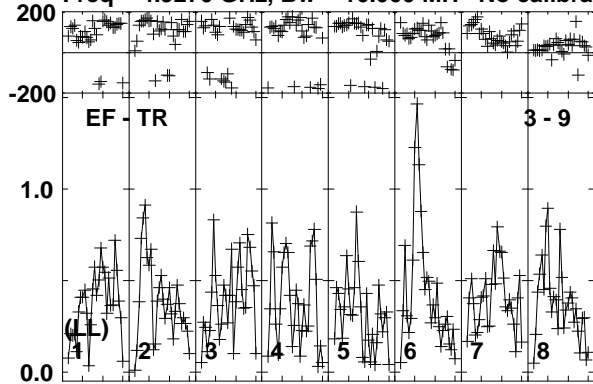

Lower frame: Milli Ampl Jy Top frame: Phas deg  
Vector averaged cross-power spectrum Baseline: EF (03) - TR (09)  
Timerange: 00/12:44:01 to 00/12:44:59

Plot file version 465 created 19-DEC-2018 17:58:47

VLA2 RY007C.UVDATA.1

Freq = 4.9270 GHz, Bw = 16.000 MH No calibration applied and no bandpass applied

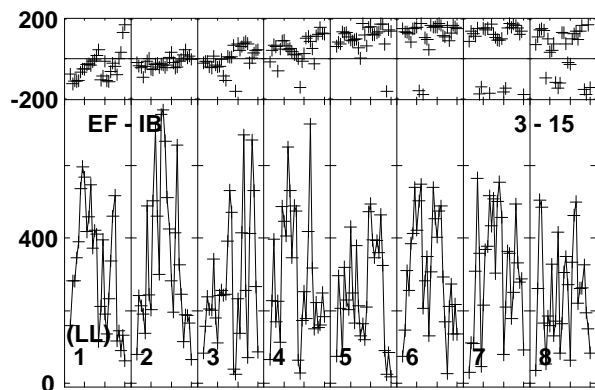
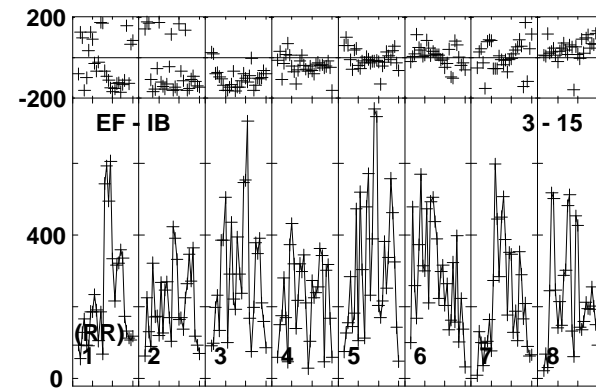
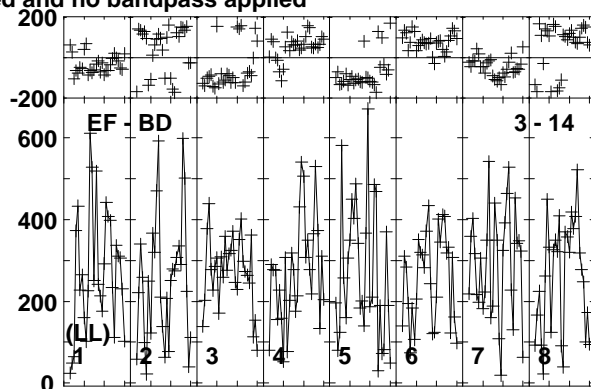
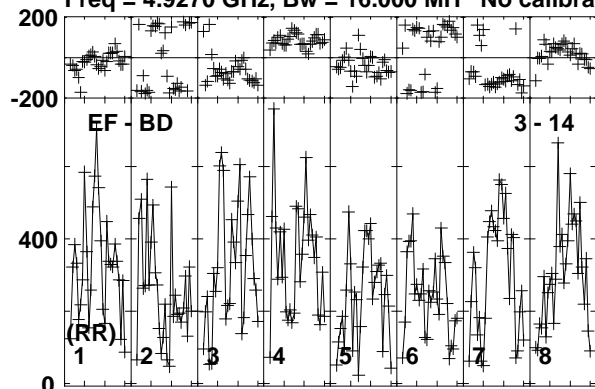

Lower frame: Micro Ampl Jy Top frame: Phas deg  
Vector averaged cross-power spectrum Baseline: EF (03) - BD (14)  
Timerange: 00:12:44:01 to 00:12:44:59

Plot file version 466 created 19-DEC-2018 17:58:47

J1619+2247 RY007C.UVDATA.1

Freq = 4.9270 GHz, Bw = 16.000 MH No calibration applied and no bandpass applied

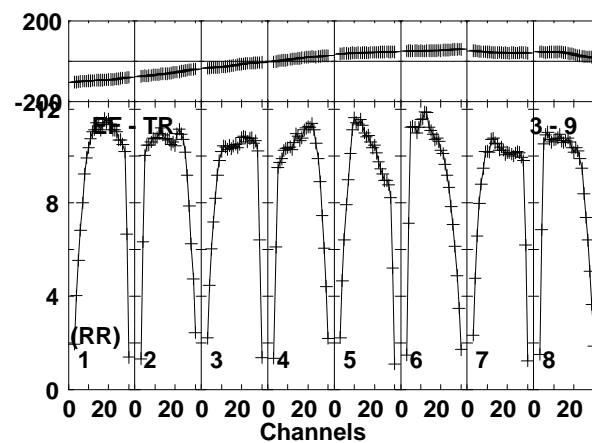
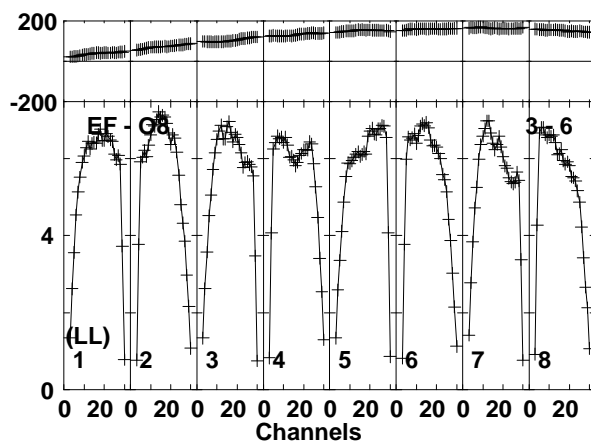
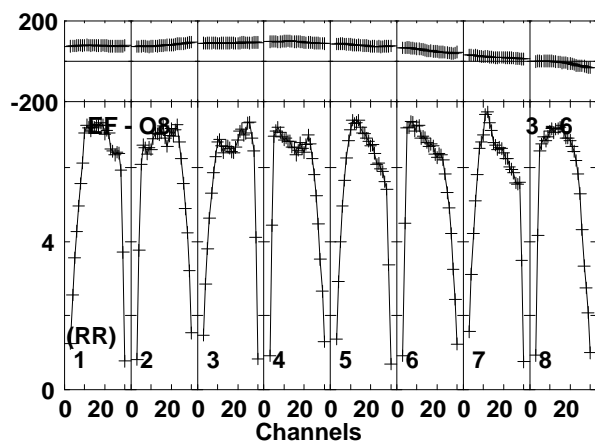
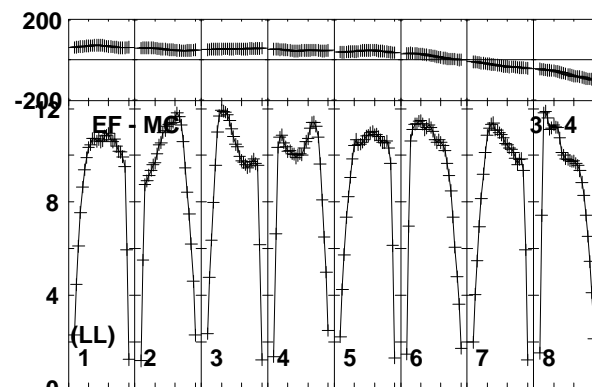
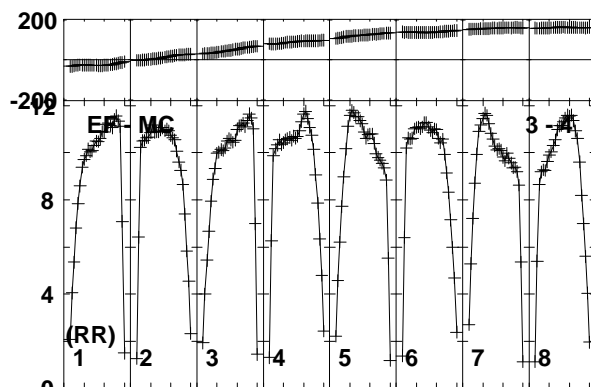
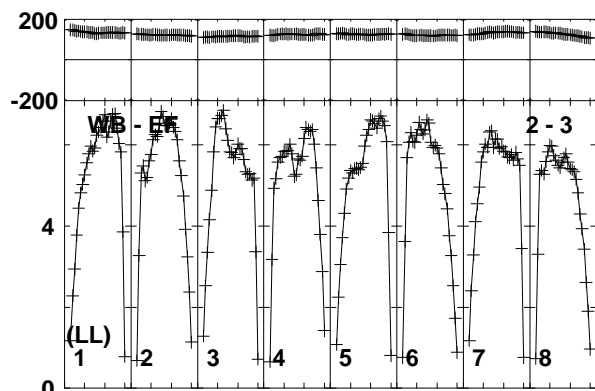
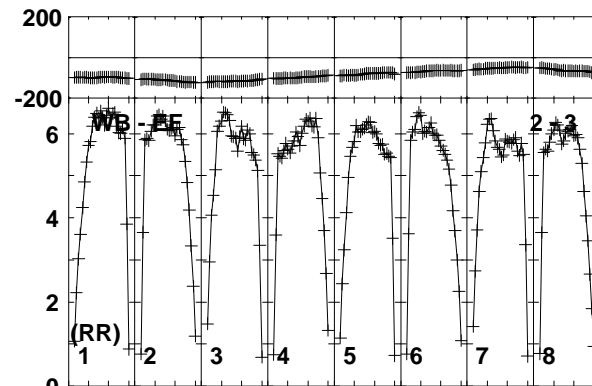
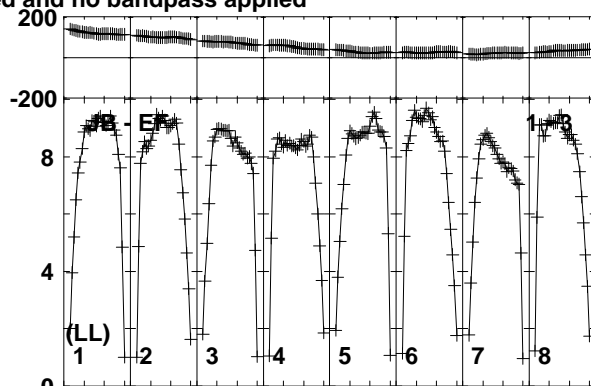
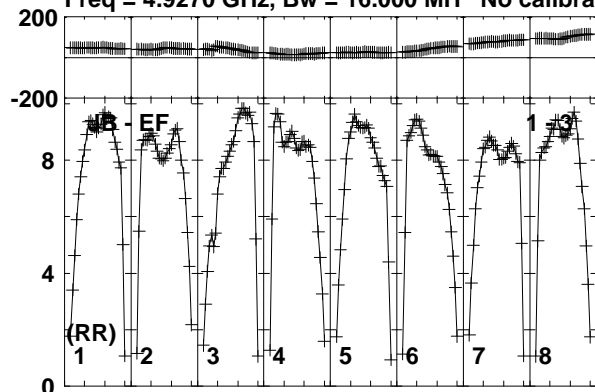

Lower frame: Milli Ampl Jy Top frame: Phas deg  
Vector averaged cross-power spectrum Baseline: JB (01) - EF (03)  
Timerange: 00:12:45:31 to 00:12:46:29



Plot file version 467 created 19-DEC-2018 17:58:47

J1619+2247 RY007C.UVDATA.1

Freq = 4.9270 GHz, Bw = 16.000 MH No calibration applied and no bandpass applied

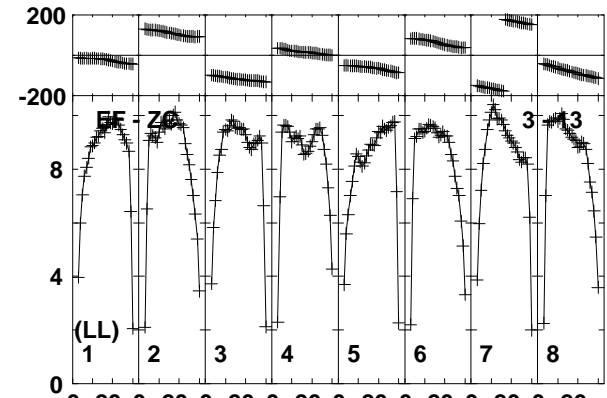
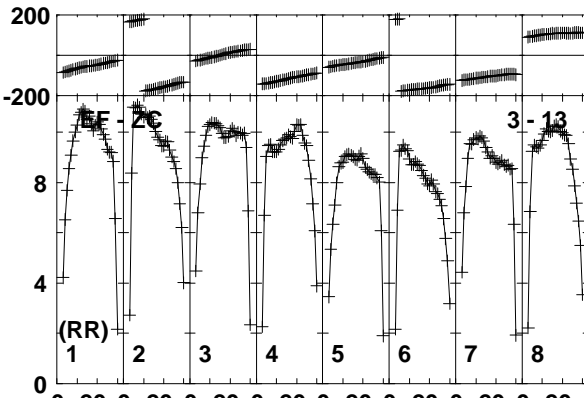
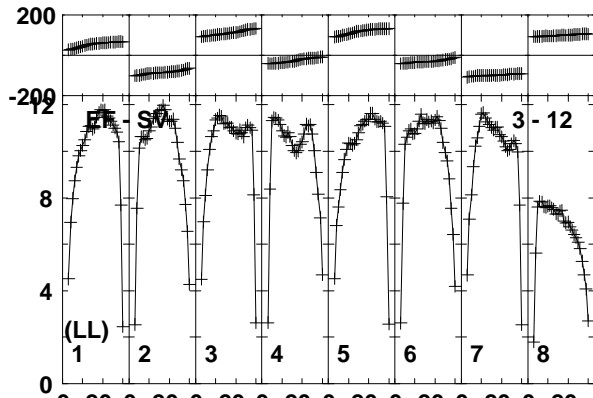
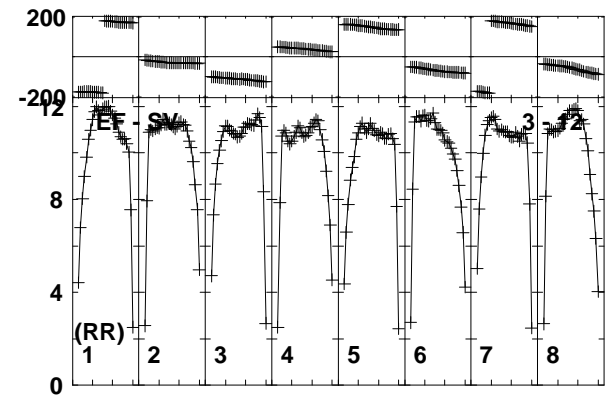
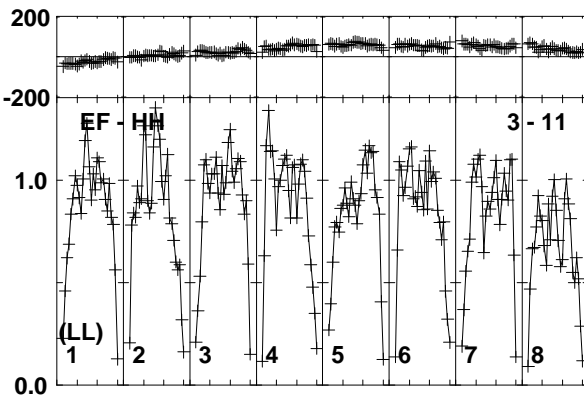
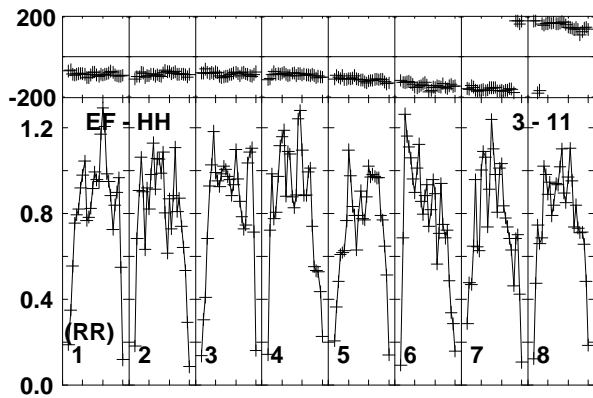
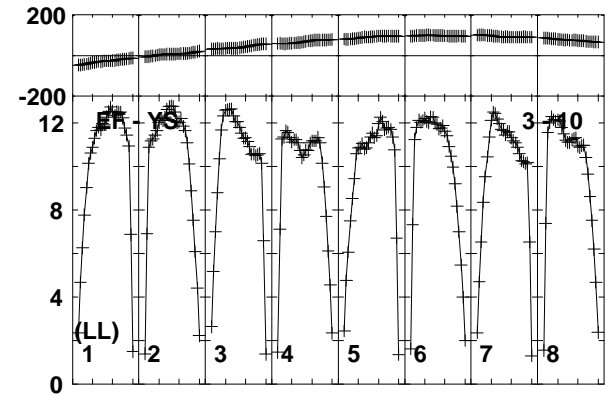
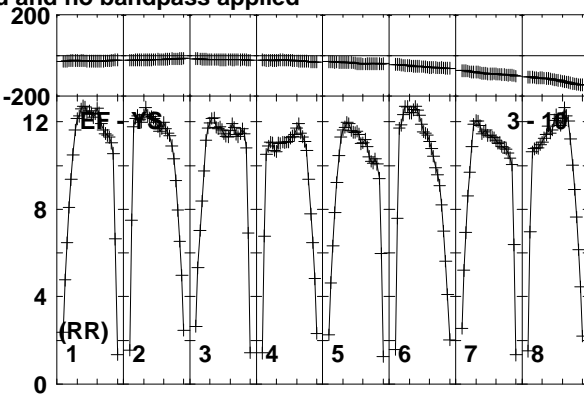
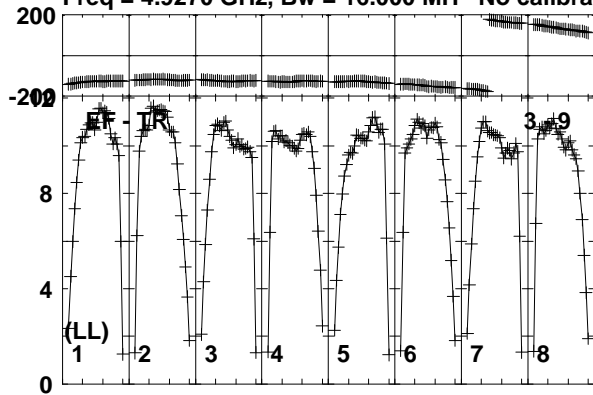

Lower frame: Milli Ampl Jy Top frame: Phas deg  
Vector averaged cross-power spectrum Baseline: EF (03) - TR (09)  
Timerange: 00:12:45:31 to 00:12:46:29

Plot file version 468 created 19-DEC-2018 17:58:47

J1619+2247 RY007C.UVDATA.1

Freq = 4.9270 GHz, Bw = 16.000 MH No calibration applied and no bandpass applied

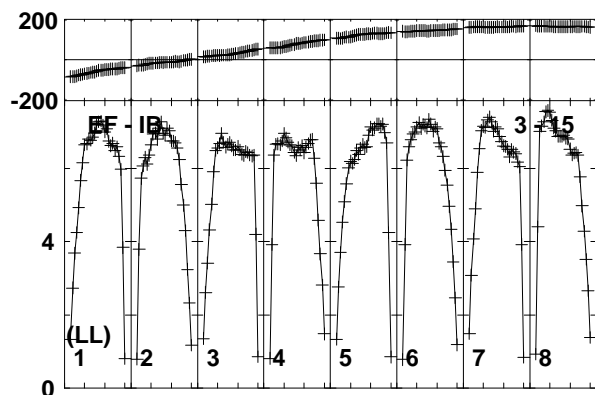
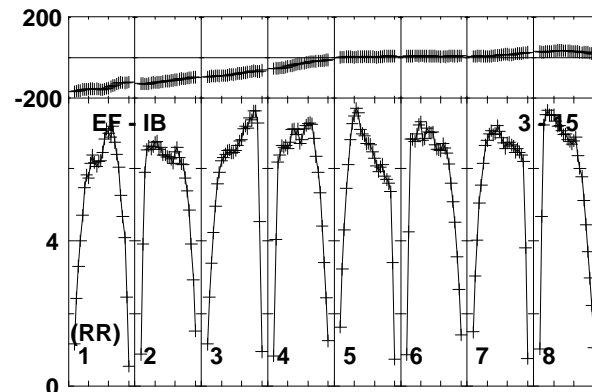
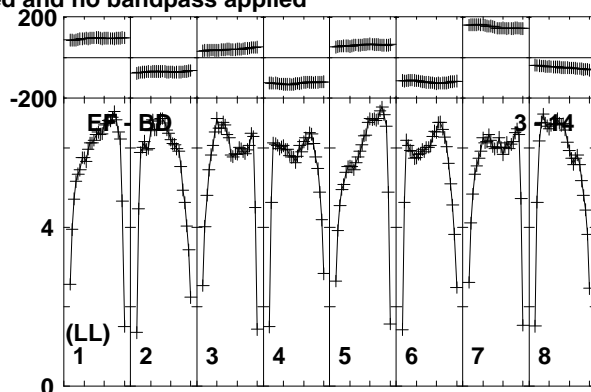
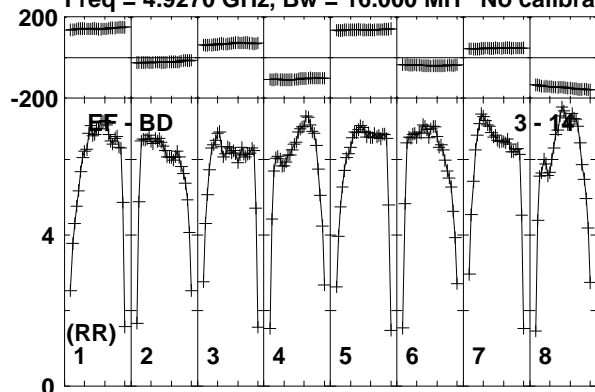

Lower frame: Milli Ampl Jy Top frame: Phas deg

Vector averaged cross-power spectrum Baseline: EF (03) - BD (14)

Timerange: 00/12:45:31 to 00/12:46:29

Plot file version 469 created 19-DEC-2018 17:58:47

AT2018\_RY007C.UVDATA.1

Freq = 4.9270 GHz, Bw = 16.000 MH No calibration applied and no bandpass applied

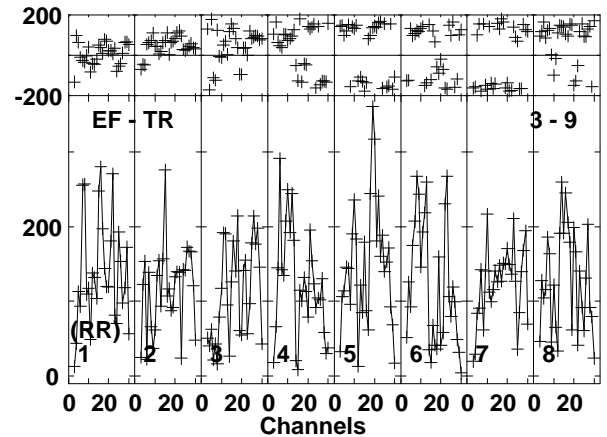
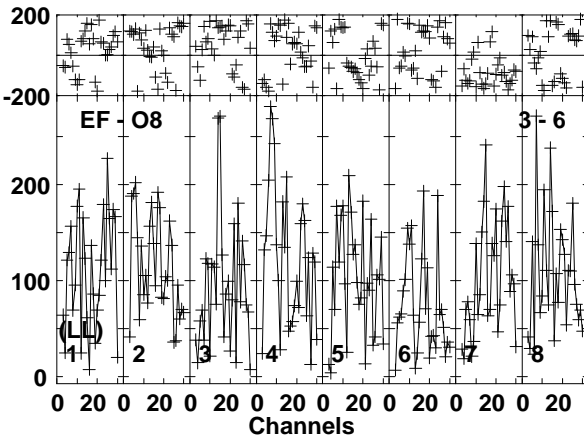
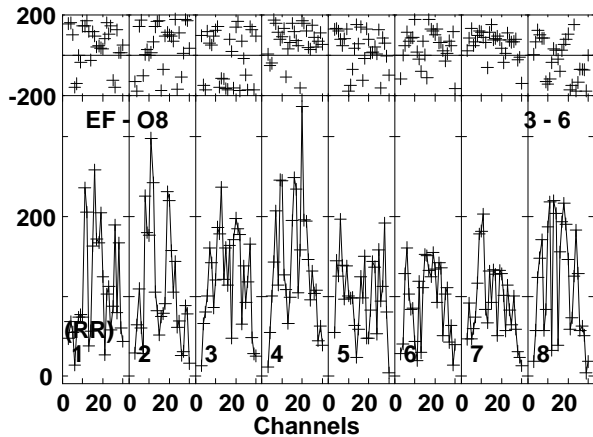
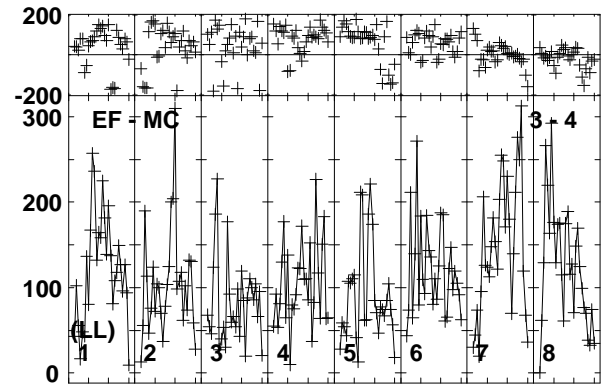
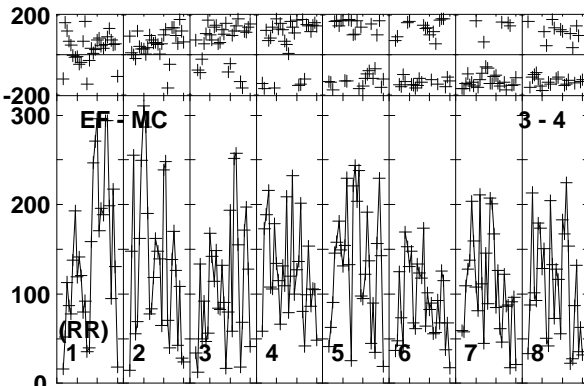
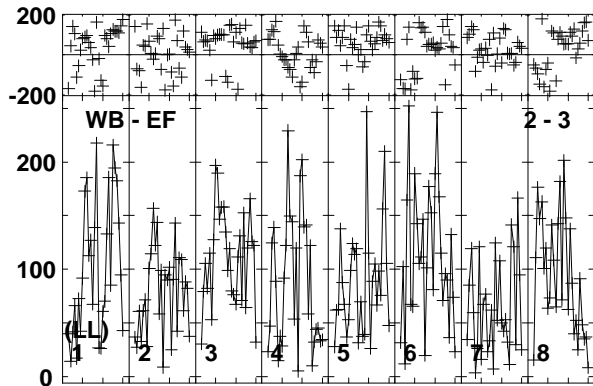
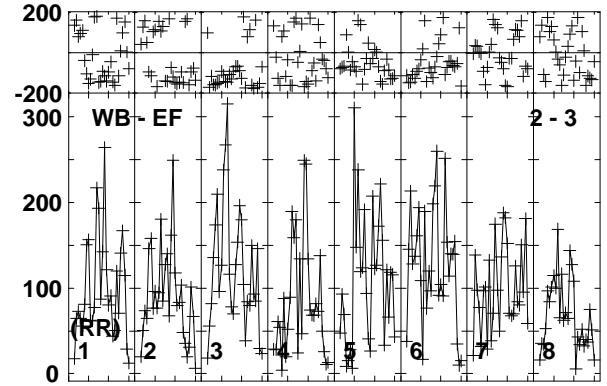
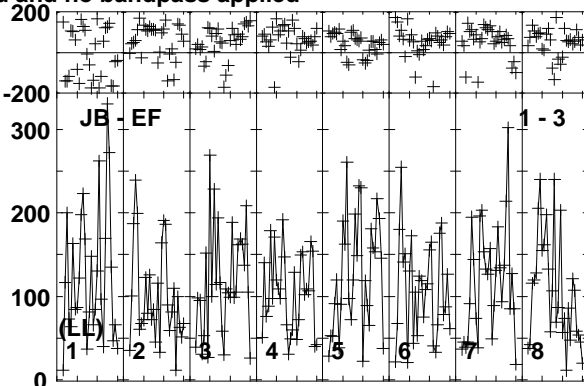
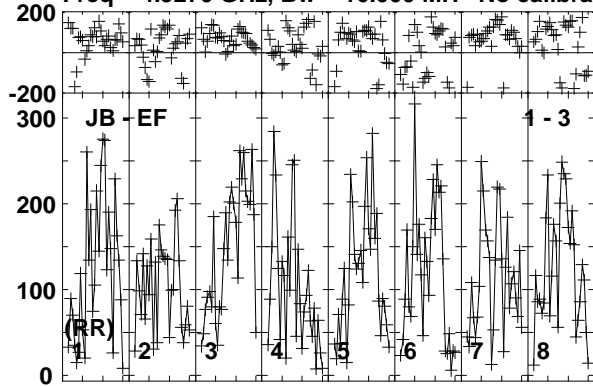

Lower frame: Micro Ampl Jy Top frame: Phas deg  
Vector averaged cross-power spectrum Baseline: JB (01) - EF (03)  
Timerange: 00/12:46:31 to 00/12:49:29

Plot file version 470 created 19-DEC-2018 17:58:47  
AT2018\_RY007C.UVDATA.1

Freq = 4.9270 GHz, Bw = 16.000 MH No calibration applied and no bandpass applied

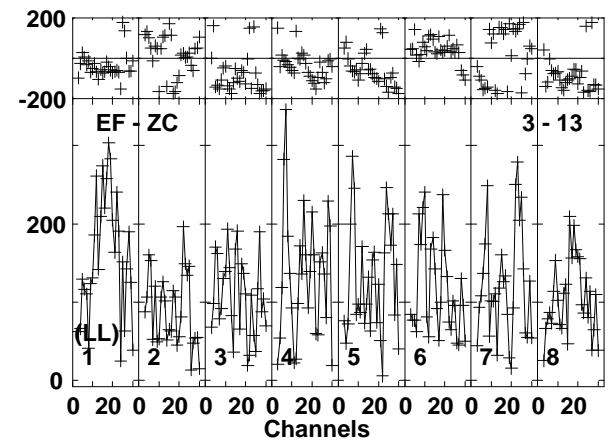
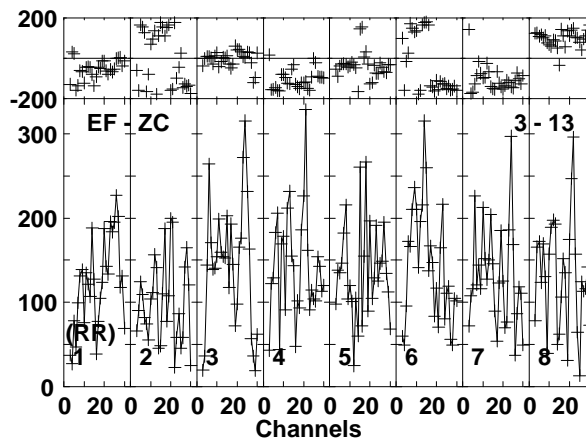
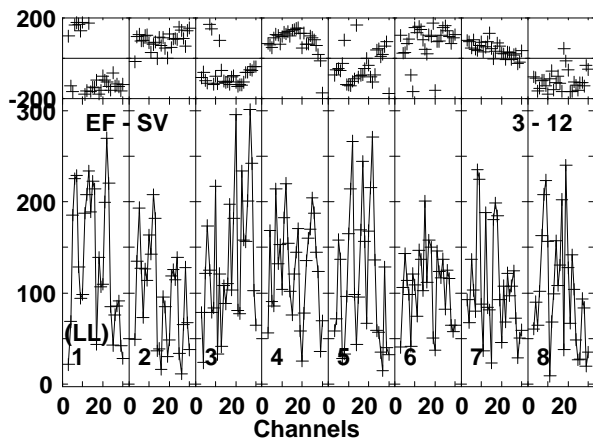
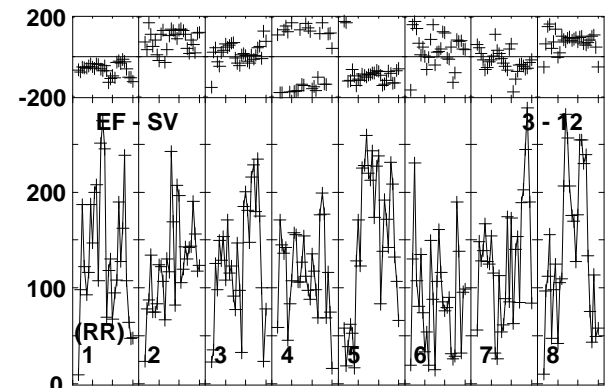
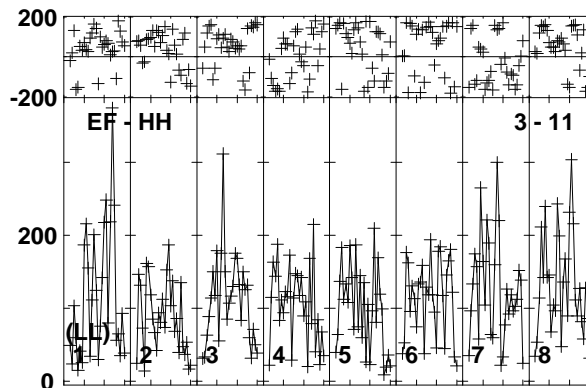
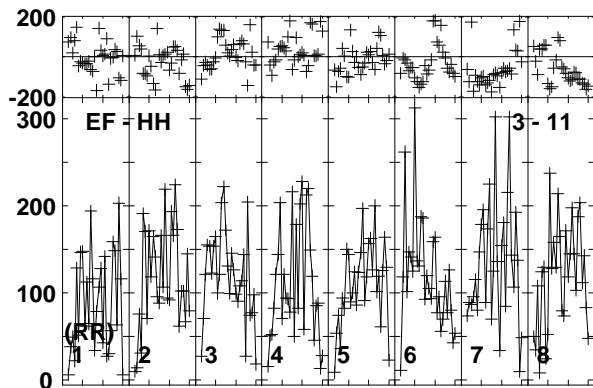
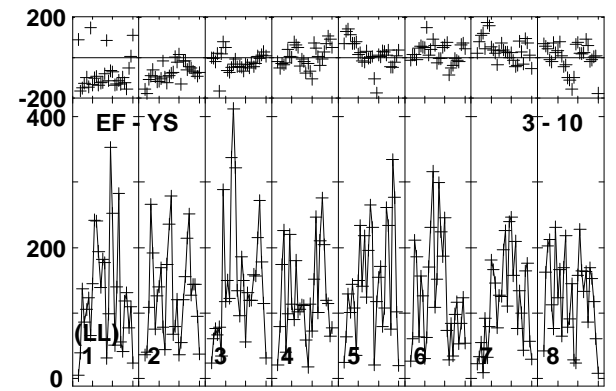
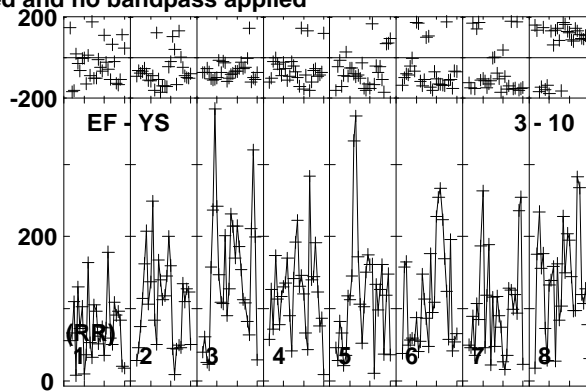
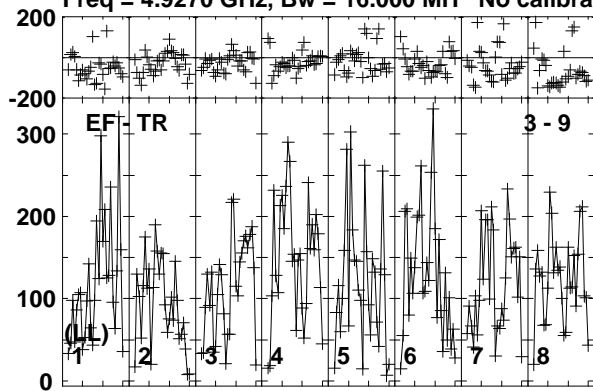

Lower frame: Micro Ampl Jy Top frame: Phas deg  
Vector averaged cross-power spectrum Baseline: EF (03) - TR (09)  
Timerange: 00/12:46:31 to 00/12:49:29

Plot file version 471 created 19-DEC-2018 17:58:47

AT2018\_RY007C.UVDATA.1

Freq = 4.9270 GHz, Bw = 16.000 MH No calibration applied and no bandpass applied

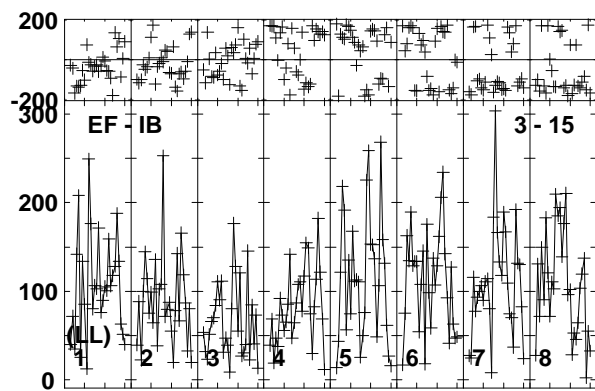
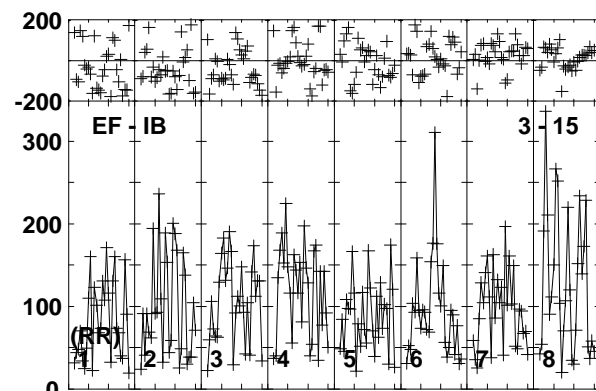
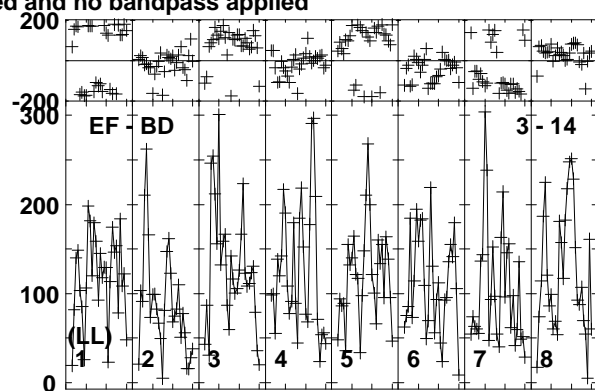
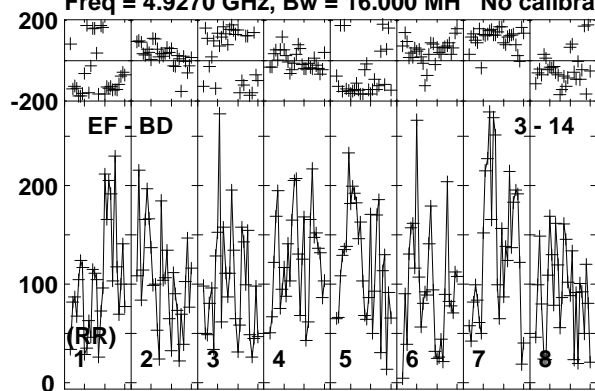

Lower frame: Micro Ampl Jy Top frame: Phas deg  
Vector averaged cross-power spectrum Baseline: EF (03) - BD (14)  
Timerange: 00:12:46:31 to 00:12:49:29

Plot file version 472 created 19-DEC-2018 17:58:47

J1619+2247 RY007C.UVDATA.1

Freq = 4.9270 GHz, Bw = 16.000 MH No calibration applied and no bandpass applied

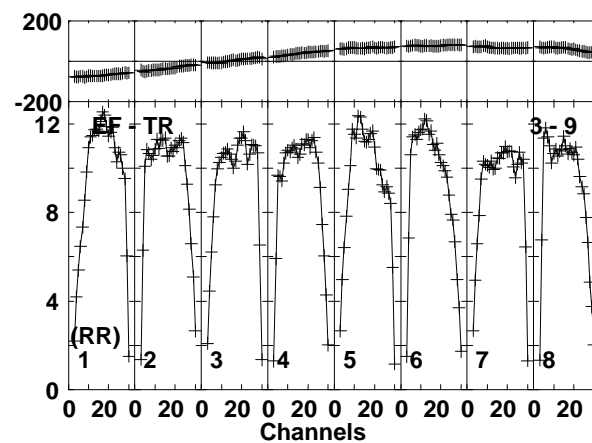
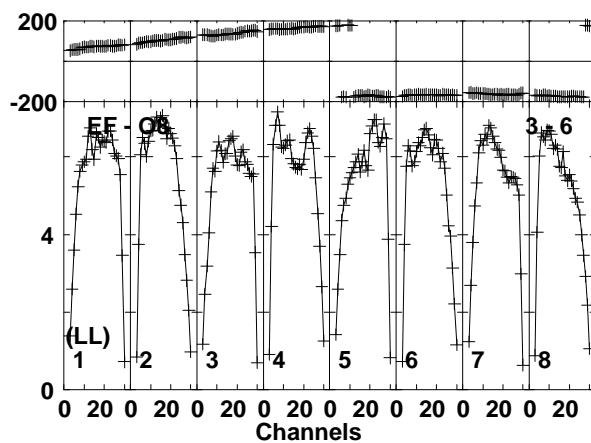
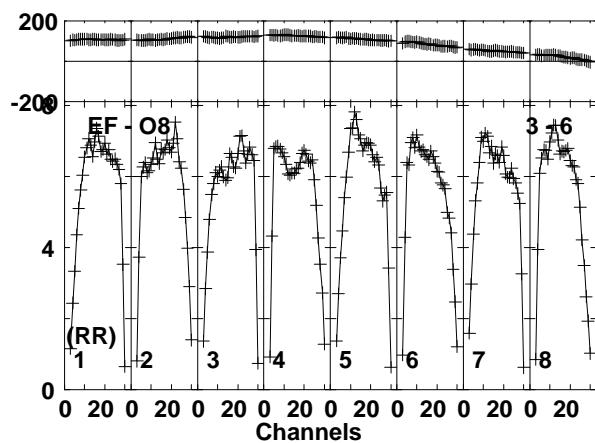
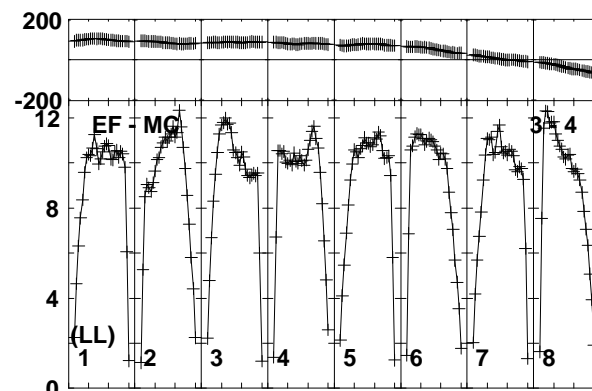
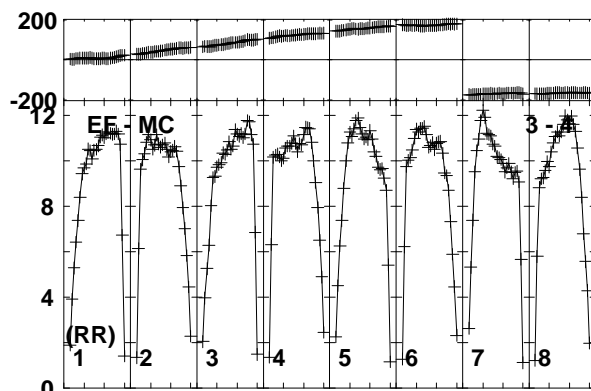
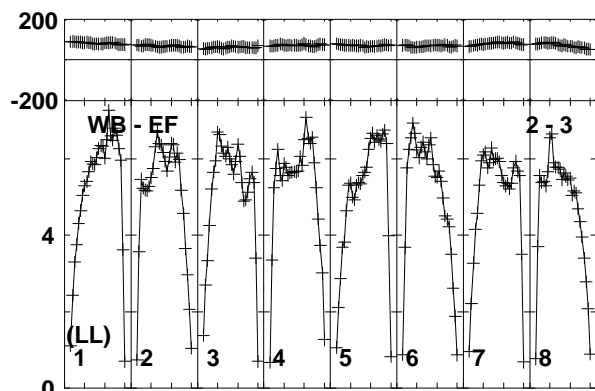
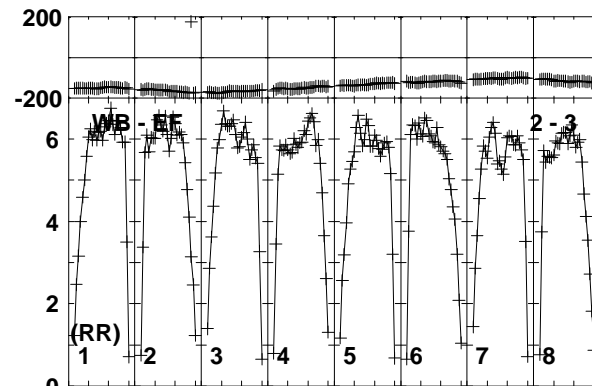
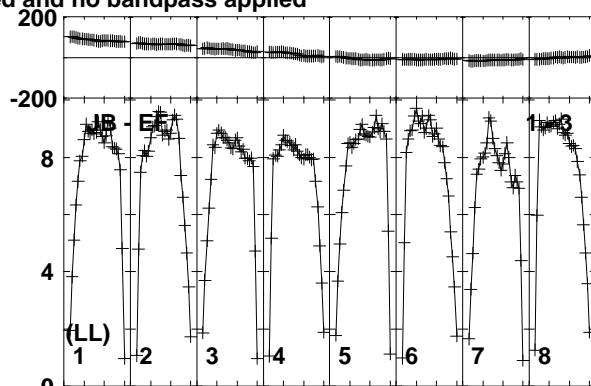
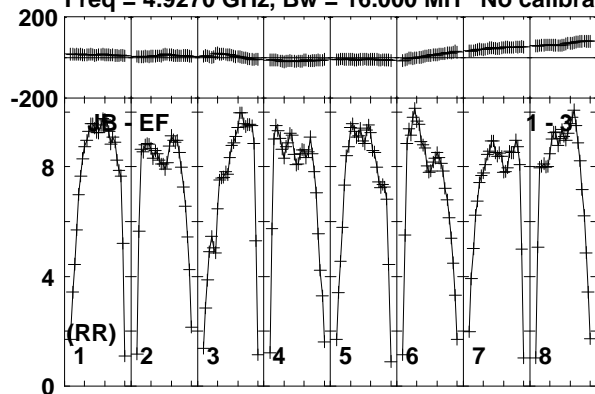

Lower frame: Milli Ampl Jy Top frame: Phas deg  
Vector averaged cross-power spectrum Baseline: JB (01) - EF (03)  
Timerange: 00/12:49:31 to 00/12:50:29

Plot file version 473 created 19-DEC-2018 17:58:48

J1619+2247 RY007C.UVDATA.1

Freq = 4.9270 GHz, Bw = 16.000 MH No calibration applied and no bandpass applied

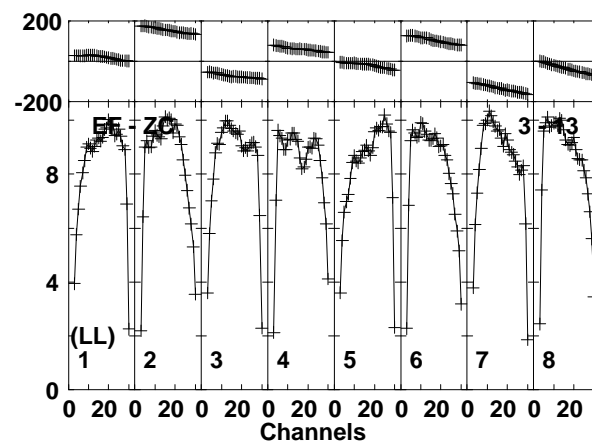
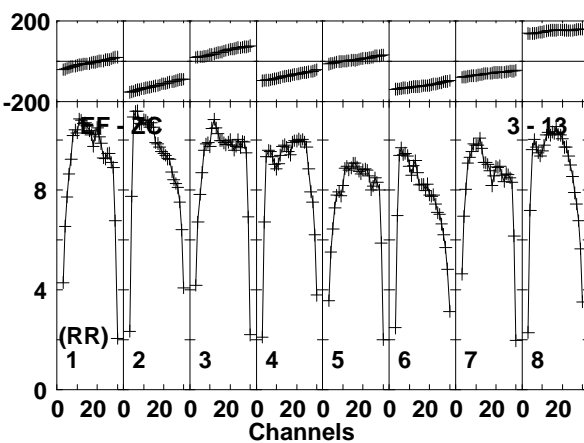
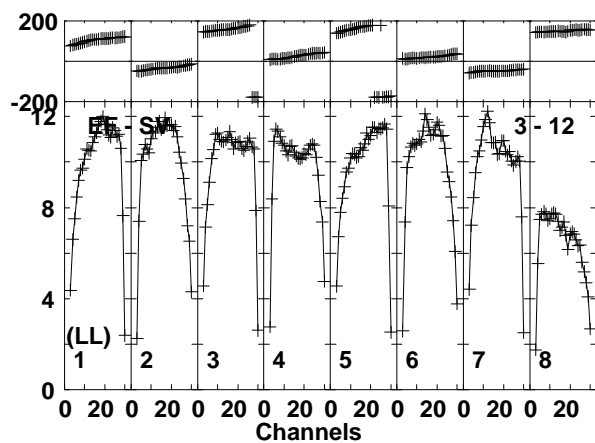
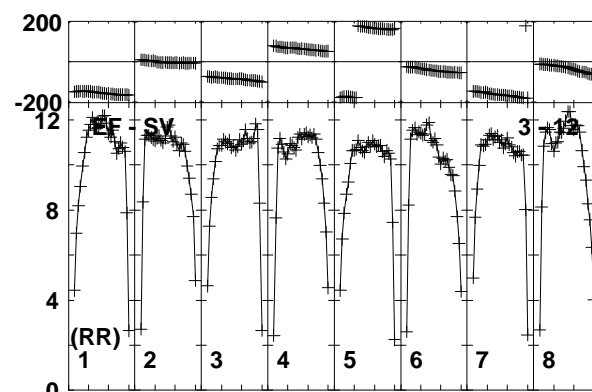
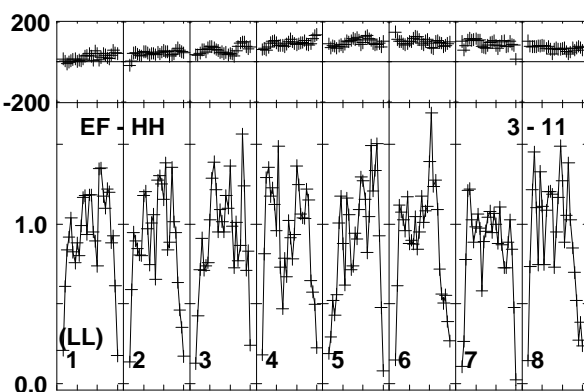
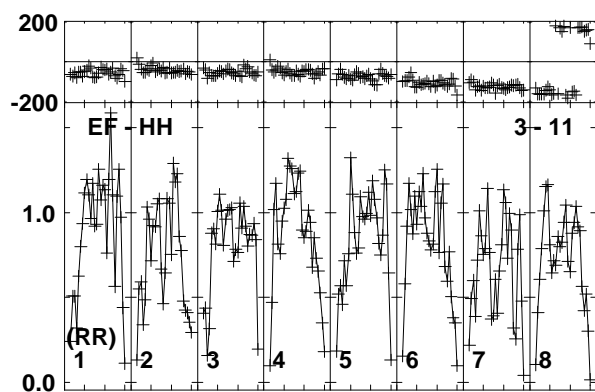
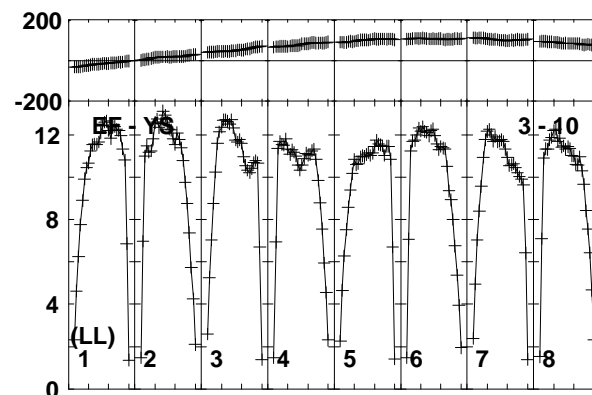
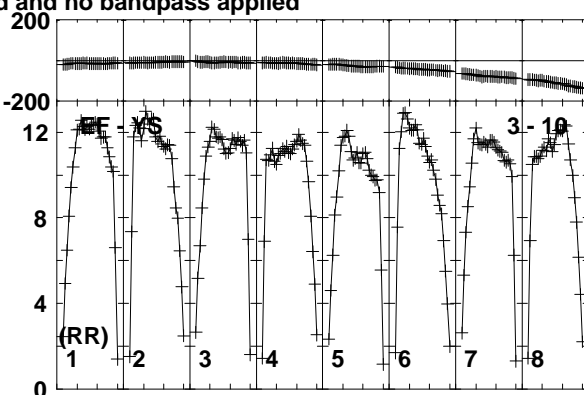
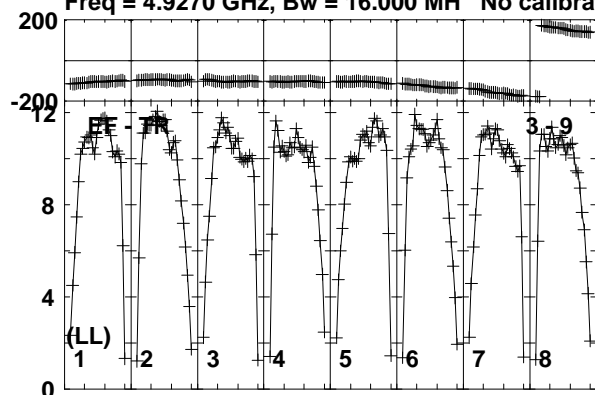

Lower frame: Milli Ampl Jy Top frame: Phas deg  
Vector averaged cross-power spectrum Baseline: EF (03) - TR (09)  
Timerange: 00:12:49:31 to 00:12:50:29

Plot file version 474 created 19-DEC-2018 17:58:48

J1619+2247 RY007C.UVDATA.1

Freq = 4.9270 GHz, Bw = 16.000 MH No calibration applied and no bandpass applied

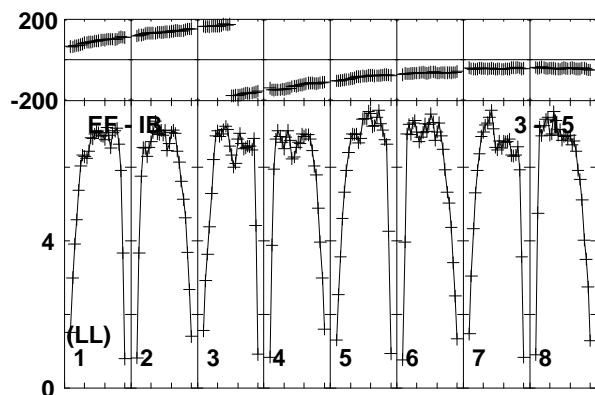
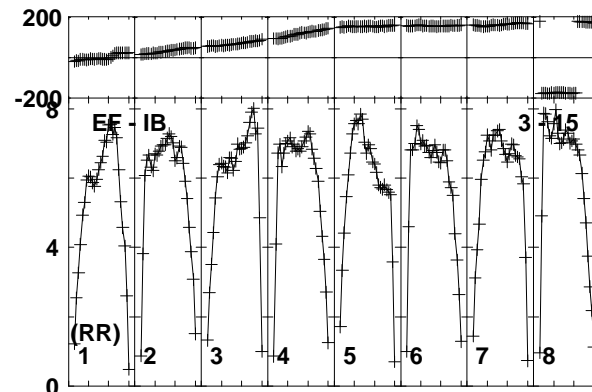
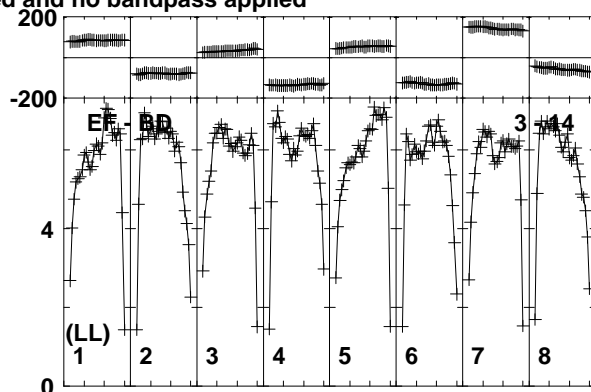
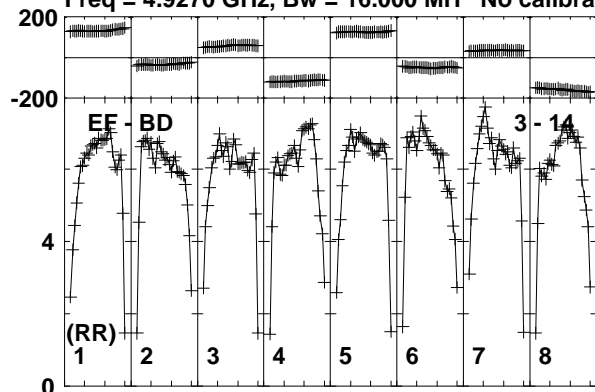

Lower frame: Milli Ampl Jy Top frame: Phas deg  
Vector averaged cross-power spectrum Baseline: EF (03) - BD (14)  
Timerange: 00:12:49:31 to 00:12:50:29



Plot file version 475 created 19-DEC-2018 17:58:48

AT2018\_RY007C.UVDATA.1

Freq = 4.9270 GHz, Bw = 16.000 MH No calibration applied and no bandpass applied

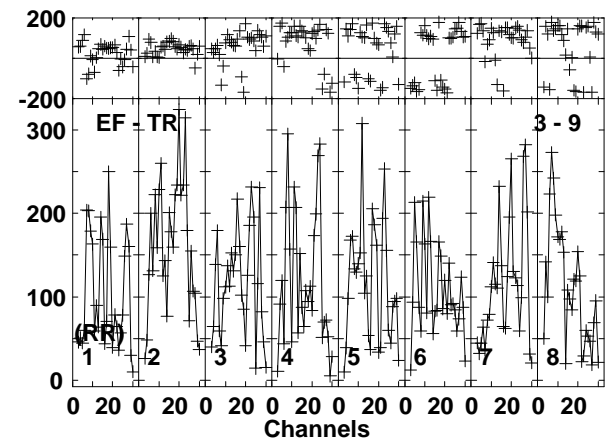
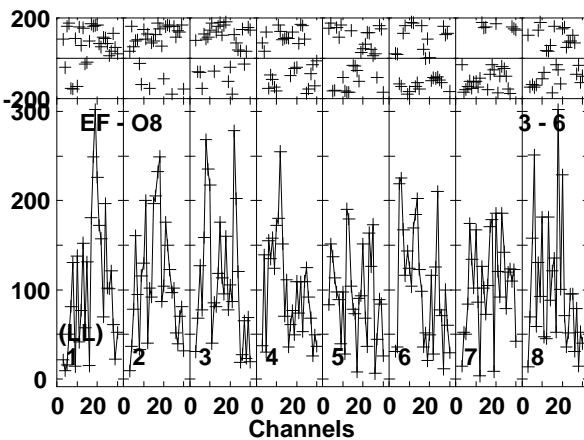
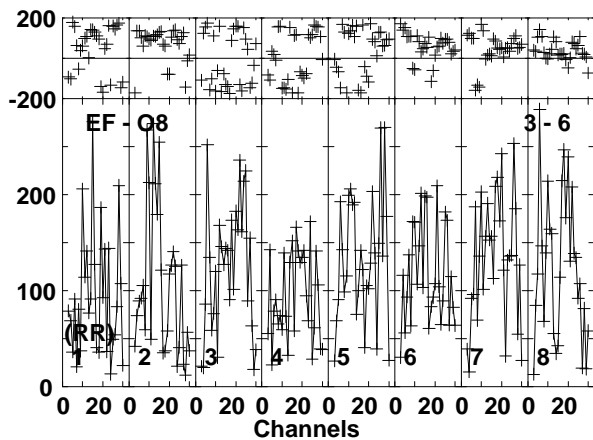
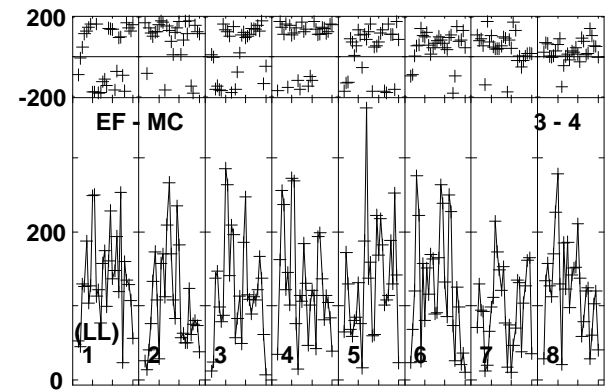
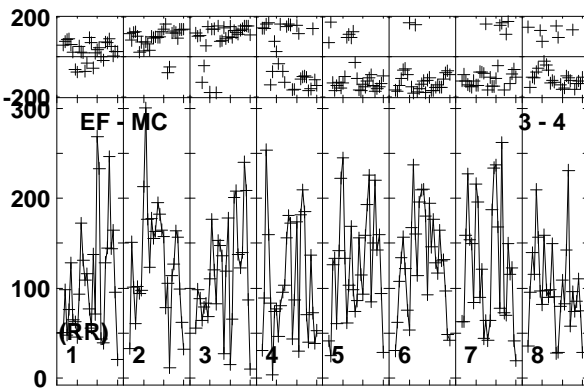
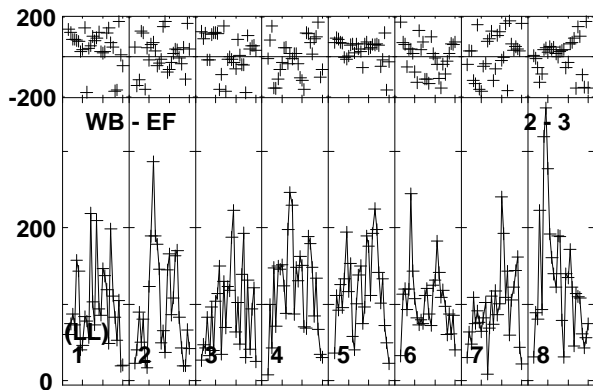
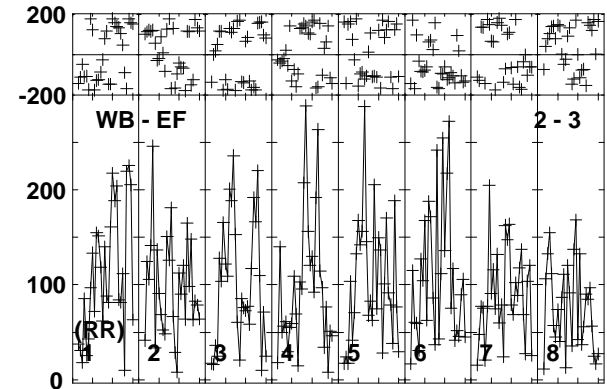
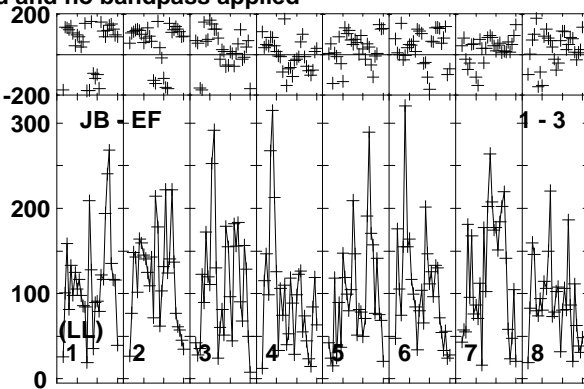
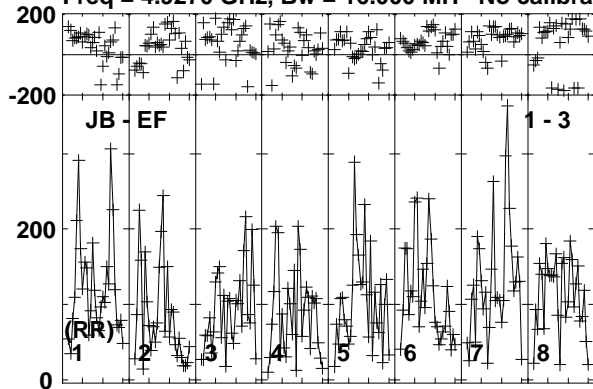

Lower frame: Micro Ampl Jy Top frame: Phas deg  
Vector averaged cross-power spectrum Baseline: JB (01) - EF (03)  
Timerange: 00/12:50:31 to 00/12:53:29

Plot file version 476 created 19-DEC-2018 17:58:48

AT2018\_RY007C.UVDATA.1

Freq = 4.9270 GHz, Bw = 16.000 MH No calibration applied and no bandpass applied

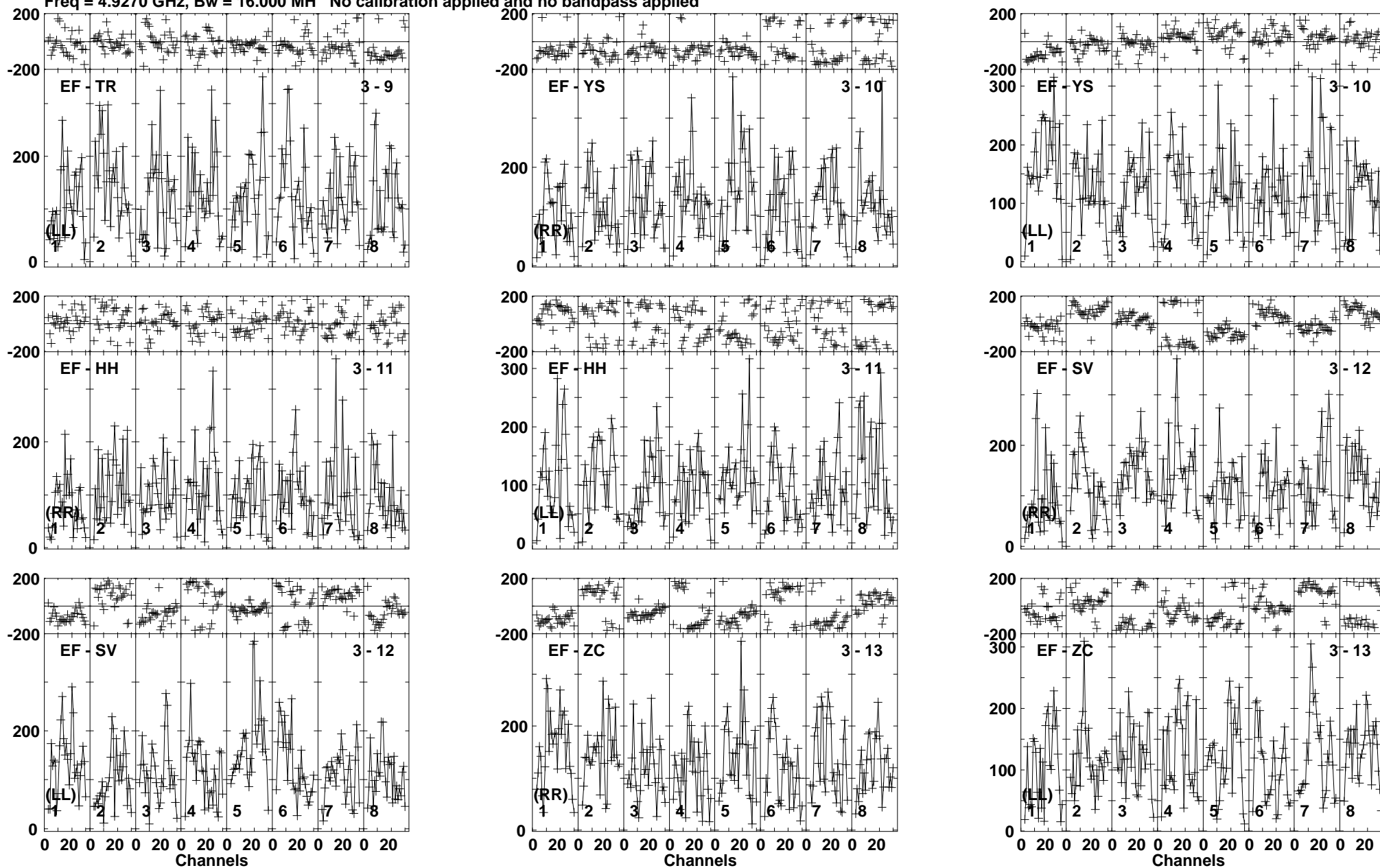

Lower frame: Micro Ampl Jy Top frame: Phas deg  
Vector averaged cross-power spectrum Baseline: EF (03) - TR (09)  
Timerange: 00:12:50:31 to 00:12:53:29

Plot file version 477 created 19-DEC-2018 17:58:48

AT2018\_RY007C.UVDATA.1

Freq = 4.9270 GHz, Bw = 16.000 MH No calibration applied and no bandpass applied

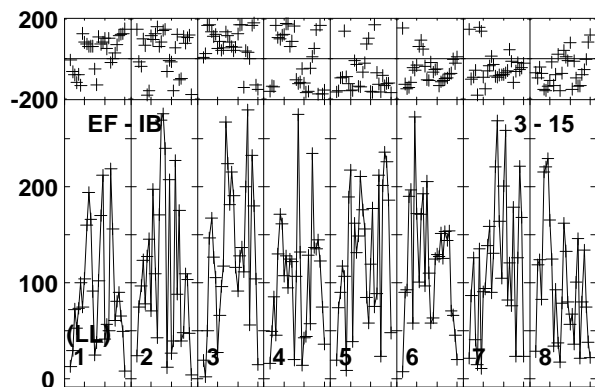
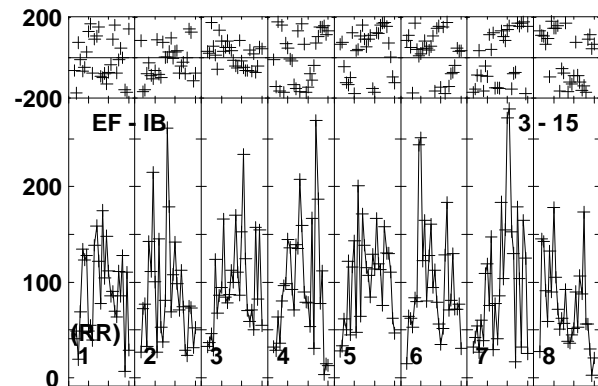
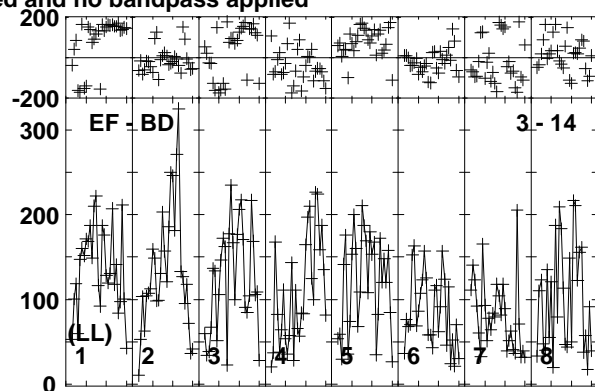
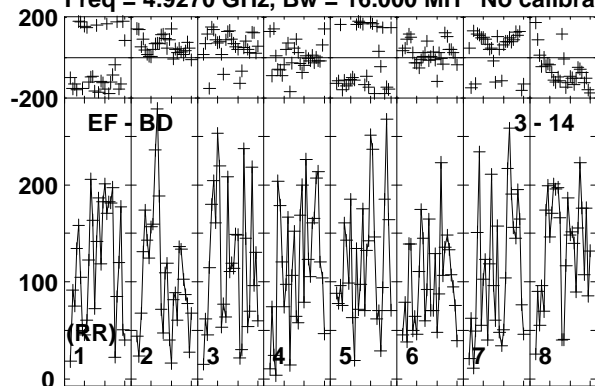

Lower frame: Micro Ampl Jy Top frame: Phas deg  
Vector averaged cross-power spectrum Baseline: EF (03) - BD (14)  
Timerange: 00/12:50:31 to 00/12:53:29

Plot file version 478 created 19-DEC-2018 17:58:48

J1619+2247 RY007C.UVDATA.1

Freq = 4.9270 GHz, Bw = 16.000 MH No calibration applied and no bandpass applied

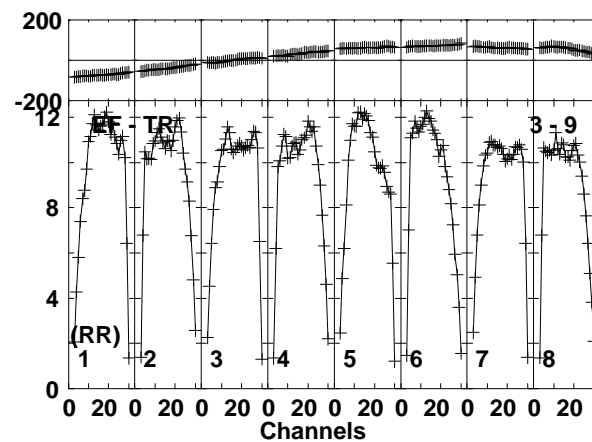
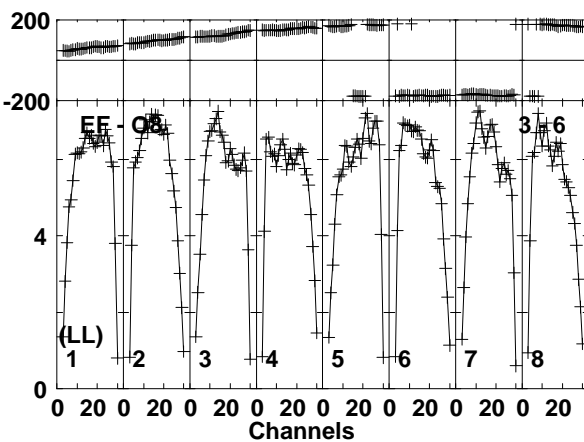
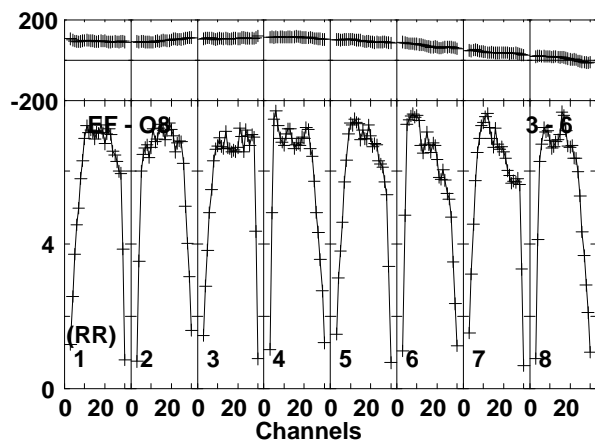
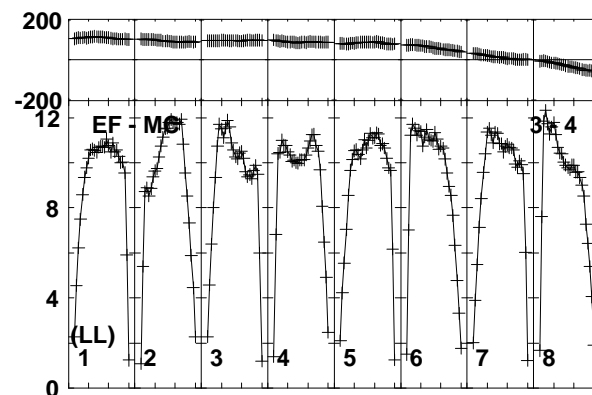
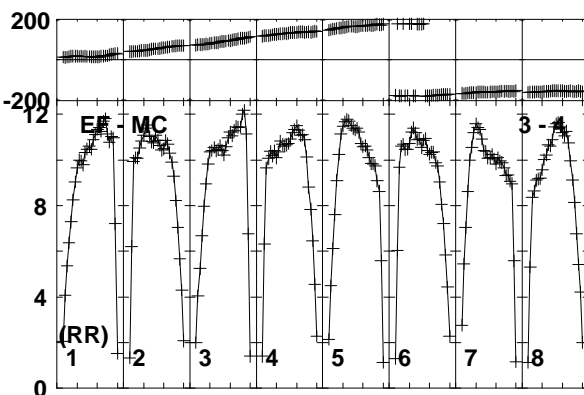
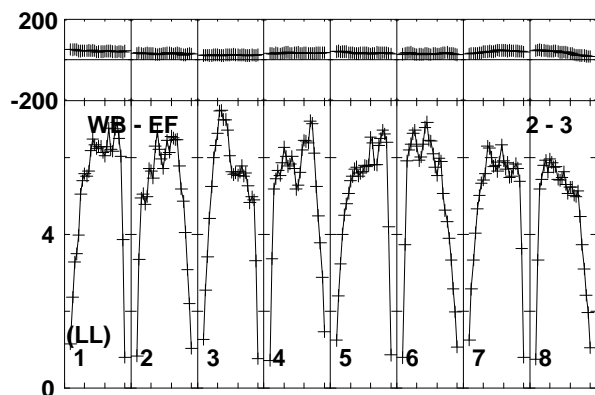
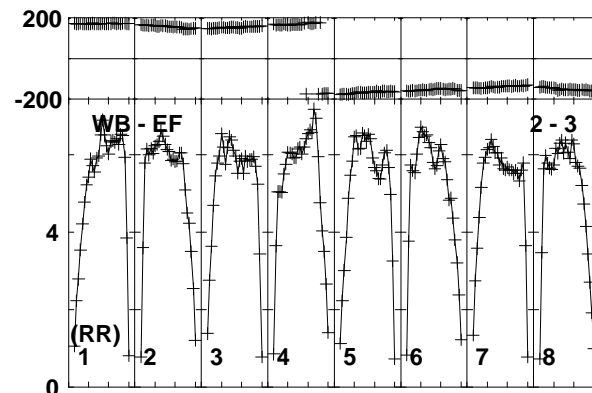
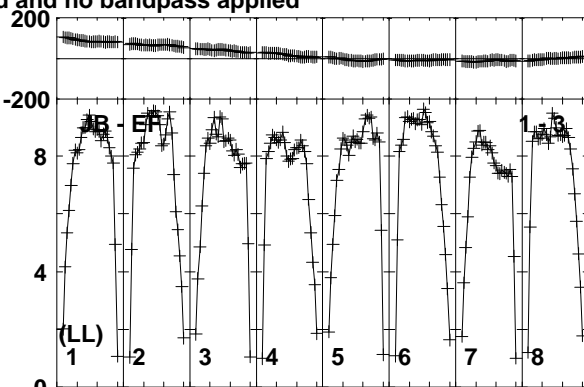
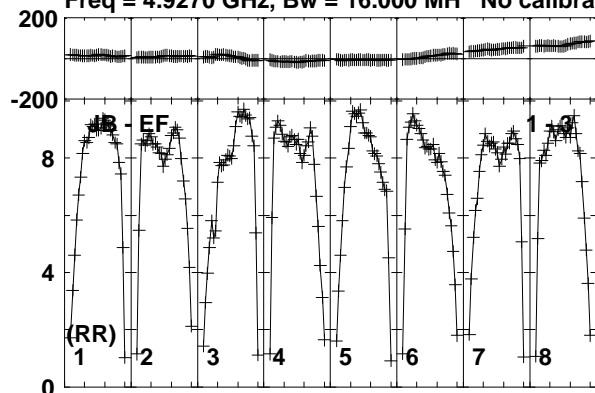

Lower frame: Milli Ampl Jy Top frame: Phas deg  
Vector averaged cross-power spectrum Baseline: JB (01) - EF (03)  
Timerange: 00:12:53:31 to 00:12:54:29

Plot file version 479 created 19-DEC-2018 17:58:48

J1619+2247 RY007C.UVDATA.1

Freq = 4.9270 GHz, Bw = 16.000 MH No calibration applied and no bandpass applied

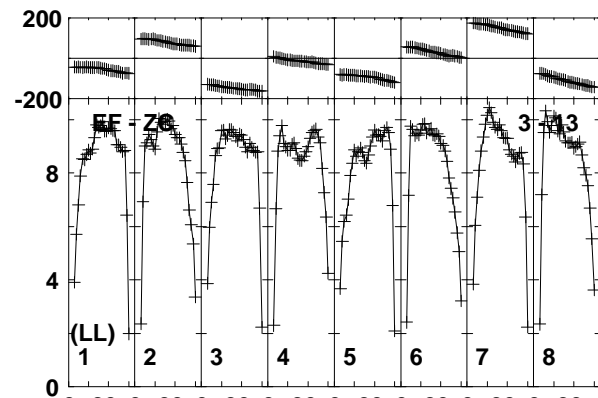
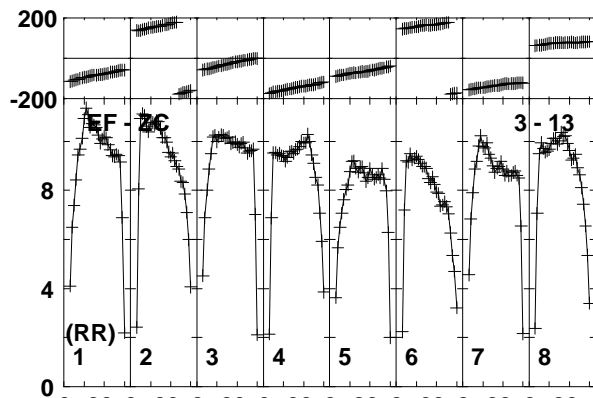
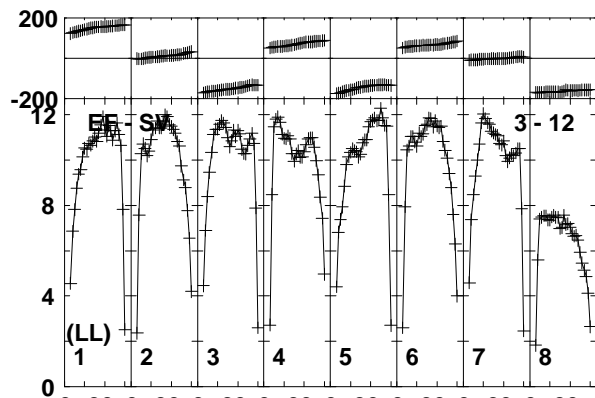
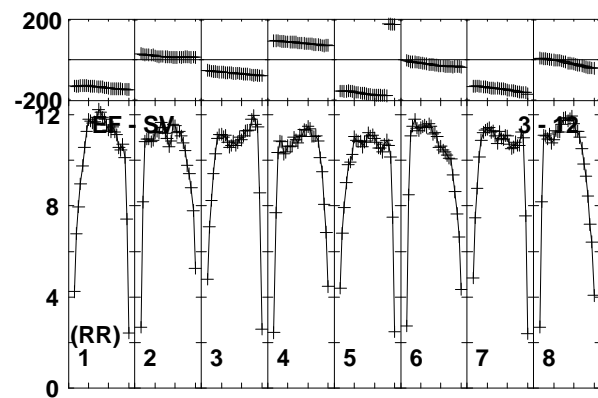
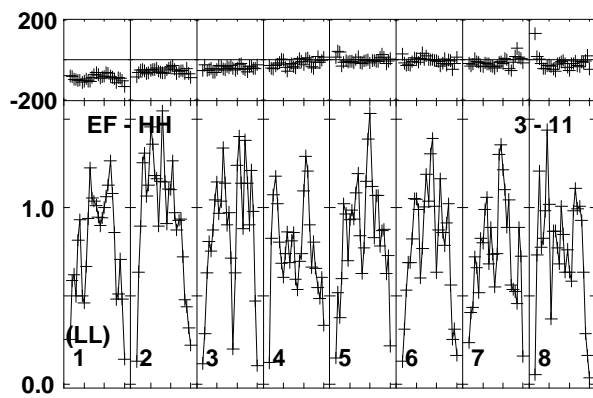
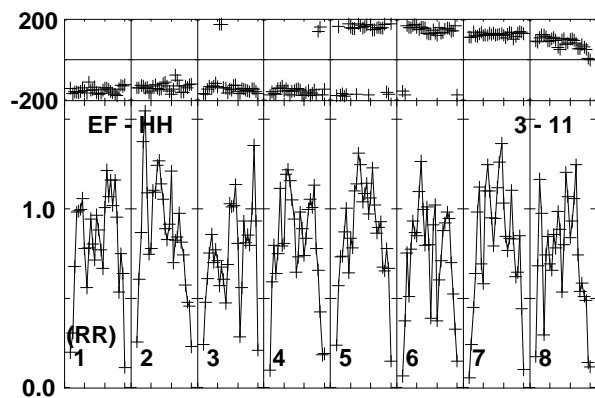
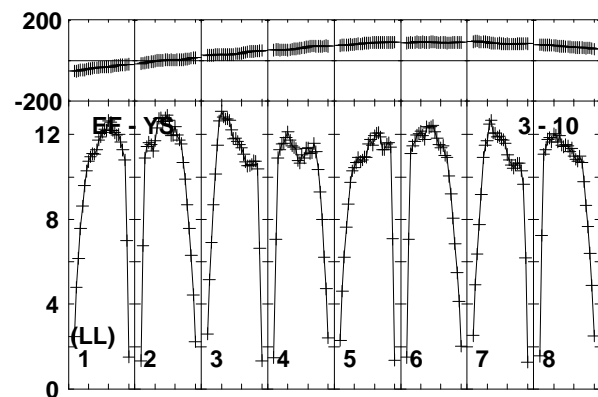
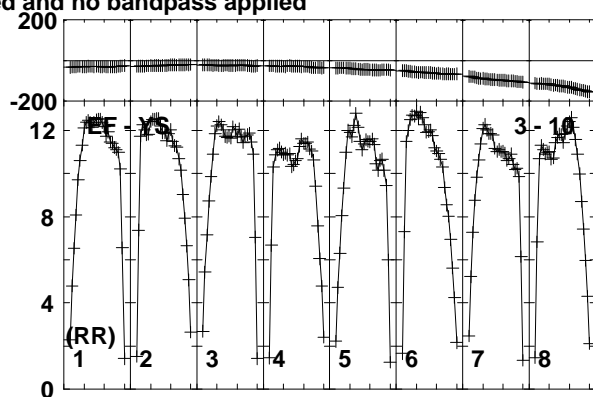
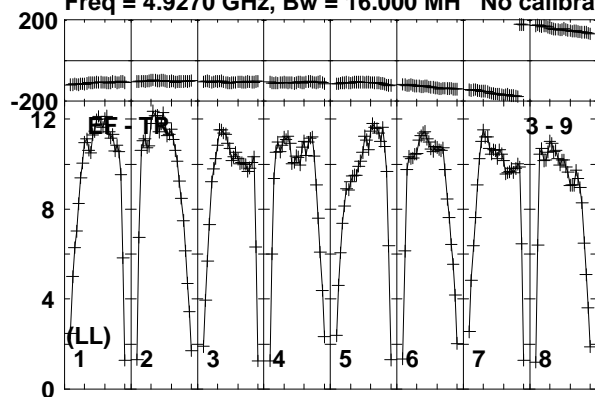

Lower frame: Milli Ampl Jy Top frame: Phas deg  
Vector averaged cross-power spectrum Baseline: EF (03) - TR (09)  
Timerange: 00:12:53:31 to 00:12:54:29

Plot file version 480 created 19-DEC-2018 17:58:48

J1619+2247 RY007C.UVDATA.1

Freq = 4.9270 GHz, Bw = 16.000 MH No calibration applied and no bandpass applied

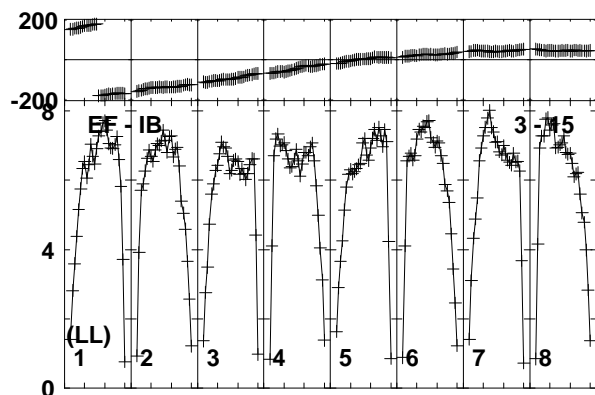
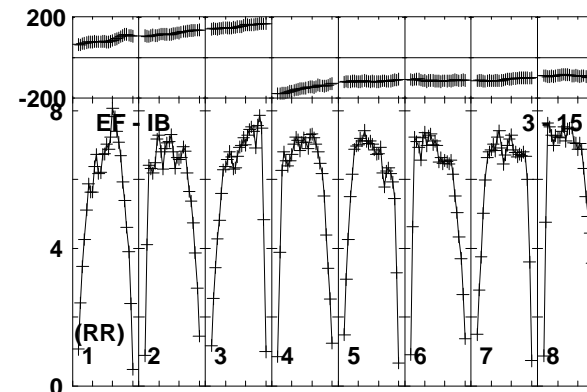
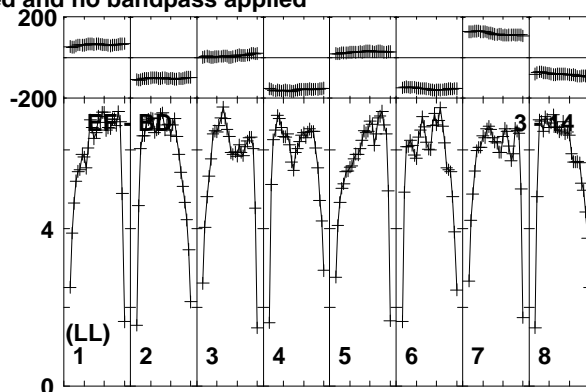
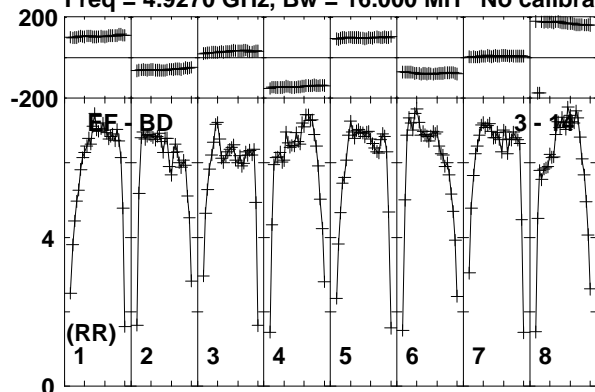

Lower frame: Milli Ampl Jy Top frame: Phas deg  
Vector averaged cross-power spectrum Baseline: EF (03) - BD (14)  
Timerange: 00/12:53:31 to 00/12:54:29

Plot file version 481 created 19-DEC-2018 17:58:48

VLA1 RY007C.UVDATA.1

Freq = 4.9270 GHz, Bw = 16.000 MH No calibration applied and no bandpass applied

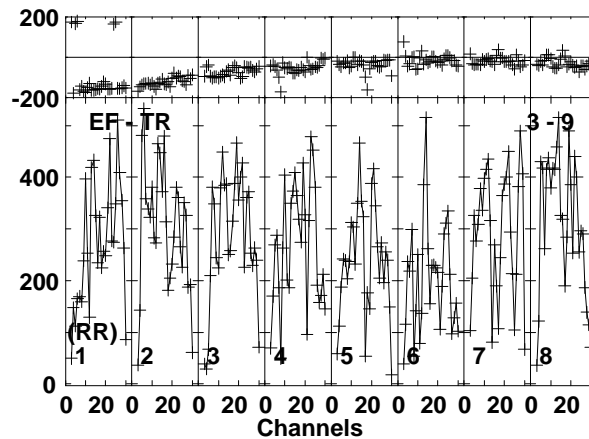
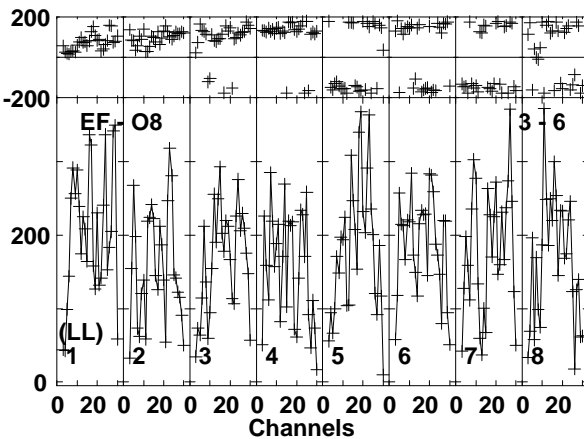
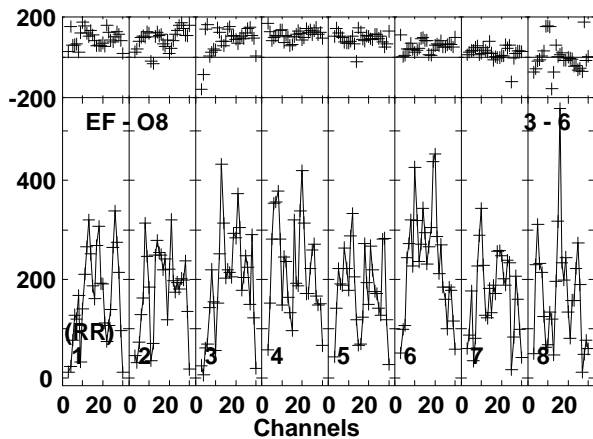
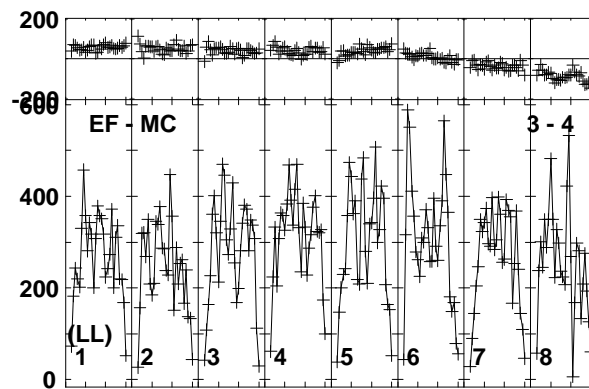
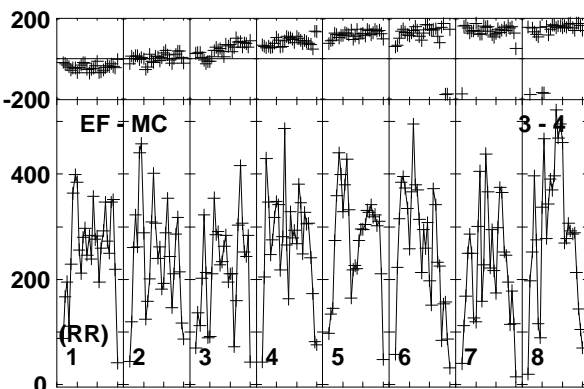
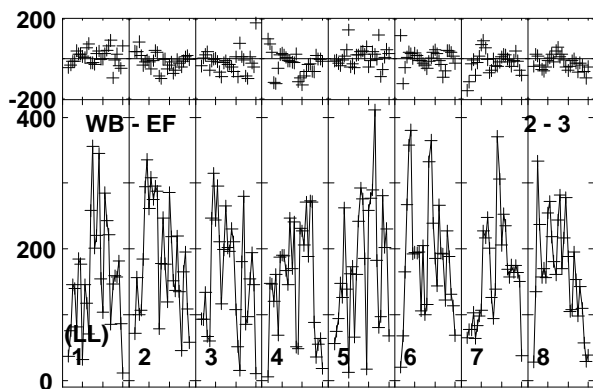
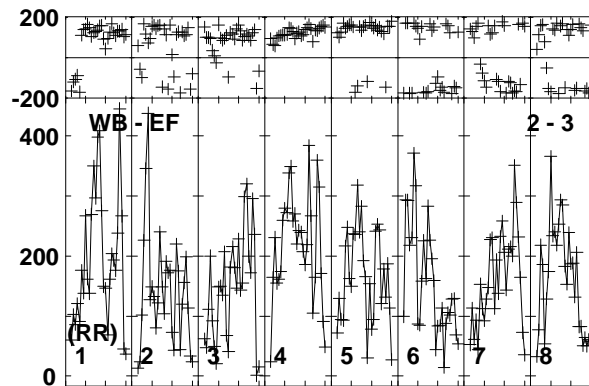
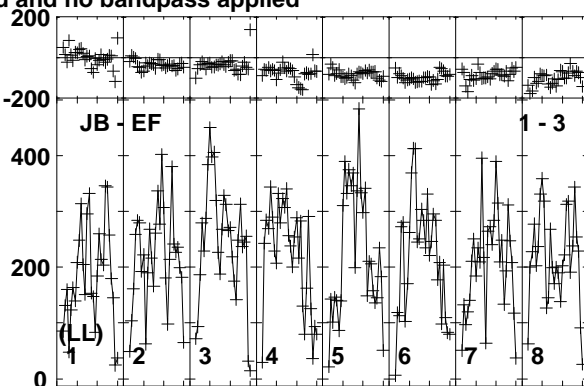
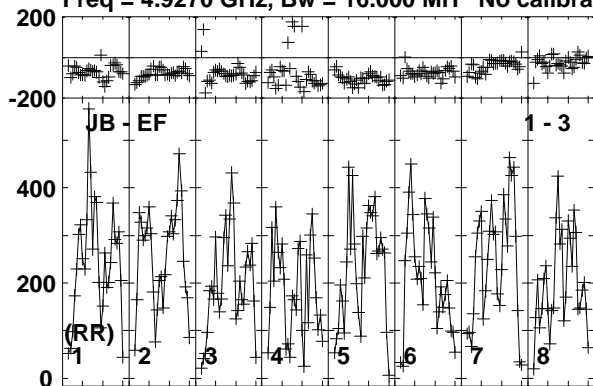

Lower frame: Micro Ampl Jy Top frame: Phas deg  
Vector averaged cross-power spectrum Baseline: JB (01) - EF (03)  
Timerange: 00:12:55:01 to 00:12:56:59

Plot file version 482 created 19-DEC-2018 17:58:48

VLA1 RY007C.UVDATA.1

Freq = 4.9270 GHz, Bw = 16.000 MH No calibration applied and no bandpass applied

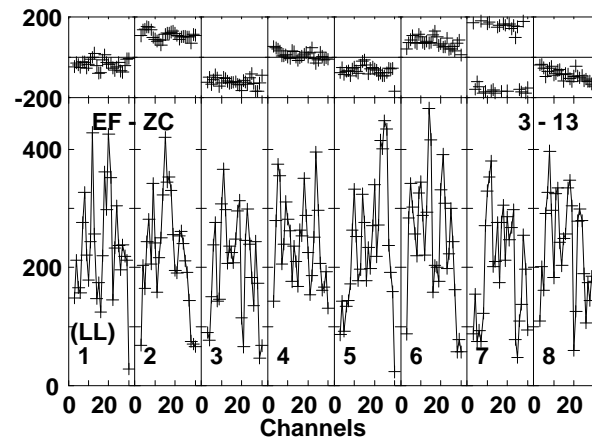
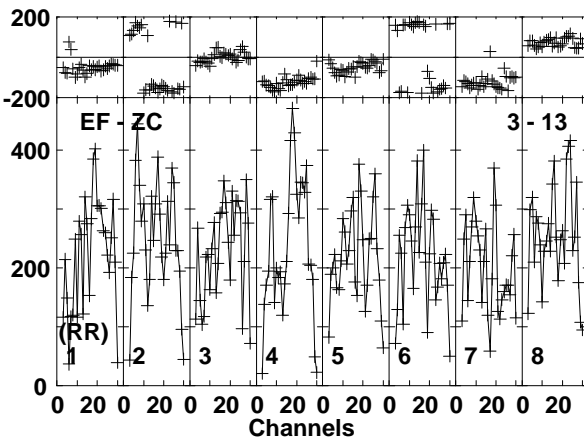
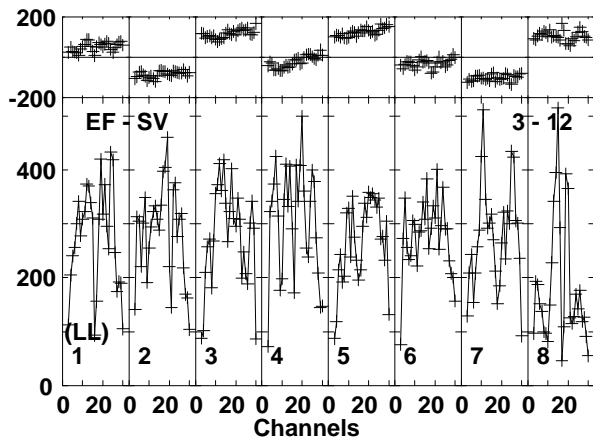
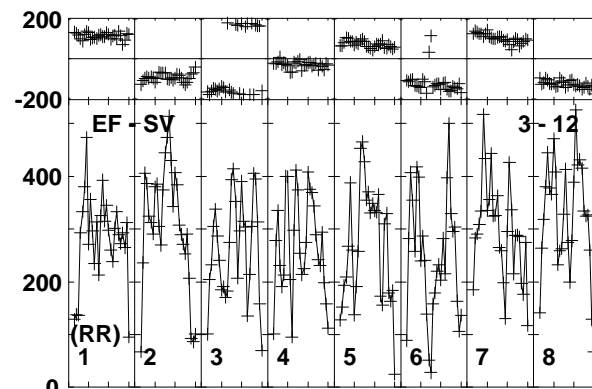
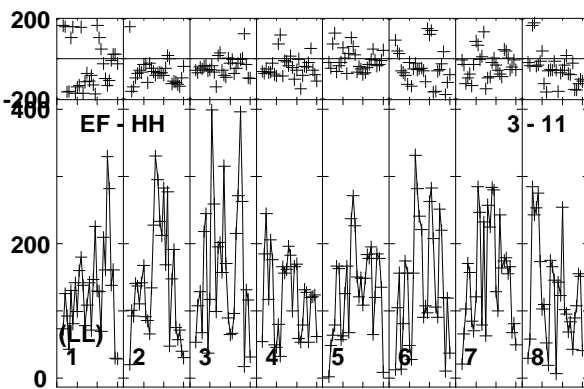
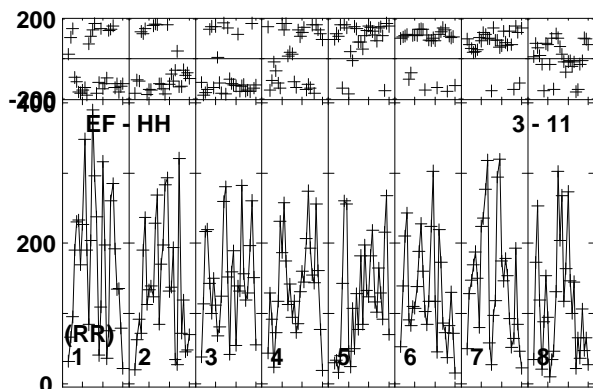
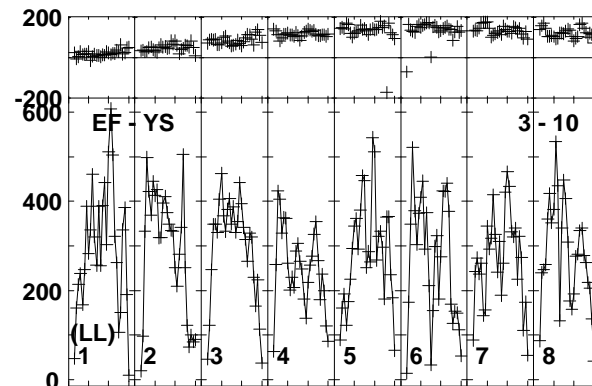
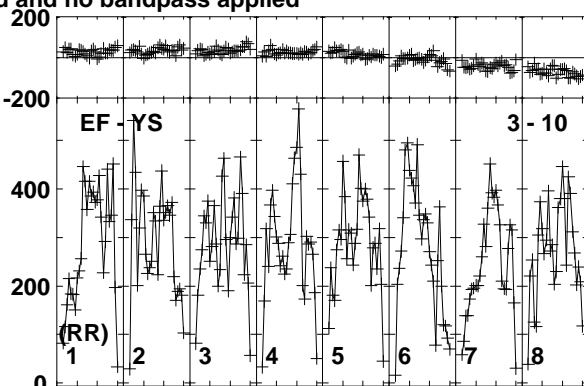
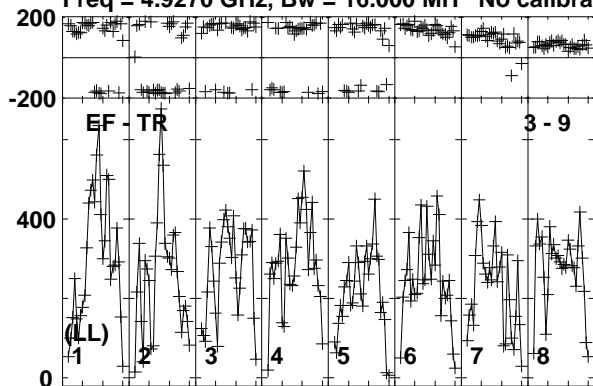

Lower frame: Micro Ampl Jy Top frame: Phas deg  
Vector averaged cross-power spectrum Baseline: EF (03) - TR (09)  
Timerange: 00/12:55:01 to 00/12:56:59



Plot file version 483 created 19-DEC-2018 17:58:48

VLA1 RY007C.UVDATA.1

Freq = 4.9270 GHz, Bw = 16.000 MH No calibration applied and no bandpass applied

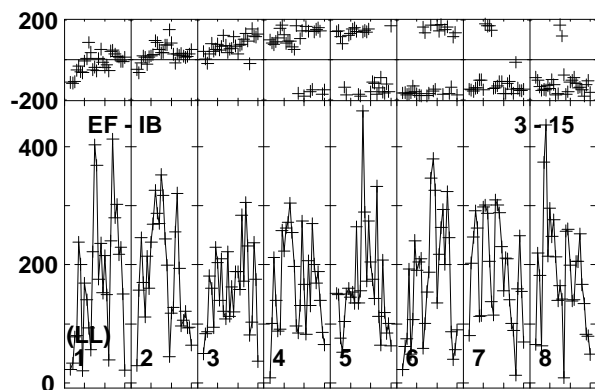
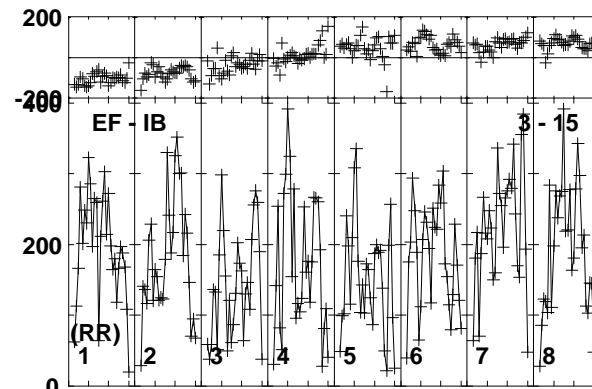
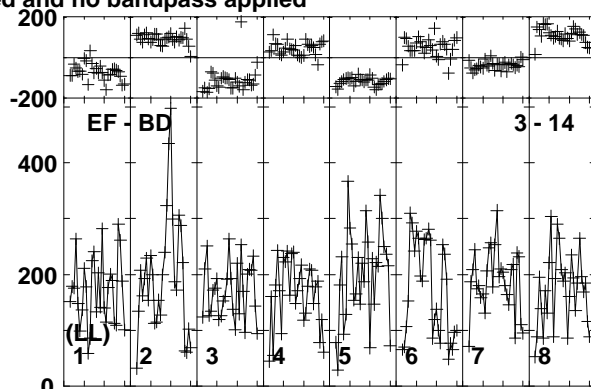
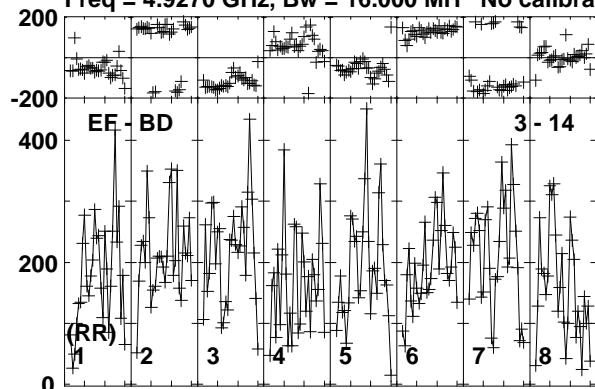

Lower frame: Micro Ampl Jy Top frame: Phas deg  
Vector averaged cross-power spectrum Baseline: EF (03) - BD (14)  
Timerange: 00/12:55:01 to 00/12:56:59

Plot file version 484 created 19-DEC-2018 17:58:48

J1619+2247 RY007C.UVDATA.1

Freq = 4.9270 GHz, Bw = 16.000 MH No calibration applied and no bandpass applied

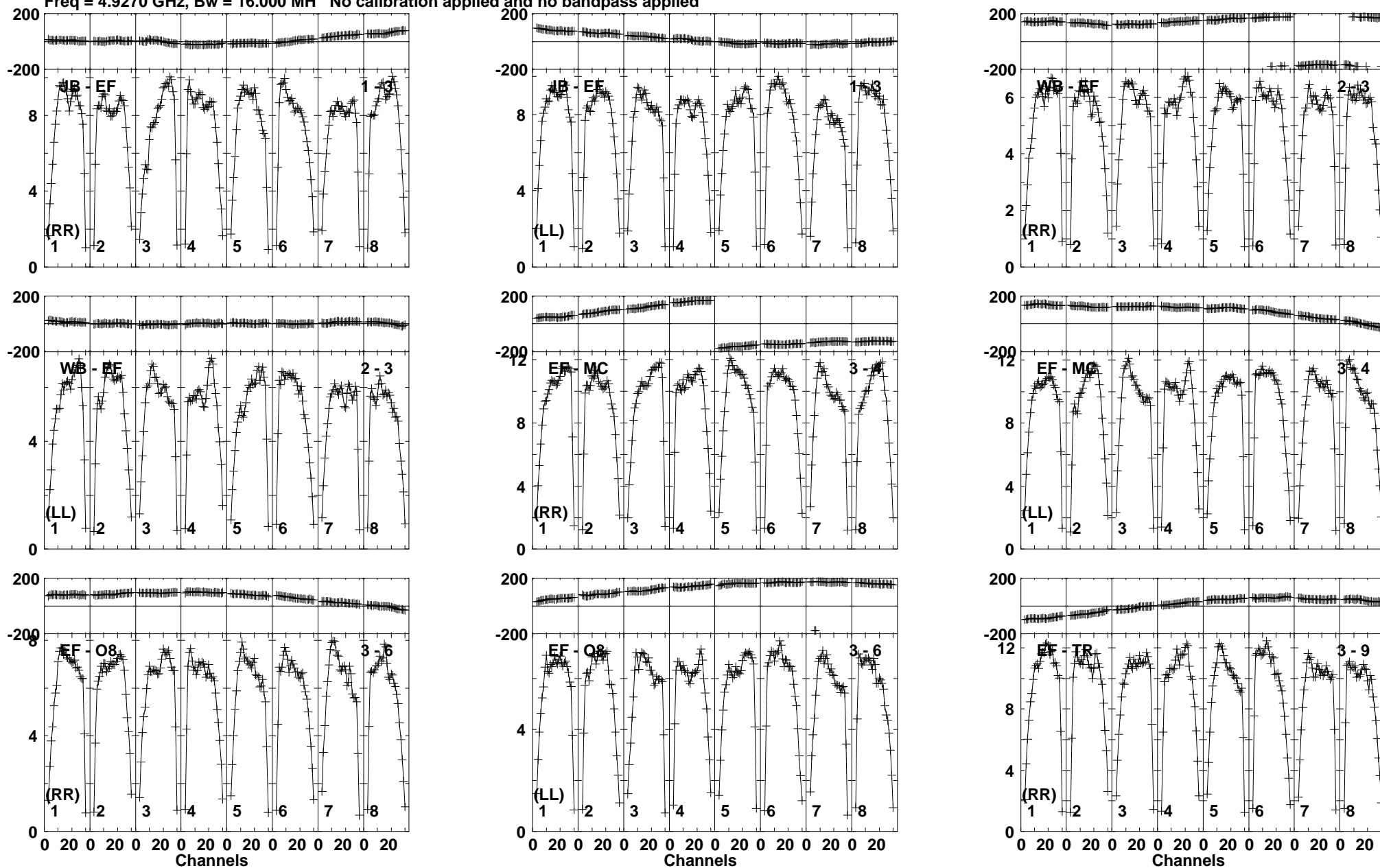

Lower frame: Milli Ampl Jy Top frame: Phas deg  
Vector averaged cross-power spectrum Baseline: JB (01) - EF (03)  
Timerange: 00:12:57:01 to 00:12:57:59

Plot file version 485 created 19-DEC-2018 17:58:48

J1619+2247 RY007C.UVDATA.1

Freq = 4.9270 GHz, Bw = 16.000 MH No calibration applied and no bandpass applied

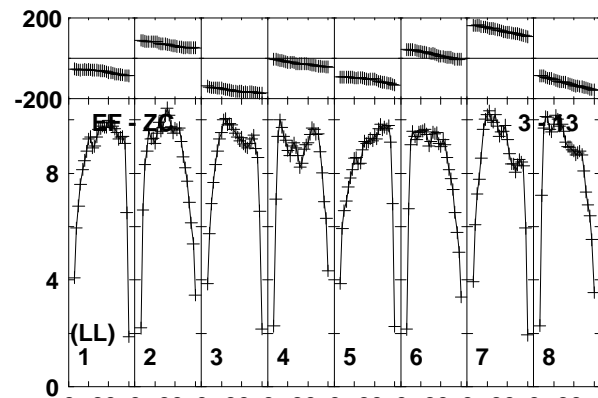
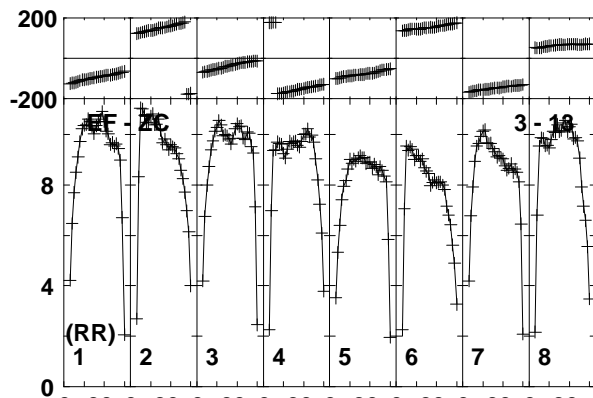
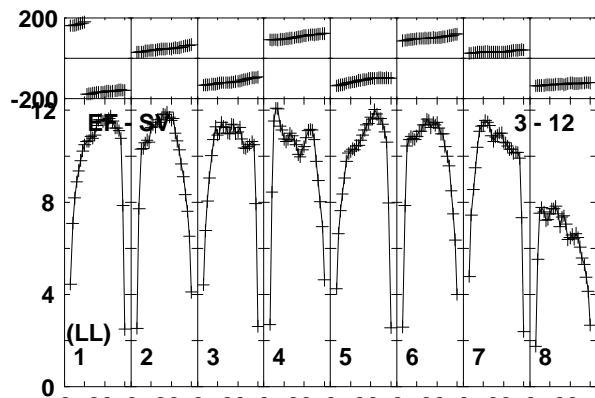
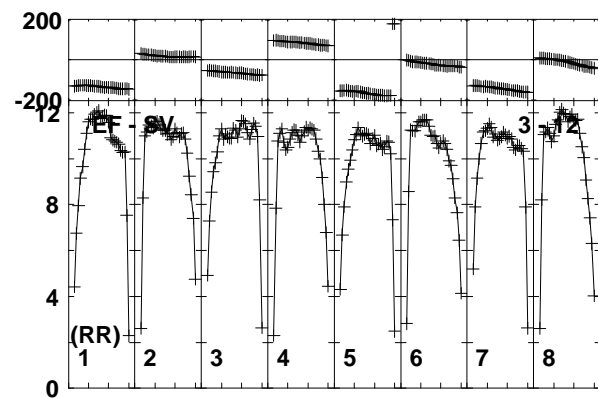
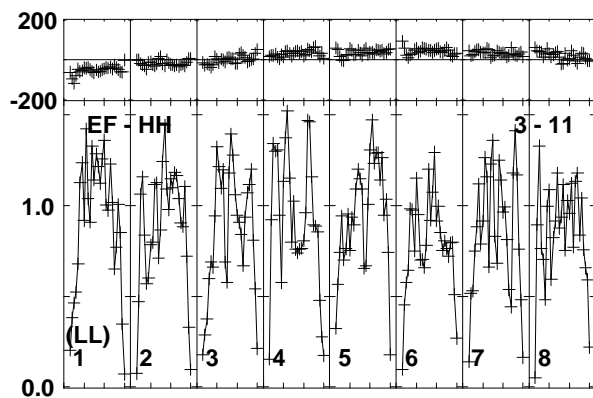
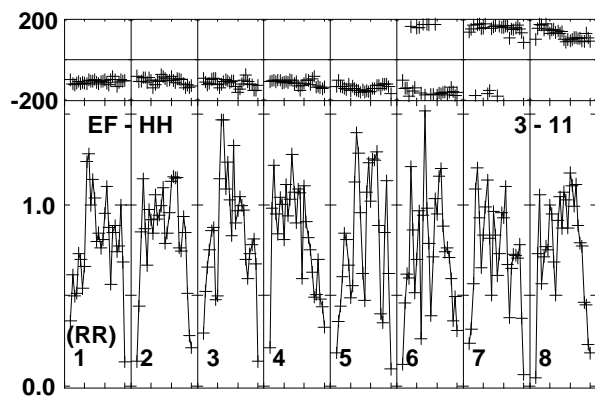
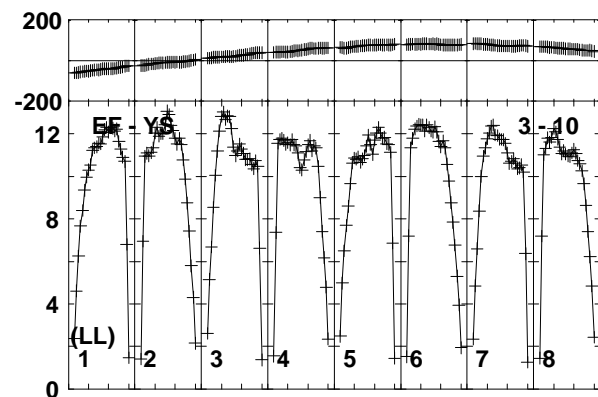
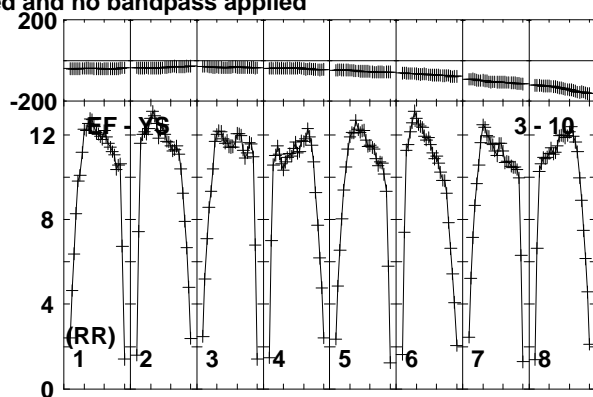
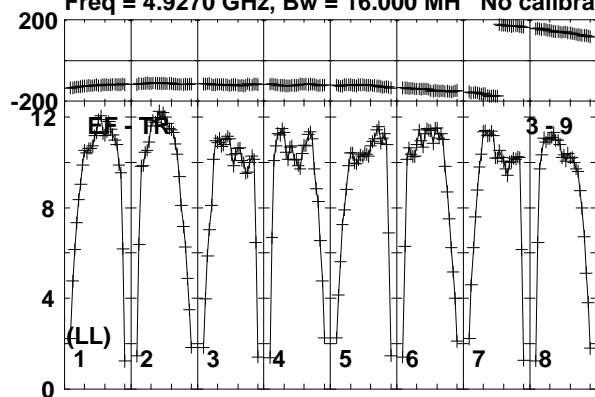

Lower frame: Milli Ampl Jy Top frame: Phas deg  
Vector averaged cross-power spectrum Baseline: EF (03) - TR (09)  
Timerange: 00:12:57:01 to 00:12:57:59

Plot file version 486 created 19-DEC-2018 17:58:48

J1619+2247 RY007C.UVDATA.1

Freq = 4.9270 GHz, Bw = 16.000 MH No calibration applied and no bandpass applied

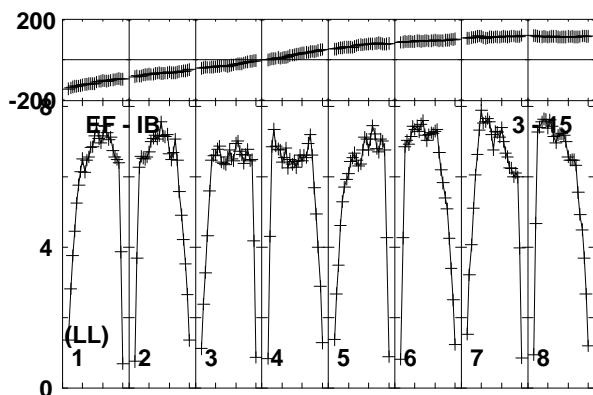
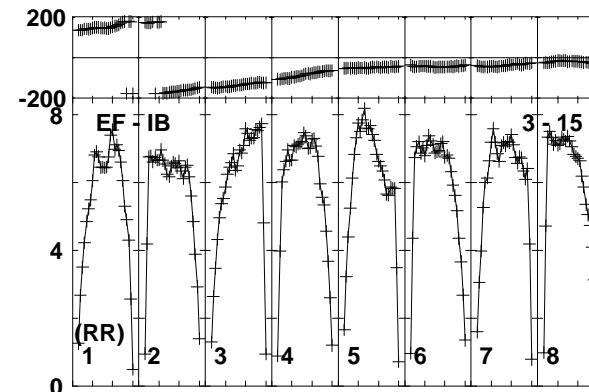
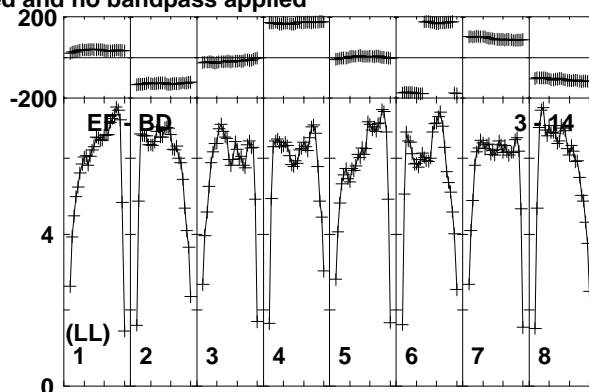
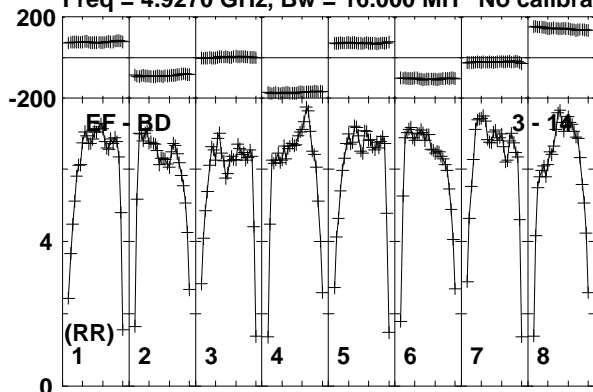

Lower frame: Milli Ampl Jy Top frame: Phas deg  
Vector averaged cross-power spectrum Baseline: EF (03) - BD (14)  
Timerange: 00:12:57:01 to 00:12:57:59

Plot file version 487 created 19-DEC-2018 17:58:48

AT2018\_RY007C.UVDATA.1

Freq = 4.9270 GHz, Bw = 16.000 MH No calibration applied and no bandpass applied

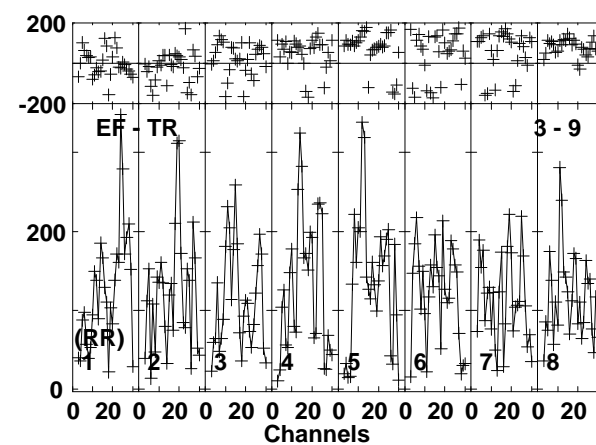
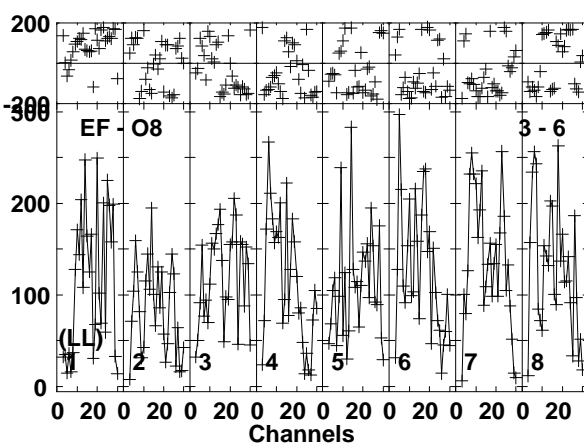
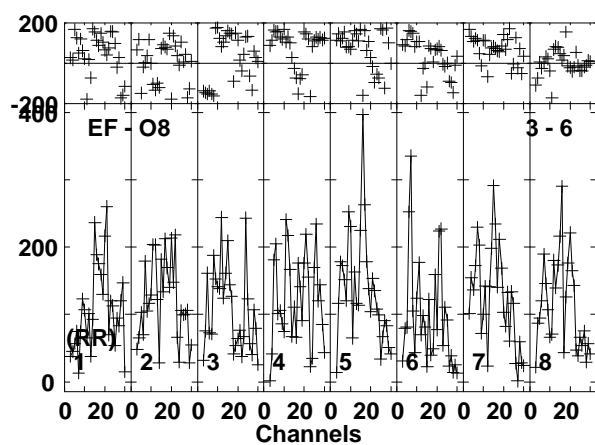
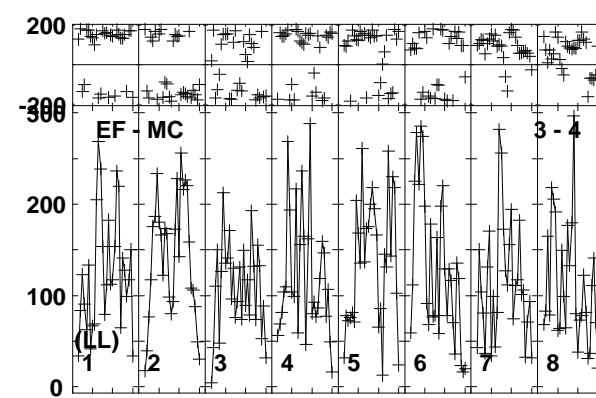
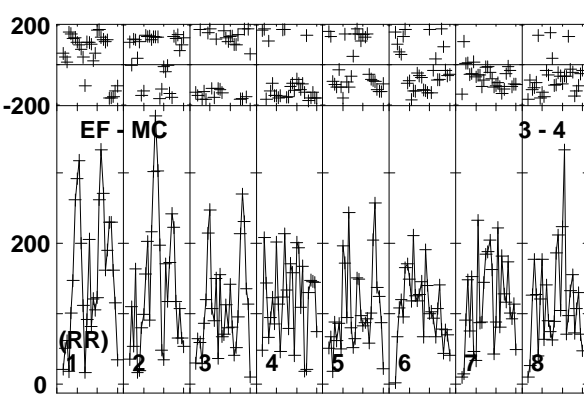
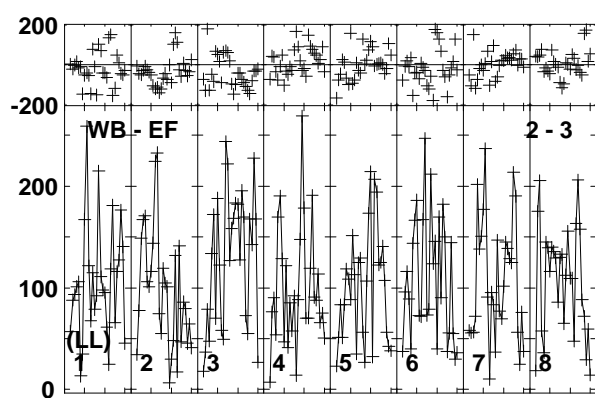
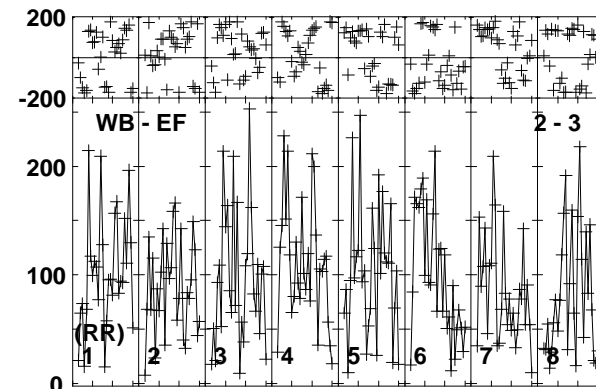
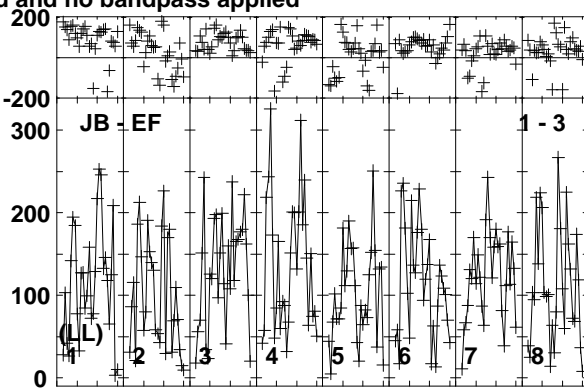
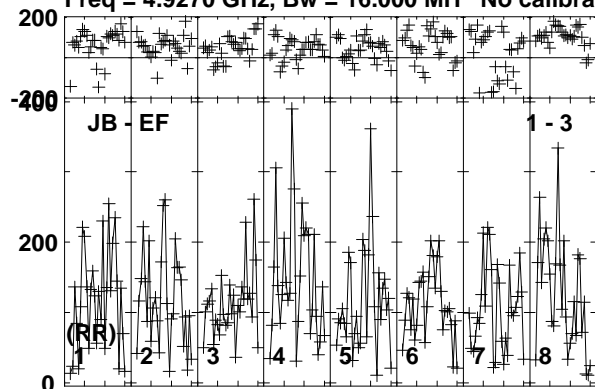

Lower frame: Micro Ampl Jy Top frame: Phas deg  
Vector averaged cross-power spectrum Baseline: JB (01) - EF (03)  
Timerange: 00/12:58:01 to 00/13:00:59

Plot file version 488 created 19-DEC-2018 17:58:48

AT2018\_RY007C.UVDATA.1

Freq = 4.9270 GHz, Bw = 16.000 MH No calibration applied and no bandpass applied

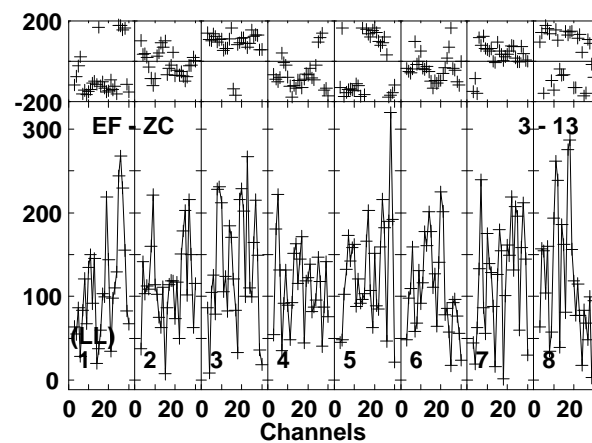
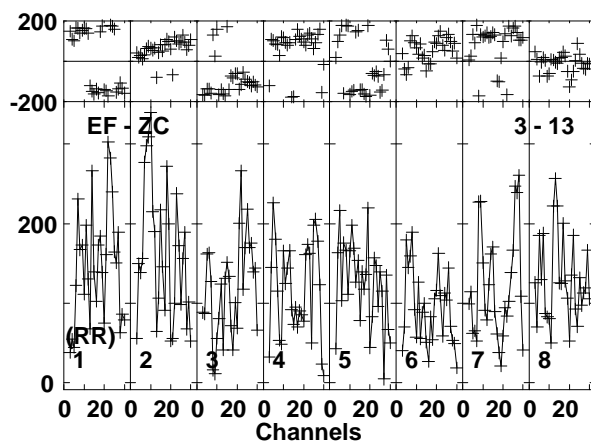
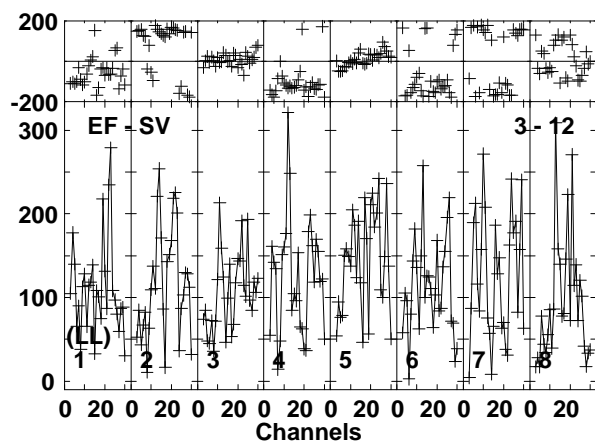
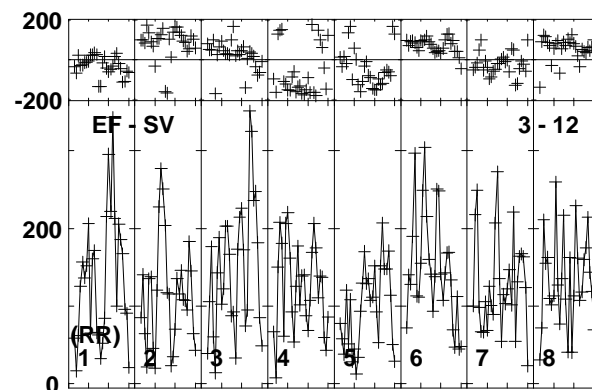
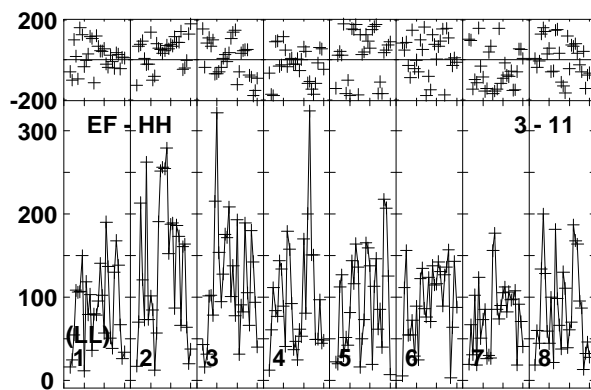
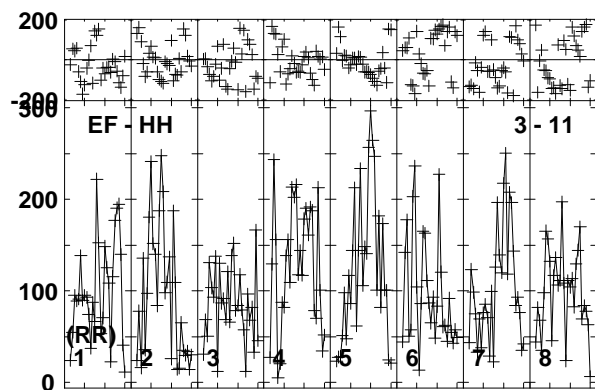
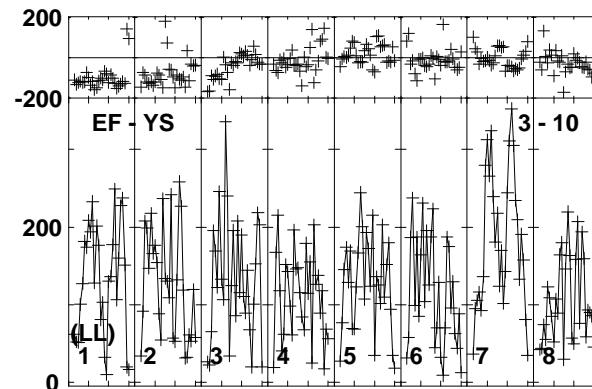
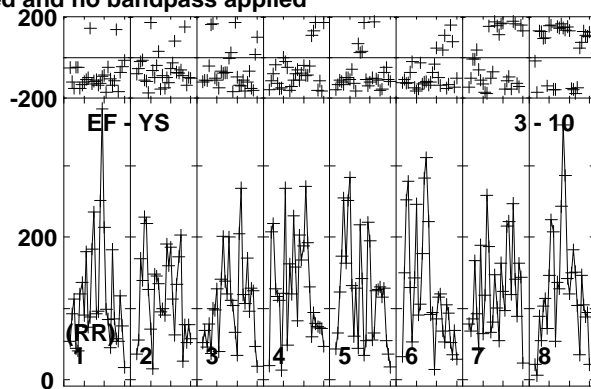
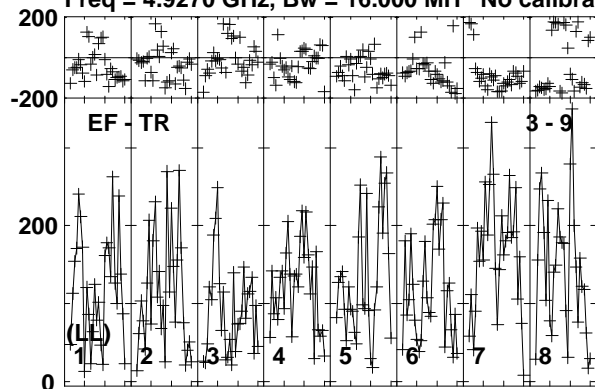

Lower frame: Micro Ampl Jy Top frame: Phas deg  
Vector averaged cross-power spectrum Baseline: EF (03) - TR (09)  
Timerange: 00/12:58:01 to 00/13:00:59

Plot file version 489 created 19-DEC-2018 17:58:48

AT2018\_RY007C.UVDATA.1

Freq = 4.9270 GHz, Bw = 16.000 MH No calibration applied and no bandpass applied

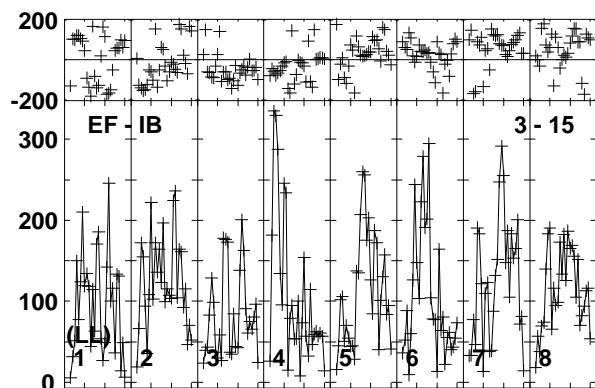
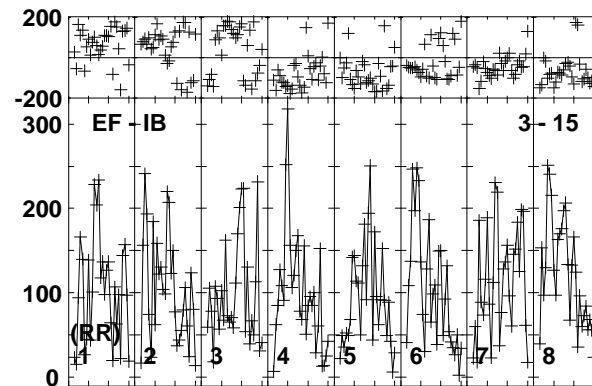
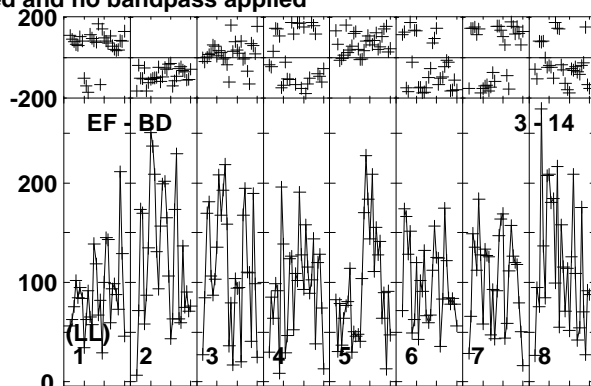
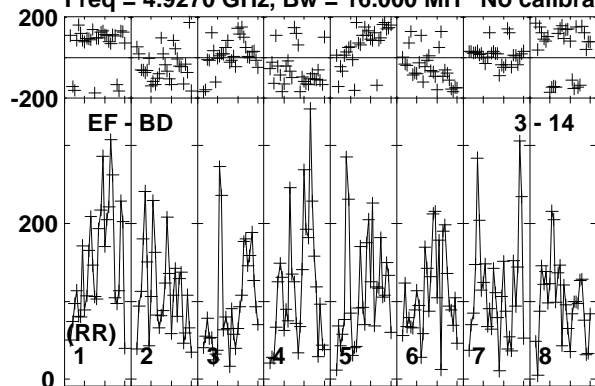

Lower frame: Micro Ampl Jy Top frame: Phas deg  
Vector averaged cross-power spectrum Baseline: EF (03) - BD (14)  
Timerange: 00/12:58:01 to 00/13:00:59

Plot file version 490 created 19-DEC-2018 17:58:48

J1619+2247 RY007C.UVDATA.1

Freq = 4.9270 GHz, Bw = 16.000 MH No calibration applied and no bandpass applied

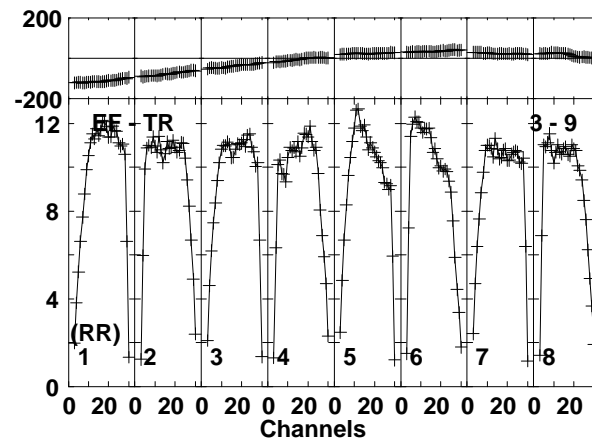
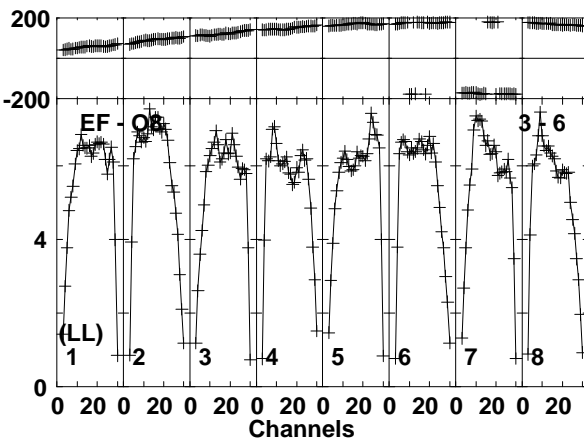
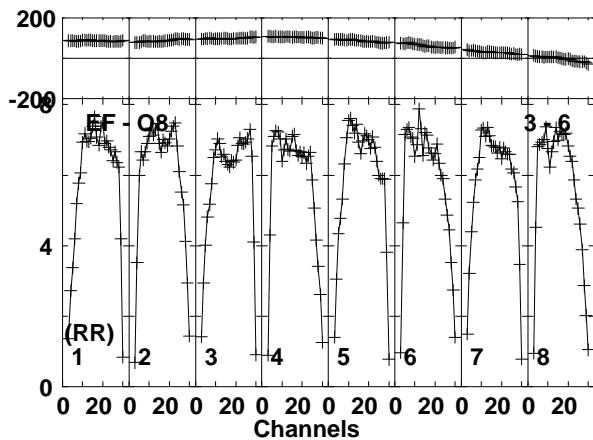
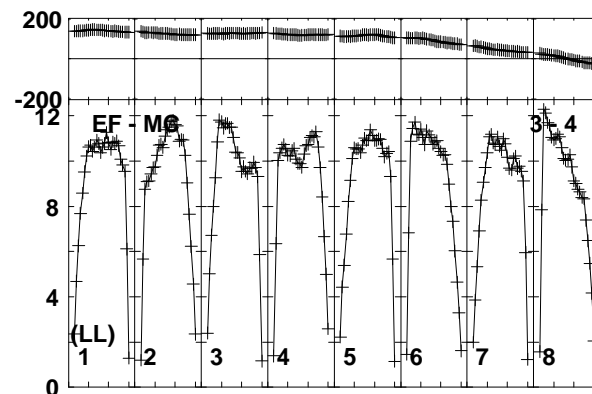
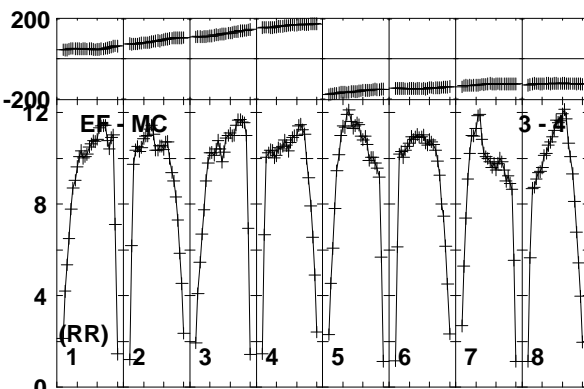
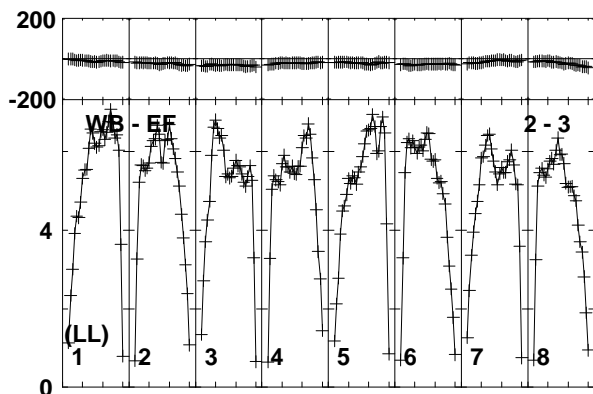
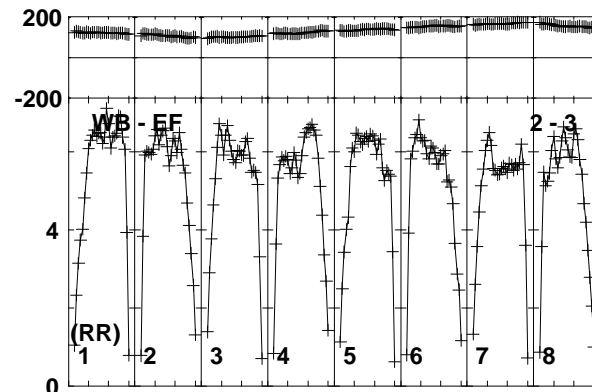
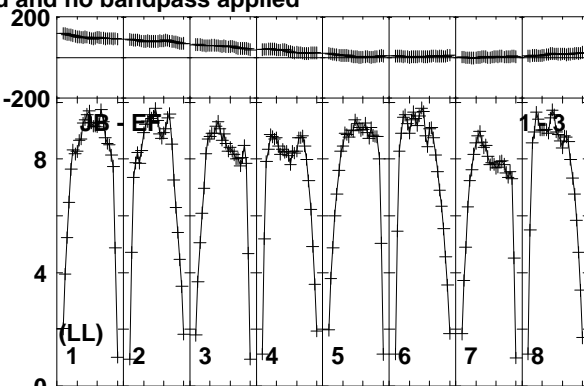
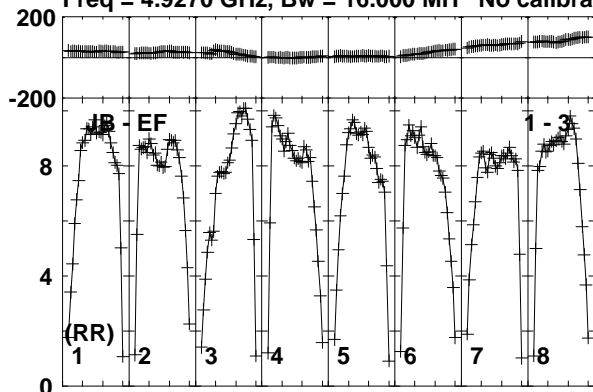

Lower frame: Milli Ampl Jy Top frame: Phas deg

Vector averaged cross-power spectrum Baseline: JB (01) - EF (03)

Timerange: 00/13:01:01 to 00/13:01:59



Plot file version 491 created 19-DEC-2018 17:58:48

J1619+2247 RY007C.UVDATA.1

Freq = 4.9270 GHz, Bw = 16.000 MH No calibration applied and no bandpass applied

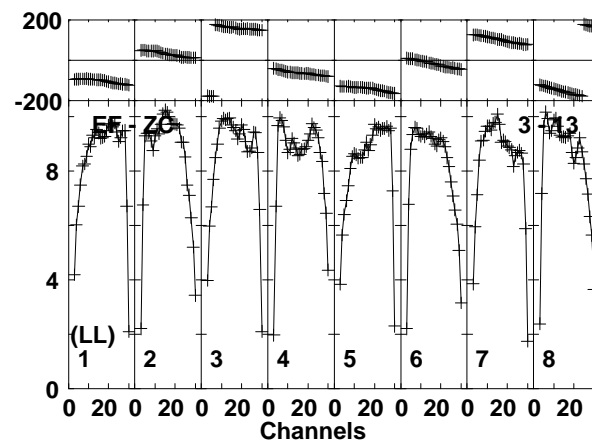
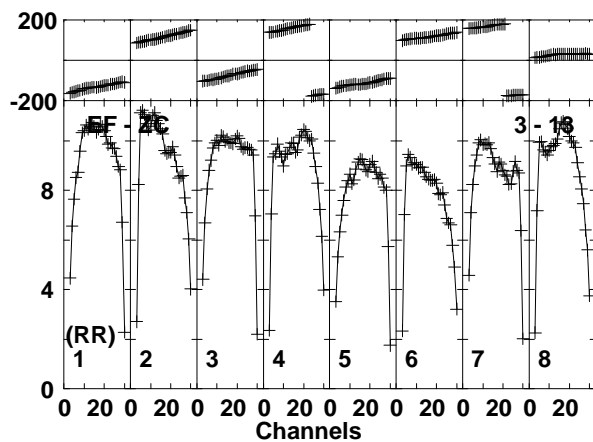
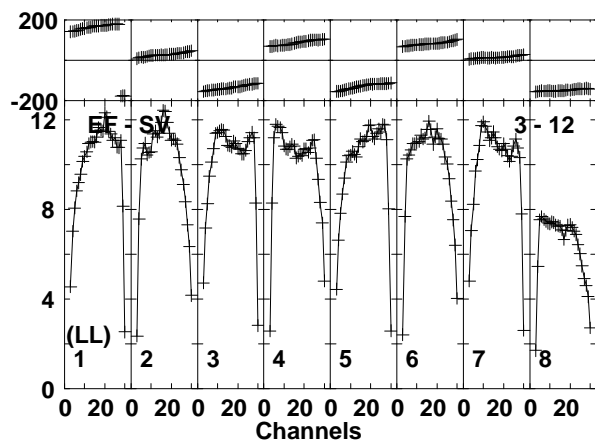
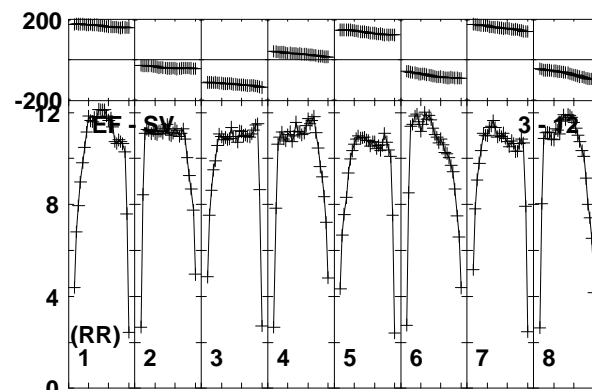
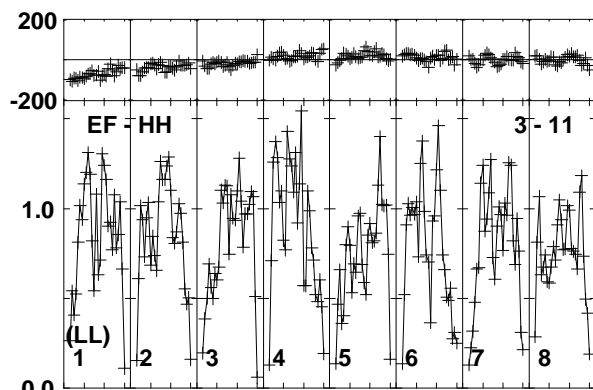
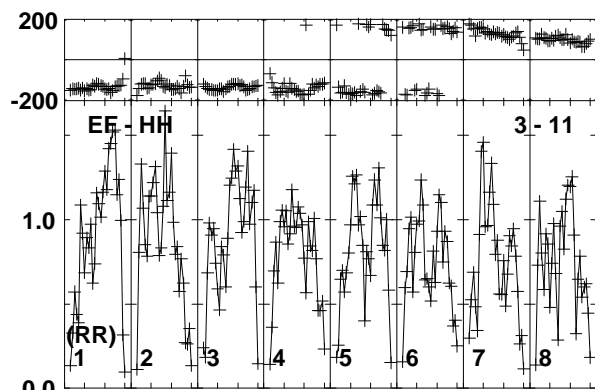
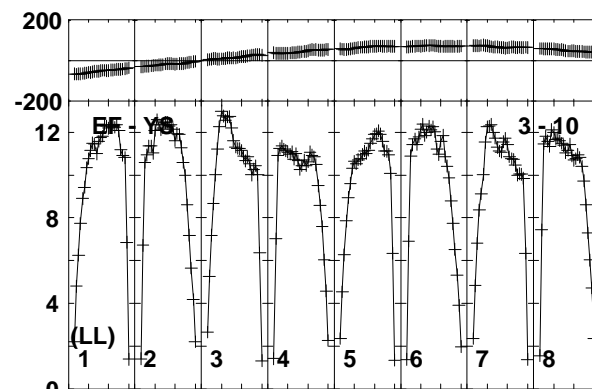
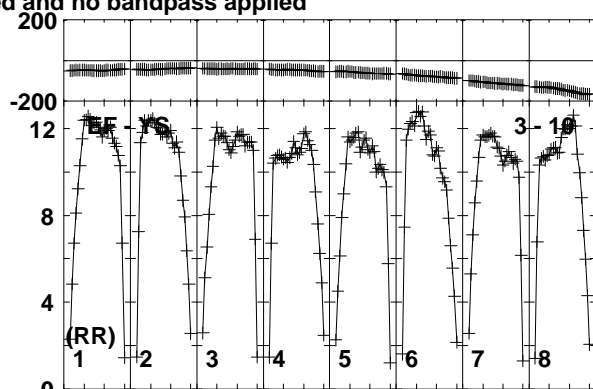
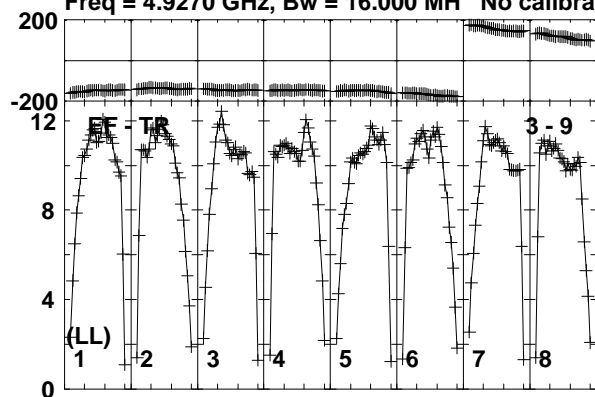

Lower frame: Milli Ampl Jy Top frame: Phas deg  
Vector averaged cross-power spectrum Baseline: EF (03) - TR (09)  
Timerange: 00/13:01:01 to 00/13:01:59

Plot file version 492 created 19-DEC-2018 17:58:49

J1619+2247 RY007C.UVDATA.1

Freq = 4.9270 GHz, Bw = 16.000 MH No calibration applied and no bandpass applied

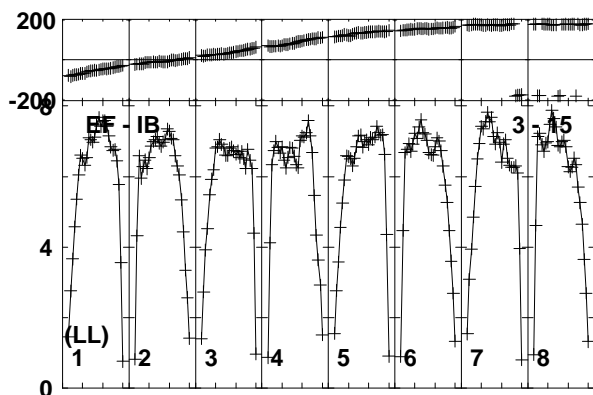
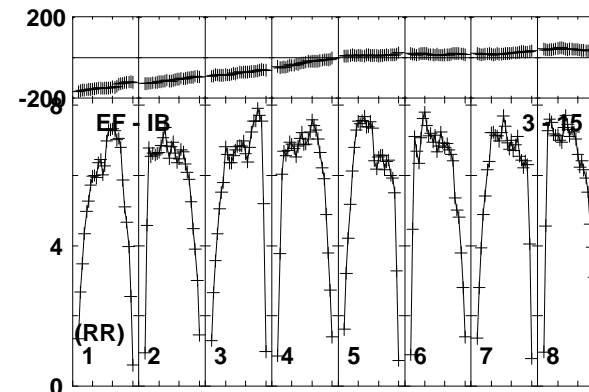
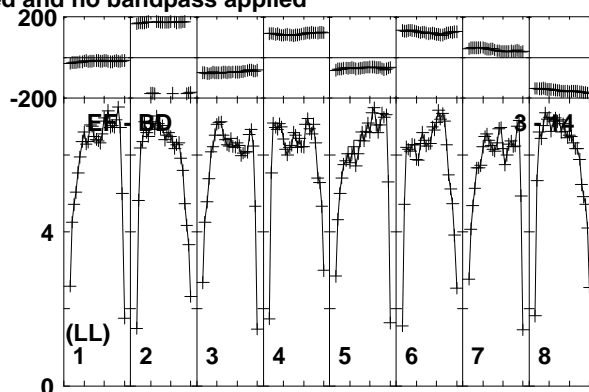
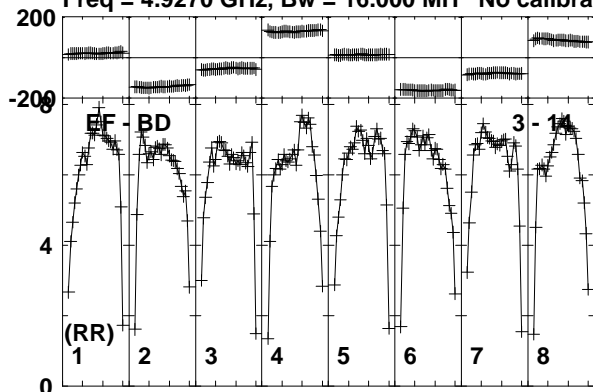

Lower frame: Milli Ampl Jy Top frame: Phas deg  
Vector averaged cross-power spectrum Baseline: EF (03) - BD (14)  
Timerange: 00/13:01:01 to 00/13:01:59

Plot file version 493 created 19-DEC-2018 17:58:49

AT2018\_RY007C.UVDATA.1

Freq = 4.9270 GHz, Bw = 16.000 MH No calibration applied and no bandpass applied

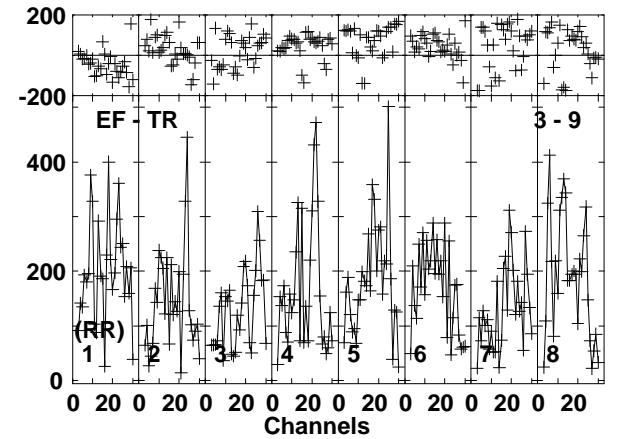
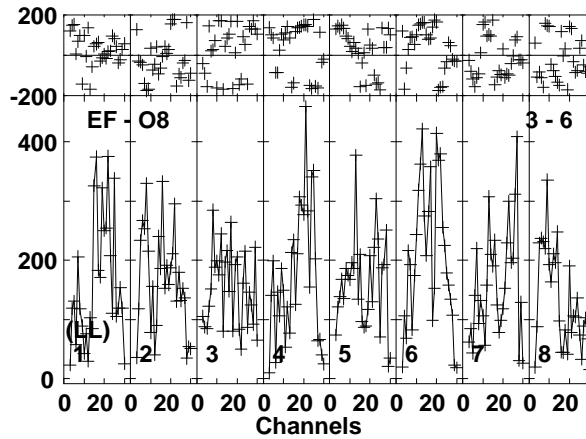
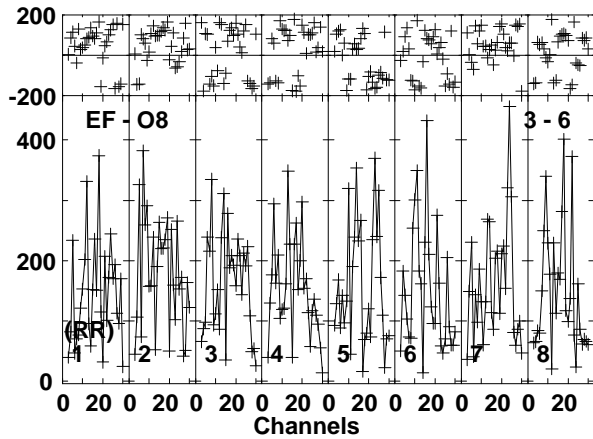
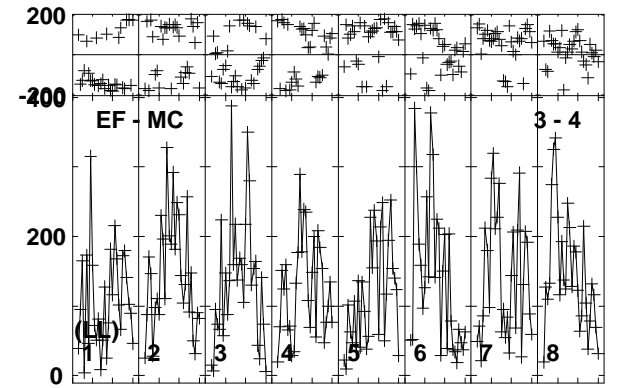
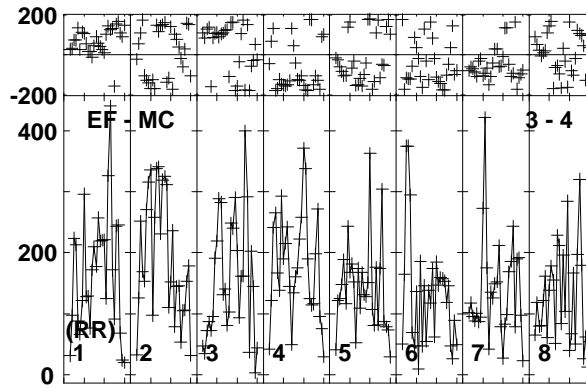
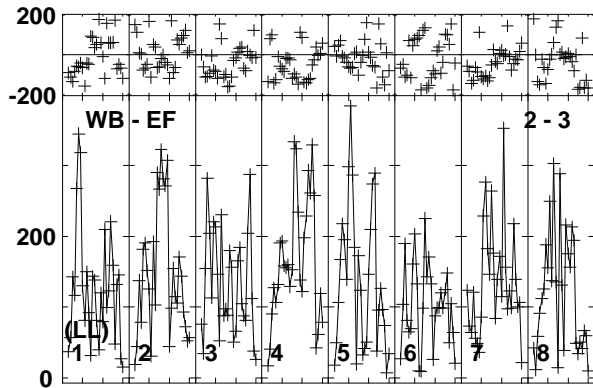
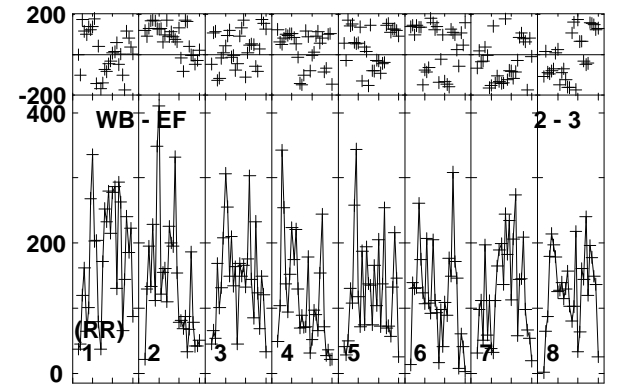
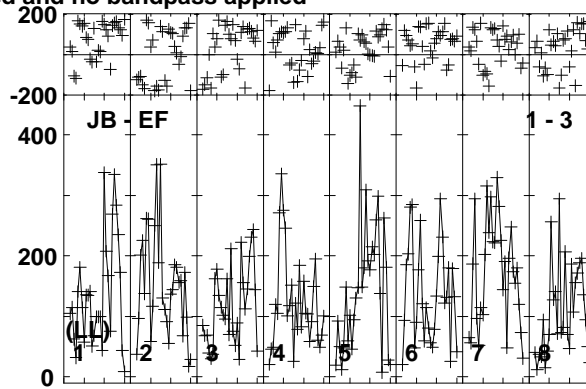
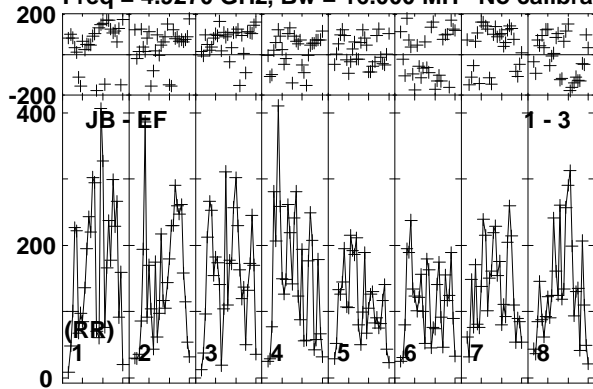

Lower frame: Micro Ampl Jy Top frame: Phas deg  
Vector averaged cross-power spectrum Baseline: JB (01) - EF (03)  
Timerange: 00/13:02:01 to 00/13:03:59

Plot file version 494 created 19-DEC-2018 17:58:49

AT2018\_RY007C.UVDATA.1

Freq = 4.9270 GHz, Bw = 16.000 MH No calibration applied and no bandpass applied

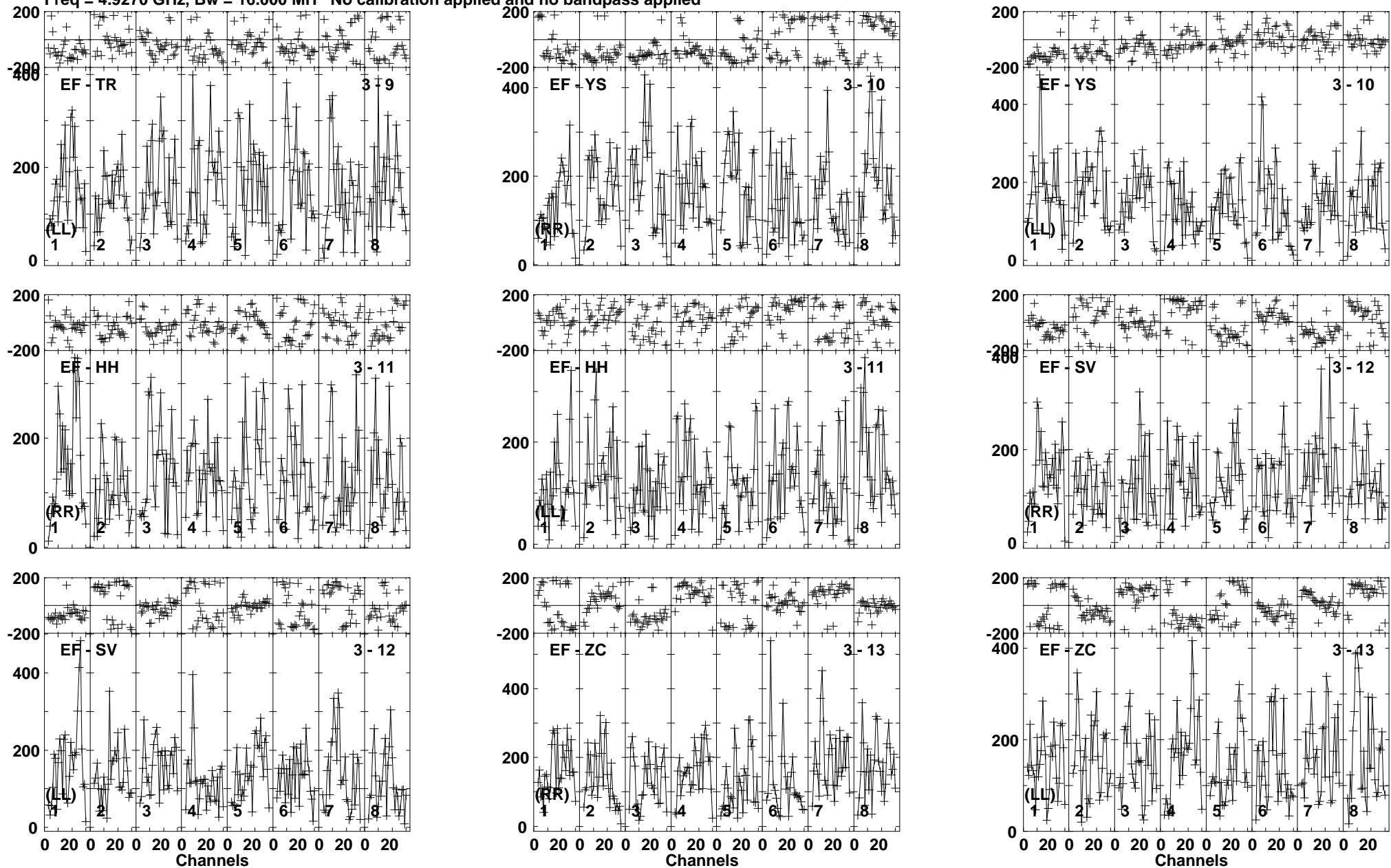

Lower frame: Micro Ampl Jy Top frame: Phas deg  
Vector averaged cross-power spectrum Baseline: EF (03) - TR (09)  
Timerange: 00/13:02:01 to 00/13:03:59

Plot file version 495 created 19-DEC-2018 17:58:49

AT2018\_RY007C.UVDATA.1

Freq = 4.9270 GHz, Bw = 16.000 MH No calibration applied and no bandpass applied

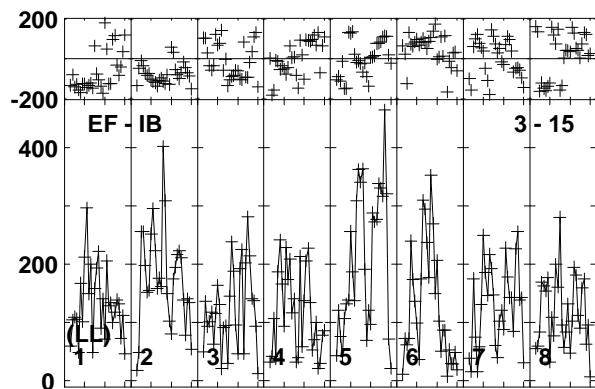
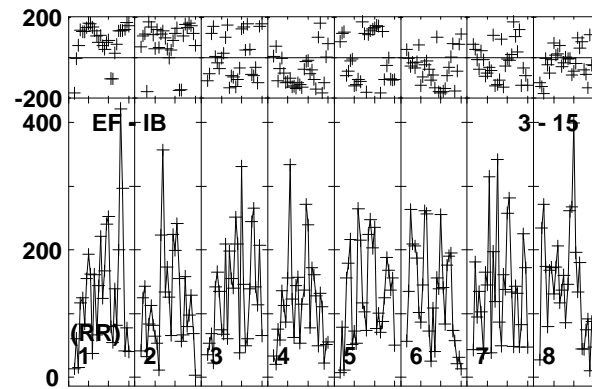
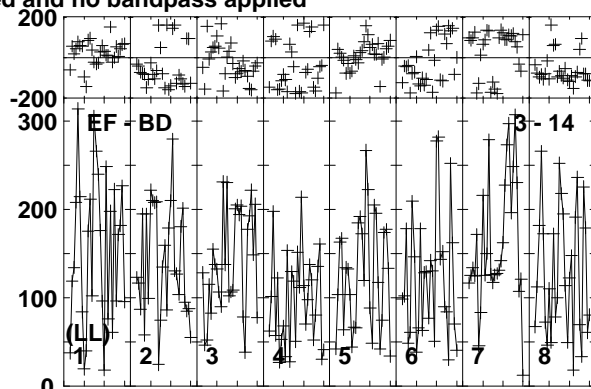
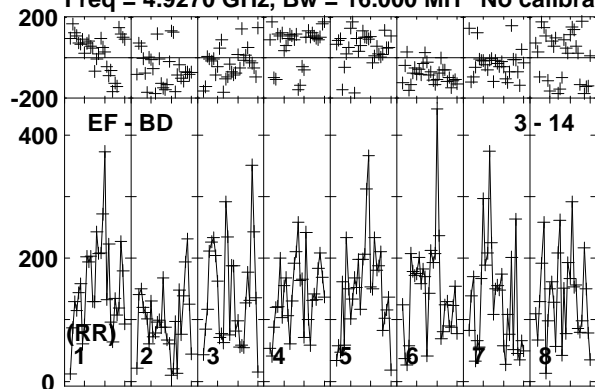

Lower frame: Micro Ampl Jy Top frame: Phas deg  
Vector averaged cross-power spectrum Baseline: EF (03) - BD (14)  
Timerange: 00/13:02:01 to 00/13:03:59

Plot file version 496 created 19-DEC-2018 17:58:49

VLA2 RY007C.UVDATA.1

Freq = 4.9270 GHz, Bw = 16.000 MH No calibration applied and no bandpass applied

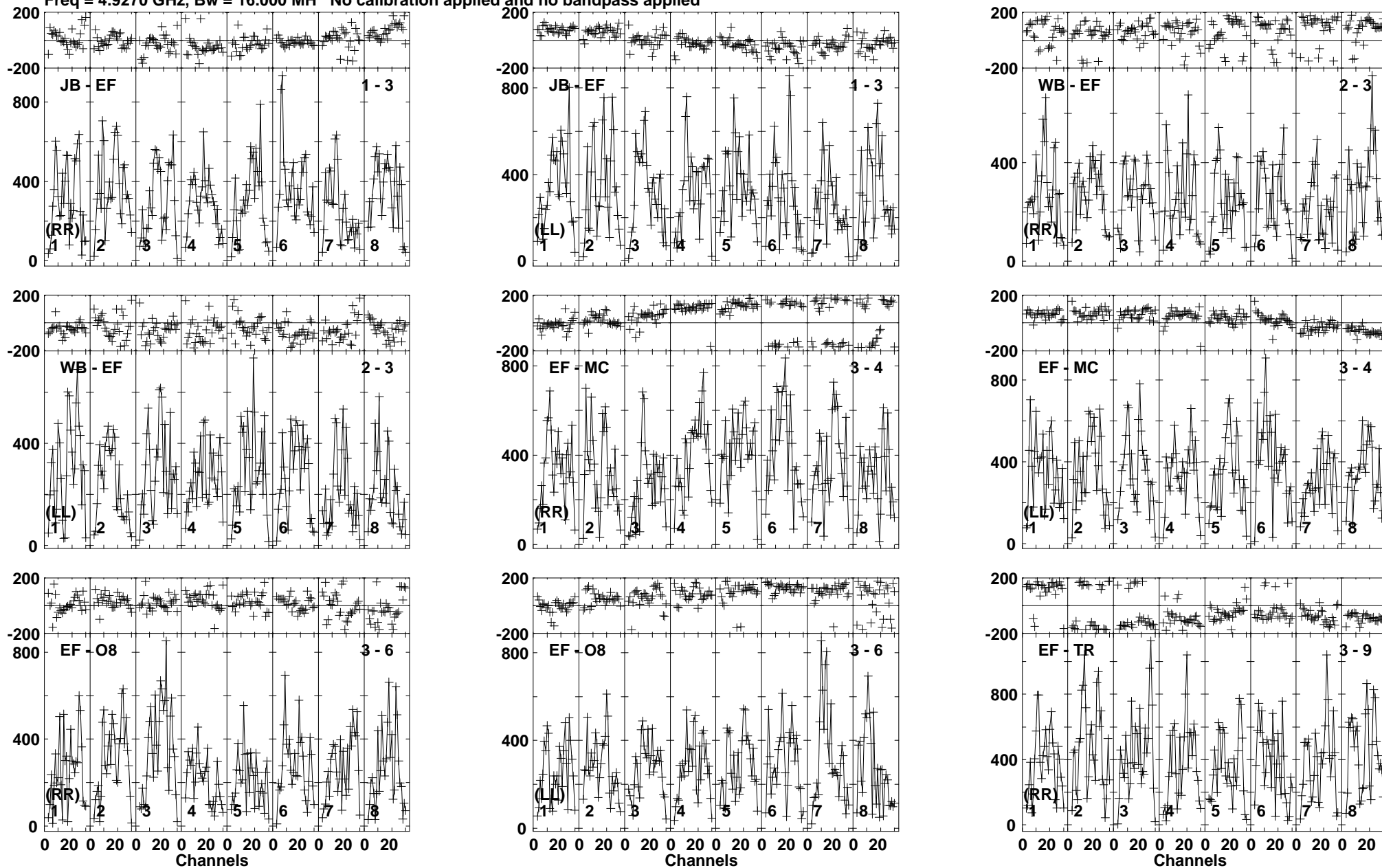

Lower frame: Micro Ampl Jy Top frame: Phas deg  
Vector averaged cross-power spectrum Baseline: JB (01) - EF (03)  
Timerange: 00/13:04:01 to 00/13:04:59

Plot file version 497 created 19-DEC-2018 17:58:49

VLA2 RY007C.UVDATA.1

Freq = 4.9270 GHz, Bw = 16.000 MH No calibration applied and no bandpass applied

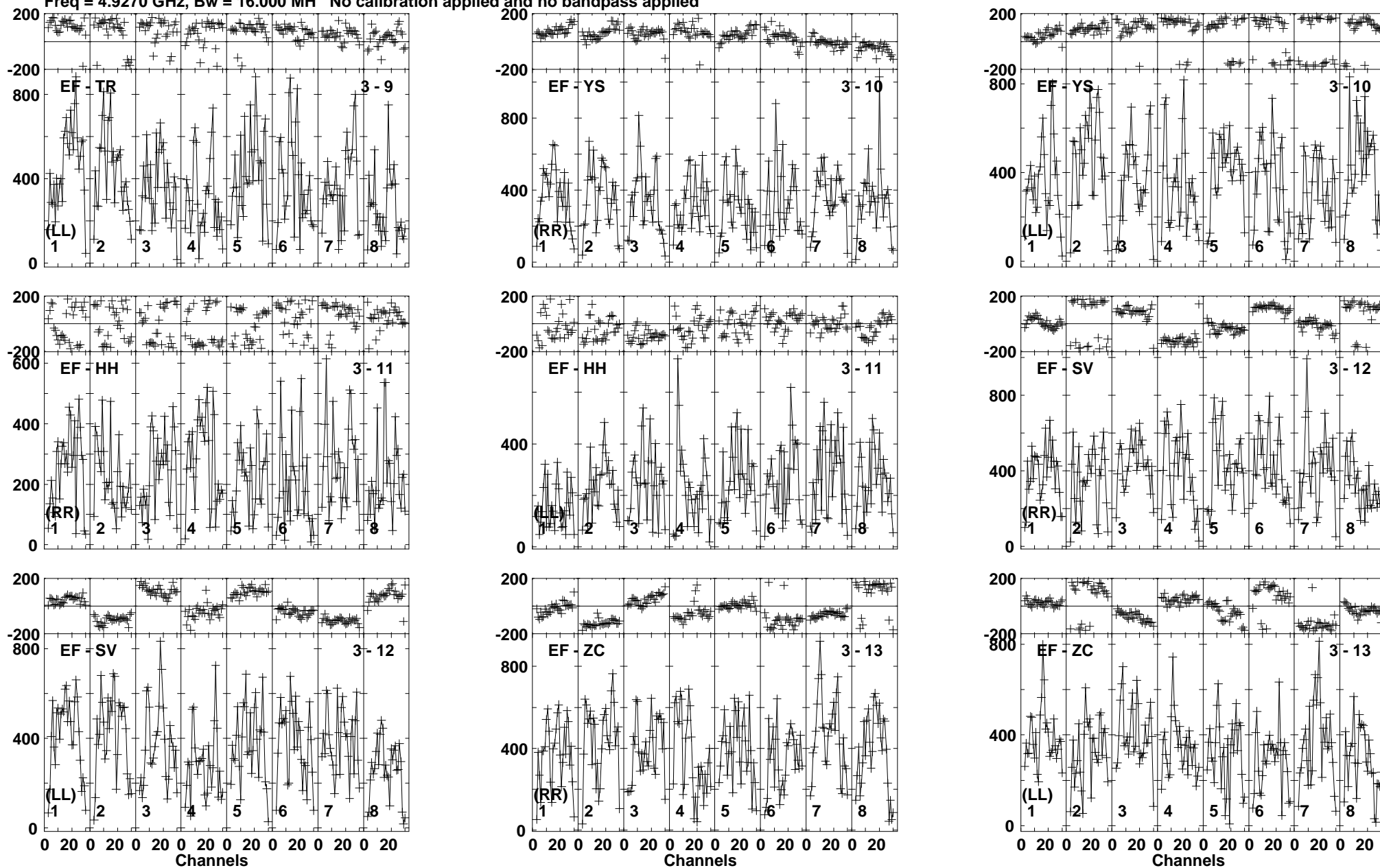

Lower frame: Micro Ampl Jy Top frame: Phas deg  
Vector averaged cross-power spectrum Baseline: EF (03) - TR (09)  
Timerange: 00/13:04:01 to 00/13:04:59

Plot file version 498 created 19-DEC-2018 17:58:49

VLA2 RY007C.UVDATA.1

Freq = 4.9270 GHz, Bw = 16.000 MH No calibration applied and no bandpass applied

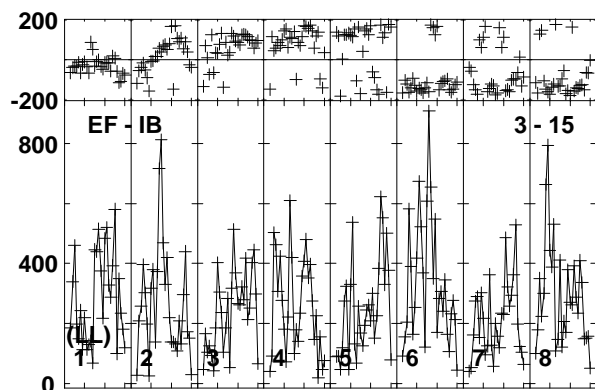
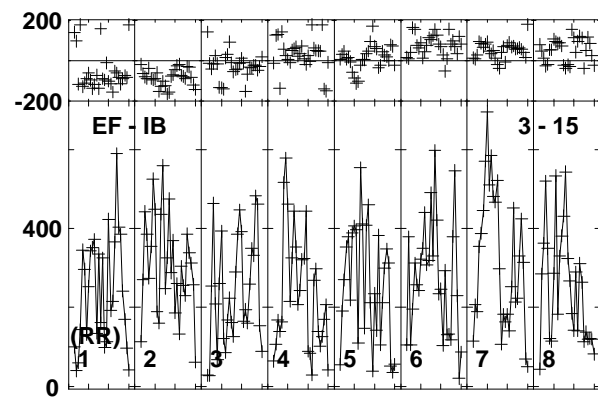
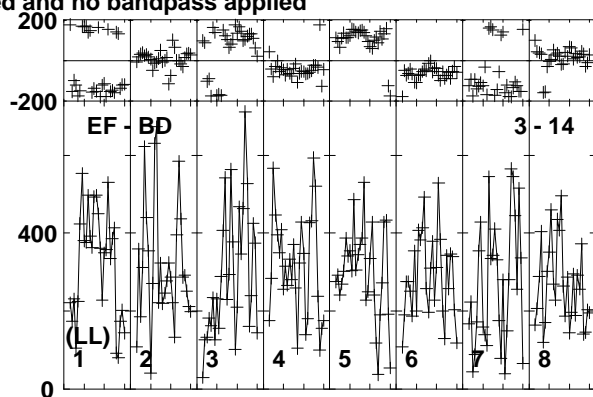
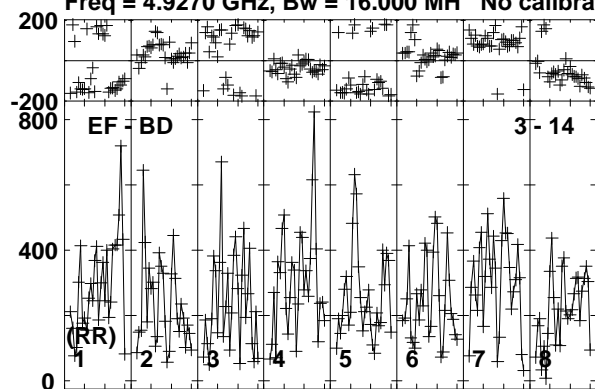

Lower frame: Micro Ampl Jy Top frame: Phas deg  
Vector averaged cross-power spectrum Baseline: EF (03) - BD (14)  
Timerange: 00/13:04:01 to 00/13:04:59



Plot file version 499 created 19-DEC-2018 17:58:49

J1619+2247 RY007C.UVDATA.1

Freq = 4.9270 GHz, Bw = 16.000 MH No calibration applied and no bandpass applied

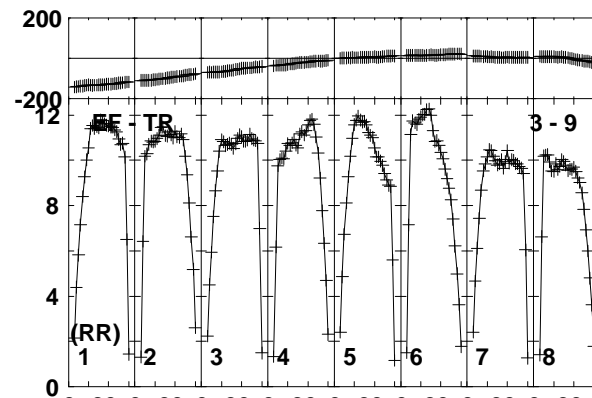
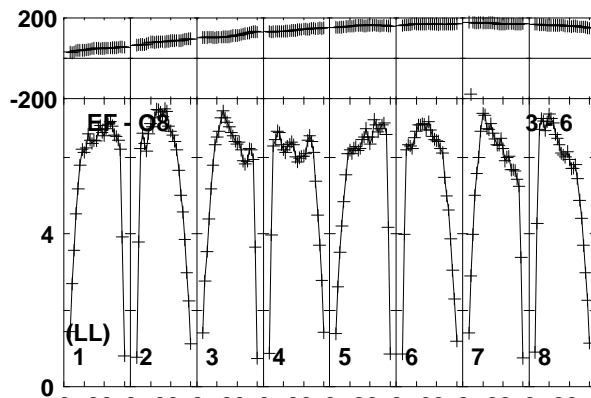
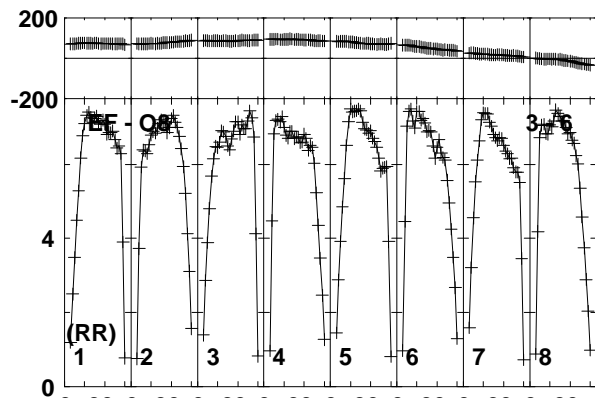
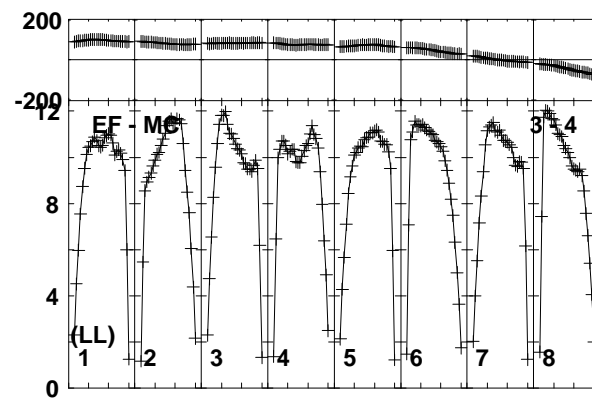
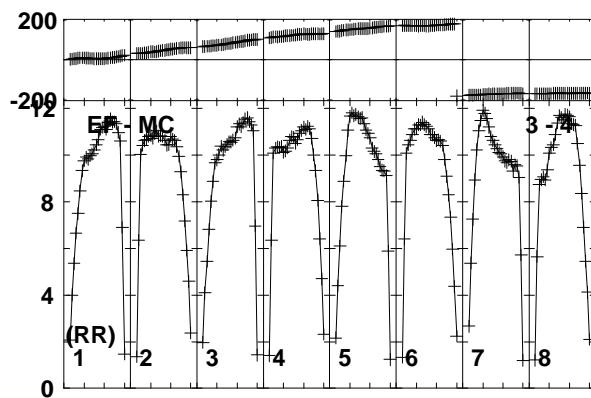
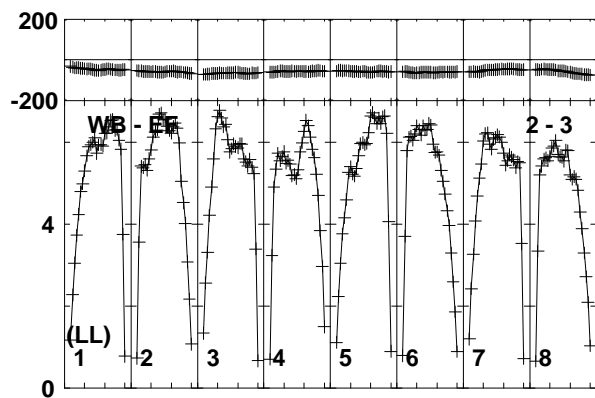
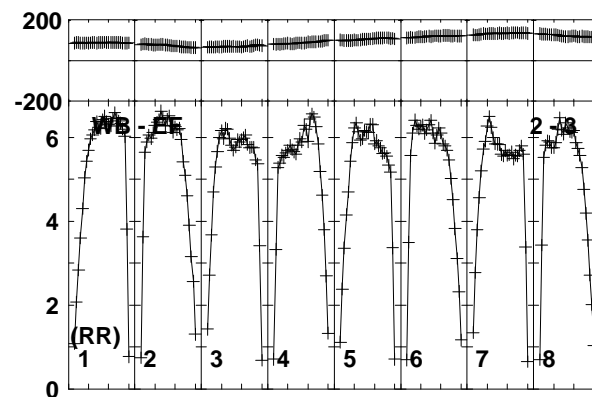
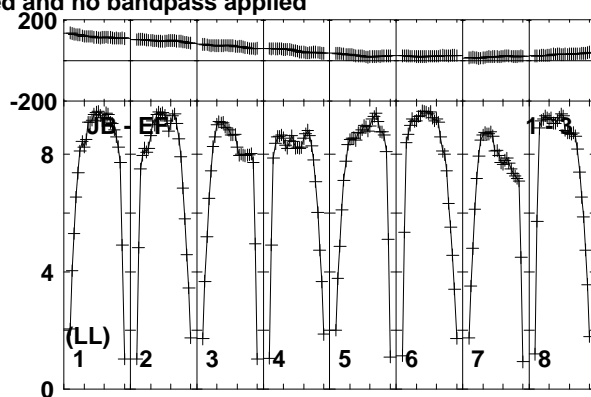
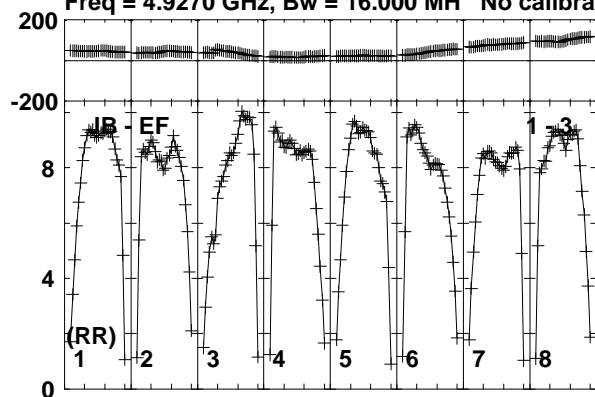

Lower frame: Milli Ampl Jy Top frame: Phas deg  
Vector averaged cross-power spectrum Baseline: JB (01) - EF (03)  
Timerange: 00/13:05:31 to 00/13:06:29

Plot file version 500 created 19-DEC-2018 17:58:49

J1619+2247 RY007C.UVDATA.1

Freq = 4.9270 GHz, Bw = 16.000 MH No calibration applied and no bandpass applied

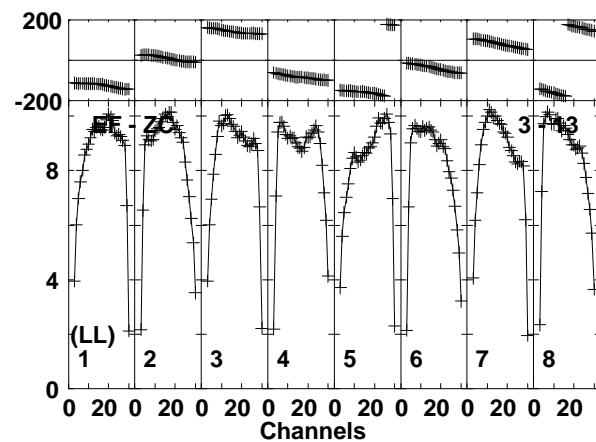
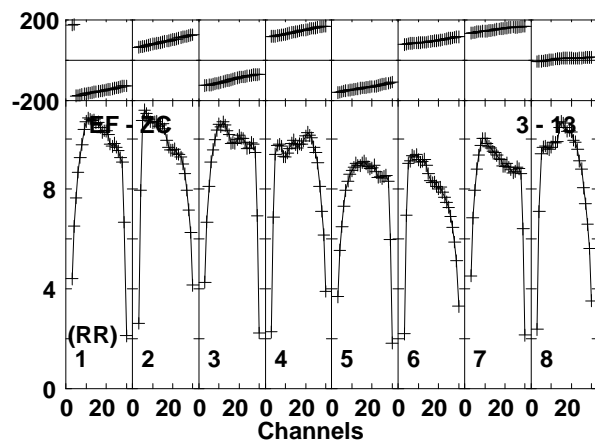
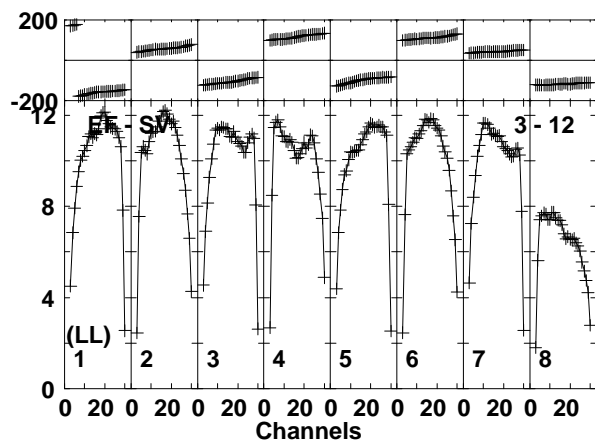
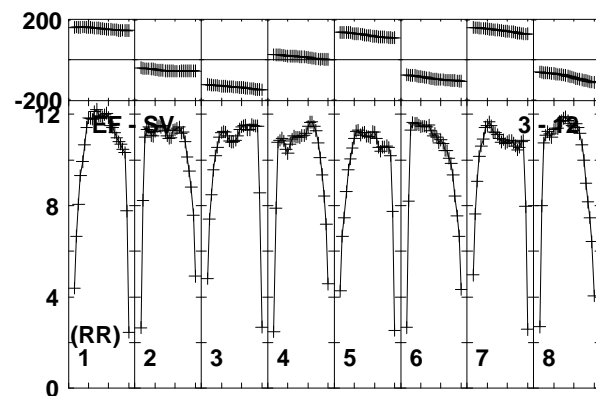
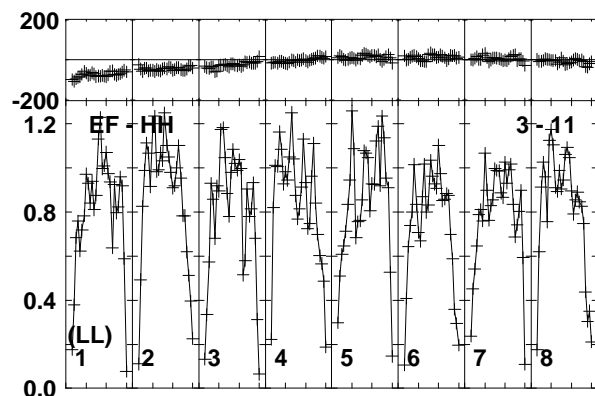
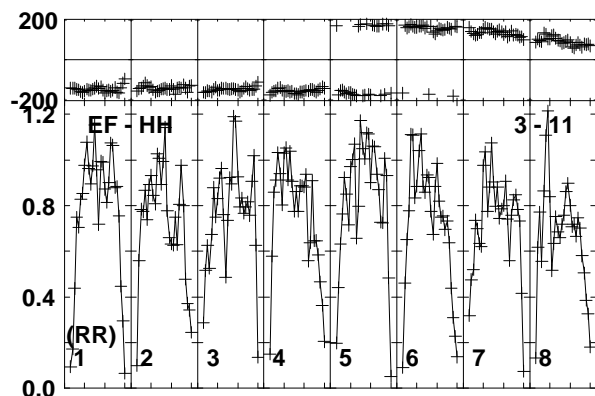
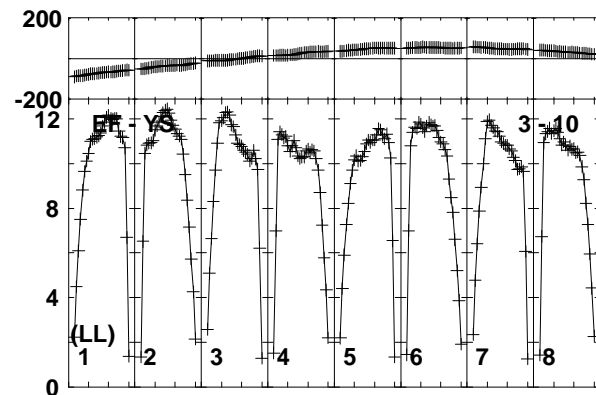
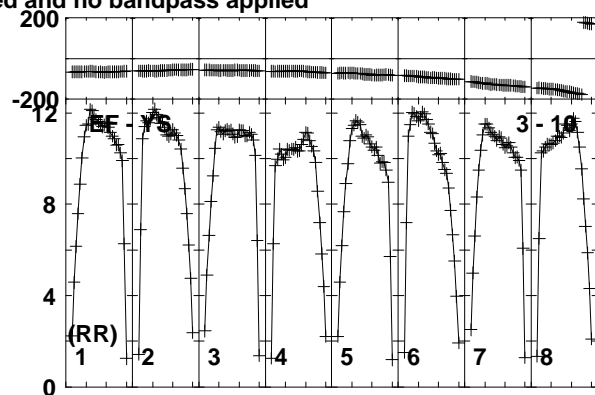
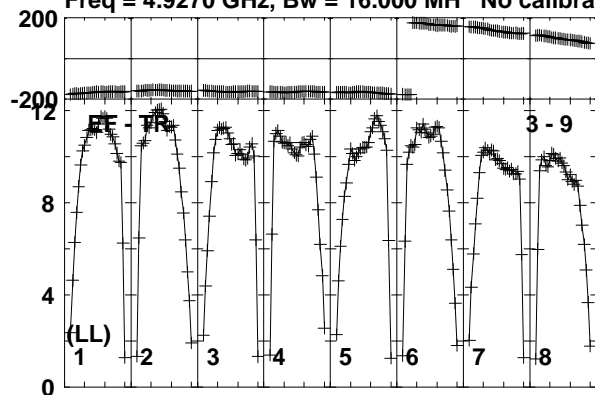

Lower frame: Milli Ampl Jy Top frame: Phas deg  
Vector averaged cross-power spectrum Baseline: EF (03) - TR (09)  
Timerange: 00/13:05:31 to 00/13:06:29

Plot file version 501 created 19-DEC-2018 17:58:49

J1619+2247 RY007C.UVDATA.1

Freq = 4.9270 GHz, Bw = 16.000 MH No calibration applied and no bandpass applied

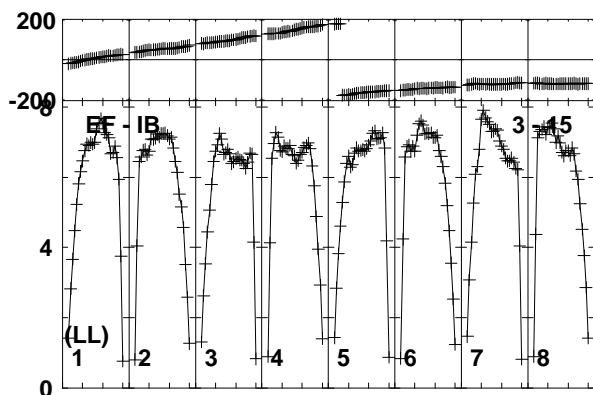
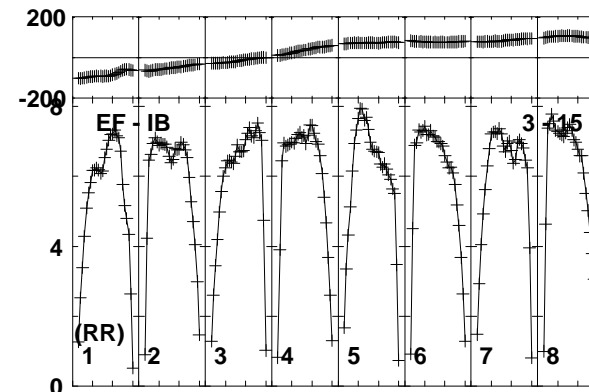
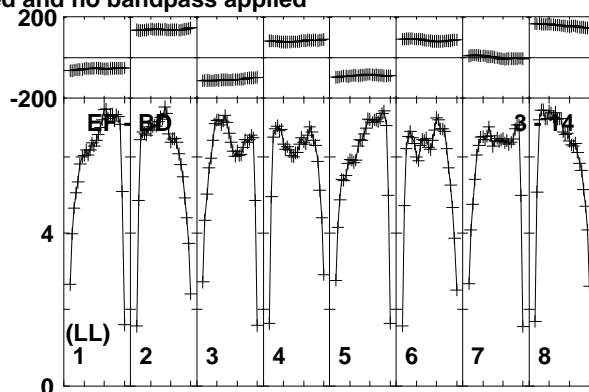
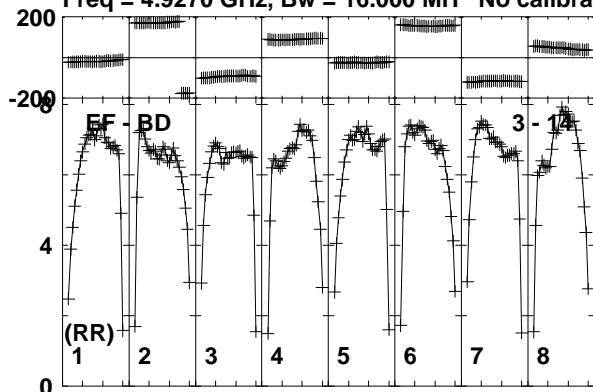

Lower frame: Milli Ampl Jy Top frame: Phas deg

Vector averaged cross-power spectrum Baseline: EF (03) - BD (14)

Timerange: 00/13:05:31 to 00/13:06:29

Plot file version 502 created 19-DEC-2018 17:58:49

J1642+3948 RY007C.UVDATA.1

Freq = 4.9270 GHz, Bw = 16.000 MH No calibration applied and no bandpass applied

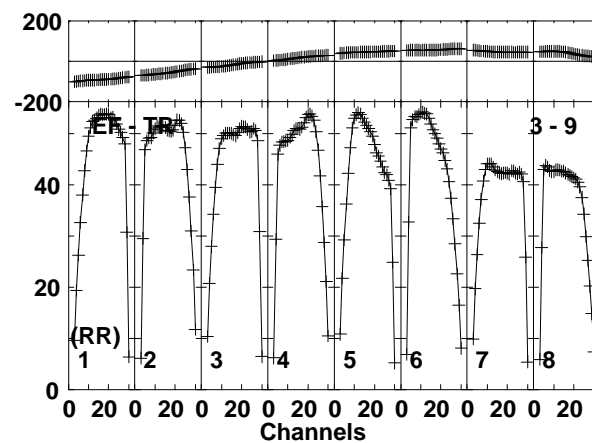
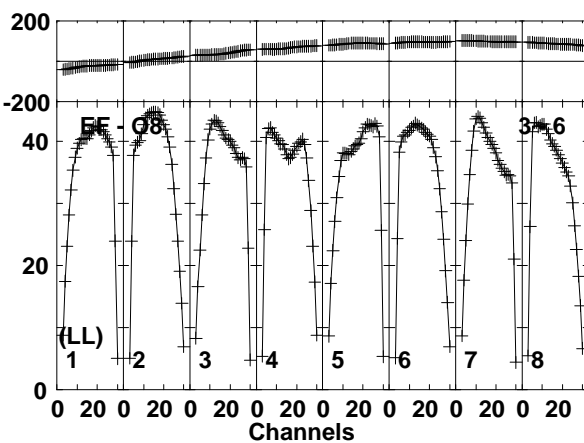
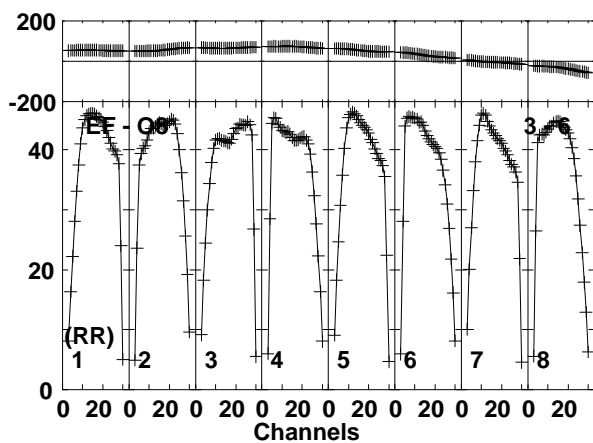
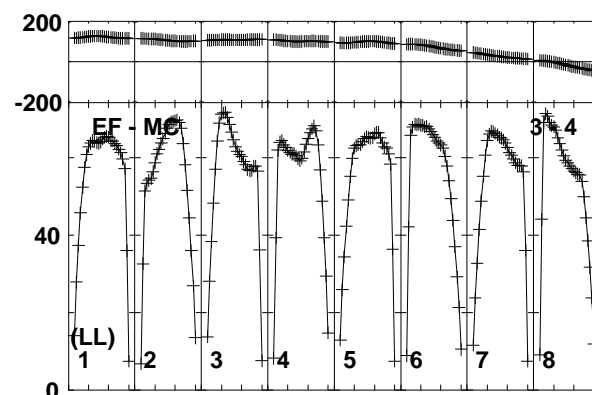
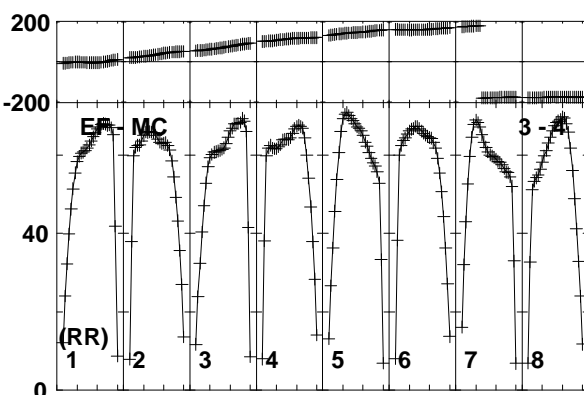
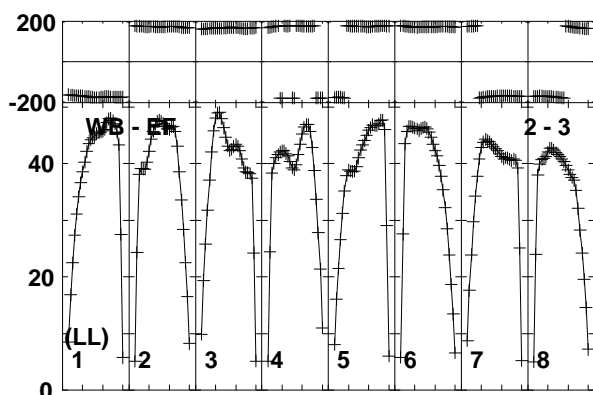
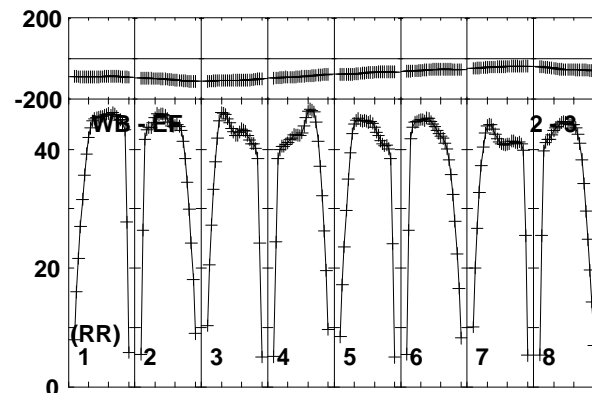
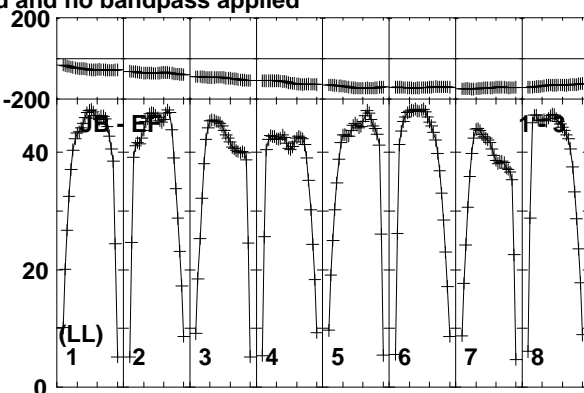
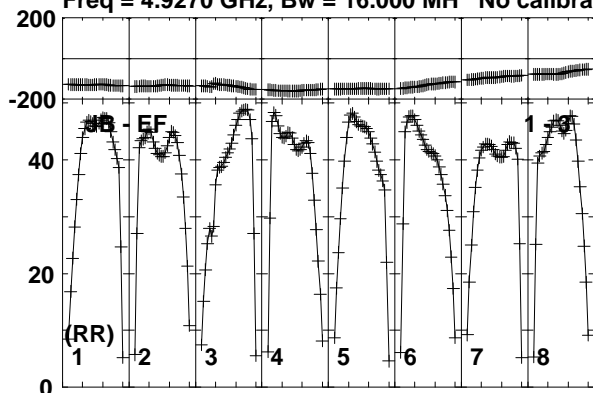

Lower frame: Milli Ampl Jy Top frame: Phas deg  
Vector averaged cross-power spectrum Baseline: JB (01) - EF (03)  
Timerange: 00/13:08:31 to 00/13:11:29

Plot file version 503 created 19-DEC-2018 17:58:49

J1642+3948 RY007C.UVDATA.1

Freq = 4.9270 GHz, Bw = 16.000 MH No calibration applied and no bandpass applied

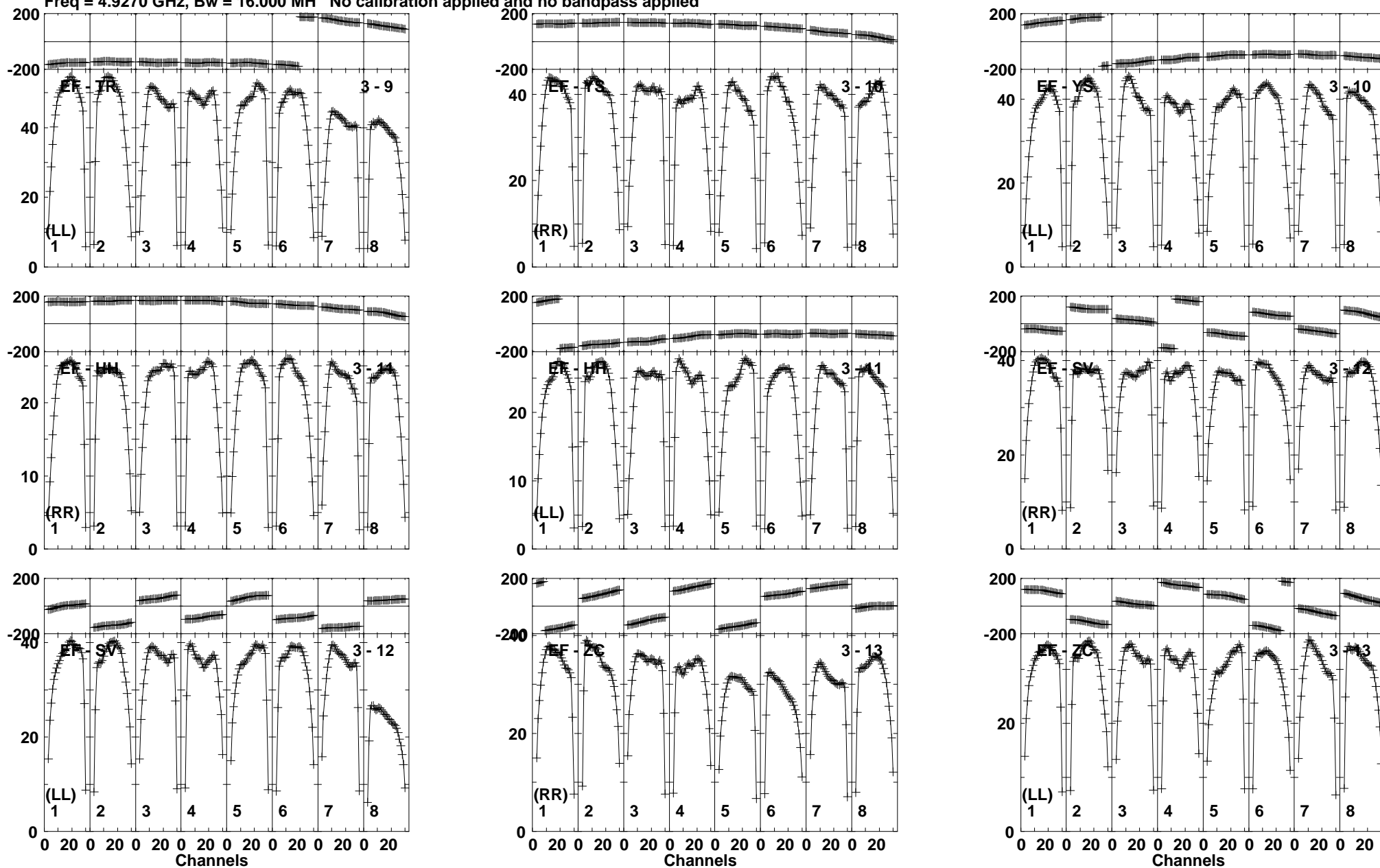

Lower frame: Milli Amply Jy Top frame: Phas deg  
Vector averaged cross-power spectrum Baseline: EF (03) - TR (09)  
Timerange: 00/13:08:31 to 00/13:11:29

Plot file version 504 created 19-DEC-2018 17:58:49

J1642+3948 RY007C.UVDATA.1

Freq = 4.9270 GHz, Bw = 16.000 MH No calibration applied and no bandpass applied

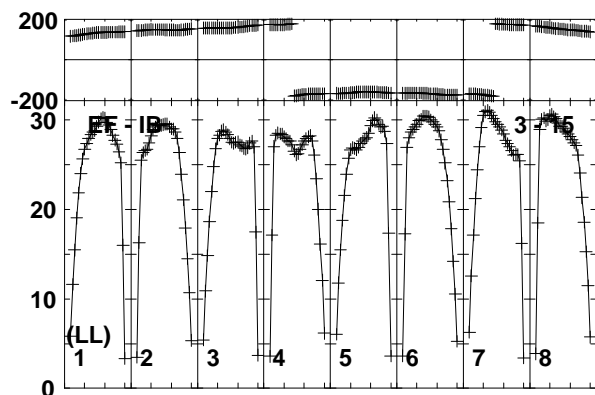
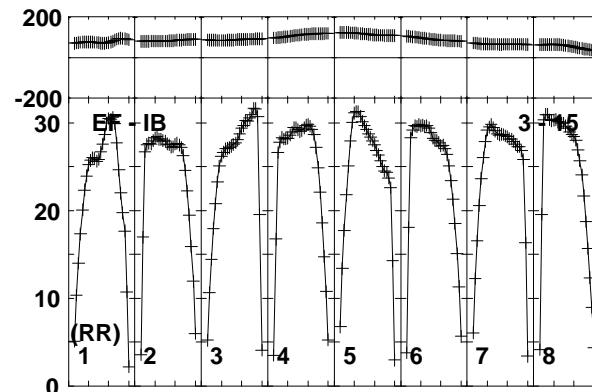
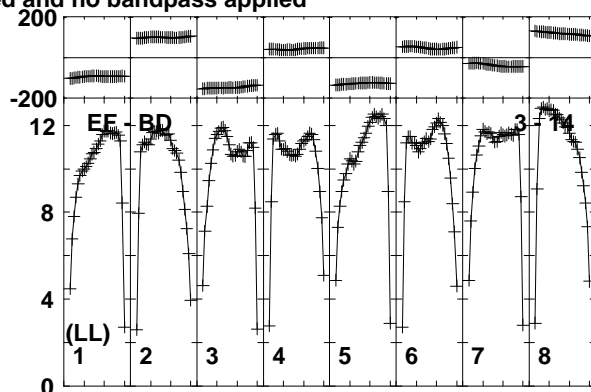
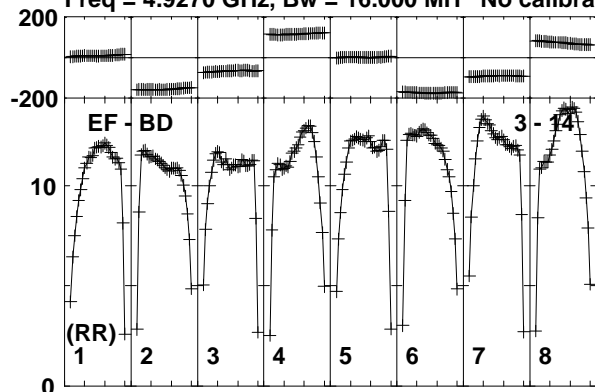

Lower frame: Milli Ampl Jy Top frame: Phas deg  
Vector averaged cross-power spectrum Baseline: EF (03) - BD (14)  
Timerange: 00/13:08:31 to 00/13:11:29

Plot file version 505 created 19-DEC-2018 17:58:49

J1619+2247 RY007C.UVDATA.1

Freq = 4.9270 GHz, Bw = 16.000 MH No calibration applied and no bandpass applied

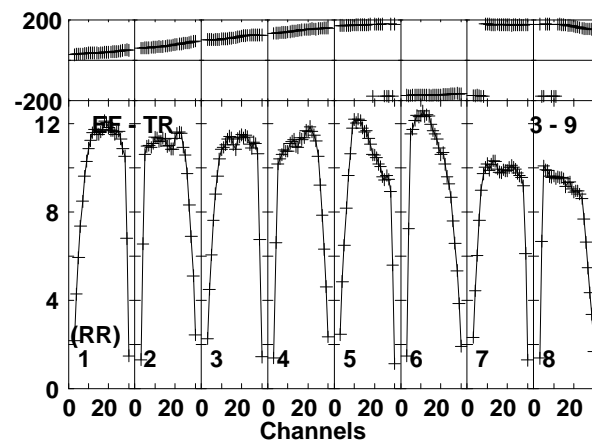
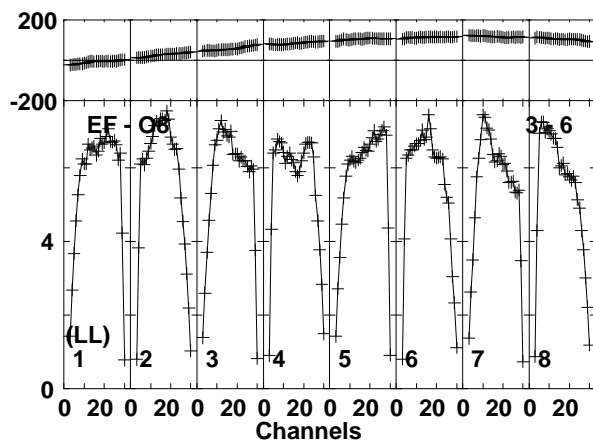
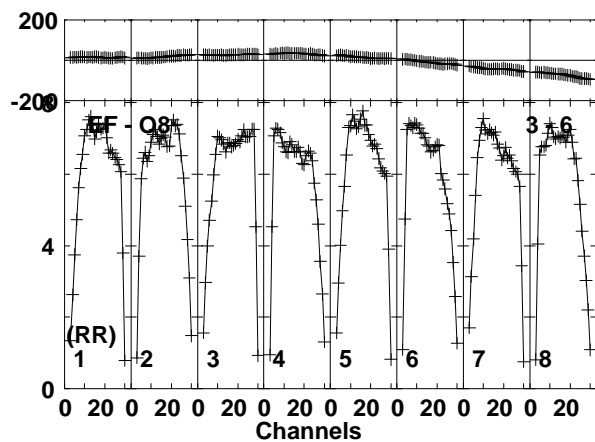
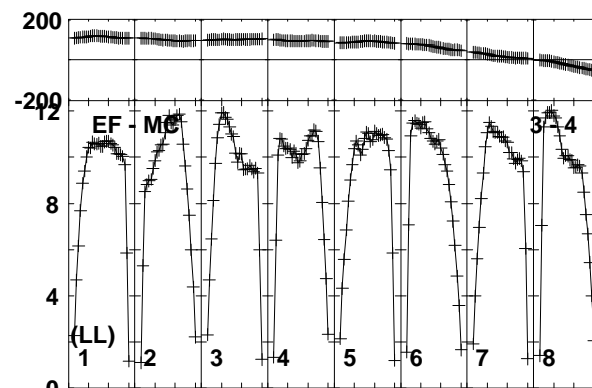
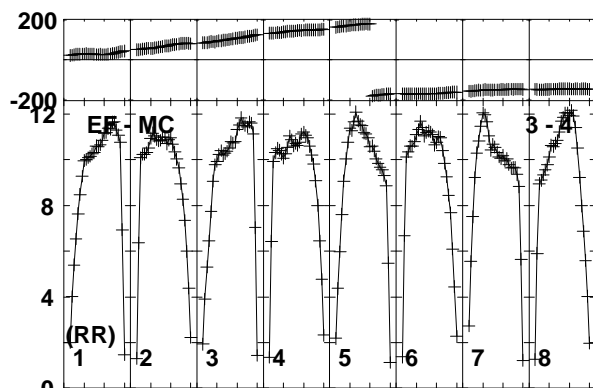
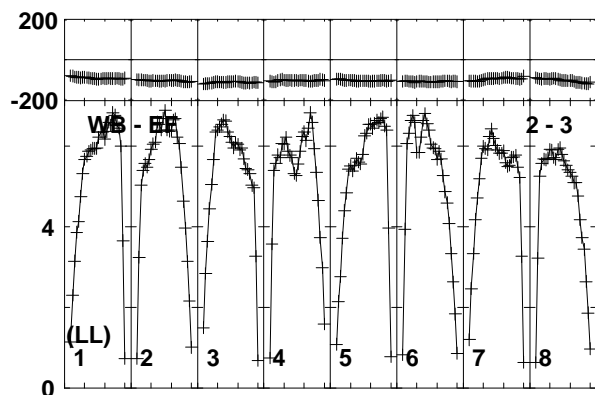
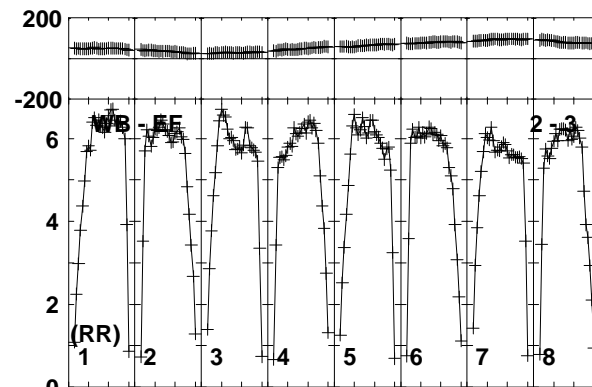
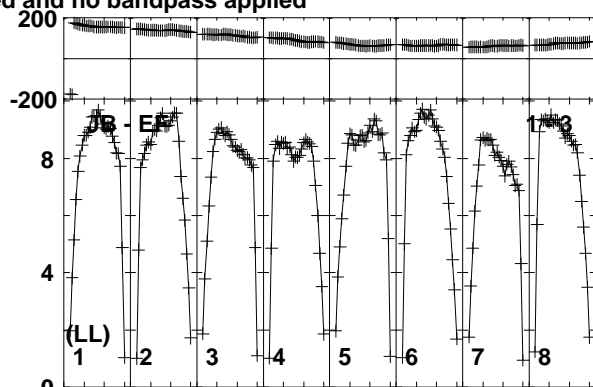
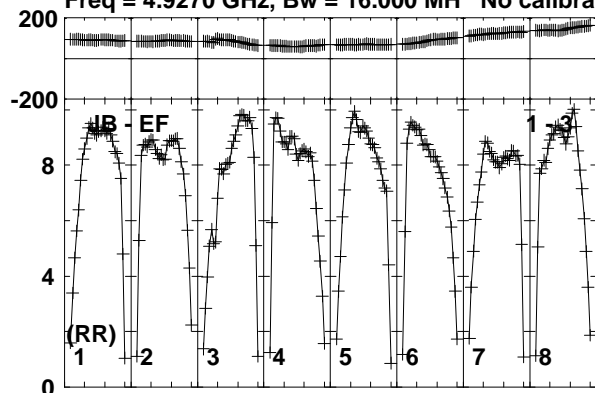

Lower frame: Milli Ampl Jy Top frame: Phas deg  
Vector averaged cross-power spectrum Baseline: JB (01) - EF (03)  
Timerange: 00/13:13:01 to 00/13:14:29

Plot file version 506 created 19-DEC-2018 17:58:49

J1619+2247 RY007C.UVDATA.1

Freq = 4.9270 GHz, Bw = 16.000 MH No calibration applied and no bandpass applied

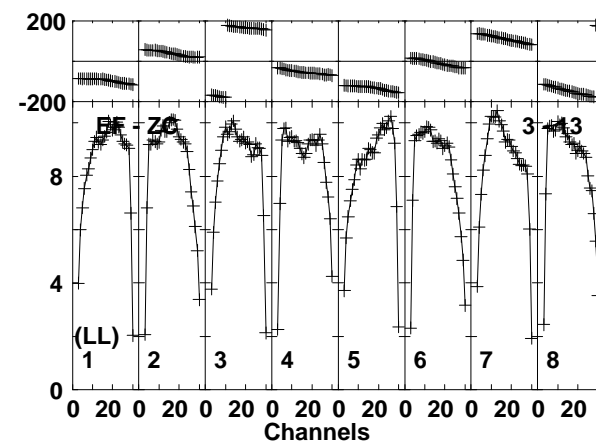
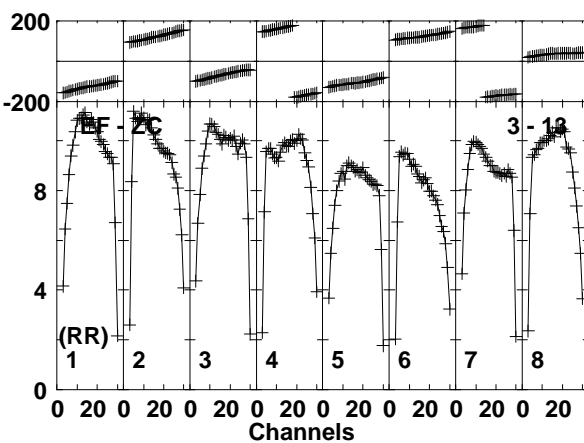
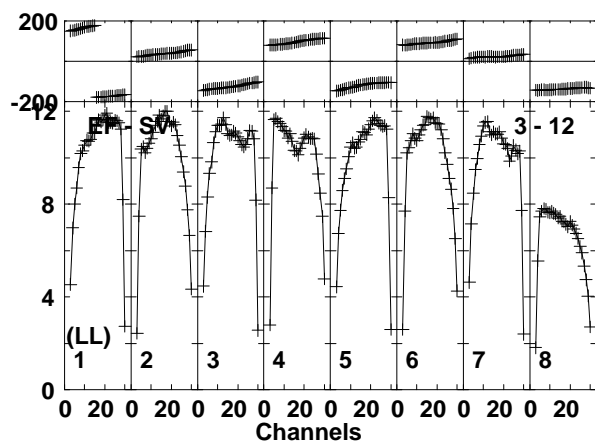
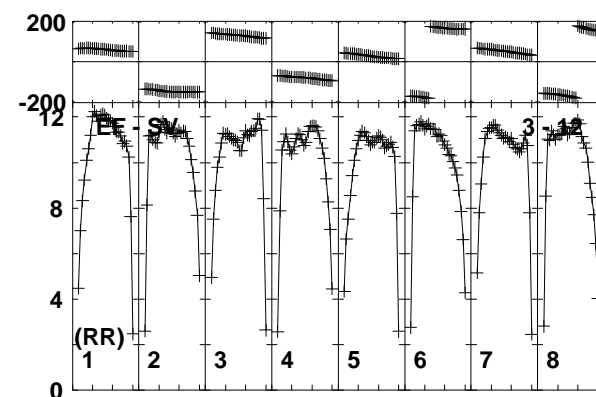
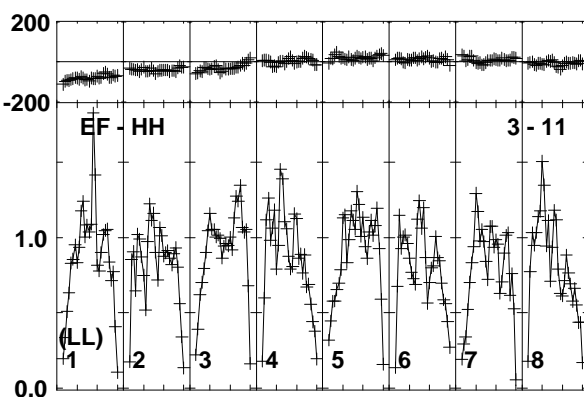
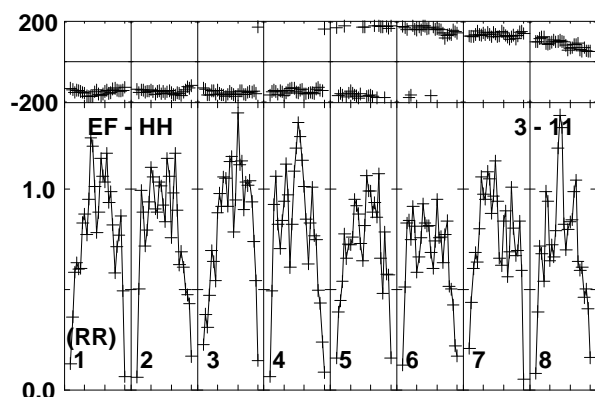
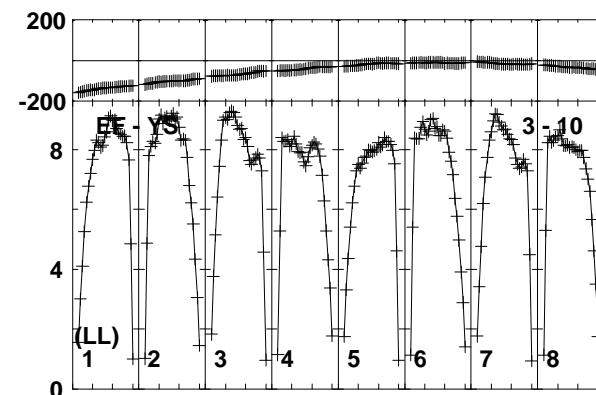
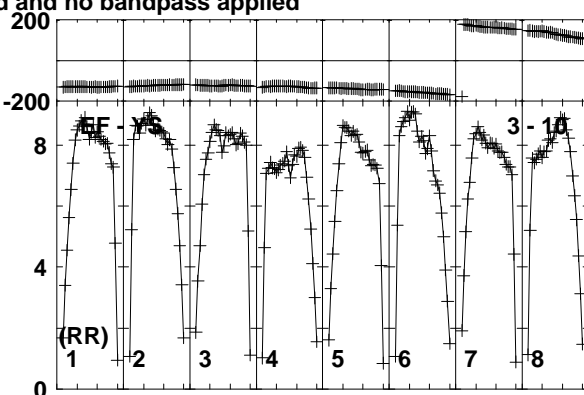
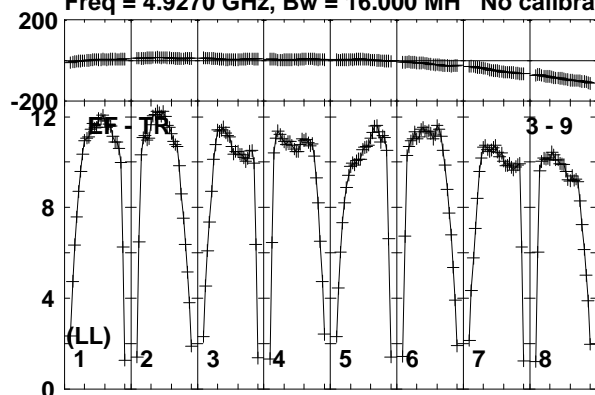

Lower frame: Milli Ampl Jy Top frame: Phas deg  
Vector averaged cross-power spectrum Baseline: EF (03) - TR (09)  
Timerange: 00/13:13:01 to 00/13:14:29



Plot file version 507 created 19-DEC-2018 17:58:49

J1619+2247 RY007C.UVDATA.1

Freq = 4.9270 GHz, Bw = 16.000 MH No calibration applied and no bandpass applied

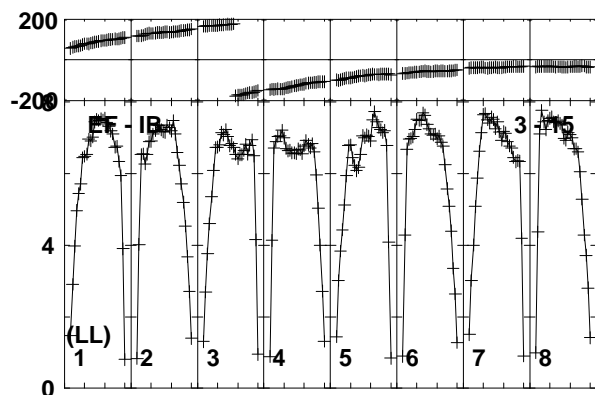
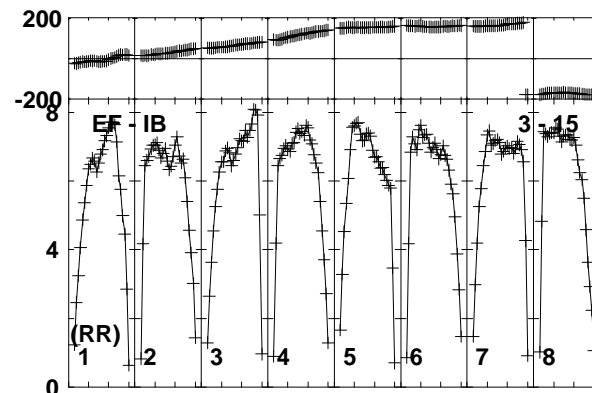
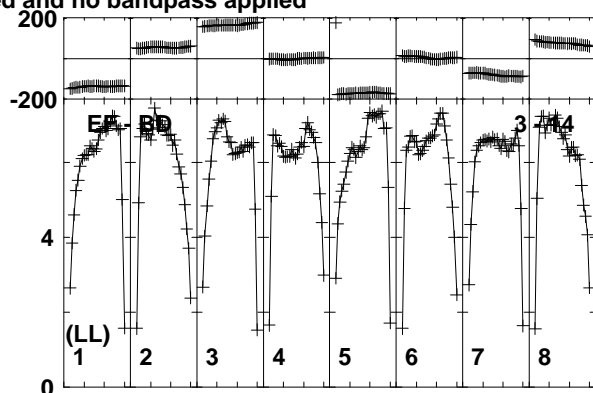
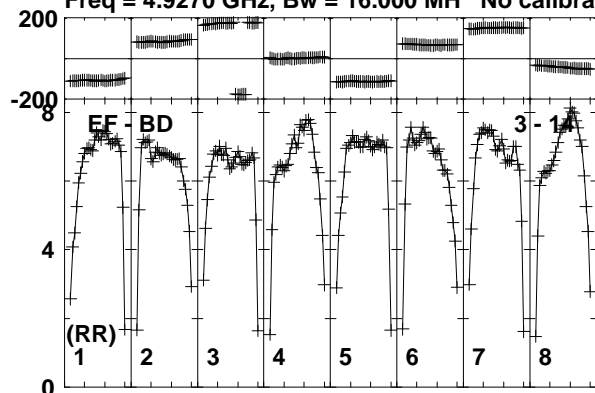

Lower frame: Milli Ampl Jy Top frame: Phas deg  
Vector averaged cross-power spectrum Baseline: EF (03) - BD (14)  
Timerange: 00/13:13:01 to 00/13:14:29

Plot file version 508 created 19-DEC-2018 17:58:49

AT2018\_RY007C.UVDATA.1

Freq = 4.9270 GHz, Bw = 16.000 MH No calibration applied and no bandpass applied

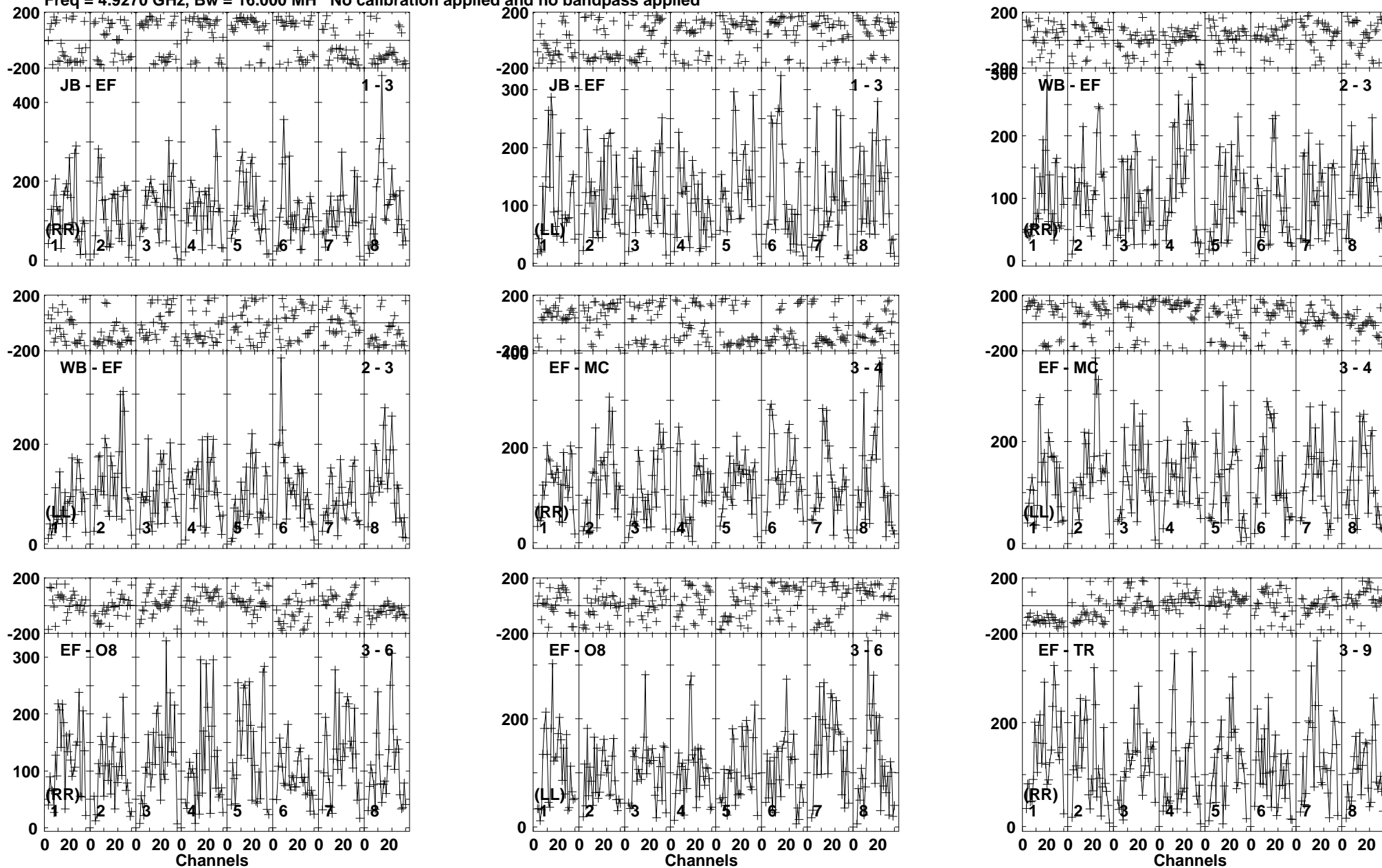

Lower frame: Micro Ampl Jy Top frame: Phas deg  
Vector averaged cross-power spectrum Baseline: JB (01) - EF (03)  
Timerange: 00/13:14:31 to 00/13:17:29

Plot file version 509 created 19-DEC-2018 17:58:50

AT2018\_RY007C.UVDATA.1

Freq = 4.9270 GHz, Bw = 16.000 MH No calibration applied and no bandpass applied

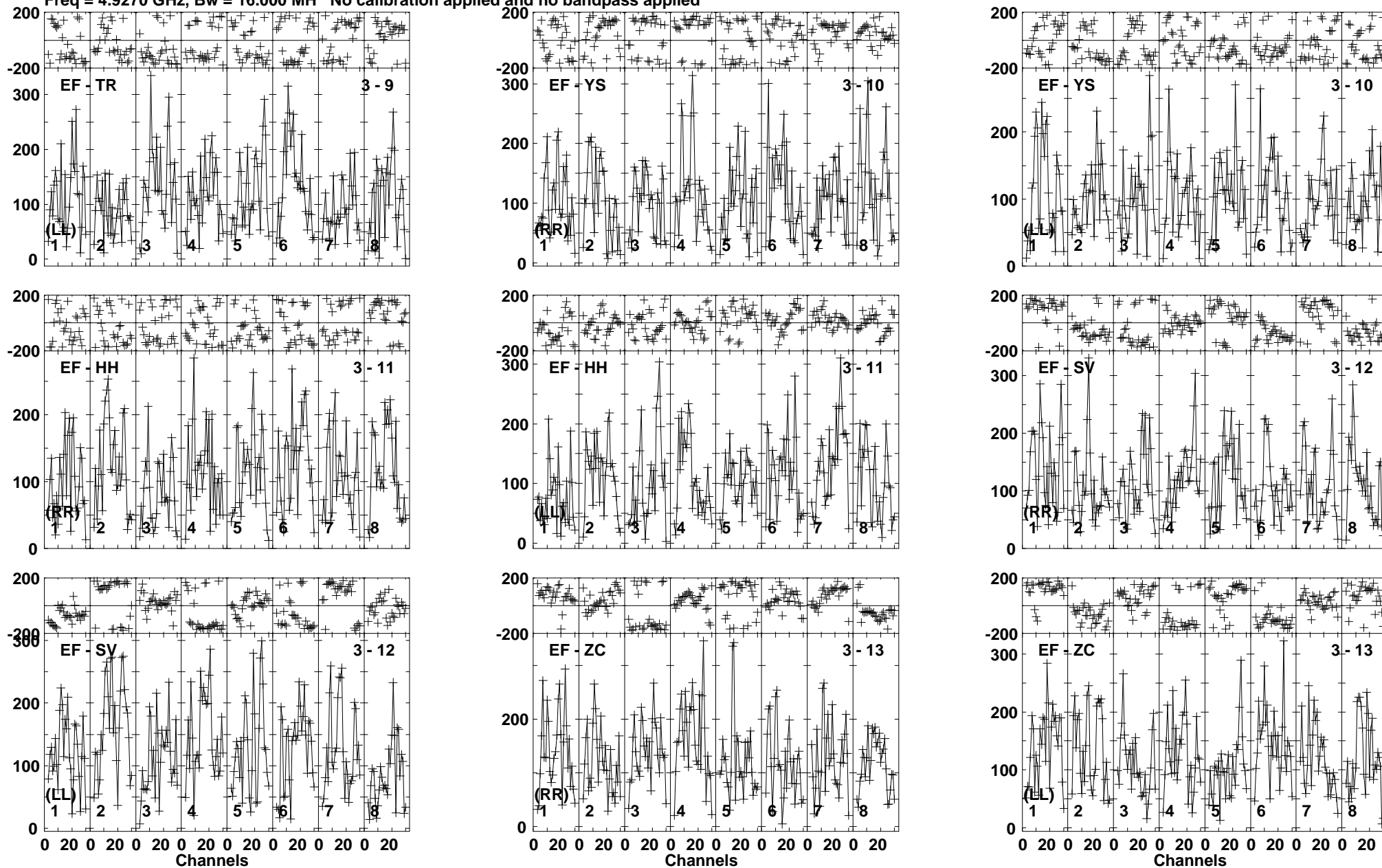

Lower frame: Micro Ampl Jy Top frame: Phas deg  
Vector averaged cross-power spectrum Baseline: EF (03) - TR (09)  
Timerange: 00/13:14:31 to 00/13:17:29

Plot file version 510 created 19-DEC-2018 17:58:50

AT2018\_RY007C.UVDATA.1

Freq = 4.9270 GHz, Bw = 16.000 MH No calibration applied and no bandpass applied

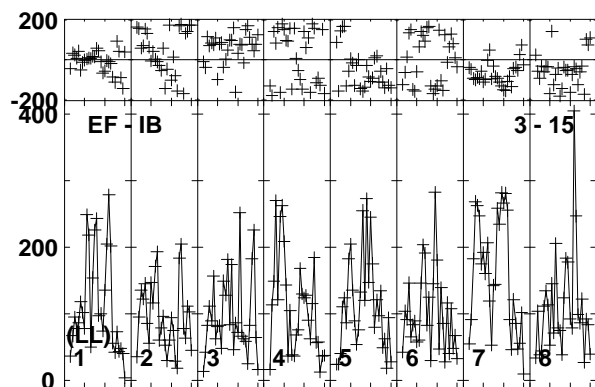
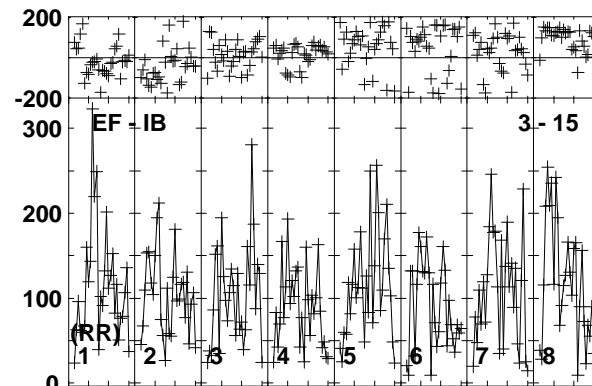
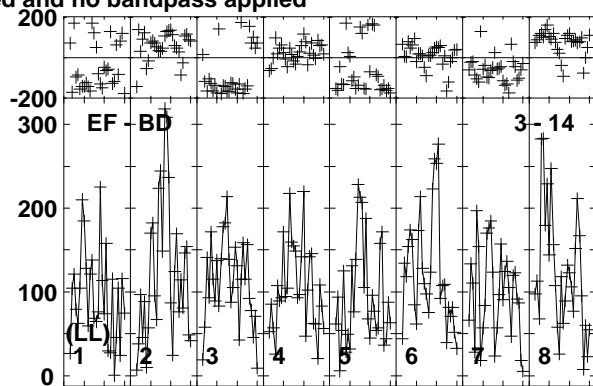
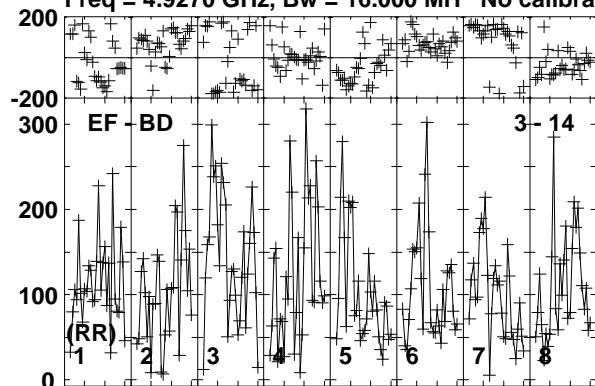

Lower frame: Micro Ampl Jy Top frame: Phas deg  
Vector averaged cross-power spectrum Baseline: EF (03) - BD (14)  
Timerange: 00/13:14:31 to 00/13:17:29

Plot file version 511 created 19-DEC-2018 17:58:50

J1619+2247 RY007C.UVDATA.1

Freq = 4.9270 GHz, Bw = 16.000 MH No calibration applied and no bandpass applied

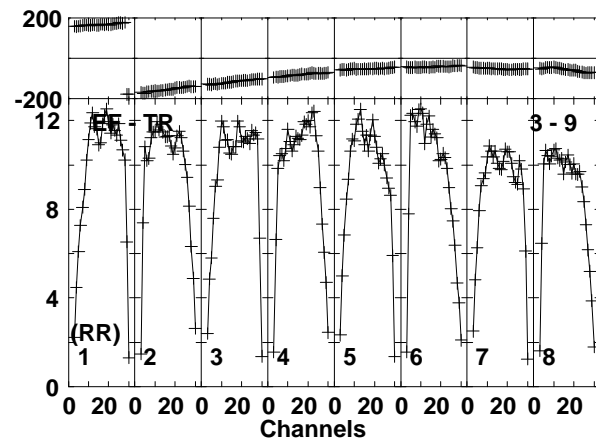
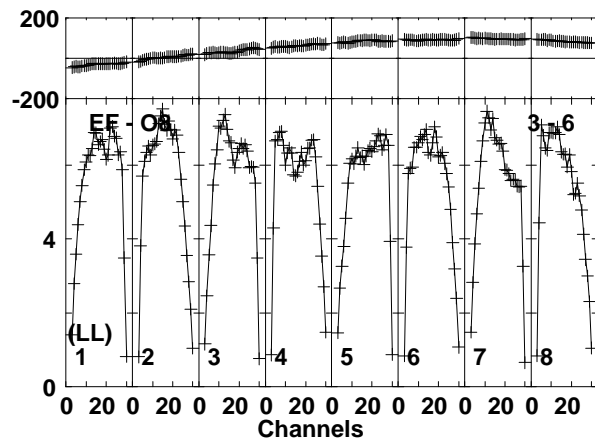
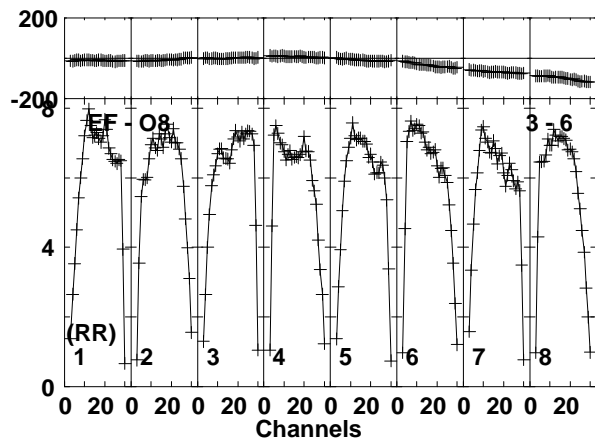
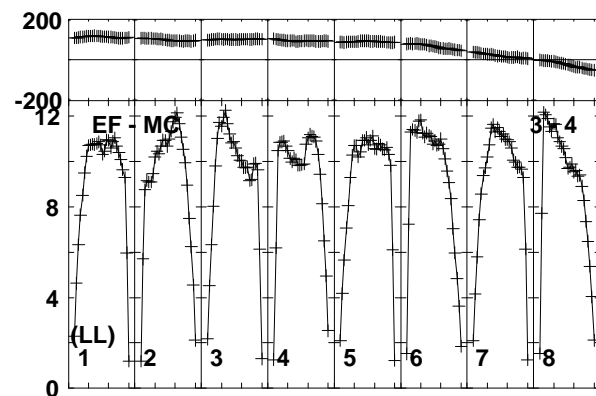
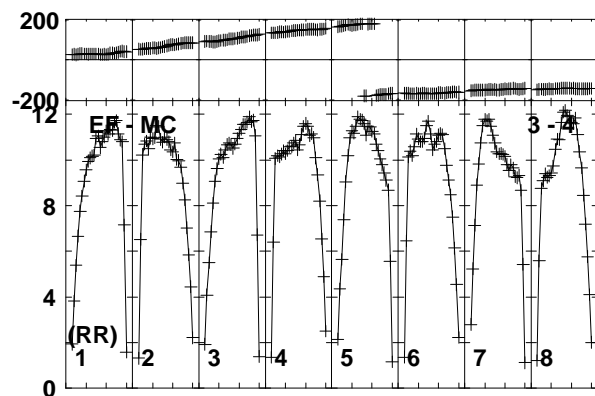
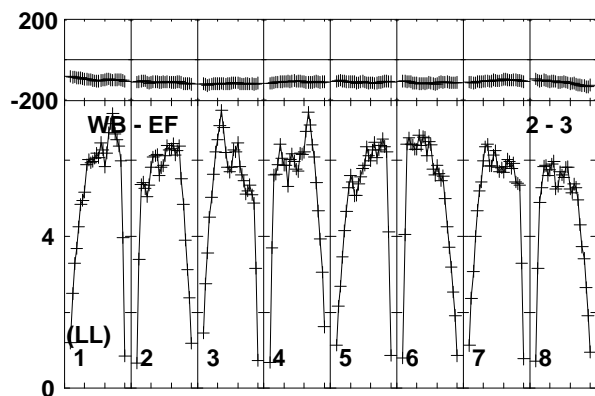
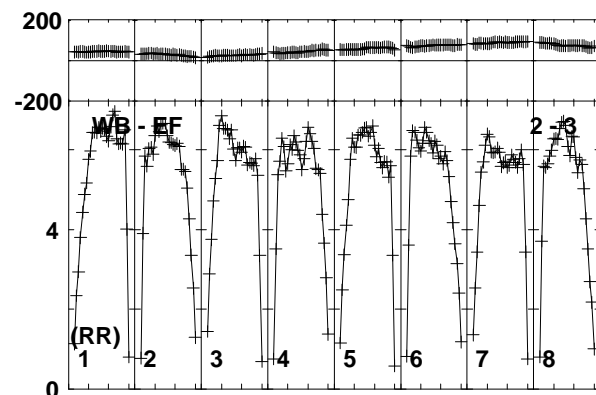
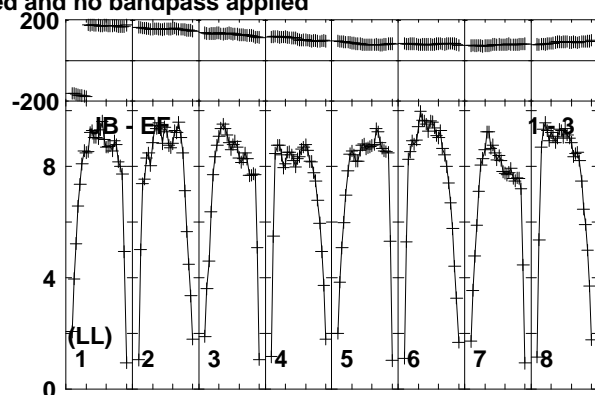
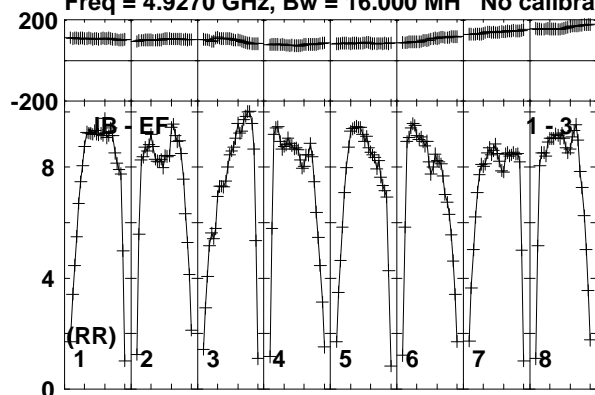

Lower frame: Milli Ampl Jy Top frame: Phas deg  
Vector averaged cross-power spectrum Baseline: JB (01) - EF (03)  
Timerange: 00/13:17:31 to 00/13:18:29

Plot file version 512 created 19-DEC-2018 17:58:50

J1619+2247 RY007C.UVDATA.1

Freq = 4.9270 GHz, Bw = 16.000 MH No calibration applied and no bandpass applied

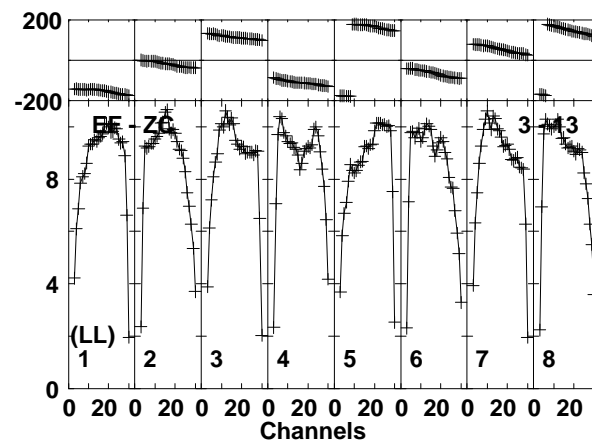
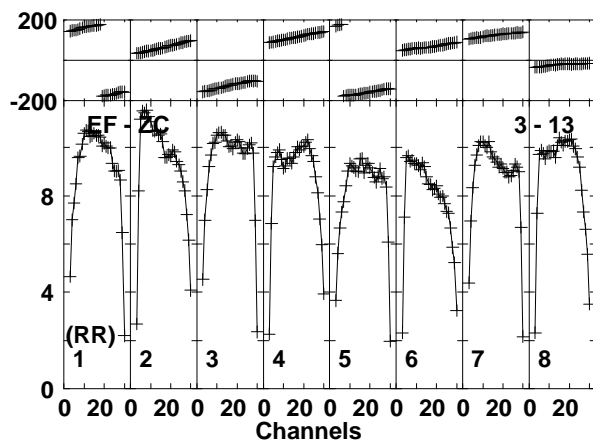
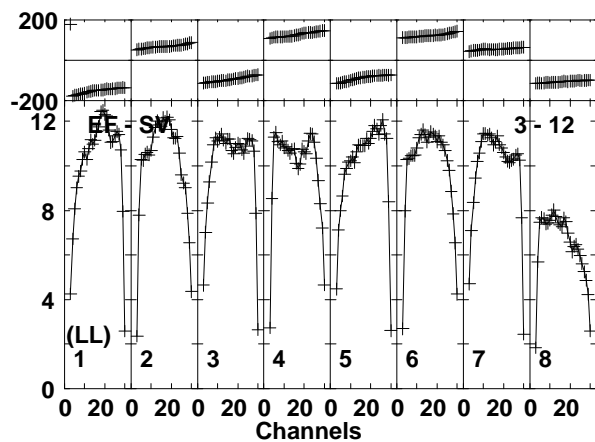
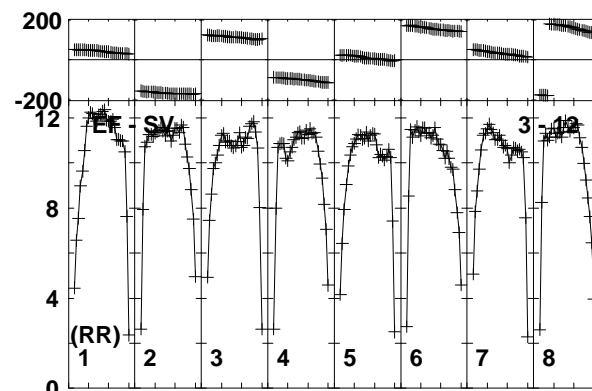
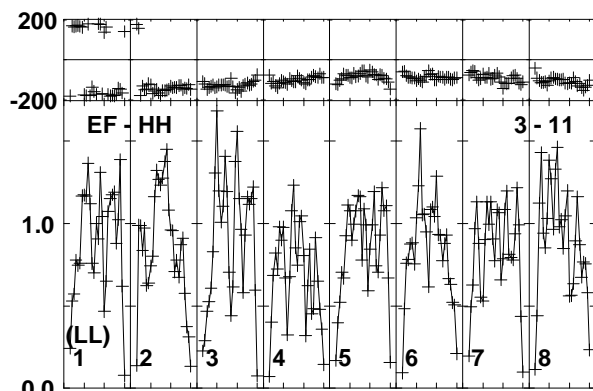
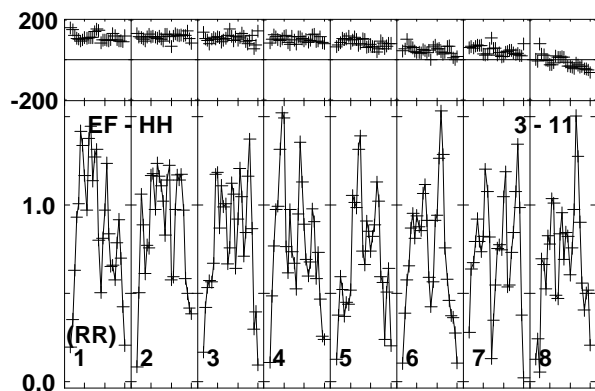
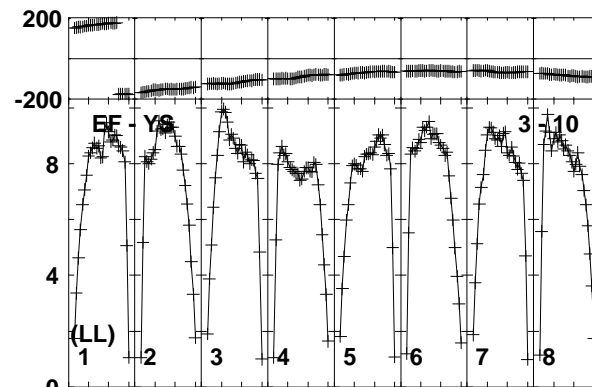
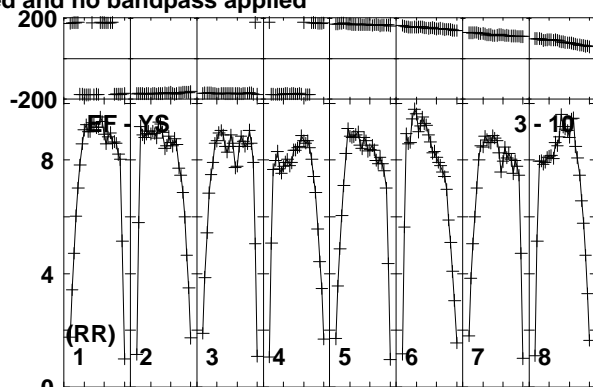
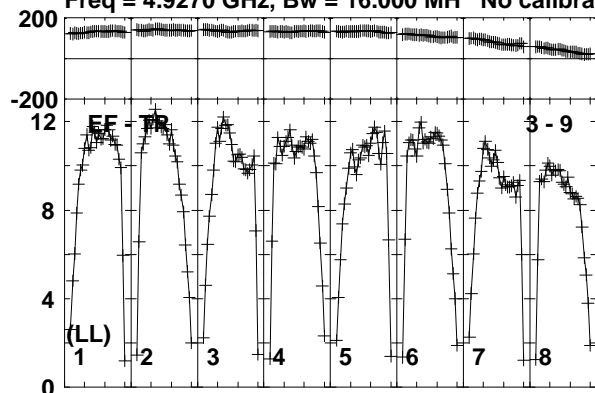

Lower frame: Milli Ampl Jy Top frame: Phas deg  
Vector averaged cross-power spectrum Baseline: EF (03) - TR (09)  
Timerange: 00/13:17:31 to 00/13:18:29

Plot file version 513 created 19-DEC-2018 17:58:50

J1619+2247 RY007C.UVDATA.1

Freq = 4.9270 GHz, Bw = 16.000 MH No calibration applied and no bandpass applied

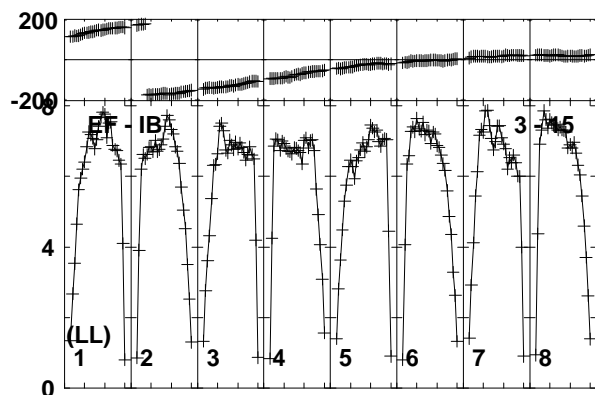
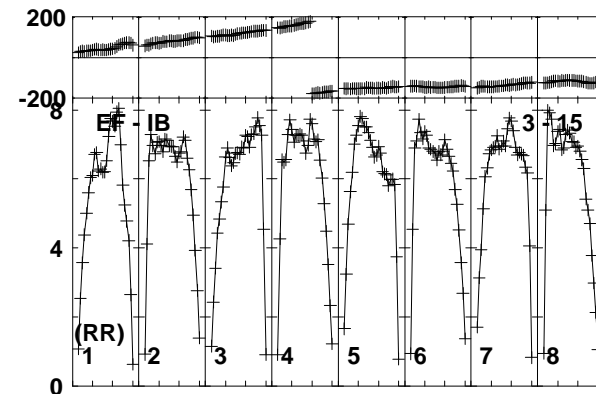
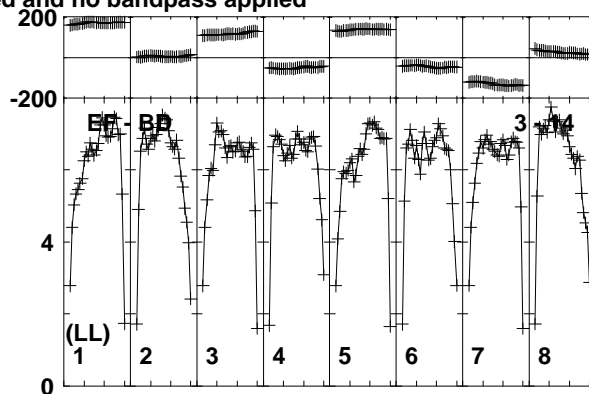
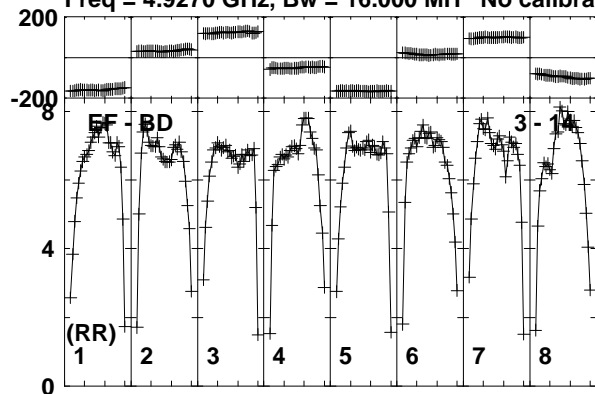

Lower frame: Milli Ampl Jy Top frame: Phas deg  
Vector averaged cross-power spectrum Baseline: EF (03) - BD (14)  
Timerange: 00/13:17:31 to 00/13:18:29

Plot file version 514 created 19-DEC-2018 17:58:50

AT2018\_RY007C.UVDATA.1

Freq = 4.9270 GHz, Bw = 16.000 MH No calibration applied and no bandpass applied

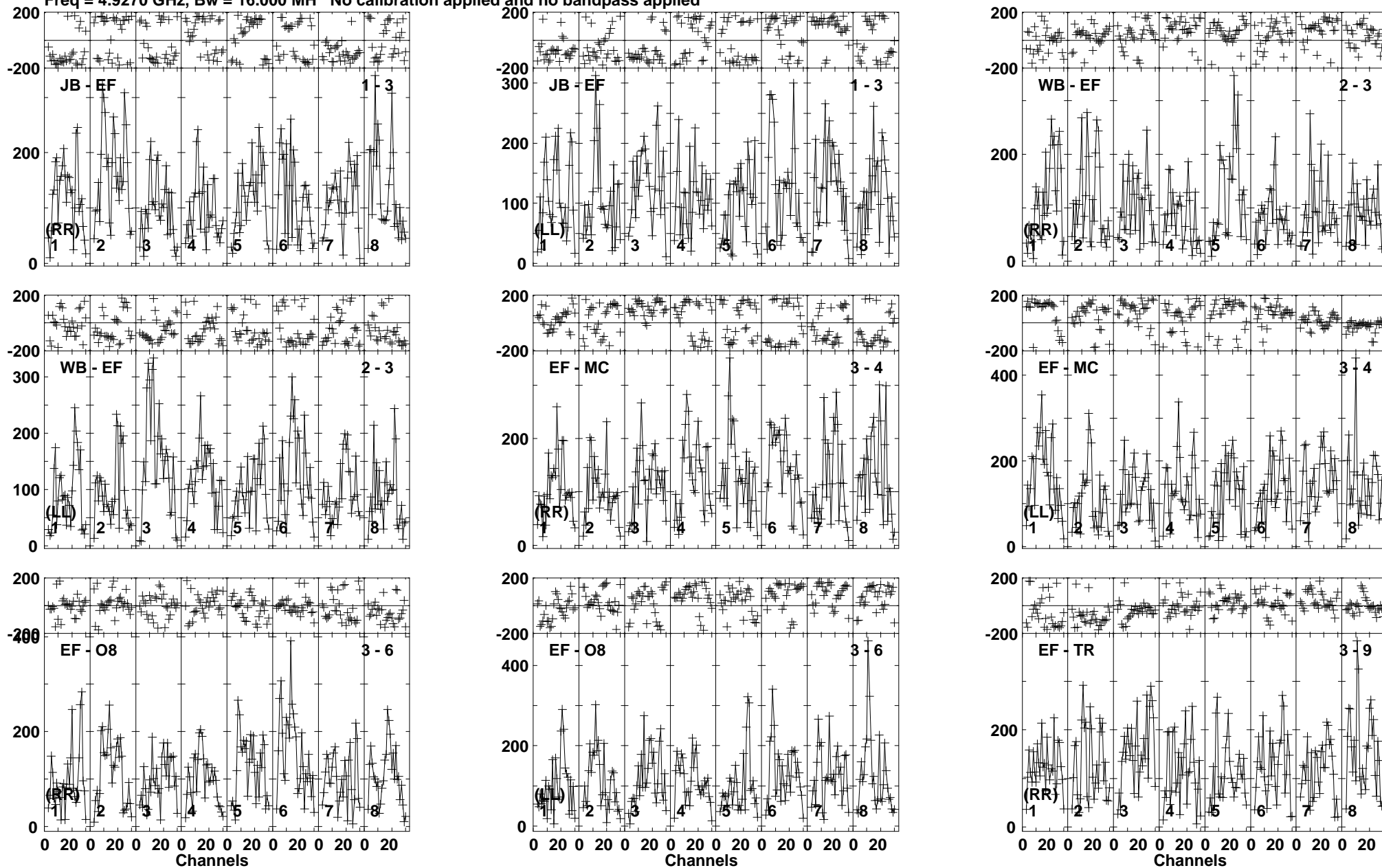

Lower frame: Micro Ampl Jy Top frame: Phas deg  
Vector averaged cross-power spectrum Baseline: JB (01) - EF (03)  
Timerange: 00/13:18:31 to 00/13:21:29



Plot file version 515 created 19-DEC-2018 17:58:50

AT2018\_RY007C.UVDATA.1

Freq = 4.9270 GHz, Bw = 16.000 MH No calibration applied and no bandpass applied

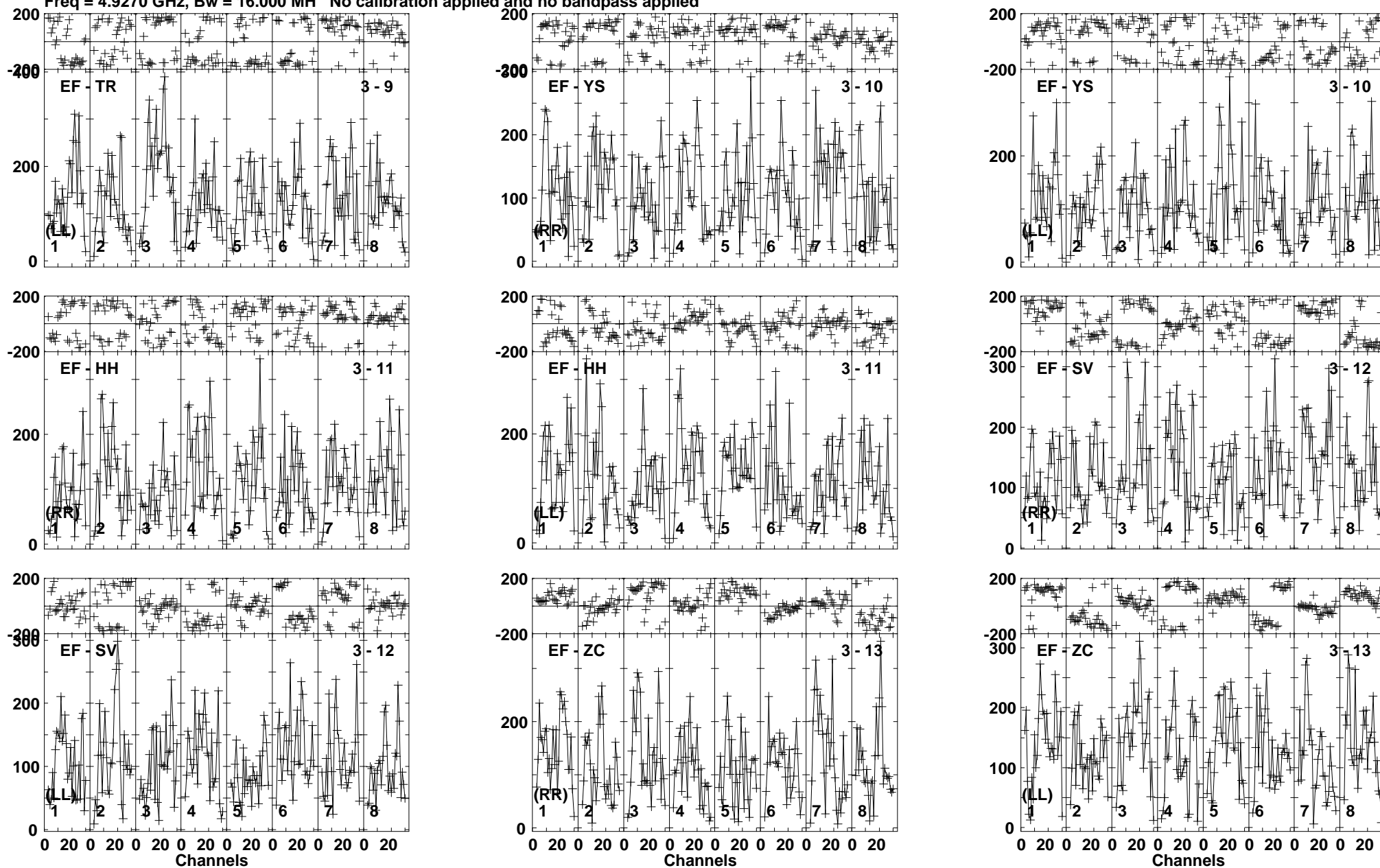

Lower frame: Micro Ampl Jy Top frame: Phas deg  
Vector averaged cross-power spectrum Baseline: EF (03) - TR (09)  
Timerange: 00/13:18:31 to 00/13:21:29

Plot file version 516 created 19-DEC-2018 17:58:50

AT2018\_RY007C.UVDATA.1

Freq = 4.9270 GHz, Bw = 16.000 MH No calibration applied and no bandpass applied

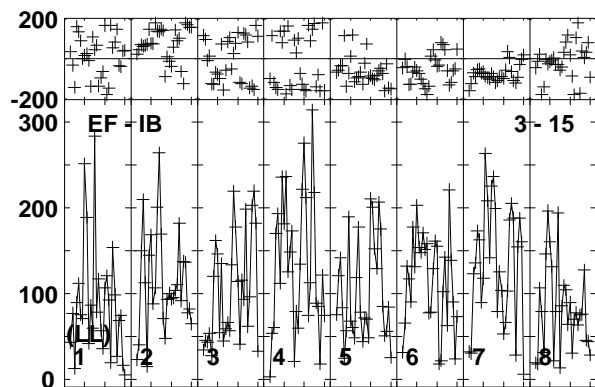
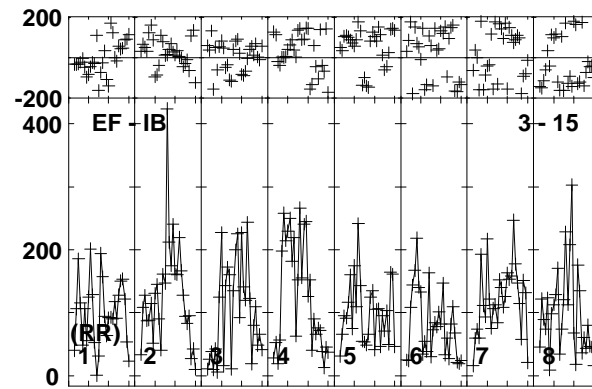
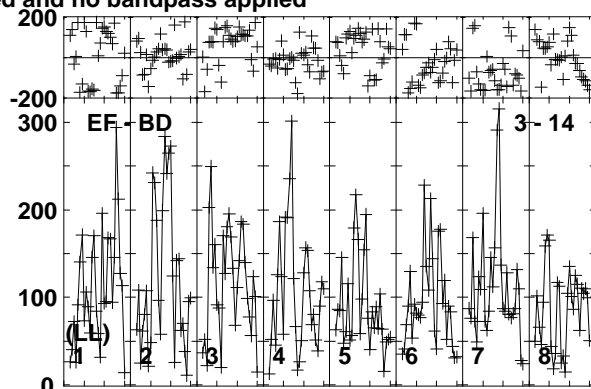
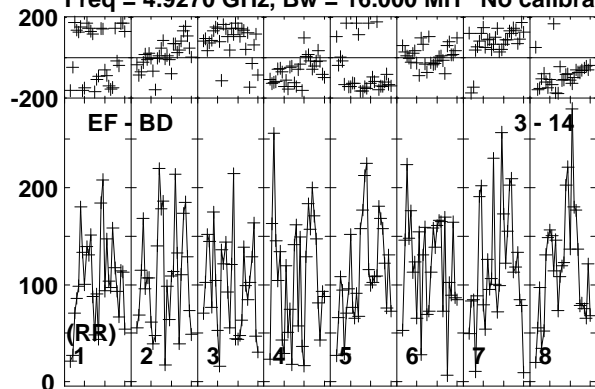

Lower frame: Micro Ampl Jy Top frame: Phas deg  
Vector averaged cross-power spectrum Baseline: EF (03) - BD (14)  
Timerange: 00/13:18:31 to 00/13:21:29

Plot file version 517 created 19-DEC-2018 17:58:50

J1619+2247 RY007C.UVDATA.1

Freq = 4.9270 GHz, Bw = 16.000 MH No calibration applied and no bandpass applied

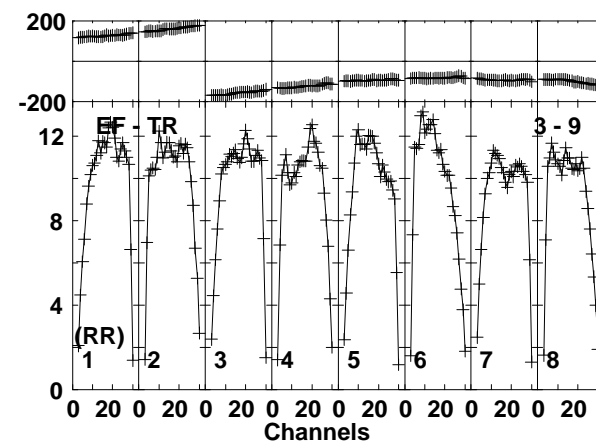
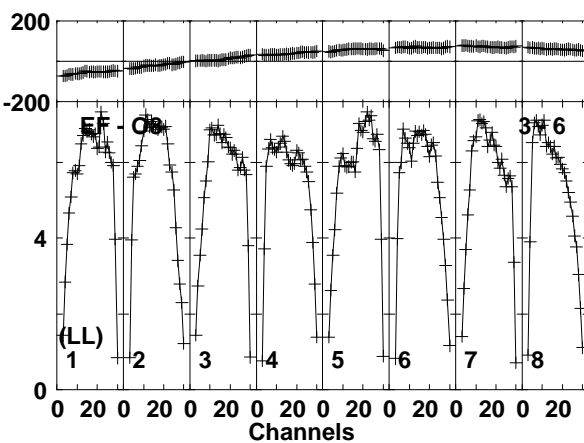
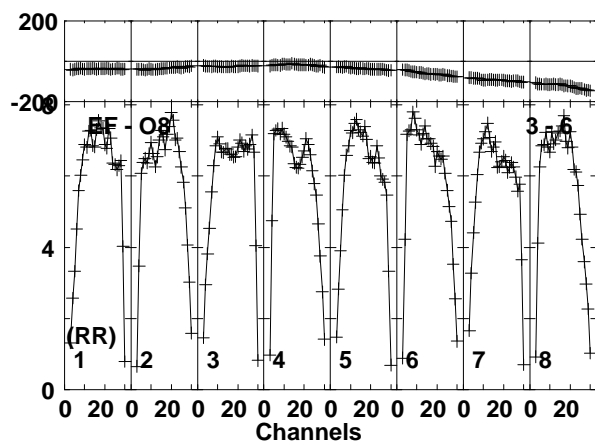
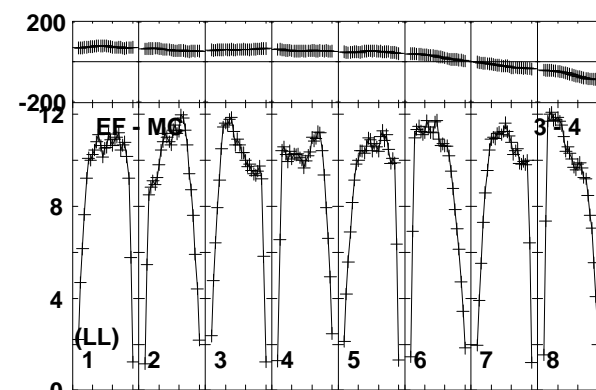
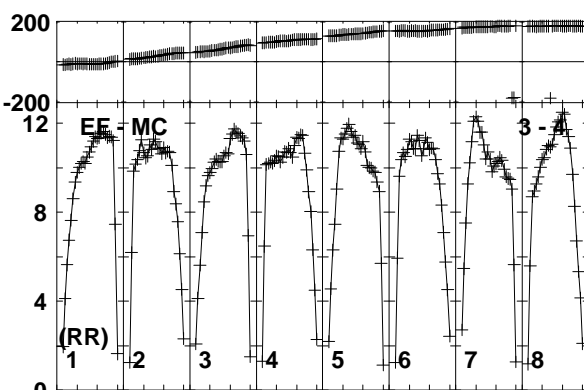
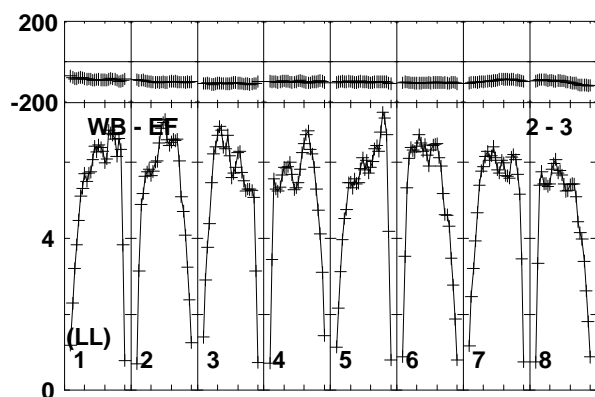
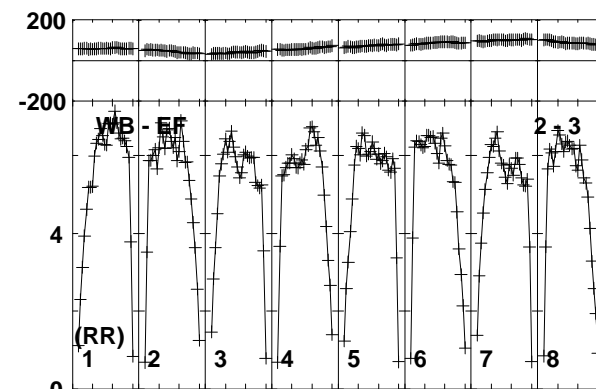
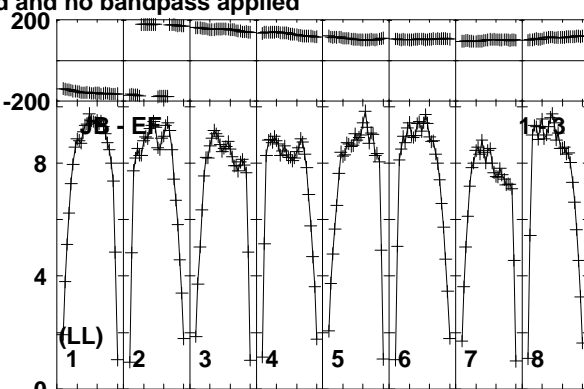
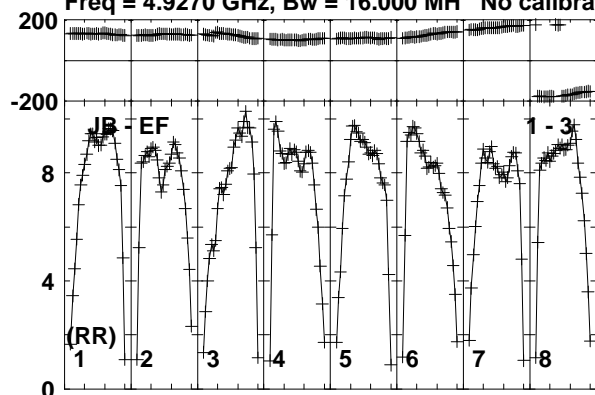

Lower frame: Milli Ampl Jy Top frame: Phas deg  
Vector averaged cross-power spectrum Baseline: JB (01) - EF (03)  
Timerange: 00/13:21:31 to 00/13:22:29

Plot file version 518 created 19-DEC-2018 17:58:50

J1619+2247 RY007C.UVDATA.1

Freq = 4.9270 GHz, Bw = 16.000 MH No calibration applied and no bandpass applied

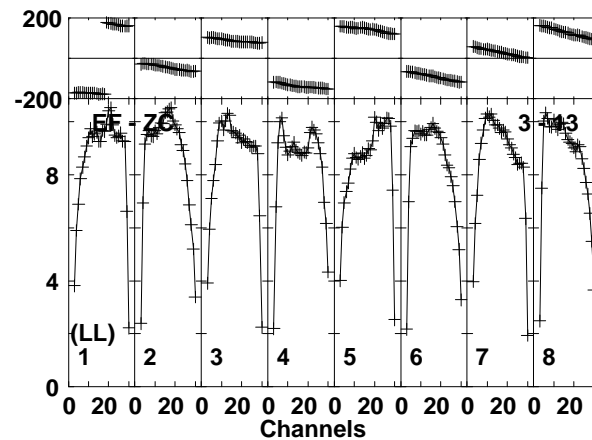
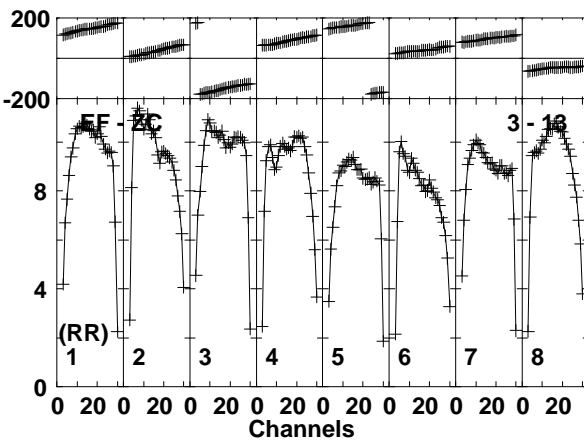
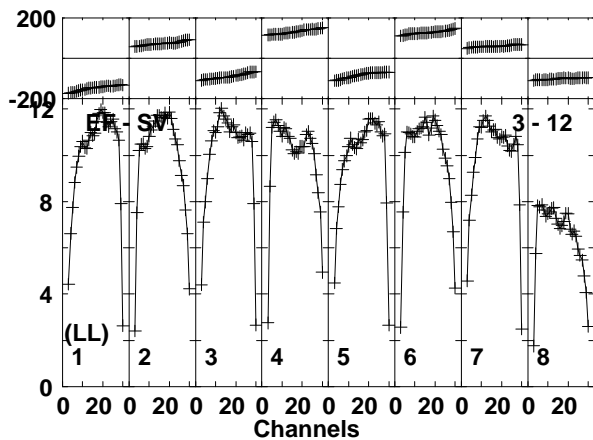
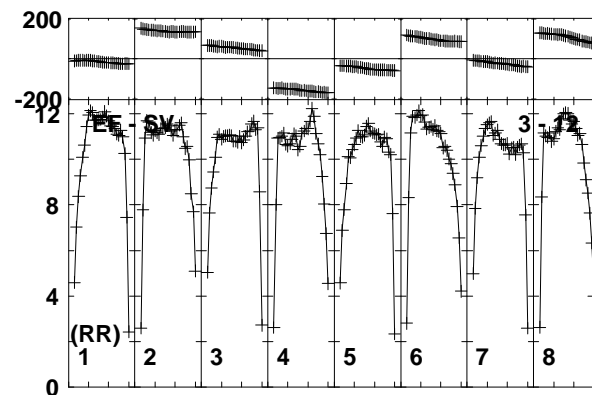
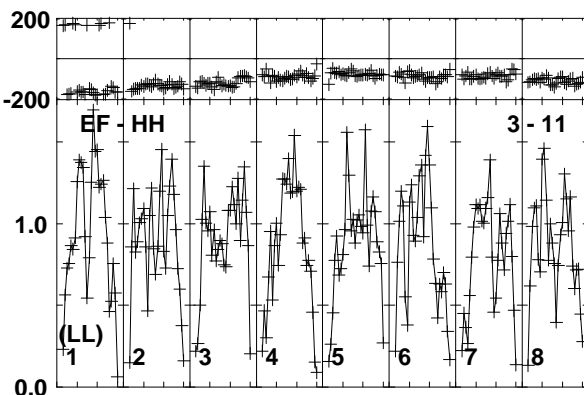
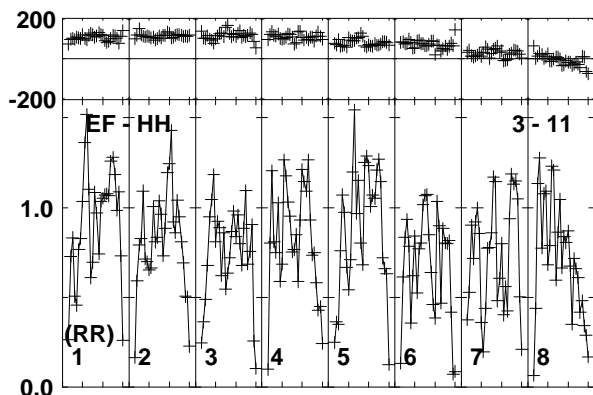
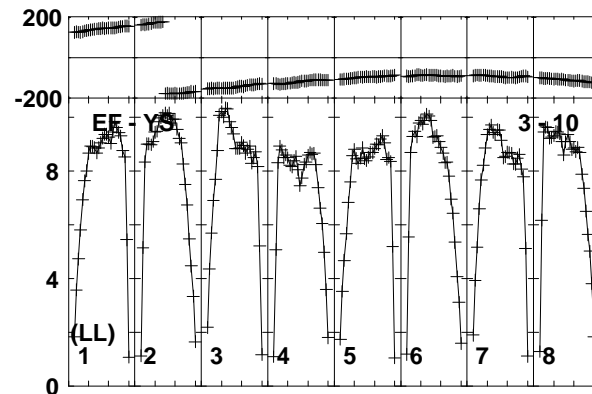
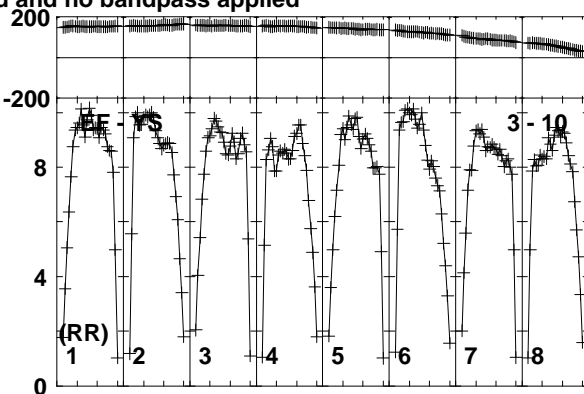
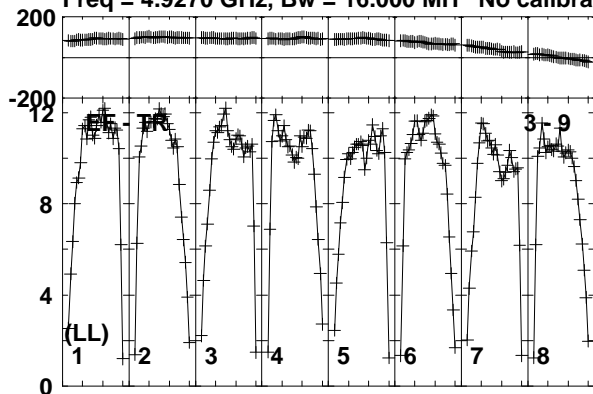

Lower frame: Milli Ampl Jy Top frame: Phas deg  
Vector averaged cross-power spectrum Baseline: EF (03) - TR (09)  
Timerange: 00/13:21:31 to 00/13:22:29

Plot file version 519 created 19-DEC-2018 17:58:50

J1619+2247 RY007C.UVDATA.1

Freq = 4.9270 GHz, Bw = 16.000 MH No calibration applied and no bandpass applied

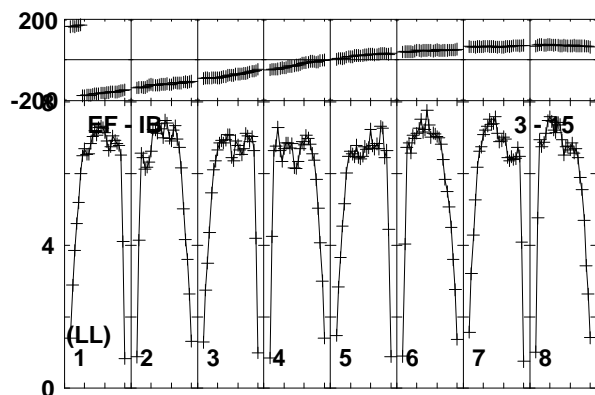
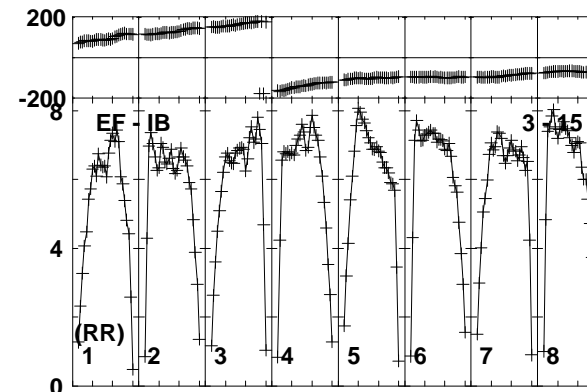
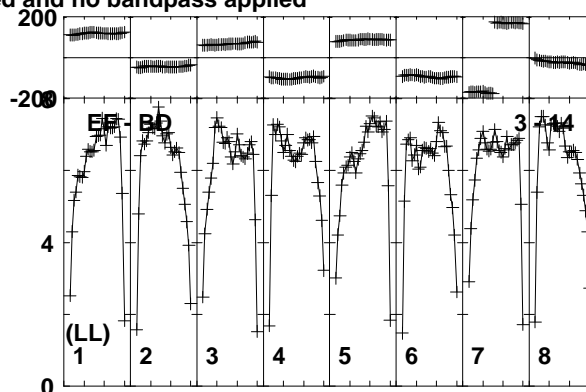
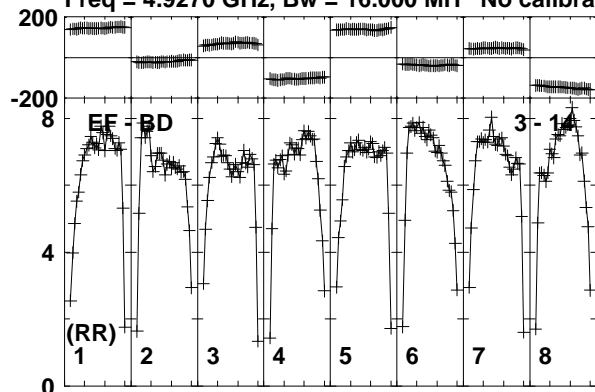

Lower frame: Milli Ampl Jy Top frame: Phas deg  
Vector averaged cross-power spectrum Baseline: EF (03) - BD (14)  
Timerange: 00/13:21:31 to 00/13:22:29

Plot file version 520 created 19-DEC-2018 17:58:50

VLA1 RY007C.UVDATA.1

Freq = 4.9270 GHz, Bw = 16.000 MH No calibration applied and no bandpass applied

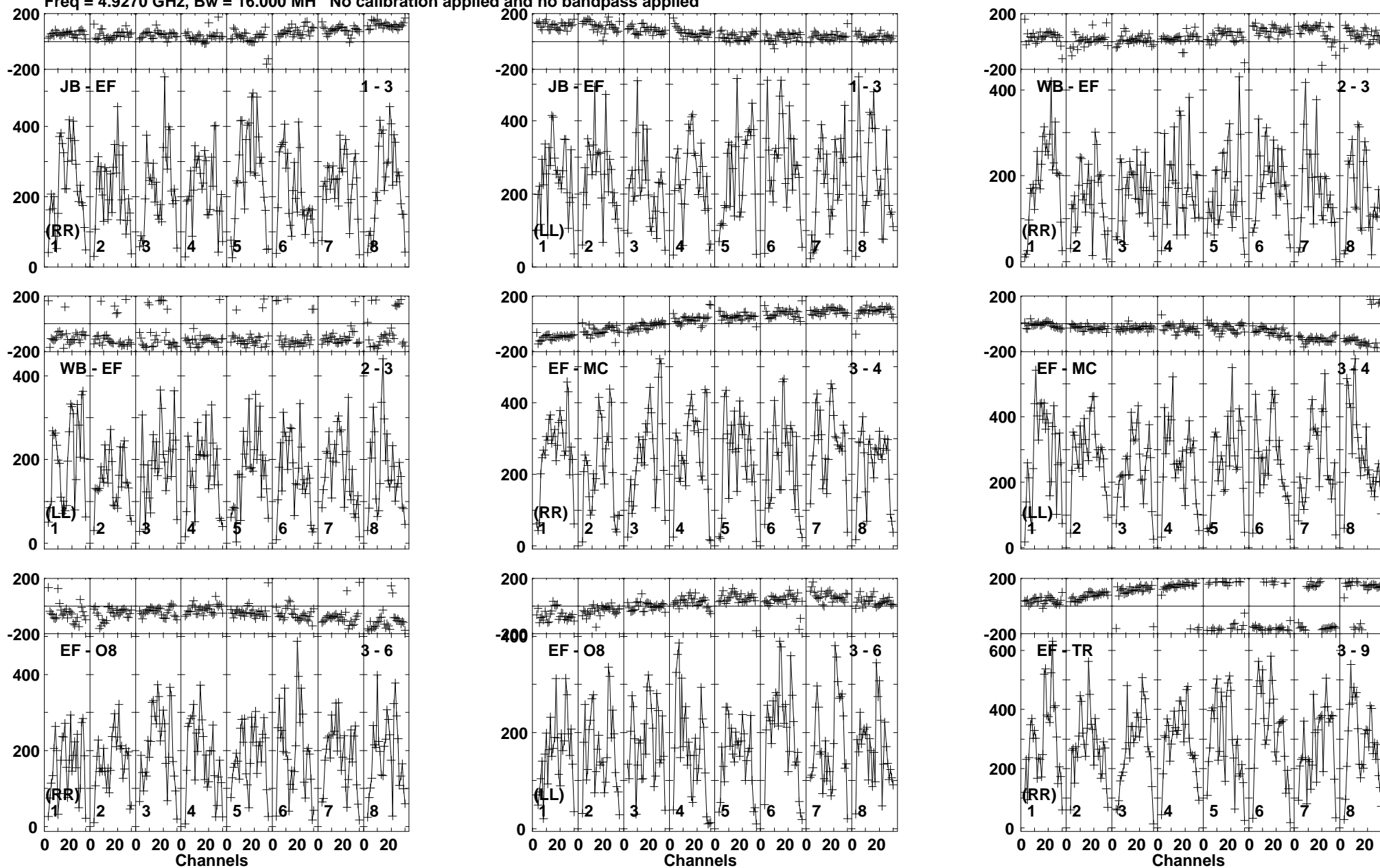

Lower frame: Micro Ampl Jy Top frame: Phas deg  
Vector averaged cross-power spectrum Baseline: JB (01) - EF (03)  
Timerange: 00/13:23:01 to 00/13:24:59

Plot file version 521 created 19-DEC-2018 17:58:50

VLA1 RY007C.UVDATA.1

Freq = 4.9270 GHz, Bw = 16.000 MH No calibration applied and no bandpass applied

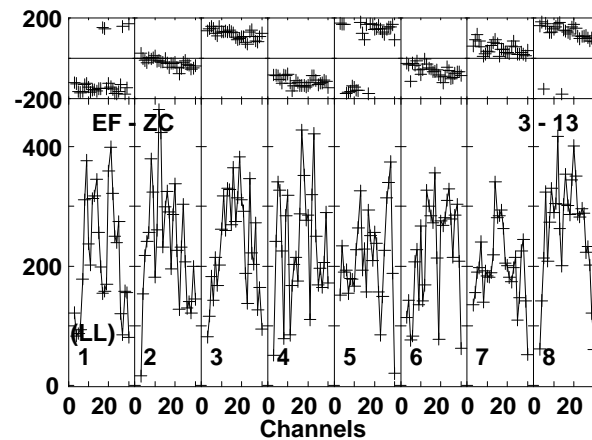
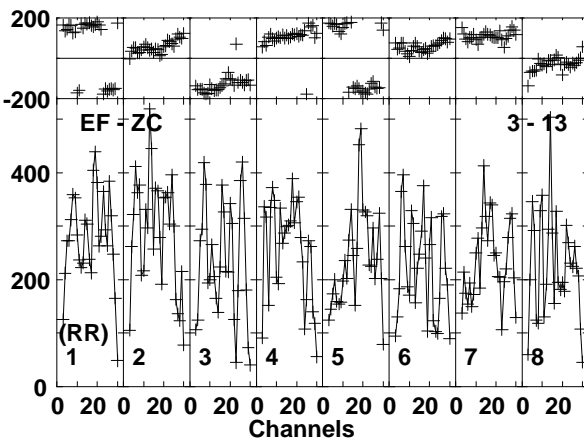
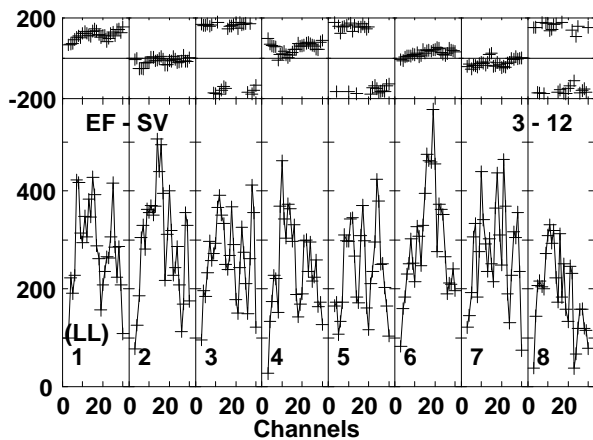
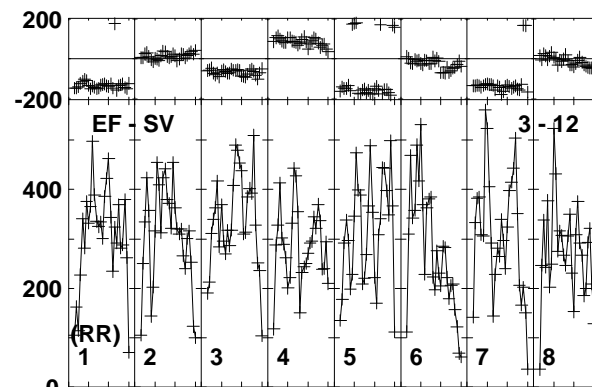
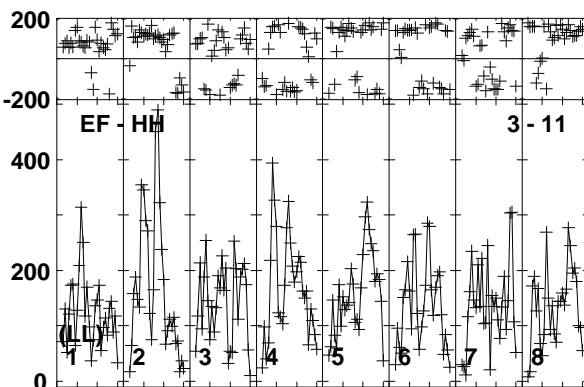
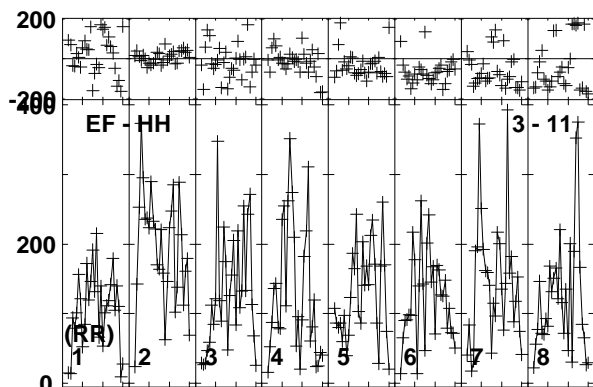
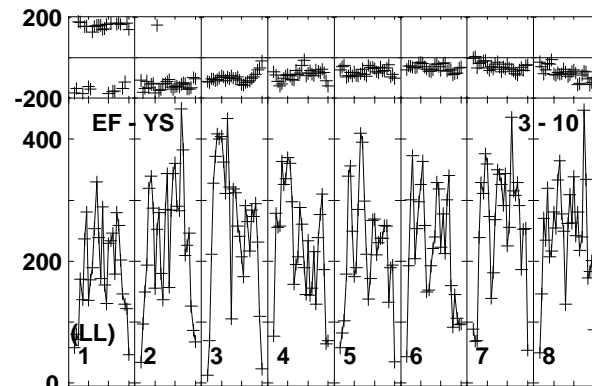
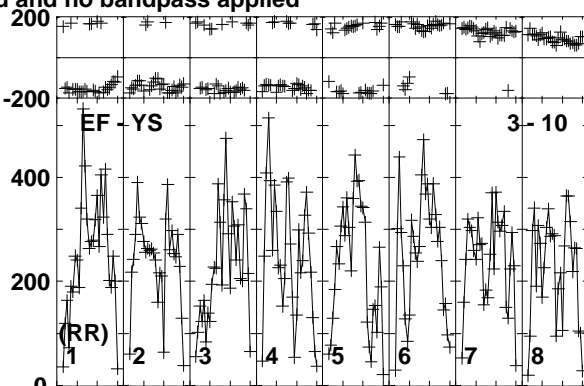
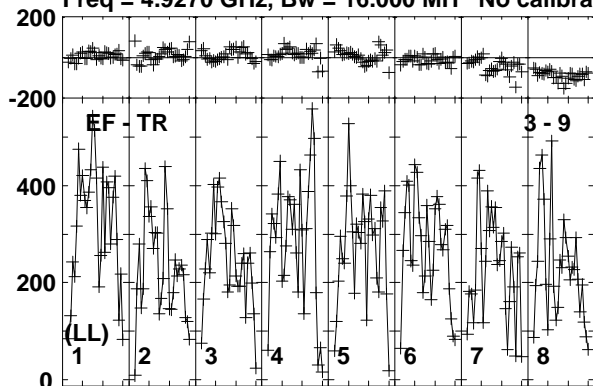

Lower frame: Micro Ampl Jy Top frame: Phas deg  
Vector averaged cross-power spectrum Baseline: EF (03) - TR (09)  
Timerange: 00/13:23:01 to 00/13:24:59

Plot file version 522 created 19-DEC-2018 17:58:50

VLA1 RY007C.UVDATA.1

Freq = 4.9270 GHz, Bw = 16.000 MH No calibration applied and no bandpass applied

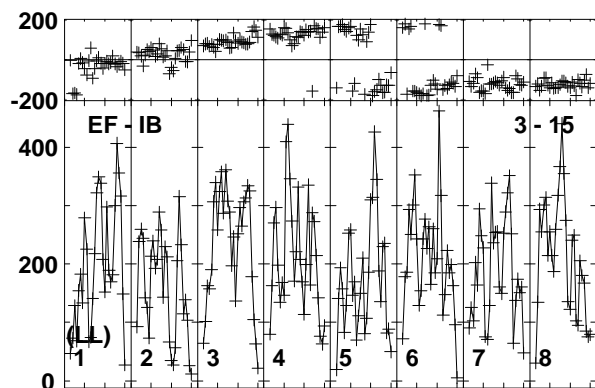
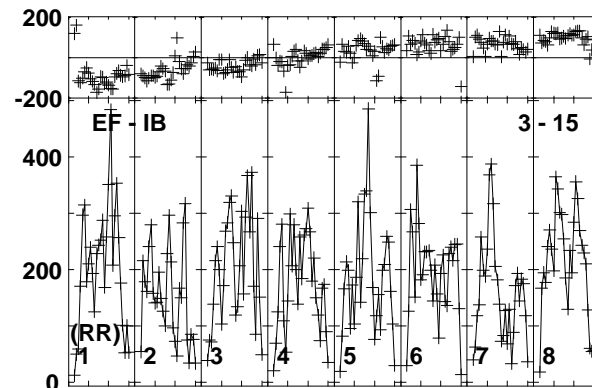
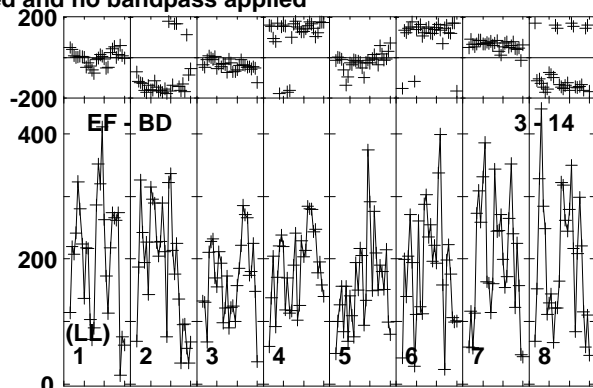
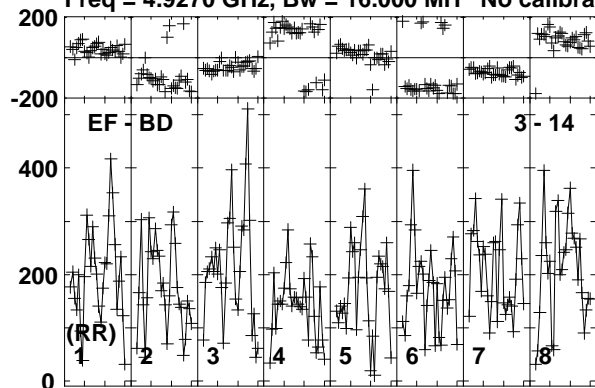

Lower frame: Micro Ampl Jy Top frame: Phas deg  
Vector averaged cross-power spectrum Baseline: EF (03) - BD (14)  
Timerange: 00/13:23:01 to 00/13:24:59



Plot file version 523 created 19-DEC-2018 17:58:50

J1619+2247 RY007C.UVDATA.1

Freq = 4.9270 GHz, Bw = 16.000 MH No calibration applied and no bandpass applied

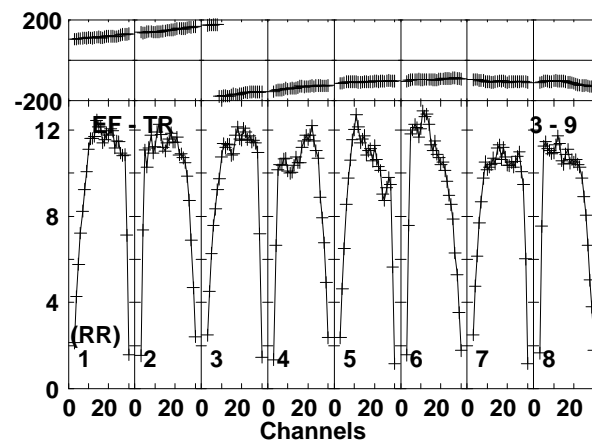
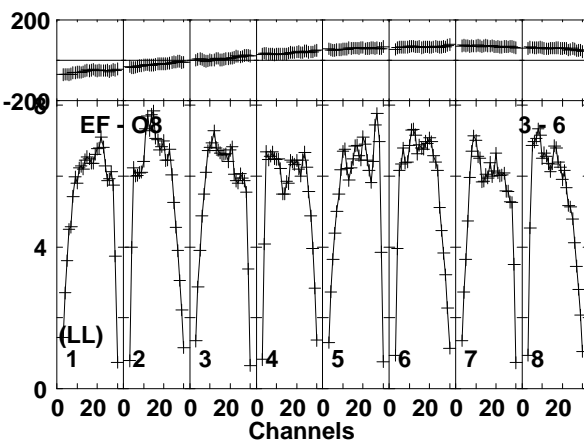
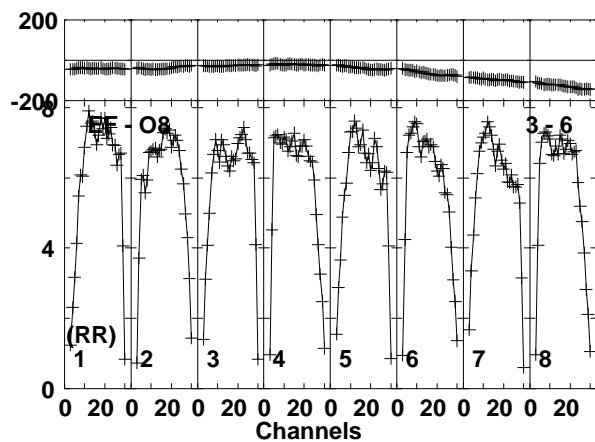
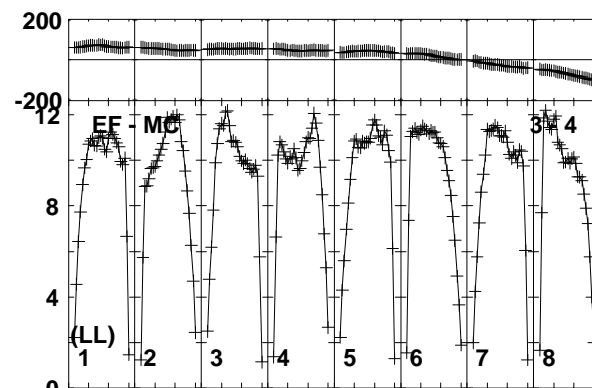
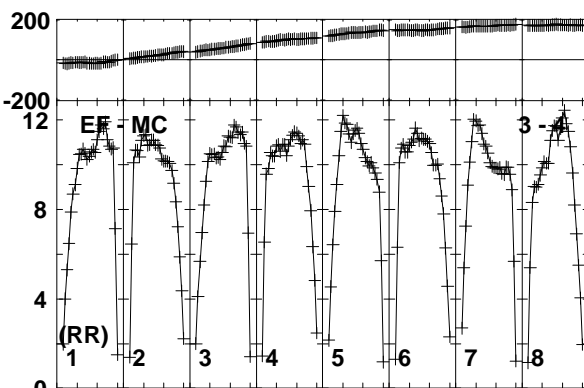
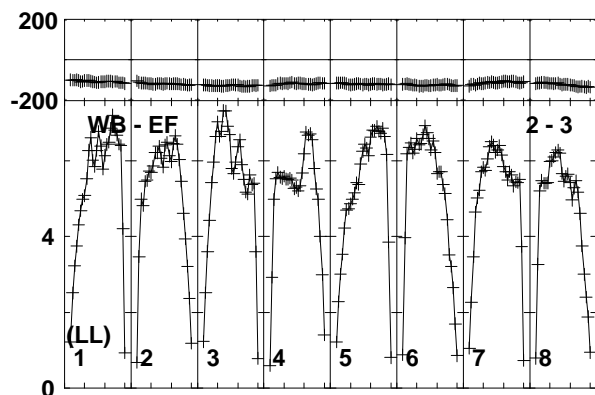
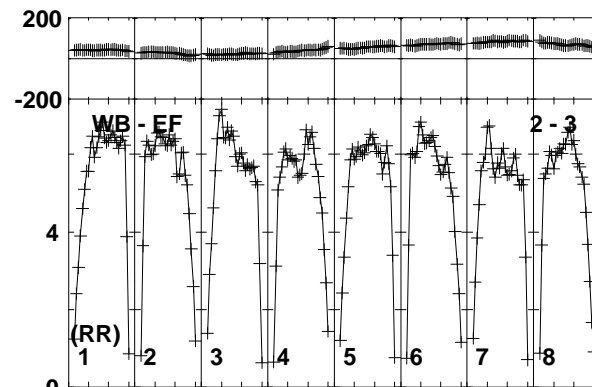
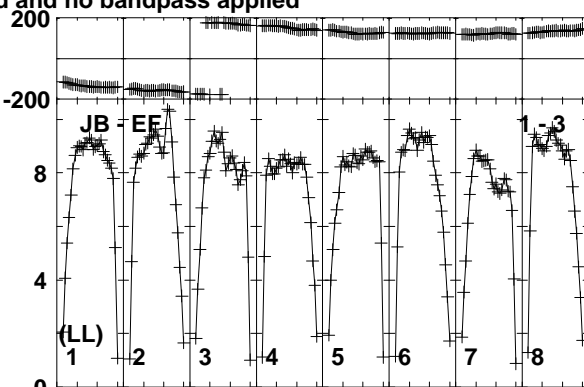
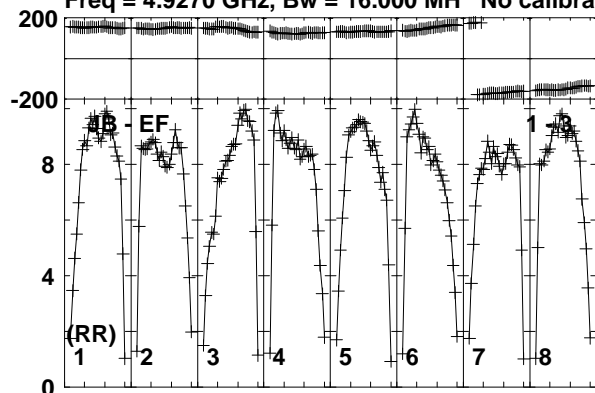

Lower frame: Milli Ampl Jy Top frame: Phas deg  
Vector averaged cross-power spectrum Baseline: JB (01) - EF (03)  
Timerange: 00/13:25:01 to 00/13:25:59

Plot file version 524 created 19-DEC-2018 17:58:50

J1619+2247 RY007C.UVDATA.1

Freq = 4.9270 GHz, Bw = 16.000 MH No calibration applied and no bandpass applied

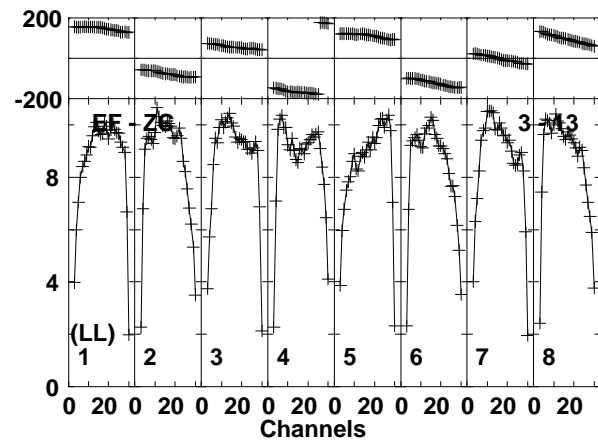
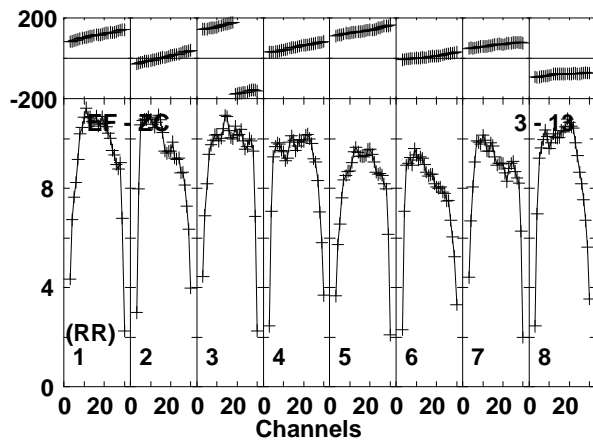
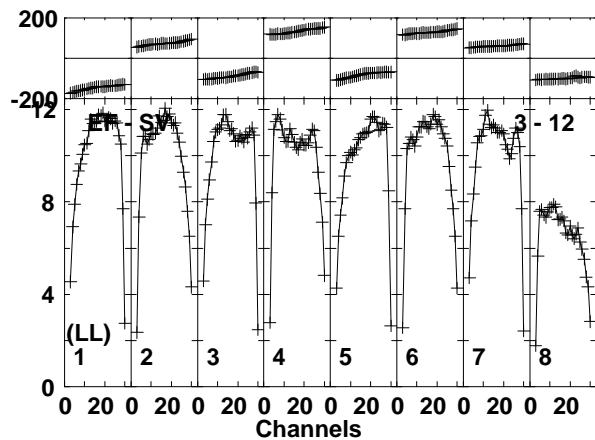
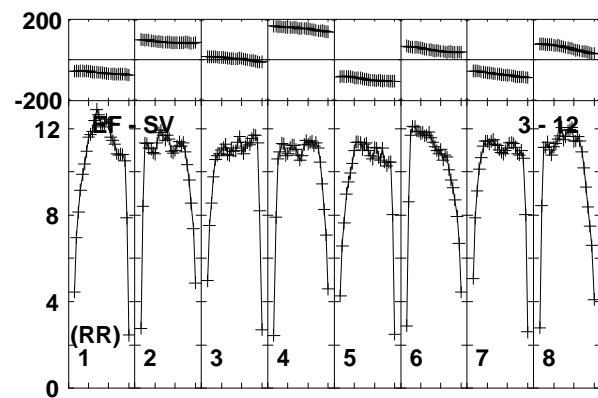
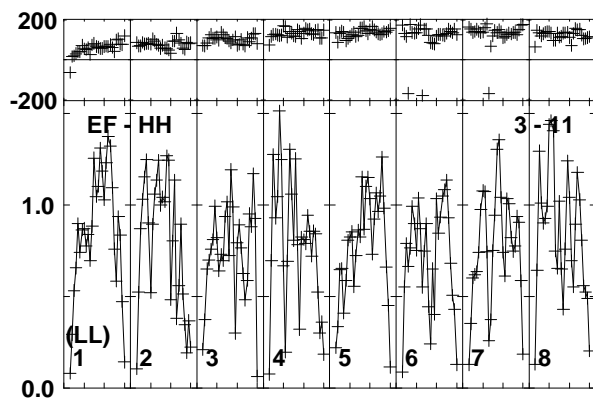
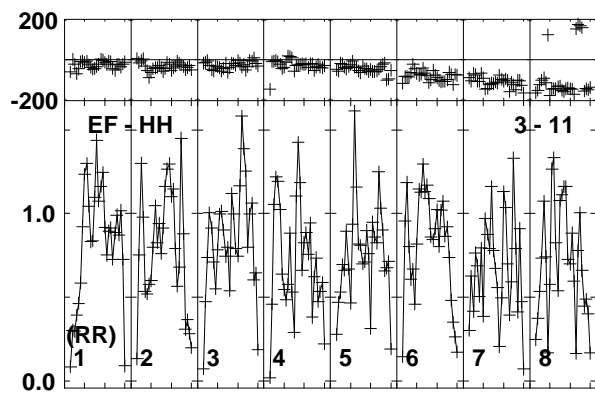
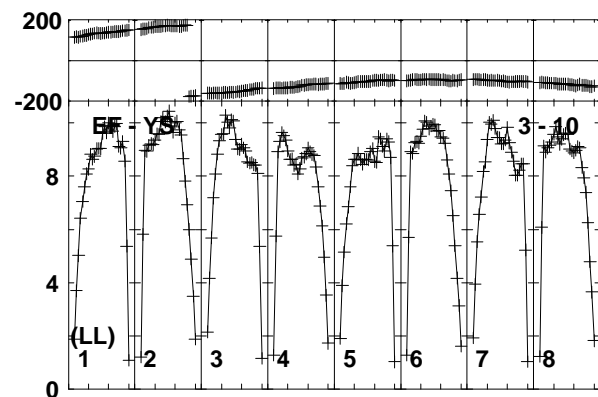
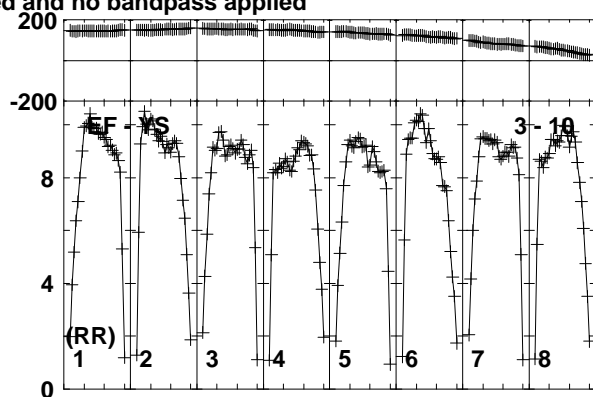
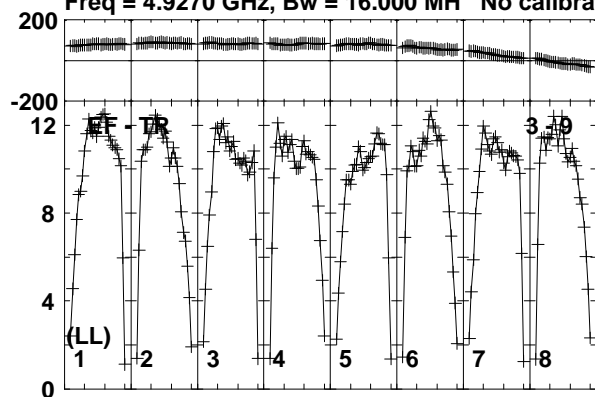

Lower frame: Milli Ampl Jy Top frame: Phas deg  
Vector averaged cross-power spectrum Baseline: EF (03) - TR (09)  
Timerange: 00/13:25:01 to 00/13:25:59

Plot file version 525 created 19-DEC-2018 17:58:50

J1619+2247 RY007C.UVDATA.1

Freq = 4.9270 GHz, Bw = 16.000 MH No calibration applied and no bandpass applied

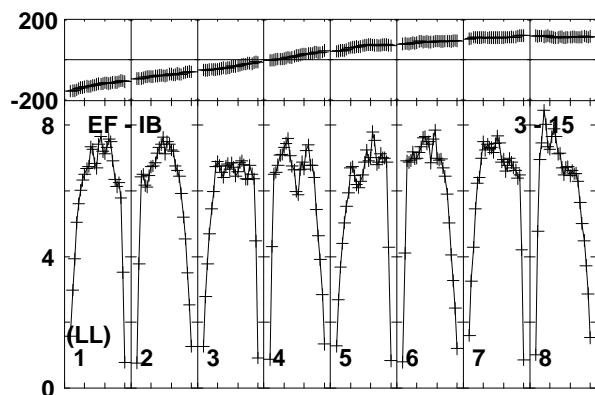
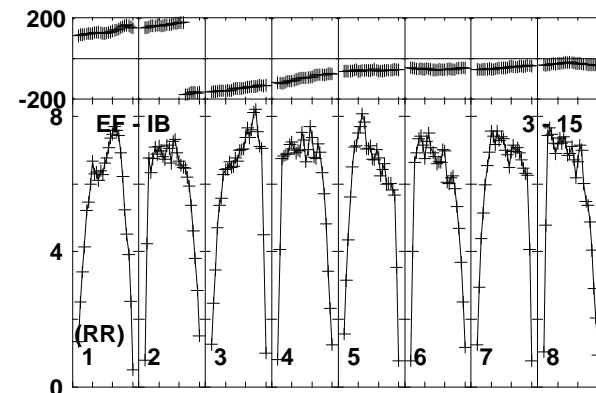
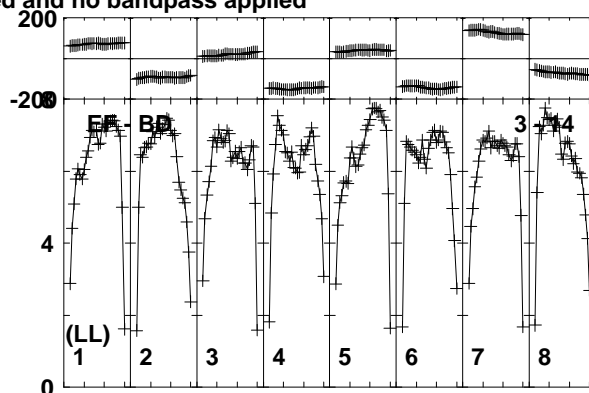
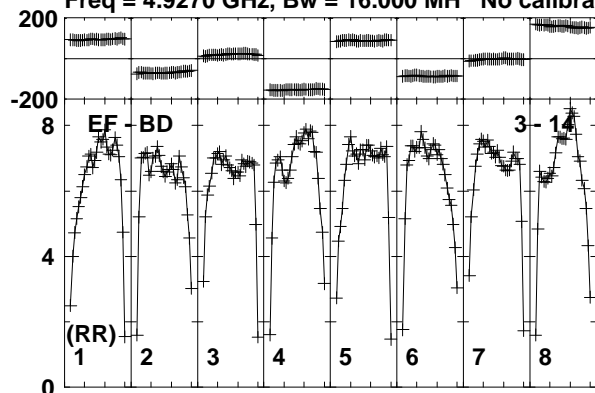

Lower frame: Milli Ampl Jy Top frame: Phas deg  
Vector averaged cross-power spectrum Baseline: EF (03) - BD (14)  
Timerange: 00/13:25:01 to 00/13:25:59

Plot file version 526 created 19-DEC-2018 17:58:50

AT2018\_RY007C.UVDATA.1

Freq = 4.9270 GHz, Bw = 16.000 MH No calibration applied and no bandpass applied

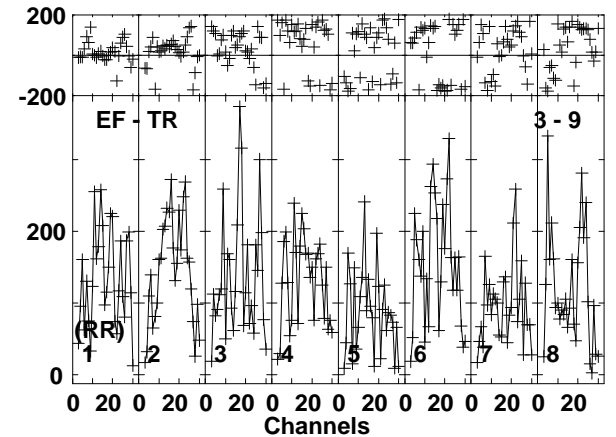
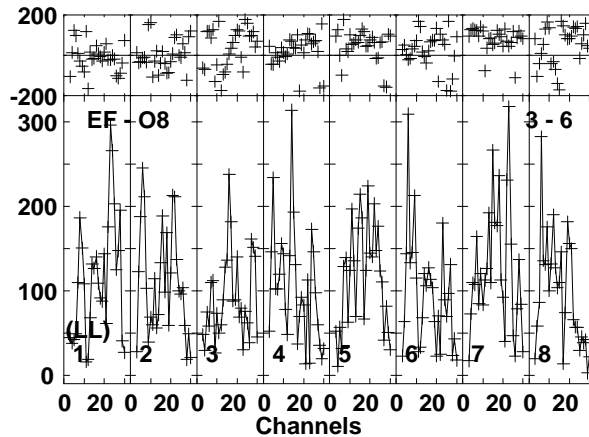
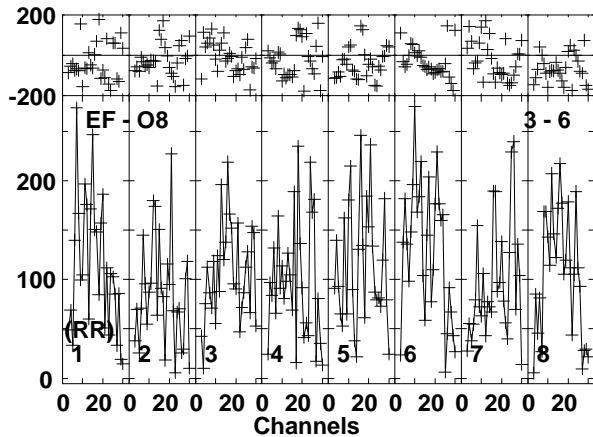
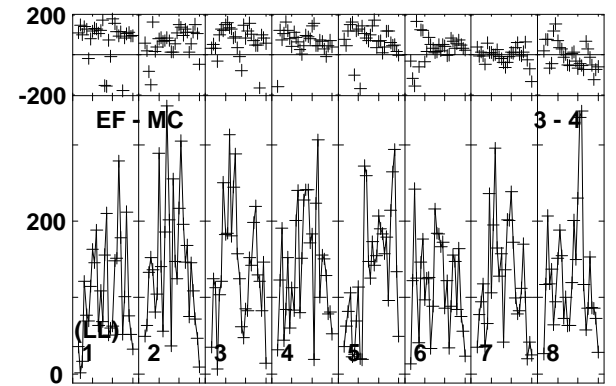
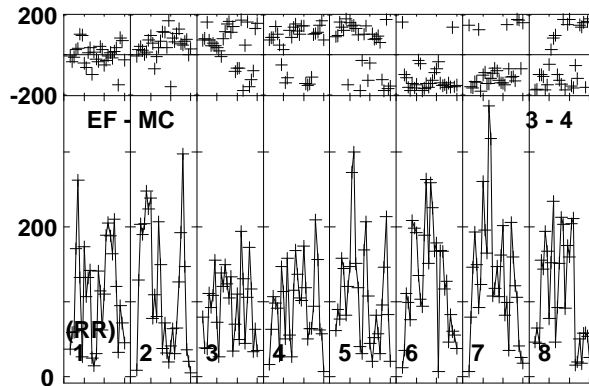
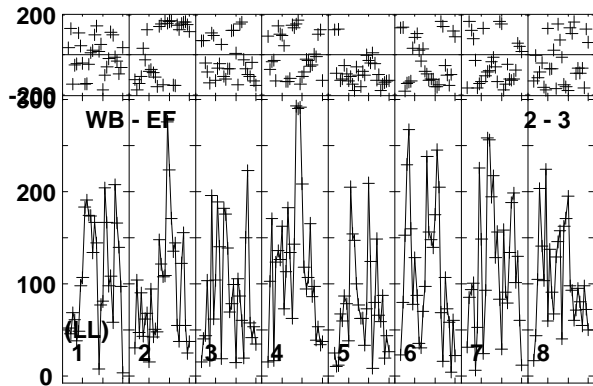
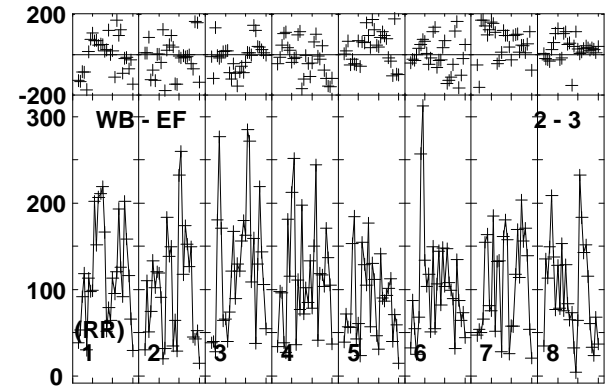
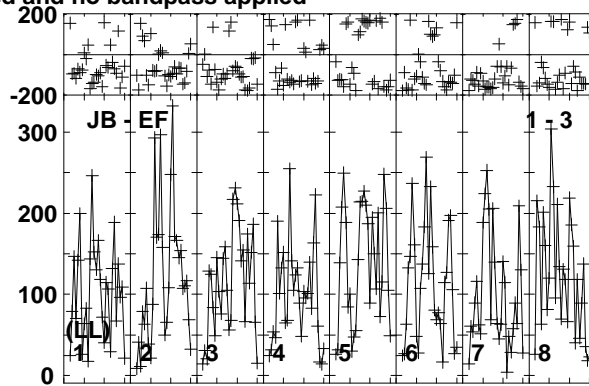
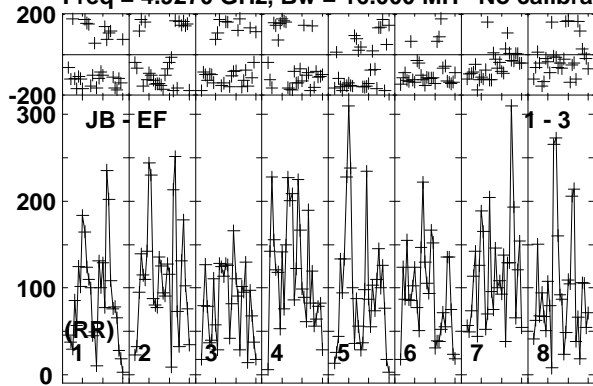

Lower frame: Micro Ampl Jy Top frame: Phas deg  
Vector averaged cross-power spectrum Baseline: JB (01) - EF (03)  
Timerange: 00/13:26:01 to 00/13:28:59

Plot file version 527 created 19-DEC-2018 17:58:51

AT2018\_RY007C.UVDATA.1

Freq = 4.9270 GHz, Bw = 16.000 MH No calibration applied and no bandpass applied

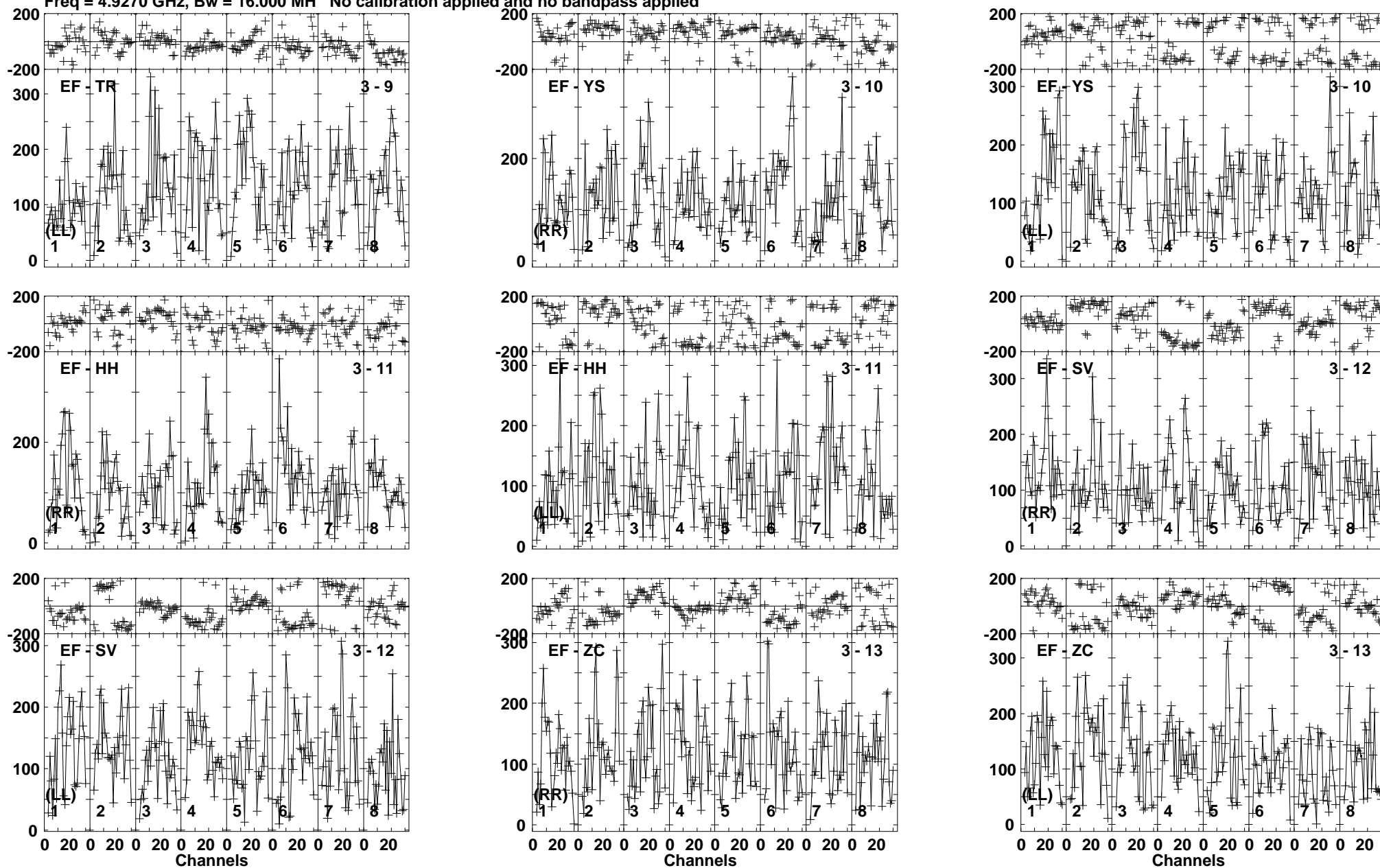

Lower frame: Micro Ampl Jy Top frame: Phas deg  
Vector averaged cross-power spectrum Baseline: EF (03) - TR (09)  
Timerange: 00/13:26:01 to 00/13:28:59

Plot file version 528 created 19-DEC-2018 17:58:51

AT2018\_RY007C.UVDATA.1

Freq = 4.9270 GHz, Bw = 16.000 MH No calibration applied and no bandpass applied

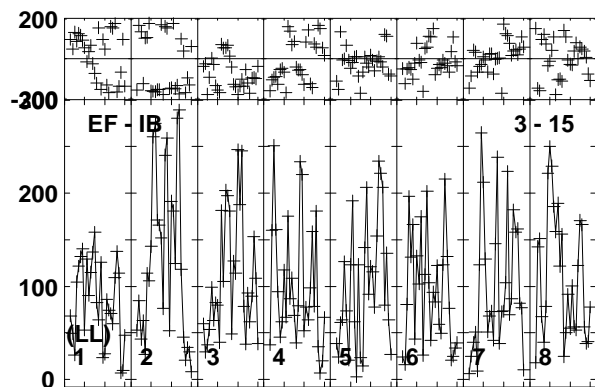
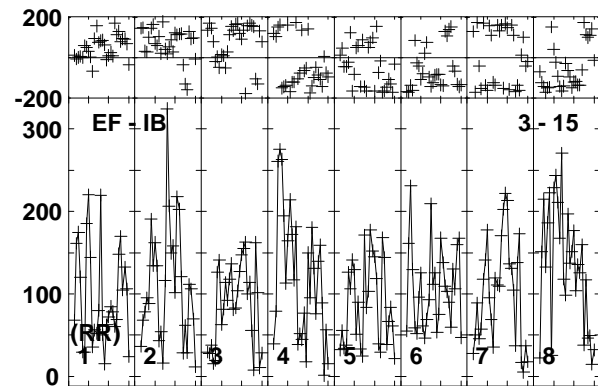
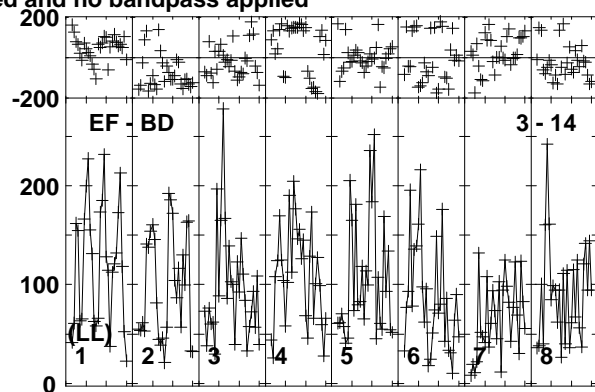
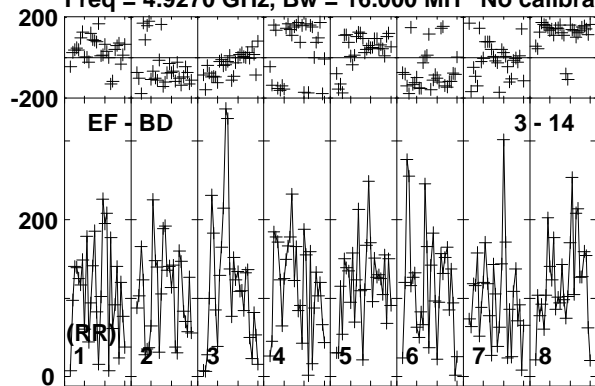

Lower frame: Micro Ampl Jy Top frame: Phas deg  
Vector averaged cross-power spectrum Baseline: EF (03) - BD (14)  
Timerange: 00/13:26:01 to 00/13:28:59

Plot file version 529 created 19-DEC-2018 17:58:51

J1619+2247 RY007C.UVDATA.1

Freq = 4.9270 GHz, Bw = 16.000 MH No calibration applied and no bandpass applied

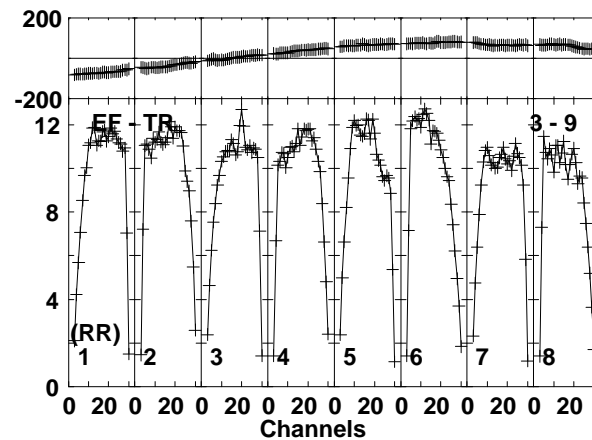
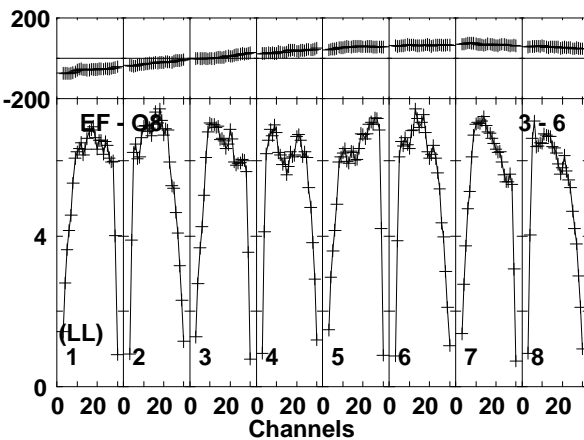
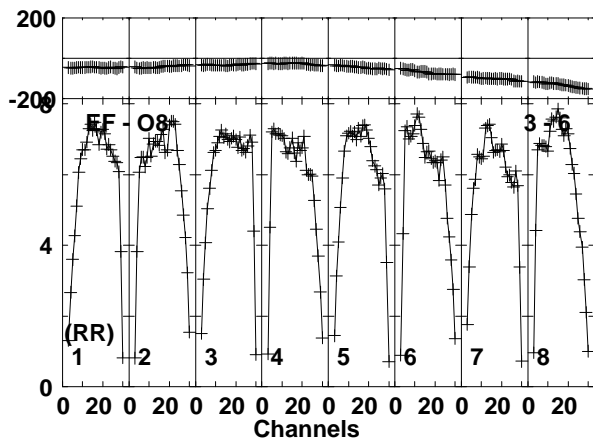
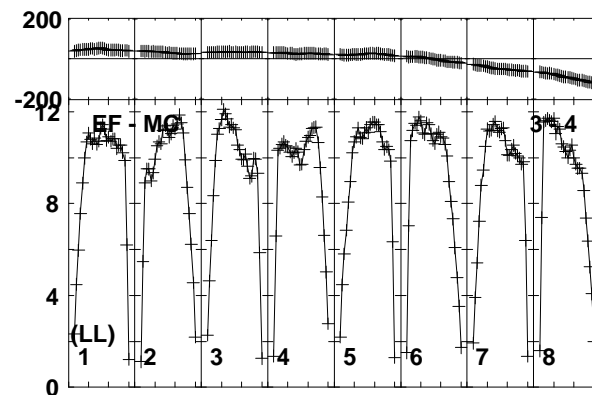
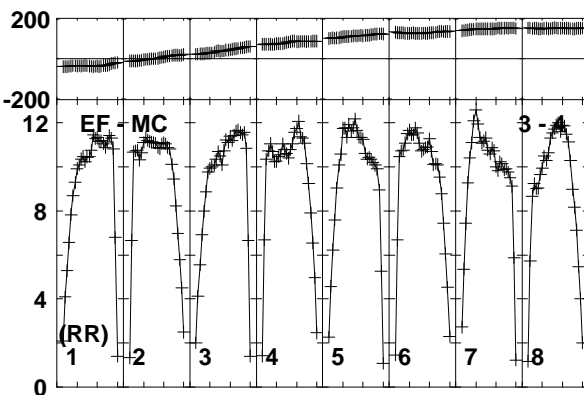
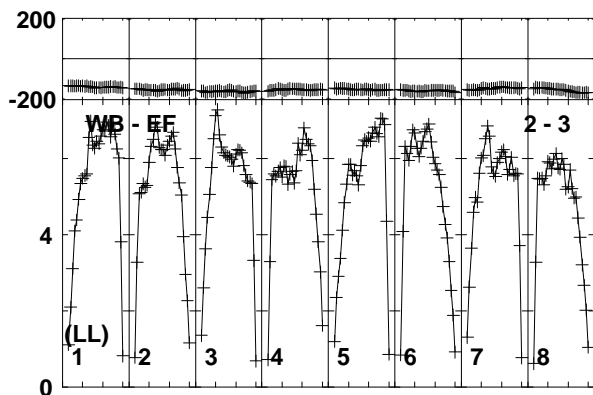
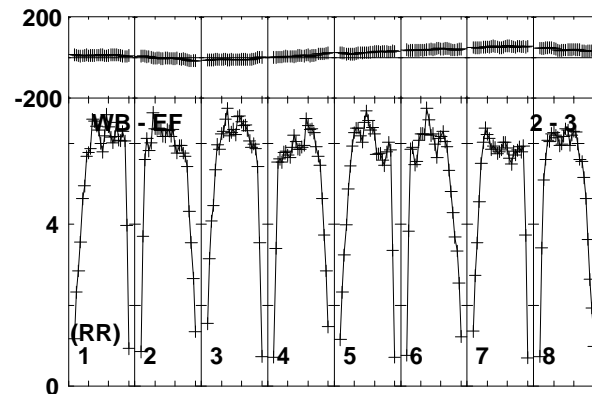
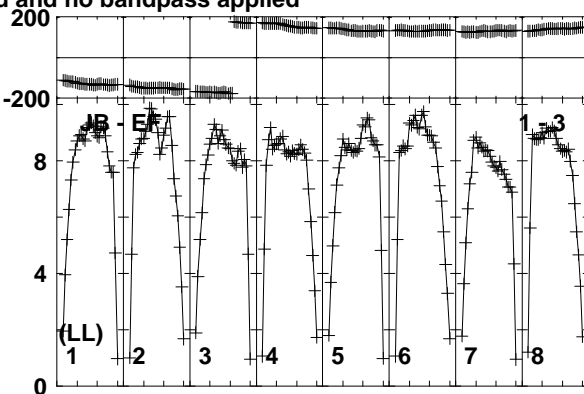
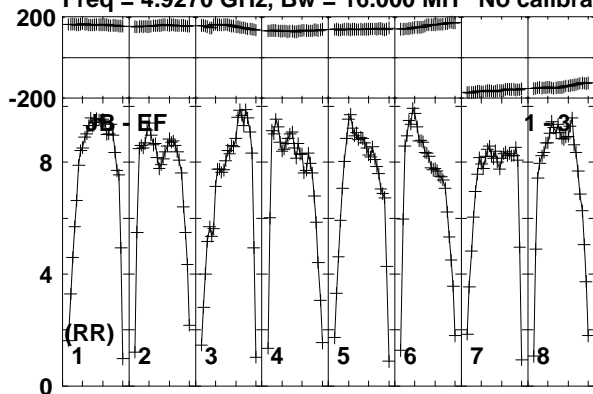

Lower frame: Milli Ampl Jy Top frame: Phas deg  
Vector averaged cross-power spectrum Baseline: JB (01) - EF (03)  
Timerange: 00/13:29:01 to 00/13:29:59

Plot file version 530 created 19-DEC-2018 17:58:51

J1619+2247 RY007C.UVDATA.1

Freq = 4.9270 GHz, Bw = 16.000 MH No calibration applied and no bandpass applied

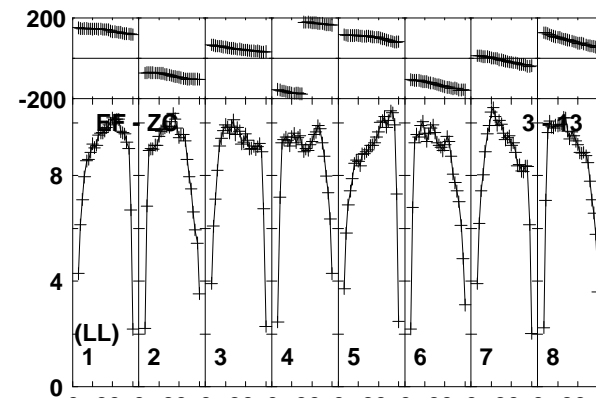
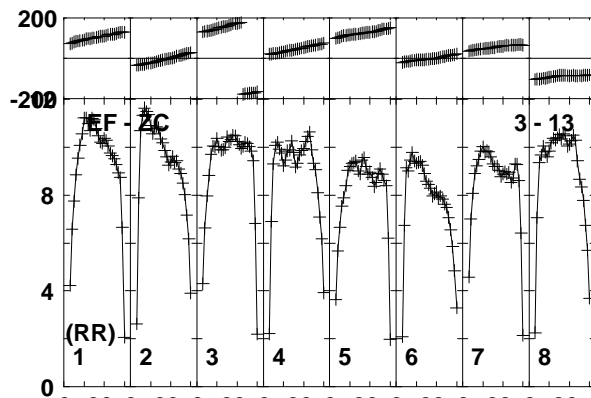
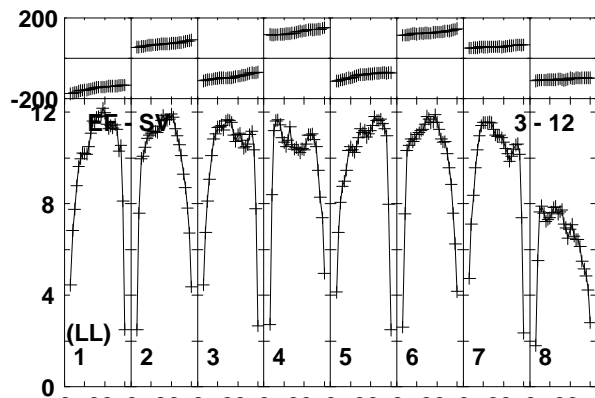
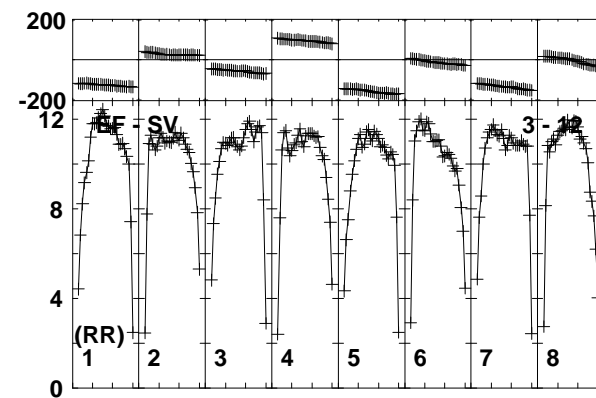
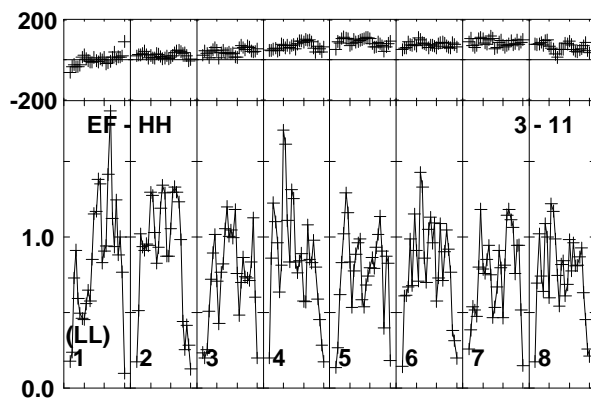
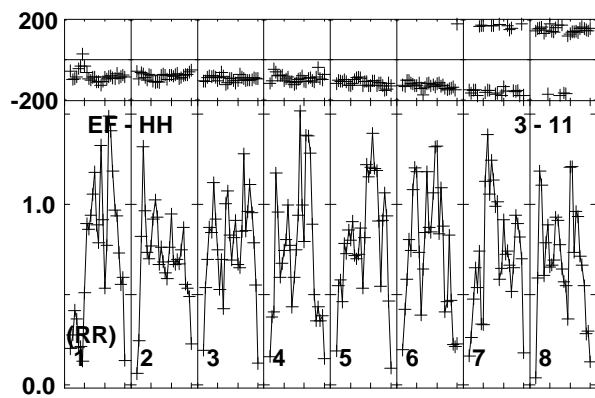
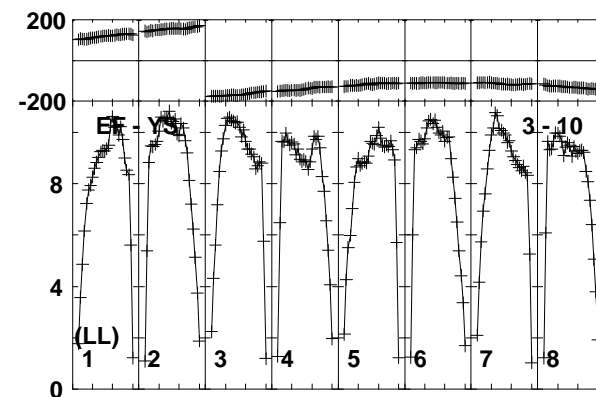
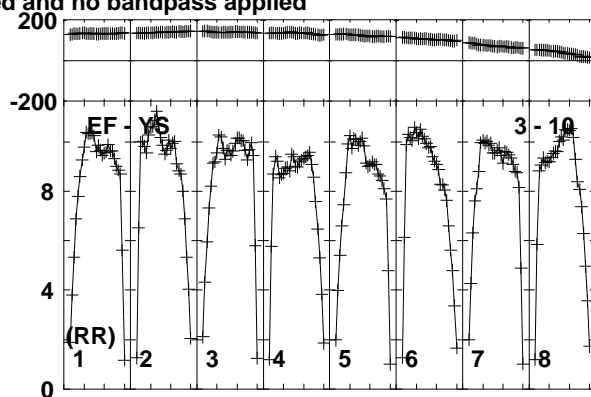
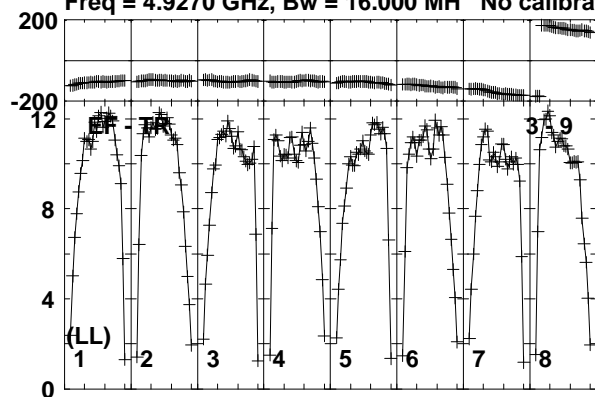

Lower frame: Milli Ampl Jy Top frame: Phas deg  
Vector averaged cross-power spectrum Baseline: EF (03) - TR (09)  
Timerange: 00/13:29:01 to 00/13:29:59



Plot file version 531 created 19-DEC-2018 17:58:51  
J1619+2247 RY007C.UVDATA.1

Freq = 4.9270 GHz, Bw = 16.000 MH No calibration applied and no bandpass applied

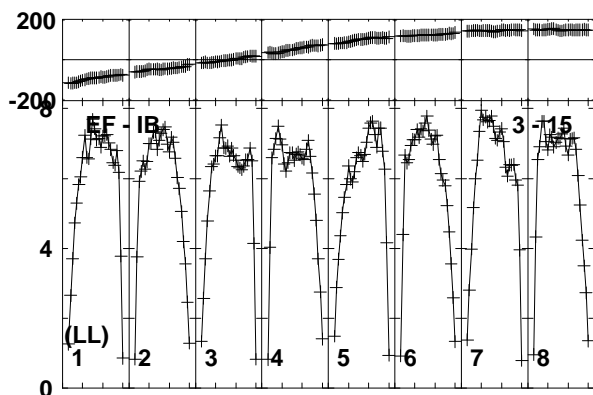
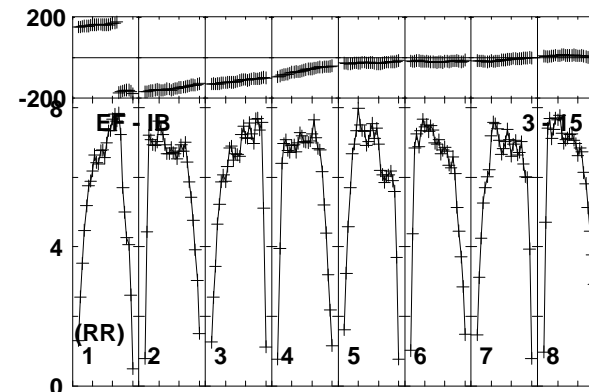
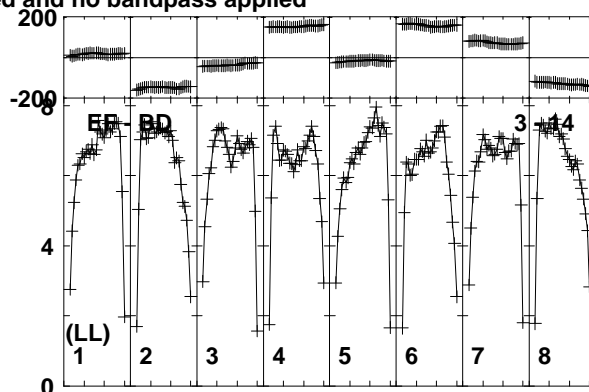
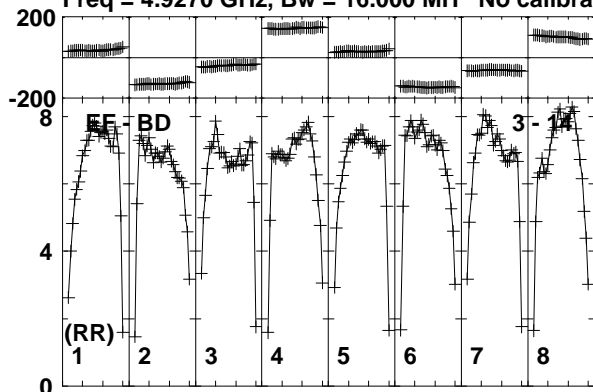

Lower frame: Milli Ampl Jy Top frame: Phas deg  
Vector averaged cross-power spectrum Baseline: EF (03) - BD (14)  
Timerange: 00/13:29:01 to 00/13:29:59

Plot file version 532 created 19-DEC-2018 17:58:51

AT2018\_RY007C.UVDATA.1

Freq = 4.9270 GHz, Bw = 16.000 MH No calibration applied and no bandpass applied

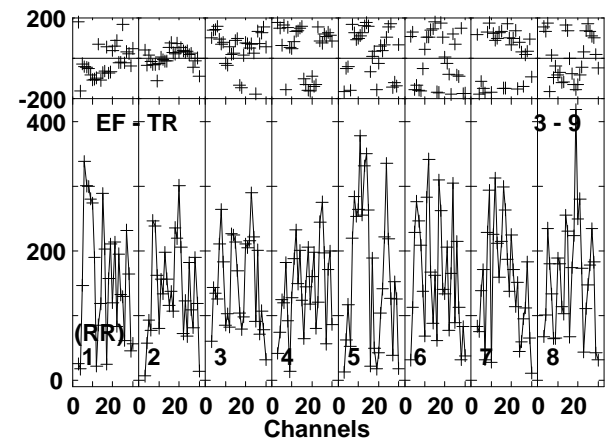
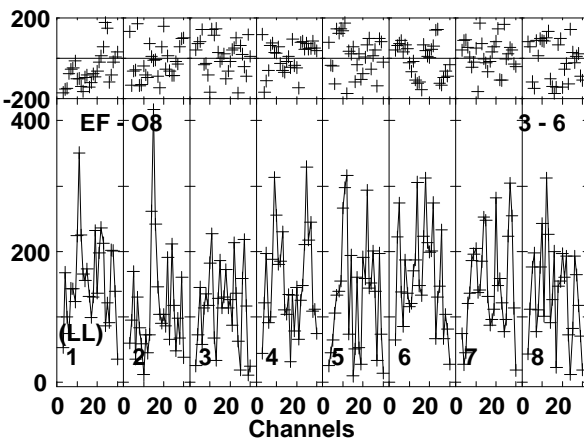
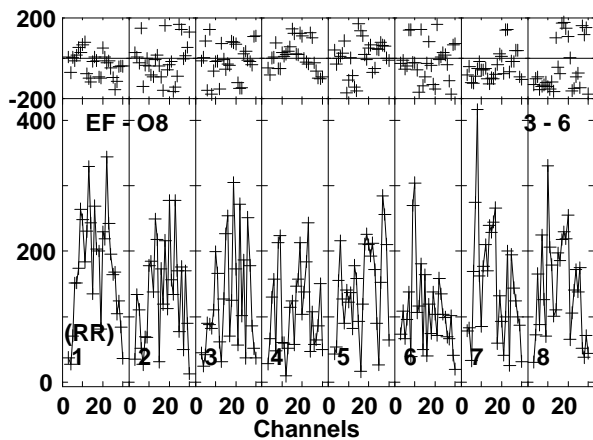
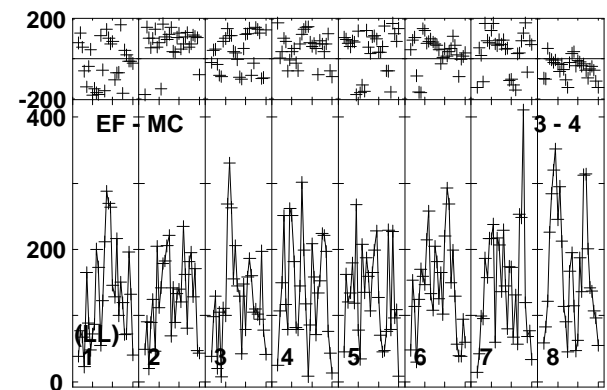
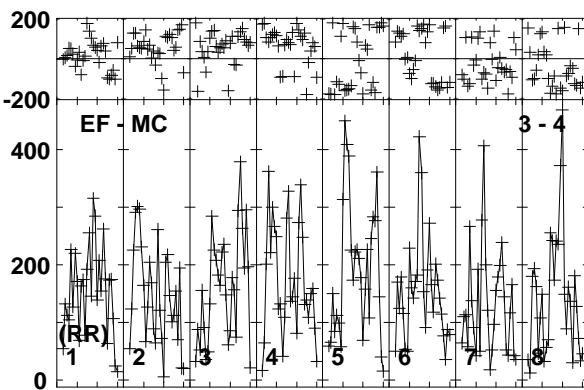
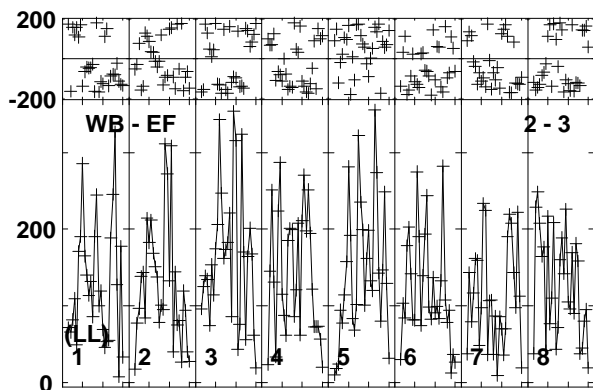
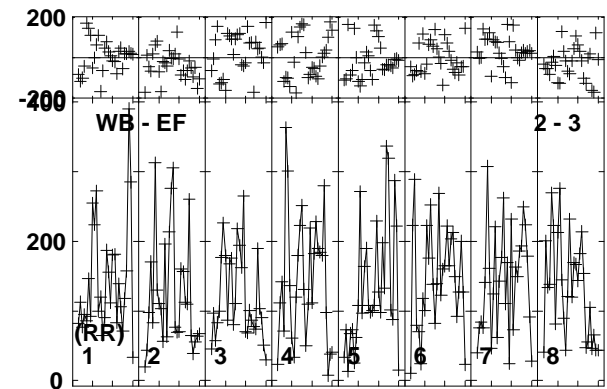
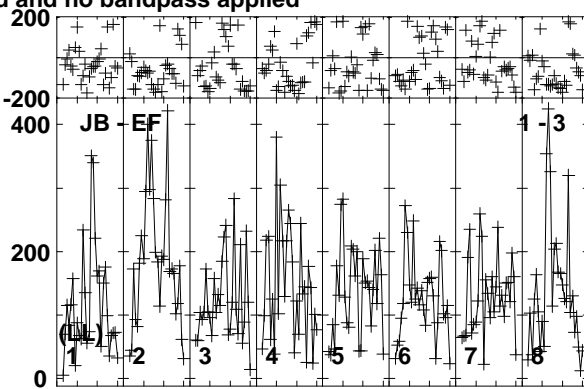
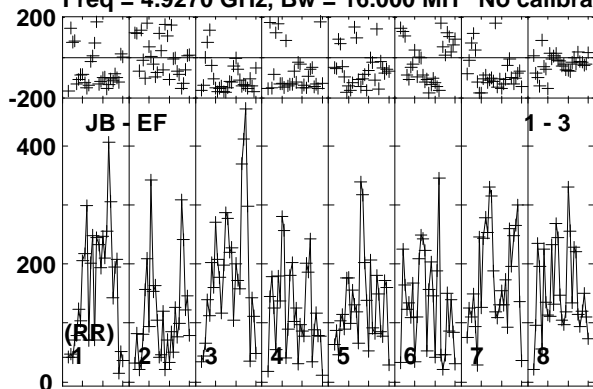

Lower frame: Micro Ampl Jy Top frame: Phas deg  
Vector averaged cross-power spectrum Baseline: JB (01) - EF (03)  
Timerange: 00/13:30:01 to 00/13:31:59

Plot file version 533 created 19-DEC-2018 17:58:51

AT2018\_RY007C.UVDATA.1

Freq = 4.9270 GHz, Bw = 16.000 MH No calibration applied and no bandpass applied

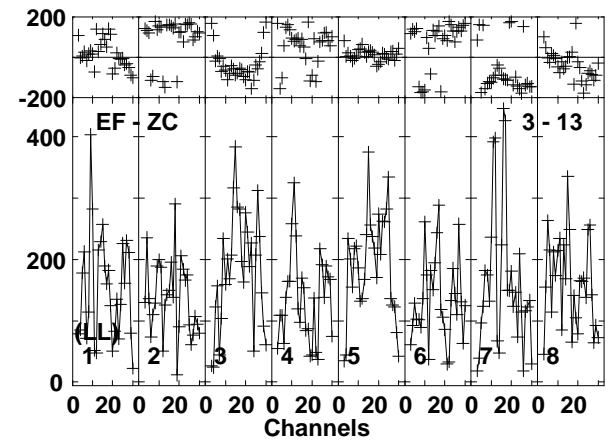
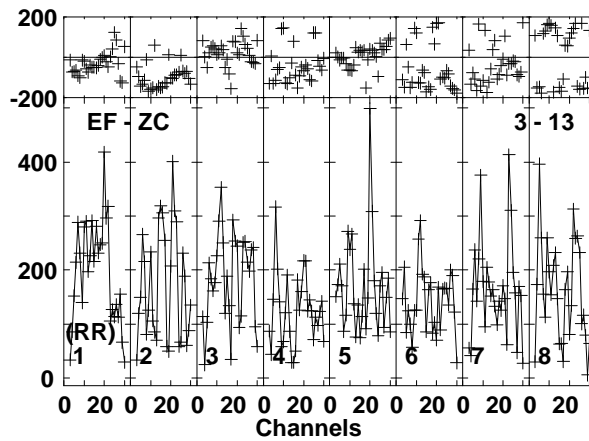
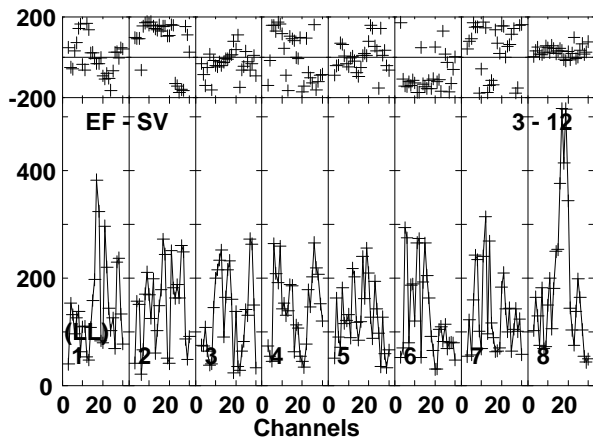
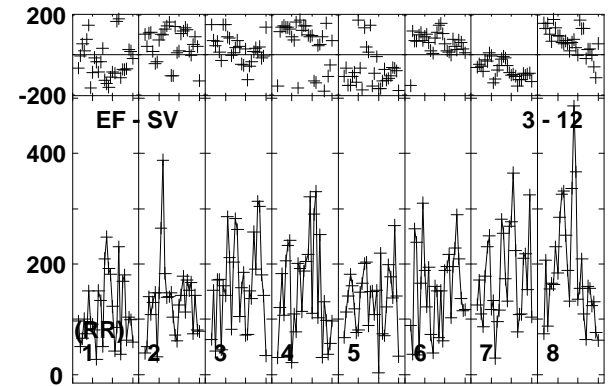
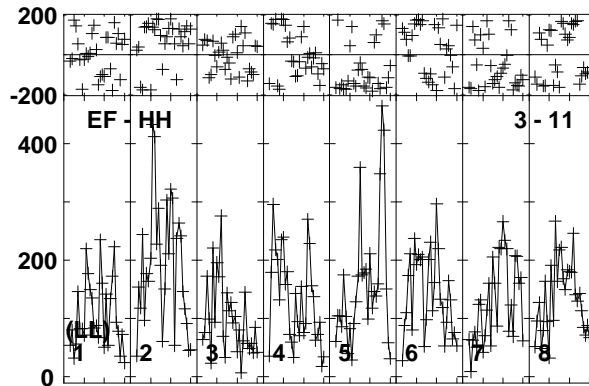
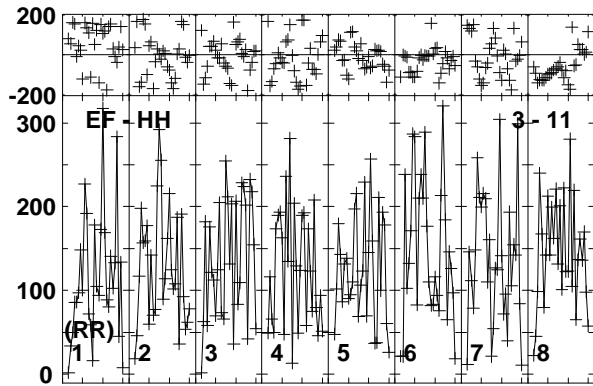
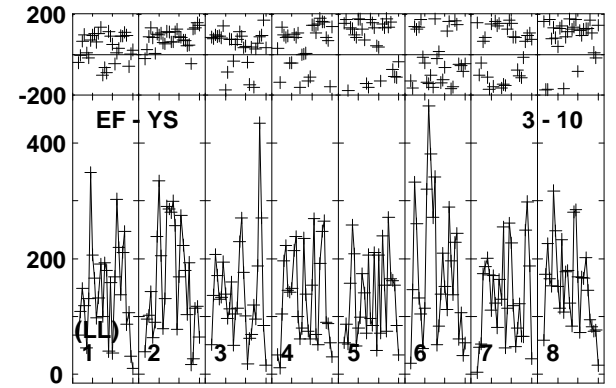
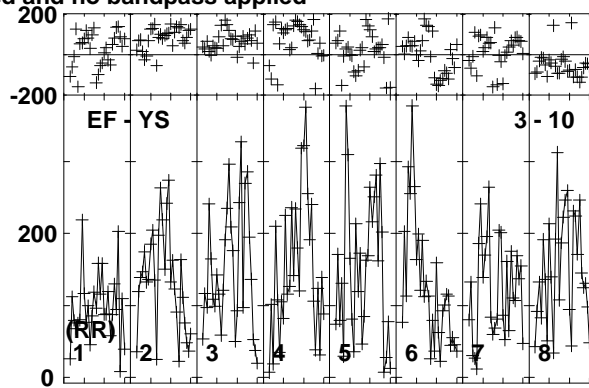
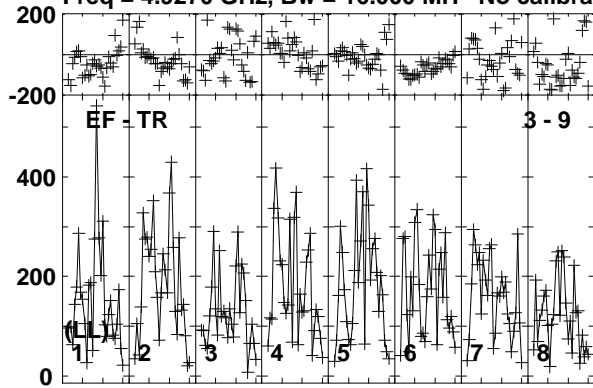

Lower frame: Micro Ampl Jy Top frame: Phas deg  
Vector averaged cross-power spectrum Baseline: EF (03) - TR (09)  
Timerange: 00/13:30:01 to 00/13:31:59

Plot file version 534 created 19-DEC-2018 17:58:51

AT2018\_RY007C.UVDATA.1

Freq = 4.9270 GHz, Bw = 16.000 MH No calibration applied and no bandpass applied

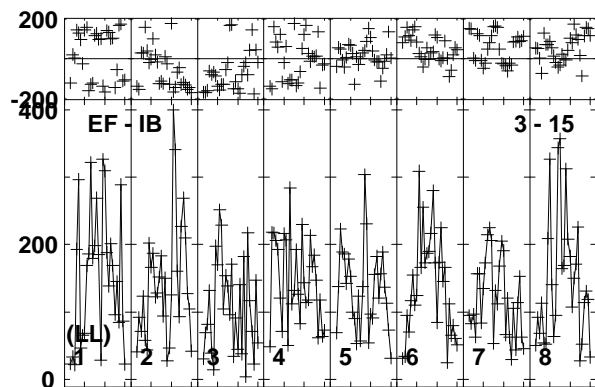
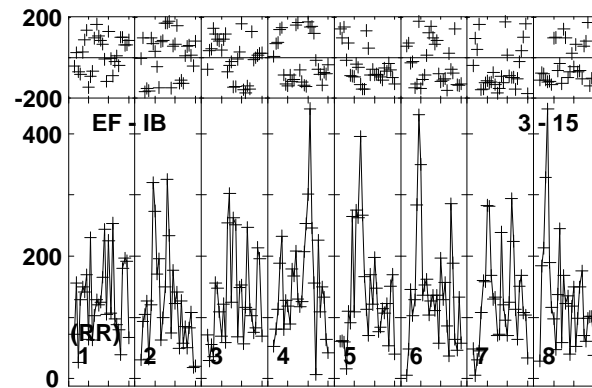
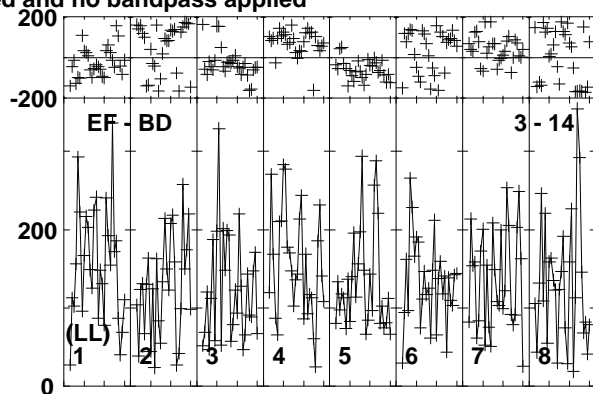
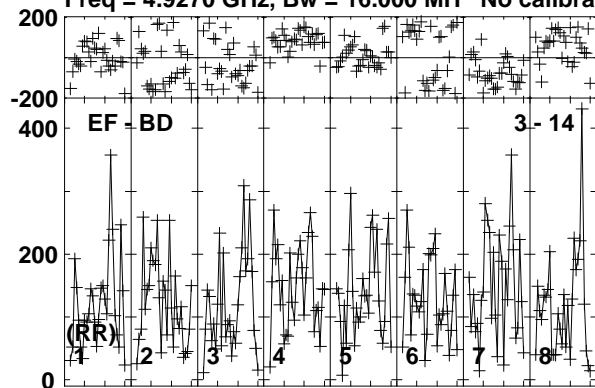

Lower frame: Micro Ampl Jy Top frame: Phas deg  
Vector averaged cross-power spectrum Baseline: EF (03) - BD (14)  
Timerange: 00/13:30:01 to 00/13:31:59

Plot file version 535 created 19-DEC-2018 17:58:51

VLA2 RY007C.UVDATA.1

Freq = 4.9270 GHz, Bw = 16.000 MH No calibration applied and no bandpass applied

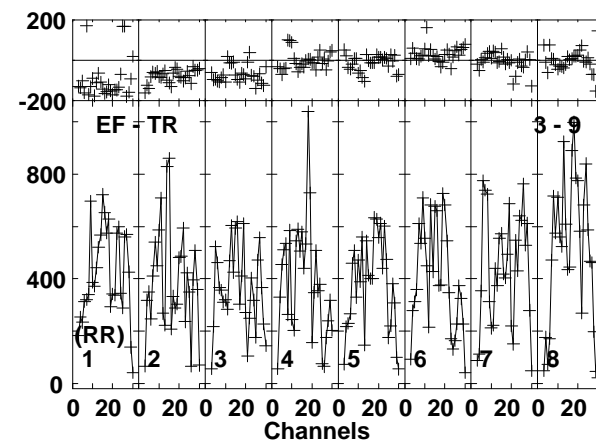
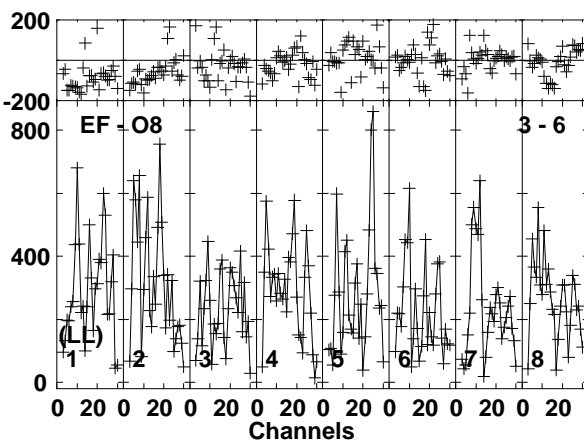
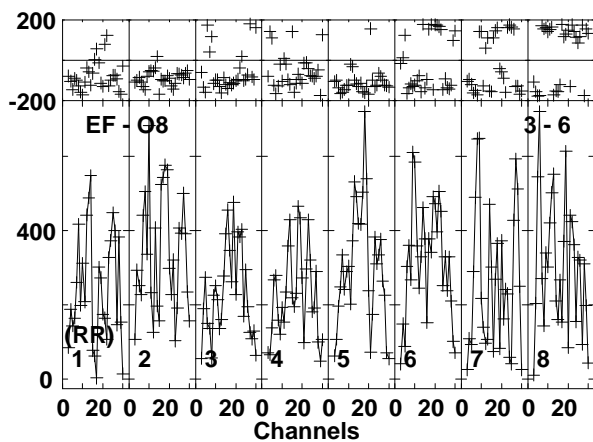
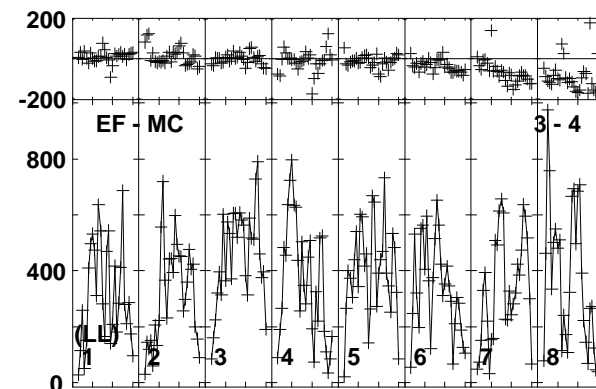
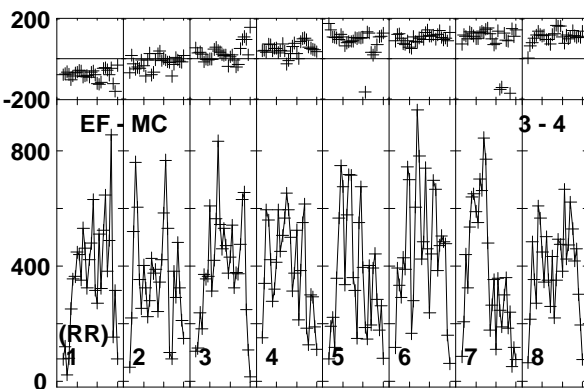
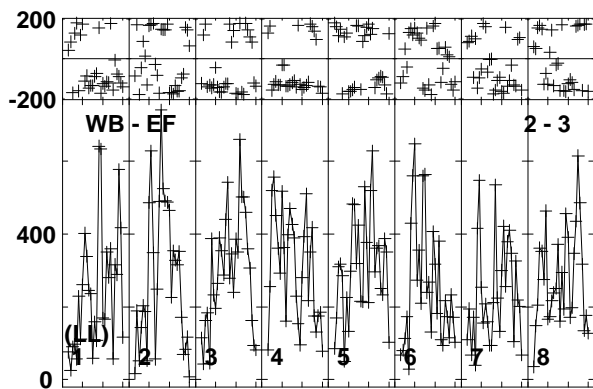
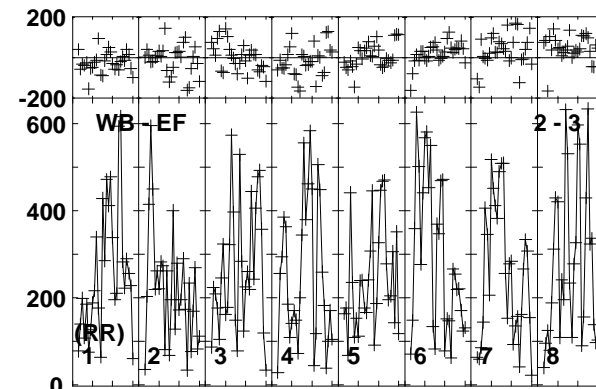
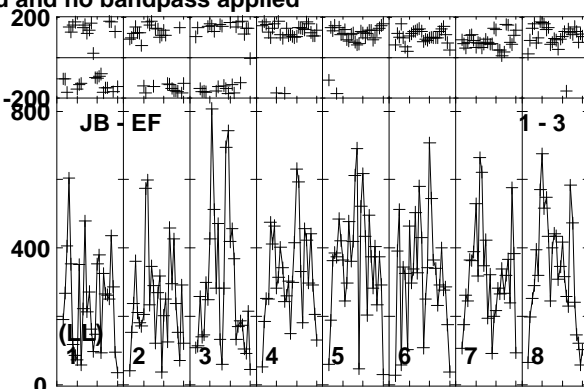
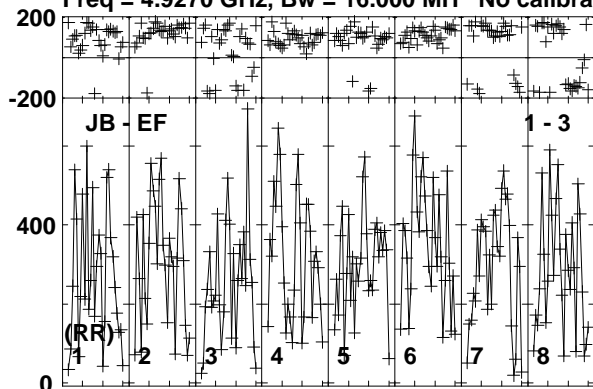

Lower frame: Micro Ampl Jy Top frame: Phas deg  
Vector averaged cross-power spectrum Baseline: JB (01) - EF (03)  
Timerange: 00/13:32:01 to 00/13:32:59

Plot file version 536 created 19-DEC-2018 17:58:51

VLA2\_RY007C.UVDATA.1

Freq = 4.9270 GHz, Bw = 16.000 MH No calibration applied and no bandpass applied

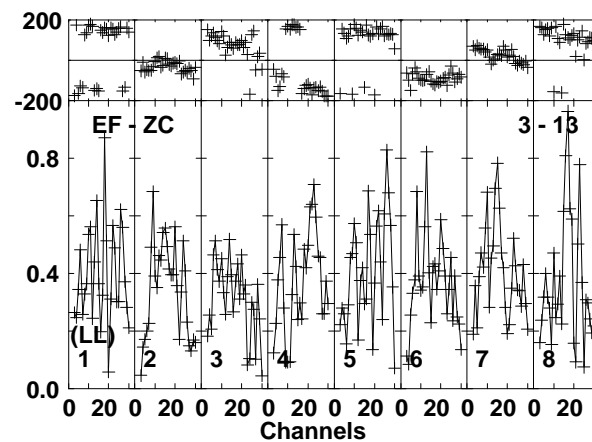
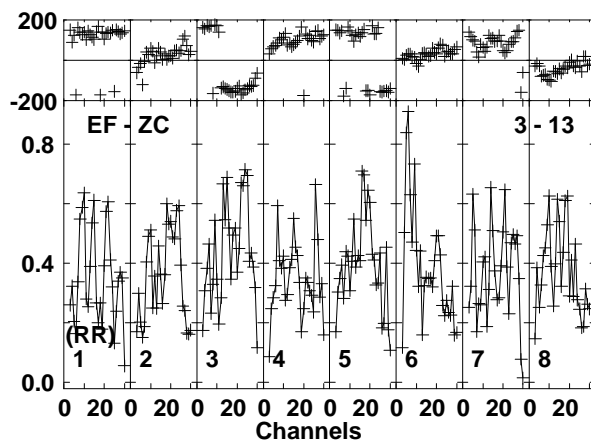
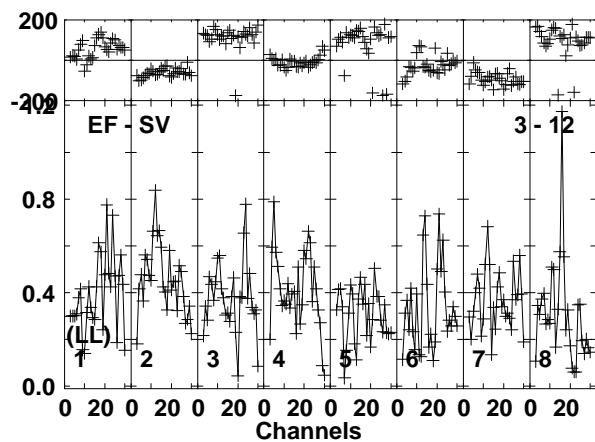
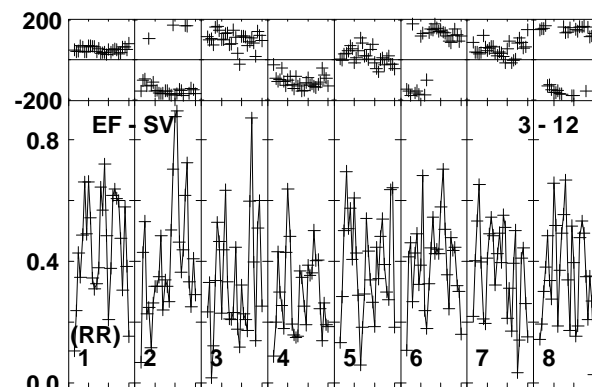
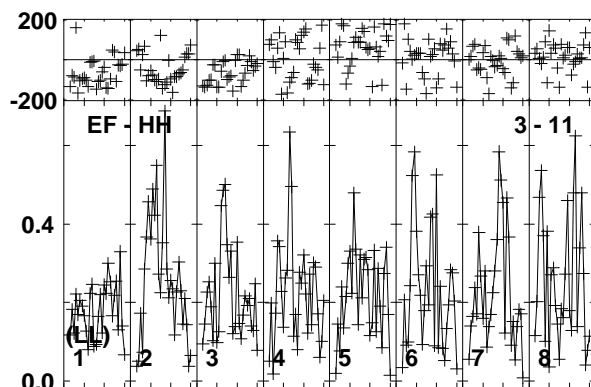
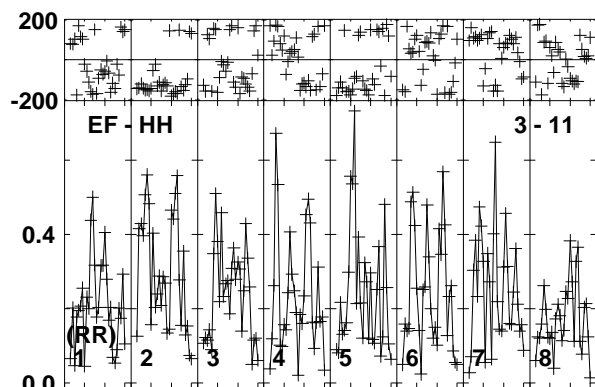
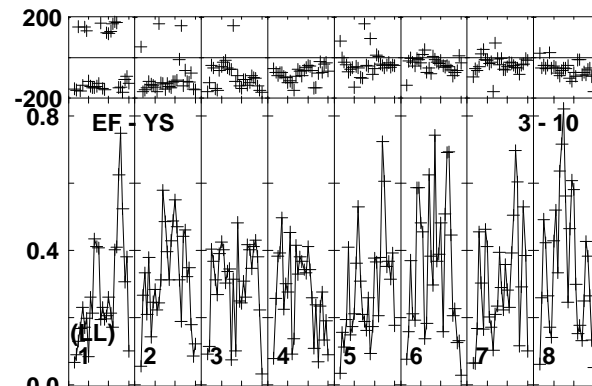
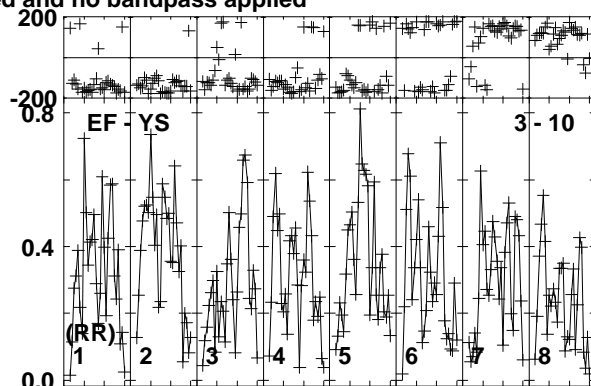
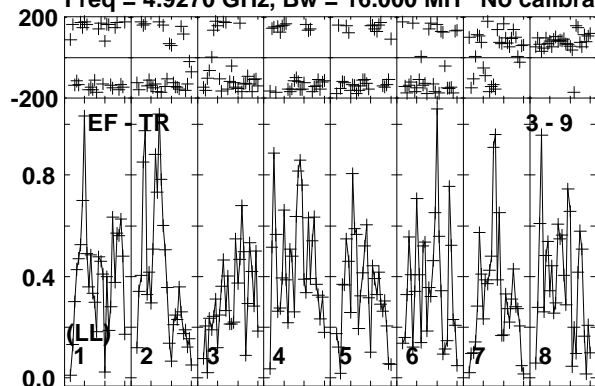

Lower frame: Milli Ampl Jy Top frame: Phas deg  
Vector averaged cross-power spectrum Baseline: EF (03) - TR (09)  
Timerange: 00/13:32:01 to 00/13:32:59

Plot file version 537 created 19-DEC-2018 17:58:51

VLA2 RY007C.UVDATA.1

Freq = 4.9270 GHz, Bw = 16.000 MH No calibration applied and no bandpass applied

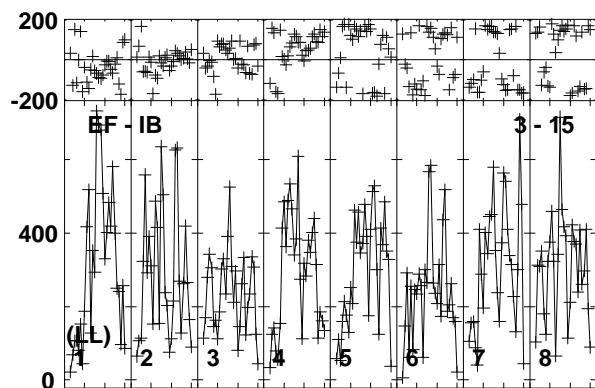
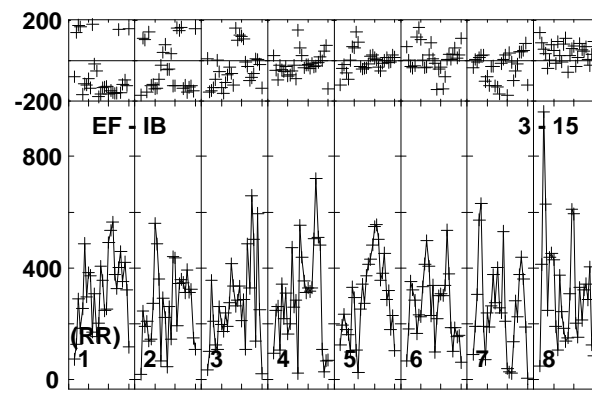
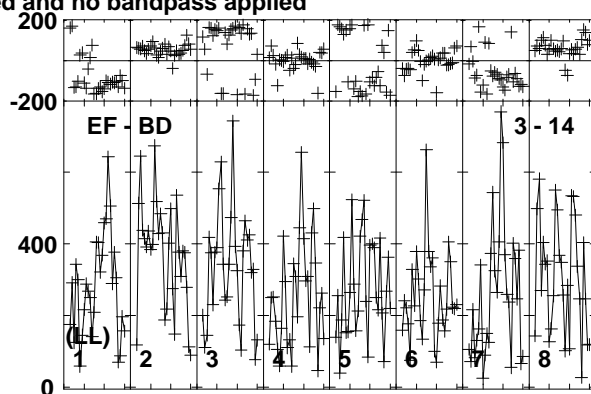
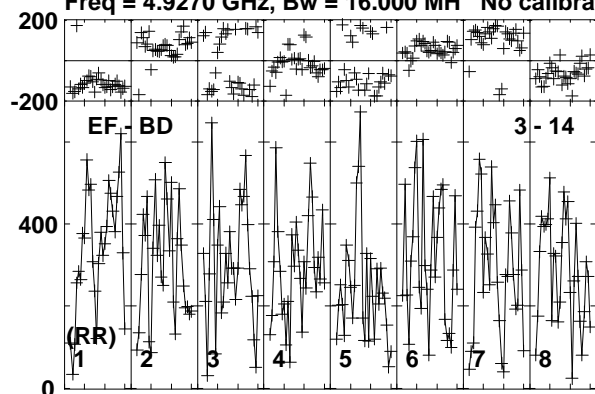

Lower frame: Micro Ampl Jy Top frame: Phas deg  
Vector averaged cross-power spectrum Baseline: EF (03) - BD (14)  
Timerange: 00/13:32:01 to 00/13:32:59

Plot file version 538 created 19-DEC-2018 17:58:51

J1619+2247 RY007C.UVDATA.1

Freq = 4.9270 GHz, Bw = 16.000 MH No calibration applied and no bandpass applied

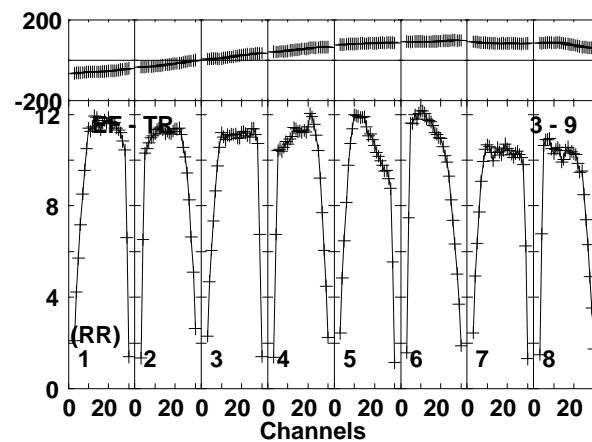
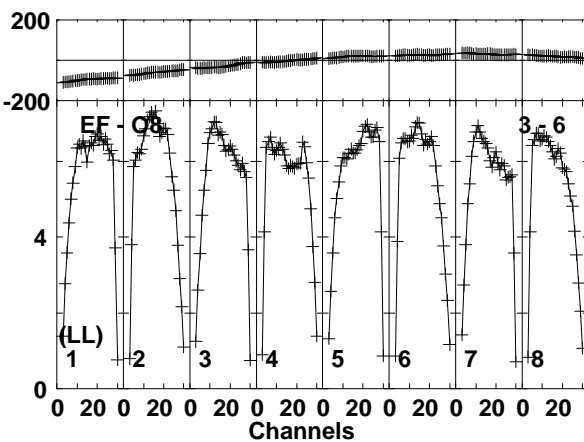
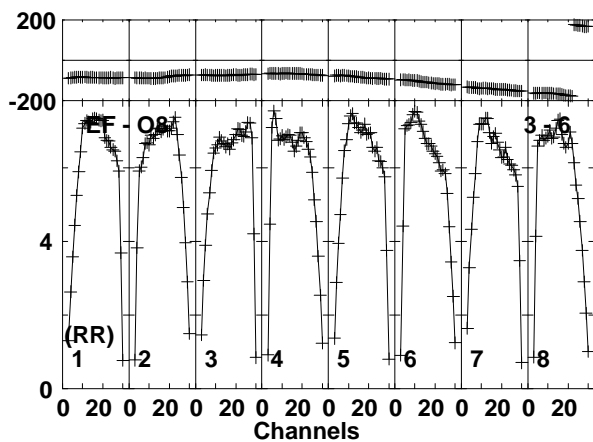
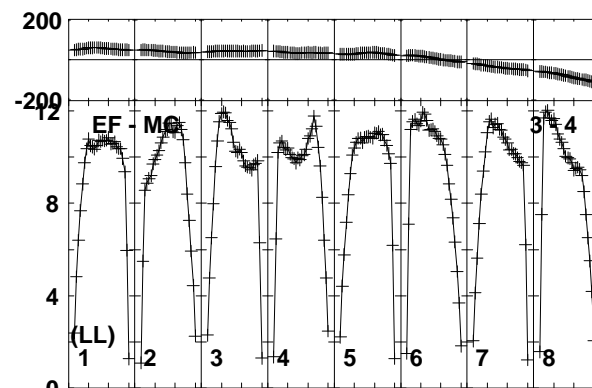
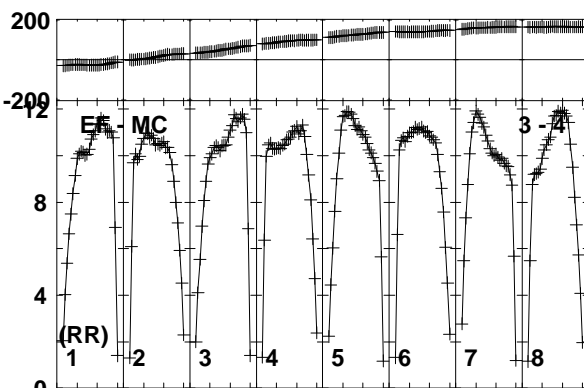
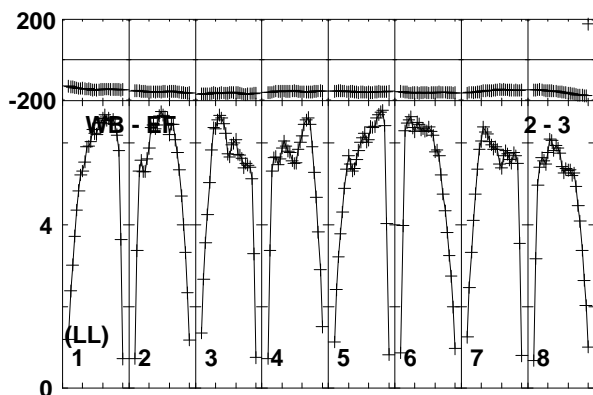
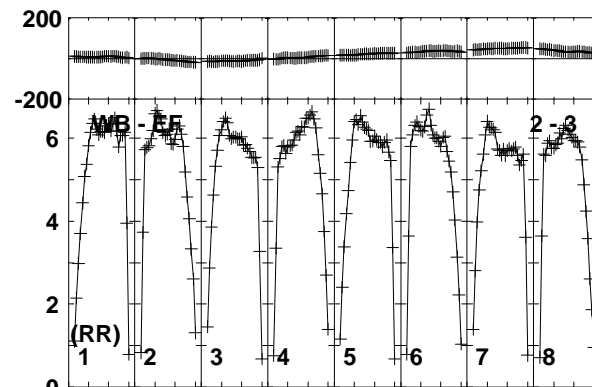
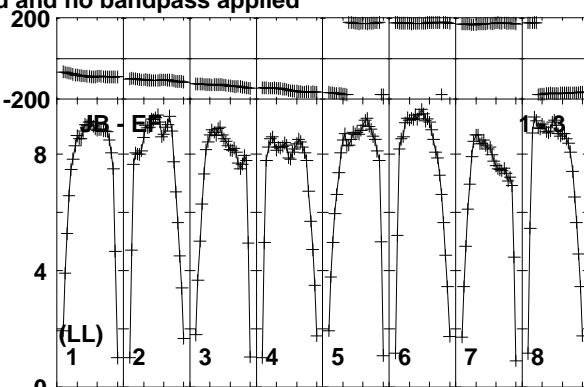
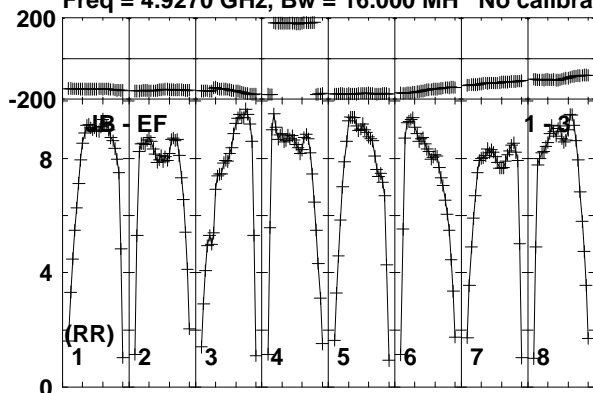

Lower frame: Milli Ampl Jy Top frame: Phas deg  
Vector averaged cross-power spectrum Baseline: JB (01) - EF (03)  
Timerange: 00/13:33:31 to 00/13:34:29



Plot file version 539 created 19-DEC-2018 17:58:51

J1619+2247 RY007C.UVDATA.1

Freq = 4.9270 GHz, Bw = 16.000 MH No calibration applied and no bandpass applied

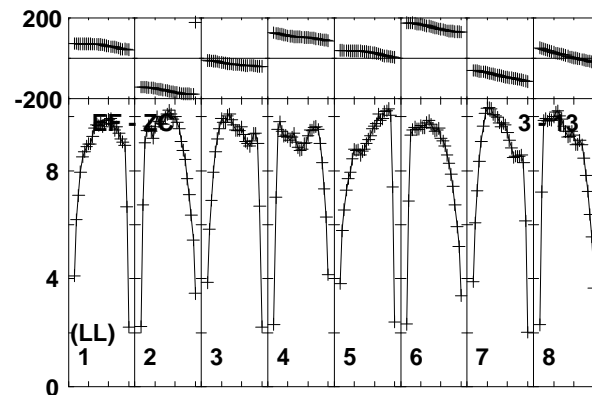
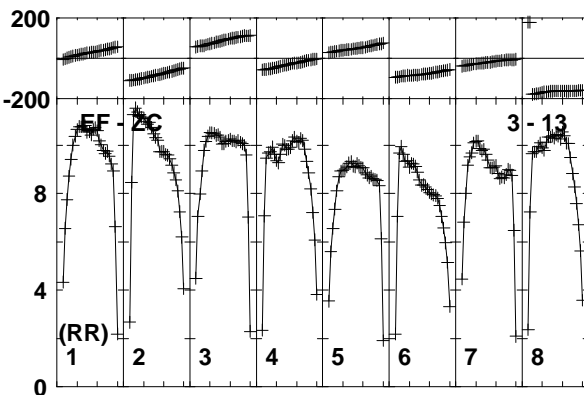
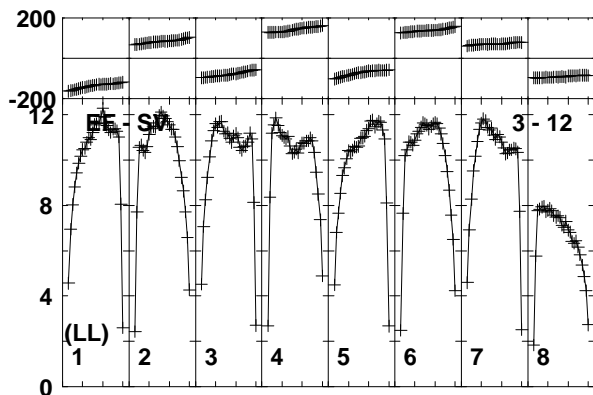
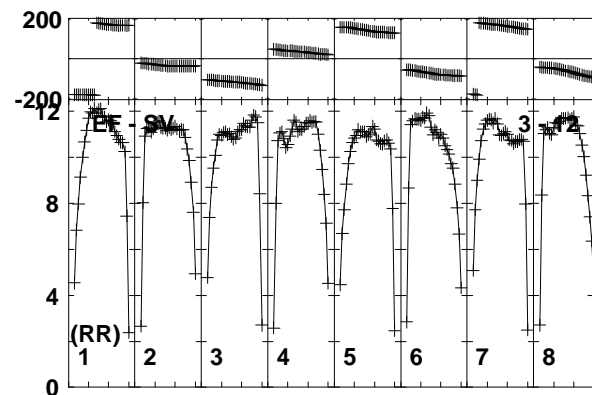
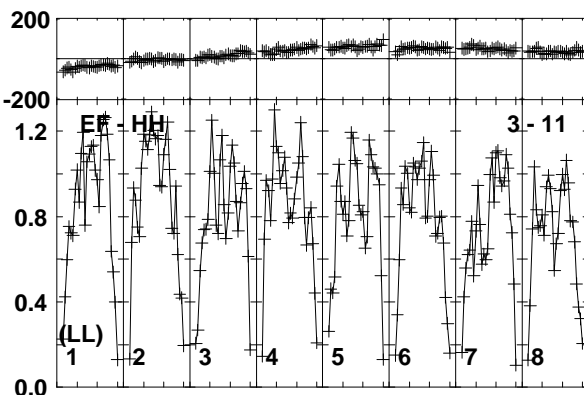
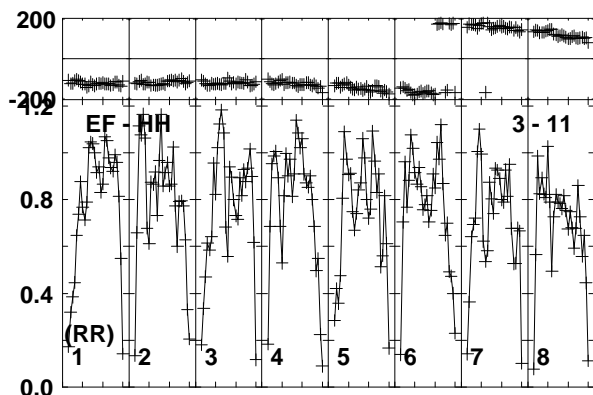
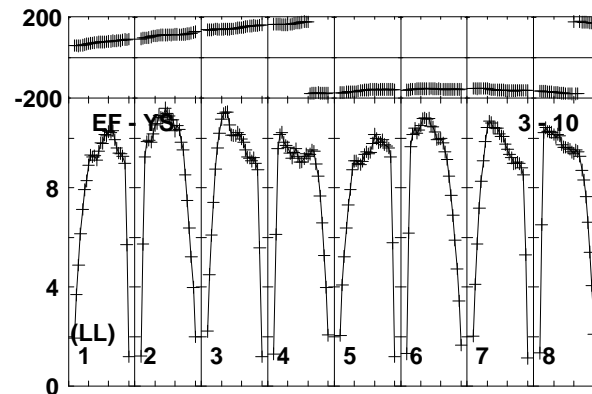
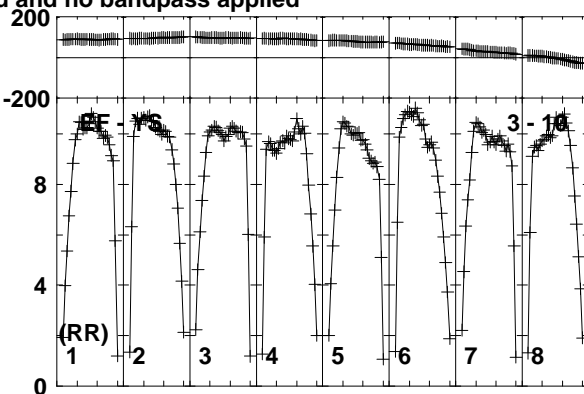
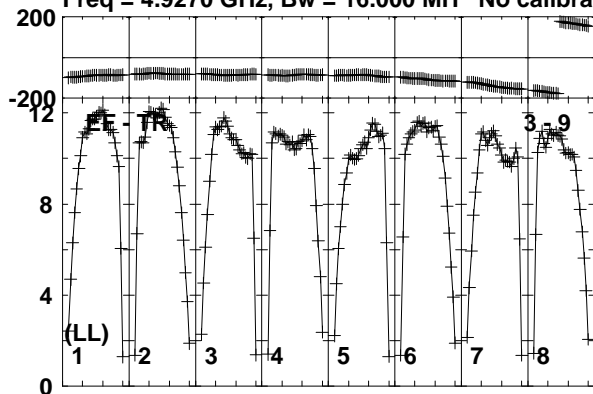

Lower frame: Milli Ampl Jy Top frame: Phas deg  
Vector averaged cross-power spectrum Baseline: EF (03) - TR (09)  
Timerange: 00:13:33:31 to 00:13:34:29

Plot file version 540 created 19-DEC-2018 17:58:51

J1619+2247 RY007C.UVDATA.1

Freq = 4.9270 GHz, Bw = 16.000 MH No calibration applied and no bandpass applied

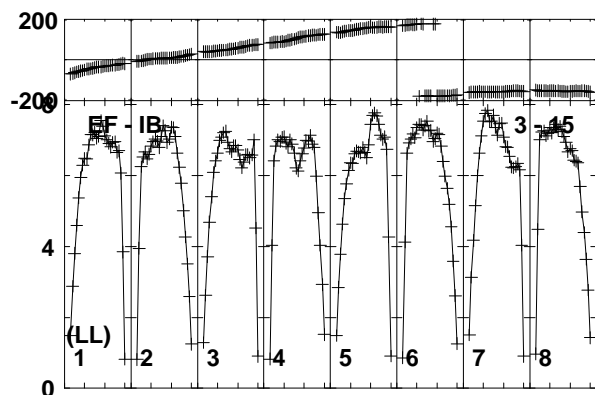
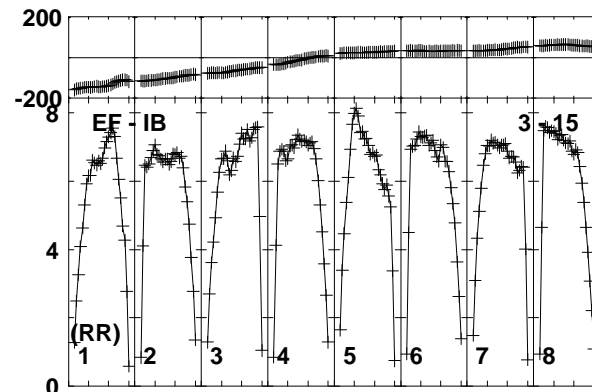
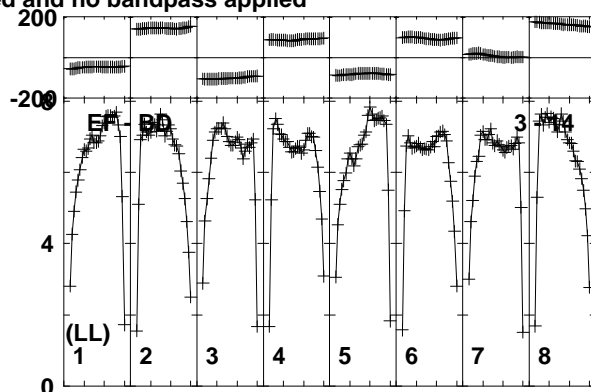
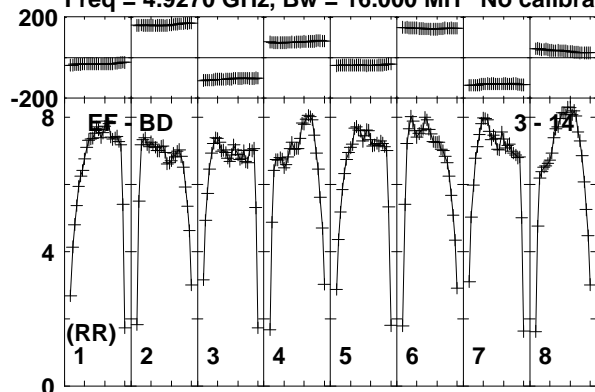

Lower frame: Milli Ampl Jy Top frame: Phas deg  
Vector averaged cross-power spectrum Baseline: EF (03) - BD (14)  
Timerange: 00/13:33:31 to 00/13:34:29

Plot file version 541 created 19-DEC-2018 17:58:51

AT2018\_RY007C.UVDATA.1

Freq = 4.9270 GHz, Bw = 16.000 MH No calibration applied and no bandpass applied

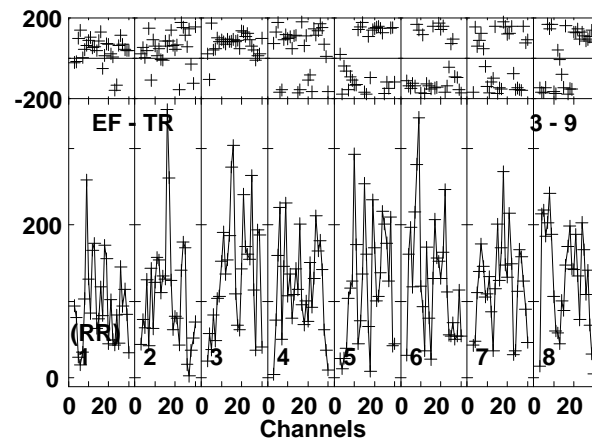
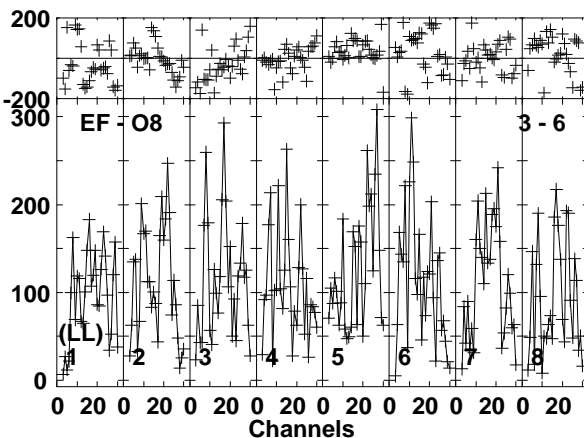
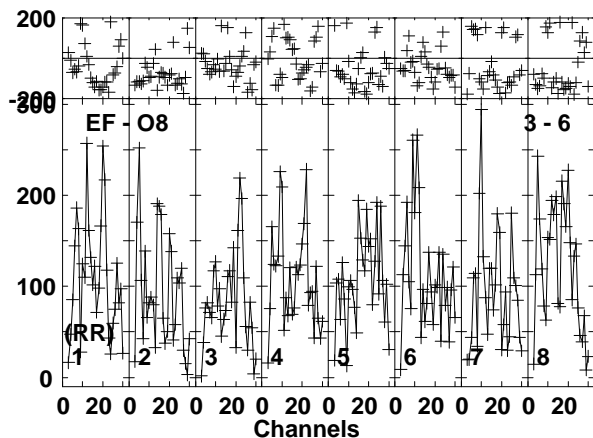
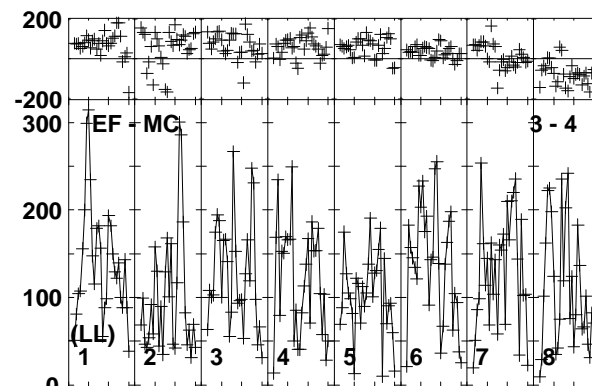
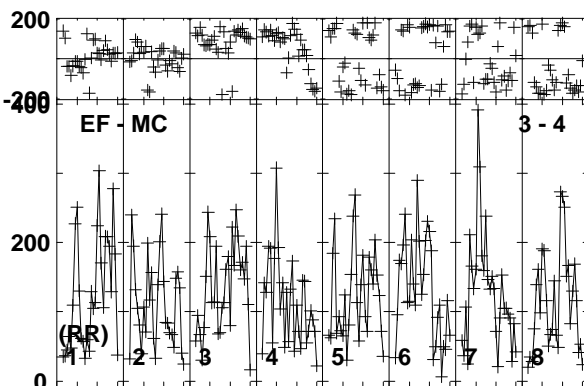
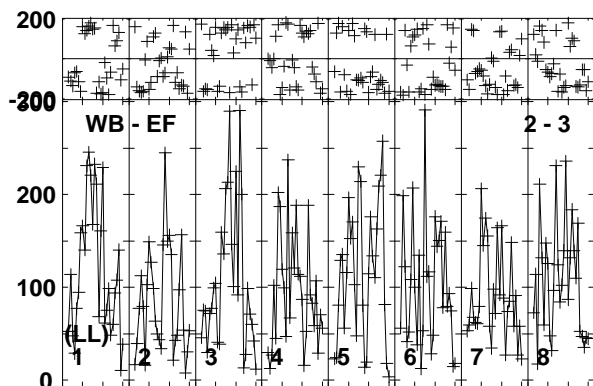
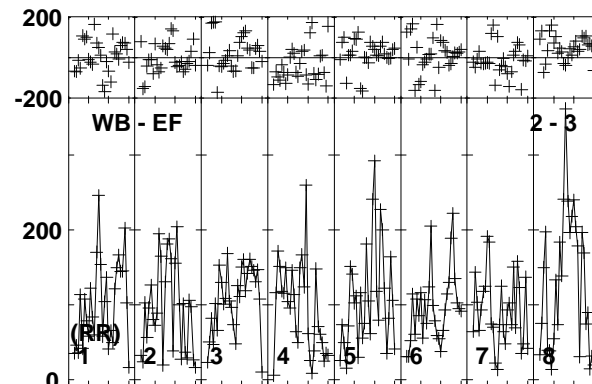
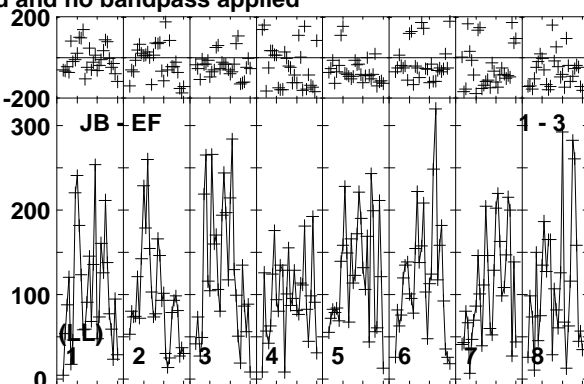
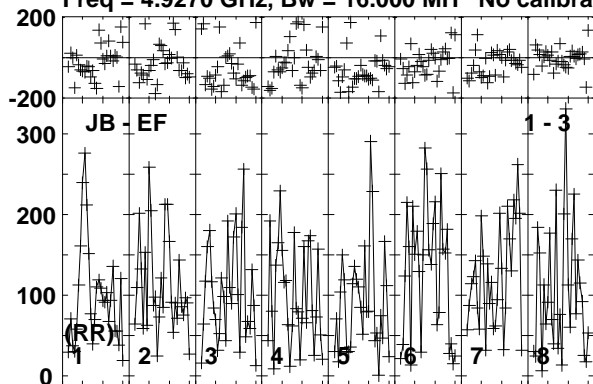

Lower frame: Micro Ampl Jy Top frame: Phas deg  
Vector averaged cross-power spectrum Baseline: JB (01) - EF (03)  
Timerange: 00/13:34:31 to 00/13:37:29

Plot file version 542 created 19-DEC-2018 17:58:51

AT2018\_RY007C.UVDATA.1

Freq = 4.9270 GHz, Bw = 16.000 MH No calibration applied and no bandpass applied

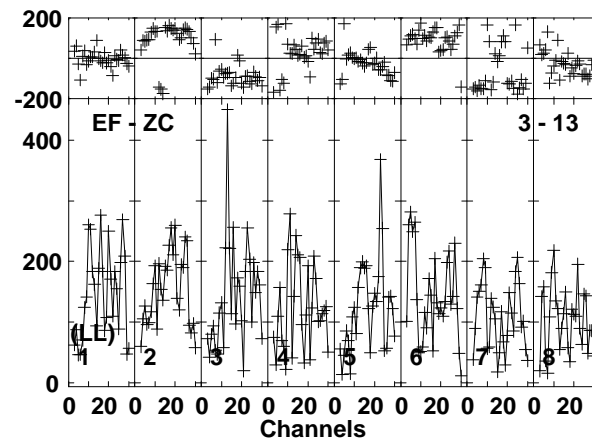
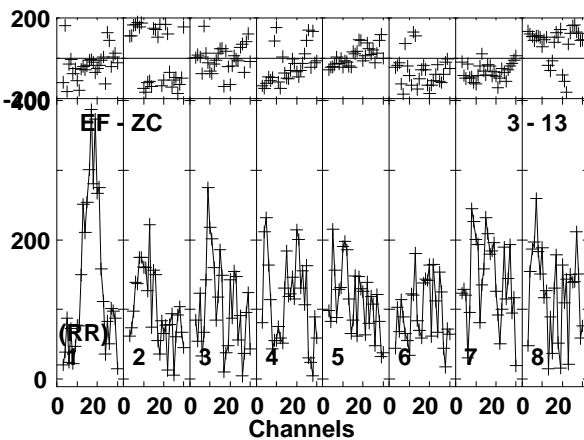
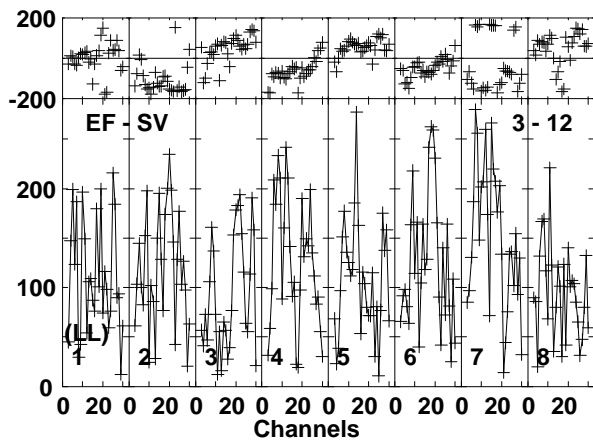
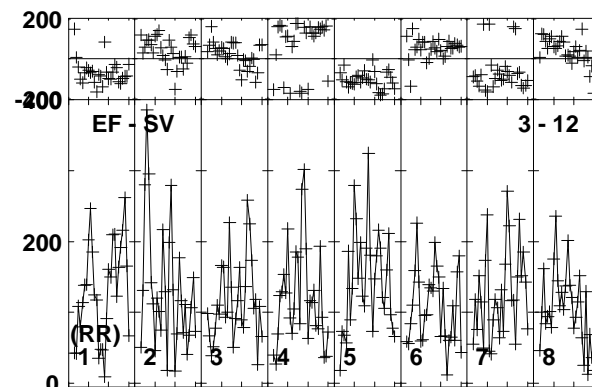
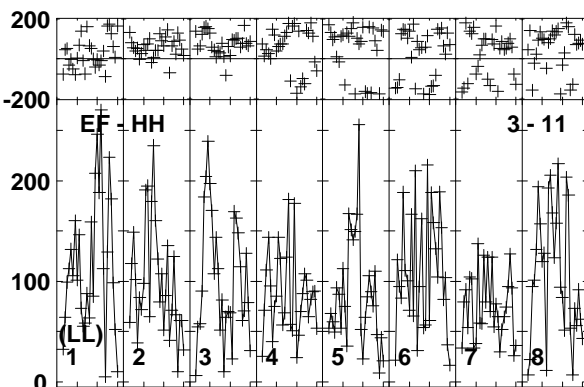
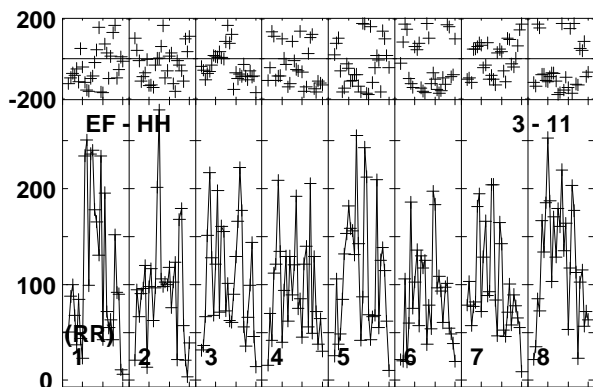
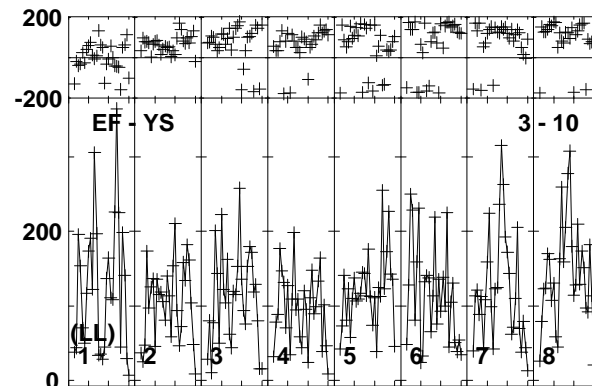
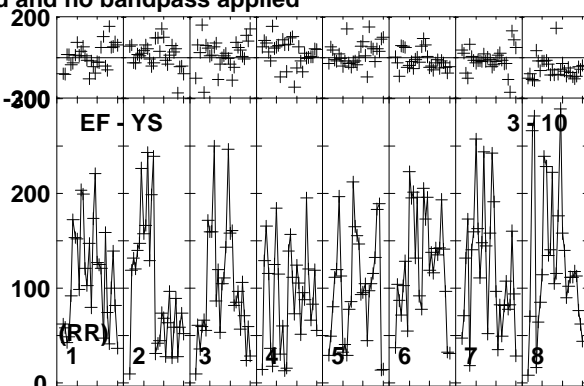
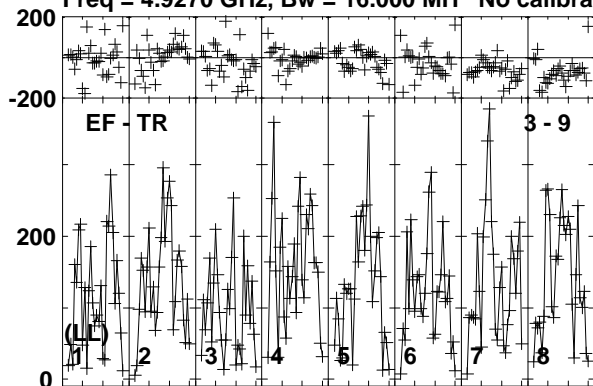

Lower frame: Micro Ampl Jy Top frame: Phas deg  
Vector averaged cross-power spectrum Baseline: EF (03) - TR (09)  
Timerange: 00/13:34:31 to 00/13:37:29

Plot file version 543 created 19-DEC-2018 17:58:51

AT2018\_RY007C.UVDATA.1

Freq = 4.9270 GHz, Bw = 16.000 MH No calibration applied and no bandpass applied

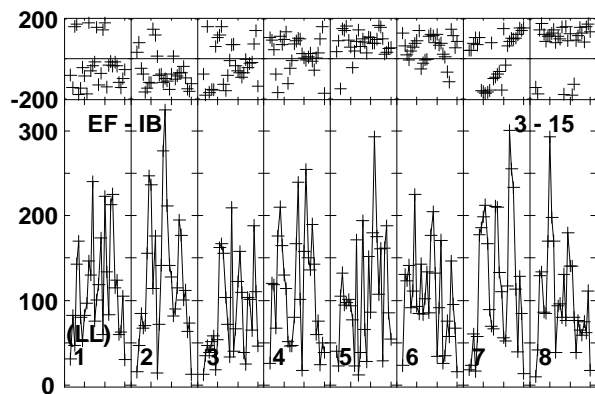
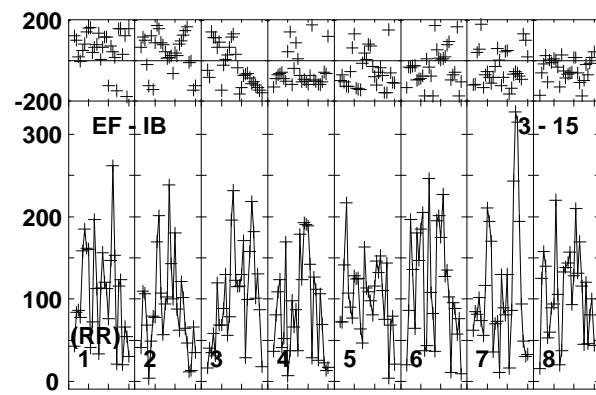
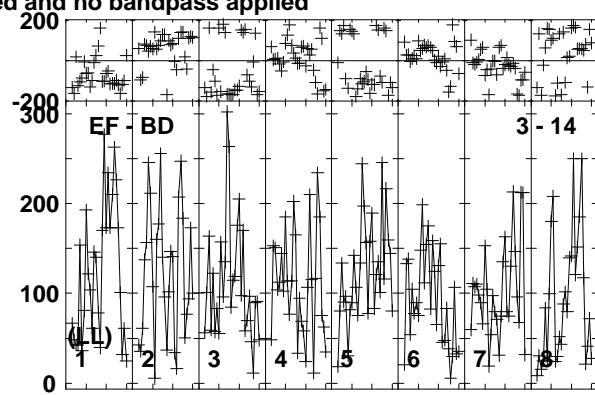
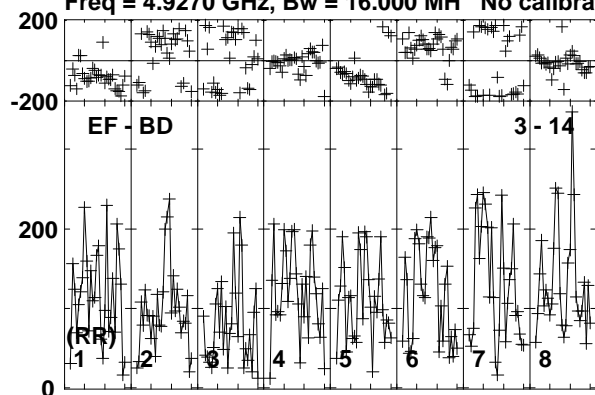

Lower frame: Micro Ampl Jy Top frame: Phas deg  
Vector averaged cross-power spectrum Baseline: EF (03) - BD (14)  
Timerange: 00/13:34:31 to 00/13:37:29

Plot file version 544 created 19-DEC-2018 17:58:51

J1619+2247 RY007C.UVDATA.1

Freq = 4.9270 GHz, Bw = 16.000 MH No calibration applied and no bandpass applied

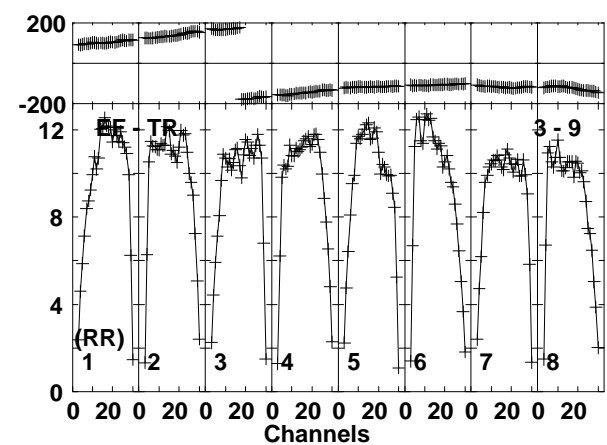
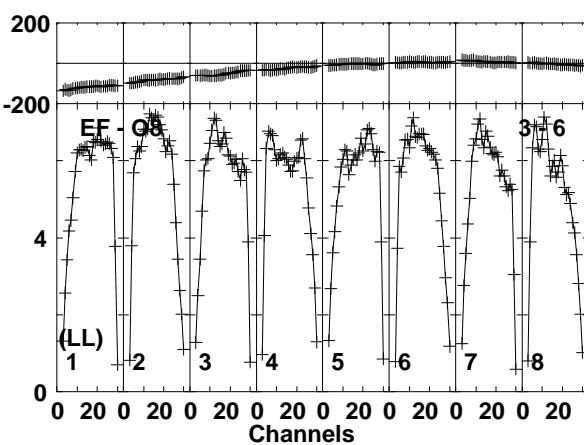
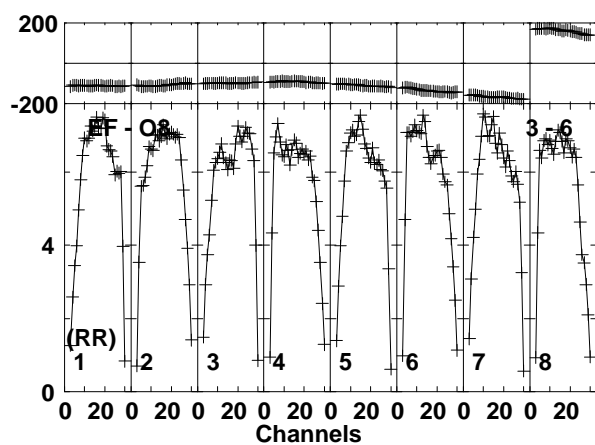
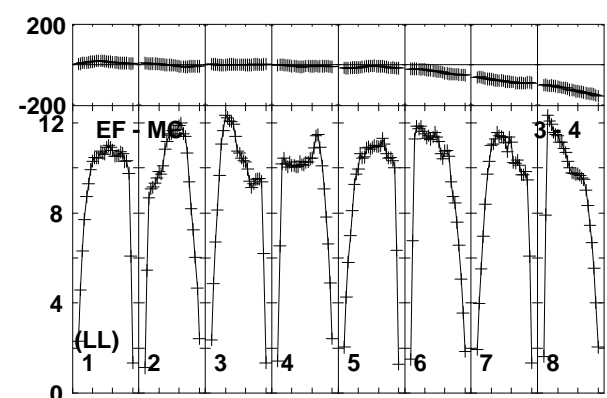
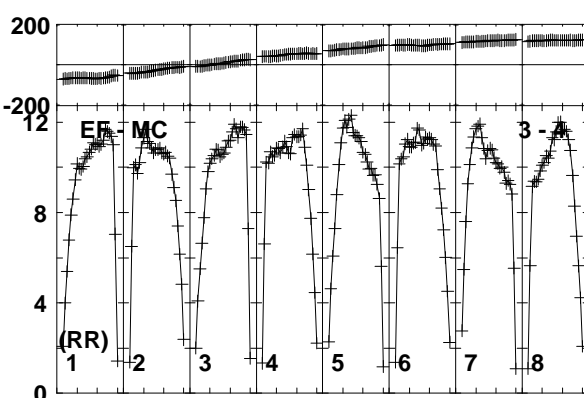
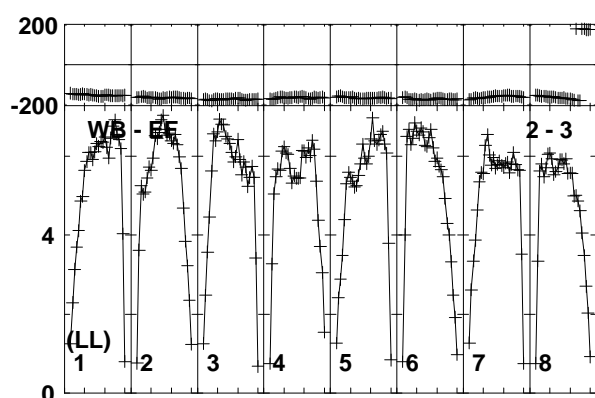
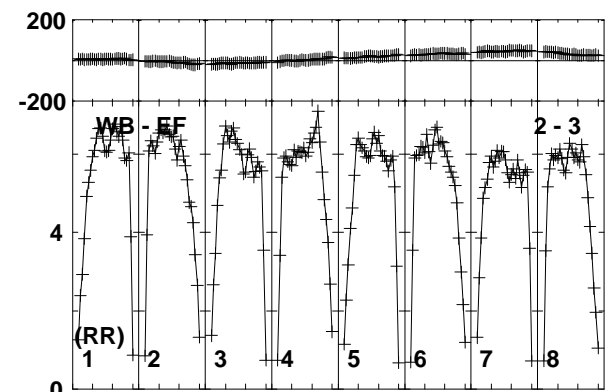
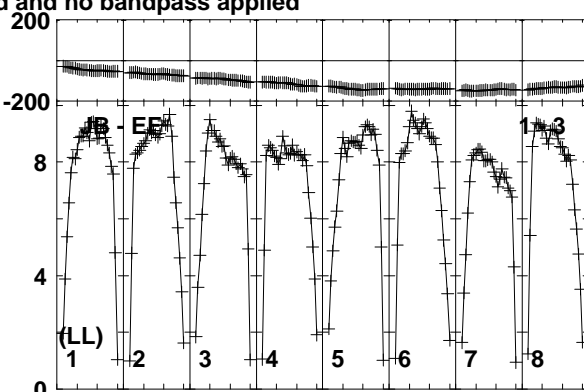
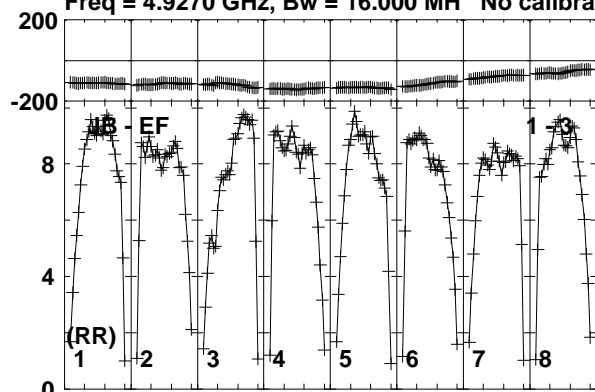

Lower frame: Milli Ampl Jy Top frame: Phas deg  
Vector averaged cross-power spectrum Baseline: JB (01) - EF (03)  
Timerange: 00/13:37:31 to 00/13:38:29

Plot file version 545 created 19-DEC-2018 17:58:51

J1619+2247 RY007C.UVDATA.1

Freq = 4.9270 GHz, Bw = 16.000 MH No calibration applied and no bandpass applied

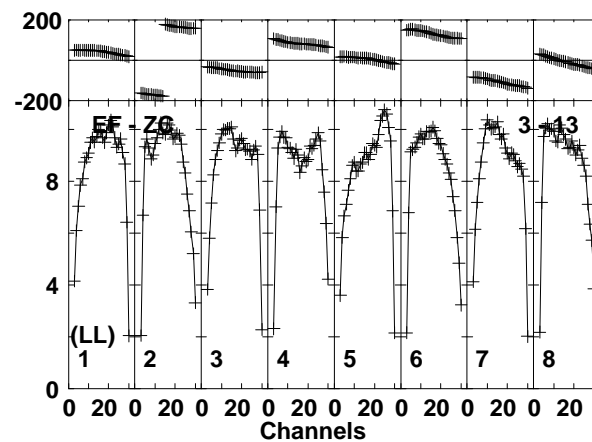
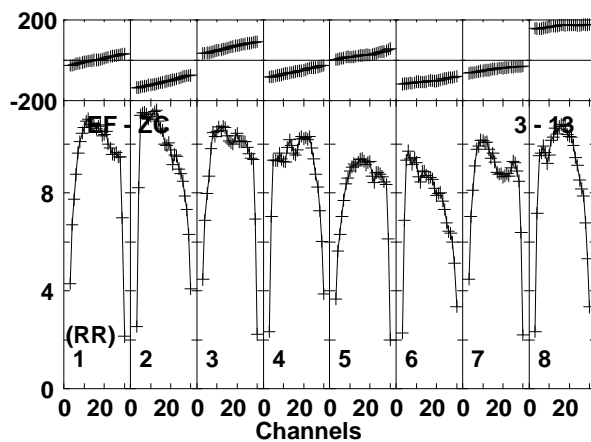
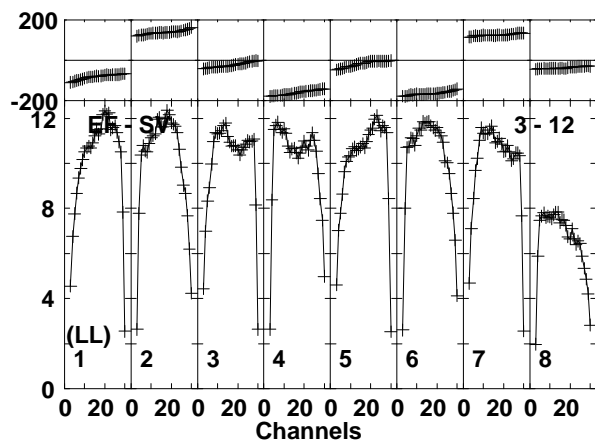
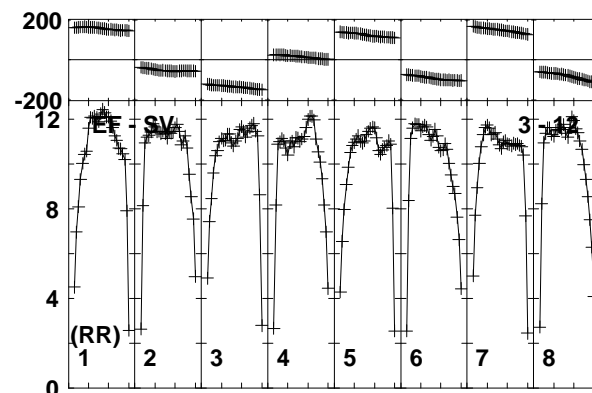
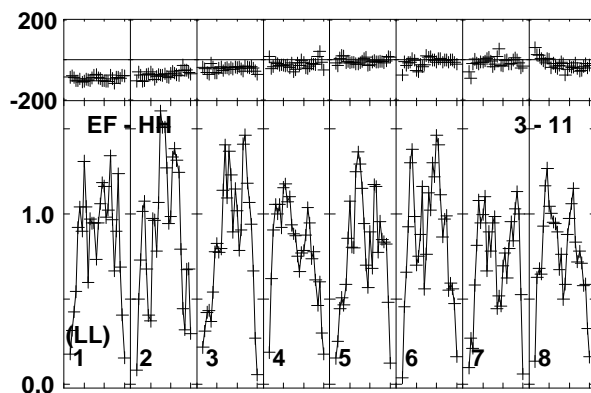
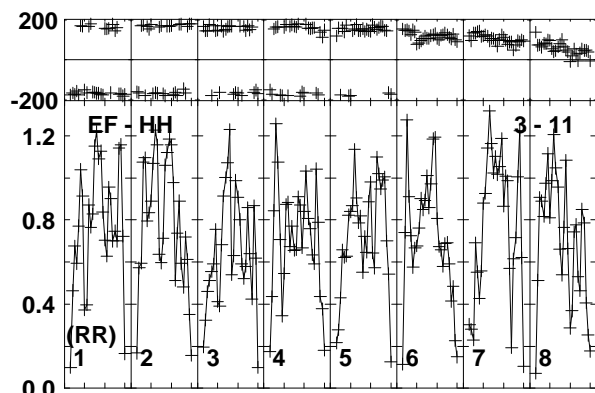
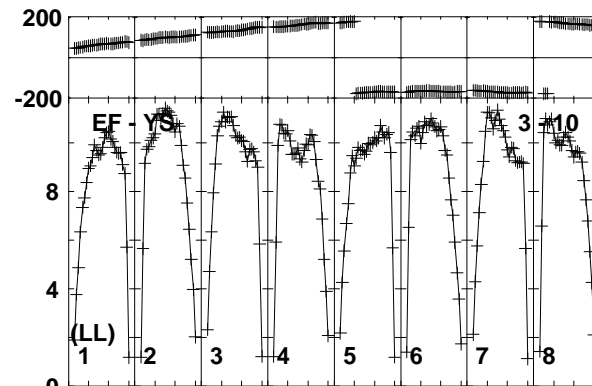
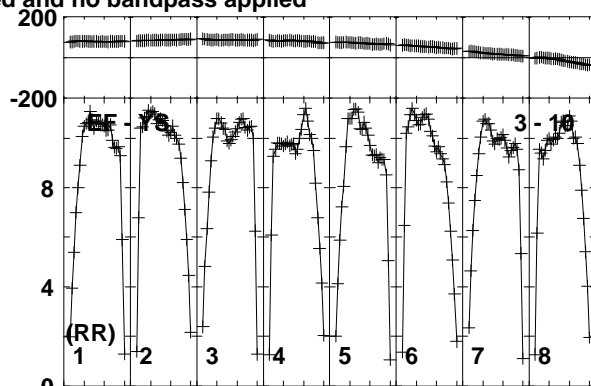
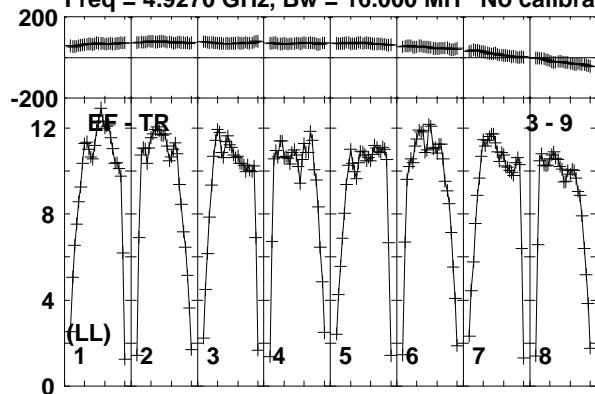

Lower frame: Milli Ampl Jy Top frame: Phas deg  
Vector averaged cross-power spectrum Baseline: EF (03) - TR (09)  
Timerange: 00/13:37:31 to 00/13:38:29

Plot file version 546 created 19-DEC-2018 17:58:51

J1619+2247 RY007C.UVDATA.1

Freq = 4.9270 GHz, Bw = 16.000 MH No calibration applied and no bandpass applied

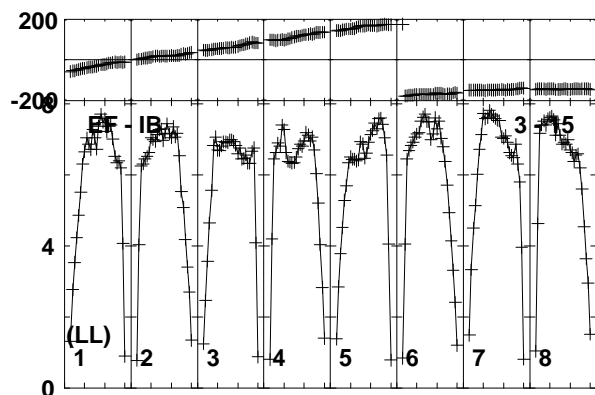
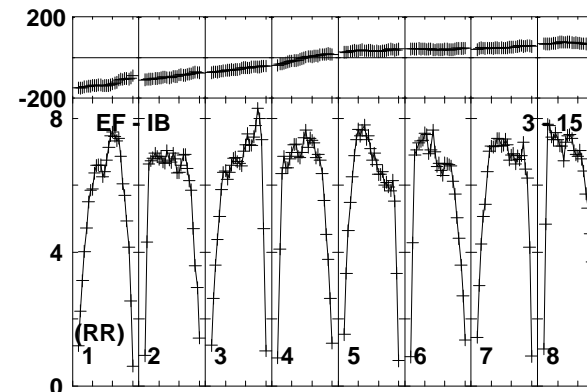
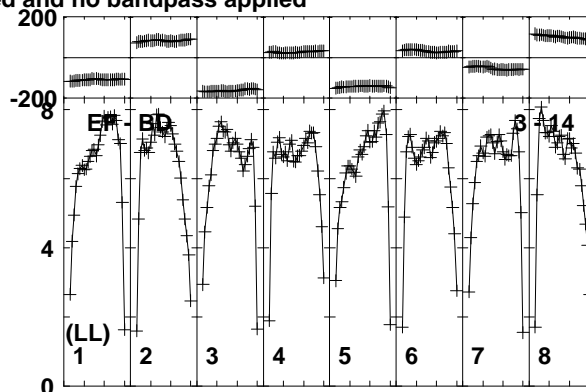
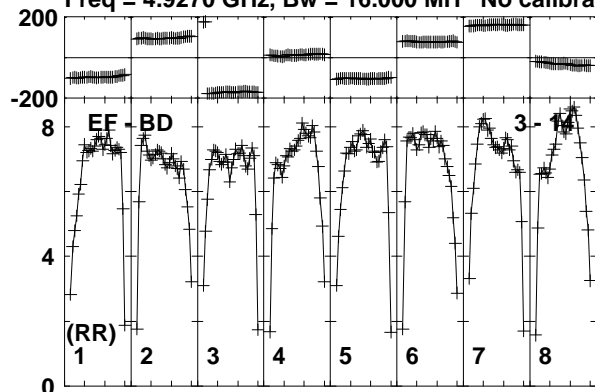

Lower frame: Milli Ampl Jy Top frame: Phas deg  
Vector averaged cross-power spectrum Baseline: EF (03) - BD (14)  
Timerange: 00/13:37:31 to 00/13:38:29



Plot file version 547 created 19-DEC-2018 17:58:52

AT2018\_RY007C.UVDATA.1

Freq = 4.9270 GHz, Bw = 16.000 MH No calibration applied and no bandpass applied

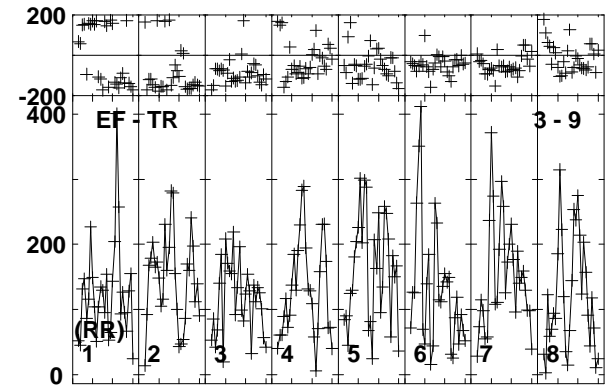
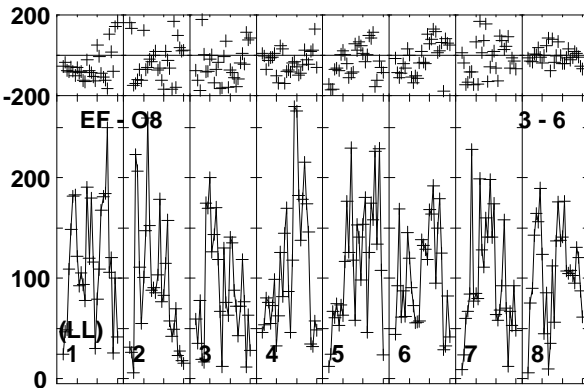
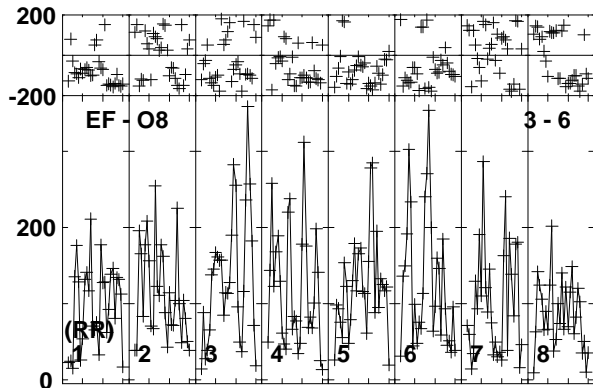
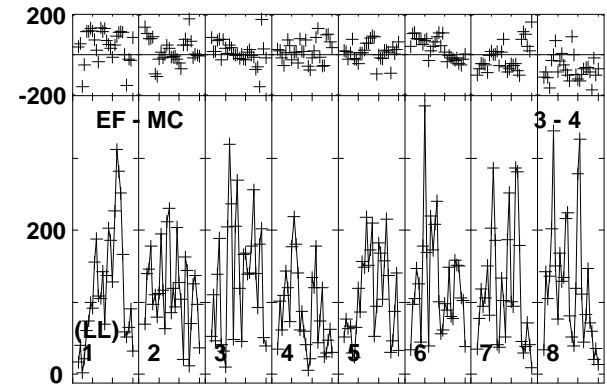
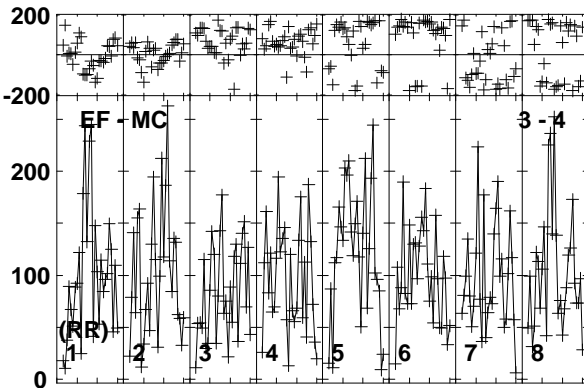
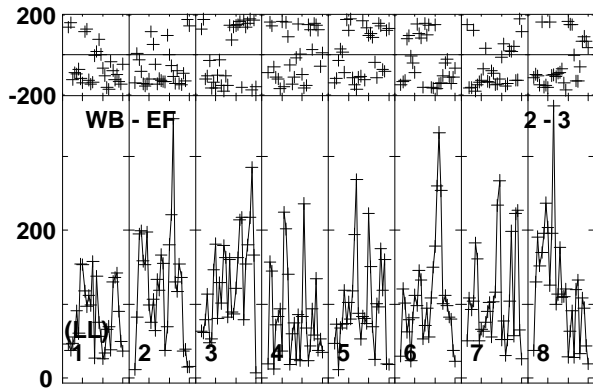
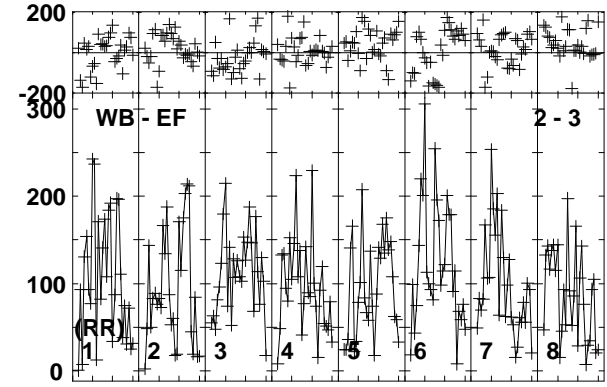
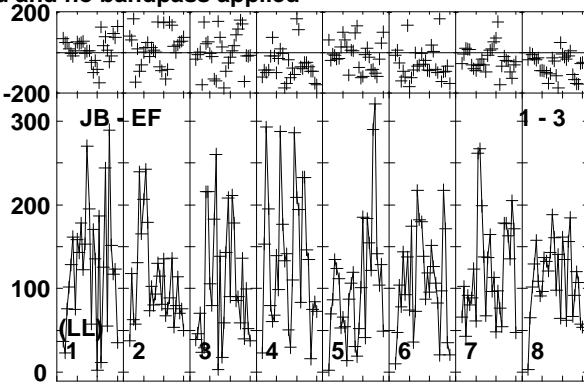
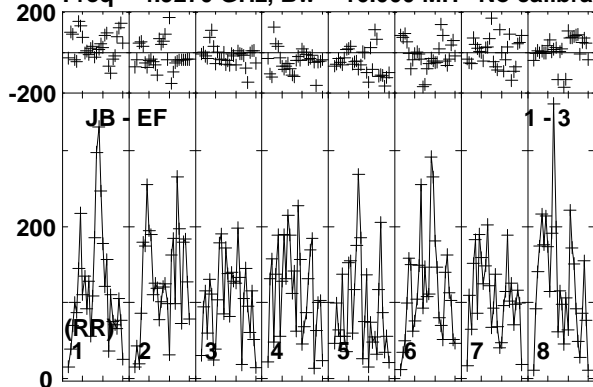

Lower frame: Micro Ampl Jy Top frame: Phas deg  
Vector averaged cross-power spectrum Baseline: JB (01) - EF (03)  
Timerange: 00/13:38:31 to 00/13:41:29

Plot file version 548 created 19-DEC-2018 17:58:52

AT2018\_RY007C.UVDATA.1

Freq = 4.9270 GHz, Bw = 16.000 MH No calibration applied and no bandpass applied

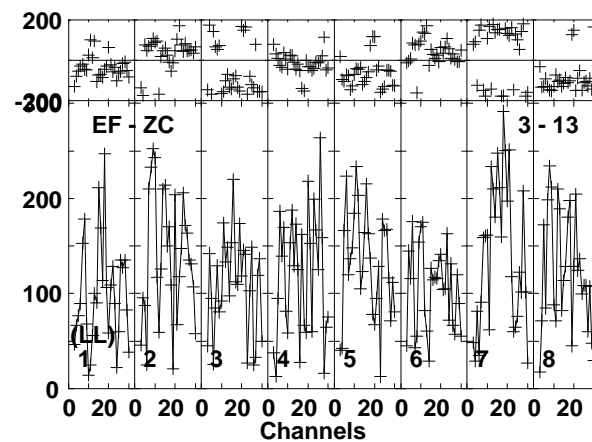
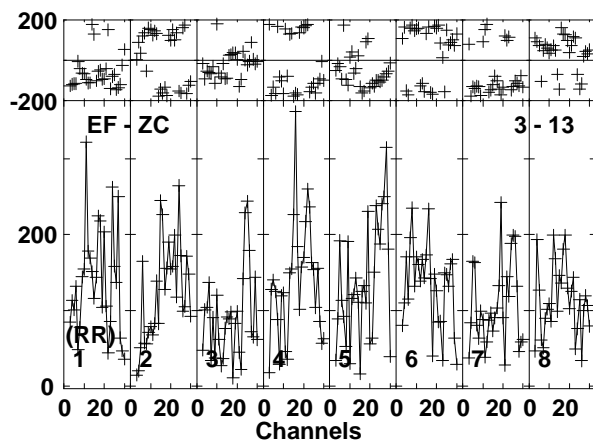
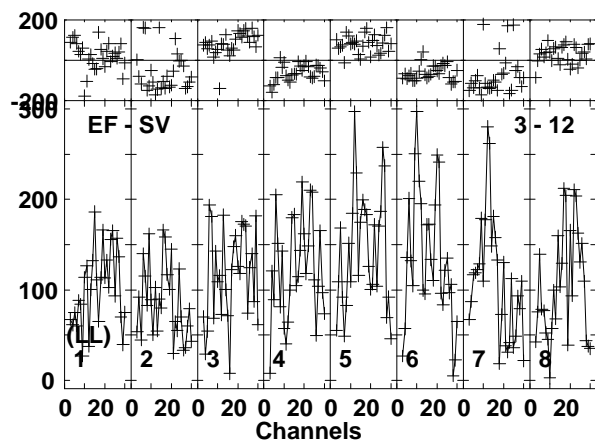
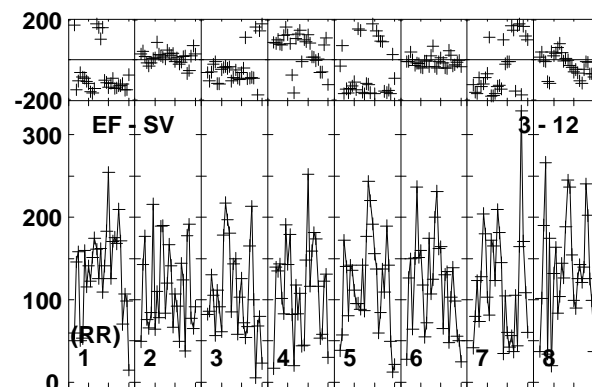
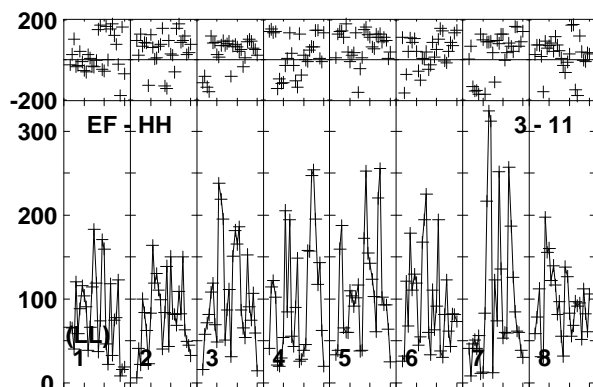
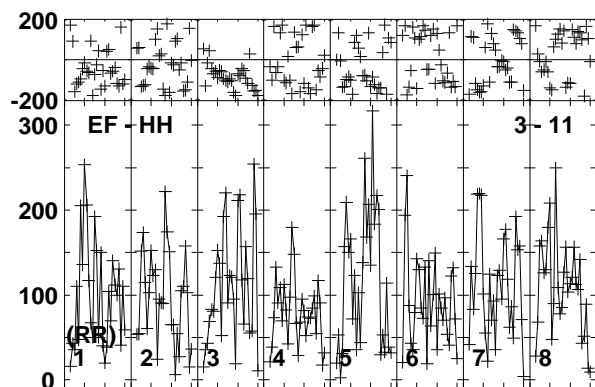
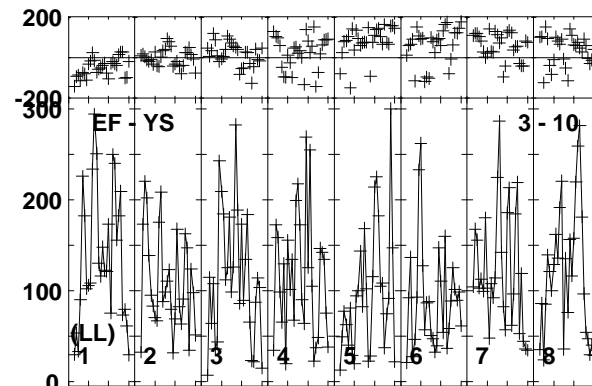
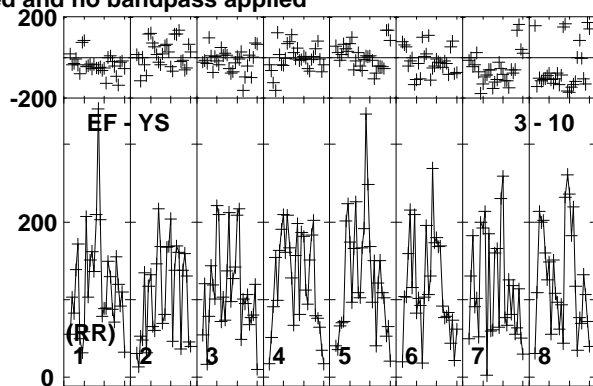
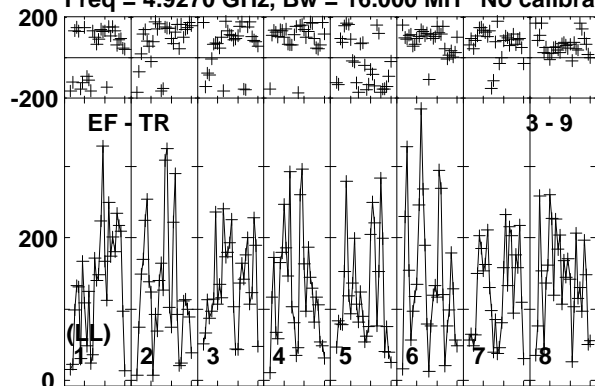

Lower frame: Micro Ampl Jy Top frame: Phas deg  
Vector averaged cross-power spectrum Baseline: EF (03) - TR (09)  
Timerange: 00/13:38:31 to 00/13:41:29

Plot file version 549 created 19-DEC-2018 17:58:52

AT2018\_RY007C.UVDATA.1

Freq = 4.9270 GHz, Bw = 16.000 MH No calibration applied and no bandpass applied

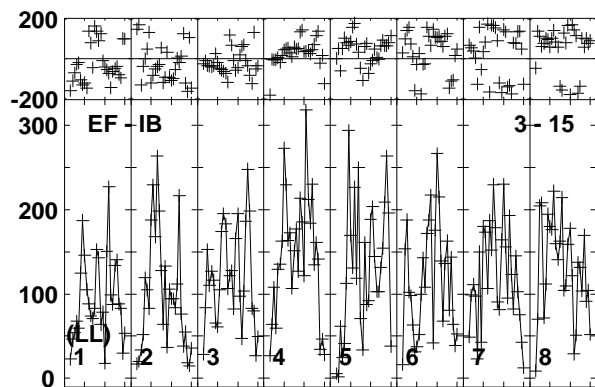
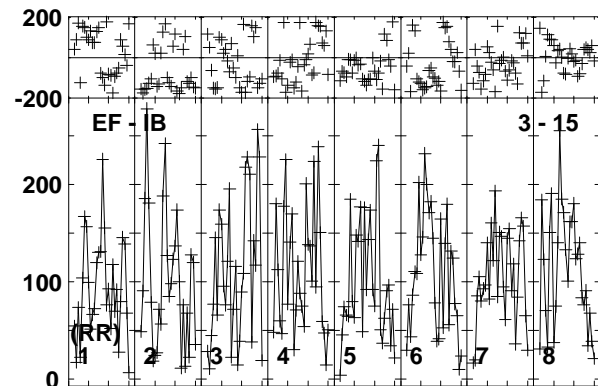
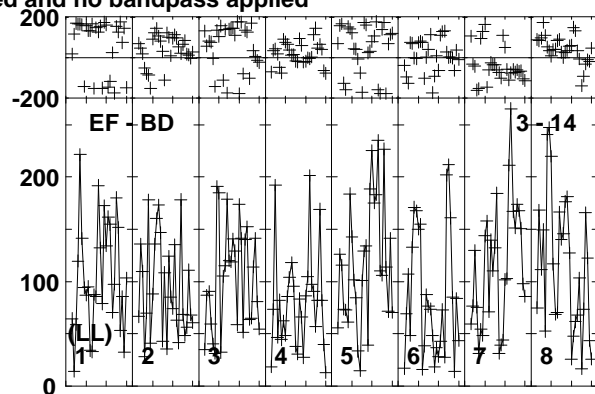
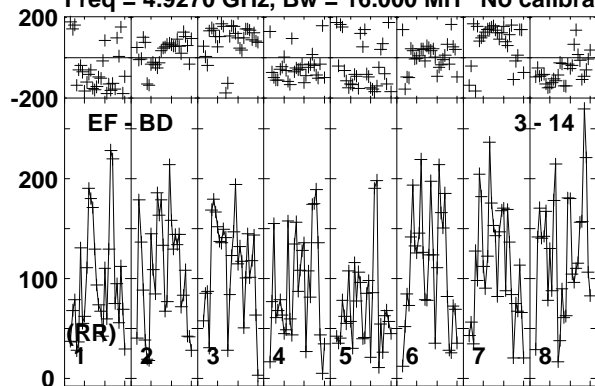

Lower frame: Micro Ampl Jy Top frame: Phas deg  
Vector averaged cross-power spectrum Baseline: EF (03) - BD (14)  
Timerange: 00/13:38:31 to 00/13:41:29

Plot file version 550 created 19-DEC-2018 17:58:52

J1619+2247 RY007C.UVDATA.1

Freq = 4.9270 GHz, Bw = 16.000 MH No calibration applied and no bandpass applied

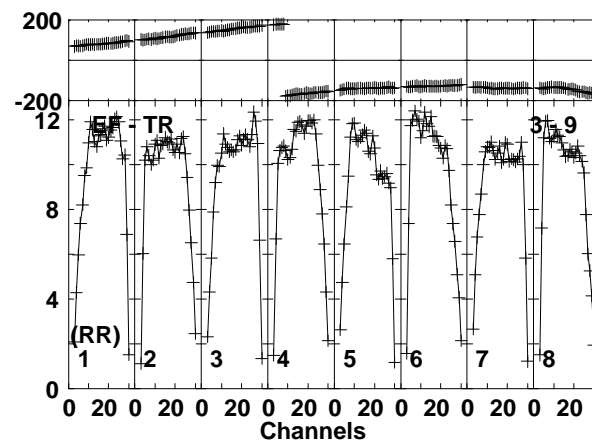
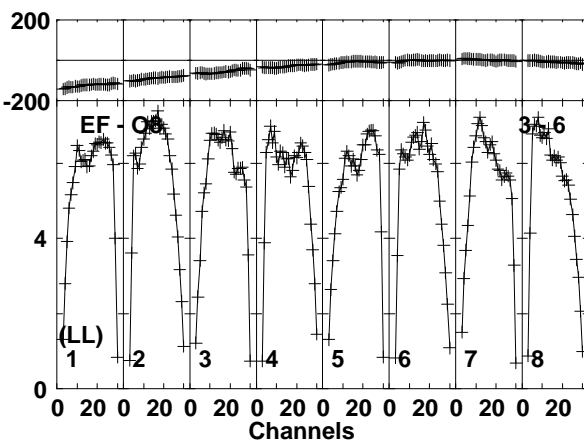
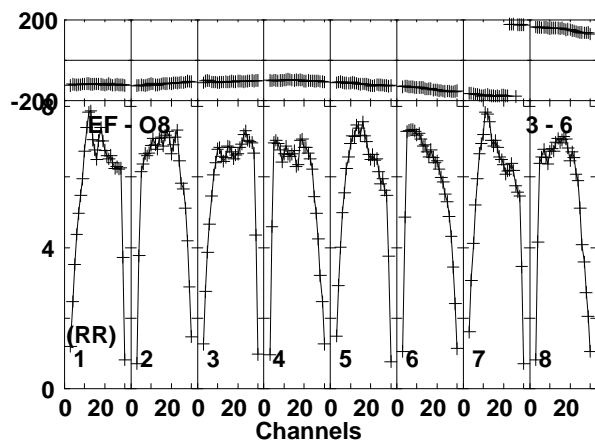
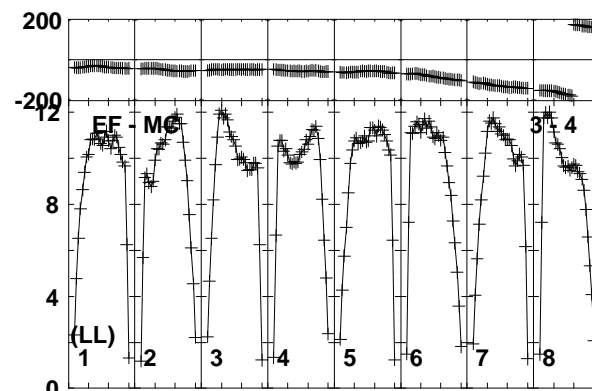
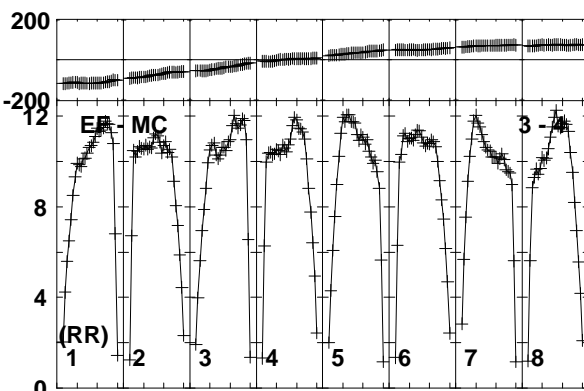
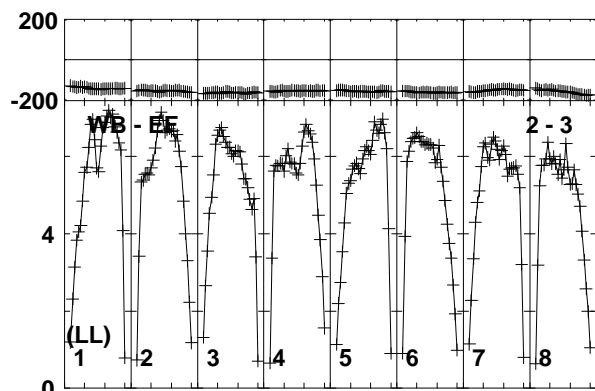
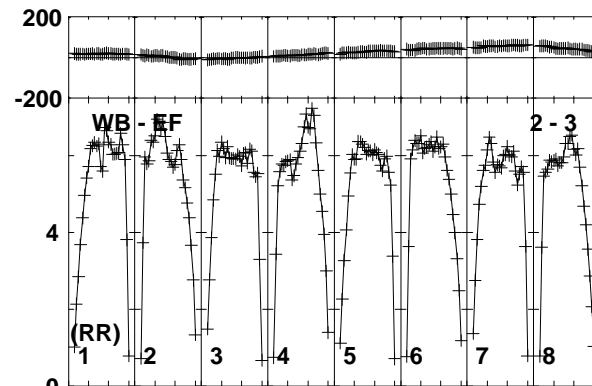
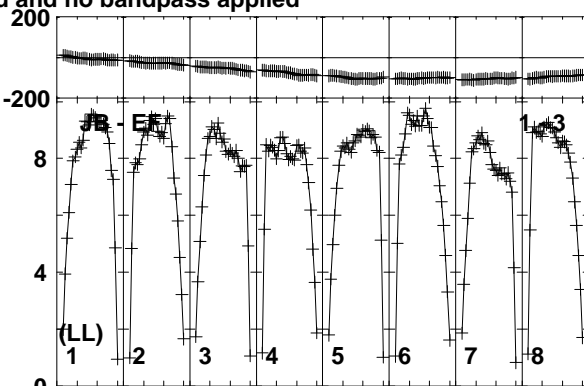
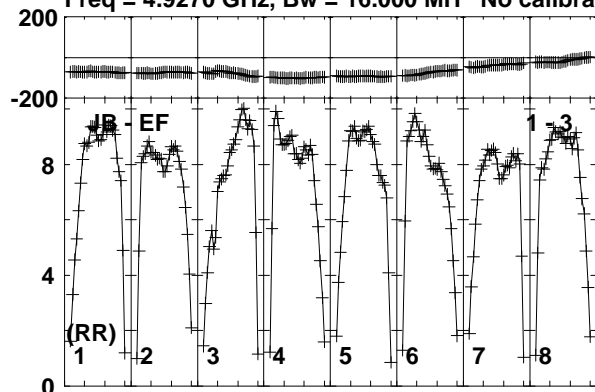

Lower frame: Milli Ampl Jy Top frame: Phas deg  
Vector averaged cross-power spectrum Baseline: JB (01) - EF (03)  
Timerange: 00/13:41:31 to 00/13:42:29

Plot file version 551 created 19-DEC-2018 17:58:52

J1619+2247 RY007C.UVDATA.1

Freq = 4.9270 GHz, Bw = 16.000 MH No calibration applied and no bandpass applied

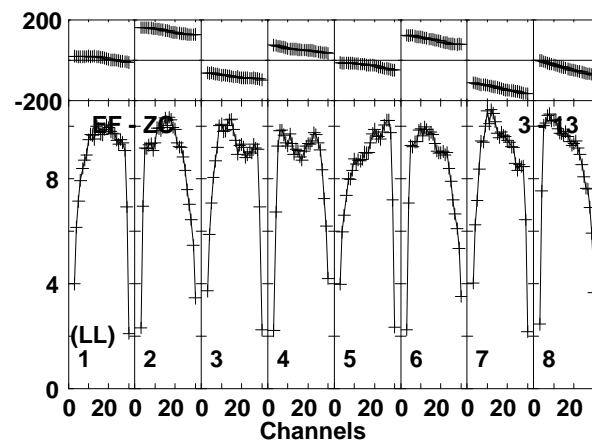
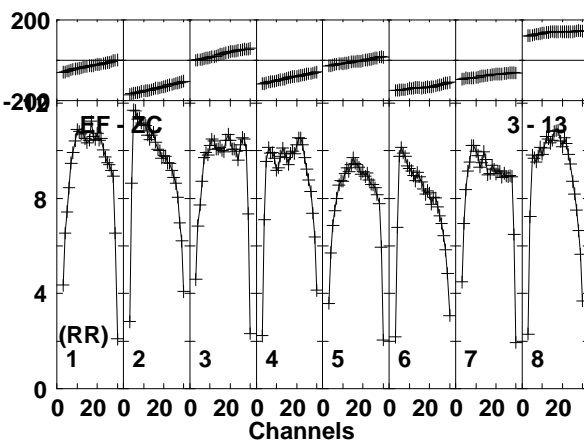
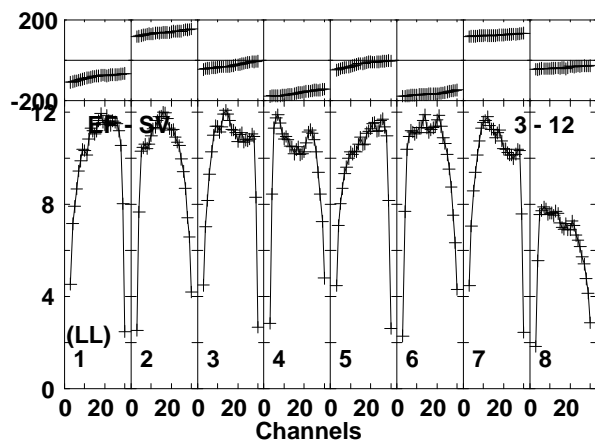
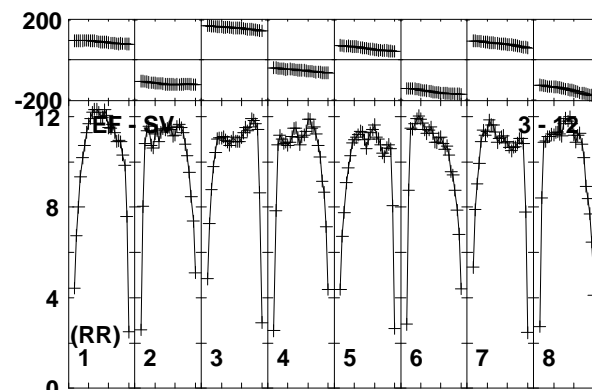
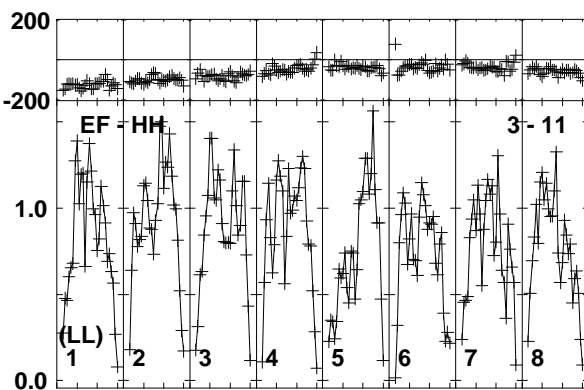
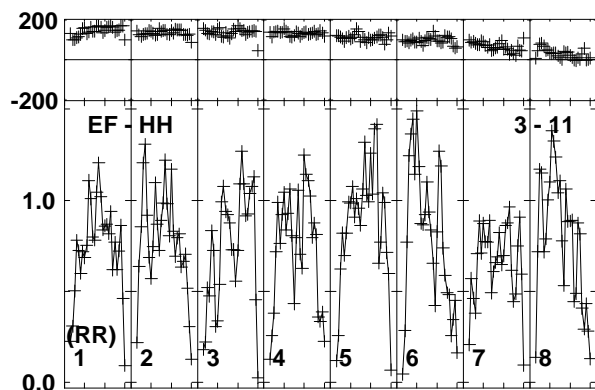
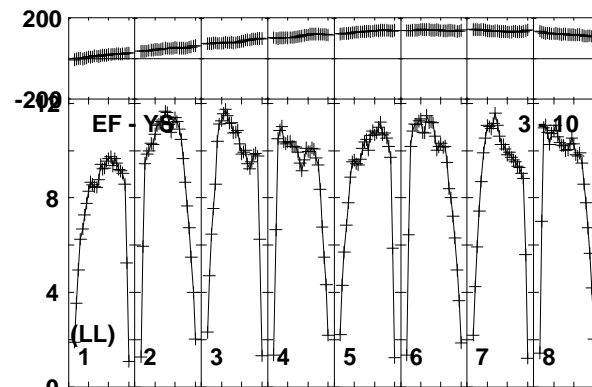
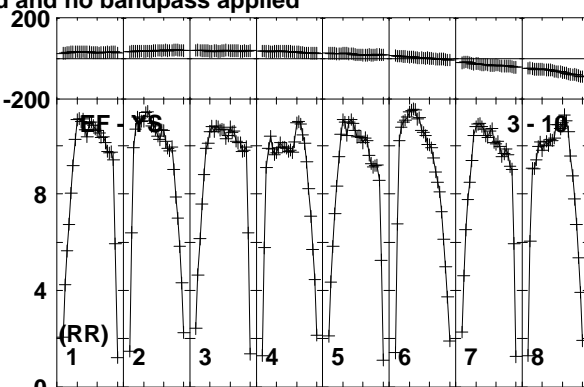
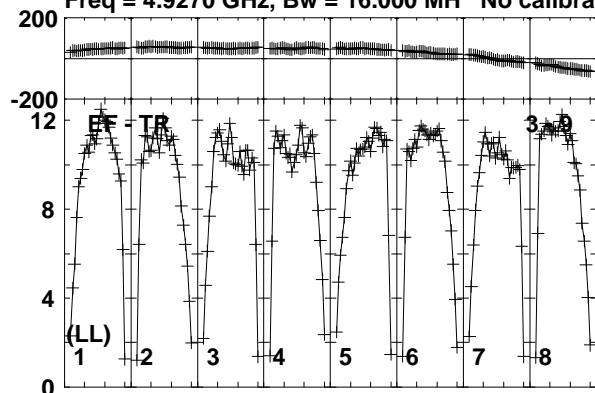

Lower frame: Milli Ampl Jy Top frame: Phas deg  
Vector averaged cross-power spectrum Baseline: EF (03) - TR (09)  
Timerange: 00/13:41:31 to 00/13:42:29

Plot file version 552 created 19-DEC-2018 17:58:52

J1619+2247 RY007C.UVDATA.1

Freq = 4.9270 GHz, Bw = 16.000 MH No calibration applied and no bandpass applied

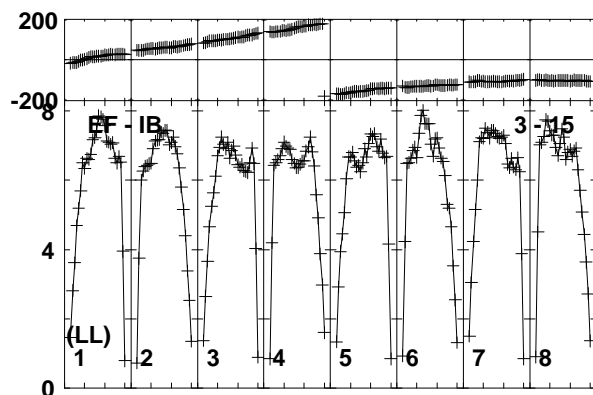
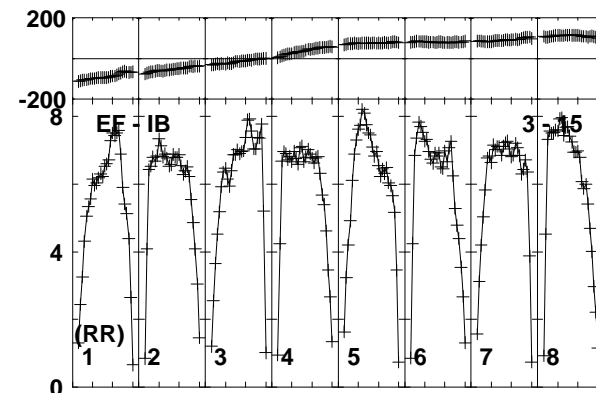
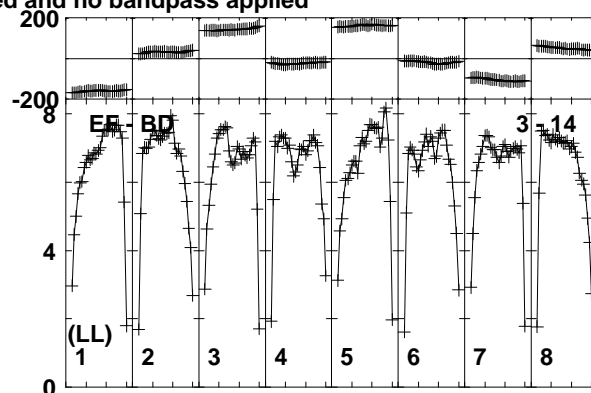
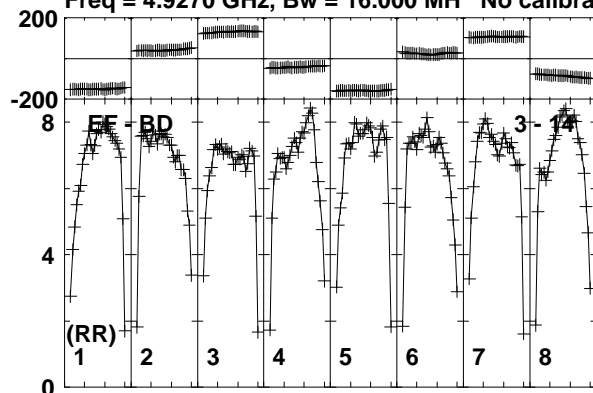

Lower frame: Milli Ampl Jy Top frame: Phas deg  
Vector averaged cross-power spectrum Baseline: EF (03) - BD (14)  
Timerange: 00/13:41:31 to 00/13:42:29

Plot file version 553 created 19-DEC-2018 17:58:52  
 VLA1 RY007C.UVDATA.1  
 Freq = 4.9270 GHz, Bw = 16.000 MH No calibration applied and no bandpass applied

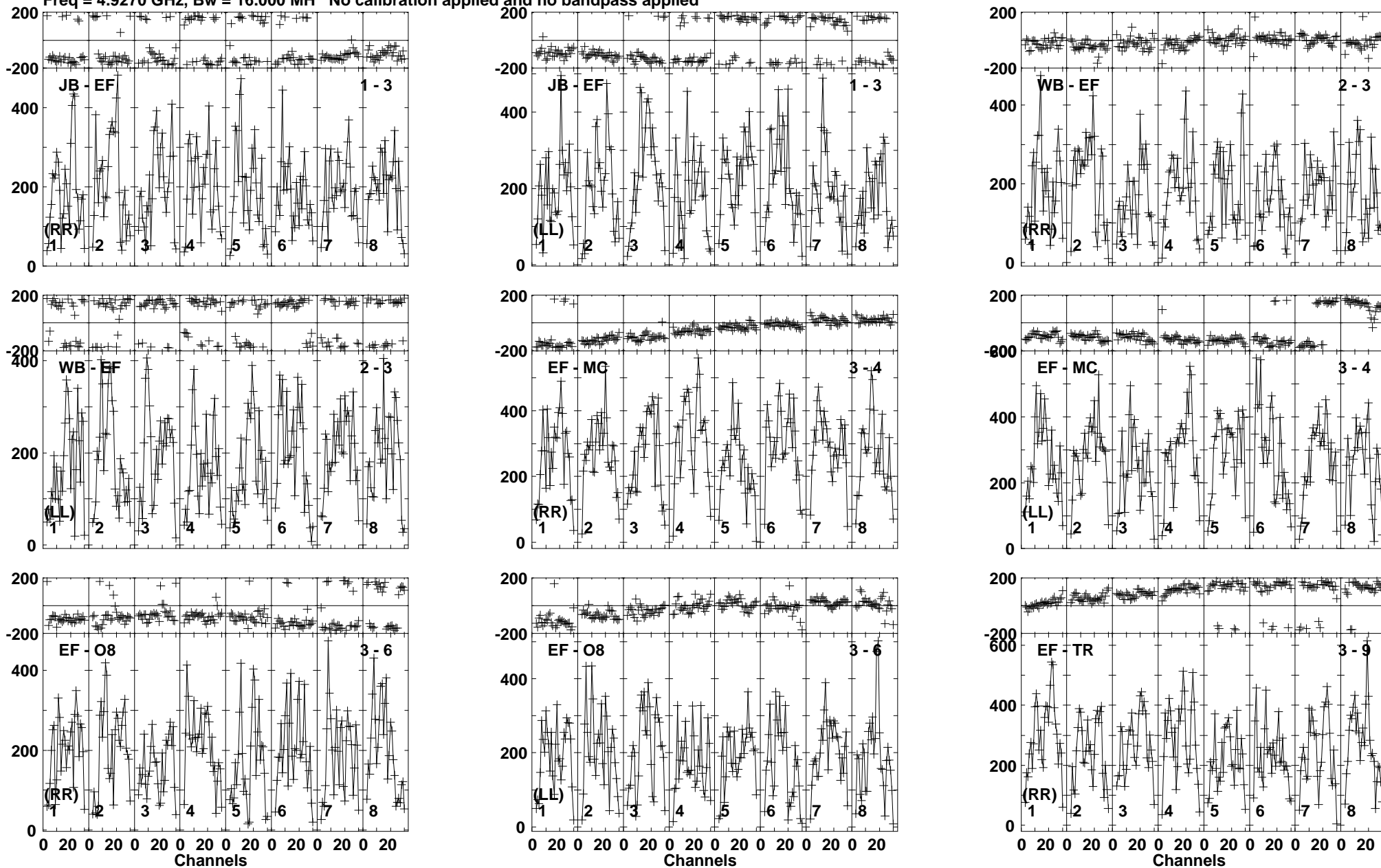

Lower frame: Micro Ampl Jy Top frame: Phas deg  
 Vector averaged cross-power spectrum Baseline: JB (01) - EF (03)  
 Timerange: 00/13:43:01 to 00/13:44:59

Plot file version 554 created 19-DEC-2018 17:58:52

VLA1 RY007C.UVDATA.1

Freq = 4.9270 GHz, Bw = 16.000 MH No calibration applied and no bandpass applied

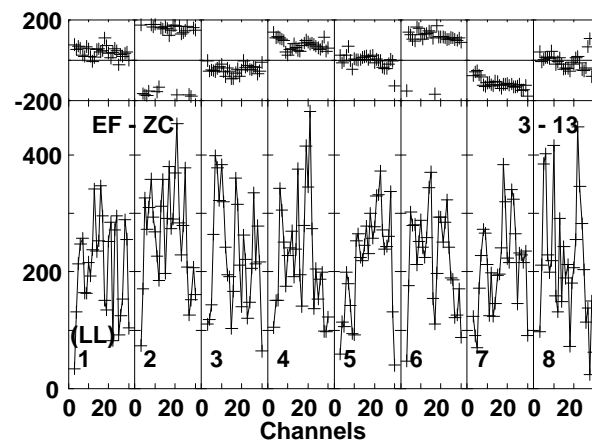
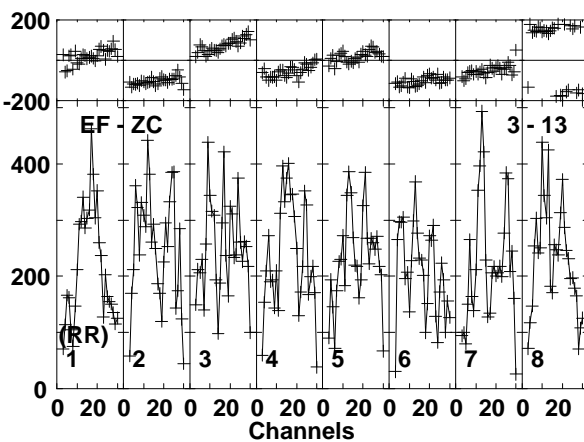
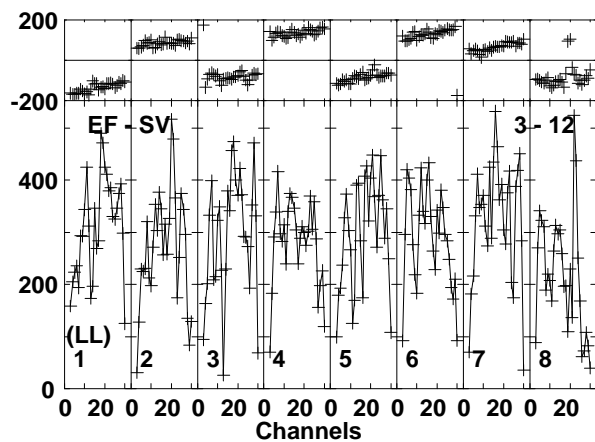
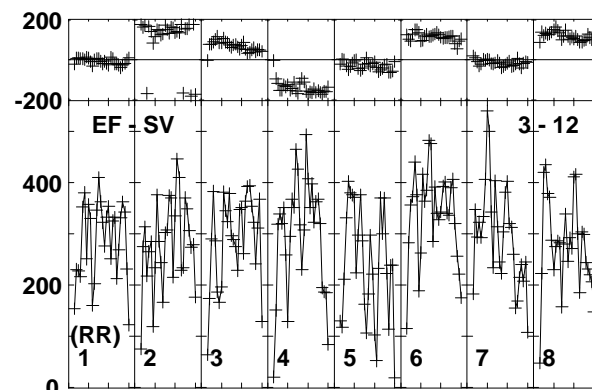
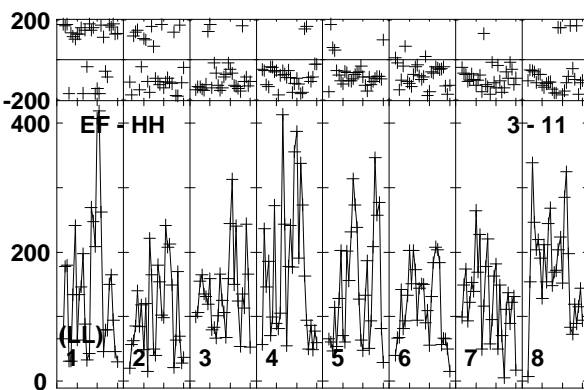
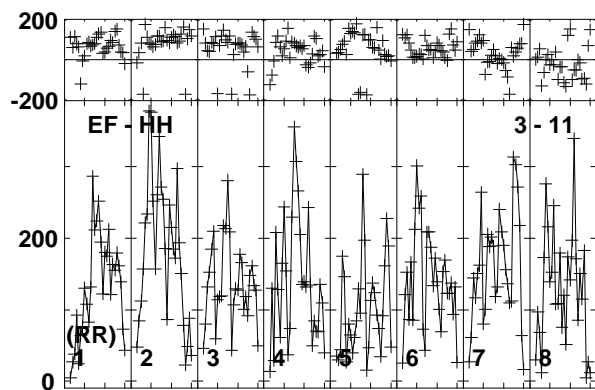
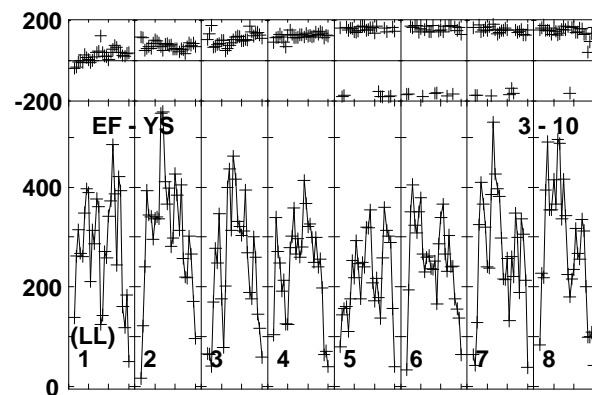
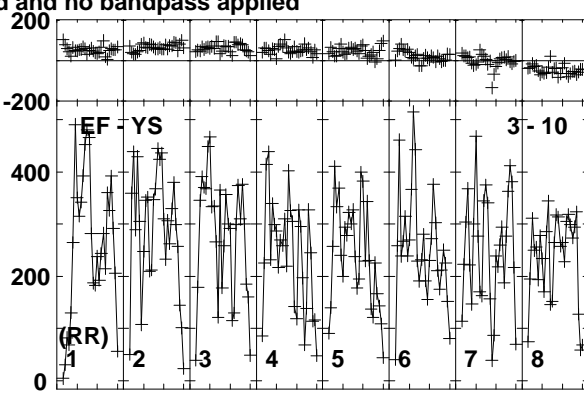
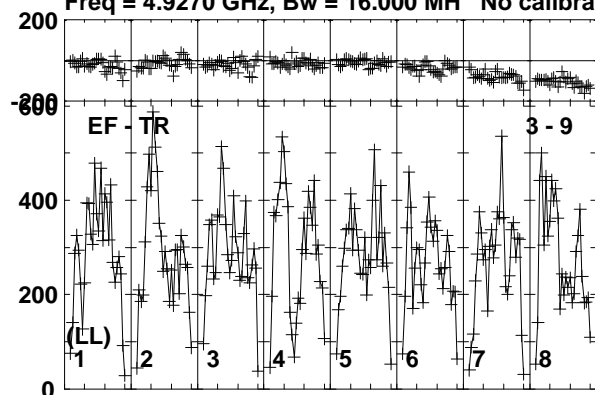

Lower frame: Micro Ampl Jy Top frame: Phas deg  
Vector averaged cross-power spectrum Baseline: EF (03) - TR (09)  
Timerange: 00/13:43:01 to 00/13:44:59



Plot file version 555 created 19-DEC-2018 17:58:52

VLA1 RY007C.UVDATA.1

Freq = 4.9270 GHz, Bw = 16.000 MH No calibration applied and no bandpass applied

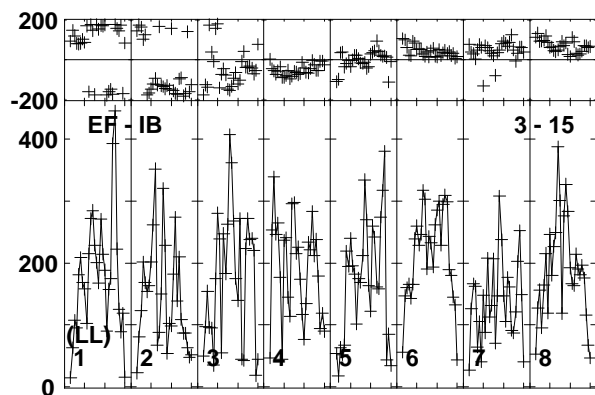
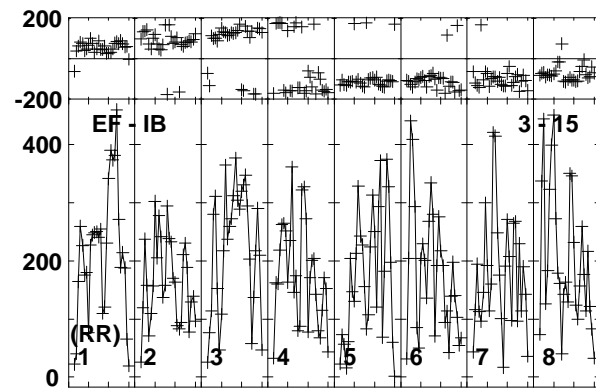
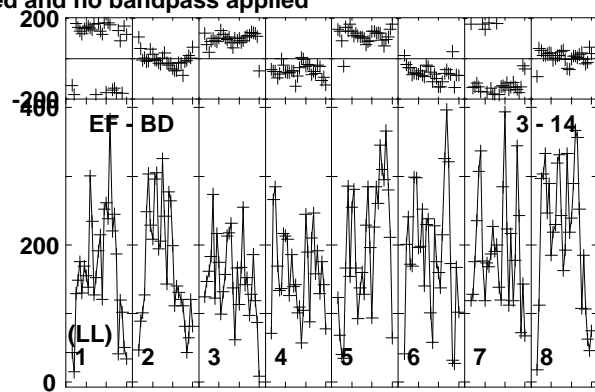
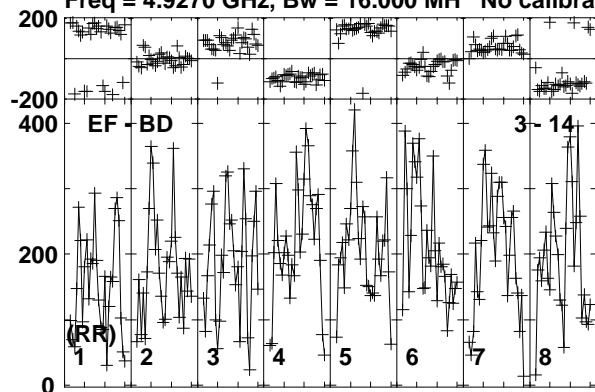

Lower frame: Micro Ampl Jy Top frame: Phas deg  
Vector averaged cross-power spectrum Baseline: EF (03) - BD (14)  
Timerange: 00/13:43:01 to 00/13:44:59

Plot file version 556 created 19-DEC-2018 17:58:52

J1619+2247 RY007C.UVDATA.1

Freq = 4.9270 GHz, Bw = 16.000 MH No calibration applied and no bandpass applied

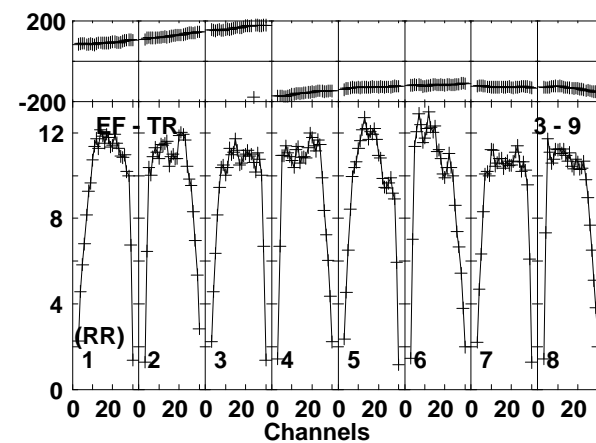
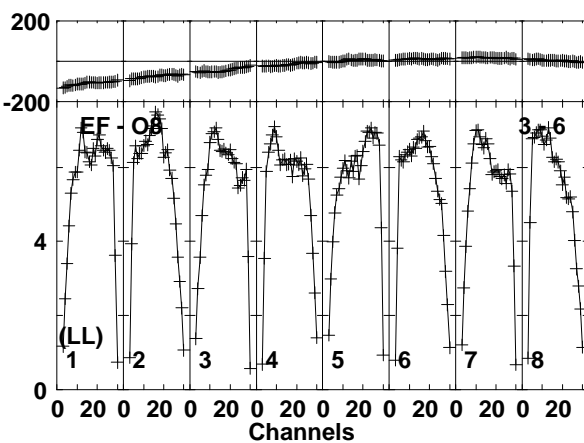
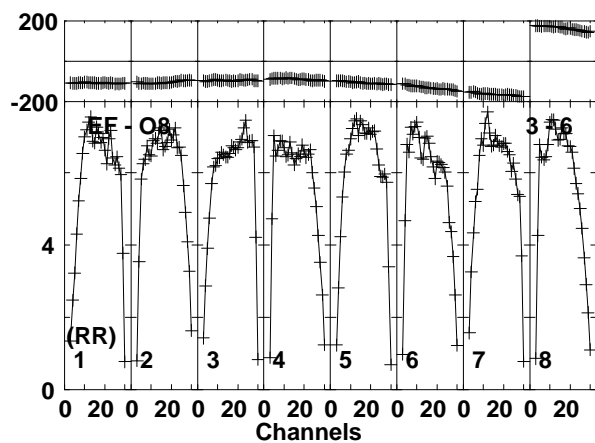
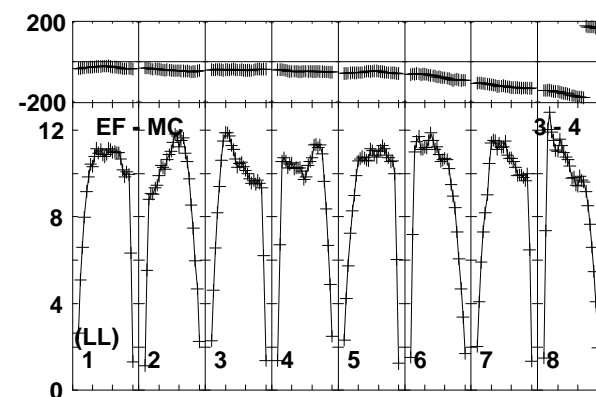
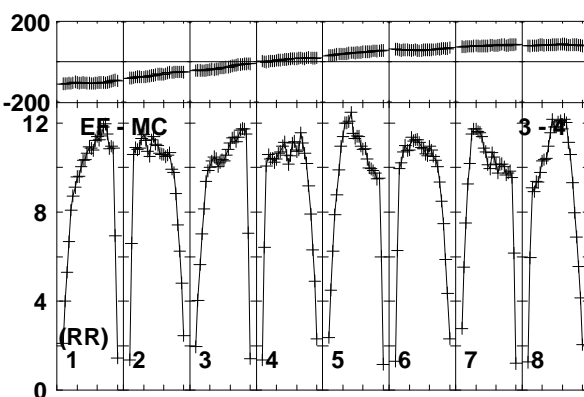
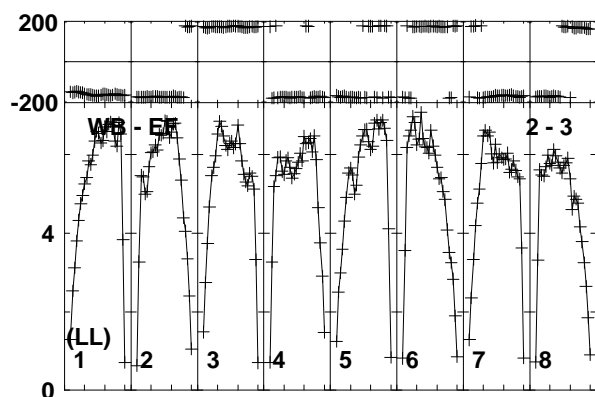
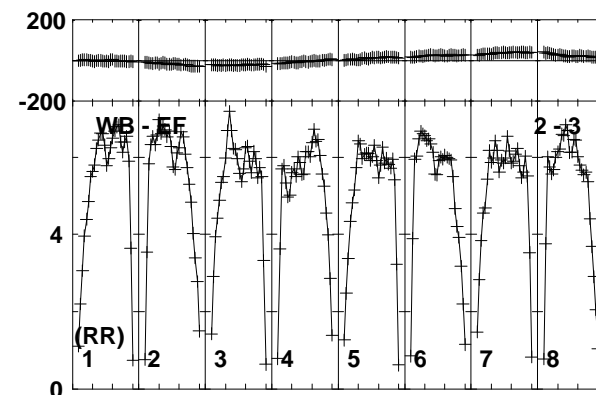
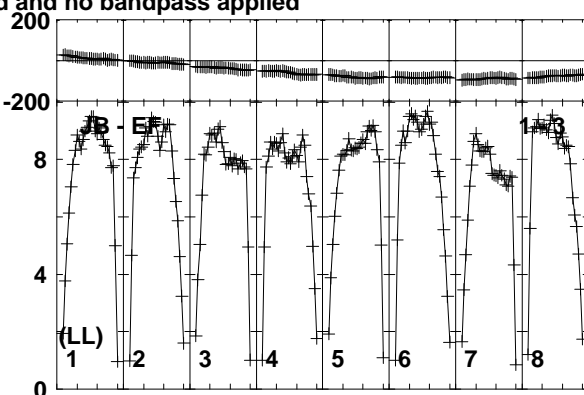
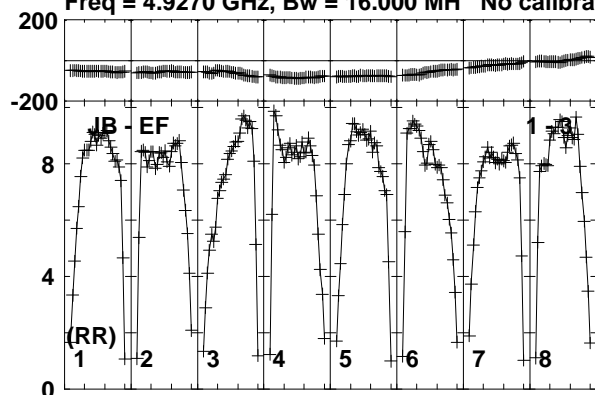

Lower frame: Milli Ampl Jy Top frame: Phas deg  
Vector averaged cross-power spectrum Baseline: JB (01) - EF (03)  
Timerange: 00/13:45:01 to 00/13:45:59

Plot file version 557 created 19-DEC-2018 17:58:52

J1619+2247 RY007C.UVDATA.1

Freq = 4.9270 GHz, Bw = 16.000 MH No calibration applied and no bandpass applied

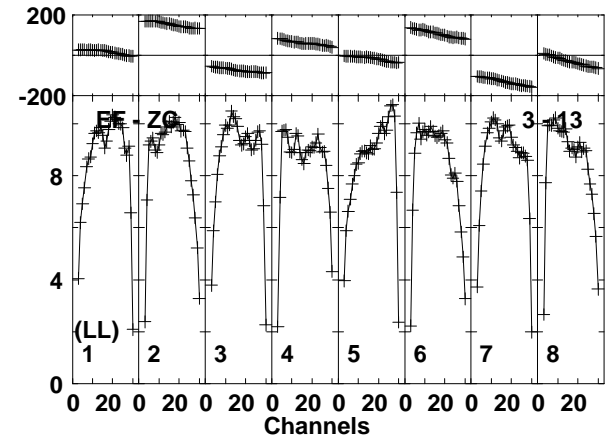
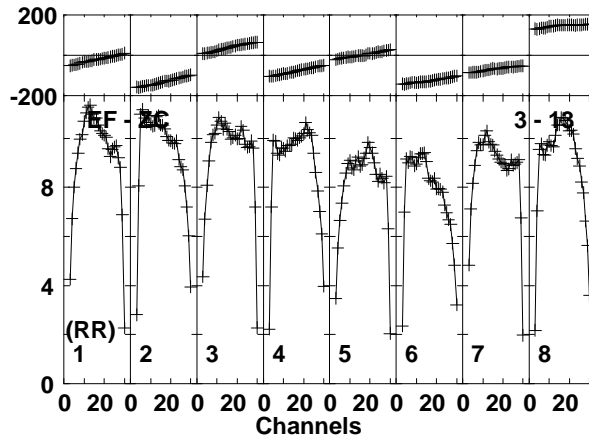
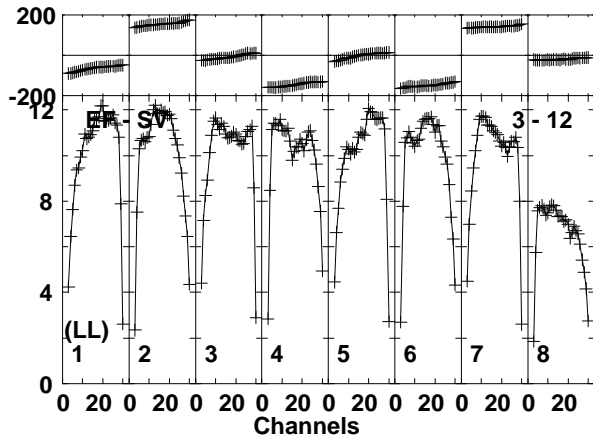
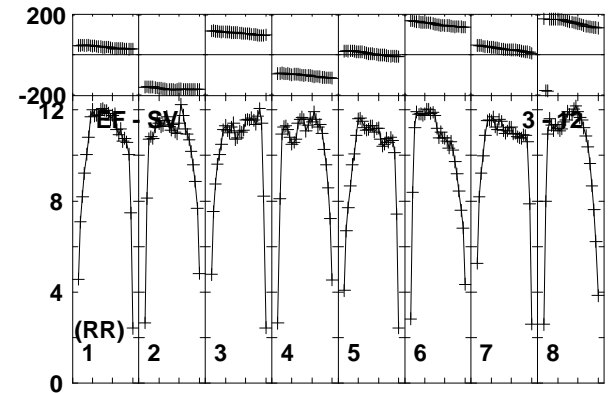
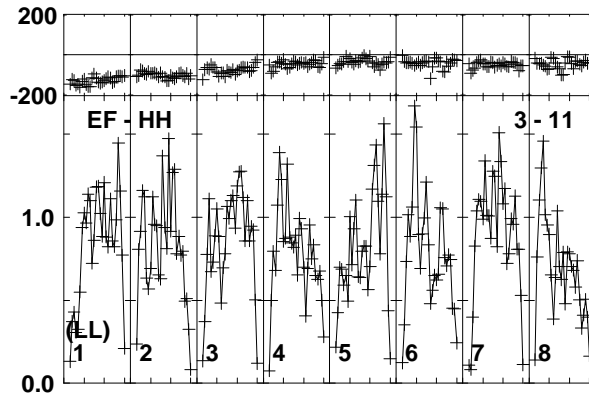
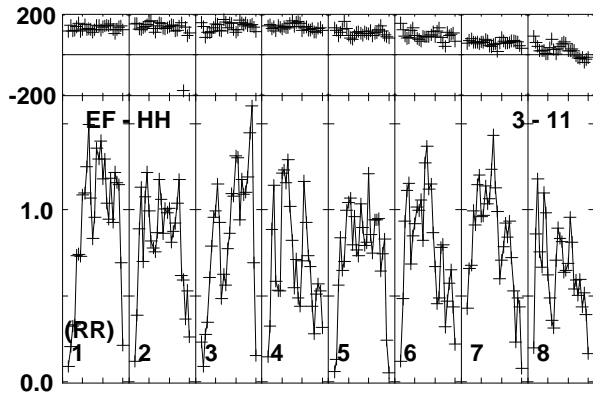
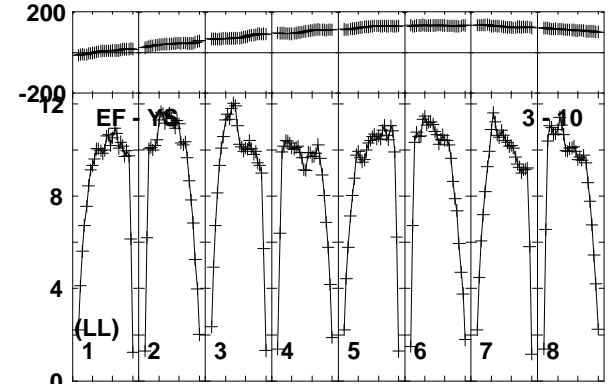
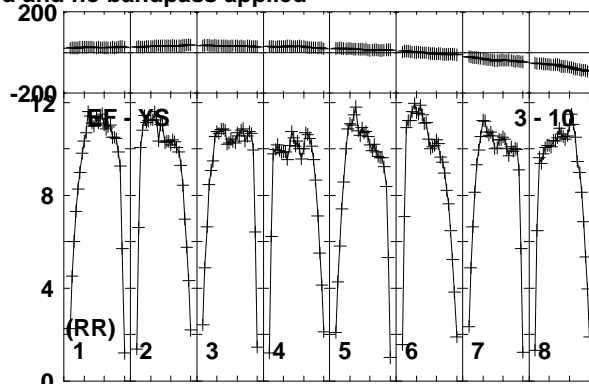
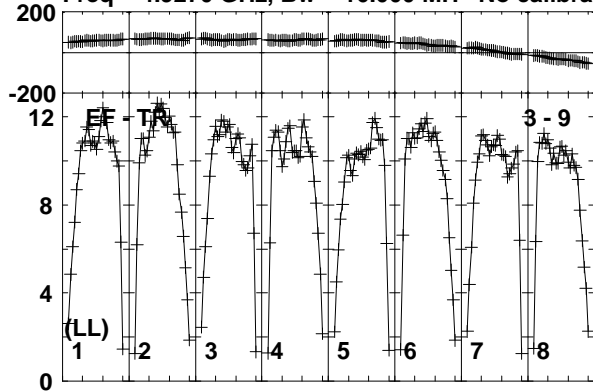

Lower frame: Milli Ampl Jy Top frame: Phas deg  
Vector averaged cross-power spectrum Baseline: EF (03) - TR (09)  
Timerange: 00/13:45:01 to 00/13:45:59

Plot file version 558 created 19-DEC-2018 17:58:52

J1619+2247 RY007C.UVDATA.1

Freq = 4.9270 GHz, Bw = 16.000 MH No calibration applied and no bandpass applied

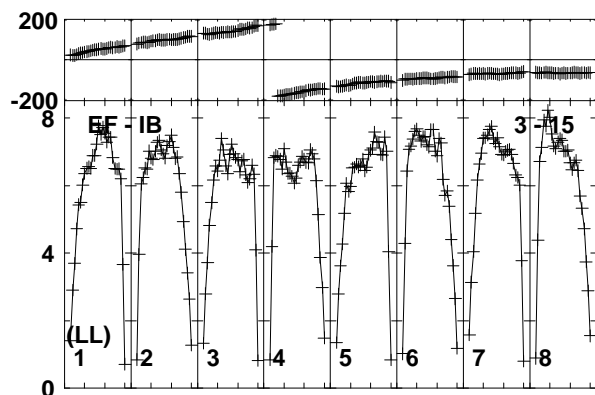
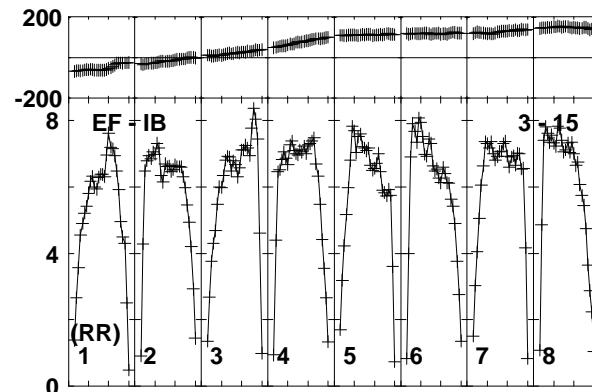
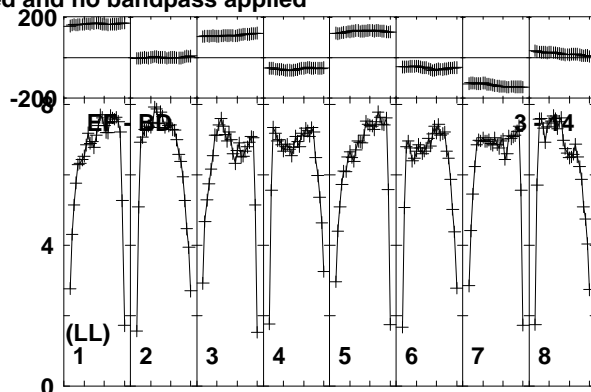
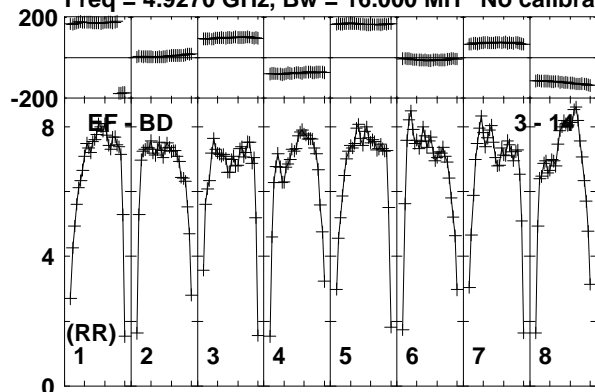

Lower frame: Milli Ampl Jy Top frame: Phas deg  
Vector averaged cross-power spectrum Baseline: EF (03) - BD (14)  
Timerange: 00/13:45:01 to 00/13:45:59

Plot file version 559 created 19-DEC-2018 17:58:52  
 AT2018\_RY007C.UVDATA.1

Freq = 4.9270 GHz, Bw = 16.000 MH No calibration applied and no bandpass applied

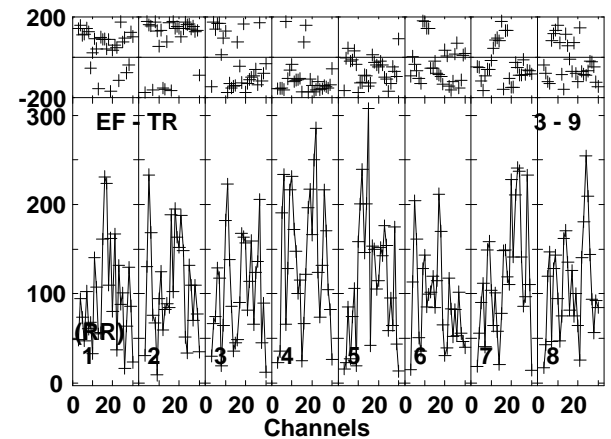
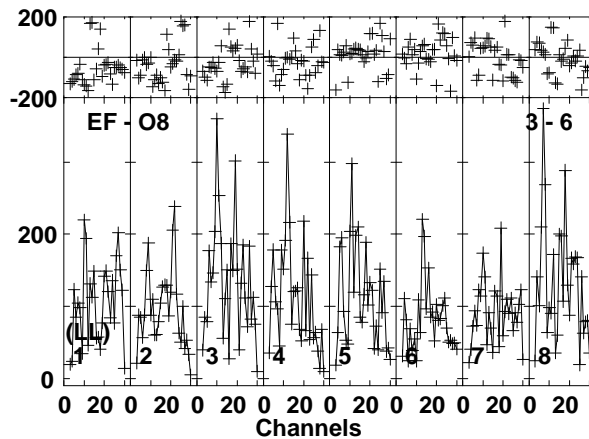
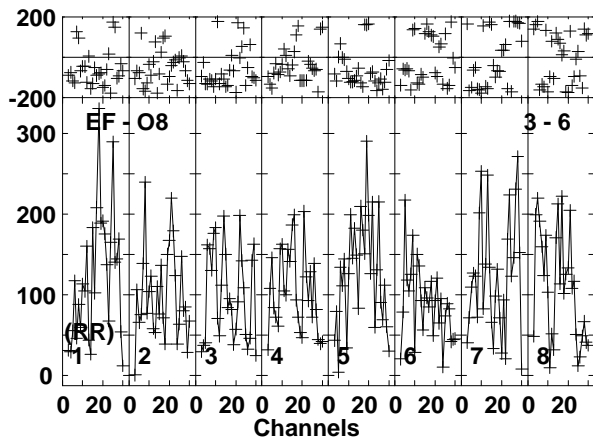
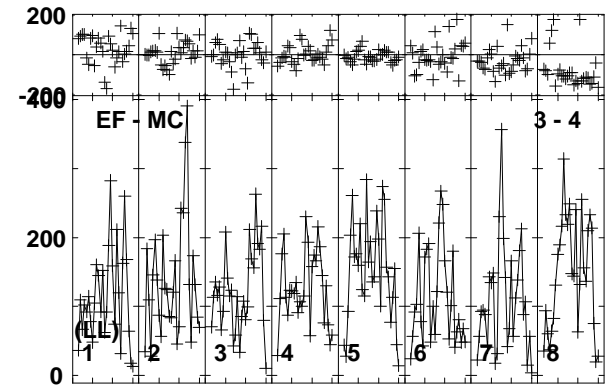
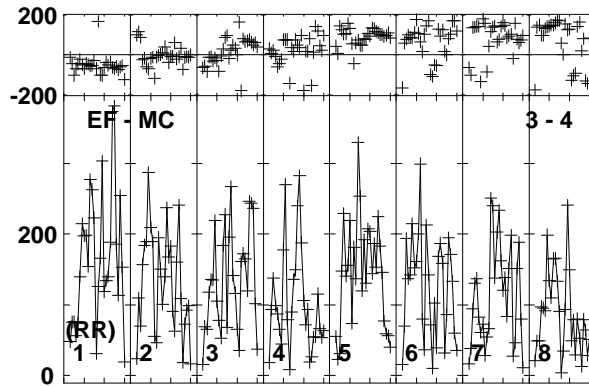
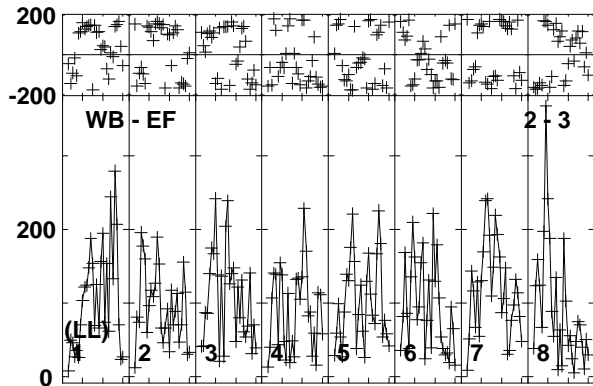
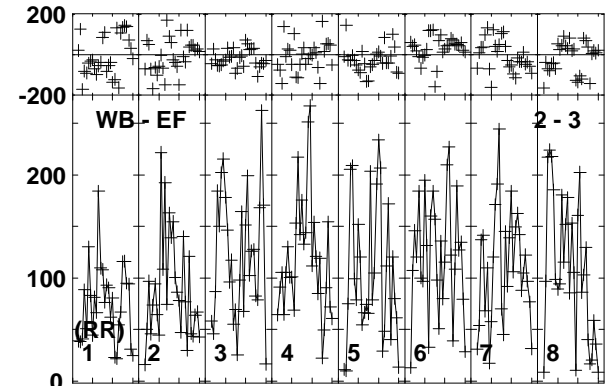
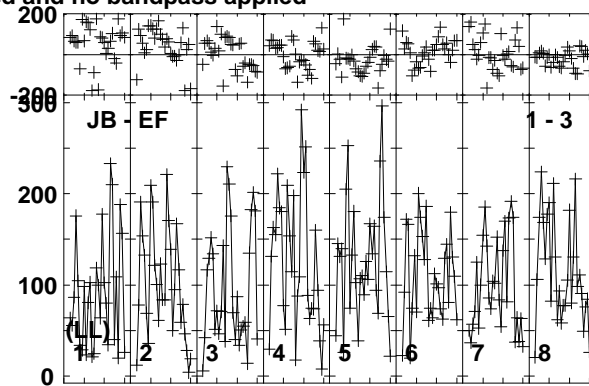
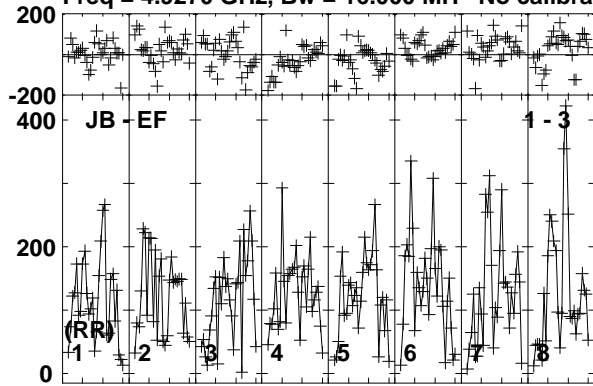

Lower frame: Micro Ampl Jy Top frame: Phas deg  
 Vector averaged cross-power spectrum Baseline: JB (01) - EF (03)  
 Timerange: 00/13:46:01 to 00/13:48:59

Plot file version 560 created 19-DEC-2018 17:58:52

AT2018\_RY007C.UVDATA.1

Freq = 4.9270 GHz, Bw = 16.000 MH No calibration applied and no bandpass applied

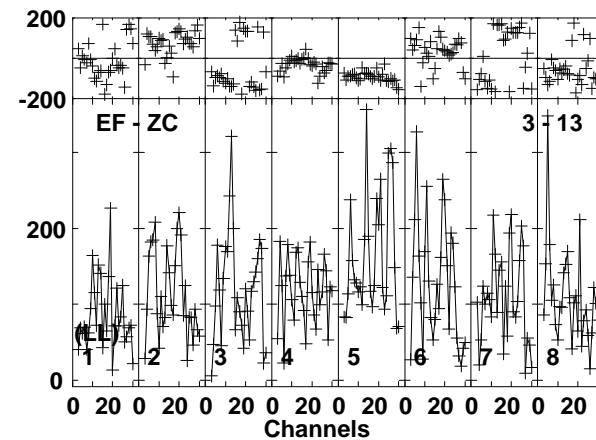
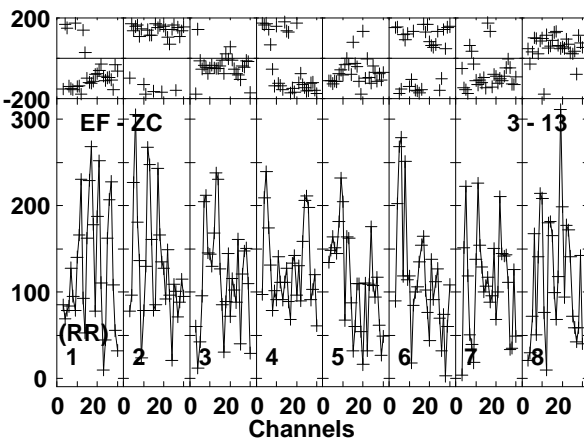
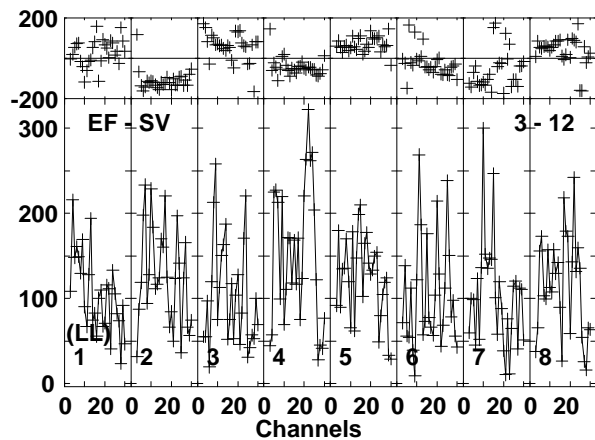
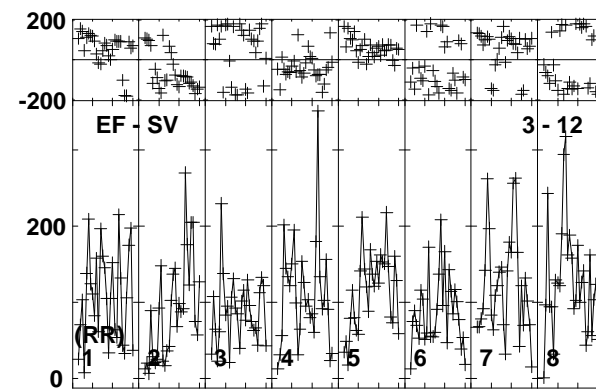
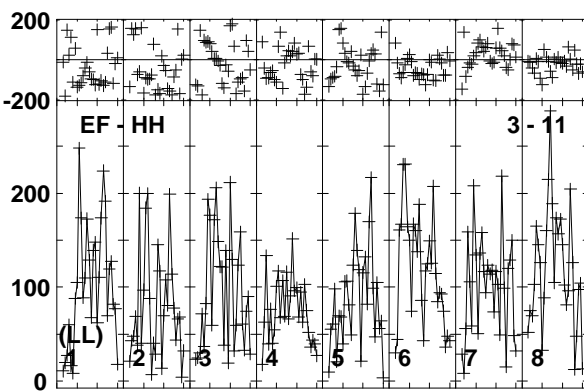
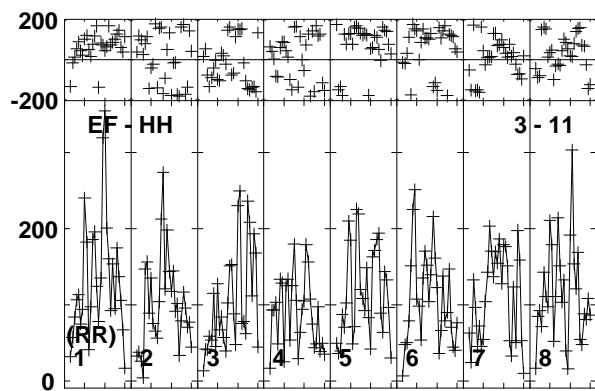
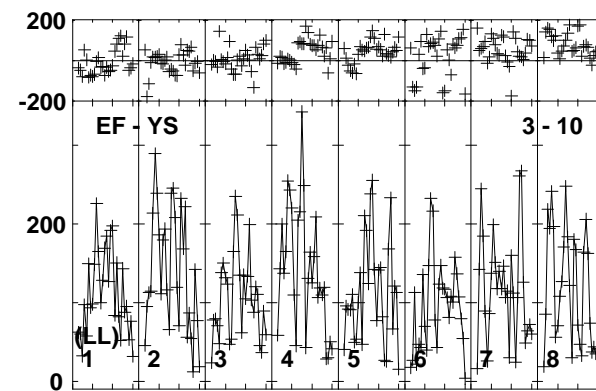
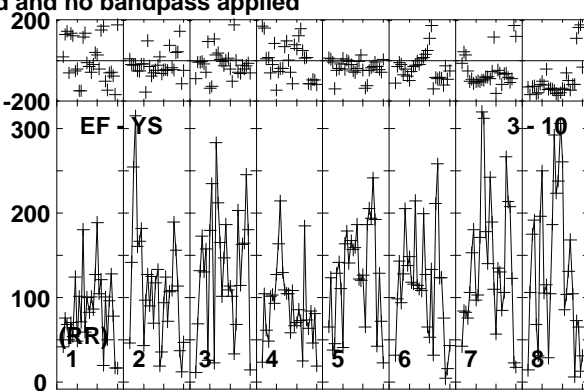
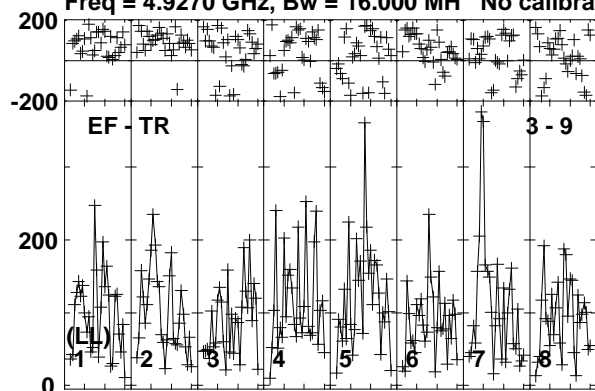

Lower frame: Micro Ampl Jy Top frame: Phas deg  
Vector averaged cross-power spectrum Baseline: EF (03) - TR (09)  
Timerange: 00/13:46:01 to 00/13:48:59

Plot file version 561 created 19-DEC-2018 17:58:52

AT2018\_RY007C.UVDATA.1

Freq = 4.9270 GHz, Bw = 16.000 MH No calibration applied and no bandpass applied

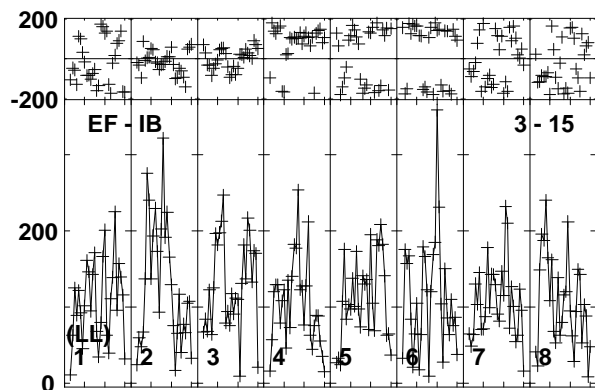
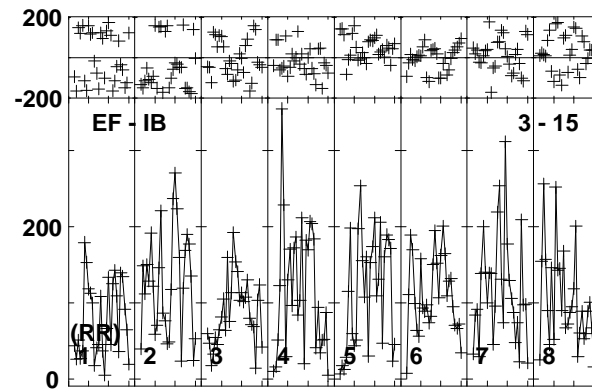
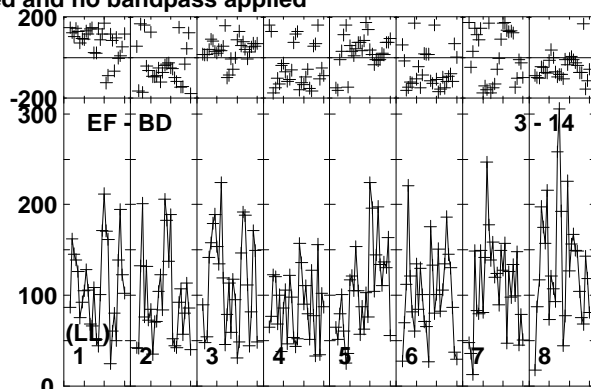
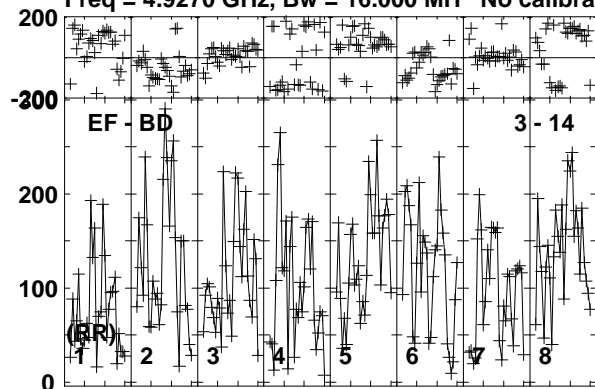

Lower frame: Micro Ampl Jy Top frame: Phas deg  
Vector averaged cross-power spectrum Baseline: EF (03) - BD (14)  
Timerange: 00/13:46:01 to 00/13:48:59

Plot file version 562 created 19-DEC-2018 17:58:52

J1619+2247 RY007C.UVDATA.1

Freq = 4.9270 GHz, Bw = 16.000 MH No calibration applied and no bandpass applied

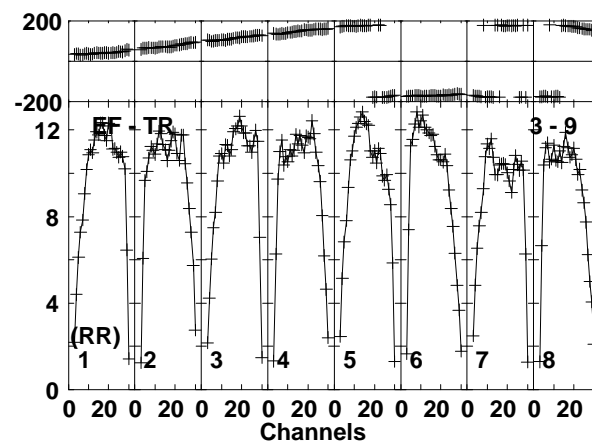
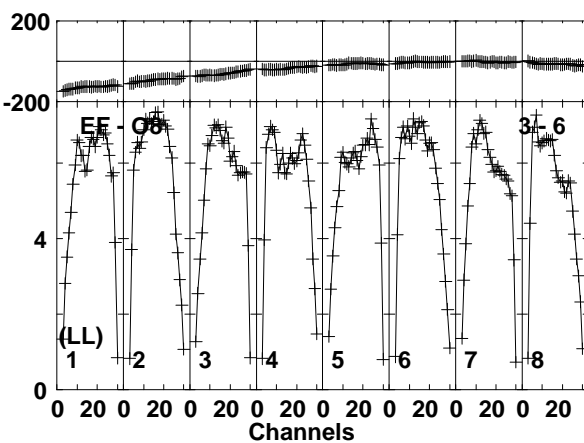
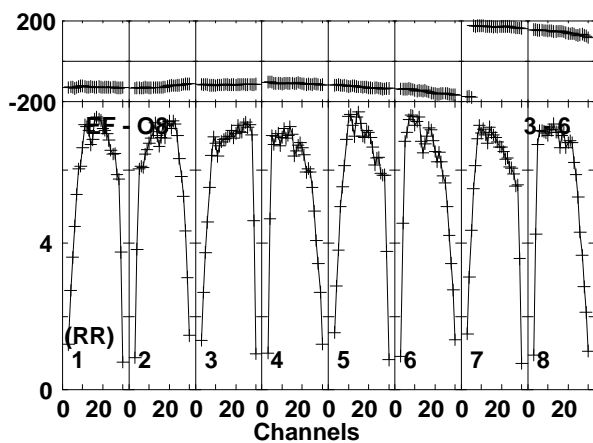
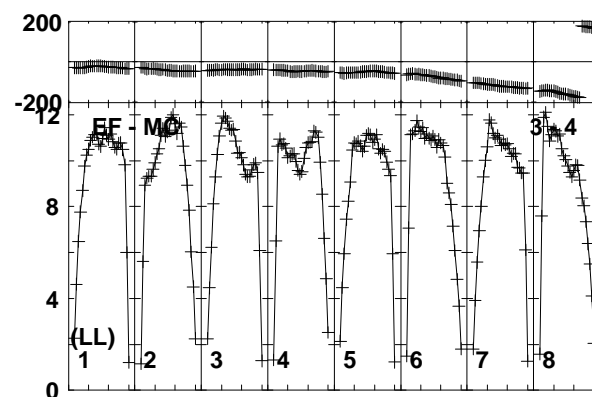
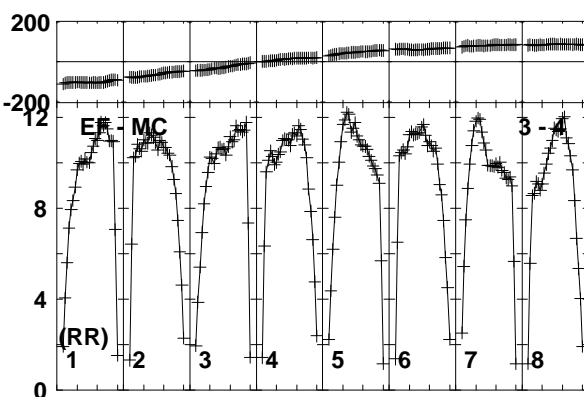
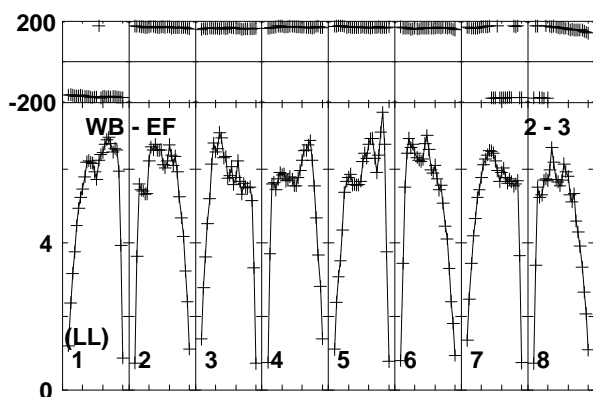
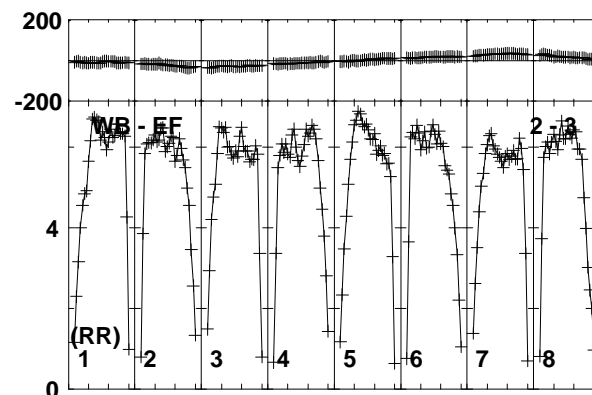
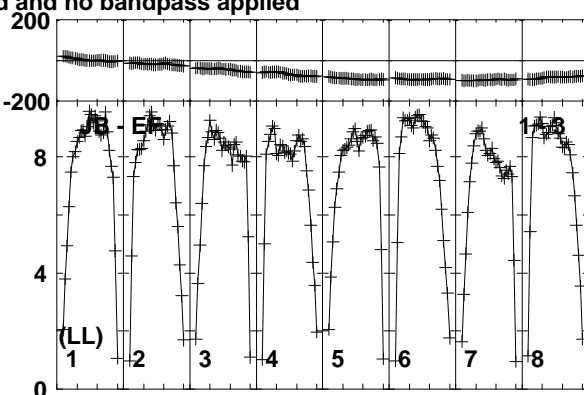
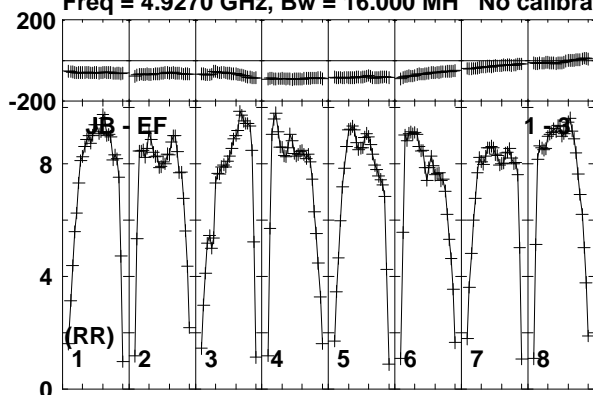

Lower frame: Milli Ampl Jy Top frame: Phas deg  
Vector averaged cross-power spectrum Baseline: JB (01) - EF (03)  
Timerange: 00/13:49:01 to 00/13:49:59



Plot file version 563 created 19-DEC-2018 17:58:52

J1619+2247 RY007C.UVDATA.1

Freq = 4.9270 GHz, Bw = 16.000 MH No calibration applied and no bandpass applied

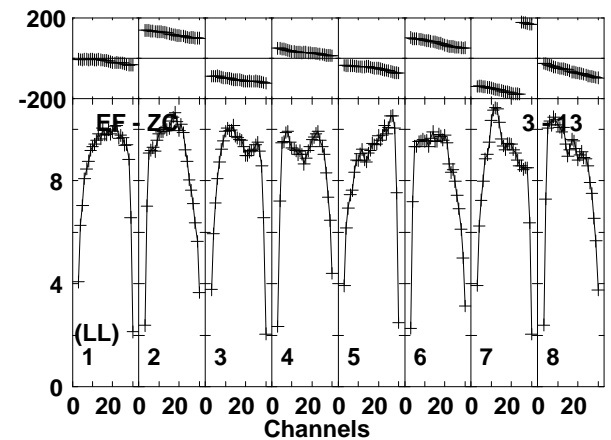
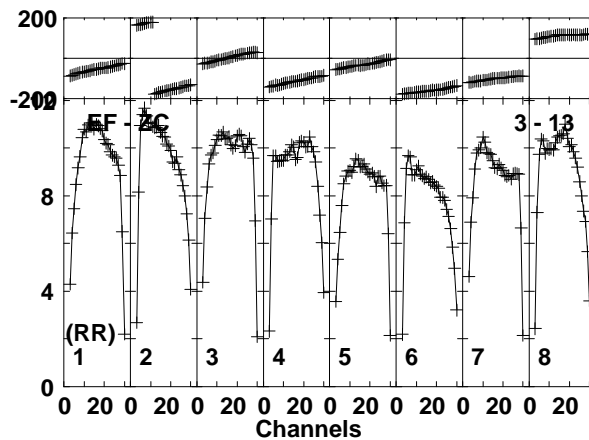
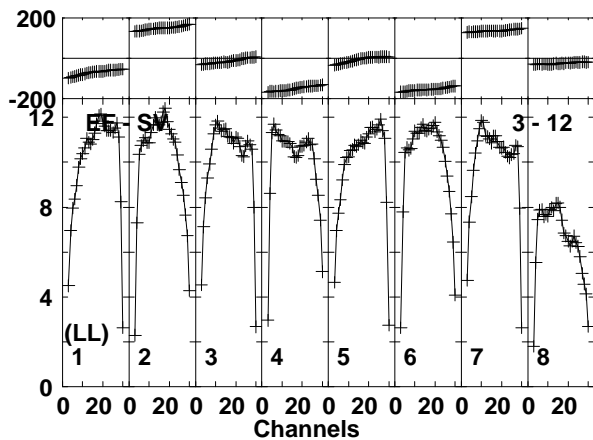
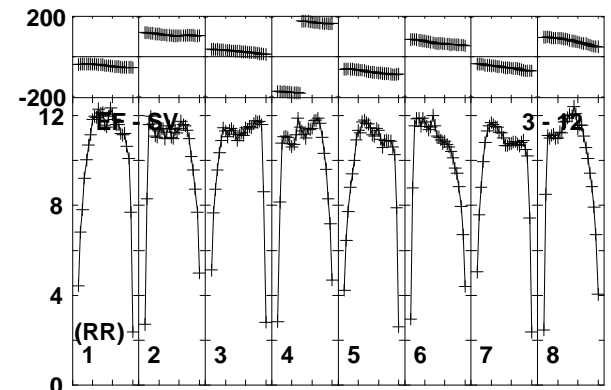
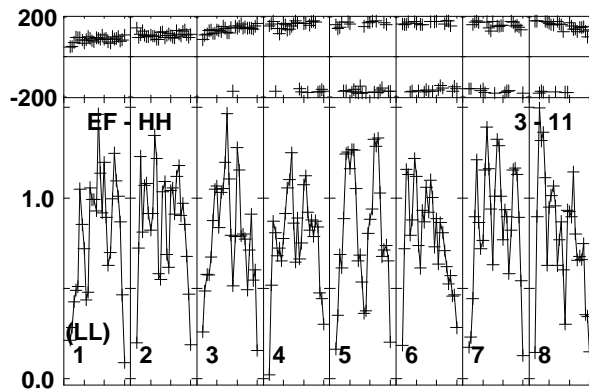
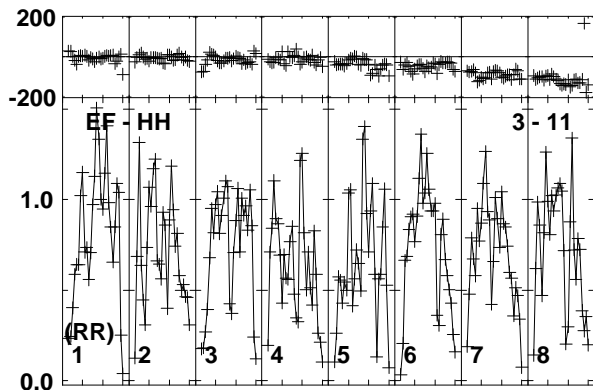
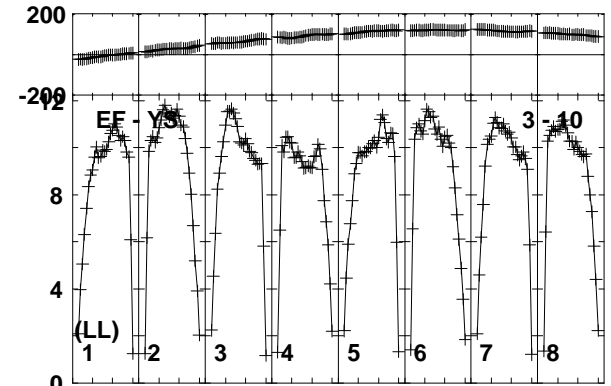
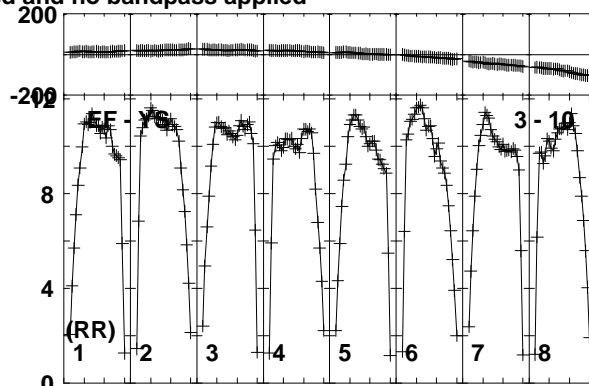
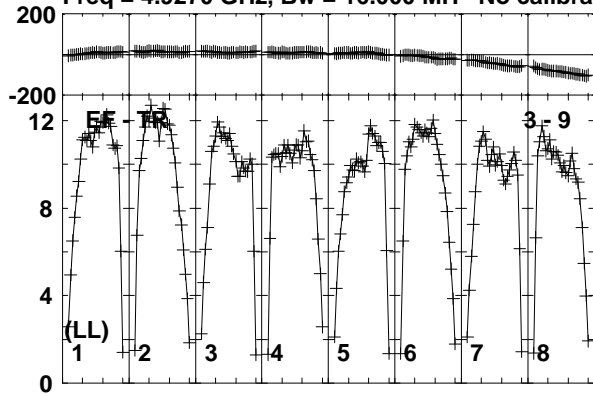

Lower frame: Milli Ampl Jy Top frame: Phas deg  
Vector averaged cross-power spectrum Baseline: EF (03) - TR (09)  
Timerange: 00/13:49:01 to 00/13:49:59

Plot file version 564 created 19-DEC-2018 17:58:52

J1619+2247 RY007C.UVDATA.1

Freq = 4.9270 GHz, Bw = 16.000 MH No calibration applied and no bandpass applied

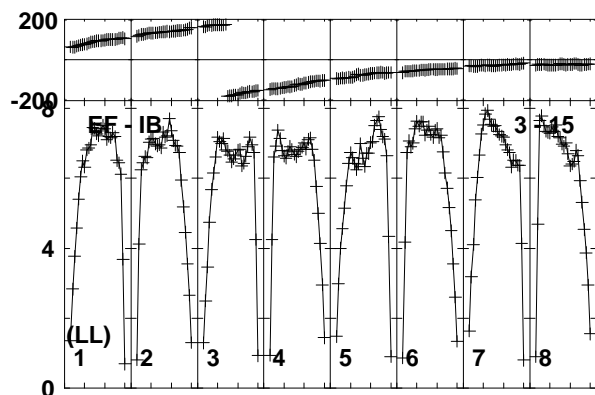
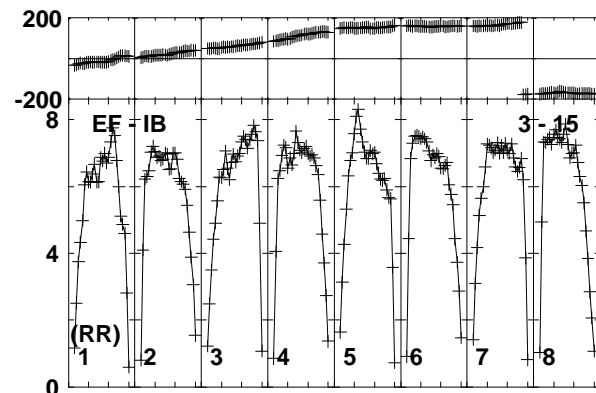
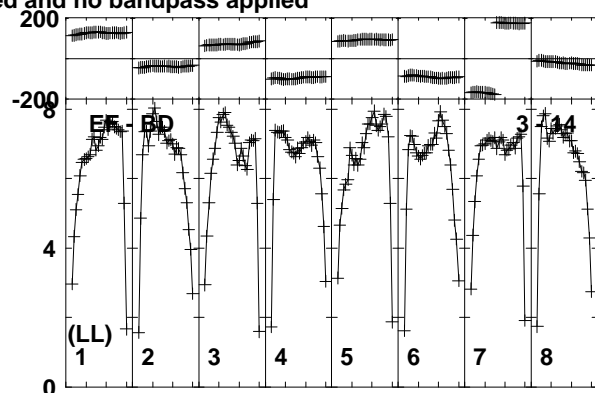
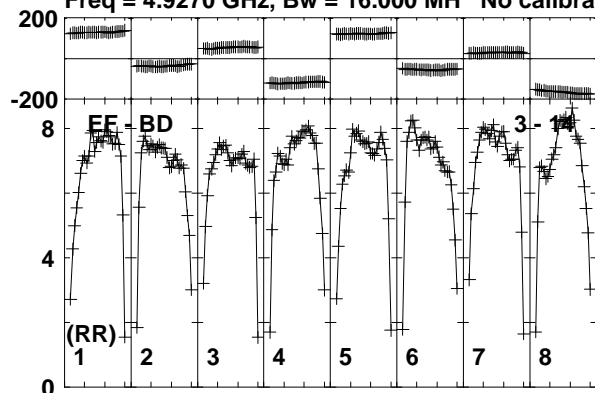

Lower frame: Milli Ampl Jy Top frame: Phas deg  
Vector averaged cross-power spectrum Baseline: EF (03) - BD (14)  
Timerange: 00/13:49:01 to 00/13:49:59

Plot file version 565 created 19-DEC-2018 17:58:52

AT2018\_RY007C.UVDATA.1

Freq = 4.9270 GHz, Bw = 16.000 MH No calibration applied and no bandpass applied

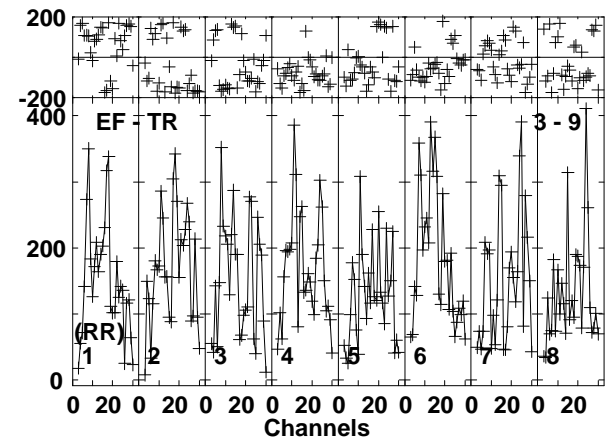
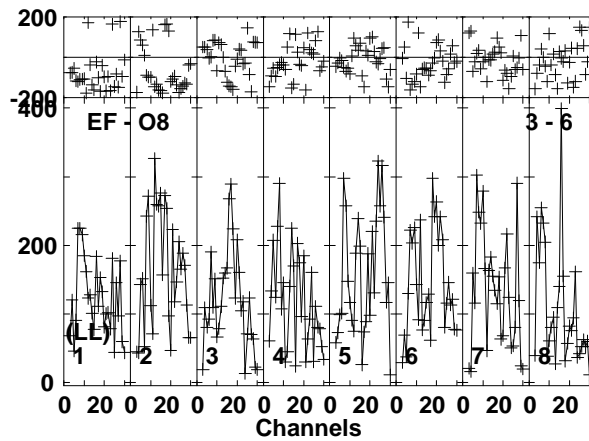
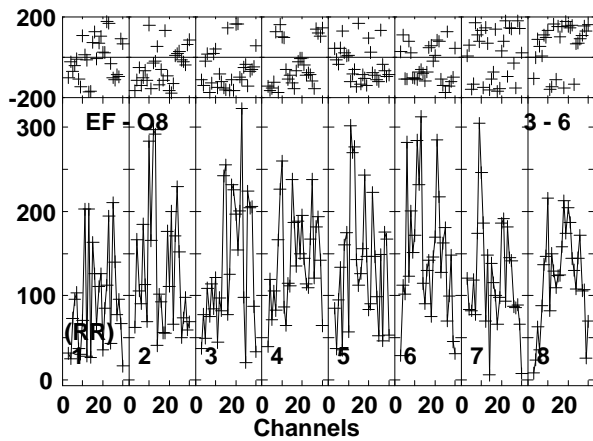
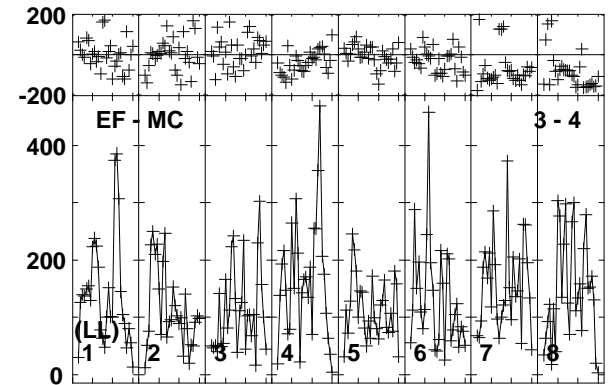
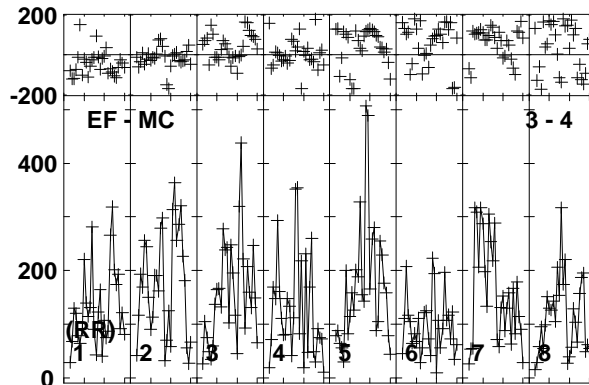
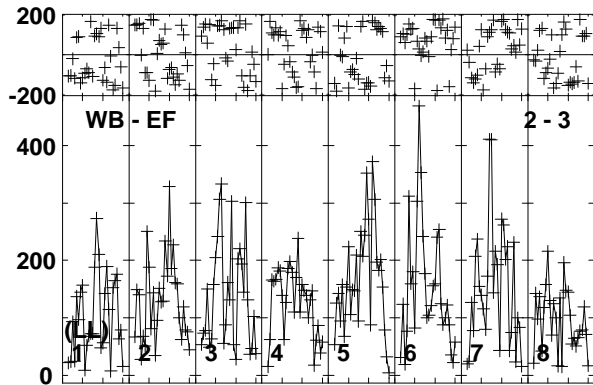
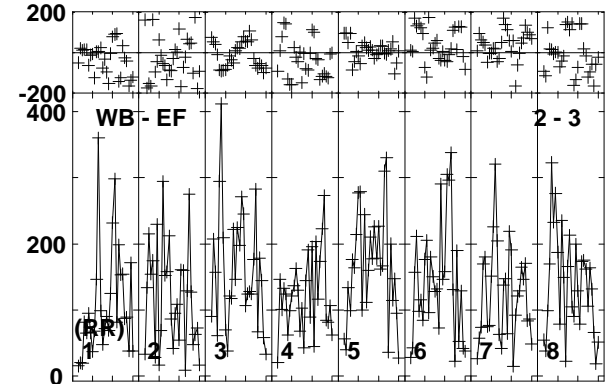
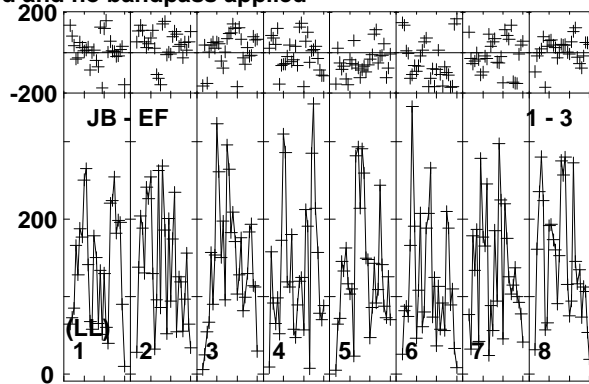
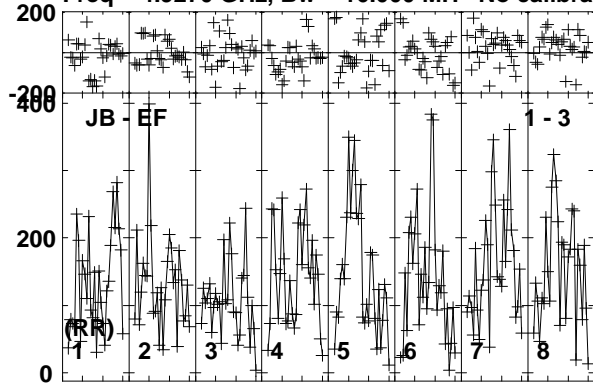

Lower frame: Micro Ampl Jy Top frame: Phas deg  
Vector averaged cross-power spectrum Baseline: JB (01) - EF (03)  
Timerange: 00/13:50:01 to 00/13:51:59

Plot file version 566 created 19-DEC-2018 17:58:53

AT2018\_RY007C.UVDATA.1

Freq = 4.9270 GHz, Bw = 16.000 MH No calibration applied and no bandpass applied

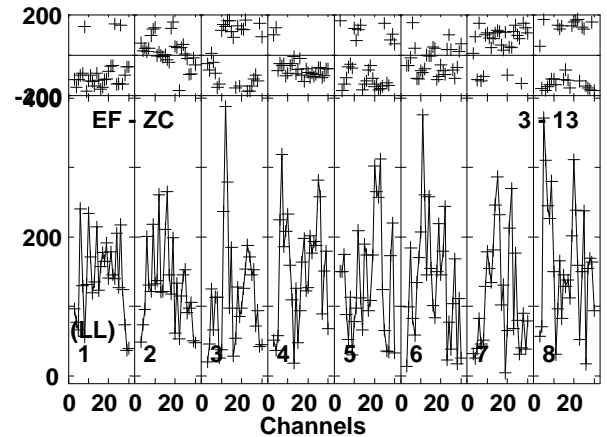
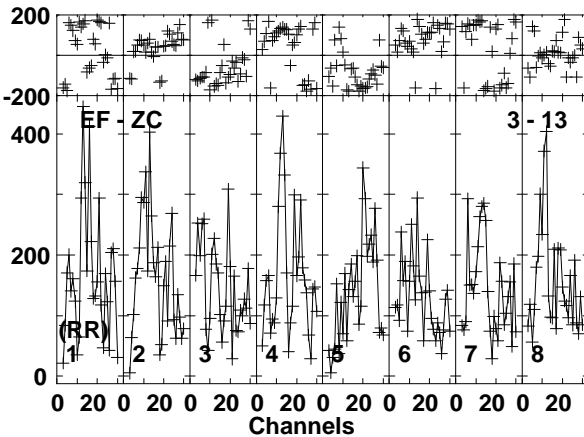
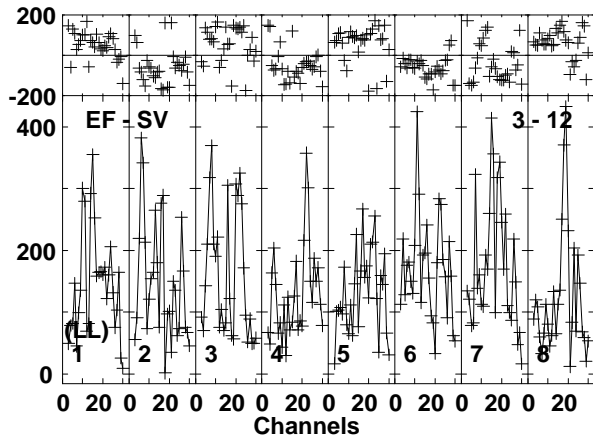
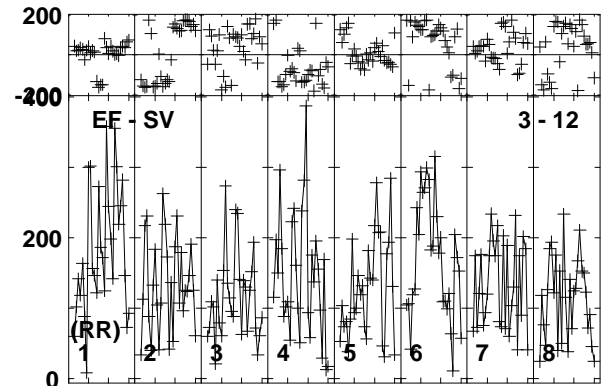
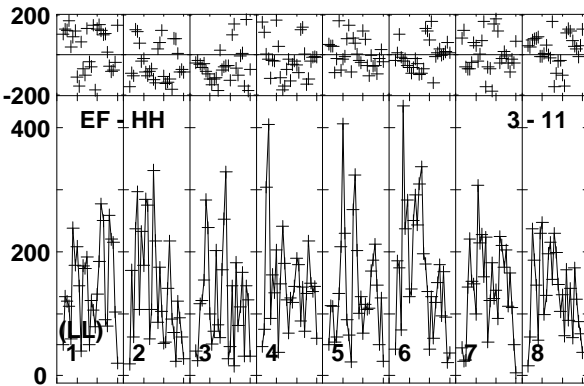
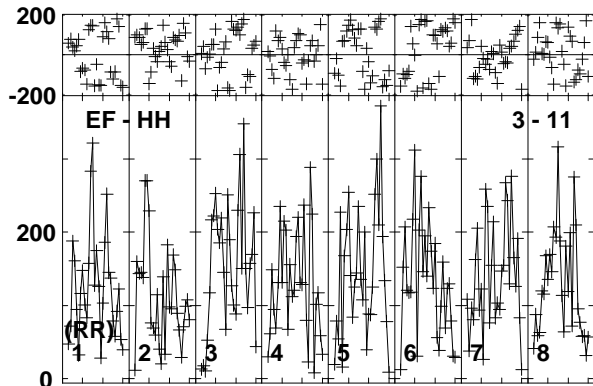
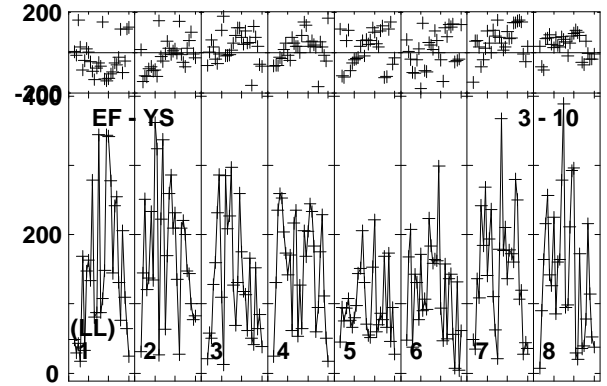
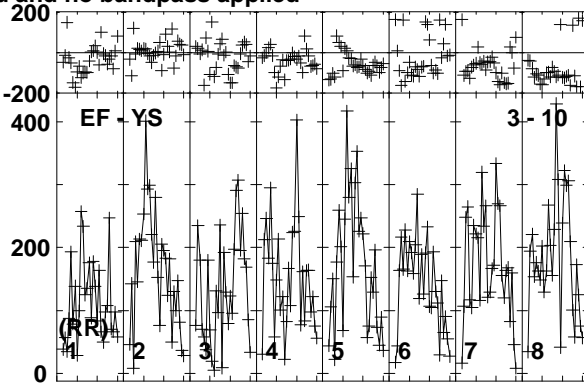
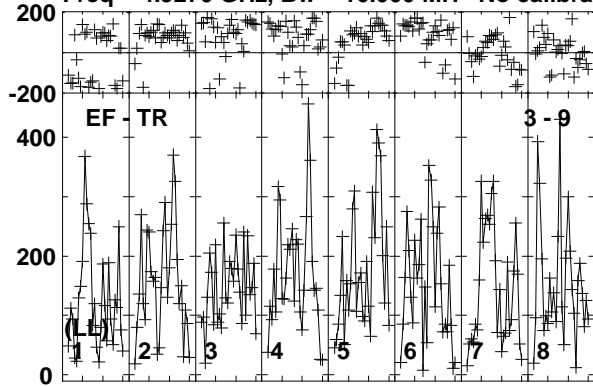

Lower frame: Micro Ampl Jy Top frame: Phas deg  
Vector averaged cross-power spectrum Baseline: EF (03) - TR (09)  
Timerange: 00/13:50:01 to 00/13:51:59

Plot file version 567 created 19-DEC-2018 17:58:53

AT2018\_RY007C.UVDATA.1

Freq = 4.9270 GHz, Bw = 16.000 MH No calibration applied and no bandpass applied

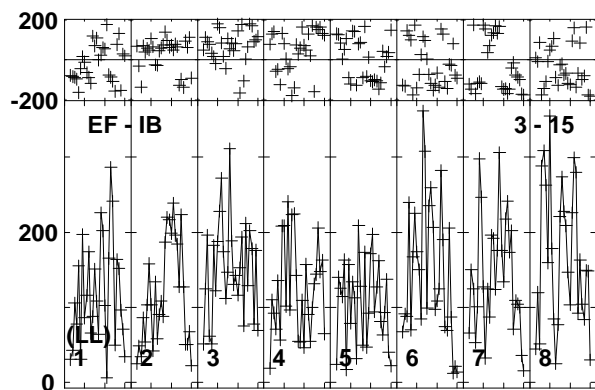
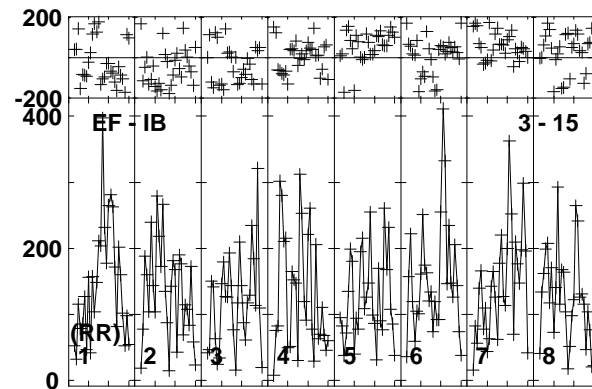
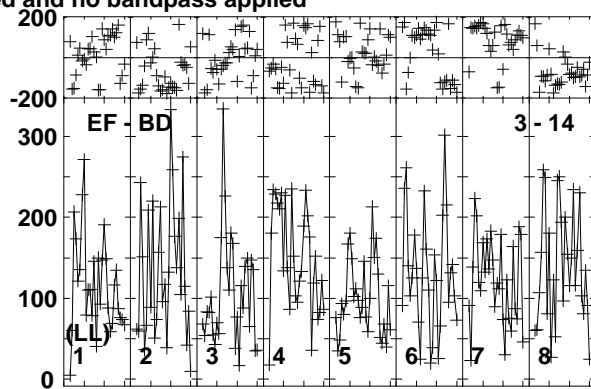
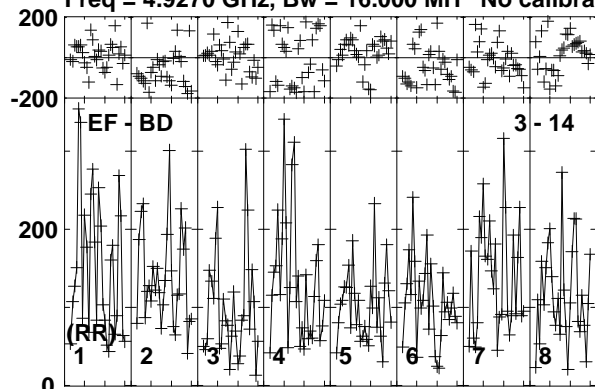

Lower frame: Micro Ampl Jy Top frame: Phas deg  
Vector averaged cross-power spectrum Baseline: EF (03) - BD (14)  
Timerange: 00/13:50:01 to 00/13:51:59

Plot file version 568 created 19-DEC-2018 17:58:53

VLA2 RY007C.UVDATA.1

Freq = 4.9270 GHz, Bw = 16.000 MH No calibration applied and no bandpass applied

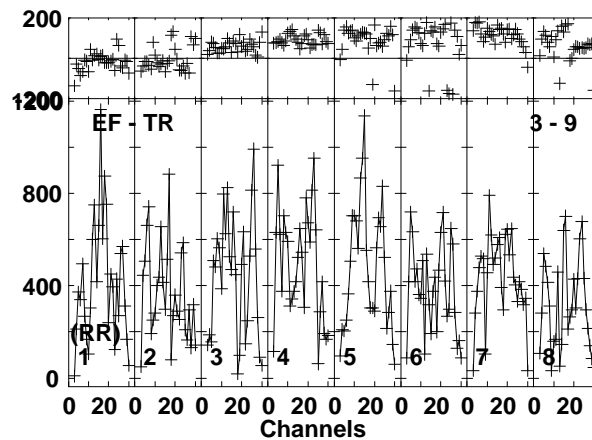
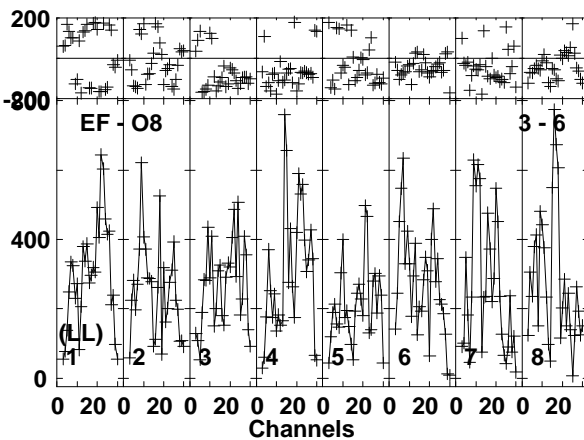
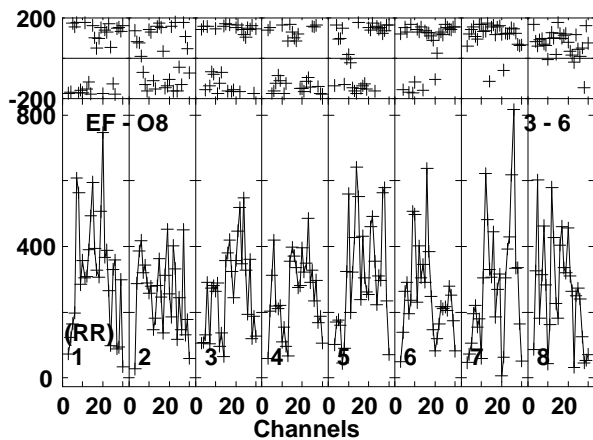
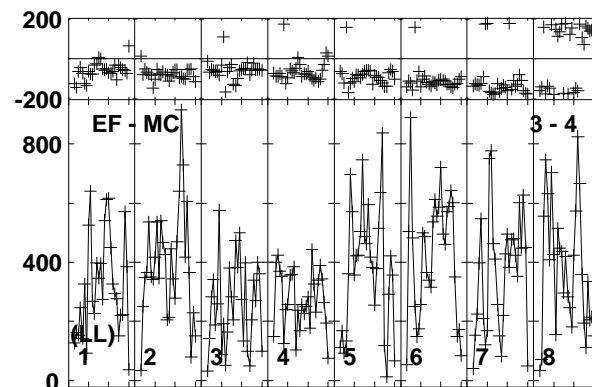
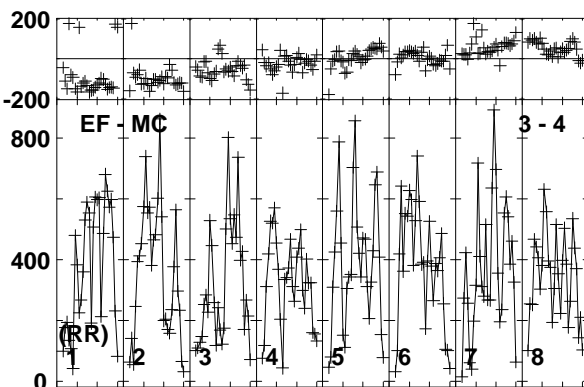
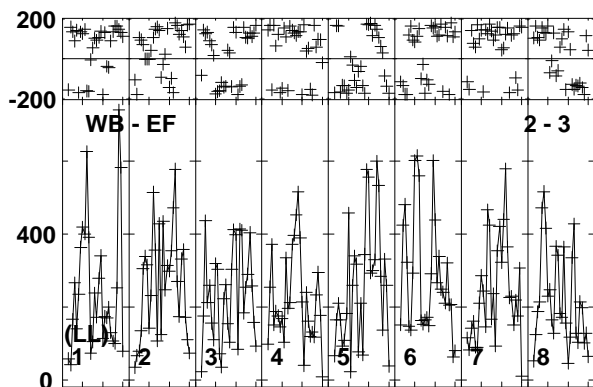
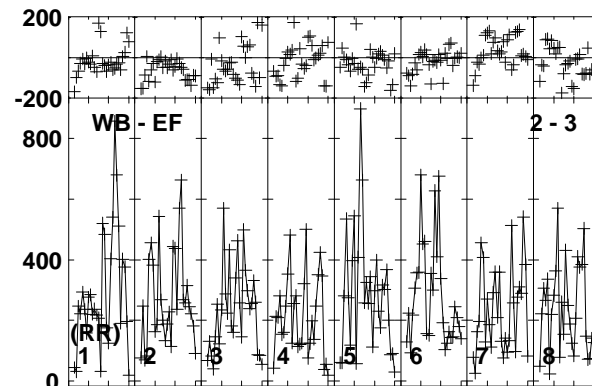
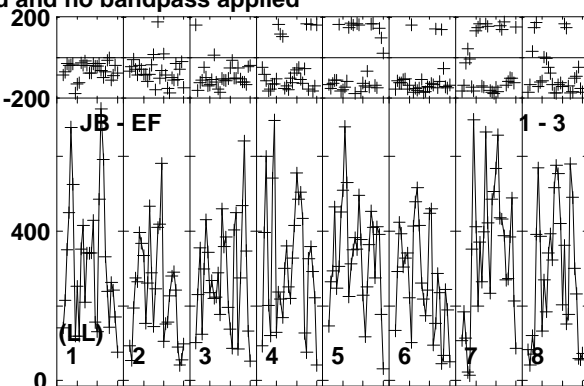
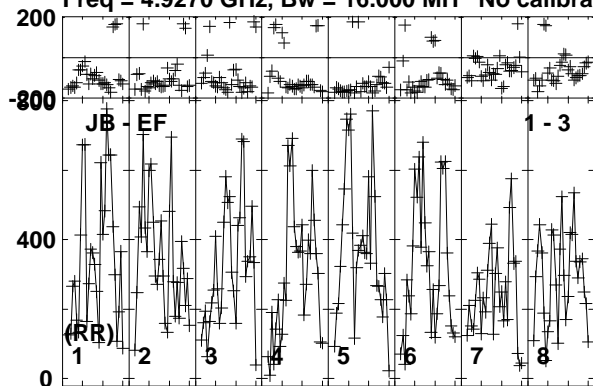

Lower frame: Micro Ampl Jy Top frame: Phas deg  
Vector averaged cross-power spectrum Baseline: JB (01) - EF (03)  
Timerange: 00/13:52:01 to 00/13:52:59

Plot file version 569 created 19-DEC-2018 17:58:53

VLA2 RY007C.UVDATA.1

Freq = 4.9270 GHz, Bw = 16.000 MH No calibration applied and no bandpass applied

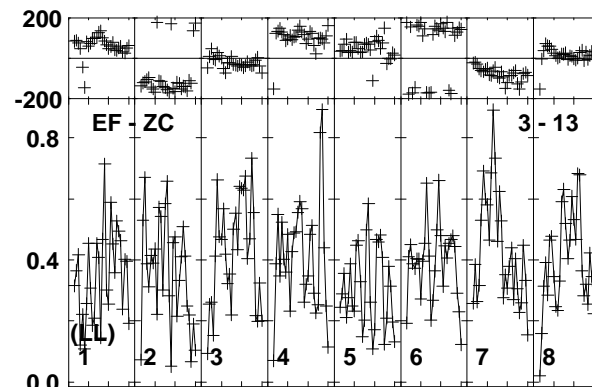
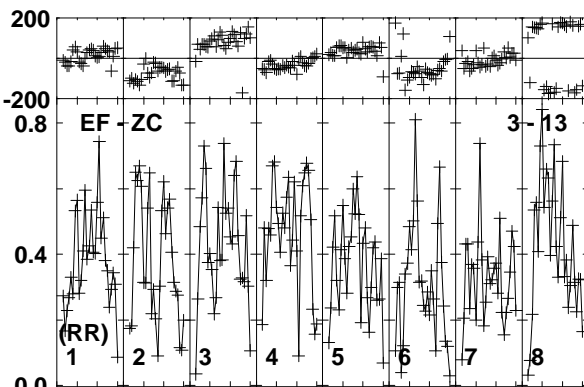
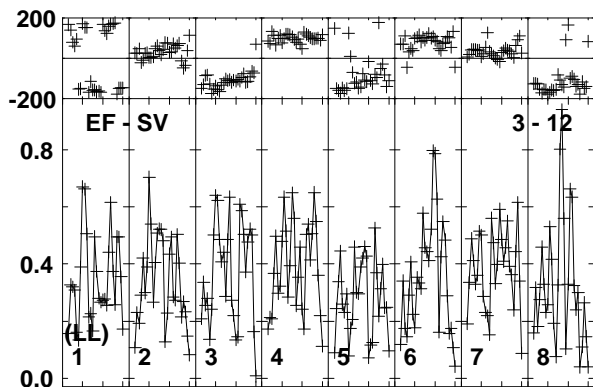
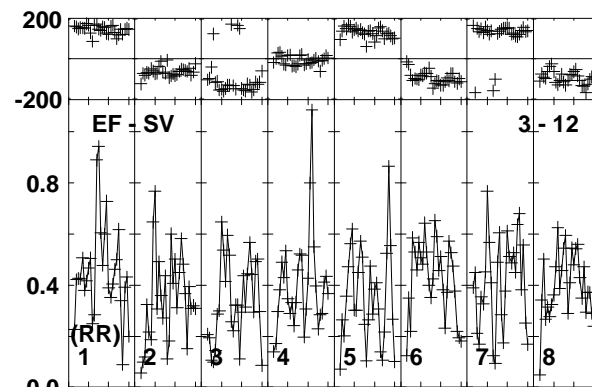
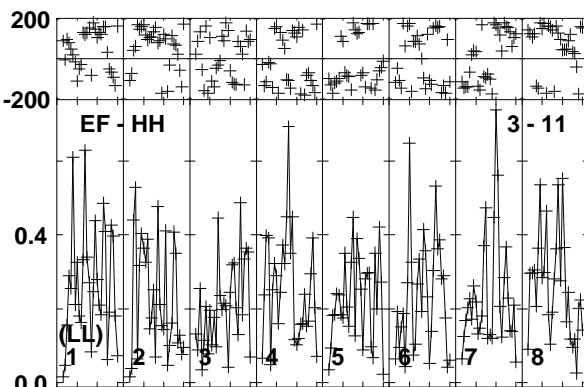
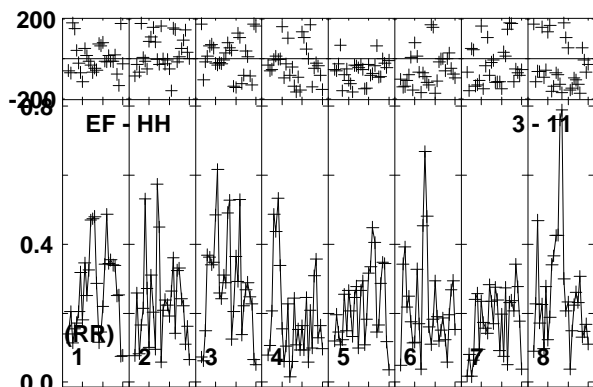
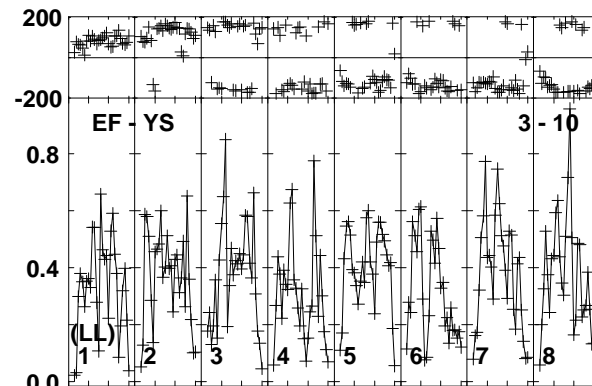
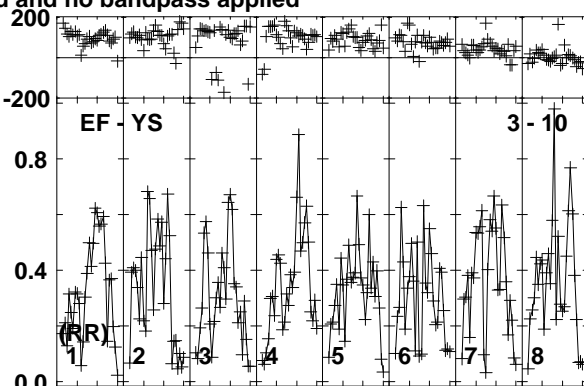
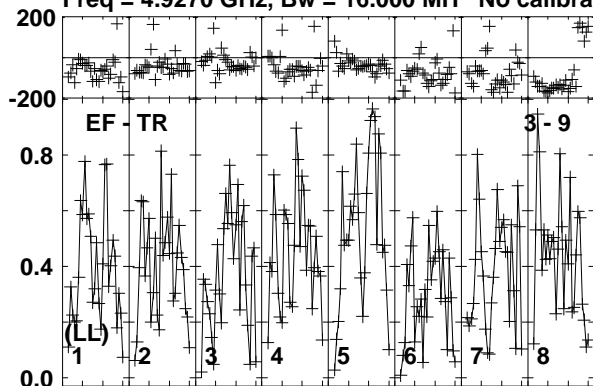

Lower frame: Milli Ampl Jy Top frame: Phas deg  
Vector averaged cross-power spectrum Baseline: EF (03) - TR (09)  
Timerange: 00/13:52:01 to 00/13:52:59

Plot file version 570 created 19-DEC-2018 17:58:53

VLA2 RY007C.UVDATA.1

Freq = 4.9270 GHz, Bw = 16.000 MH No calibration applied and no bandpass applied

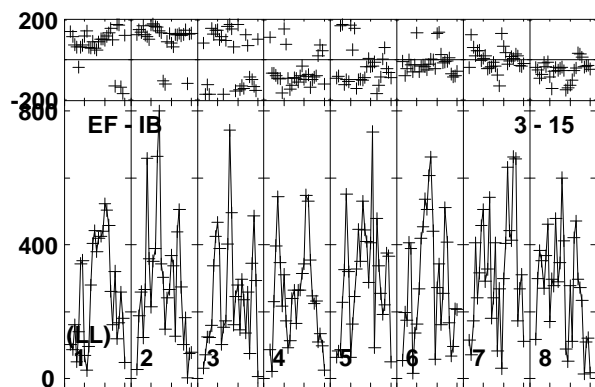
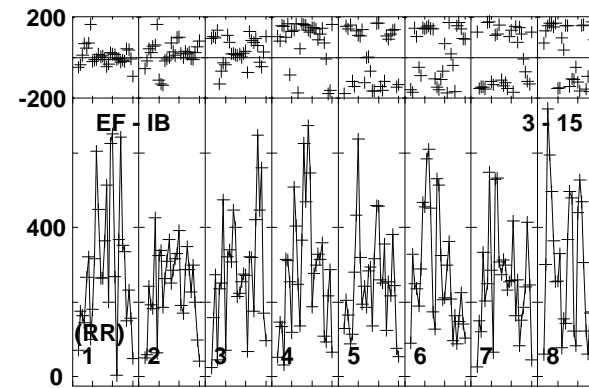
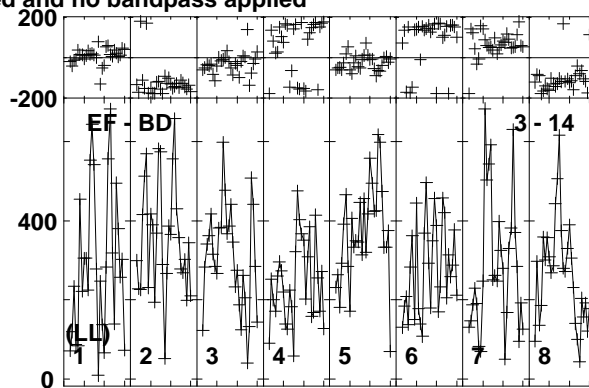
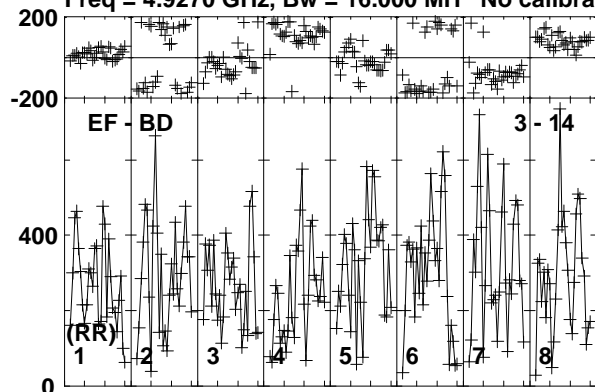

Lower frame: Micro Ampl Jy Top frame: Phas deg  
Vector averaged cross-power spectrum Baseline: EF (03) - BD (14)  
Timerange: 00/13:52:01 to 00/13:52:59



Plot file version 571 created 19-DEC-2018 17:58:53

J1619+2247 RY007C.UVDATA.1

Freq = 4.9270 GHz, Bw = 16.000 MH No calibration applied and no bandpass applied

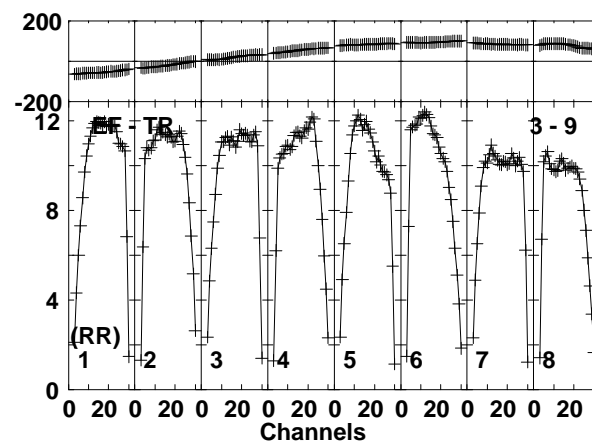
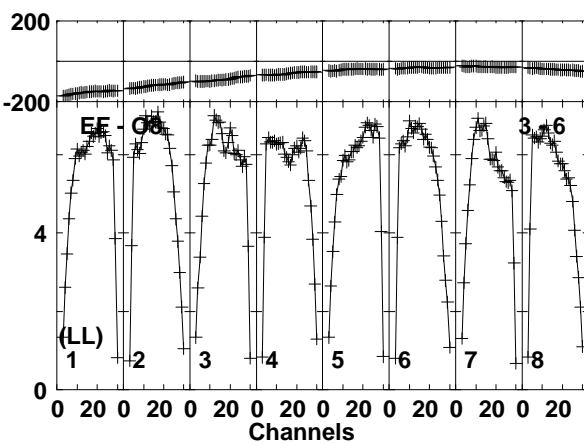
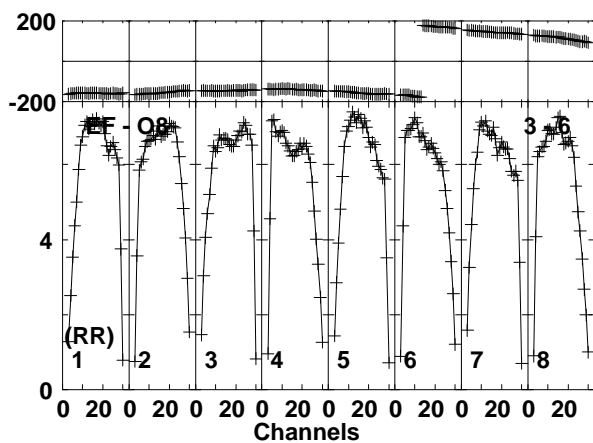
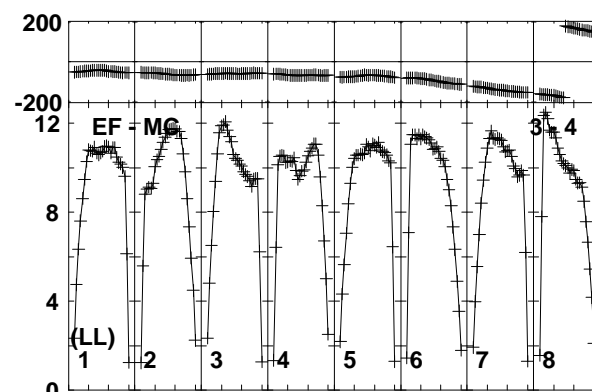
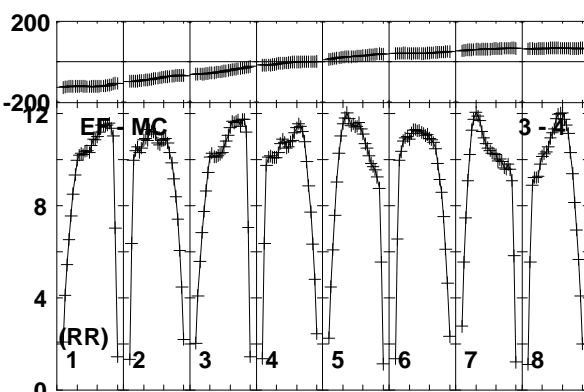
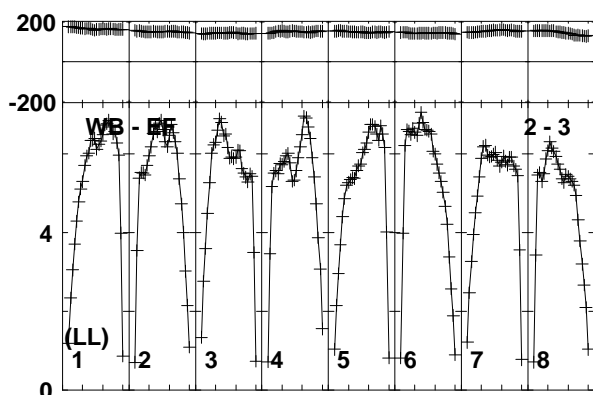
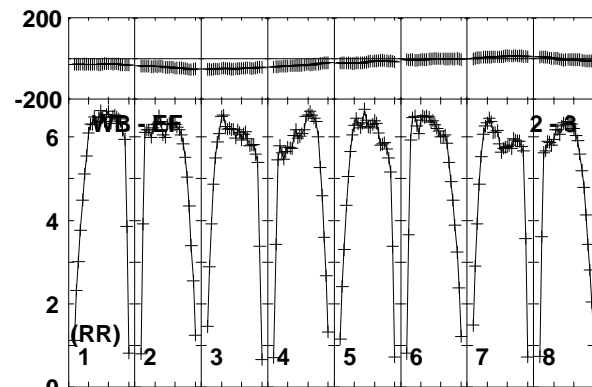
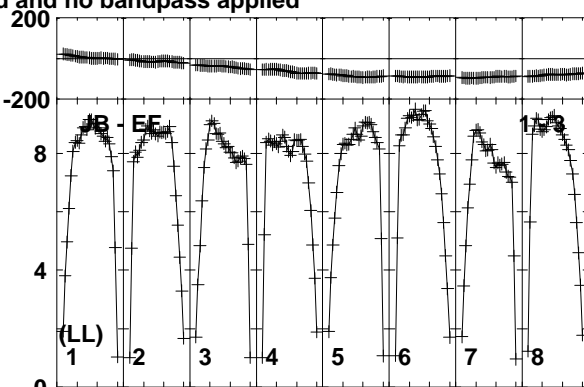
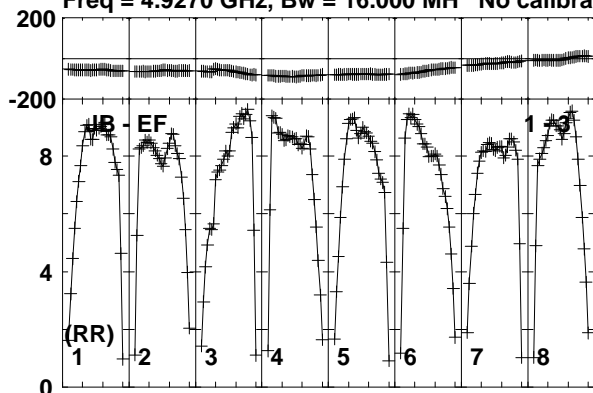

Lower frame: Milli Ampl Jy Top frame: Phas deg  
Vector averaged cross-power spectrum Baseline: JB (01) - EF (03)  
Timerange: 00/13:53:31 to 00/13:54:29

Plot file version 572 created 19-DEC-2018 17:58:55

J1619+2247 RY007C.UVDATA.1

Freq = 4.9270 GHz, Bw = 16.000 MH No calibration applied and no bandpass applied

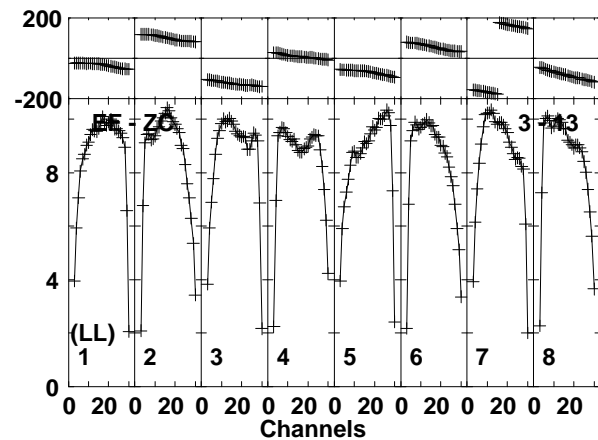
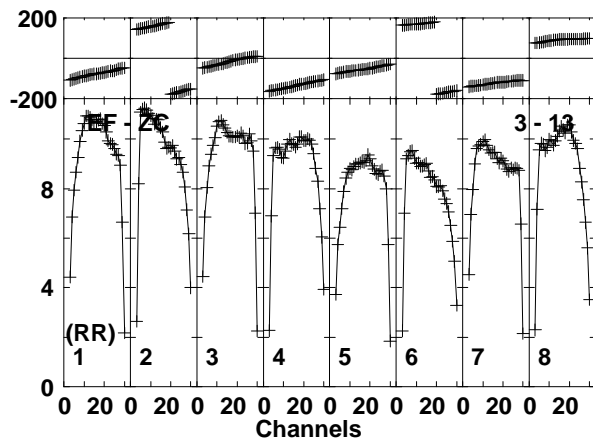
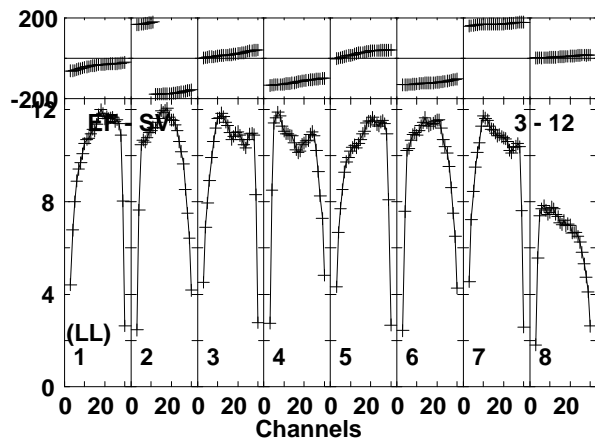
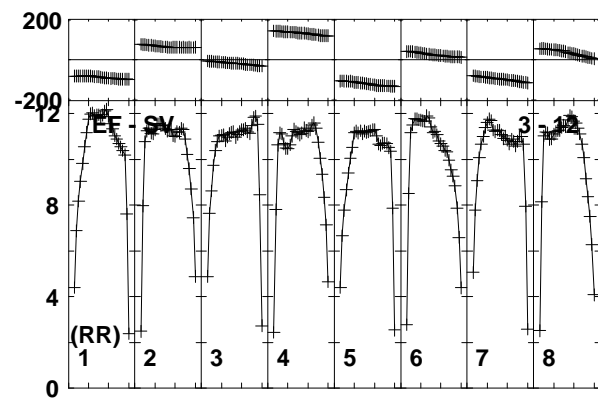
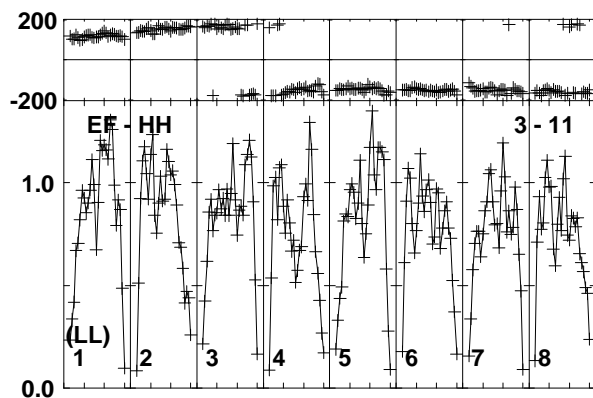
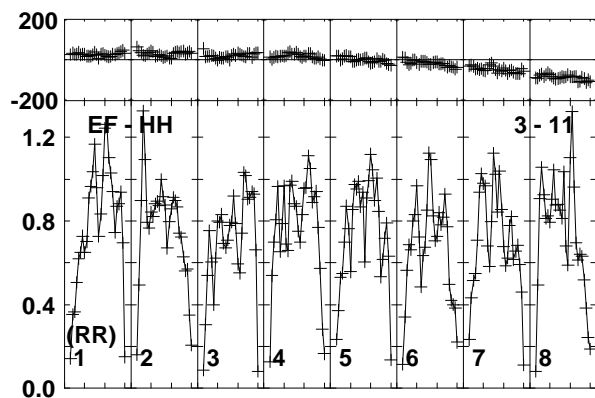
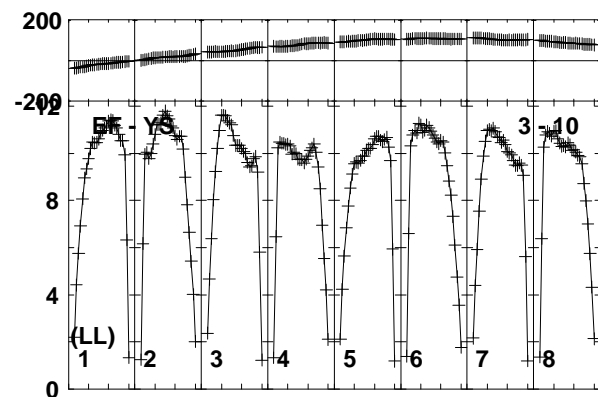
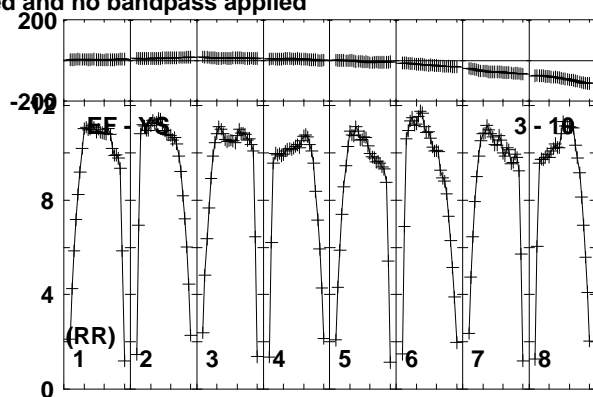
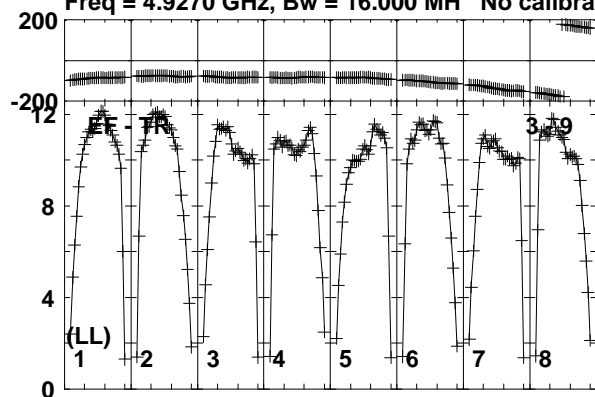

Lower frame: Milli Ampl Jy Top frame: Phas deg  
Vector averaged cross-power spectrum Baseline: EF (03) - TR (09)  
Timerange: 00/13:53:31 to 00/13:54:29

Plot file version 573 created 19-DEC-2018 17:58:55

J1619+2247 RY007C.UVDATA.1

Freq = 4.9270 GHz, Bw = 16.000 MH No calibration applied and no bandpass applied

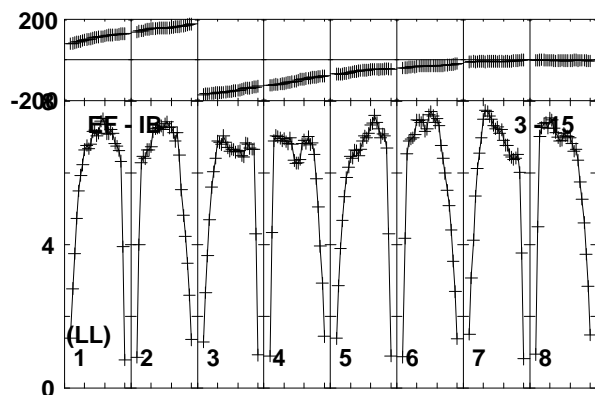
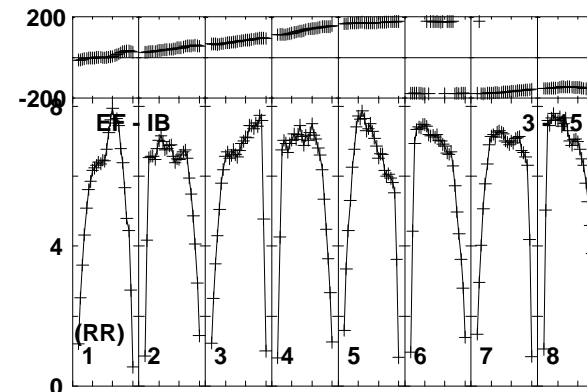
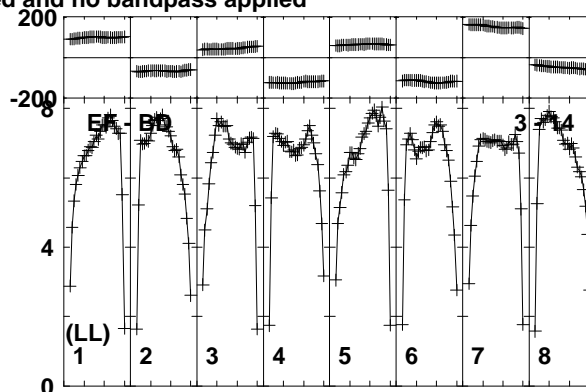
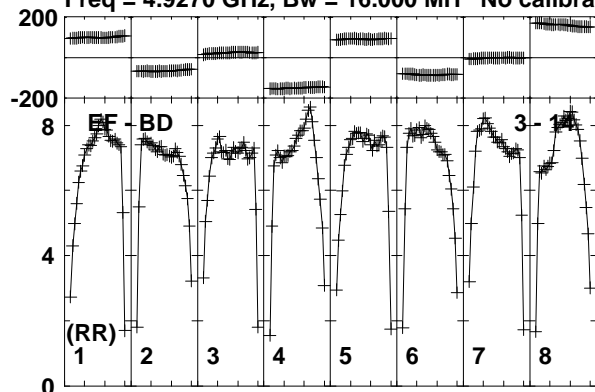

Lower frame: Milli Ampl Jy Top frame: Phas deg  
Vector averaged cross-power spectrum Baseline: EF (03) - BD (14)  
Timerange: 00/13:53:31 to 00/13:54:29

Plot file version 574 created 19-DEC-2018 17:58:55

AT2018\_RY007C.UVDATA.1

Freq = 4.9270 GHz, Bw = 16.000 MH No calibration applied and no bandpass applied

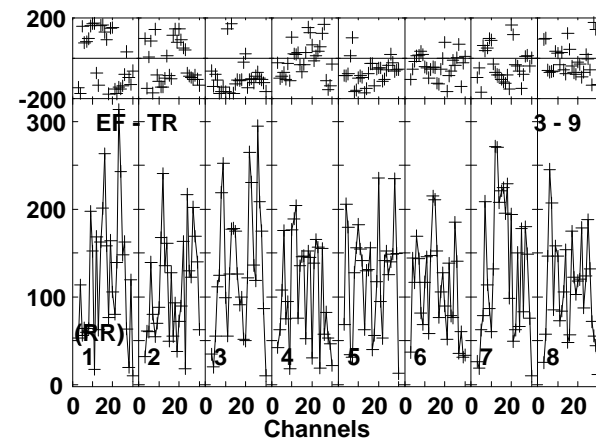
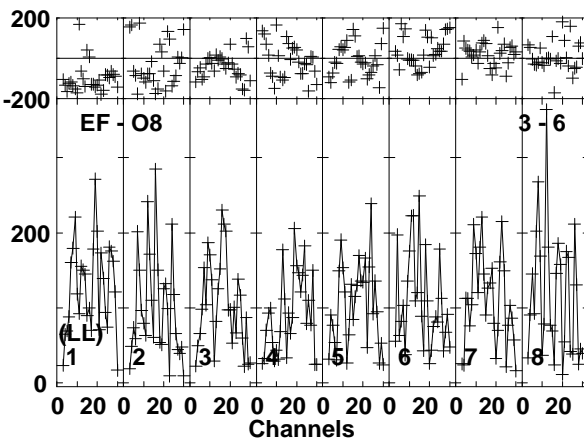
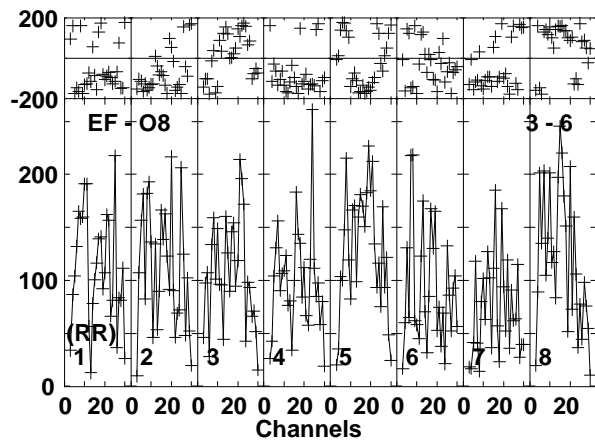
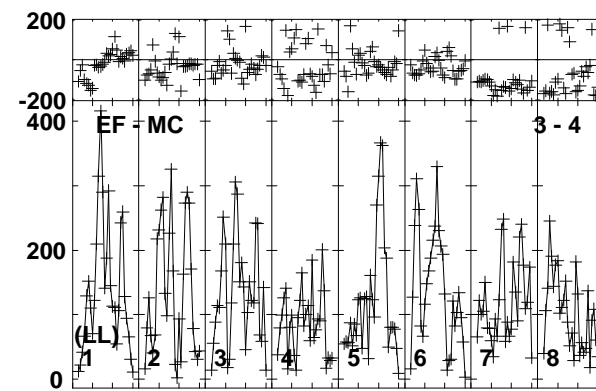
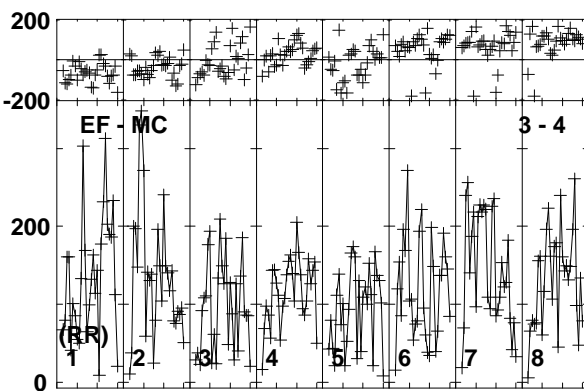
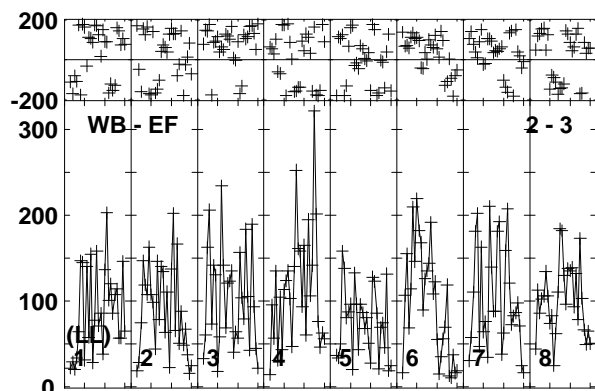
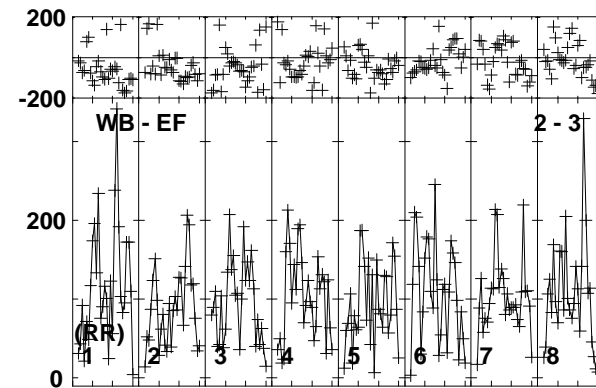
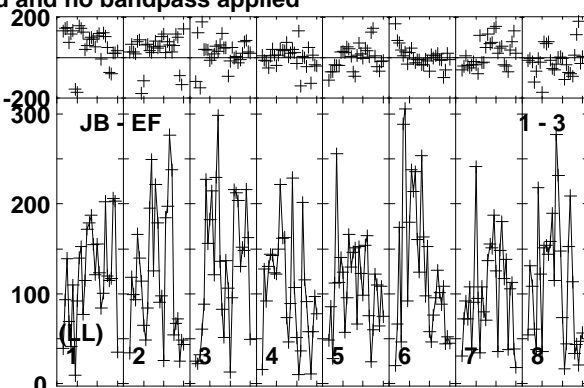
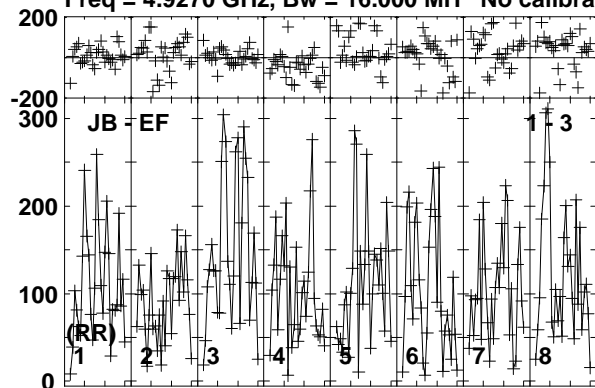

Lower frame: Micro Ampl Jy Top frame: Phas deg  
Vector averaged cross-power spectrum Baseline: JB (01) - EF (03)  
Timerange: 00/13:54:31 to 00/13:57:29

Plot file version 575 created 19-DEC-2018 17:58:55

AT2018\_RY007C.UVDATA.1

Freq = 4.9270 GHz, Bw = 16.000 MH No calibration applied and no bandpass applied

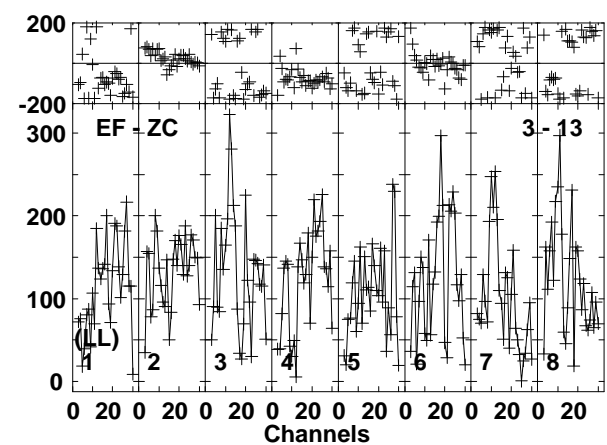
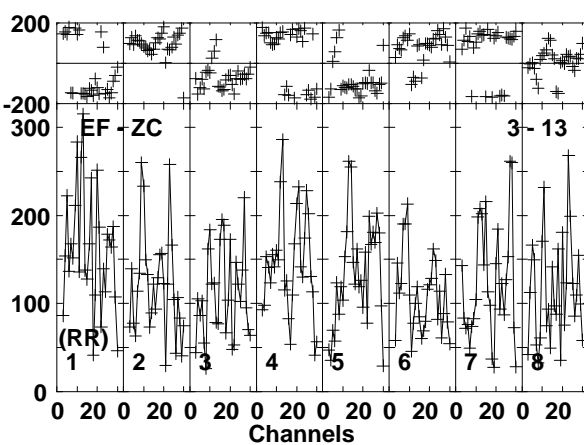
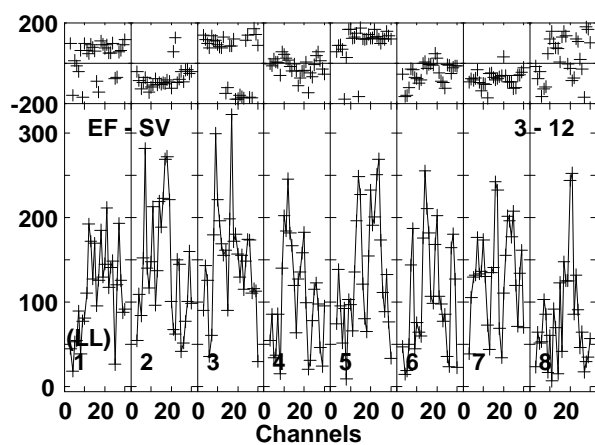
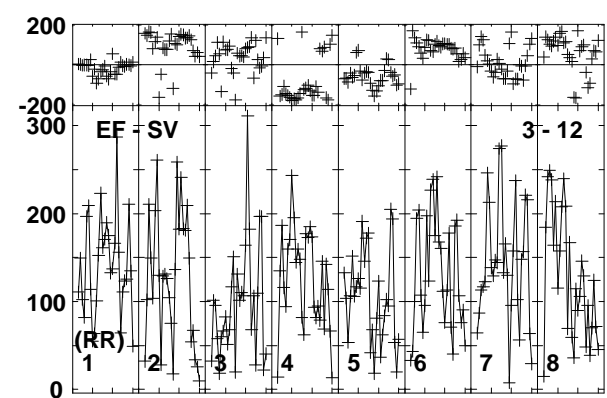
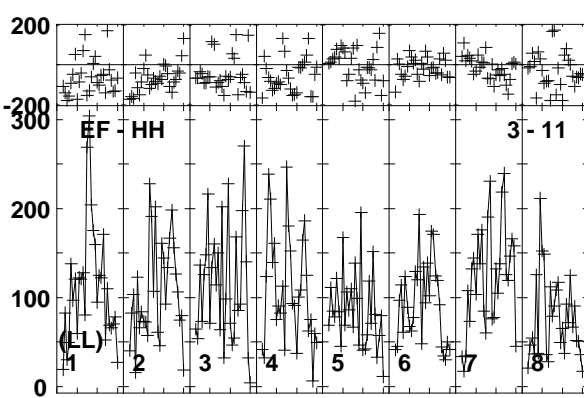
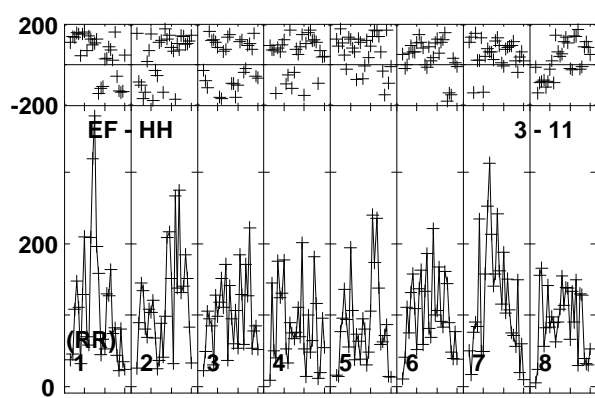
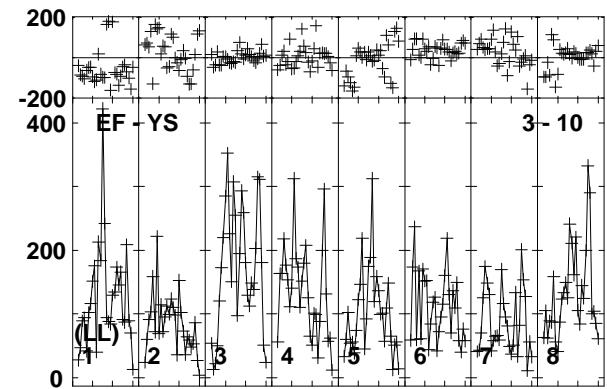
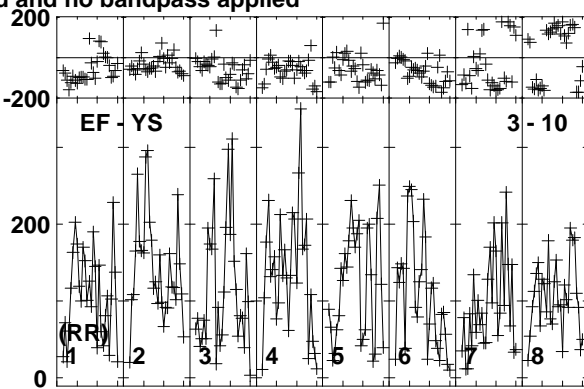
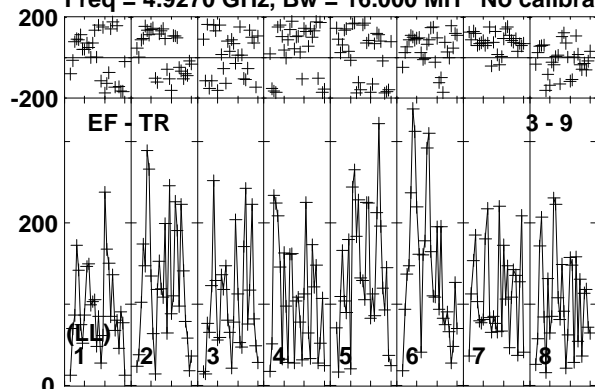

Lower frame: Micro Ampl Jy Top frame: Phas deg  
Vector averaged cross-power spectrum Baseline: EF (03) - TR (09)  
Timerange: 00/13:54:31 to 00/13:57:29

Plot file version 576 created 19-DEC-2018 17:58:55

AT2018\_RY007C.UVDATA.1

Freq = 4.9270 GHz, Bw = 16.000 MH No calibration applied and no bandpass applied

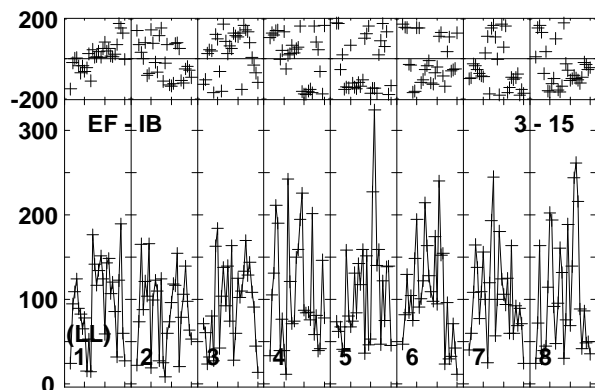
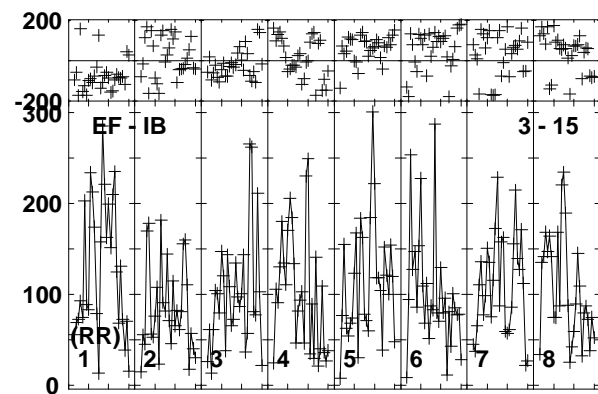
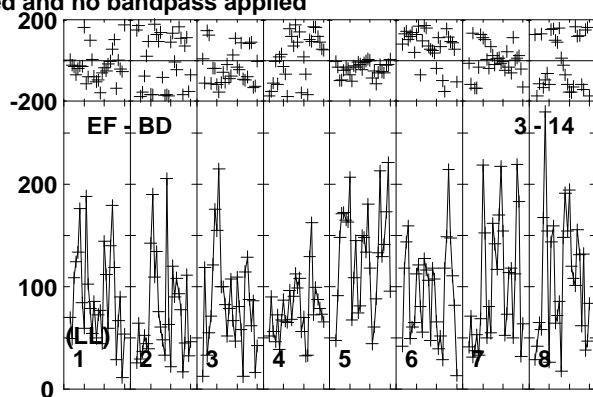
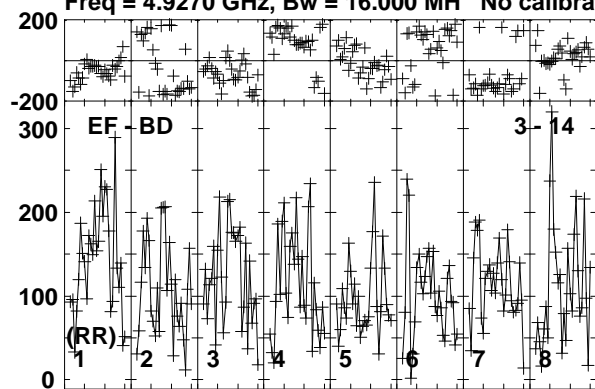

Lower frame: Micro Ampl Jy Top frame: Phas deg  
Vector averaged cross-power spectrum Baseline: EF (03) - BD (14)  
Timerange: 00/13:54:31 to 00/13:57:29

Plot file version 577 created 19-DEC-2018 17:58:55

J1619+2247 RY007C.UVDATA.1

Freq = 4.9270 GHz, Bw = 16.000 MH No calibration applied and no bandpass applied

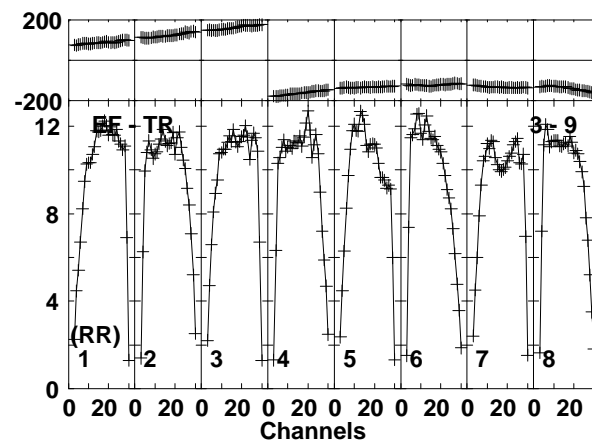
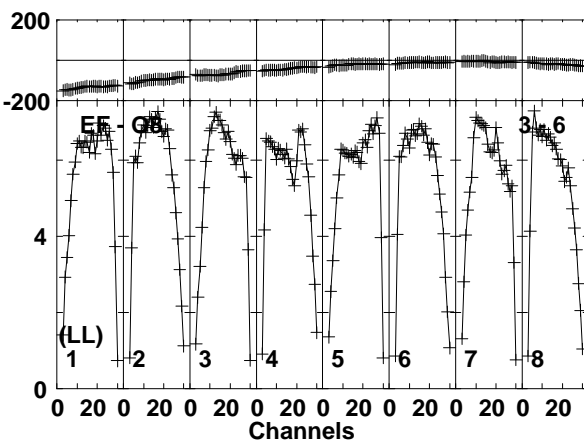
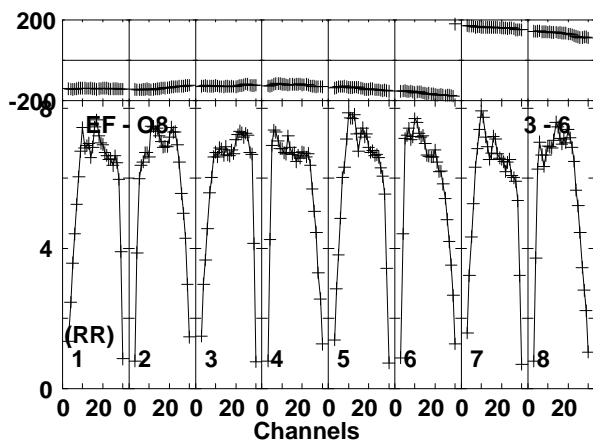
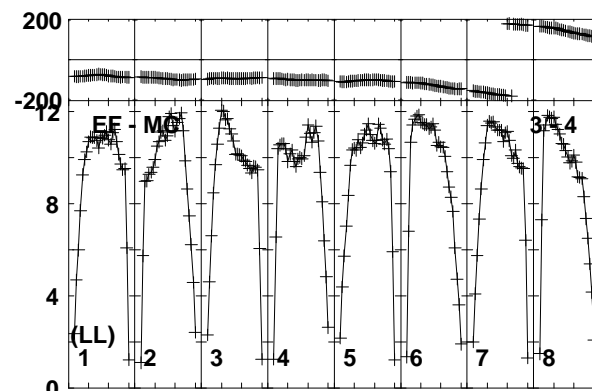
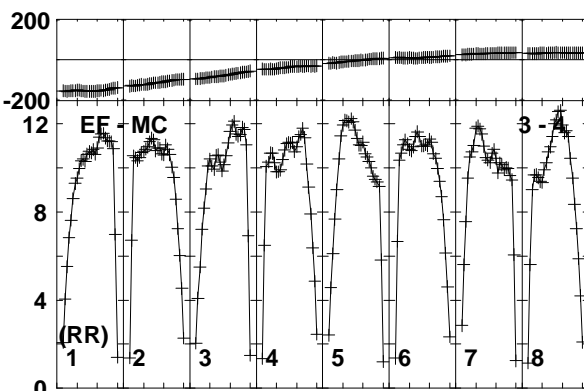
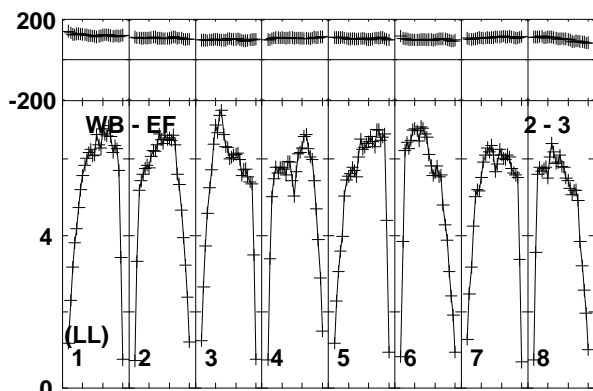
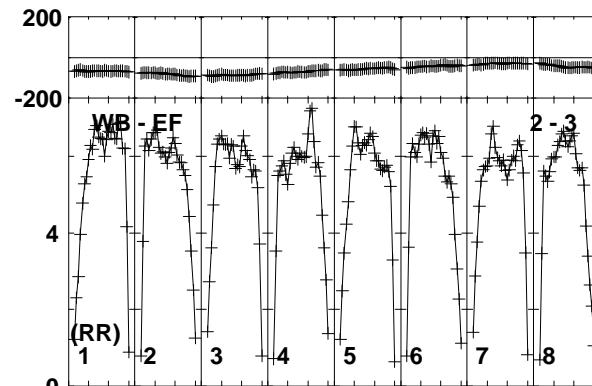
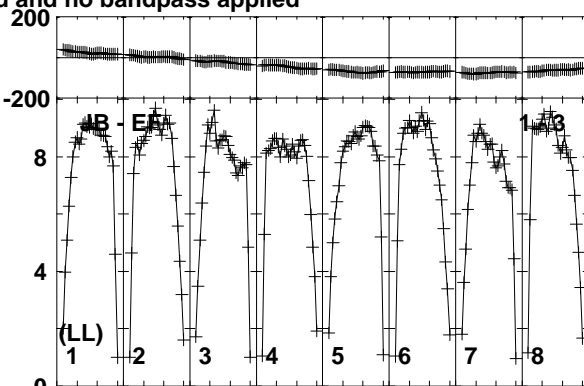
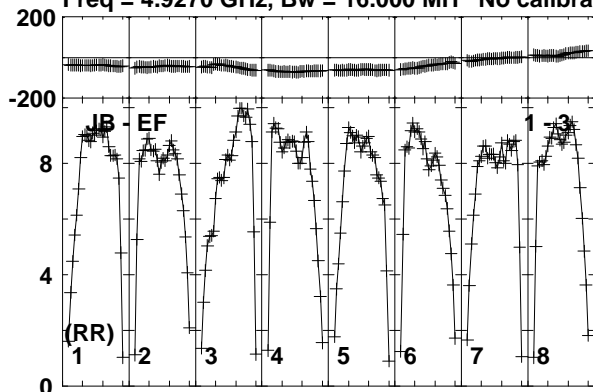

Lower frame: Milli Ampl Jy Top frame: Phas deg  
Vector averaged cross-power spectrum Baseline: JB (01) - EF (03)  
Timerange: 00/13:57:31 to 00/13:58:29

Plot file version 578 created 19-DEC-2018 17:58:55

J1619+2247 RY007C.UVDATA.1

Freq = 4.9270 GHz, Bw = 16.000 MH No calibration applied and no bandpass applied

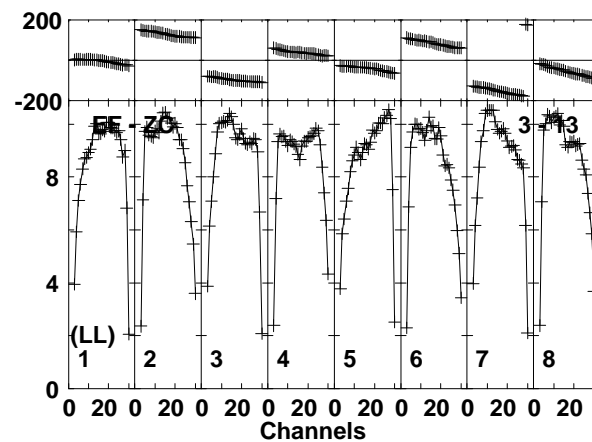
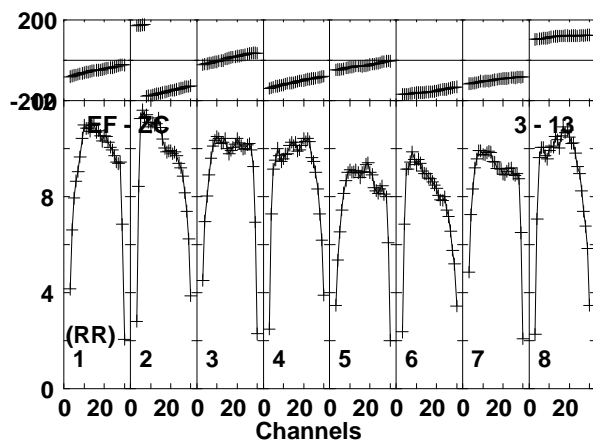
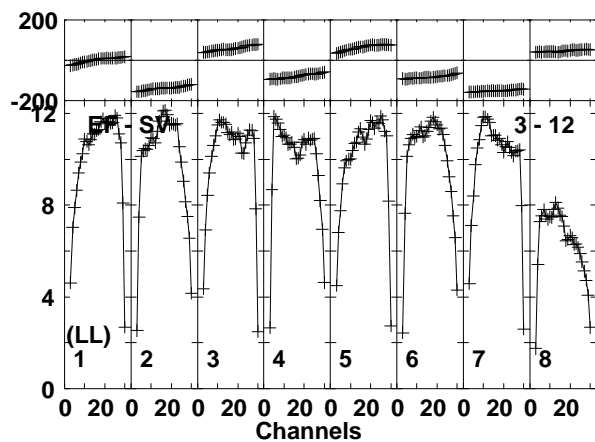
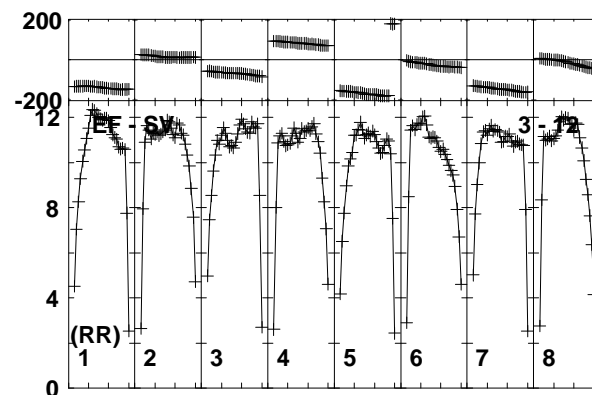
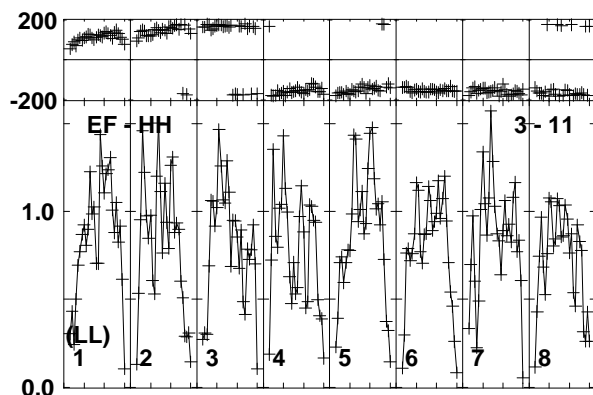
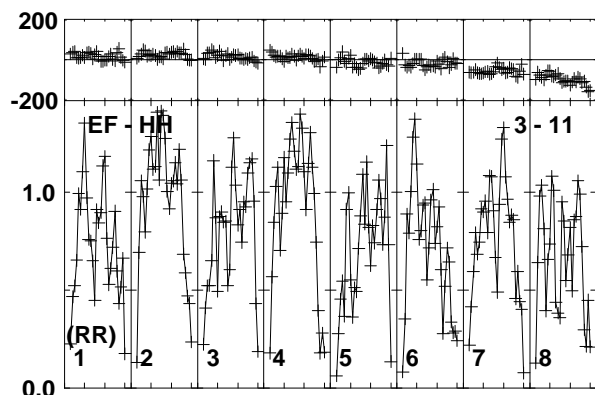
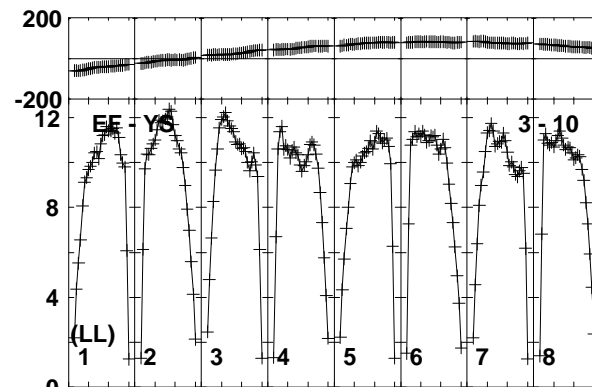
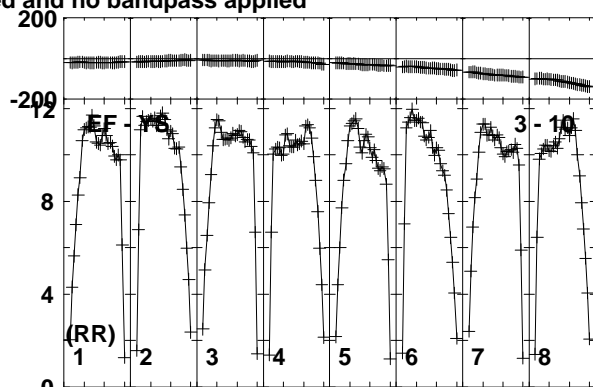
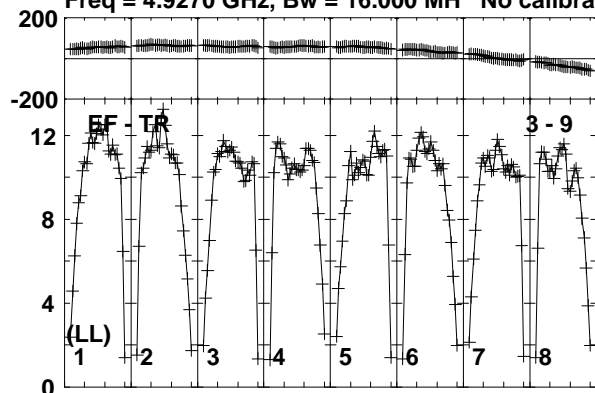

Lower frame: Milli Ampl Jy Top frame: Phas deg  
Vector averaged cross-power spectrum Baseline: EF (03) - TR (09)  
Timerange: 00/13:57:31 to 00/13:58:29



Plot file version 579 created 19-DEC-2018 17:58:55

J1619+2247 RY007C.UVDATA.1

Freq = 4.9270 GHz, Bw = 16.000 MH No calibration applied and no bandpass applied

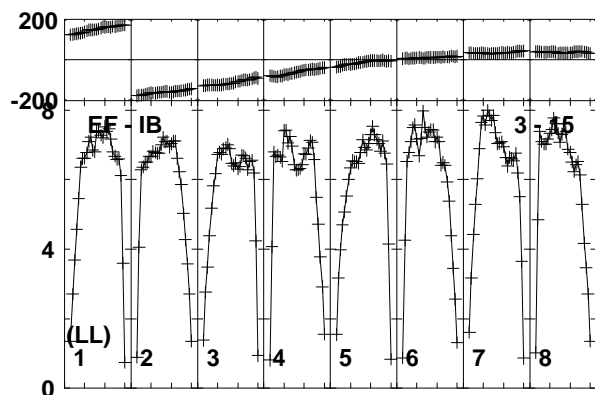
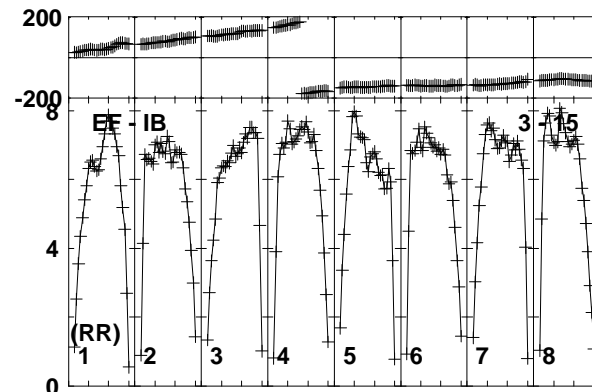
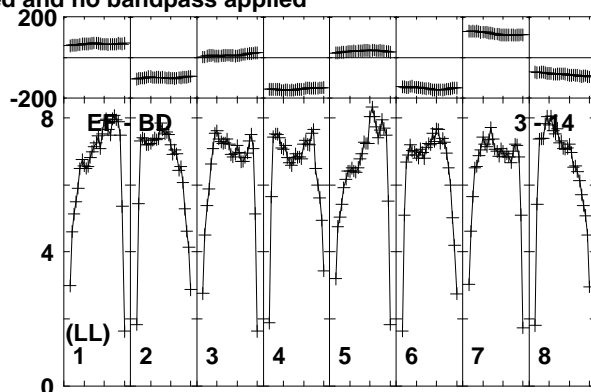
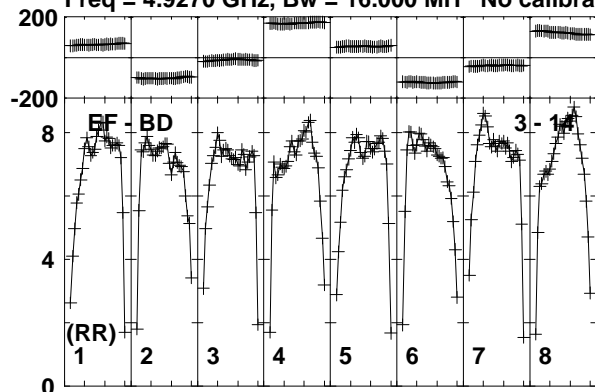

Lower frame: Milli Ampl Jy Top frame: Phas deg  
Vector averaged cross-power spectrum Baseline: EF (03) - BD (14)  
Timerange: 00/13:57:31 to 00/13:58:29

Plot file version 580 created 19-DEC-2018 17:58:55

AT2018\_RY007C.UVDATA.1

Freq = 4.9270 GHz, Bw = 16.000 MH No calibration applied and no bandpass applied

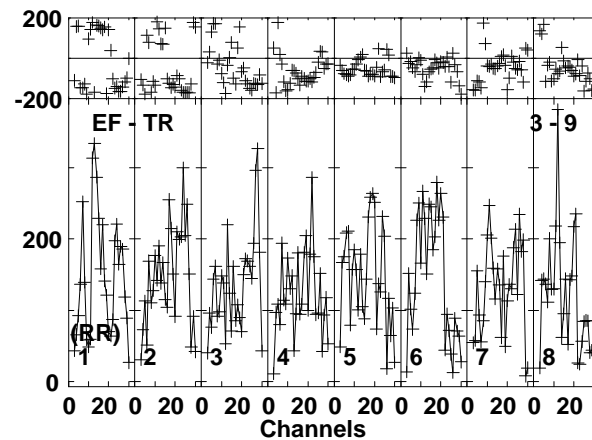
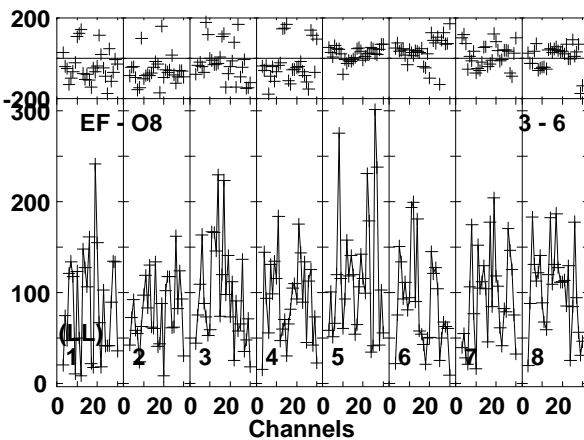
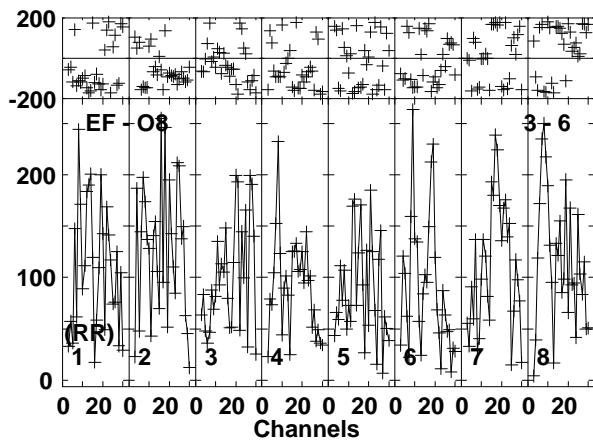
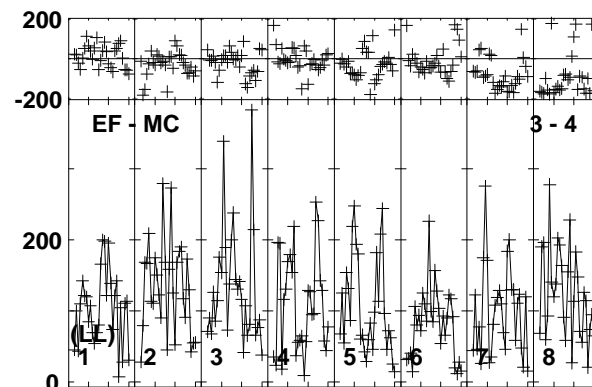
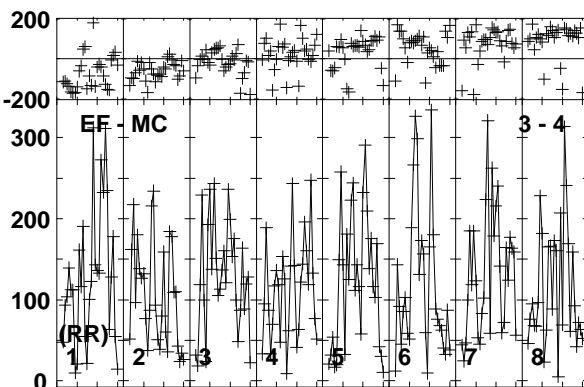
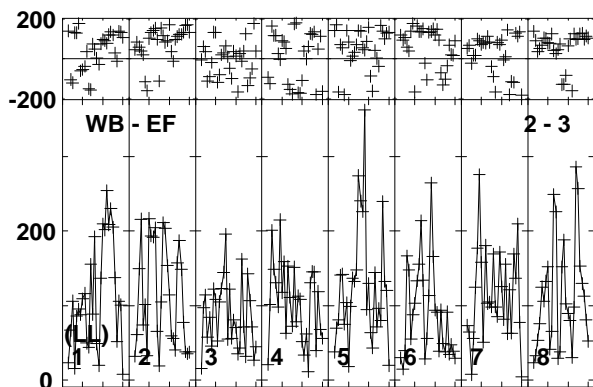
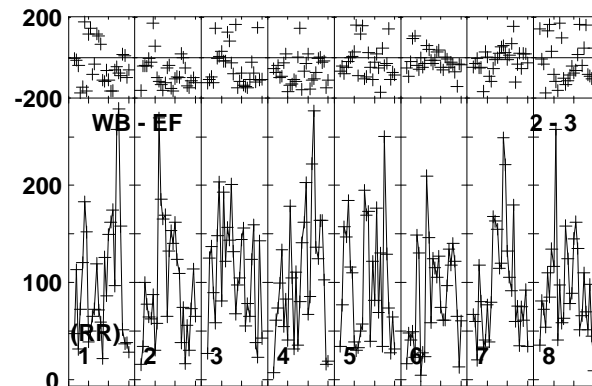
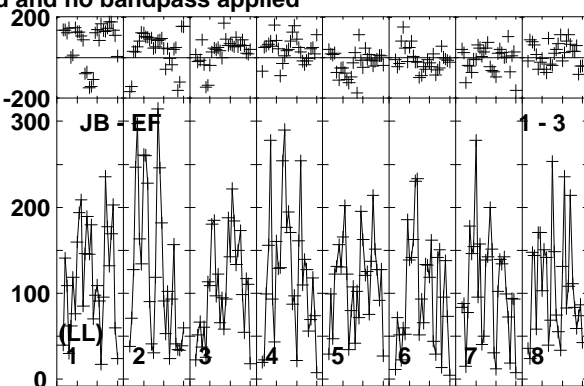
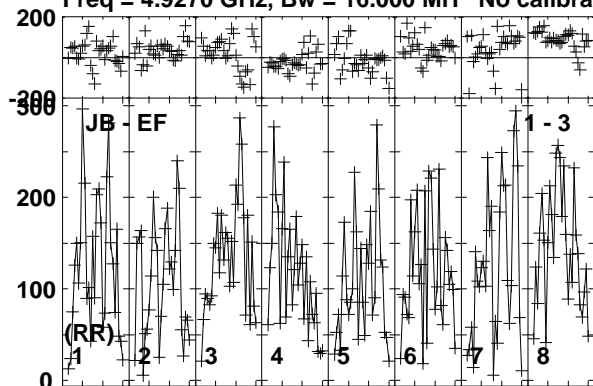

Lower frame: Micro Ampl Jy Top frame: Phas deg  
Vector averaged cross-power spectrum Baseline: JB (01) - EF (03)  
Timerange: 00/13:58:31 to 00/14:01:29

Plot file version 581 created 19-DEC-2018 17:58:55

AT2018\_RY007C.UVDATA.1

Freq = 4.9270 GHz, Bw = 16.000 MH No calibration applied and no bandpass applied

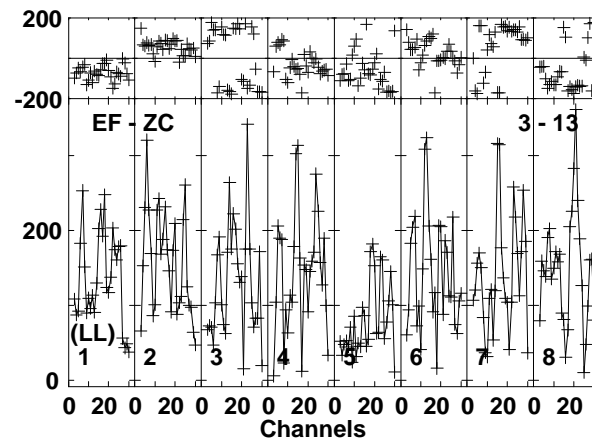
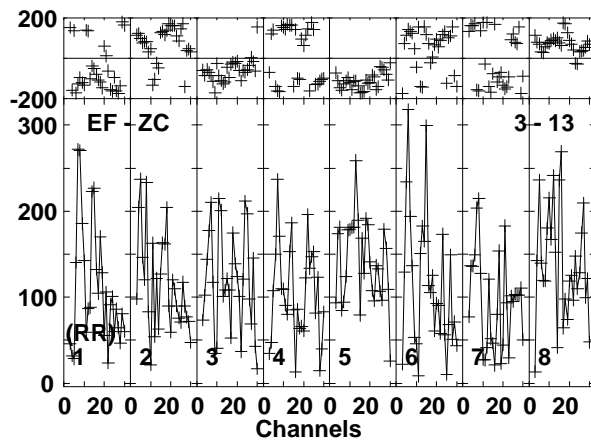
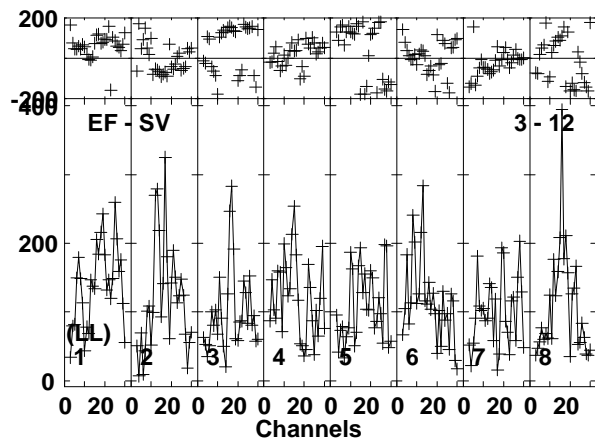
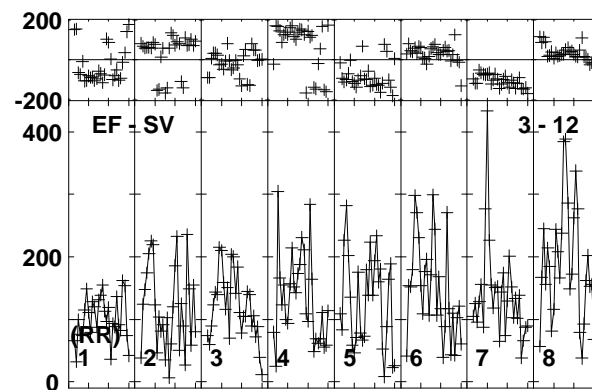
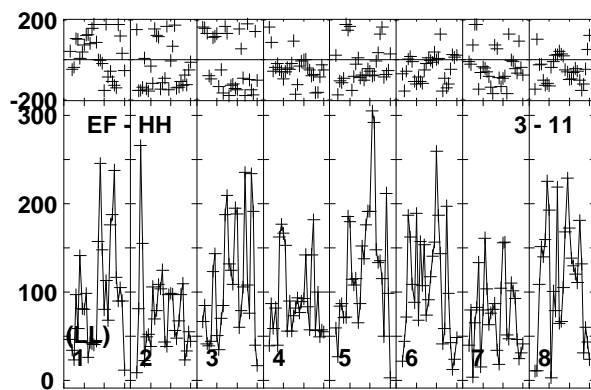
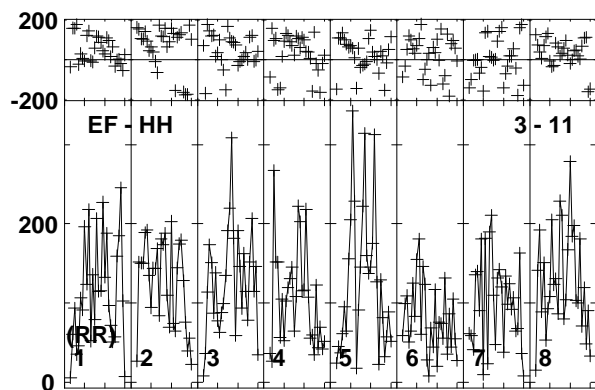
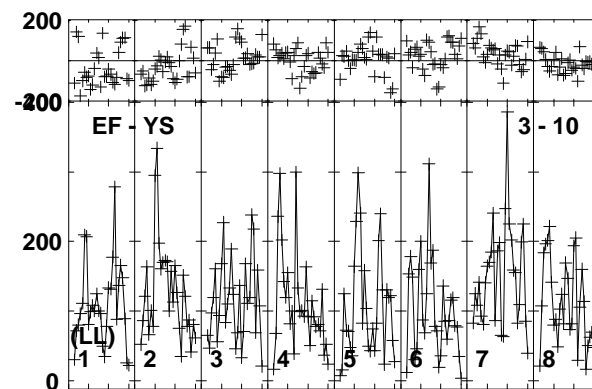
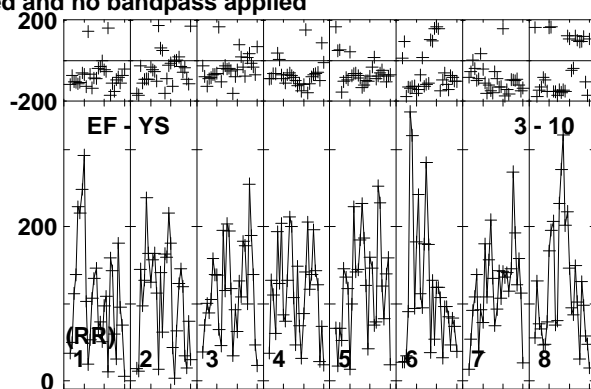
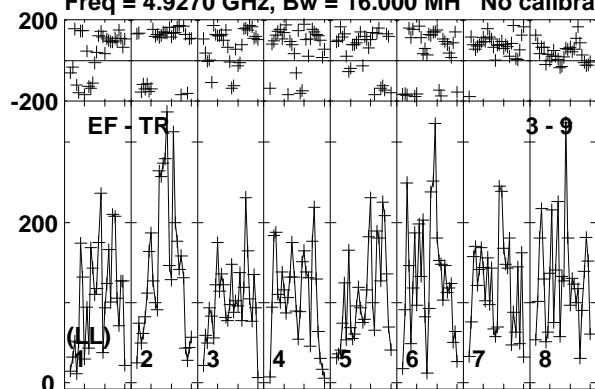

Lower frame: Micro Ampl Jy Top frame: Phas deg  
Vector averaged cross-power spectrum Baseline: EF (03) - TR (09)  
Timerange: 00/13:58:31 to 00/14:01:29

Plot file version 582 created 19-DEC-2018 17:58:55

AT2018\_RY007C.UVDATA.1

Freq = 4.9270 GHz, Bw = 16.000 MH No calibration applied and no bandpass applied

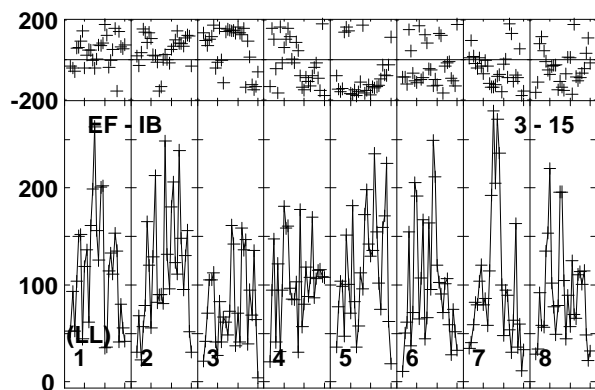
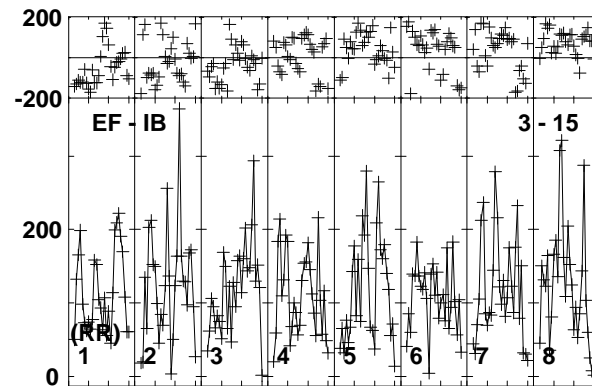
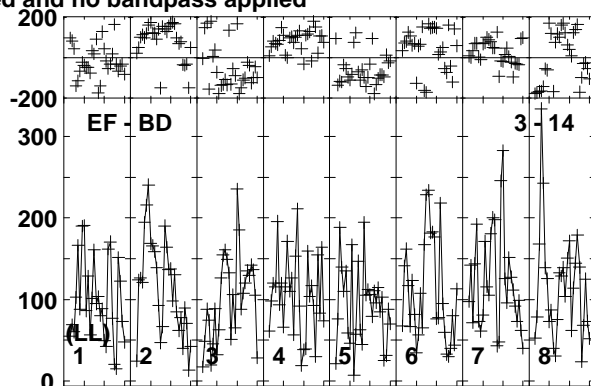
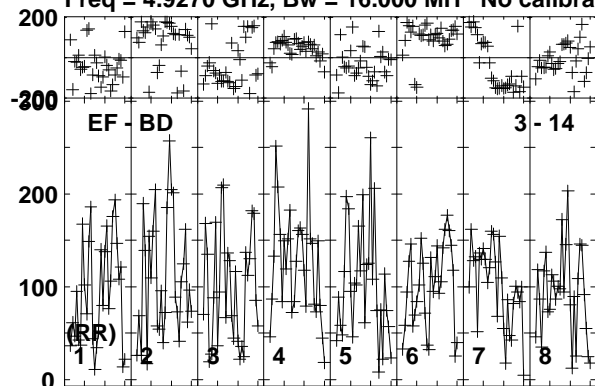

Lower frame: Micro Ampl Jy Top frame: Phas deg  
Vector averaged cross-power spectrum Baseline: EF (03) - BD (14)  
Timerange: 00/13:58:31 to 00/14:01:29

Plot file version 583 created 19-DEC-2018 17:58:55

J1619+2247 RY007C.UVDATA.1

Freq = 4.9270 GHz, Bw = 16.000 MH No calibration applied and no bandpass applied

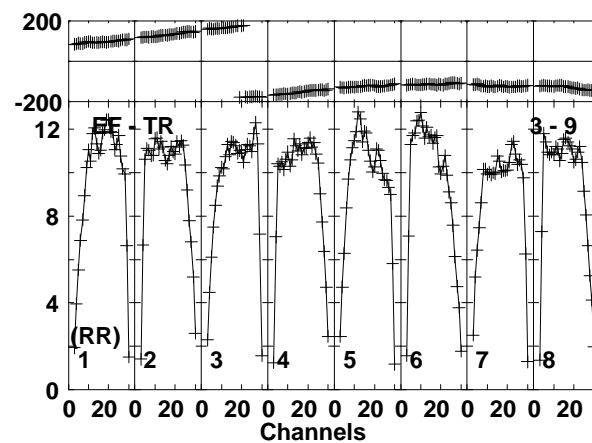
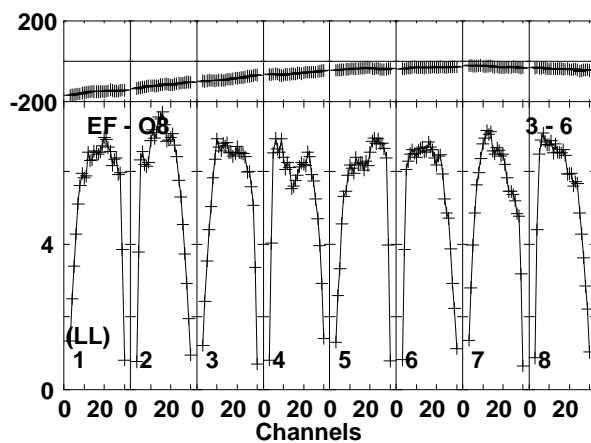
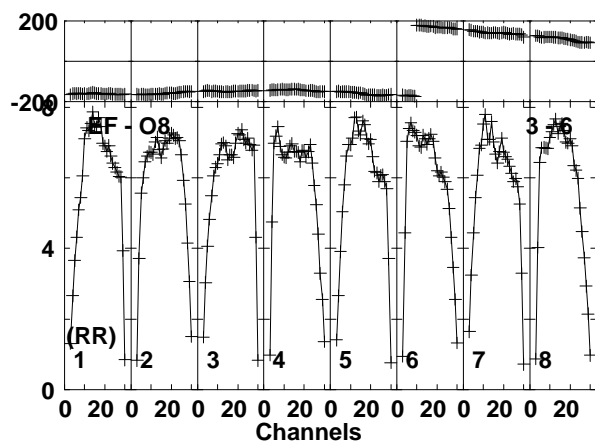
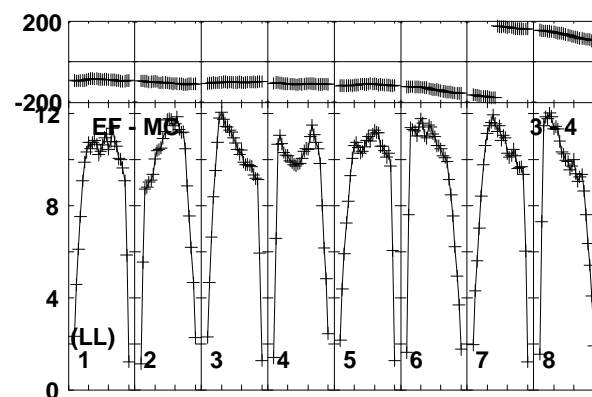
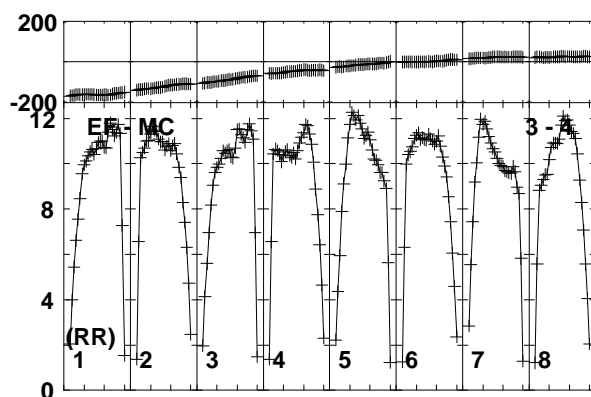
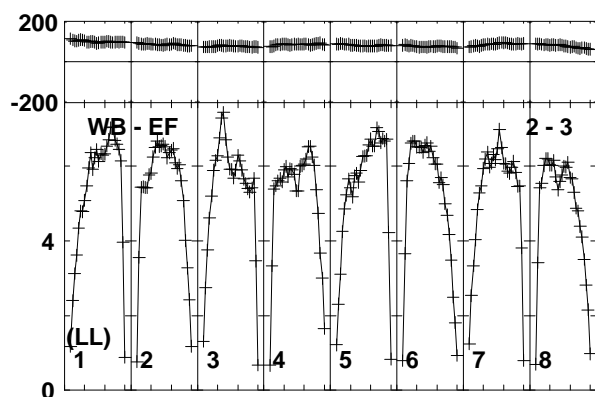
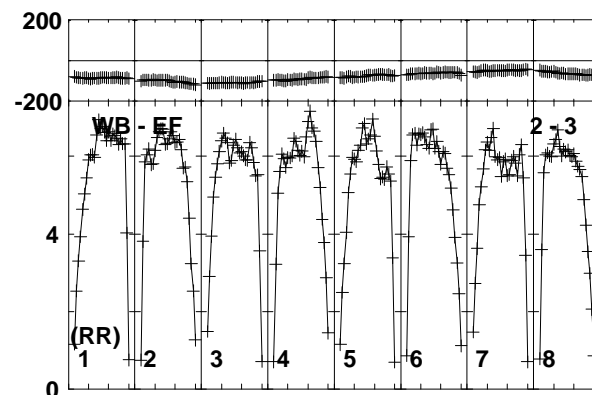
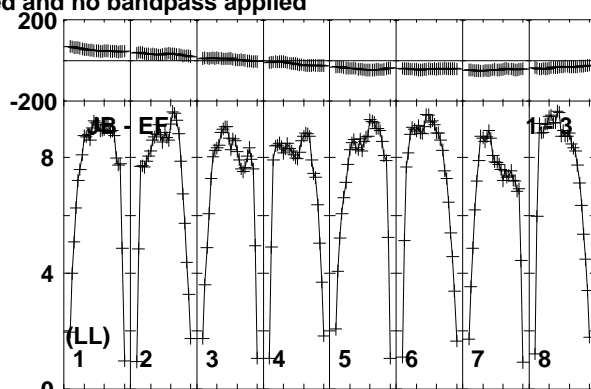
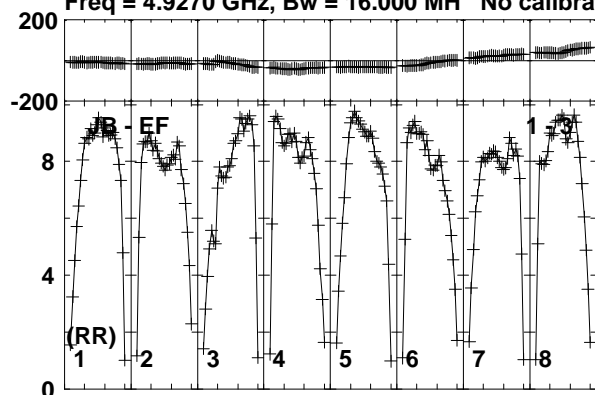

Lower frame: Milli Ampl Jy Top frame: Phas deg  
Vector averaged cross-power spectrum Baseline: JB (01) - EF (03)  
Timerange: 00/14:01:31 to 00/14:02:29

Plot file version 584 created 19-DEC-2018 17:58:55

J1619+2247 RY007C.UVDATA.1

Freq = 4.9270 GHz, Bw = 16.000 MH No calibration applied and no bandpass applied

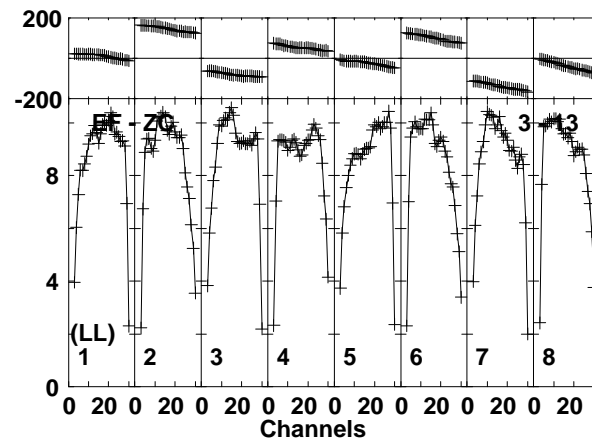
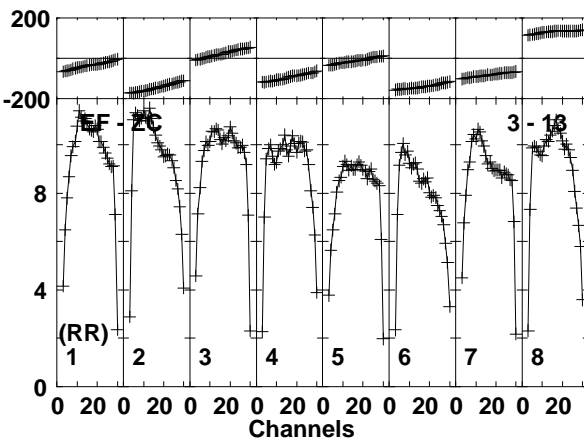
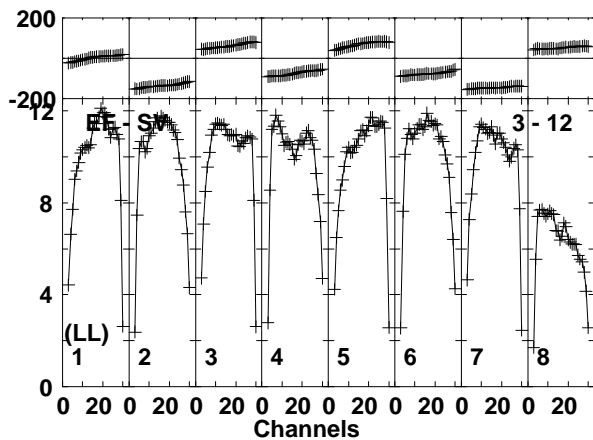
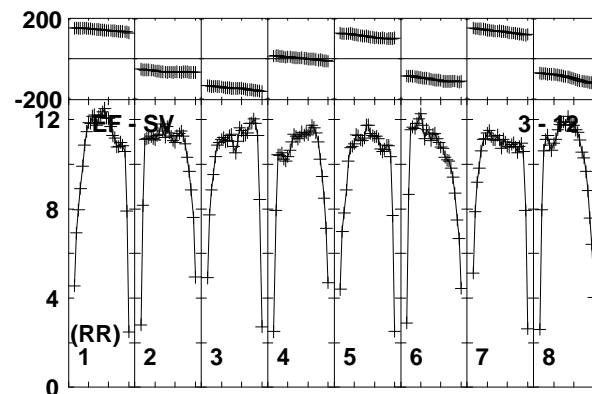
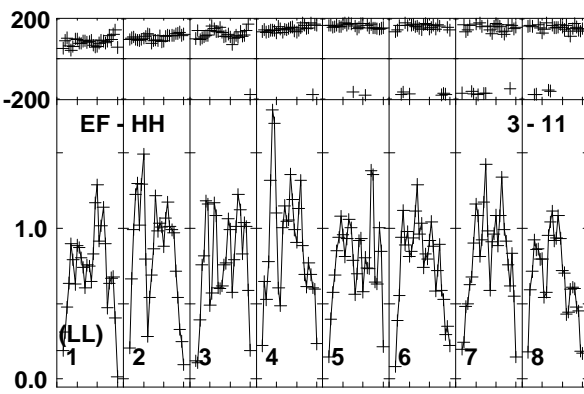
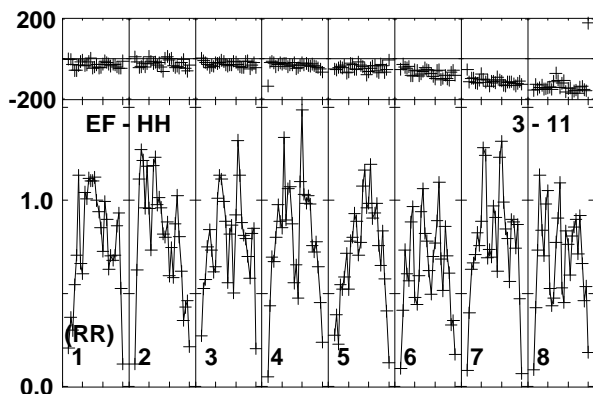
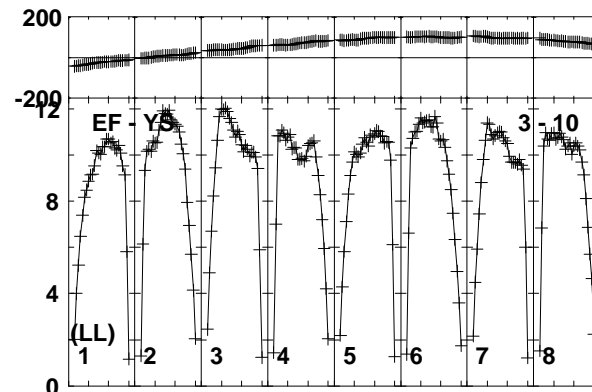
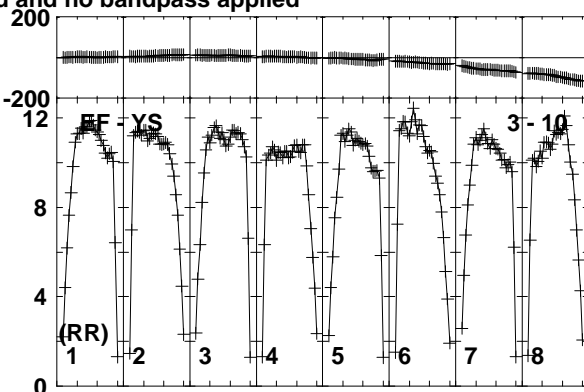
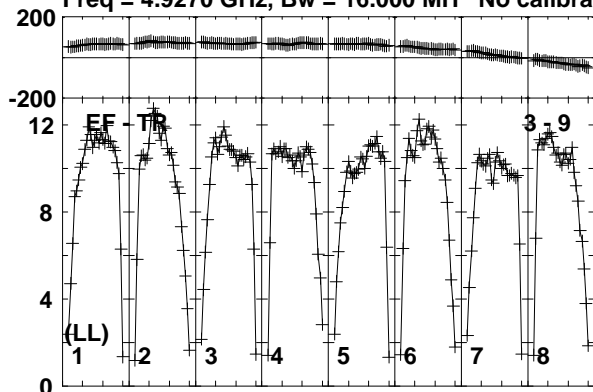

Lower frame: Milli Ampl Jy Top frame: Phas deg  
Vector averaged cross-power spectrum Baseline: EF (03) - TR (09)  
Timerange: 00/14:01:31 to 00/14:02:29

Plot file version 585 created 19-DEC-2018 17:58:56

J1619+2247 RY007C.UVDATA.1

Freq = 4.9270 GHz, Bw = 16.000 MH No calibration applied and no bandpass applied

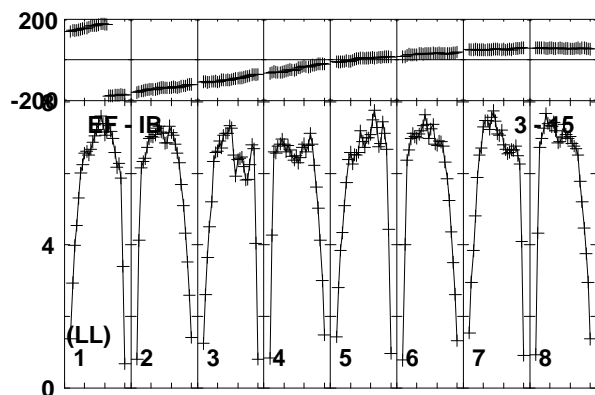
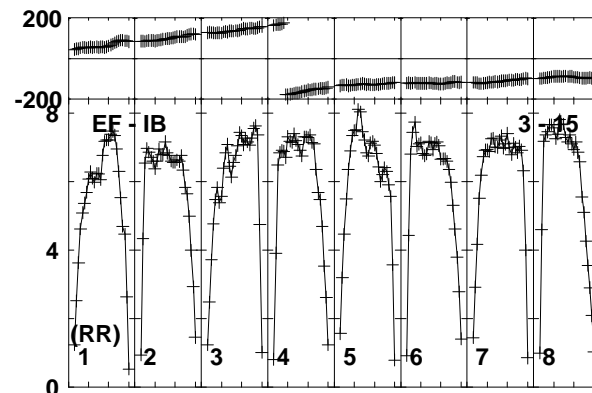
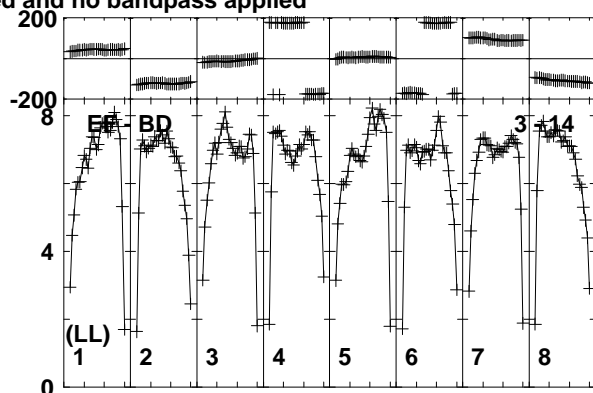
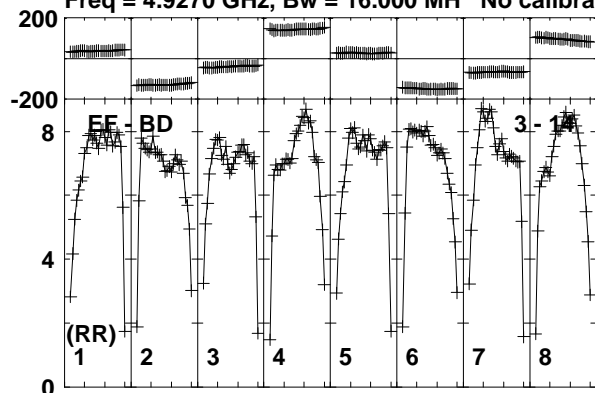

Lower frame: Milli Ampl Jy Top frame: Phas deg  
Vector averaged cross-power spectrum Baseline: EF (03) - BD (14)  
Timerange: 00/14:01:31 to 00/14:02:29

Plot file version 586 created 19-DEC-2018 17:58:56

VLA1 RY007C.UVDATA.1

Freq = 4.9270 GHz, Bw = 16.000 MH No calibration applied and no bandpass applied

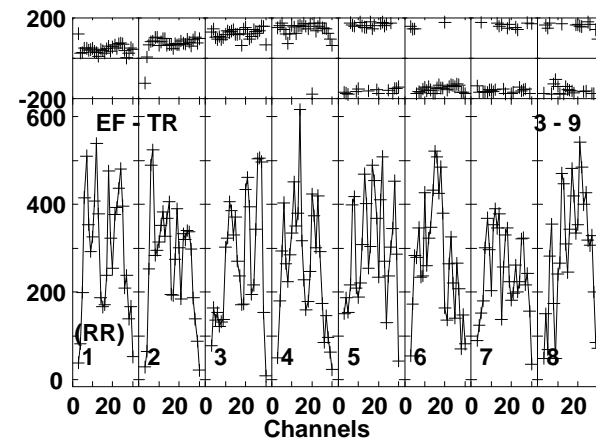
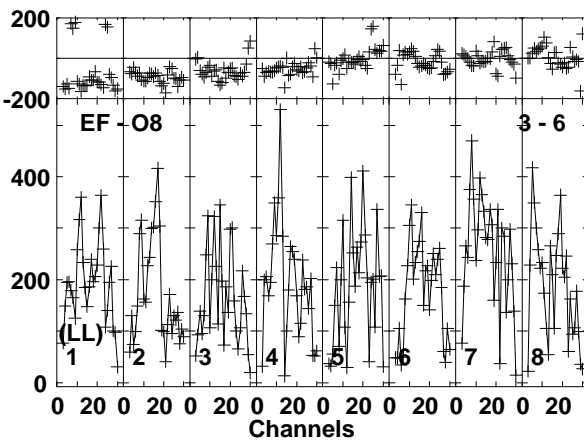
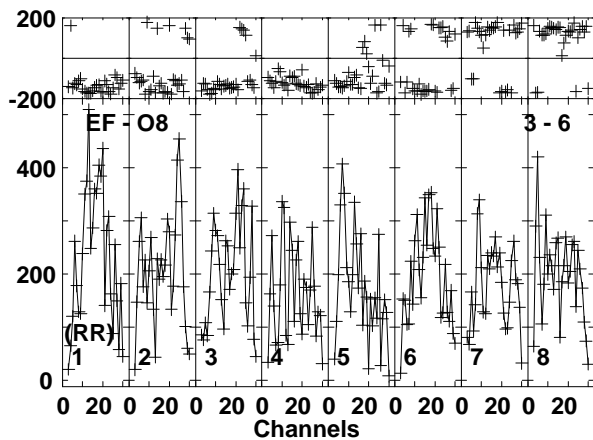
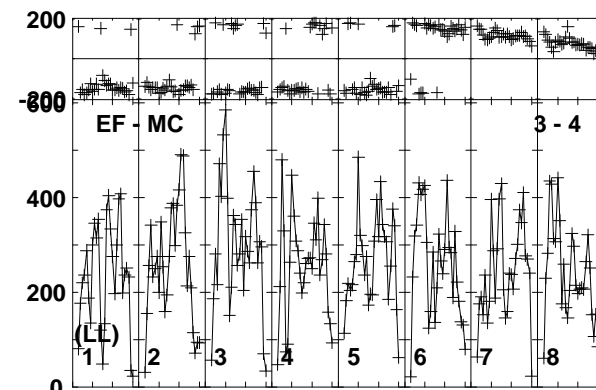
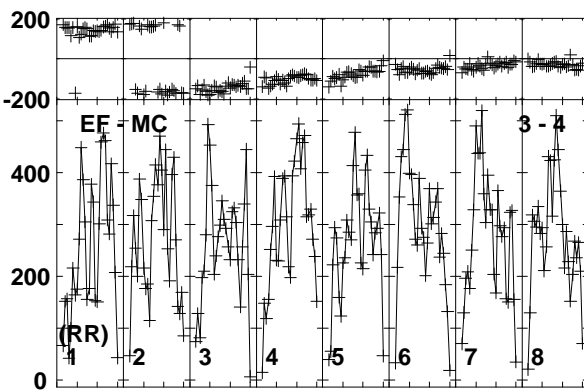
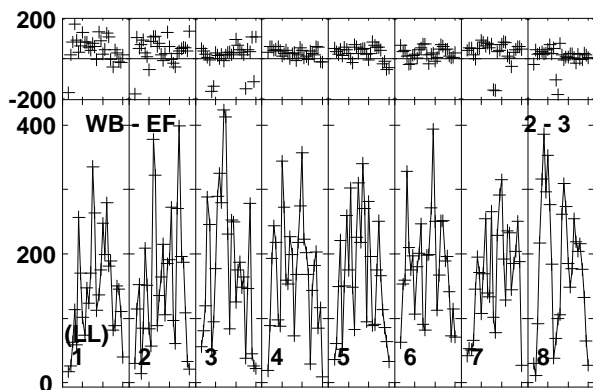
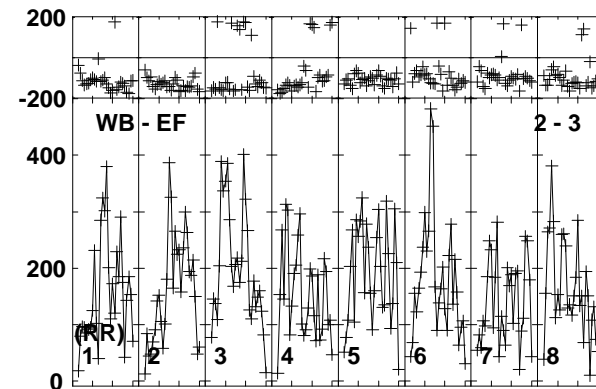
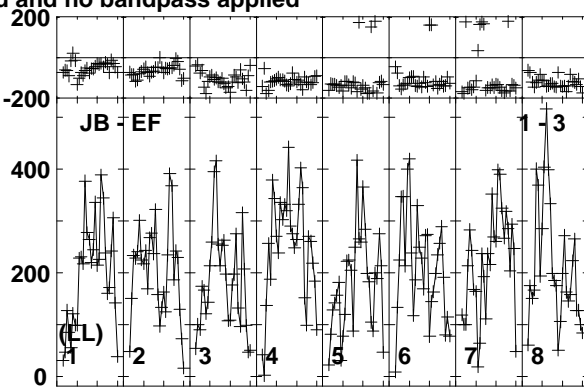
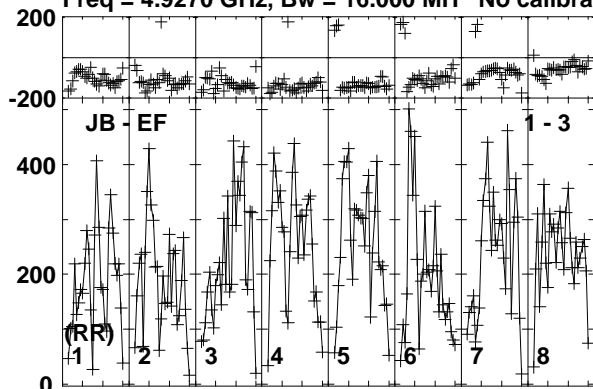

Lower frame: Micro Ampl Jy Top frame: Phas deg  
Vector averaged cross-power spectrum Baseline: JB (01) - EF (03)  
Timerange: 00/14:03:01 to 00/14:04:59



Plot file version 587 created 19-DEC-2018 17:58:56

VLA1 RY007C.UVDATA.1

Freq = 4.9270 GHz, Bw = 16.000 MH No calibration applied and no bandpass applied

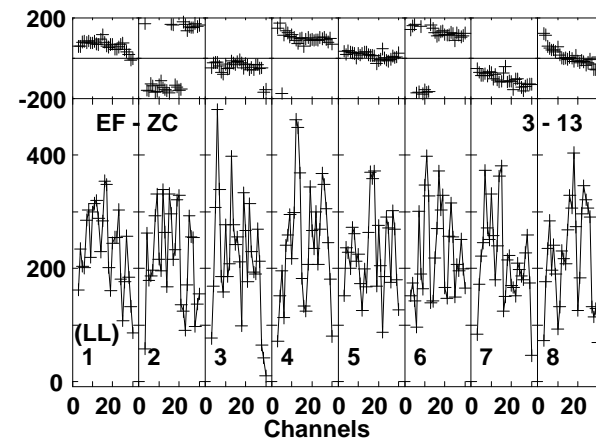
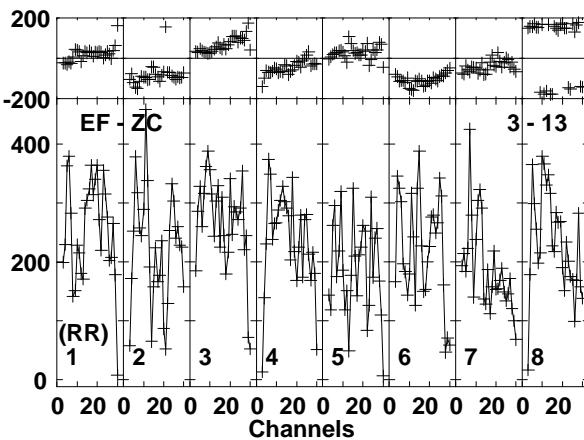
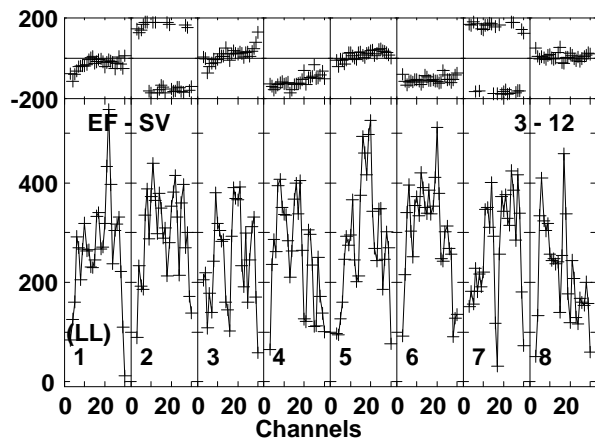
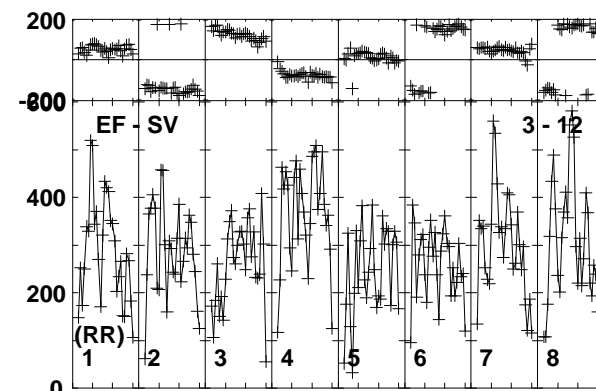
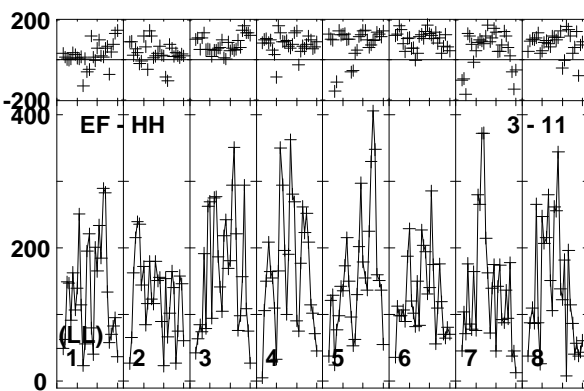
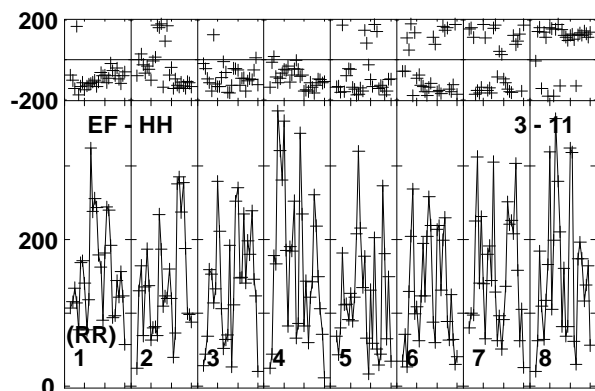
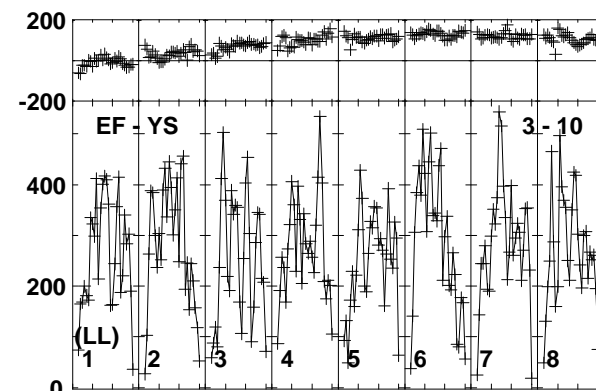
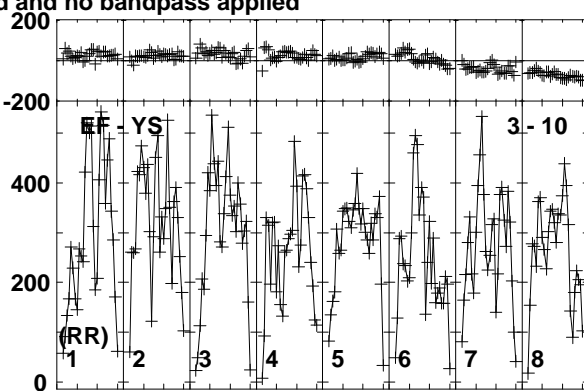
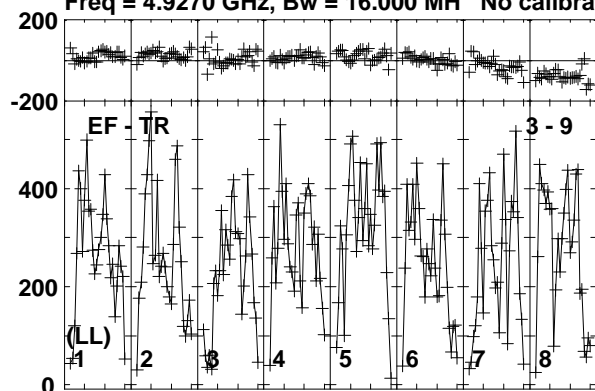

Lower frame: Micro Ampl Jy Top frame: Phas deg  
Vector averaged cross-power spectrum Baseline: EF (03) - TR (09)  
Timerange: 00/14:03:01 to 00/14:04:59

Plot file version 588 created 19-DEC-2018 17:58:56

VLA1 RY007C.UVDATA.1

Freq = 4.9270 GHz, Bw = 16.000 MH No calibration applied and no bandpass applied

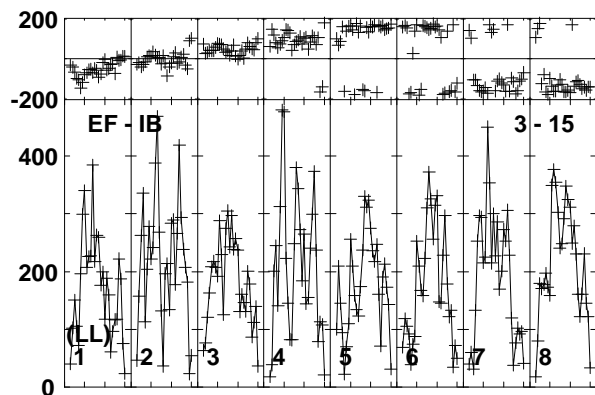
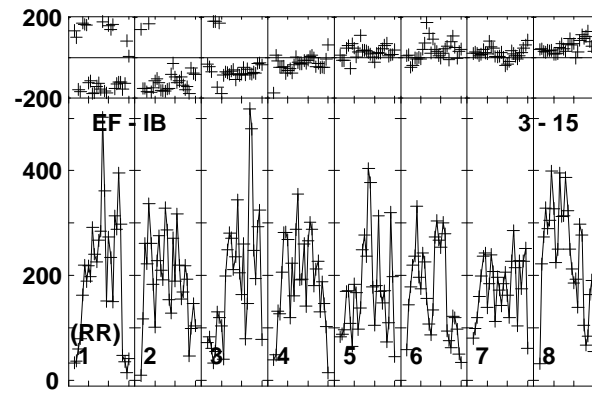
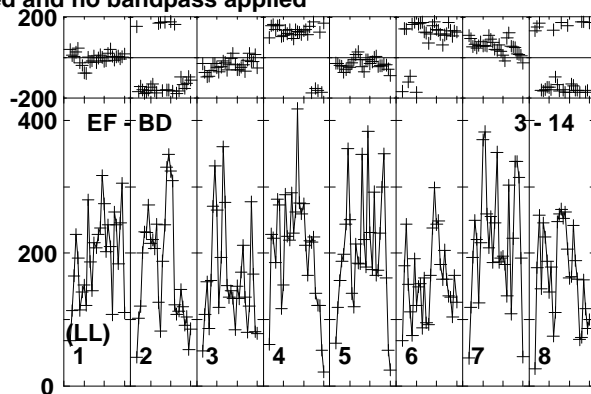
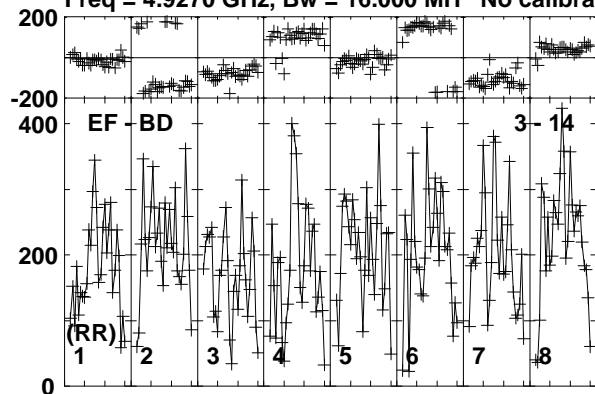

Lower frame: Micro Ampl Jy Top frame: Phas deg  
Vector averaged cross-power spectrum Baseline: EF (03) - BD (14)  
Timerange: 00/14:03:01 to 00/14:04:59

Plot file version 589 created 19-DEC-2018 17:58:56

J1619+2247 RY007C.UVDATA.1

Freq = 4.9270 GHz, Bw = 16.000 MH No calibration applied and no bandpass applied

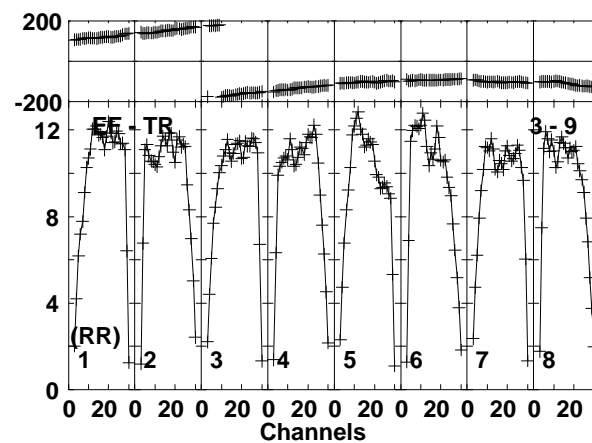
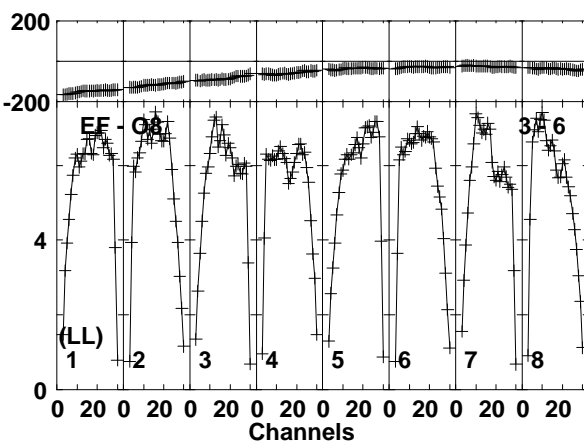
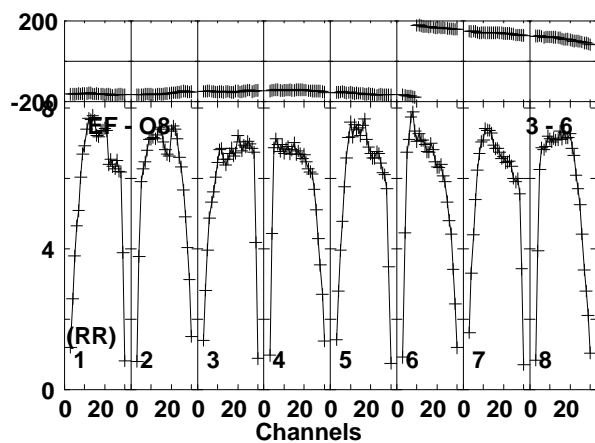
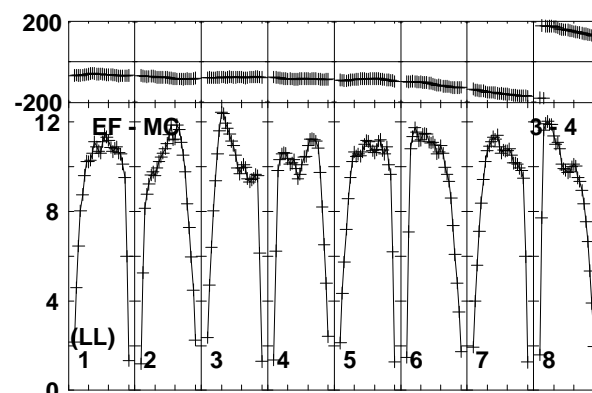
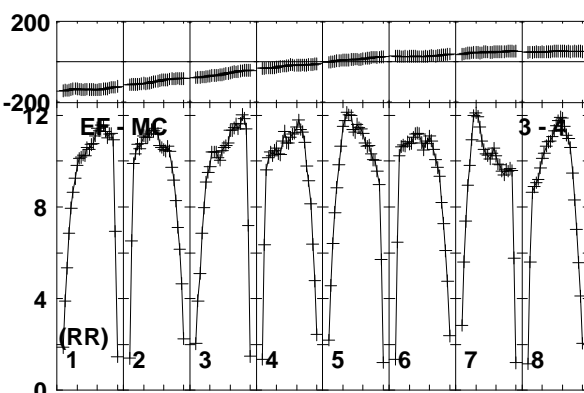
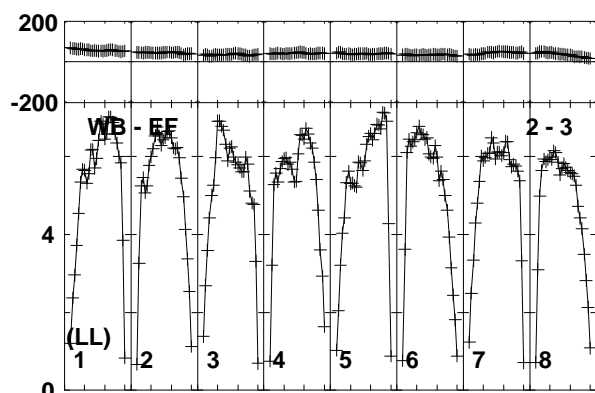
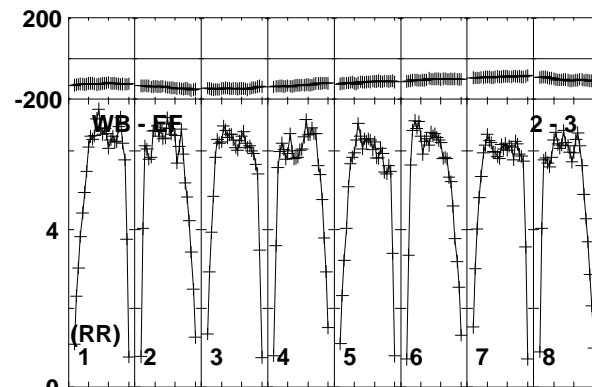
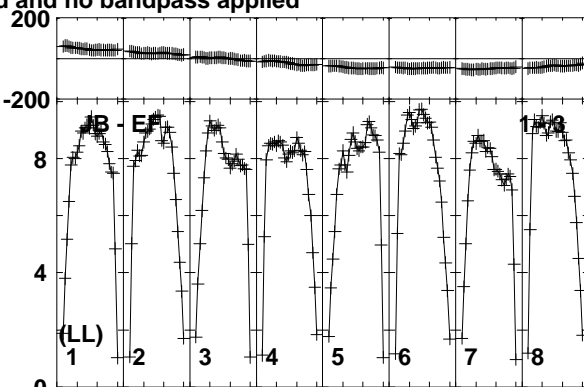
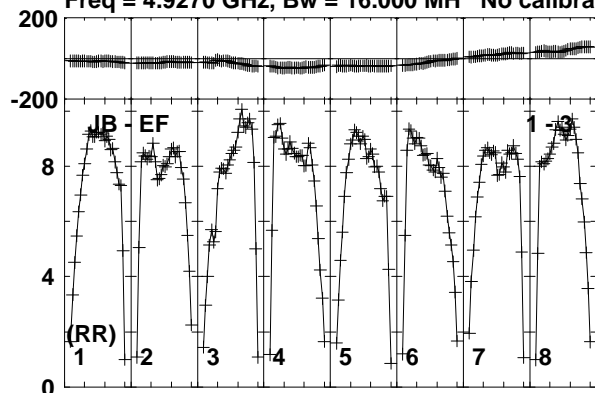

Lower frame: Milli Ampl Jy Top frame: Phas deg  
Vector averaged cross-power spectrum Baseline: JB (01) - EF (03)  
Timerange: 00/14:05:01 to 00/14:05:59

Plot file version 590 created 19-DEC-2018 17:58:56

J1619+2247 RY007C.UVDATA.1

Freq = 4.9270 GHz, Bw = 16.000 MH No calibration applied and no bandpass applied

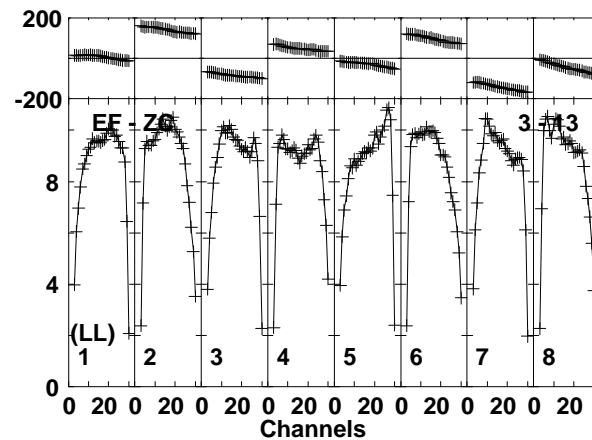
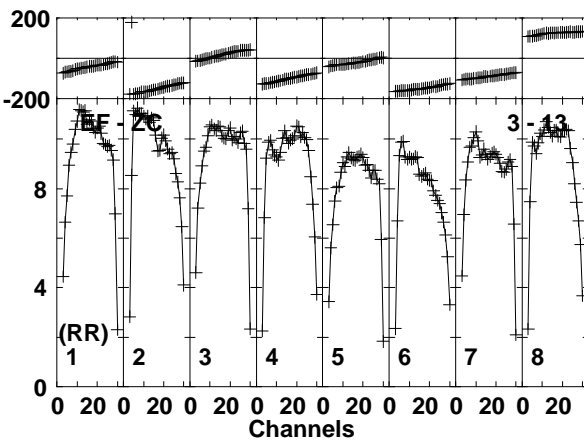
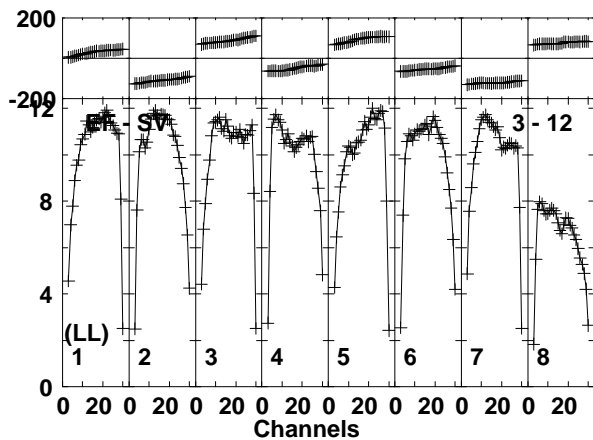
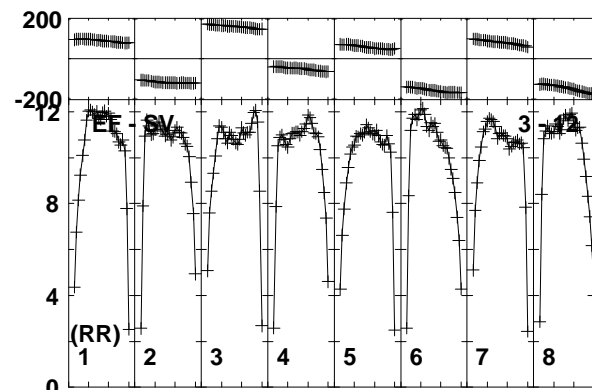
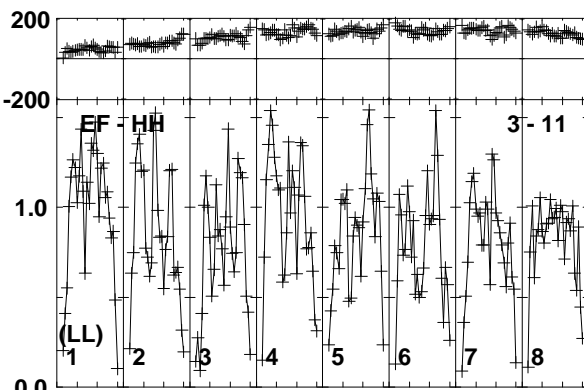
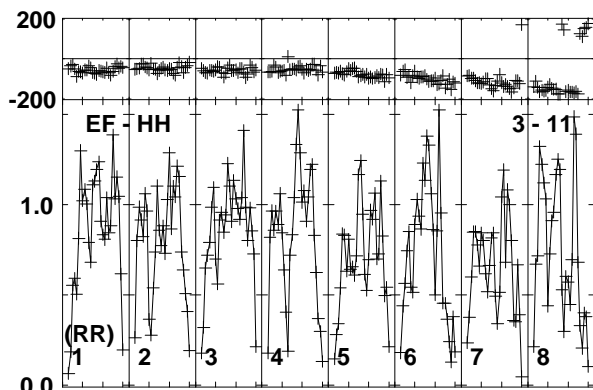
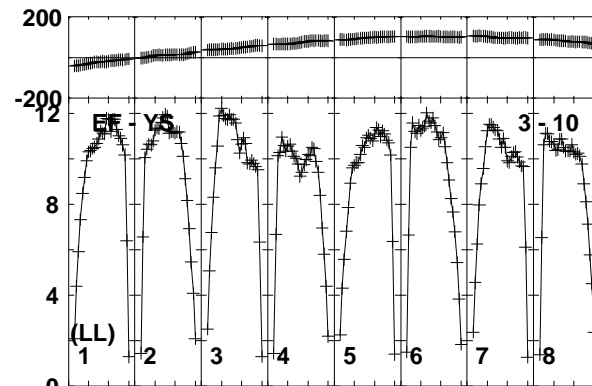
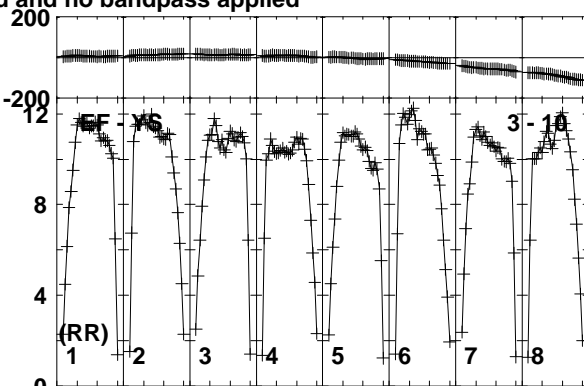
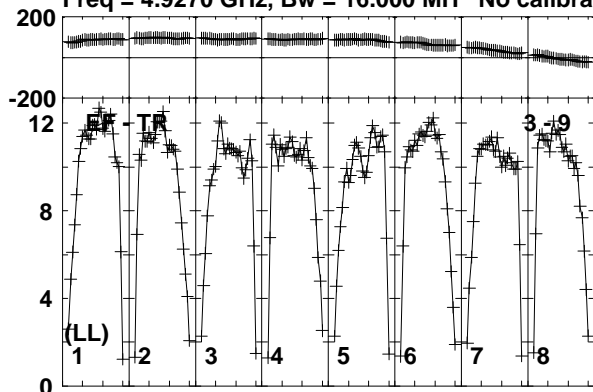

Lower frame: Milli Ampl Jy Top frame: Phas deg  
Vector averaged cross-power spectrum Baseline: EF (03) - TR (09)  
Timerange: 00/14:05:01 to 00/14:05:59

Plot file version 591 created 19-DEC-2018 17:58:56

J1619+2247 RY007C.UVDATA.1

Freq = 4.9270 GHz, Bw = 16.000 MH No calibration applied and no bandpass applied

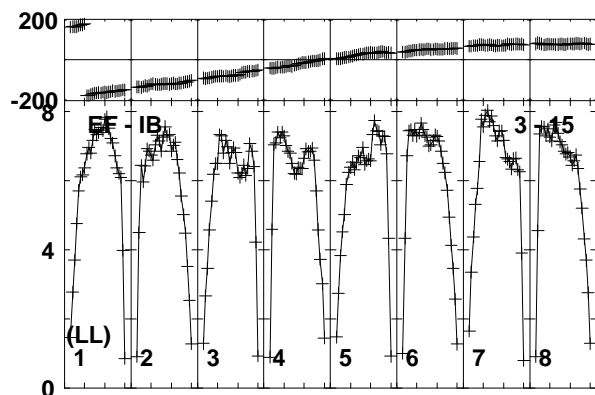
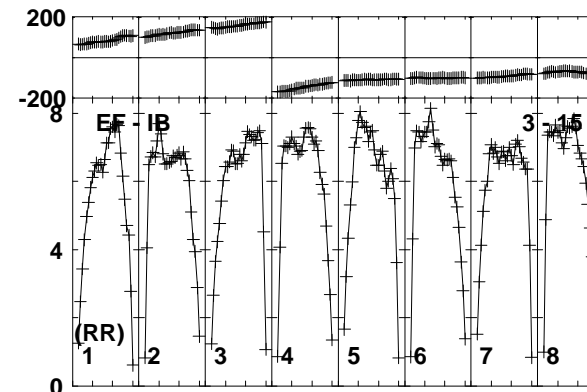
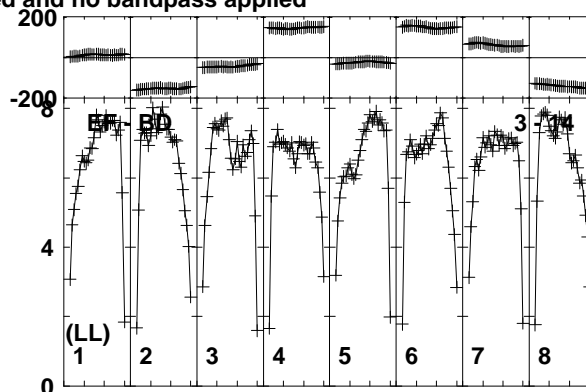
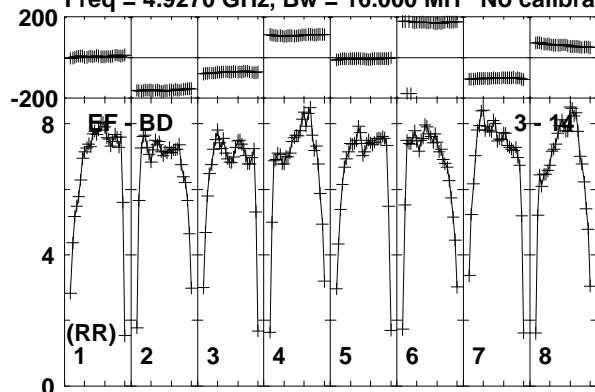

Lower frame: Milli Ampl Jy Top frame: Phas deg  
Vector averaged cross-power spectrum Baseline: EF (03) - BD (14)  
Timerange: 00/14:05:01 to 00/14:05:59

Plot file version 592 created 19-DEC-2018 17:58:56

AT2018\_RY007C.UVDATA.1

Freq = 4.9270 GHz, Bw = 16.000 MH No calibration applied and no bandpass applied

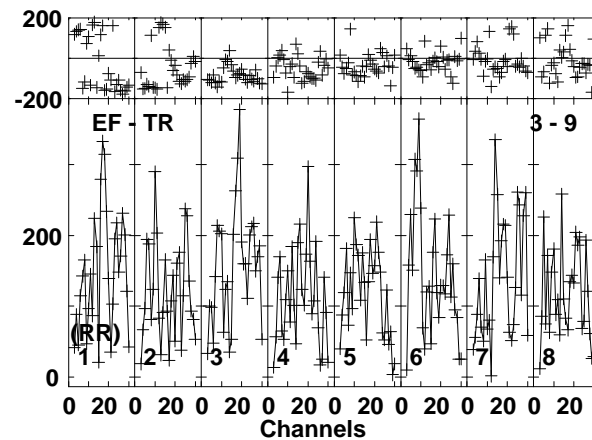
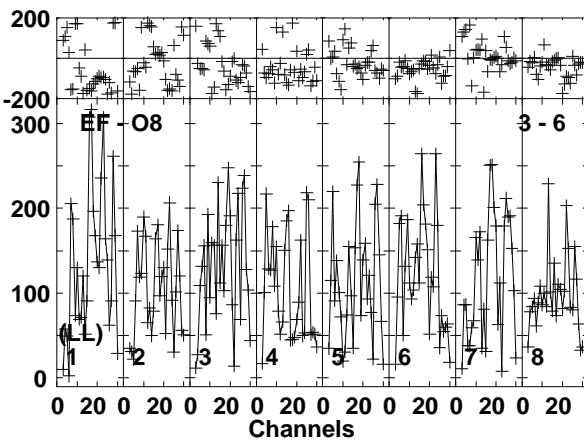
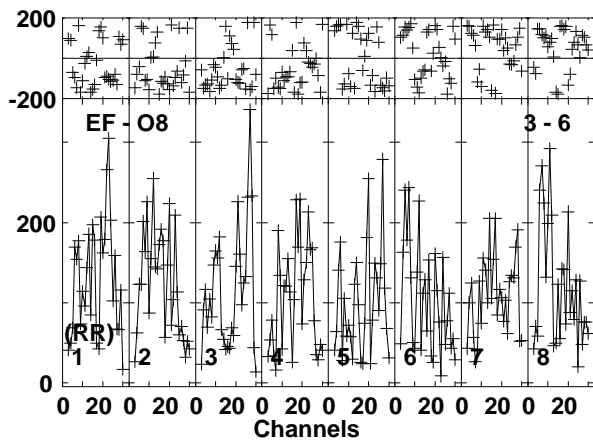
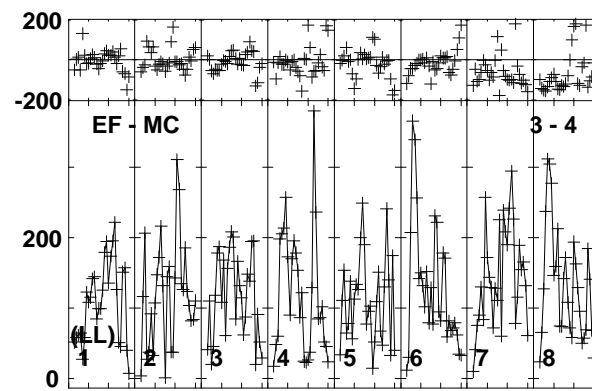
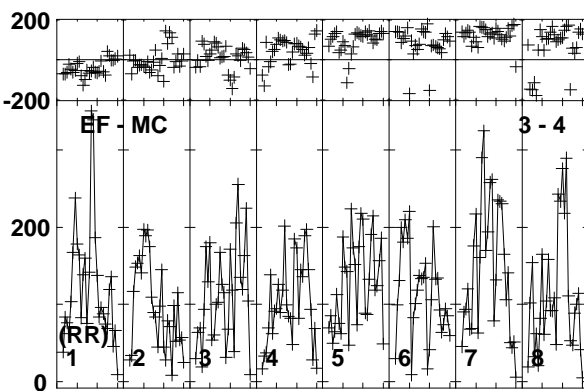
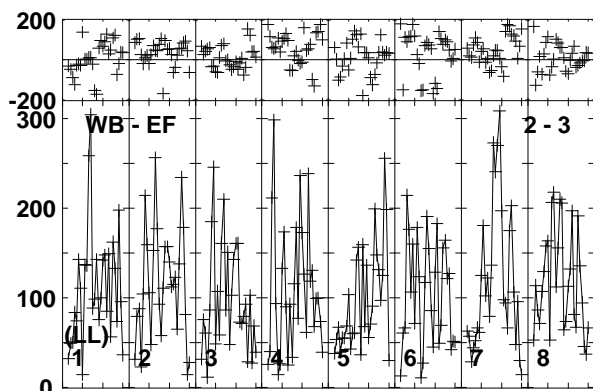
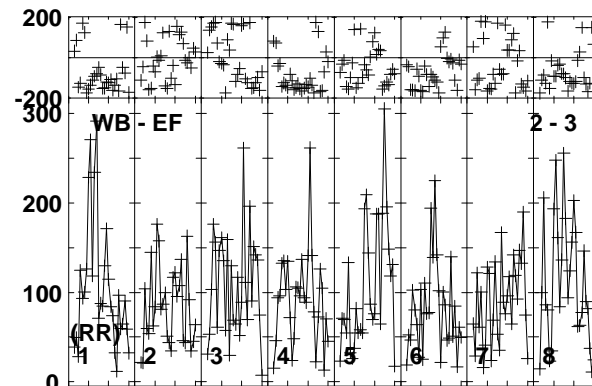
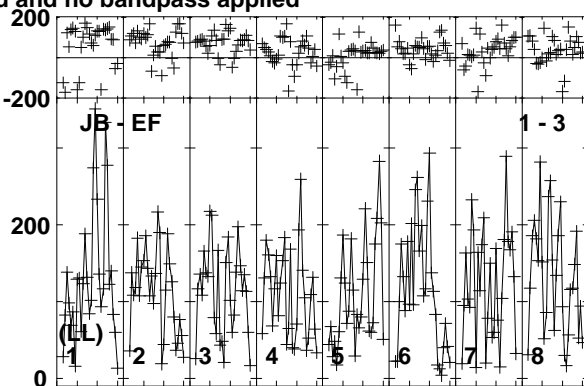
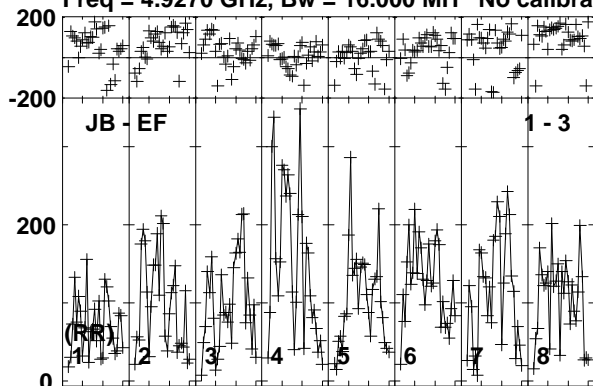

Lower frame: Micro Ampl Jy Top frame: Phas deg  
Vector averaged cross-power spectrum Baseline: JB (01) - EF (03)  
Timerange: 00/14:06:01 to 00/14:08:59

Plot file version 593 created 19-DEC-2018 17:58:56

AT2018\_RY007C.UVDATA.1

Freq = 4.9270 GHz, Bw = 16.000 MH No calibration applied and no bandpass applied

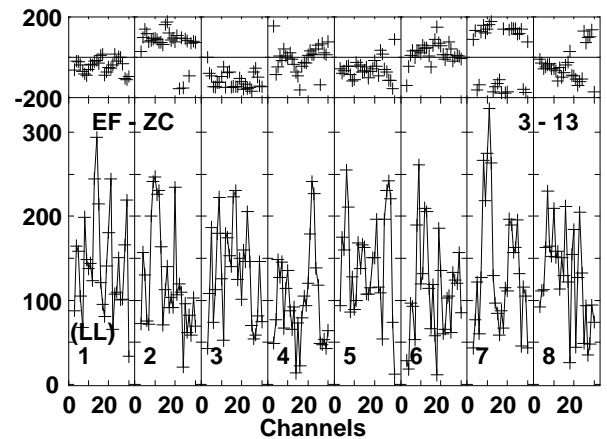
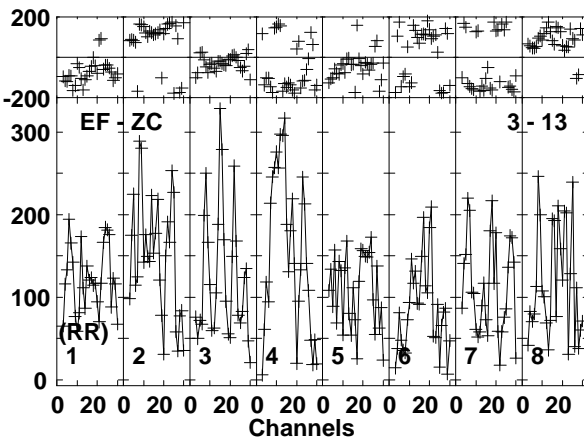
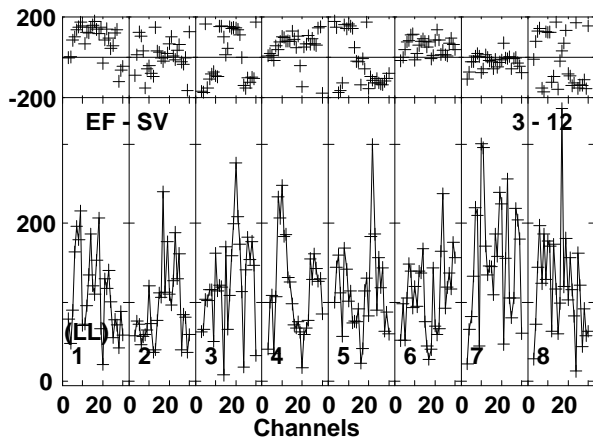
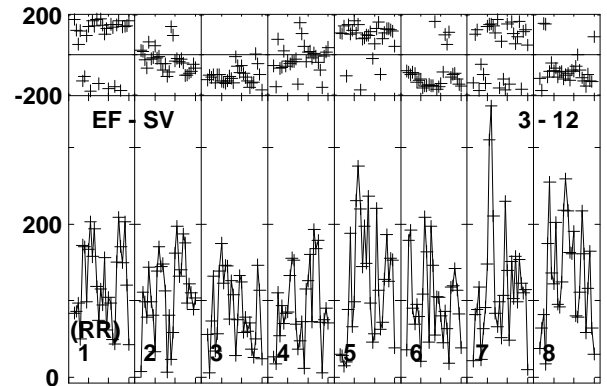
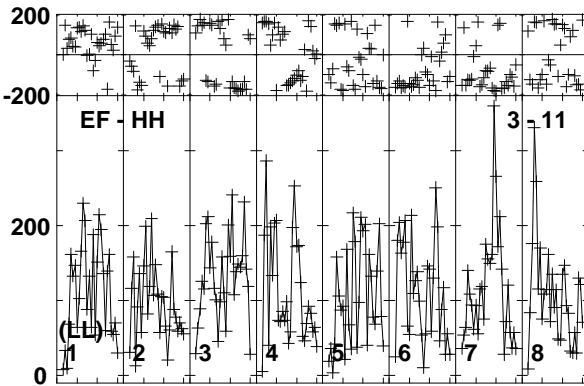
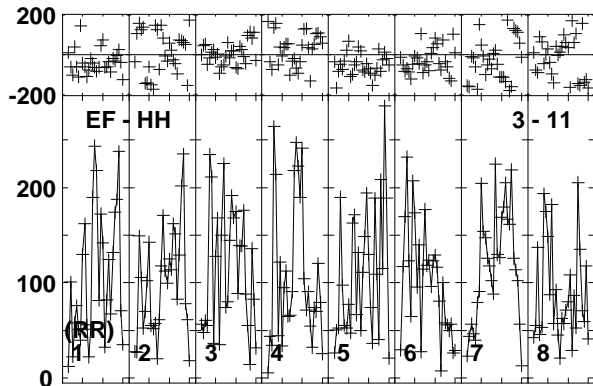
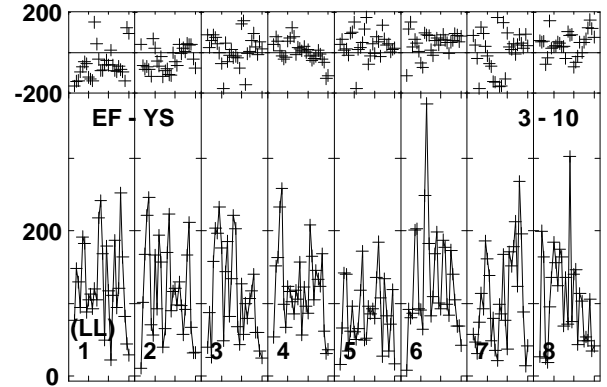
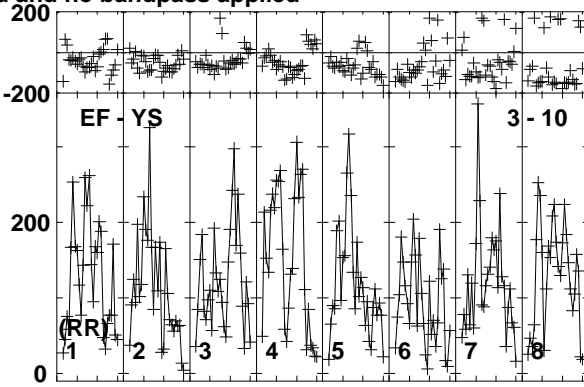
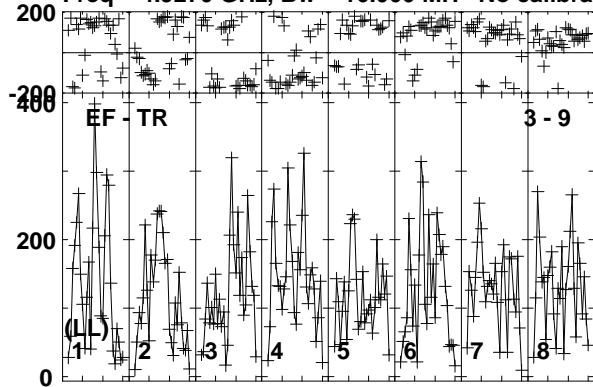

Lower frame: Micro Ampl Jy Top frame: Phas deg  
Vector averaged cross-power spectrum Baseline: EF (03) - TR (09)  
Timerange: 00/14:06:01 to 00/14:08:59

Plot file version 594 created 19-DEC-2018 17:58:56

AT2018\_RY007C.UVDATA.1

Freq = 4.9270 GHz, Bw = 16.000 MH No calibration applied and no bandpass applied

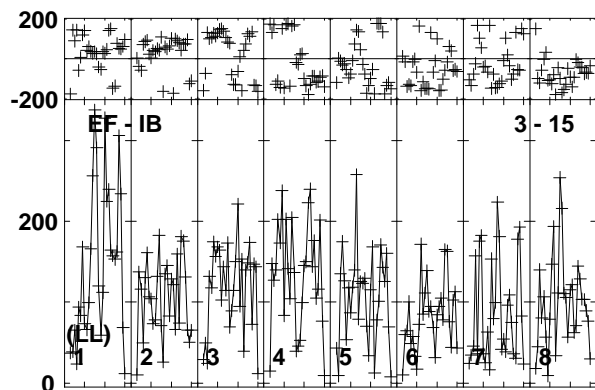
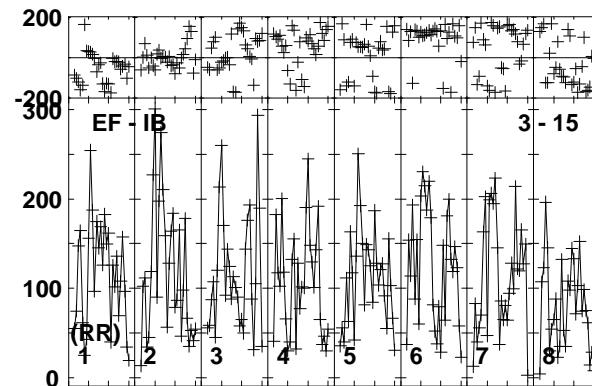
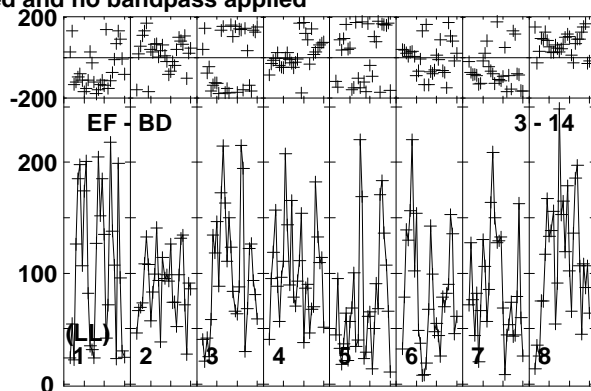
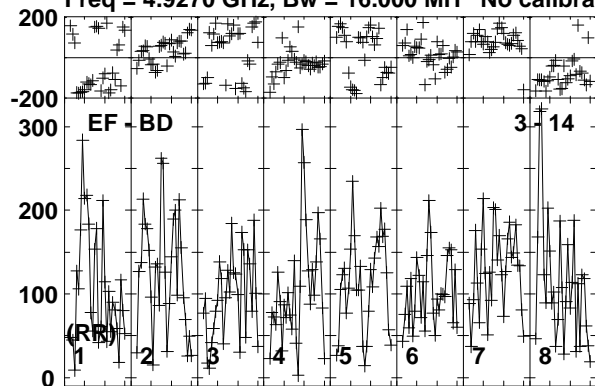

Lower frame: Micro Ampl Jy Top frame: Phas deg  
Vector averaged cross-power spectrum Baseline: EF (03) - BD (14)  
Timerange: 00/14:06:01 to 00/14:08:59



Plot file version 595 created 19-DEC-2018 17:58:56

J1619+2247 RY007C.UVDATA.1

Freq = 4.9270 GHz, Bw = 16.000 MH No calibration applied and no bandpass applied

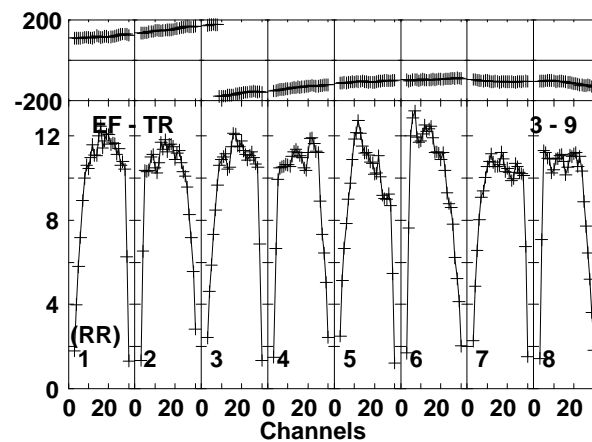
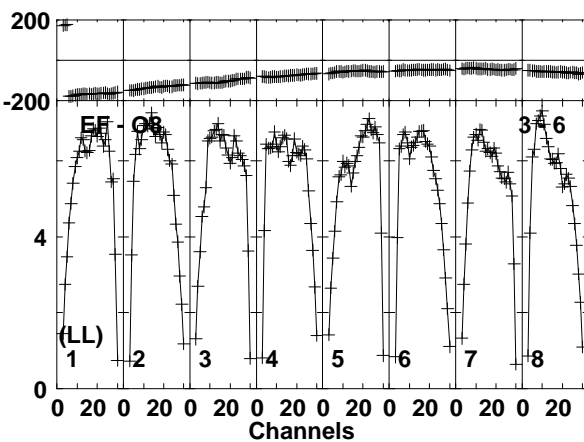
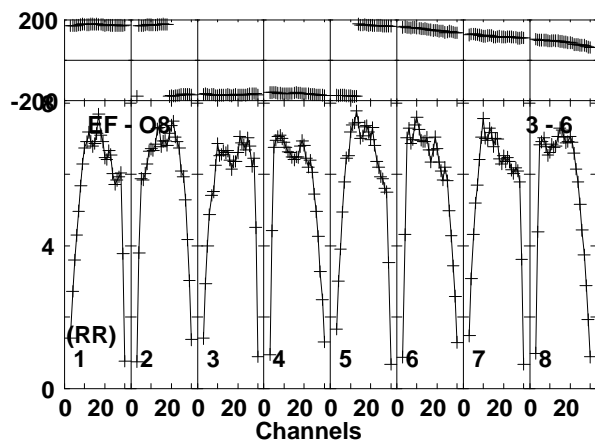
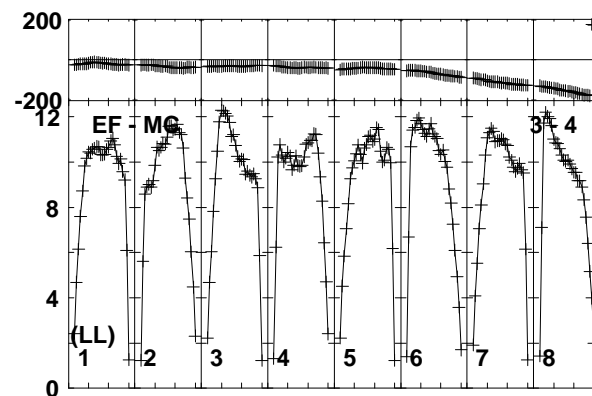
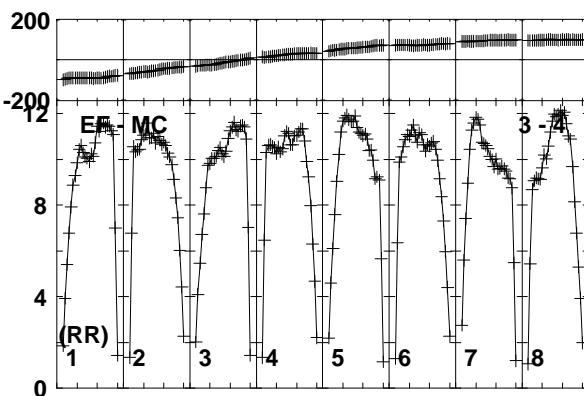
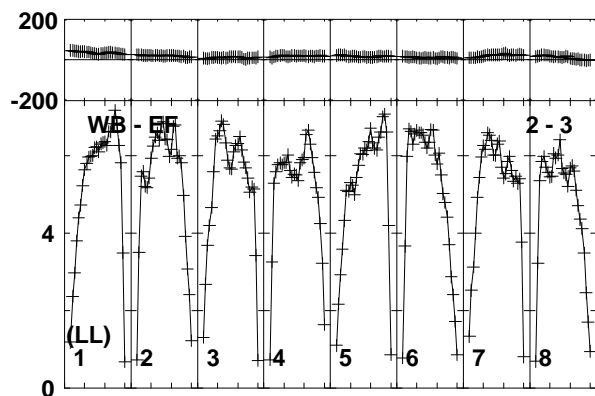
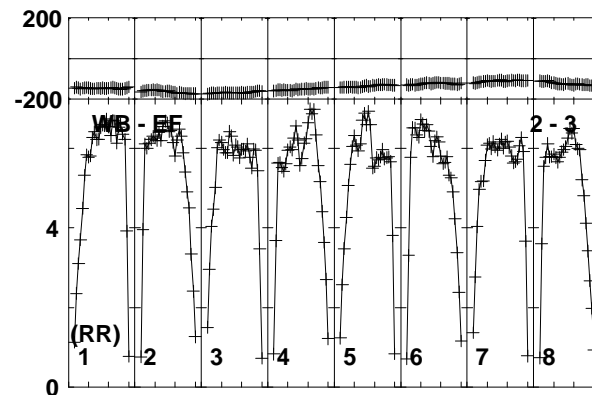
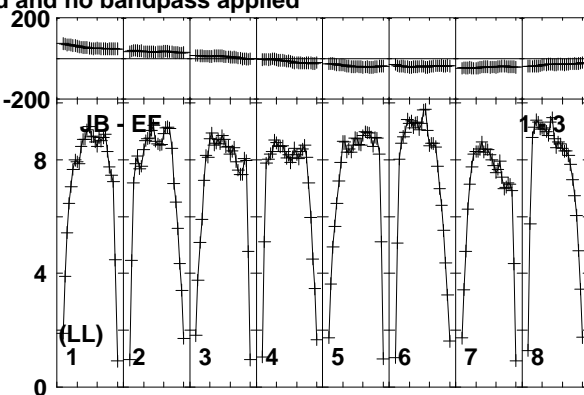
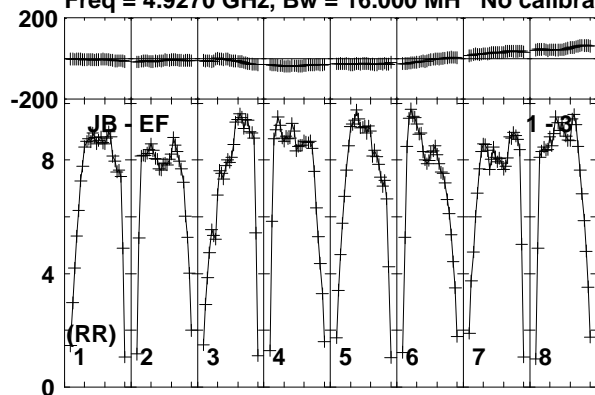

Lower frame: Milli Ampl Jy Top frame: Phas deg  
Vector averaged cross-power spectrum Baseline: JB (01) - EF (03)  
Timerange: 00/14:09:01 to 00/14:09:59

Plot file version 596 created 19-DEC-2018 17:58:56

J1619+2247 RY007C.UVDATA.1

Freq = 4.9270 GHz, Bw = 16.000 MH No calibration applied and no bandpass applied

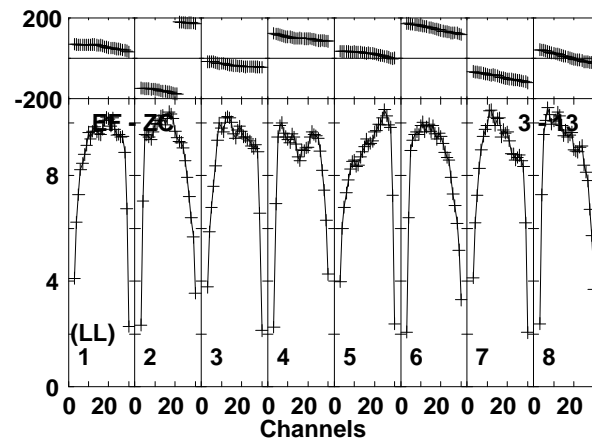
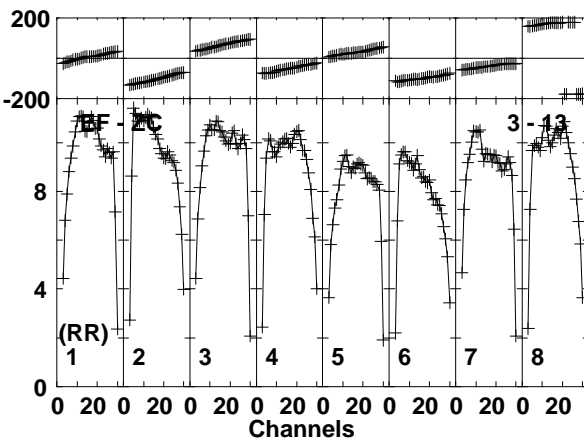
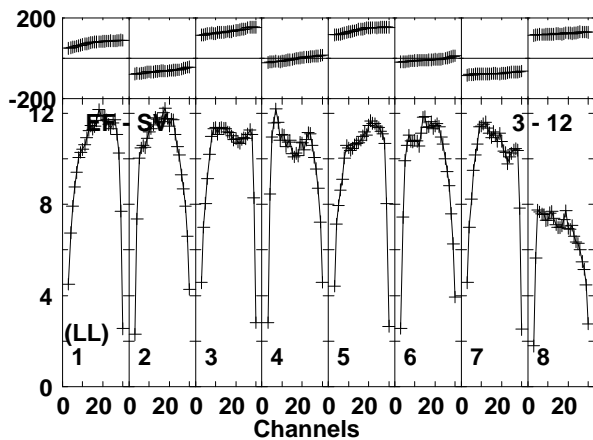
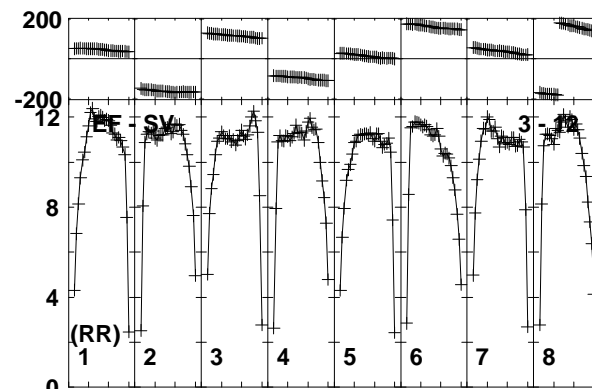
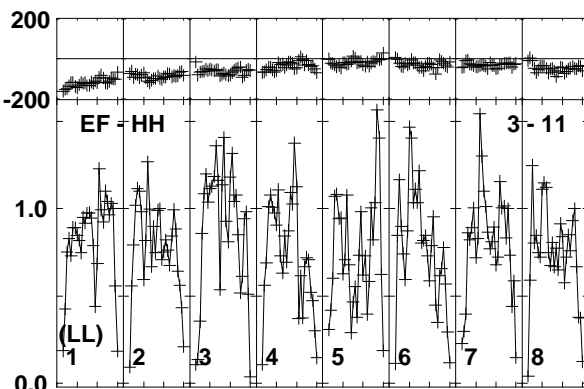
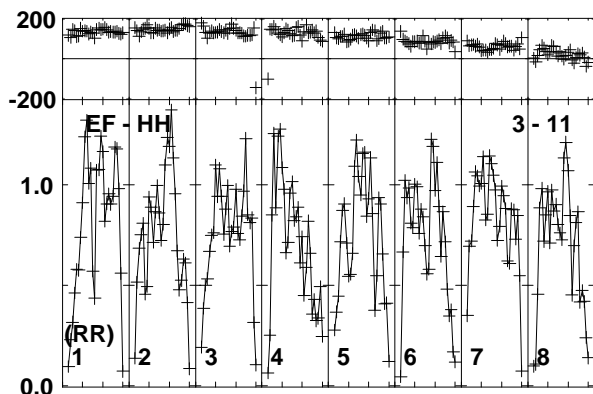
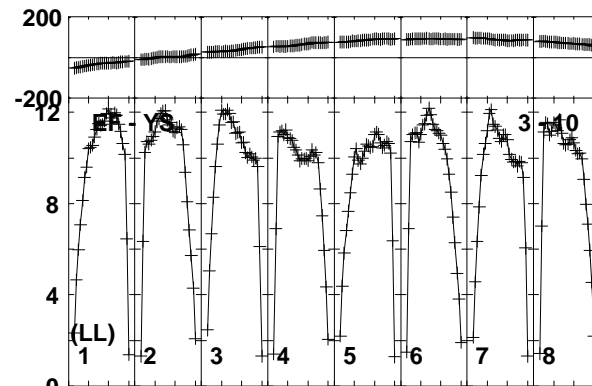
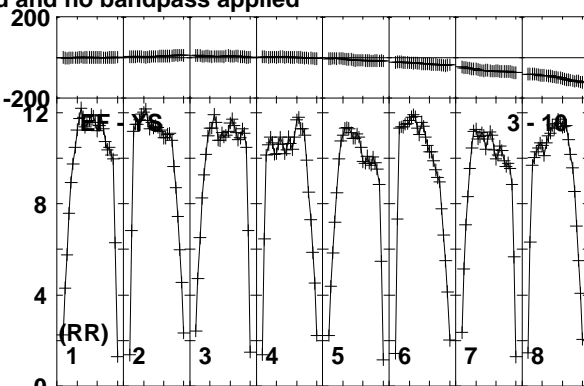
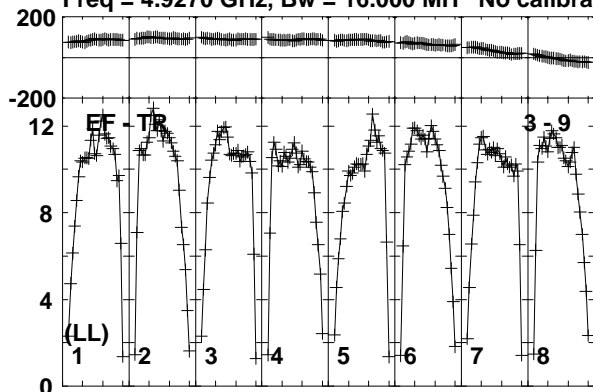

Lower frame: Milli Ampl Jy Top frame: Phas deg  
Vector averaged cross-power spectrum Baseline: EF (03) - TR (09)  
Timerange: 00/14:09:01 to 00/14:09:59

Plot file version 597 created 19-DEC-2018 17:58:56

J1619+2247 RY007C.UVDATA.1

Freq = 4.9270 GHz, Bw = 16.000 MH No calibration applied and no bandpass applied

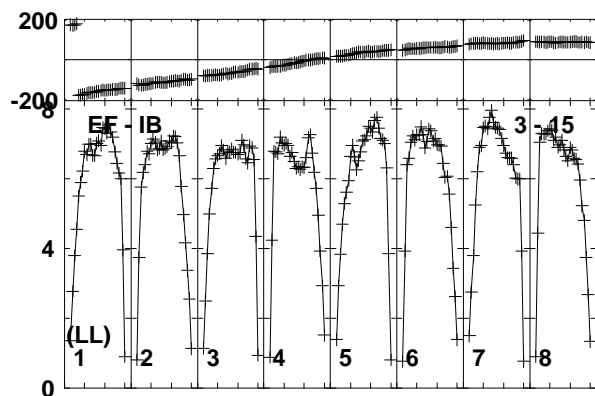
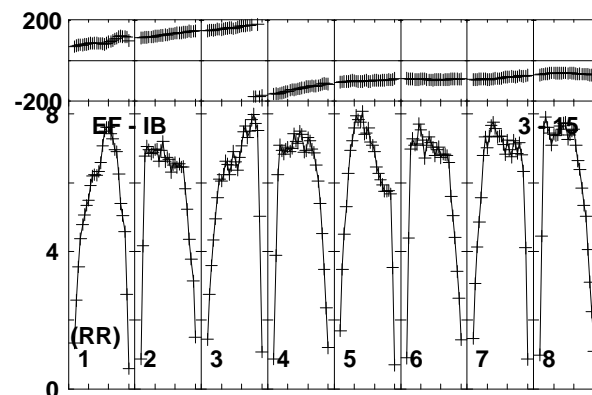
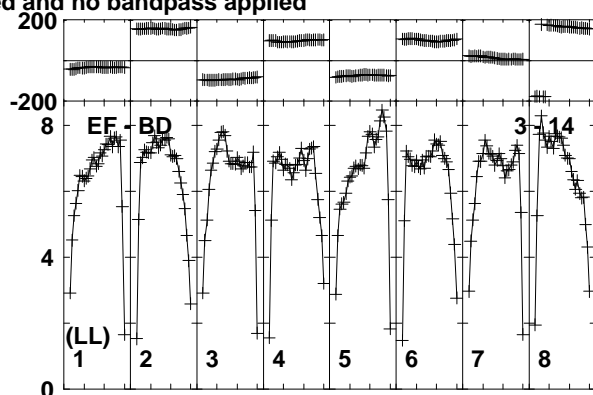
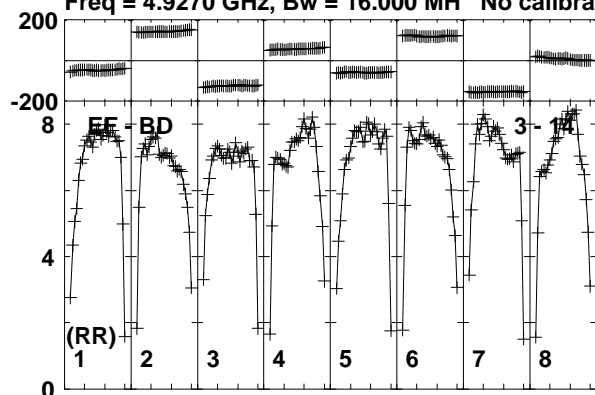

Lower frame: Milli Ampl Jy Top frame: Phas deg

Vector averaged cross-power spectrum Baseline: EF (03) - BD (14)

Timerange: 00/14:09:01 to 00/14:09:59

Plot file version 598 created 19-DEC-2018 17:58:56

AT2018\_RY007C.UVDATA.1

Freq = 4.9270 GHz, Bw = 16.000 MH No calibration applied and no bandpass applied

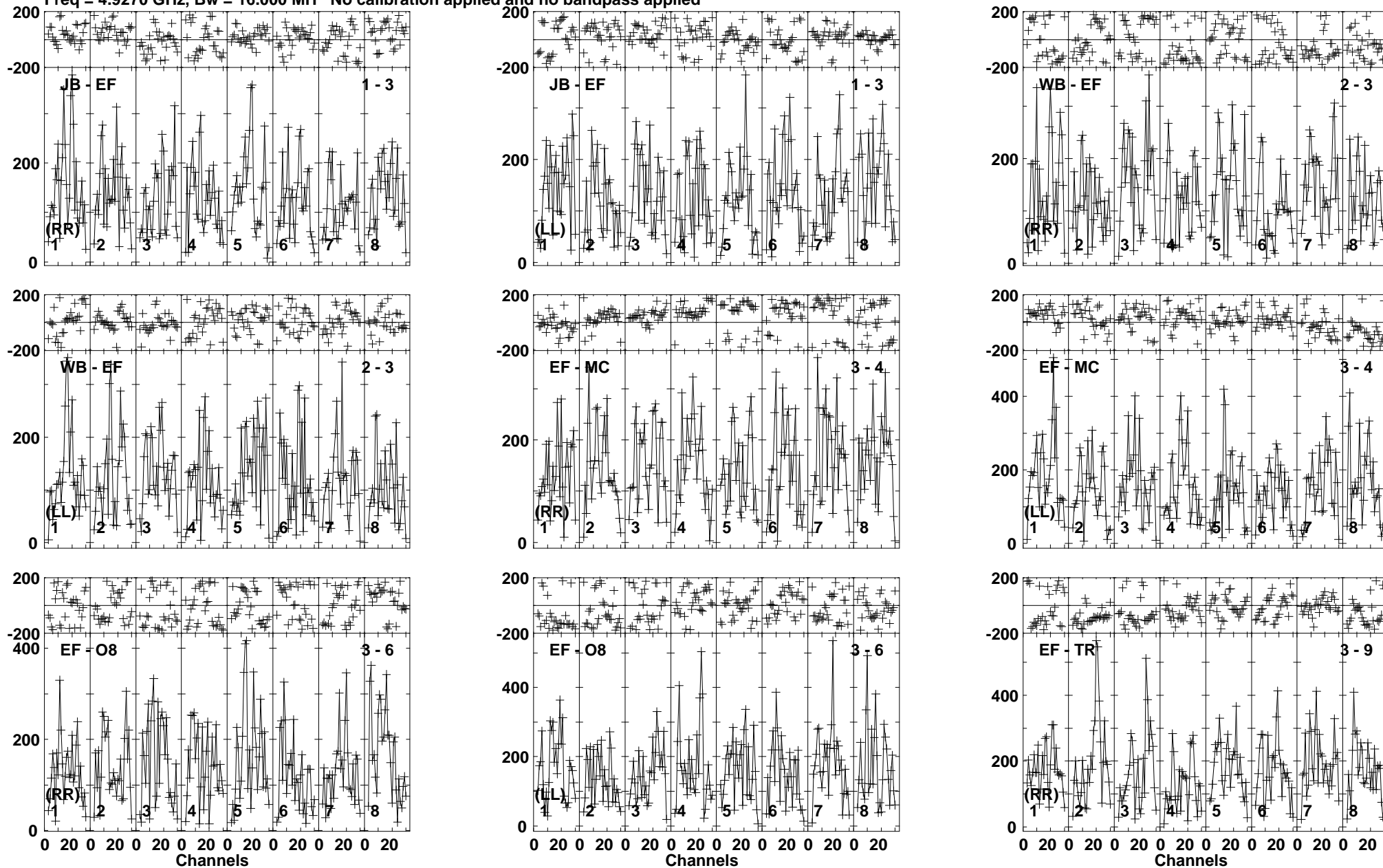

Lower frame: Micro Ampl Jy Top frame: Phas deg  
Vector averaged cross-power spectrum Baseline: JB (01) - EF (03)  
Timerange: 00/14:10:01 to 00/14:11:59

Plot file version 599 created 19-DEC-2018 17:58:56

AT2018\_RY007C.UVDATA.1

Freq = 4.9270 GHz, Bw = 16.000 MH No calibration applied and no bandpass applied

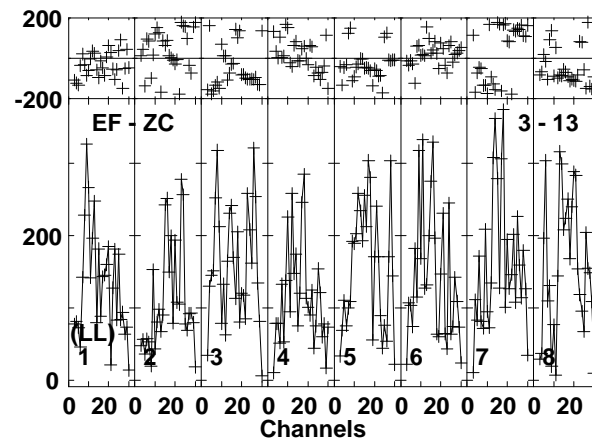
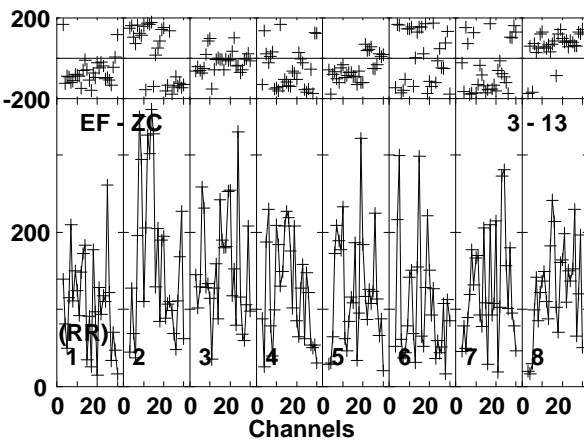
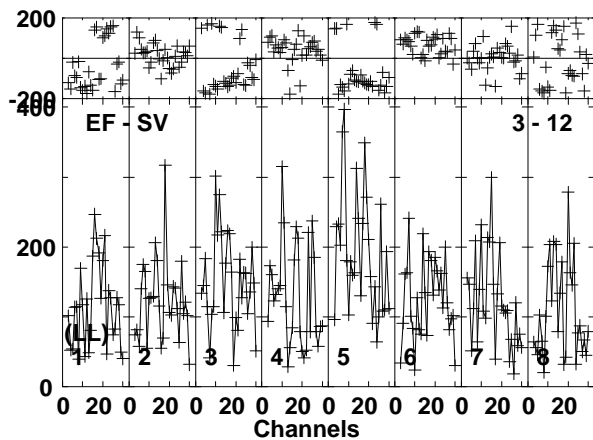
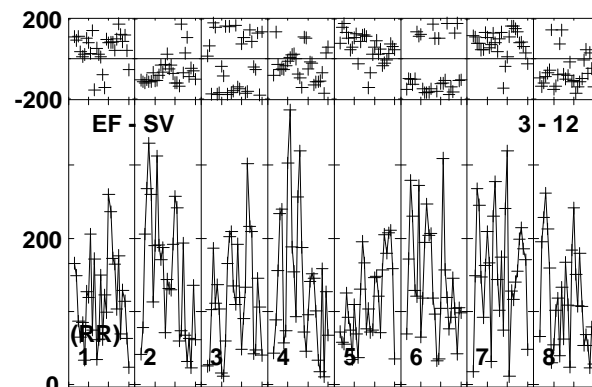
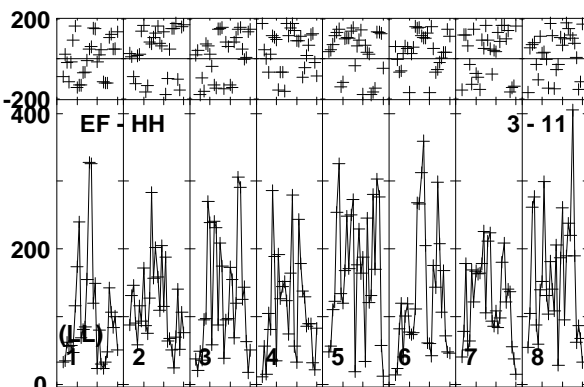
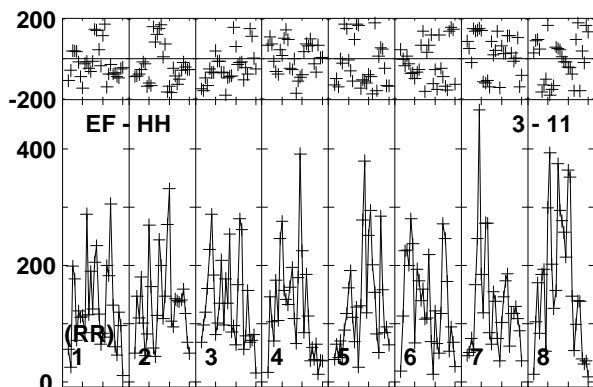
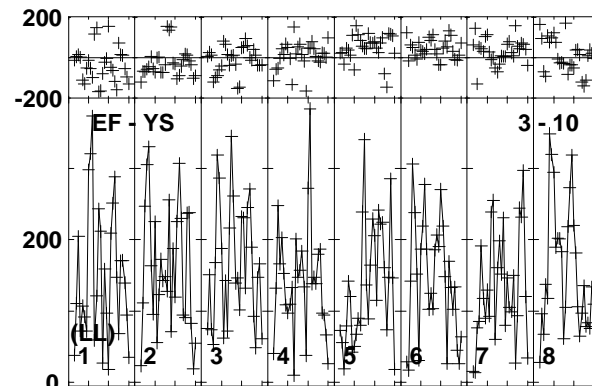
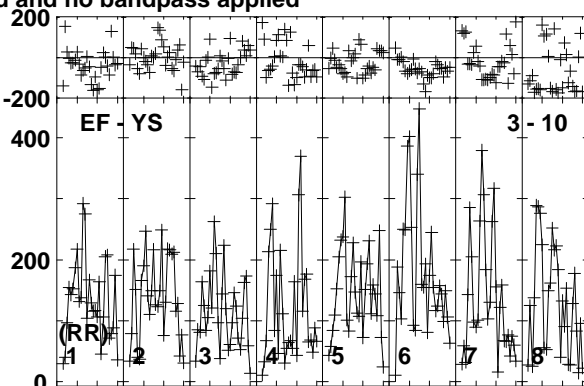
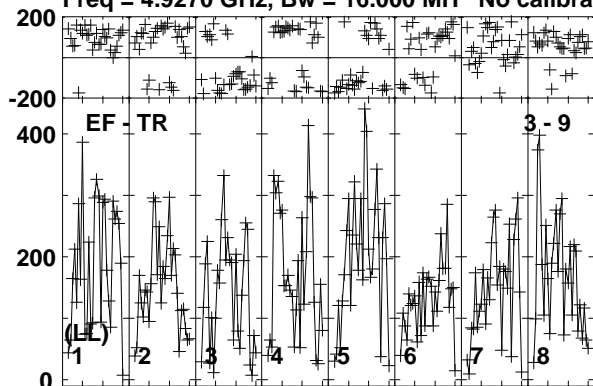

Lower frame: Micro Ampl Jy Top frame: Phas deg  
Vector averaged cross-power spectrum Baseline: EF (03) - TR (09)  
Timerange: 00/14:10:01 to 00/14:11:59

Plot file version 600 created 19-DEC-2018 17:58:56

AT2018\_RY007C.UVDATA.1

Freq = 4.9270 GHz, Bw = 16.000 MH No calibration applied and no bandpass applied

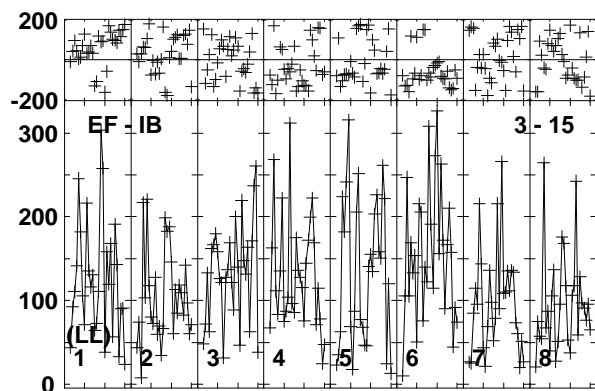
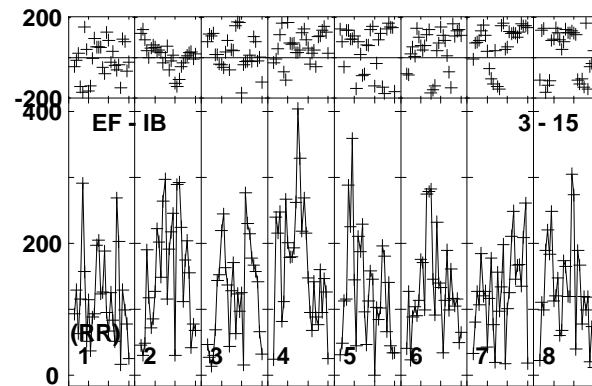
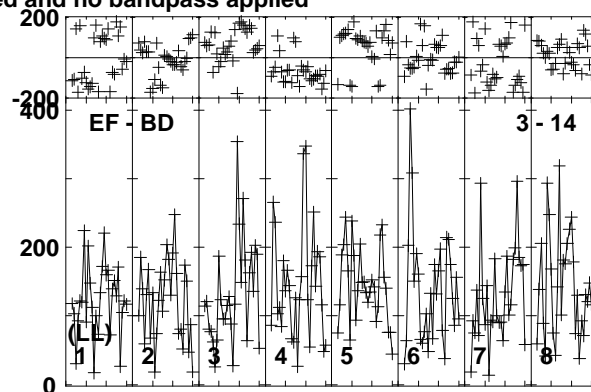
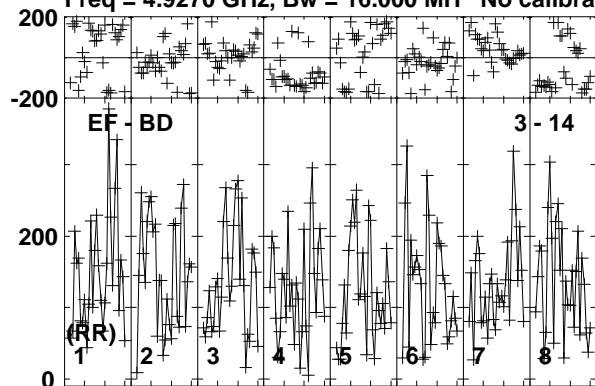

Lower frame: Micro Ampl Jy Top frame: Phas deg  
Vector averaged cross-power spectrum Baseline: EF (03) - BD (14)  
Timerange: 00/14:10:01 to 00/14:11:59

Plot file version 601 created 19-DEC-2018 17:58:56

VLA2 RY007C.UVDATA.1

Freq = 4.9270 GHz, Bw = 16.000 MH No calibration applied and no bandpass applied

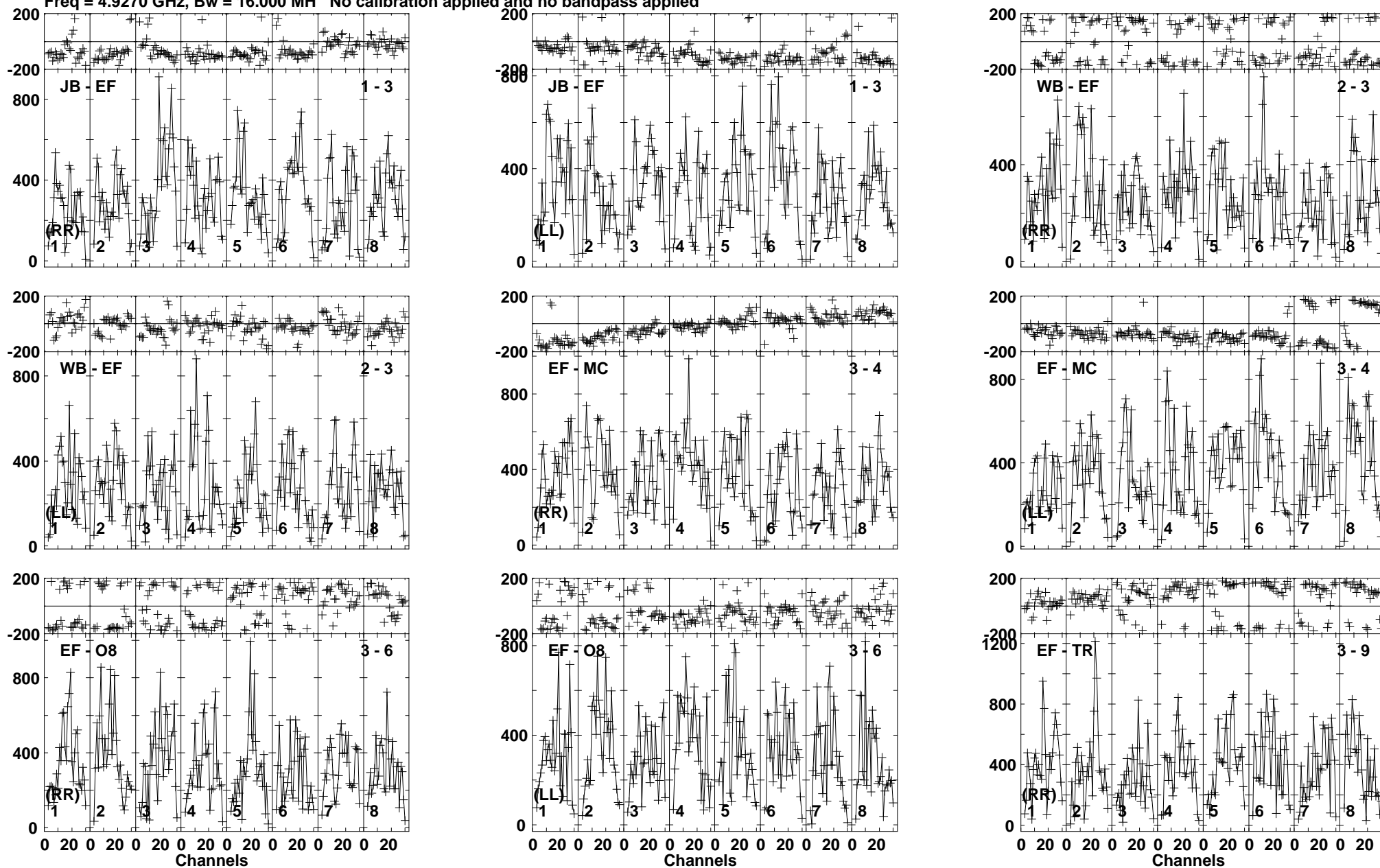

Lower frame: Micro Ampl Jy Top frame: Phas deg  
Vector averaged cross-power spectrum Baseline: JB (01) - EF (03)  
Timerange: 00/14:12:01 to 00/14:12:59

Plot file version 602 created 19-DEC-2018 17:58:56

VLA2 RY007C.UVDATA.1

Freq = 4.9270 GHz, Bw = 16.000 MH No calibration applied and no bandpass applied

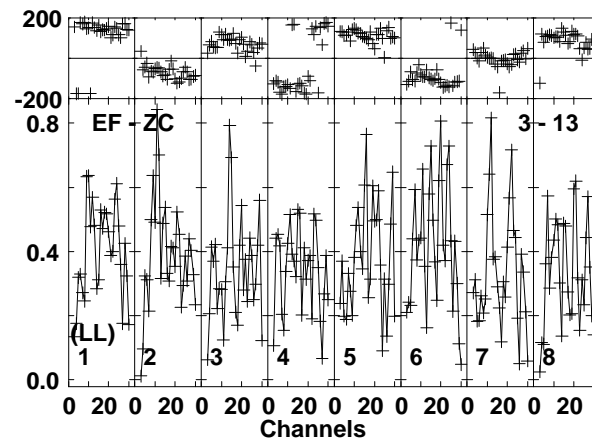
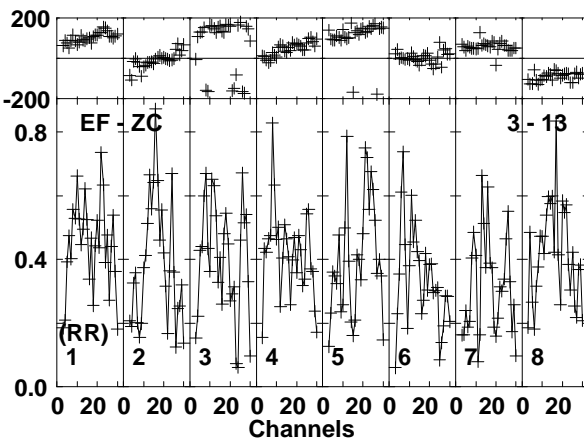
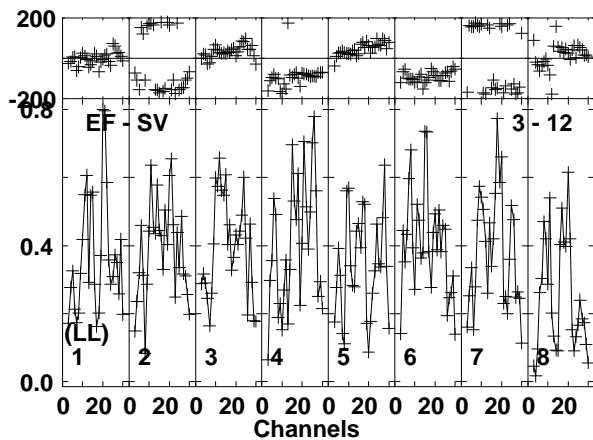
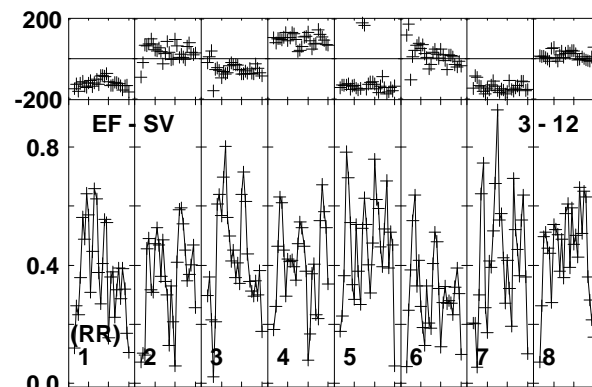
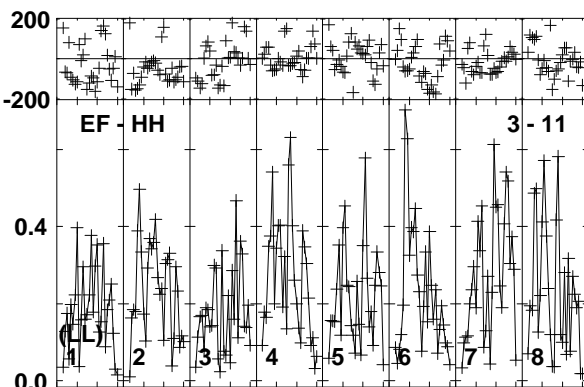
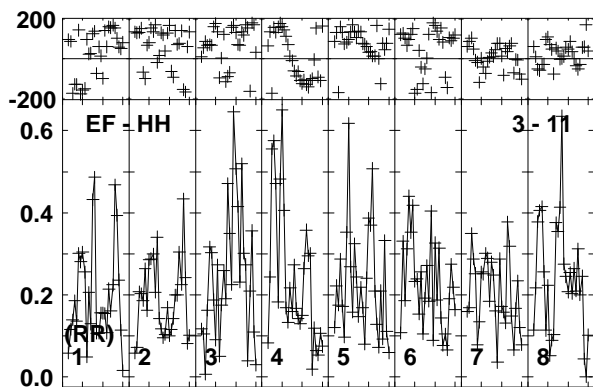
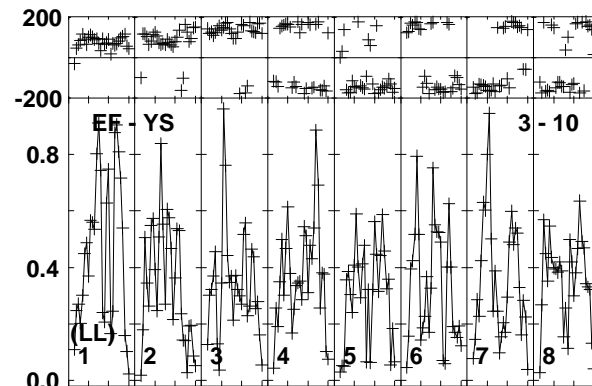
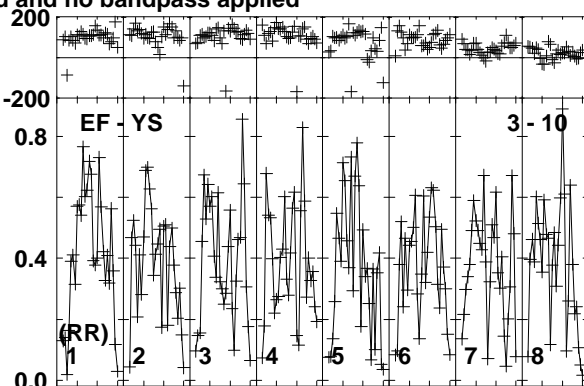
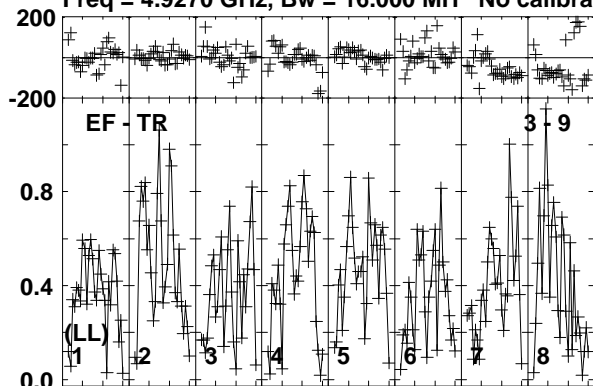

Lower frame: Milli Ampl Jy Top frame: Phas deg  
Vector averaged cross-power spectrum Baseline: EF (03) - TR (09)  
Timerange: 00/14:12:01 to 00/14:12:59



Plot file version 603 created 19-DEC-2018 17:58:56

VLA2 RY007C.UVDATA.1

Freq = 4.9270 GHz, Bw = 16.000 MH No calibration applied and no bandpass applied

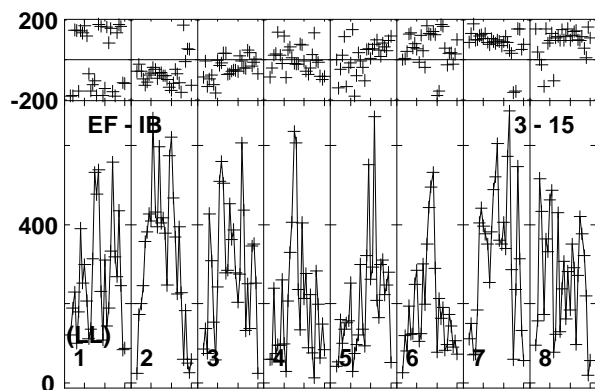
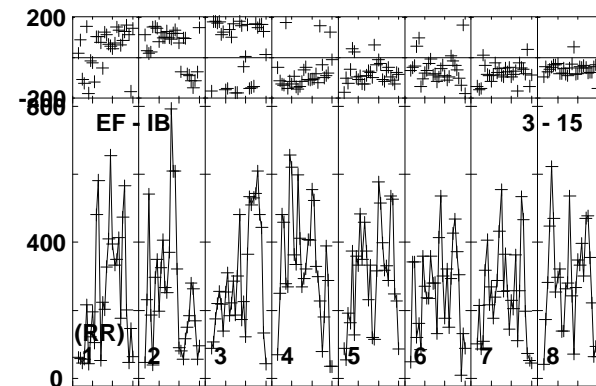
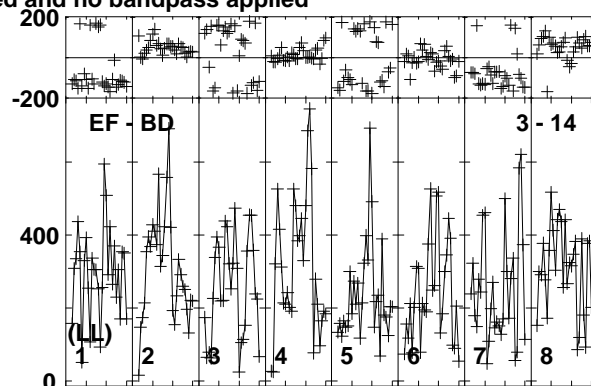
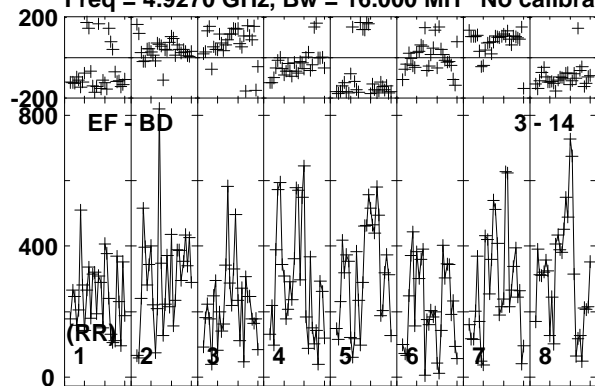

Lower frame: Micro Ampl Jy Top frame: Phas deg  
Vector averaged cross-power spectrum Baseline: EF (03) - BD (14)  
Timerange: 00/14:12:01 to 00/14:12:59

Plot file version 604 created 19-DEC-2018 17:58:56

J1619+2247 RY007C.UVDATA.1

Freq = 4.9270 GHz, Bw = 16.000 MH No calibration applied and no bandpass applied

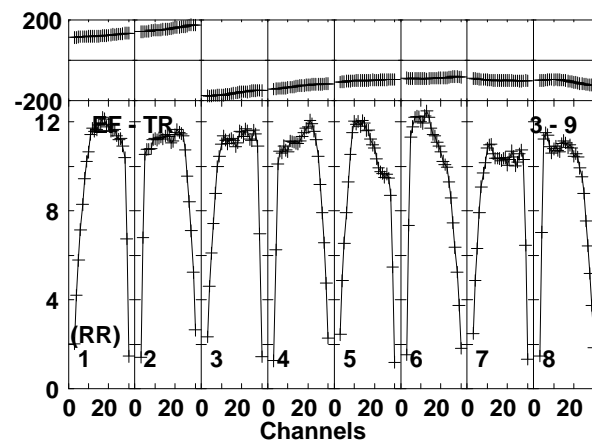
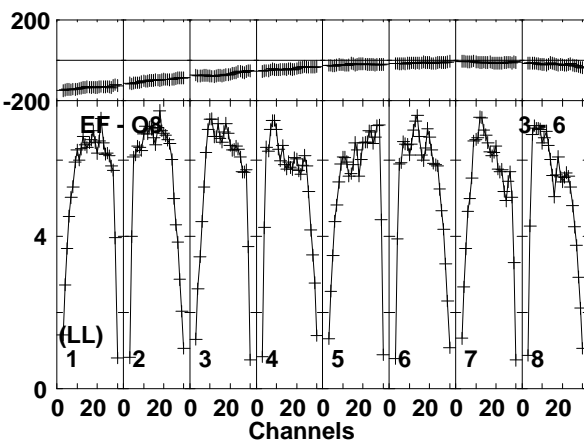
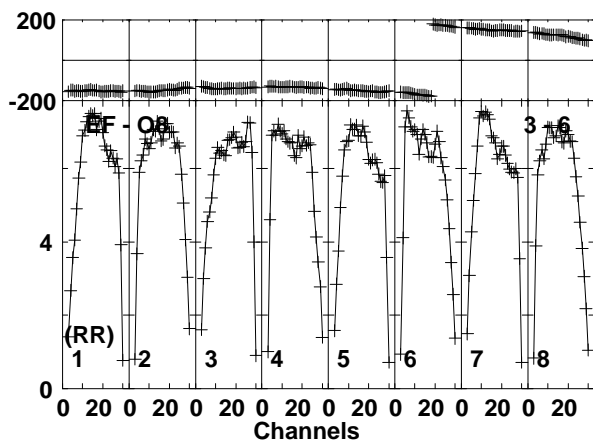
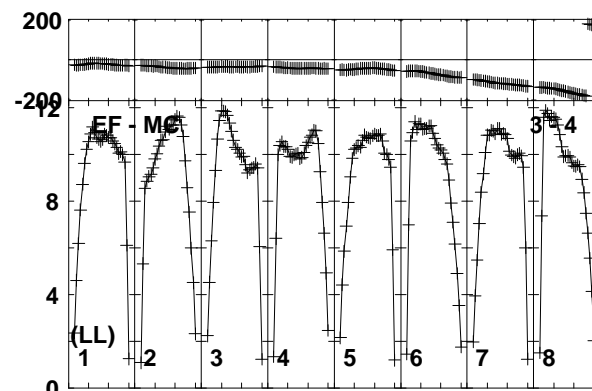
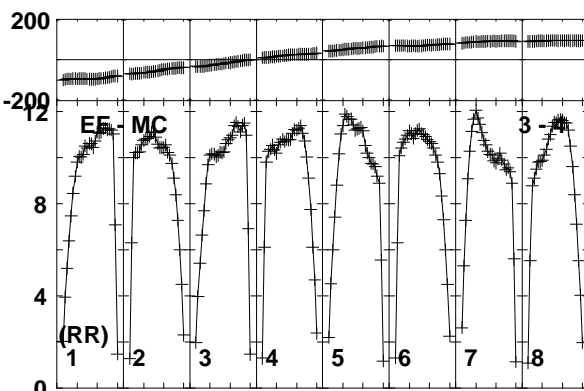
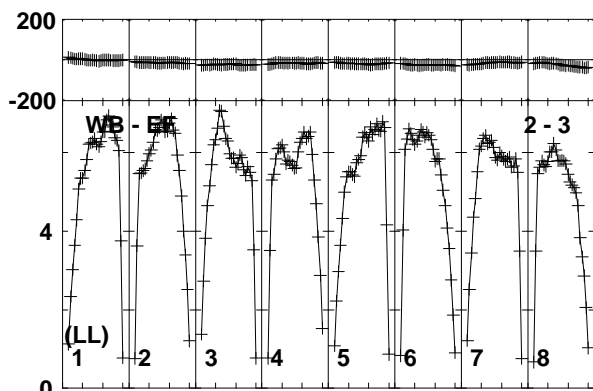
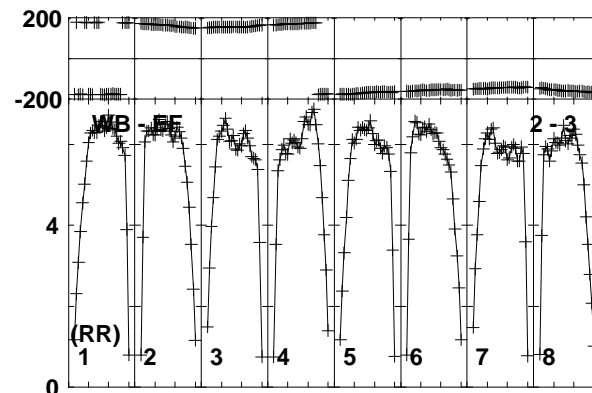
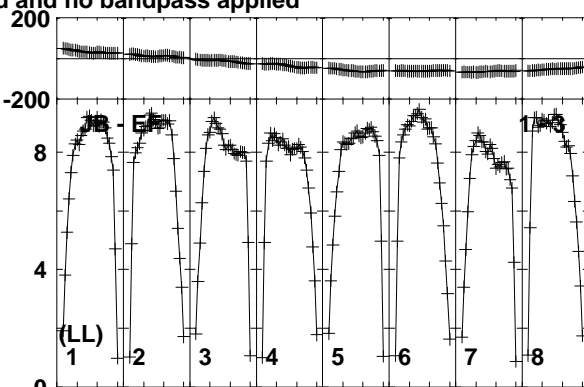
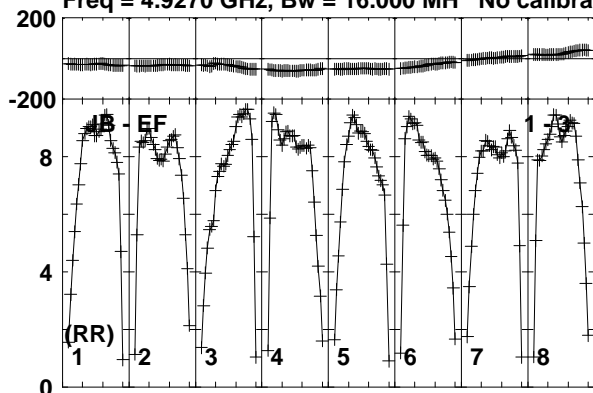

Lower frame: Milli Ampl Jy Top frame: Phas deg  
Vector averaged cross-power spectrum Baseline: JB (01) - EF (03)  
Timerange: 00/14:13:31 to 00/14:14:29

Plot file version 605 created 19-DEC-2018 17:58:56

J1619+2247 RY007C.UVDATA.1

Freq = 4.9270 GHz, Bw = 16.000 MH No calibration applied and no bandpass applied

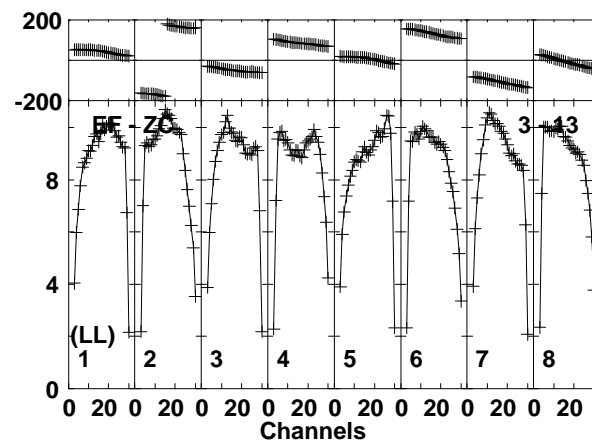
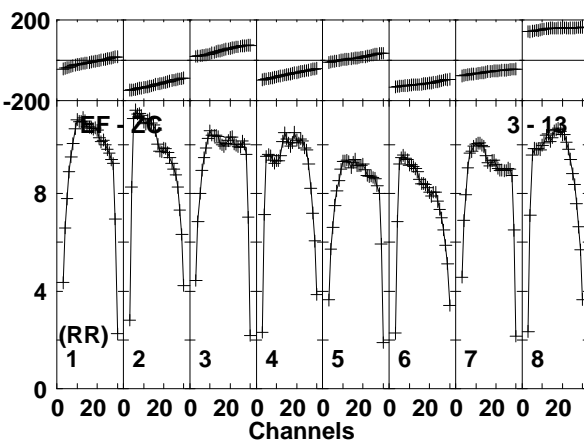
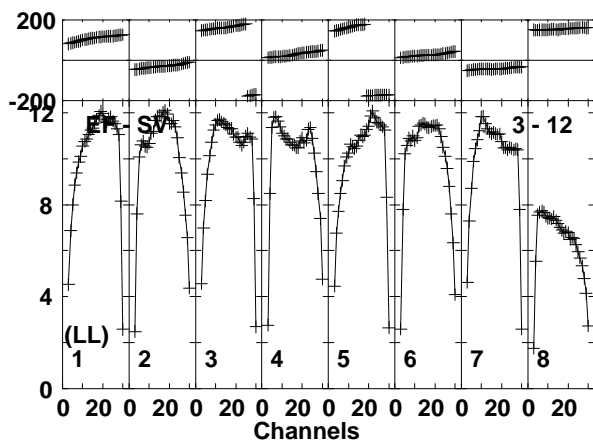
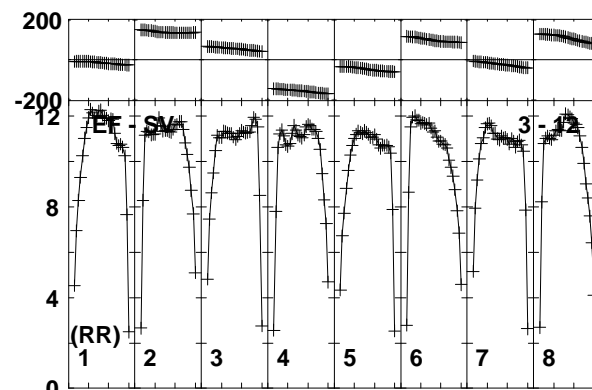
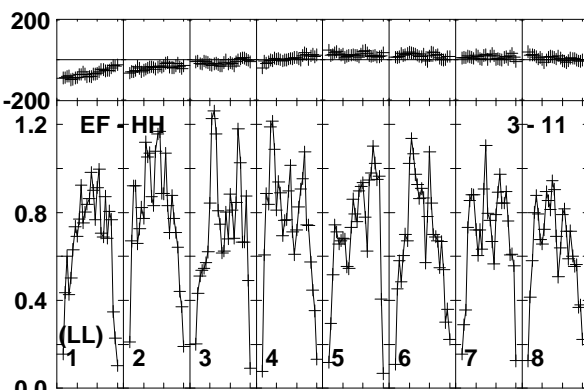
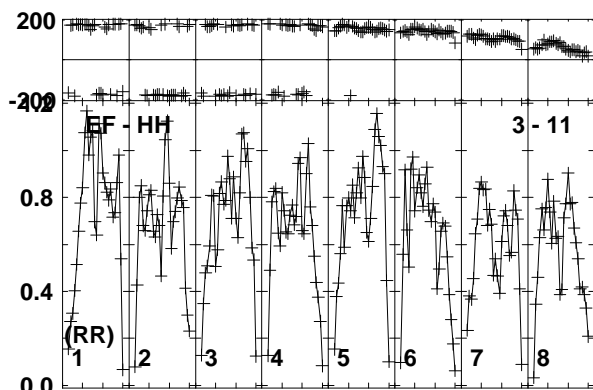
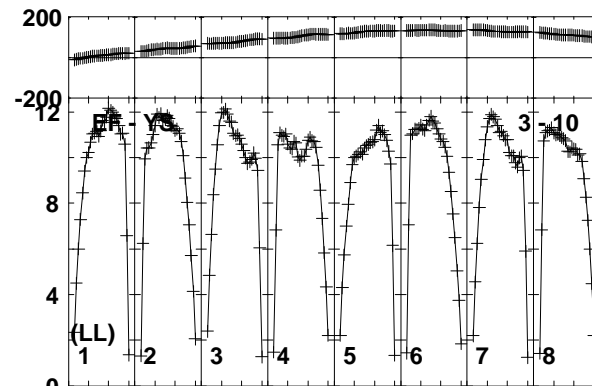
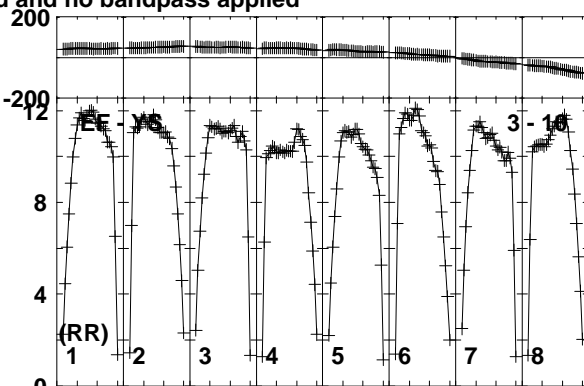
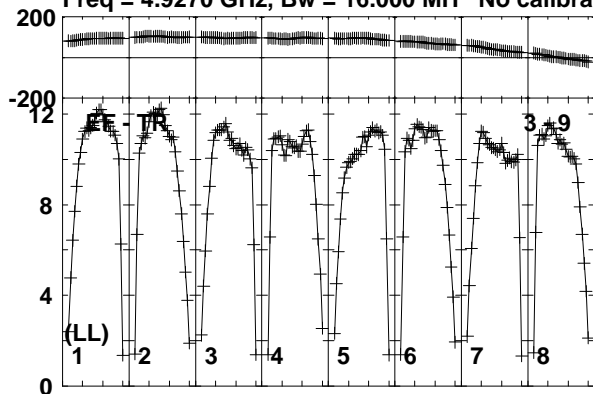

Lower frame: Milli Ampl Jy Top frame: Phas deg  
Vector averaged cross-power spectrum Baseline: EF (03) - TR (09)  
Timerange: 00/14:13:31 to 00/14:14:29

Plot file version 606 created 19-DEC-2018 17:58:57

J1619+2247 RY007C.UVDATA.1

Freq = 4.9270 GHz, Bw = 16.000 MH No calibration applied and no bandpass applied

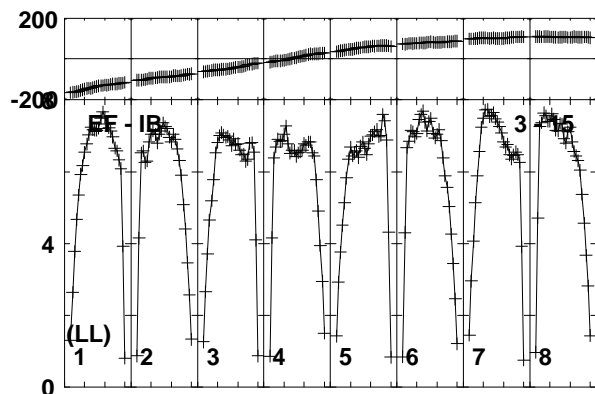
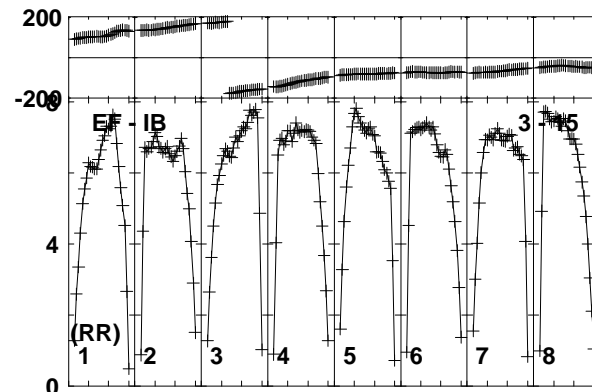
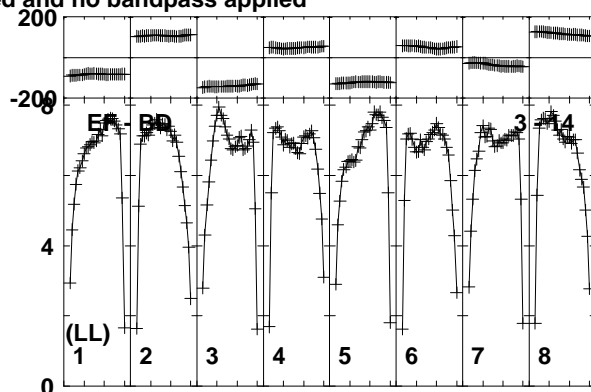
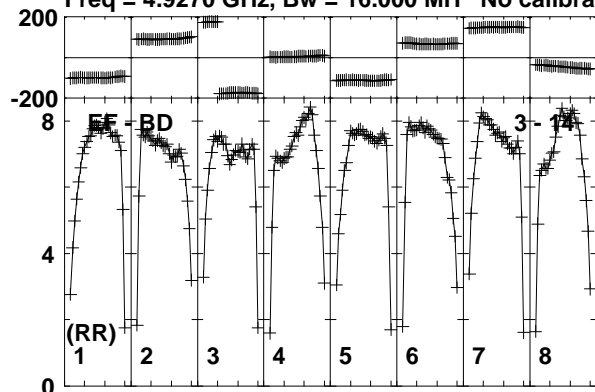

Lower frame: Milli Ampl Jy Top frame: Phas deg  
Vector averaged cross-power spectrum Baseline: EF (03) - BD (14)  
Timerange: 00/14:13:31 to 00/14:14:29

Plot file version 607 created 19-DEC-2018 17:58:57

AT2018\_RY007C.UVDATA.1

Freq = 4.9270 GHz, Bw = 16.000 MH No calibration applied and no bandpass applied

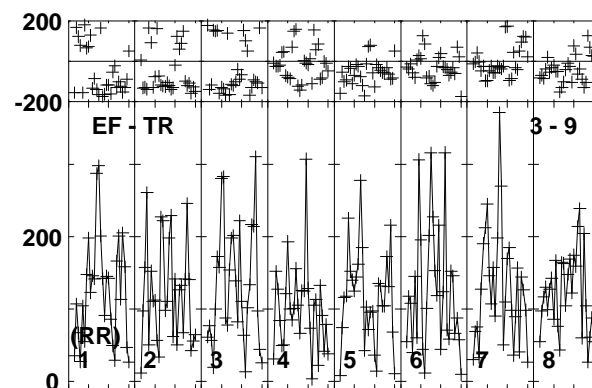
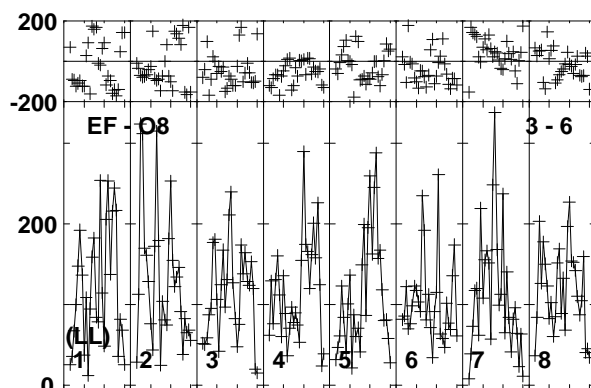
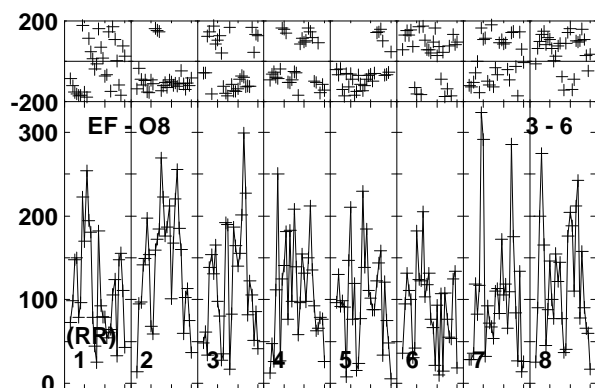
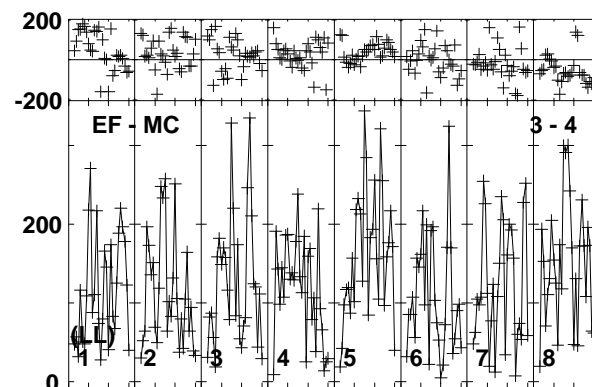
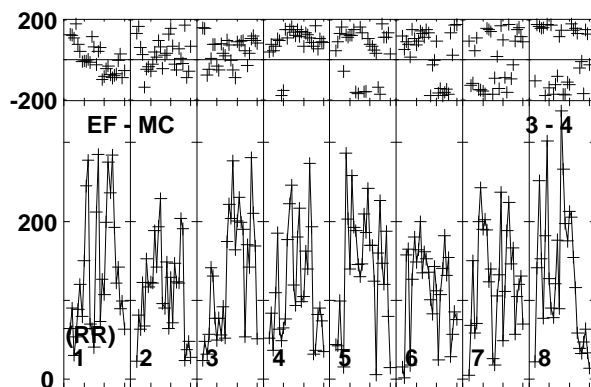
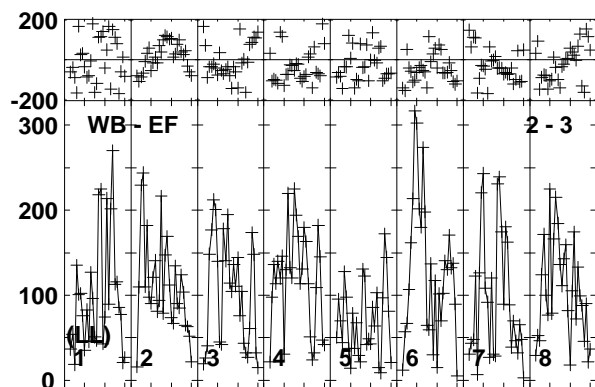
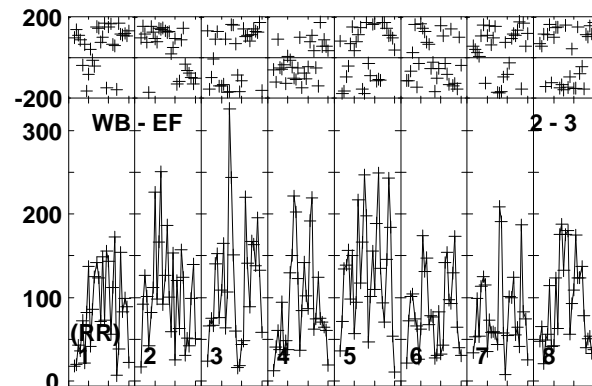
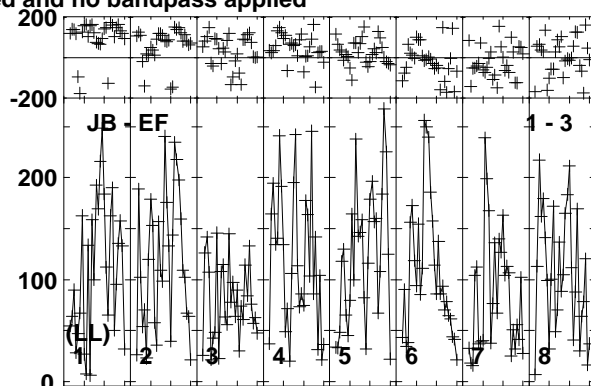
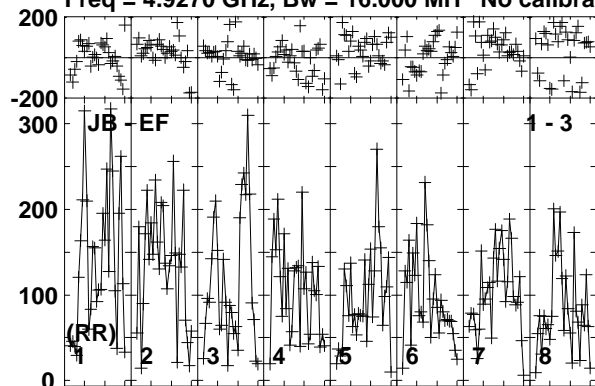

Lower frame: Micro Ampl Jy Top frame: Phas deg  
Vector averaged cross-power spectrum Baseline: JB (01) - EF (03)  
Timerange: 00/14:14:31 to 00/14:17:29

Plot file version 608 created 19-DEC-2018 17:58:57

AT2018\_RY007C.UVDATA.1

Freq = 4.9270 GHz, Bw = 16.000 MH No calibration applied and no bandpass applied

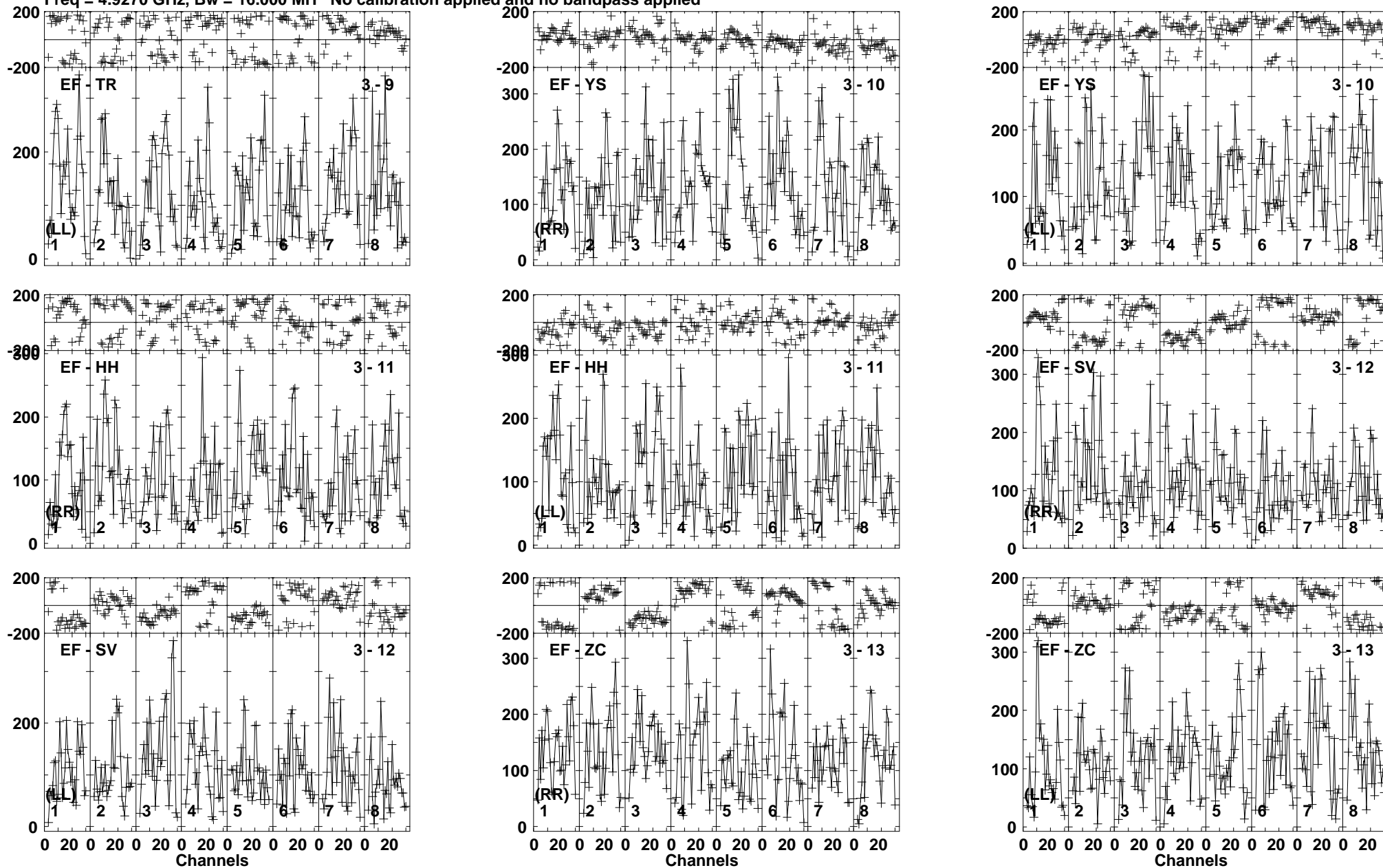

Lower frame: Micro Ampl Jy Top frame: Phas deg  
Vector averaged cross-power spectrum Baseline: EF (03) - TR (09)  
Timerange: 00/14:14:31 to 00/14:17:29

Plot file version 609 created 19-DEC-2018 17:58:57

AT2018\_RY007C.UVDATA.1

Freq = 4.9270 GHz, Bw = 16.000 MH No calibration applied and no bandpass applied

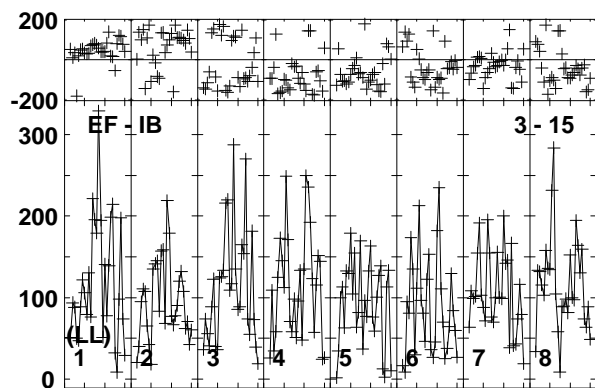
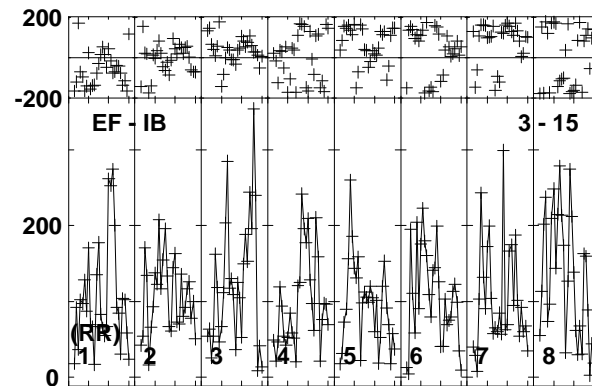
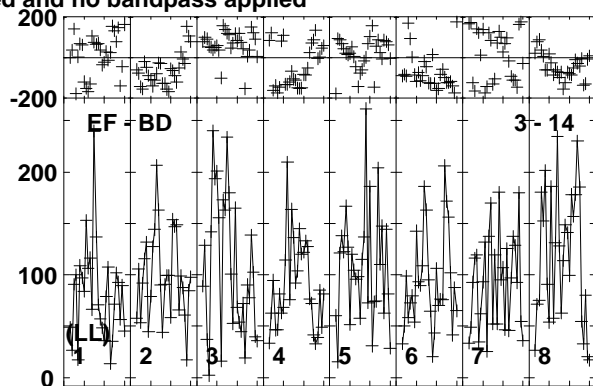
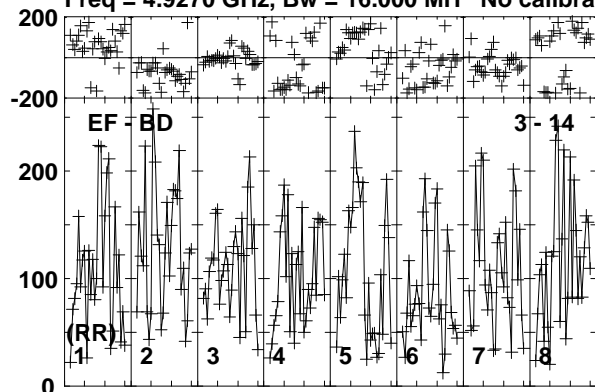

Lower frame: Micro Ampl Jy Top frame: Phas deg  
Vector averaged cross-power spectrum Baseline: EF (03) - BD (14)  
Timerange: 00/14:14:31 to 00/14:17:29

Plot file version 610 created 19-DEC-2018 17:58:57

J1619+2247 RY007C.UVDATA.1

Freq = 4.9270 GHz, Bw = 16.000 MH No calibration applied and no bandpass applied

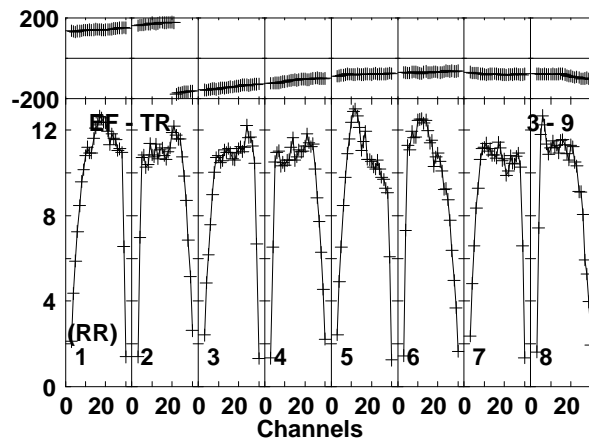
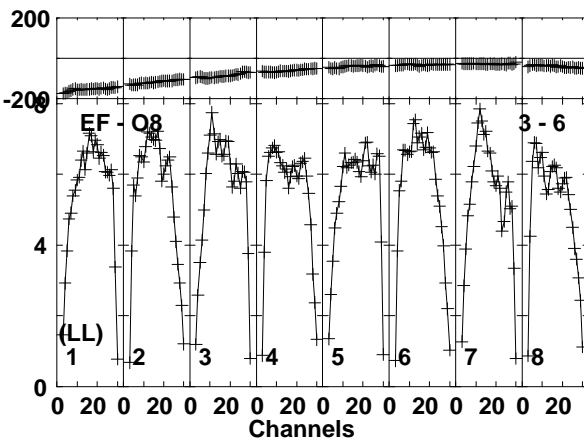
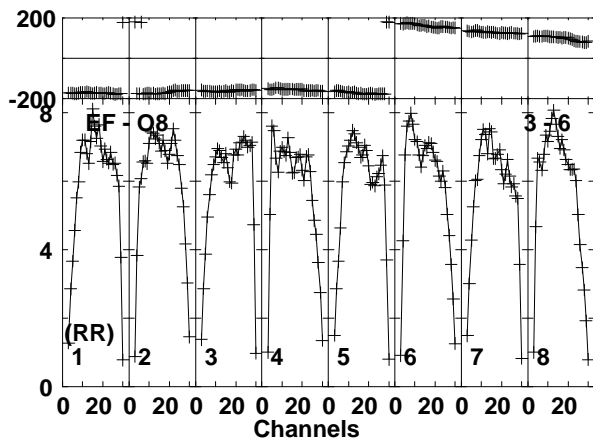
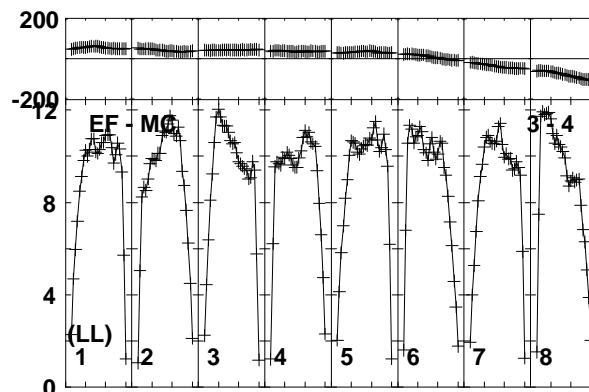
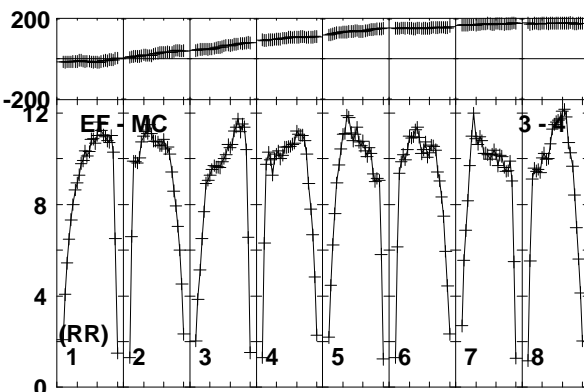
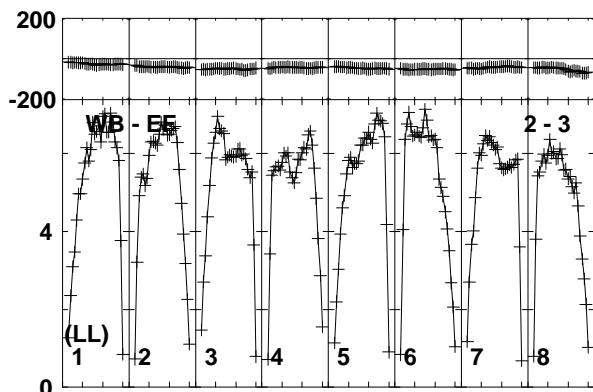
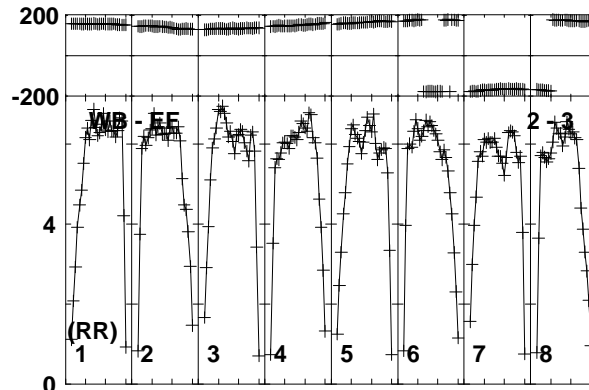
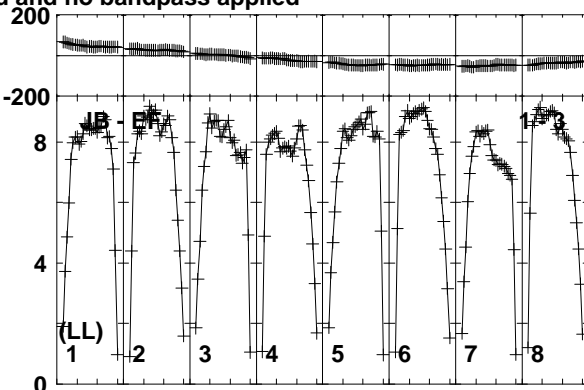
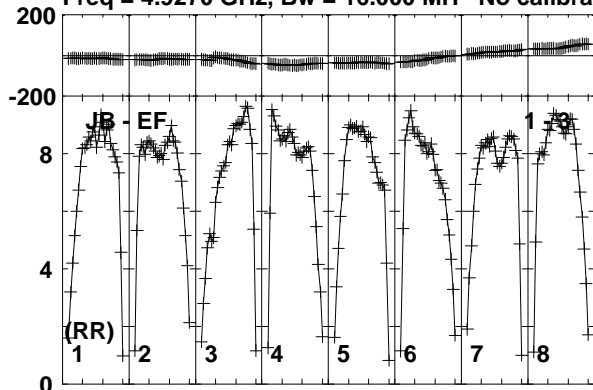

Lower frame: Milli Ampl Jy Top frame: Phas deg  
Vector averaged cross-power spectrum Baseline: JB (01) - EF (03)  
Timerange: 00/14:17:31 to 00/14:18:29



Plot file version 611 created 19-DEC-2018 17:58:57

J1619+2247 RY007C.UVDATA.1

Freq = 4.9270 GHz, Bw = 16.000 MH No calibration applied and no bandpass applied

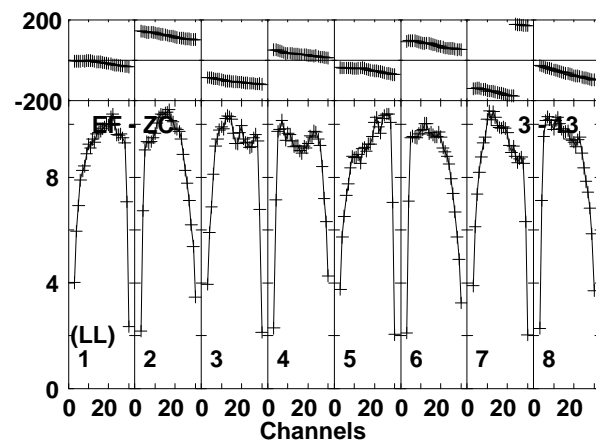
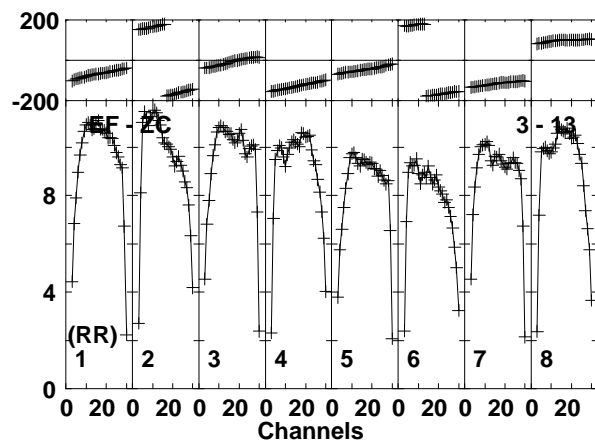
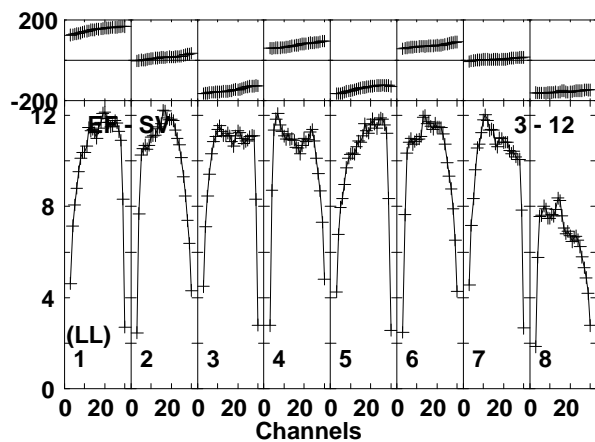
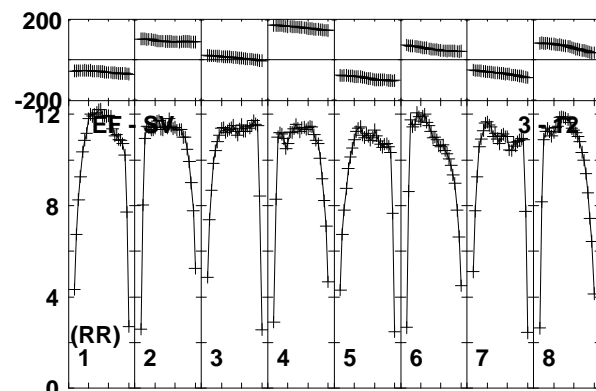
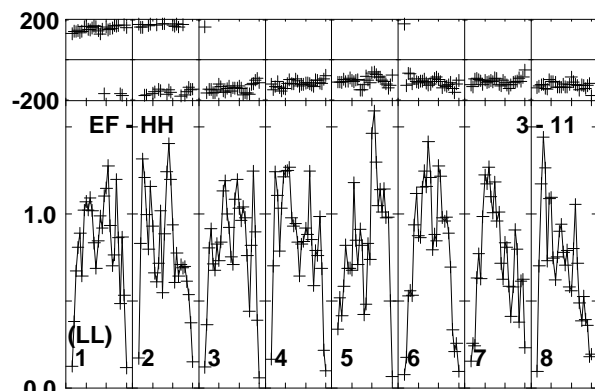
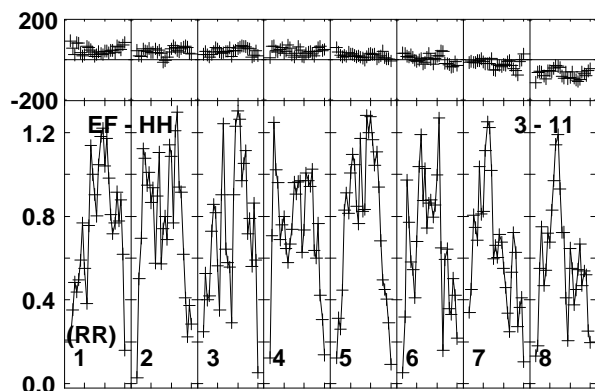
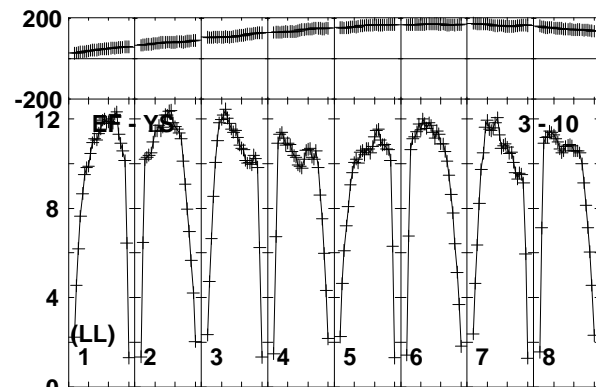
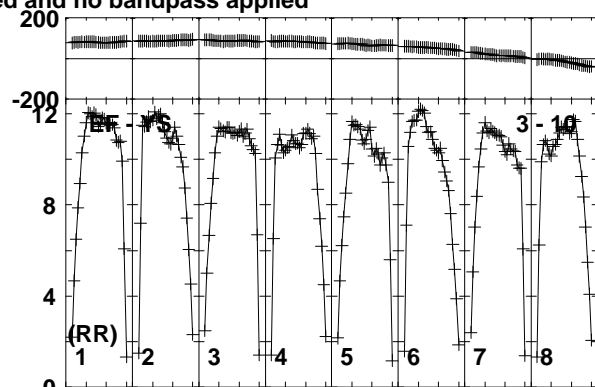
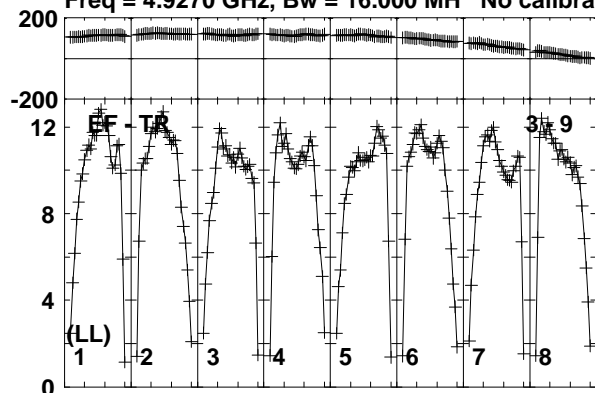

Lower frame: Milli Ampl Jy Top frame: Phas deg  
Vector averaged cross-power spectrum Baseline: EF (03) - TR (09)  
Timerange: 00/14:17:31 to 00/14:18:29

Plot file version 612 created 19-DEC-2018 17:58:57

J1619+2247 RY007C.UVDATA.1

Freq = 4.9270 GHz, Bw = 16.000 MH No calibration applied and no bandpass applied

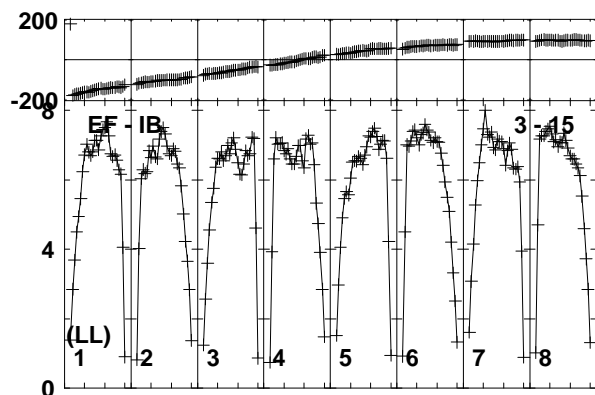
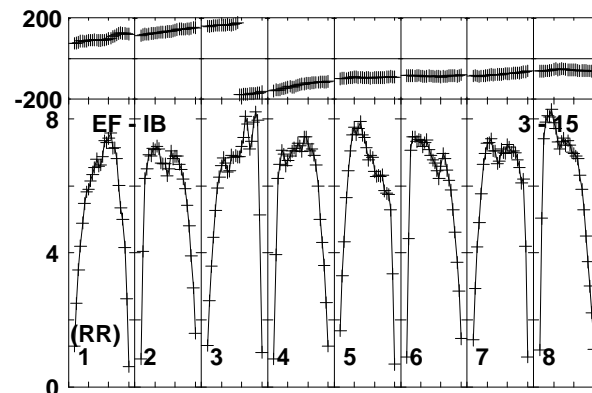
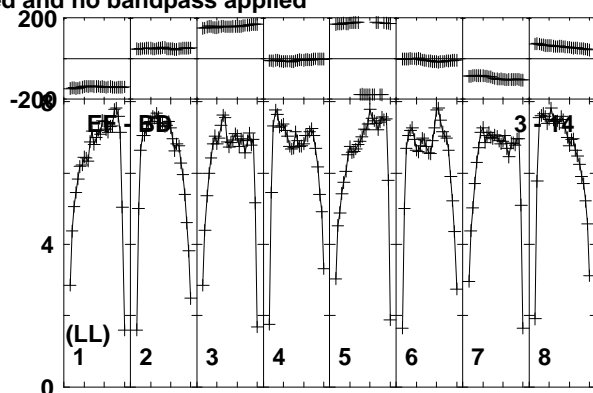
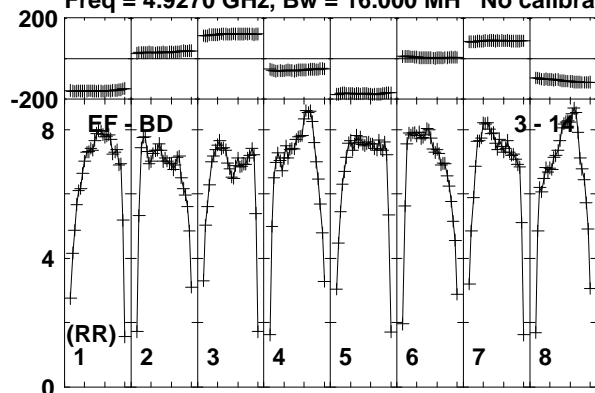

Lower frame: Milli Ampl Jy Top frame: Phas deg  
Vector averaged cross-power spectrum Baseline: EF (03) - BD (14)  
Timerange: 00/14:17:31 to 00/14:18:29

Plot file version 613 created 19-DEC-2018 17:58:57

AT2018\_RY007C.UVDATA.1

Freq = 4.9270 GHz, Bw = 16.000 MH No calibration applied and no bandpass applied

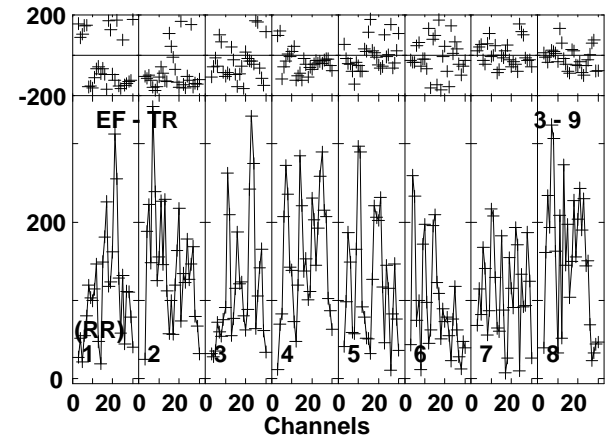
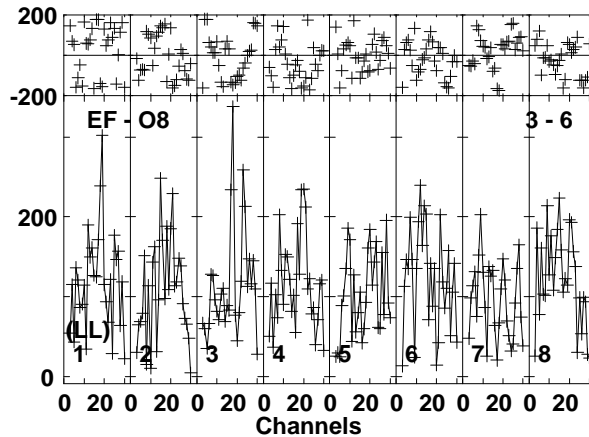
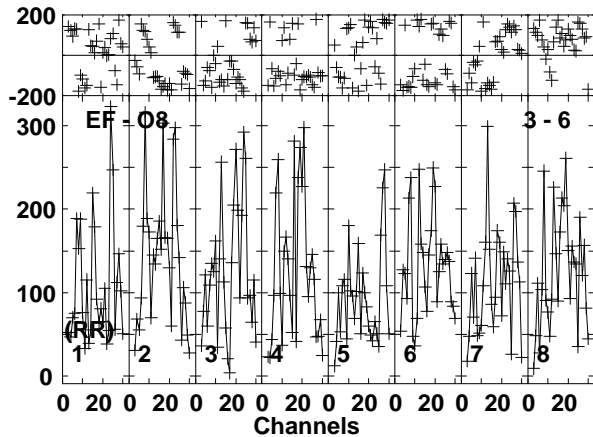
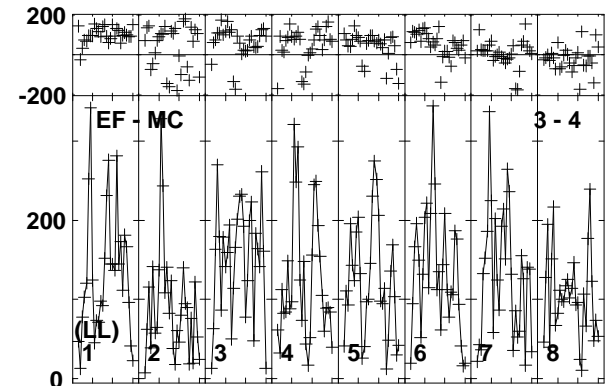
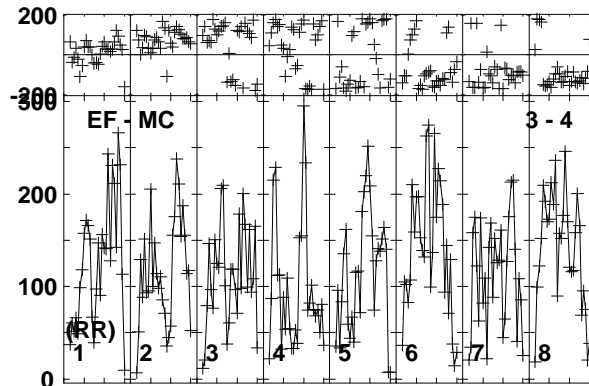
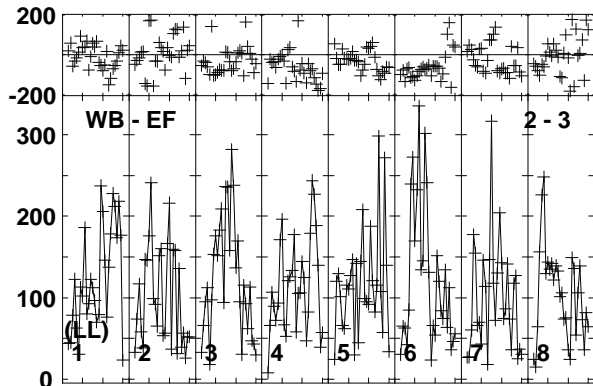
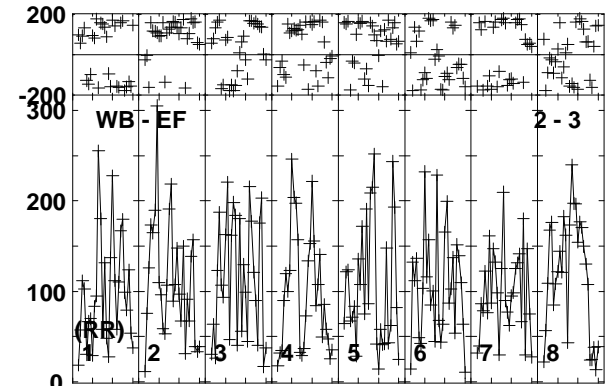
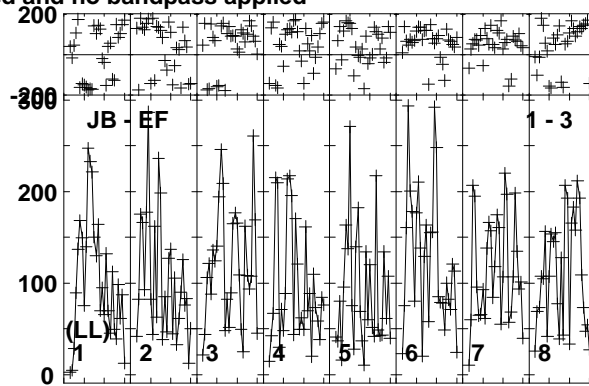
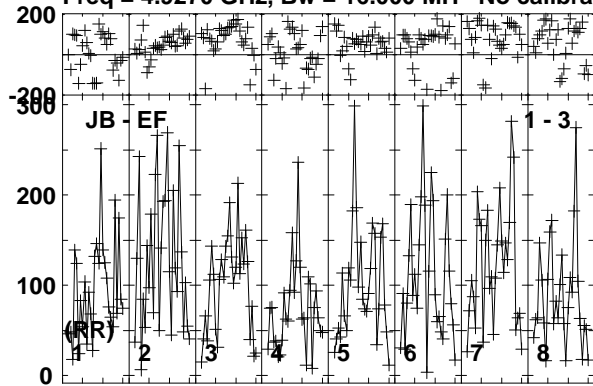

Lower frame: Micro Ampl Jy Top frame: Phas deg  
Vector averaged cross-power spectrum Baseline: JB (01) - EF (03)  
Timerange: 00/14:18:31 to 00/14:21:29

Plot file version 614 created 19-DEC-2018 17:58:57

AT2018\_RY007C.UVDATA.1

Freq = 4.9270 GHz, Bw = 16.000 MH No calibration applied and no bandpass applied

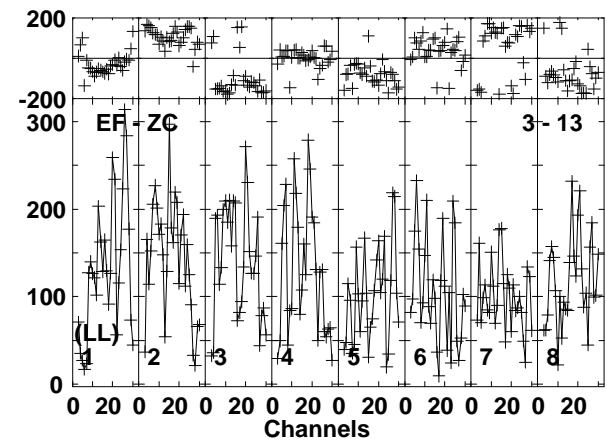
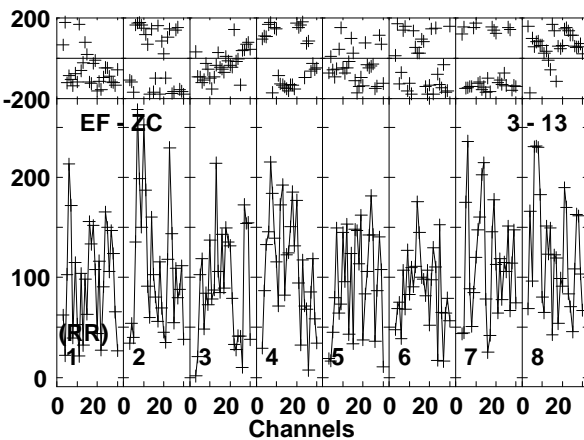
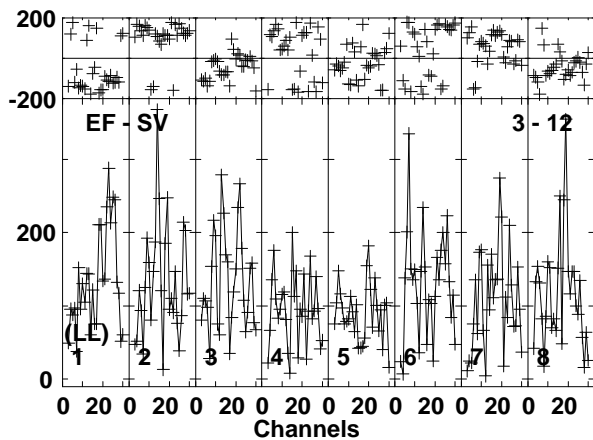
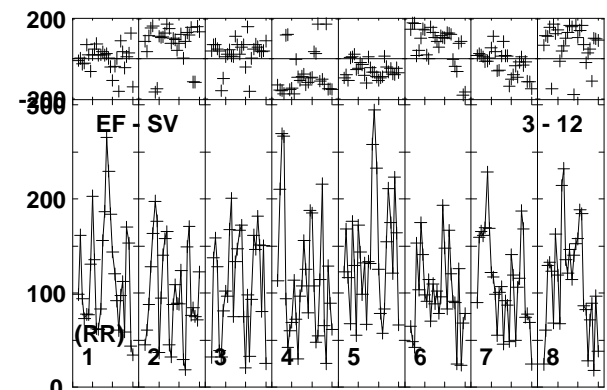
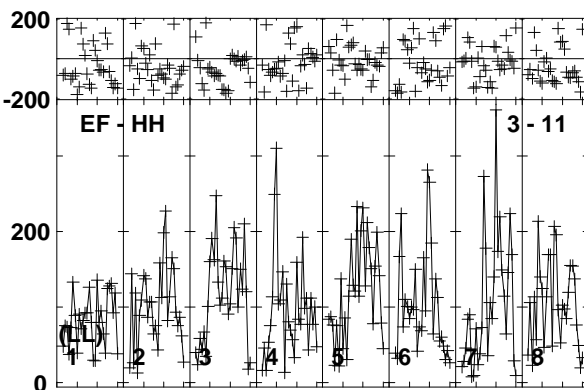
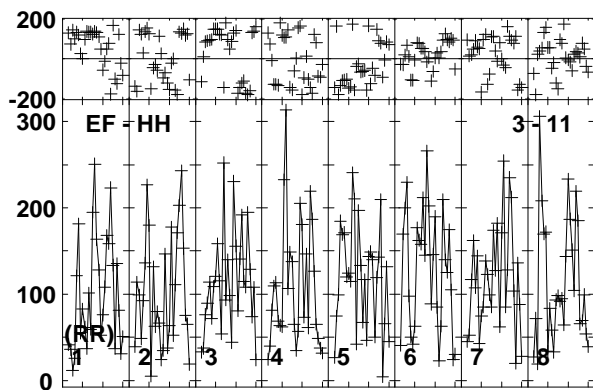
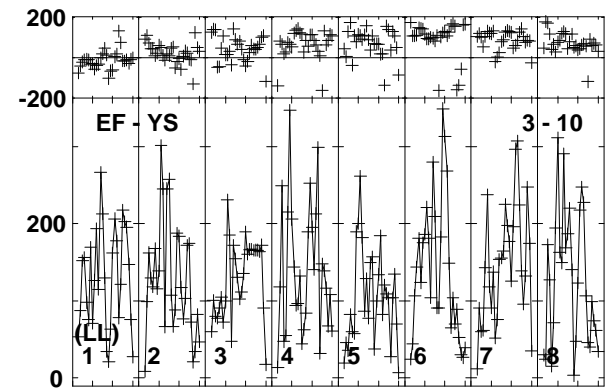
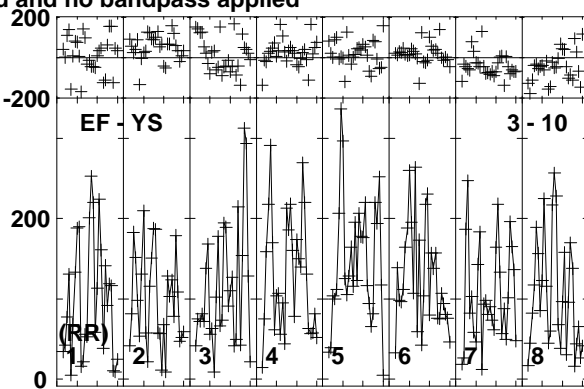
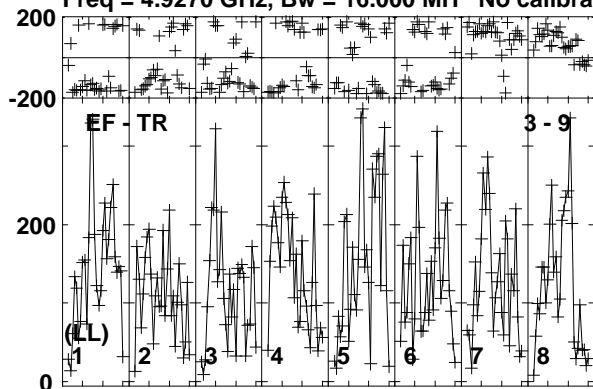

Lower frame: Micro Ampl Jy Top frame: Phas deg  
Vector averaged cross-power spectrum Baseline: EF (03) - TR (09)  
Timerange: 00/14:18:31 to 00/14:21:29

Plot file version 615 created 19-DEC-2018 17:58:57

AT2018\_RY007C.UVDATA.1

Freq = 4.9270 GHz, Bw = 16.000 MH No calibration applied and no bandpass applied

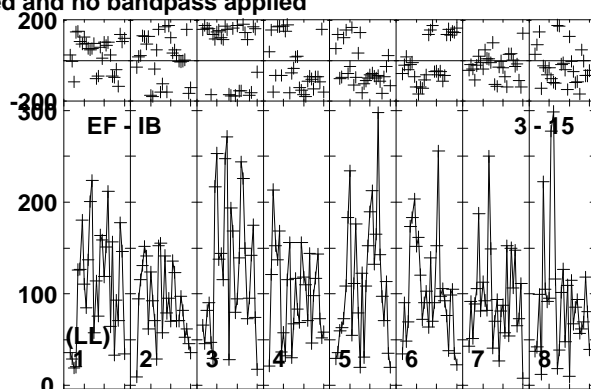
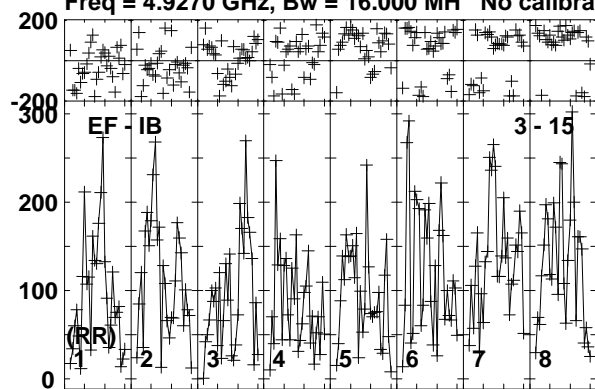

Lower frame: Micro Ampl Jy Top frame: Phas deg  
Vector averaged cross-power spectrum Baseline: EF (03) - IB (15)  
Timerange: 00/14:18:31 to 00/14:21:29

Plot file version 616 created 19-DEC-2018 17:58:57

J1619+2247 RY007C.UVDATA.1

Freq = 4.9270 GHz, Bw = 16.000 MH No calibration applied and no bandpass applied

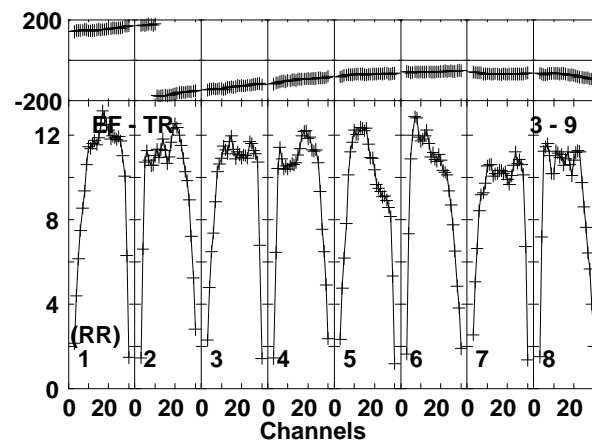
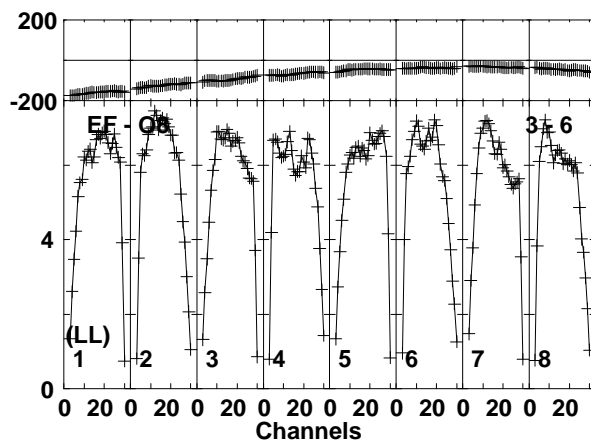
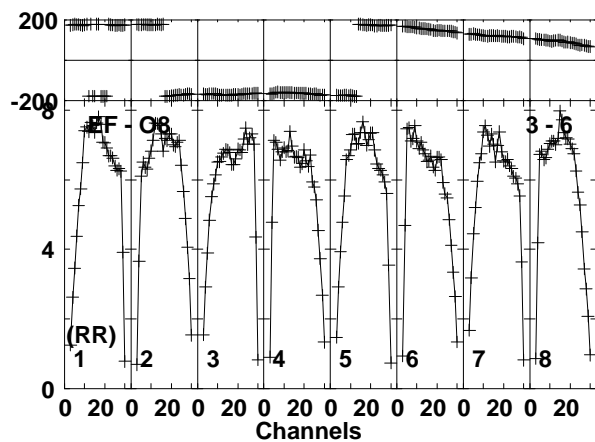
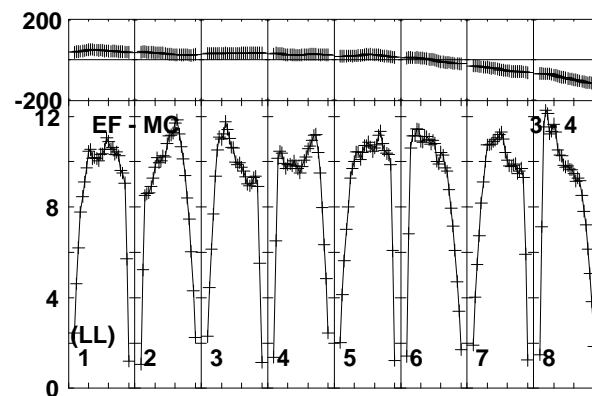
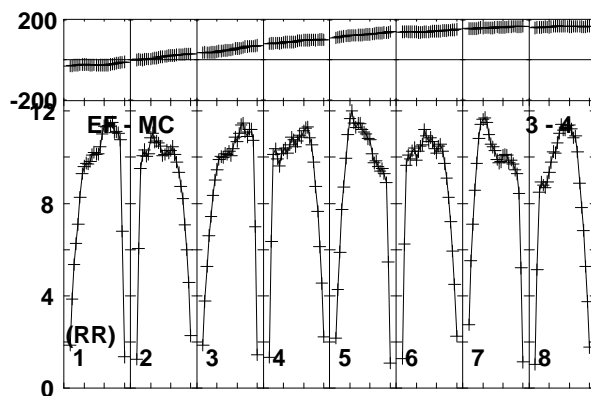
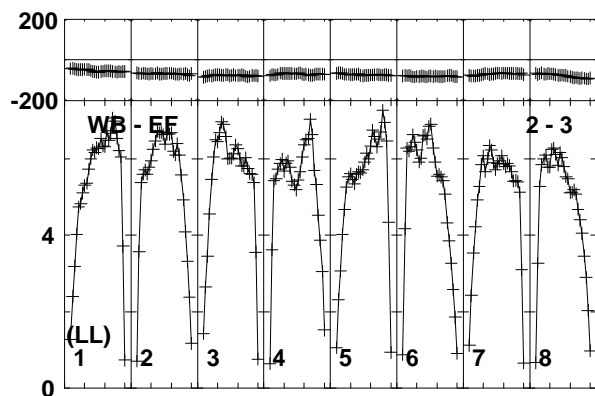
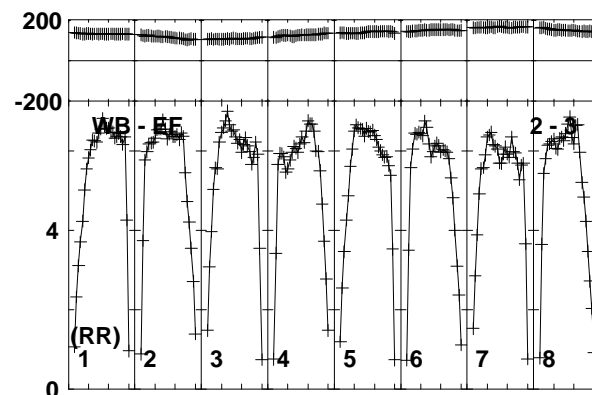
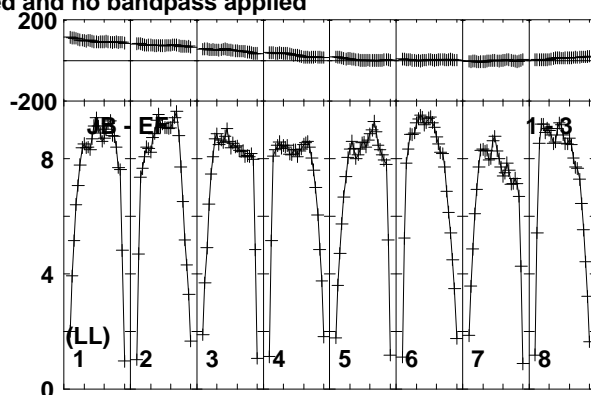
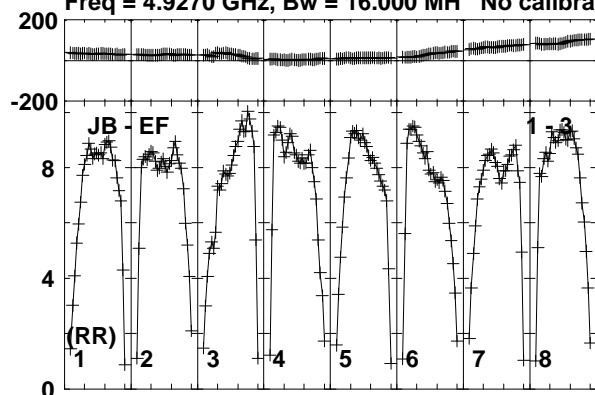

Lower frame: Milli Ampl Jy Top frame: Phas deg  
Vector averaged cross-power spectrum Baseline: JB (01) - EF (03)  
Timerange: 00/14:21:31 to 00/14:22:29

Plot file version 617 created 19-DEC-2018 17:58:57

J1619+2247 RY007C.UVDATA.1

Freq = 4.9270 GHz, Bw = 16.000 MH No calibration applied and no bandpass applied

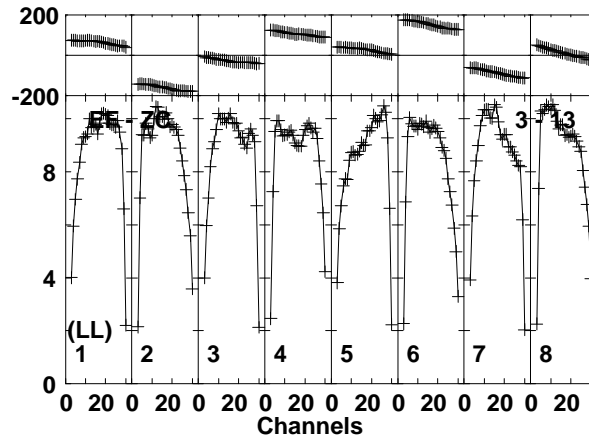
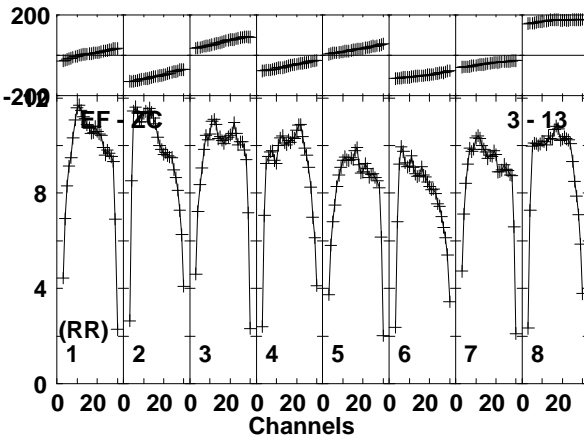
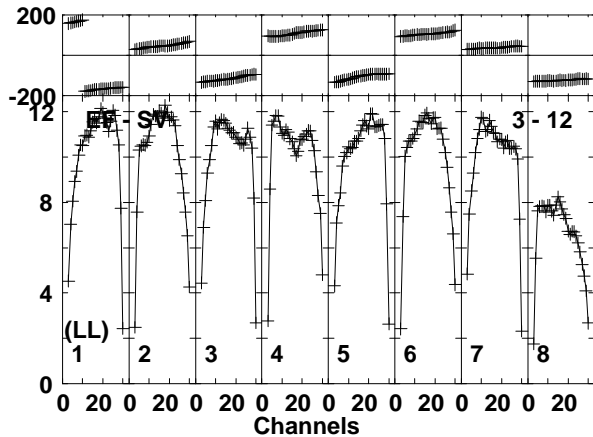
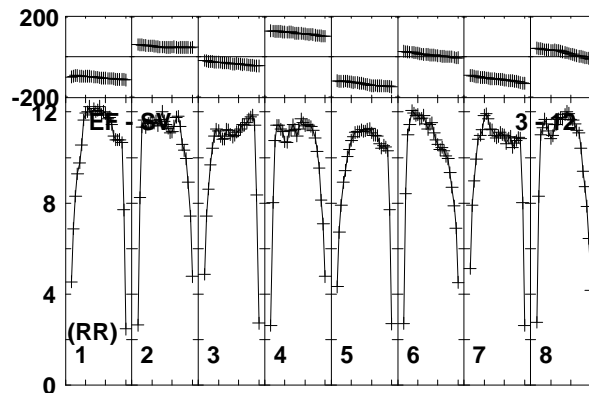
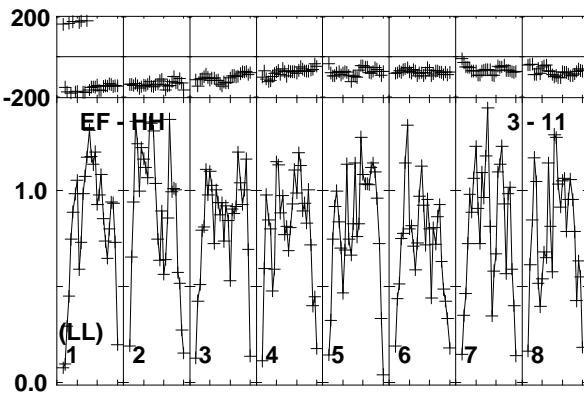
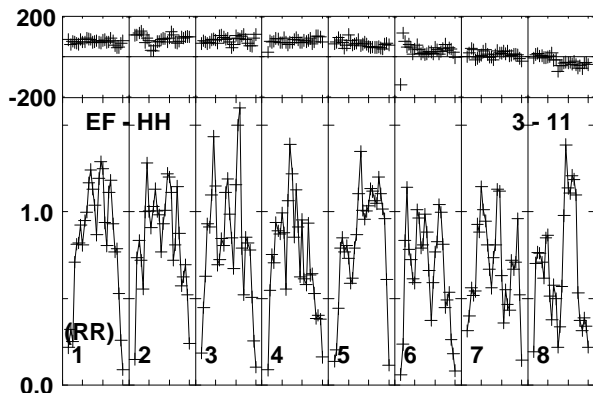
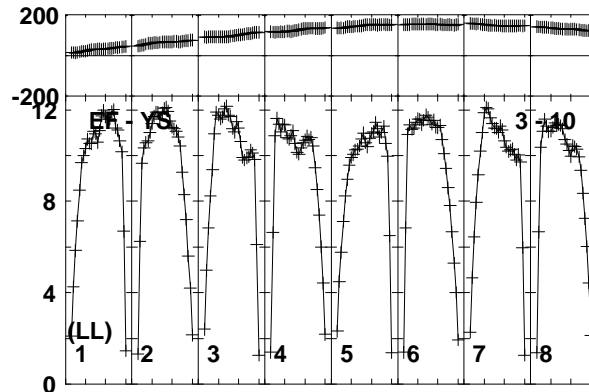
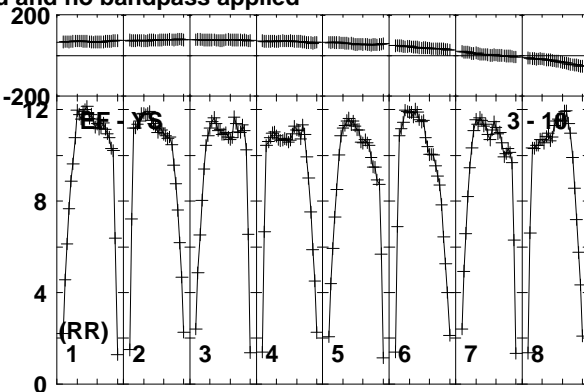
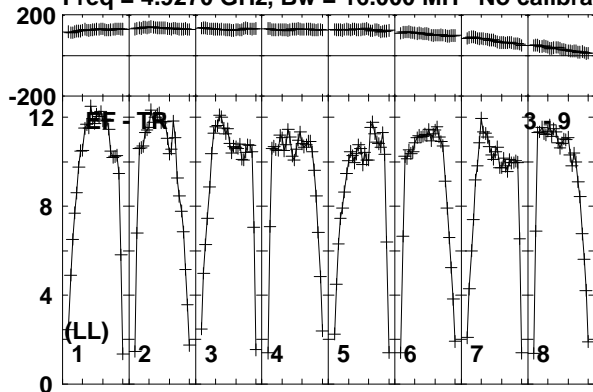

Lower frame: Milli Ampl Jy Top frame: Phas deg  
Vector averaged cross-power spectrum Baseline: EF (03) - TR (09)  
Timerange: 00/14:21:31 to 00/14:22:29

Plot file version 618 created 19-DEC-2018 17:58:57

J1619+2247 RY007C.UVDATA.1

Freq = 4.9270 GHz, Bw = 16.000 MH No calibration applied and no bandpass applied

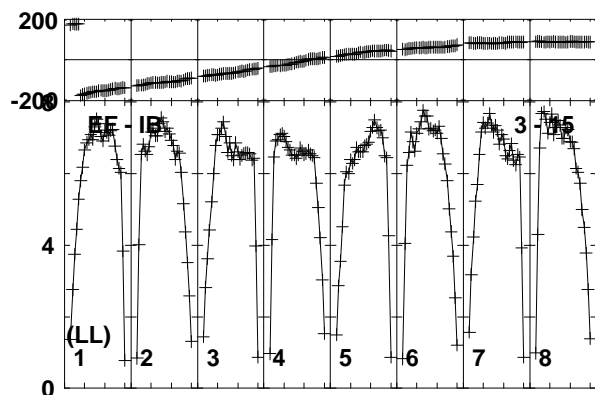
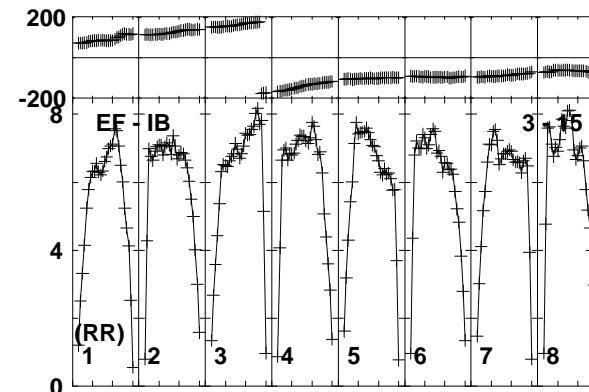
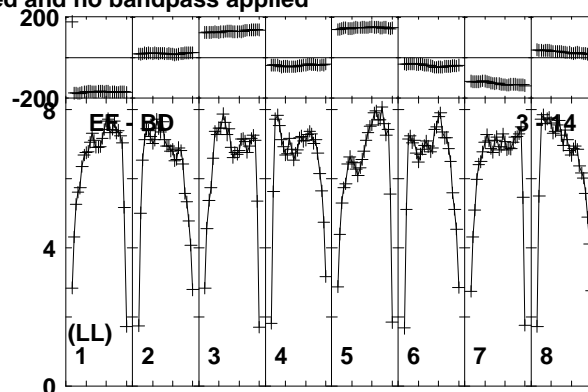
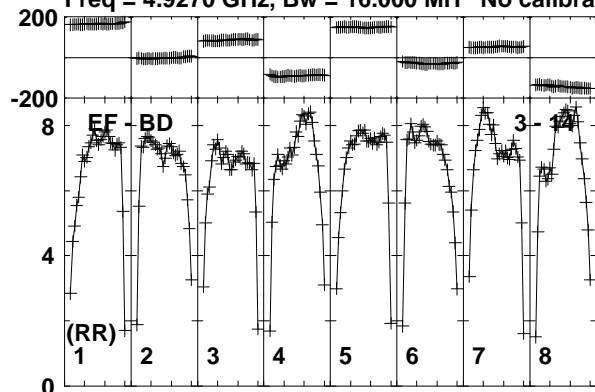

Lower frame: Milli Ampl Jy Top frame: Phas deg  
Vector averaged cross-power spectrum Baseline: EF (03) - BD (14)  
Timerange: 00/14:21:31 to 00/14:22:29



Plot file version 619 created 19-DEC-2018 17:58:57

VLA1 RY007C.UVDATA.1

Freq = 4.9270 GHz, Bw = 16.000 MH No calibration applied and no bandpass applied

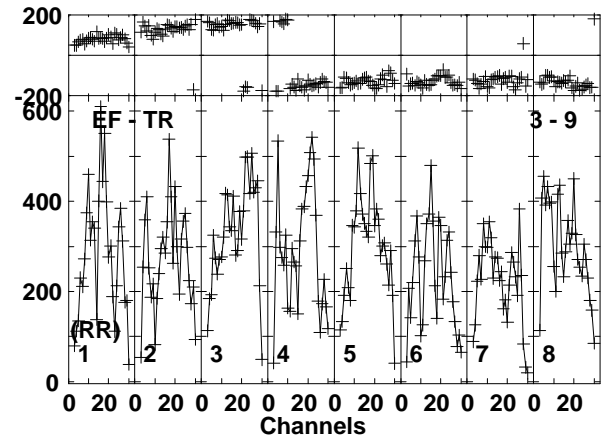
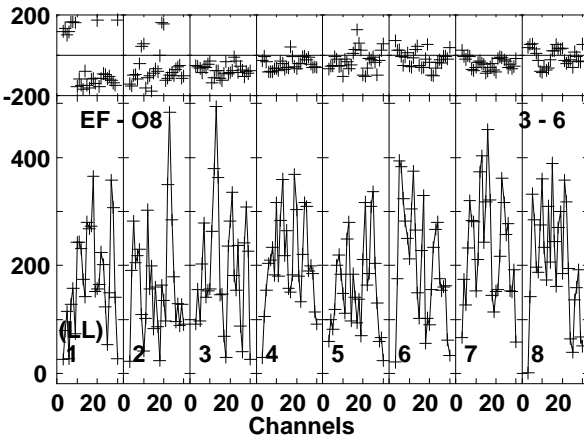
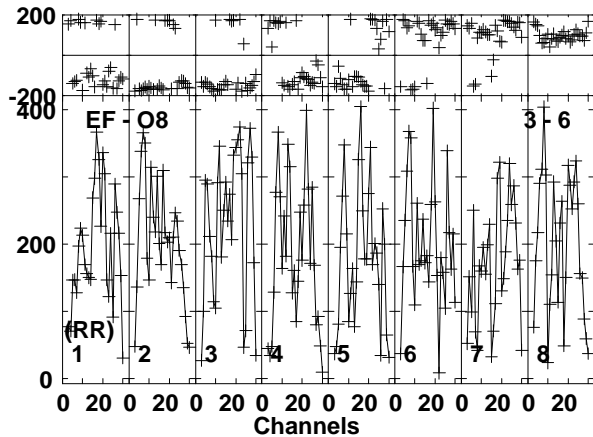
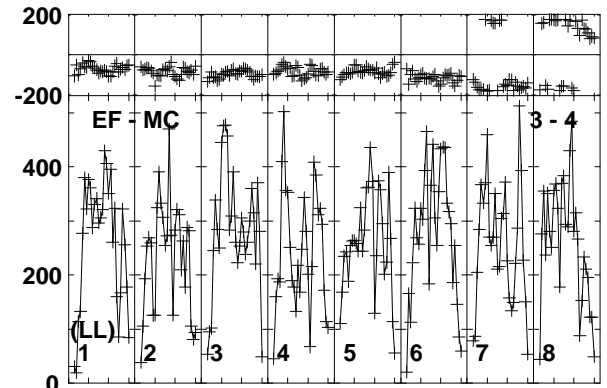
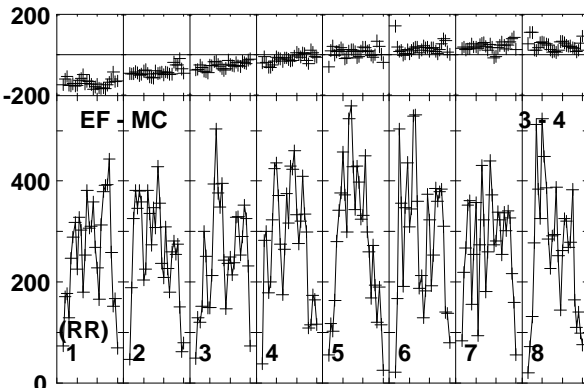
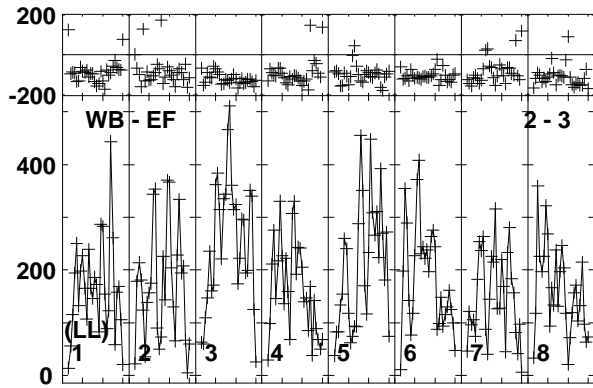
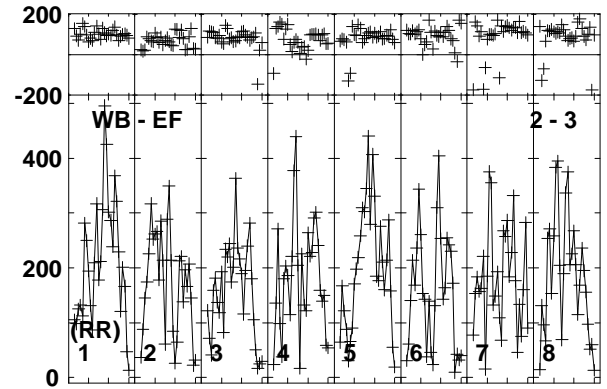
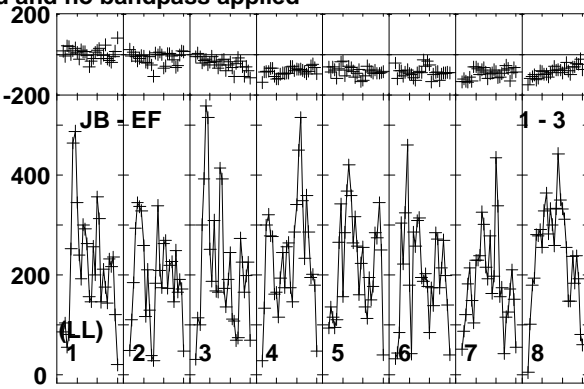
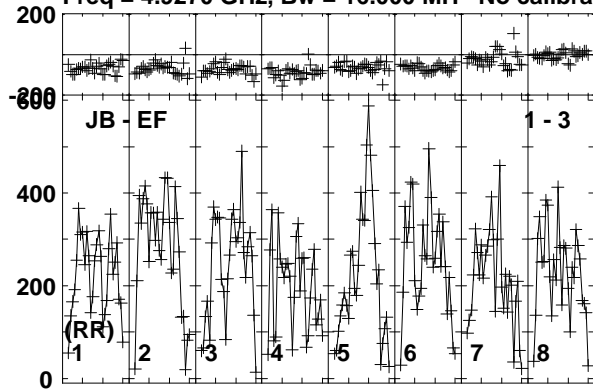

Lower frame: Micro Ampl Jy Top frame: Phas deg  
Vector averaged cross-power spectrum Baseline: JB (01) - EF (03)  
Timerange: 00/14:23:01 to 00/14:24:59

Plot file version 620 created 19-DEC-2018 17:58:57

VLA1 RY007C.UVDATA.1

Freq = 4.9270 GHz, Bw = 16.000 MH No calibration applied and no bandpass applied

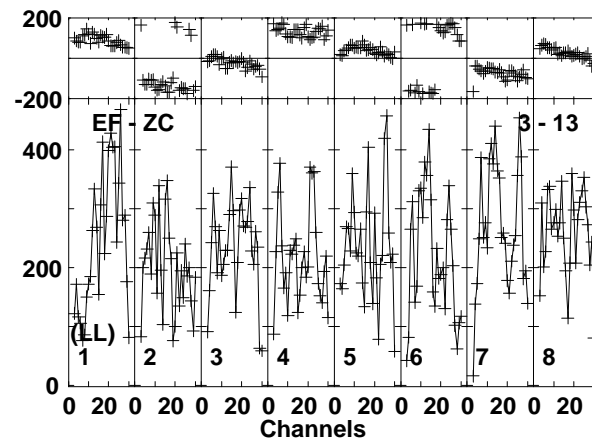
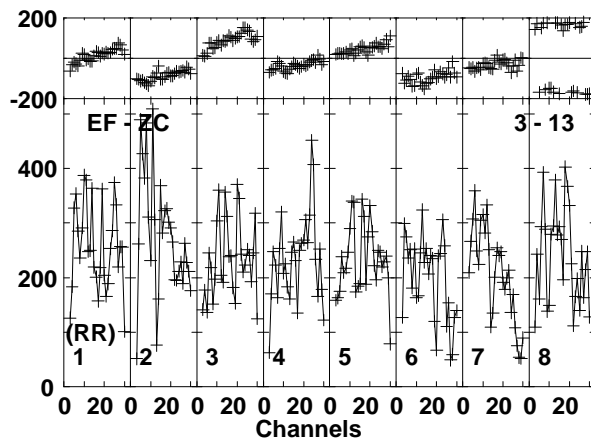
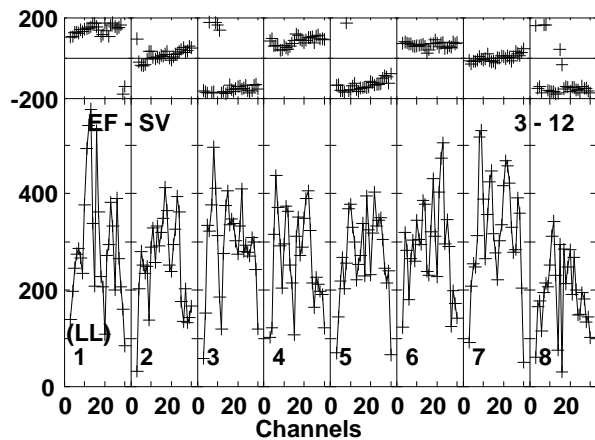
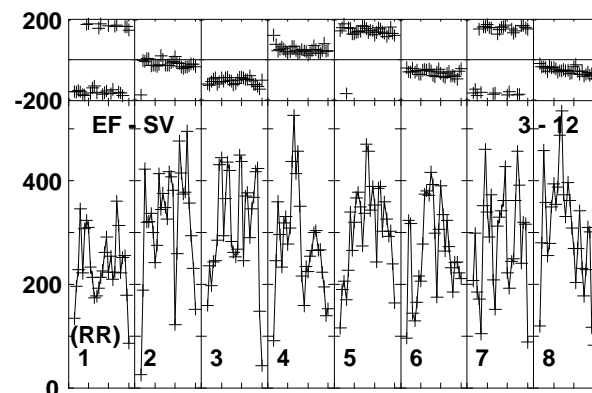
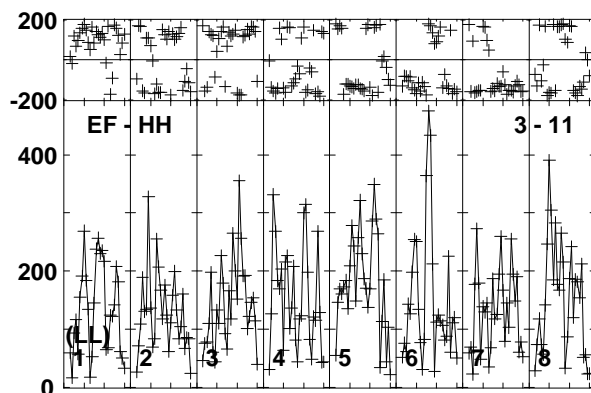
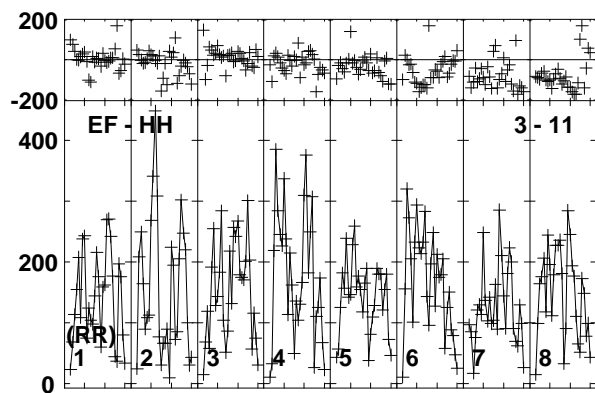
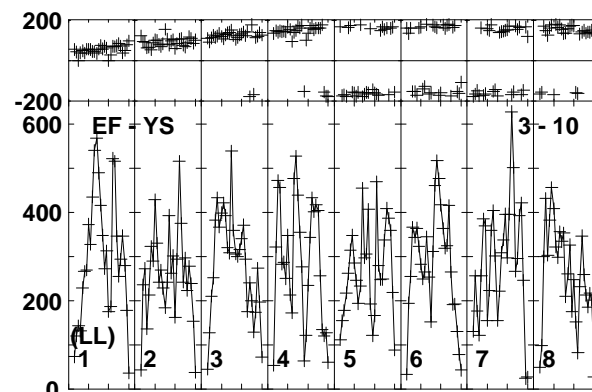
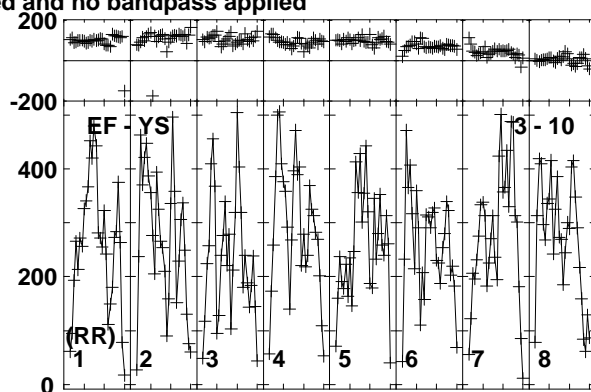
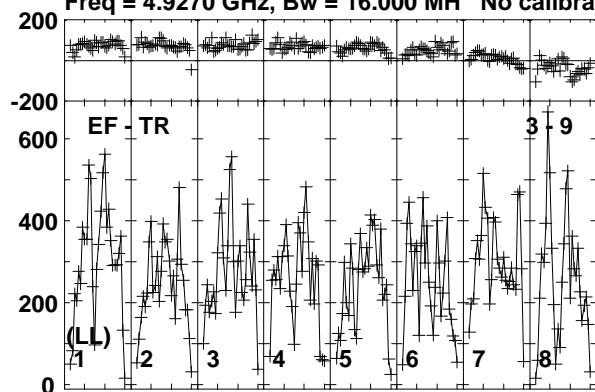

Lower frame: Micro Ampl Jy Top frame: Phas deg  
Vector averaged cross-power spectrum Baseline: EF (03) - TR (09)  
Timerange: 00/14:23:01 to 00/14:24:59

Plot file version 621 created 19-DEC-2018 17:58:57

VLA1 RY007C.UVDATA.1

Freq = 4.9270 GHz, Bw = 16.000 MH No calibration applied and no bandpass applied

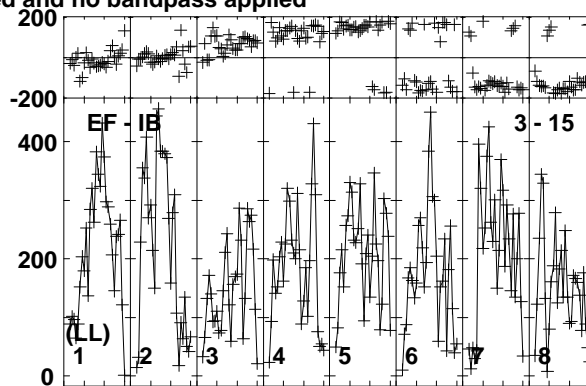
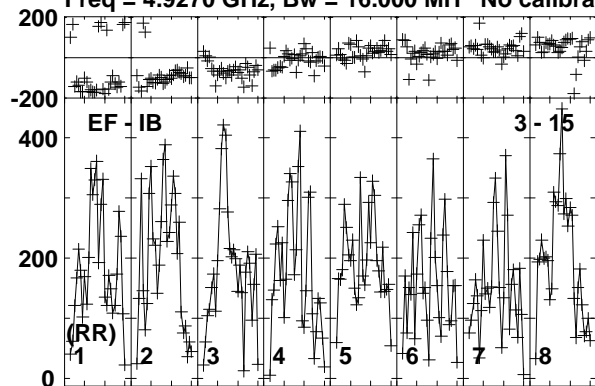

Lower frame: Micro Ampl Jy Top frame: Phas deg  
Vector averaged cross-power spectrum Baseline: EF (03) - IB (15)  
Timerange: 00/14:23:01 to 00/14:24:59

Plot file version 622 created 19-DEC-2018 17:58:57

J1619+2247 RY007C.UVDATA.1

Freq = 4.9270 GHz, Bw = 16.000 MH No calibration applied and no bandpass applied

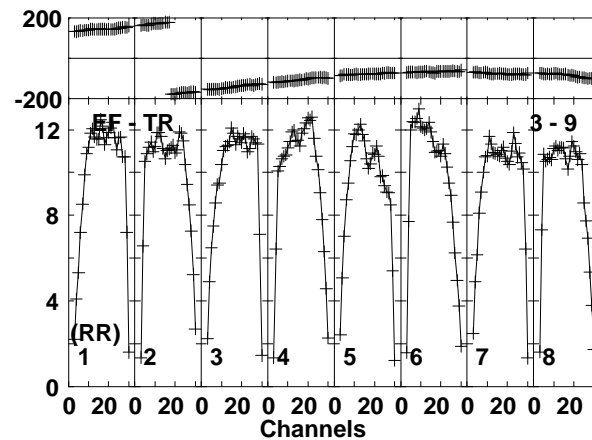
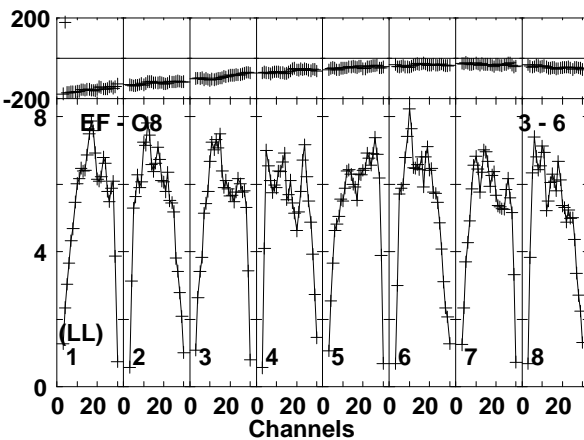
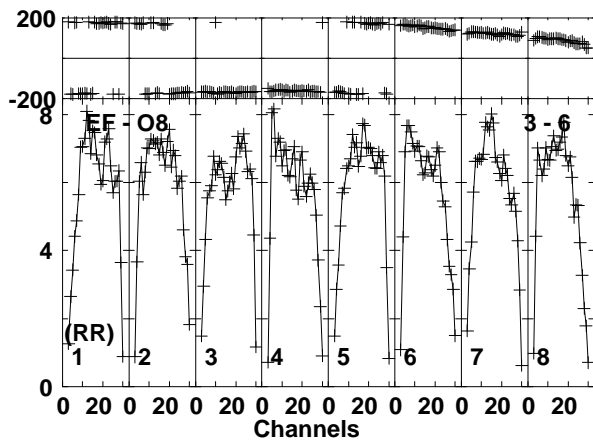
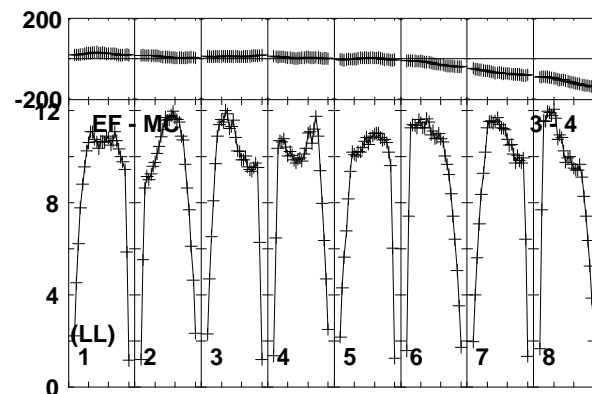
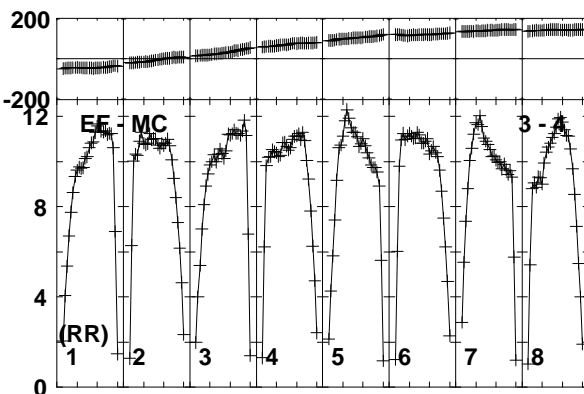
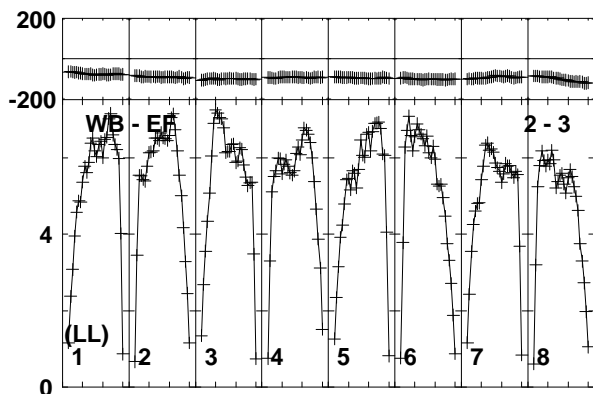
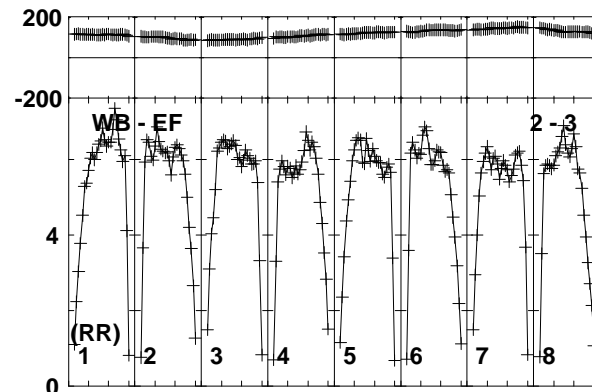
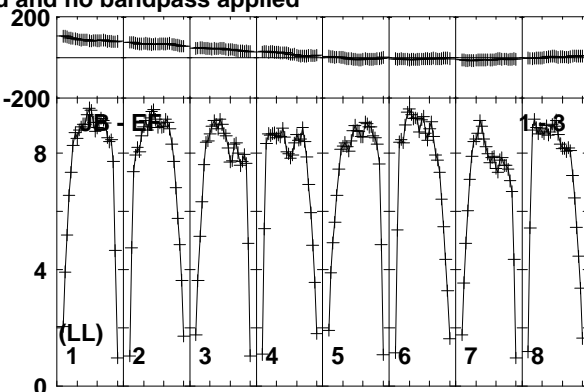
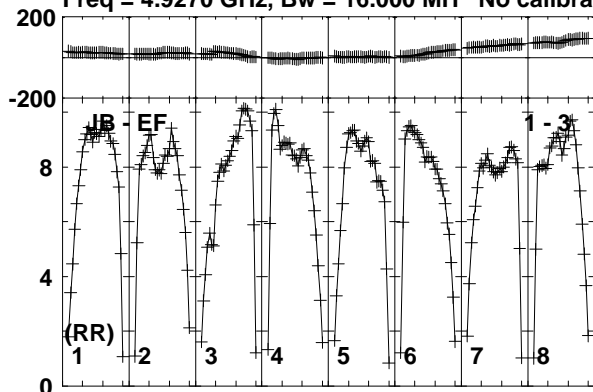

Lower frame: Milli Ampl Jy Top frame: Phas deg  
Vector averaged cross-power spectrum Baseline: JB (01) - EF (03)  
Timerange: 00/14:25:01 to 00/14:25:59

Plot file version 623 created 19-DEC-2018 17:58:58

J1619+2247 RY007C.UVDATA.1

Freq = 4.9270 GHz, Bw = 16.000 MH No calibration applied and no bandpass applied

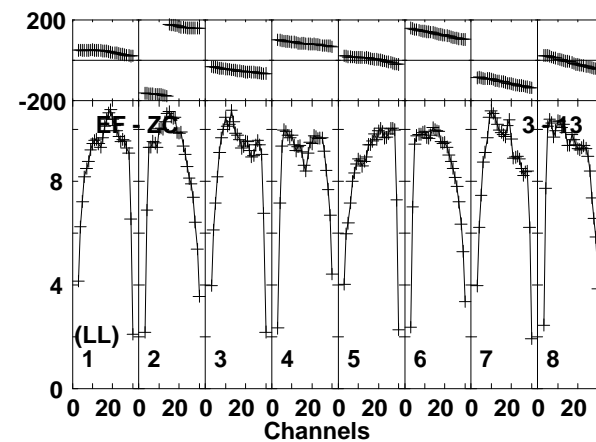
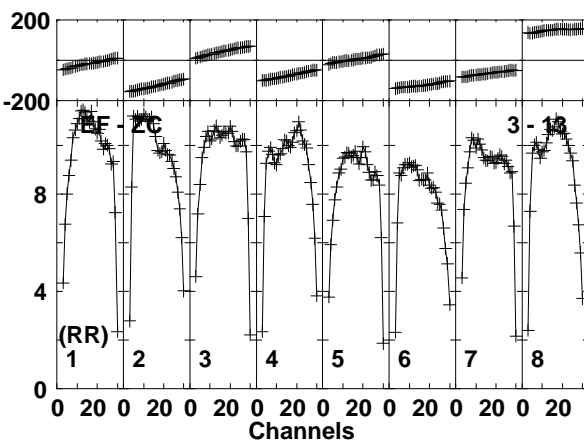
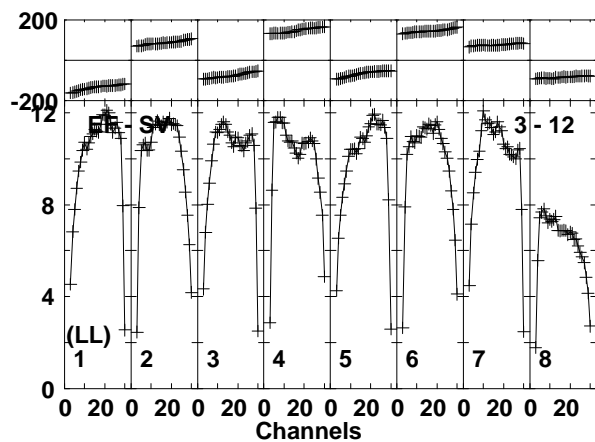
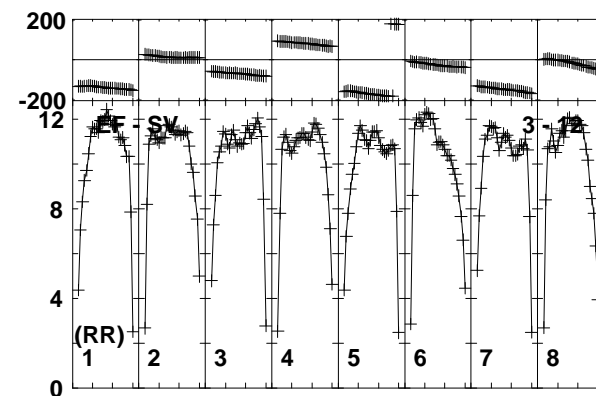
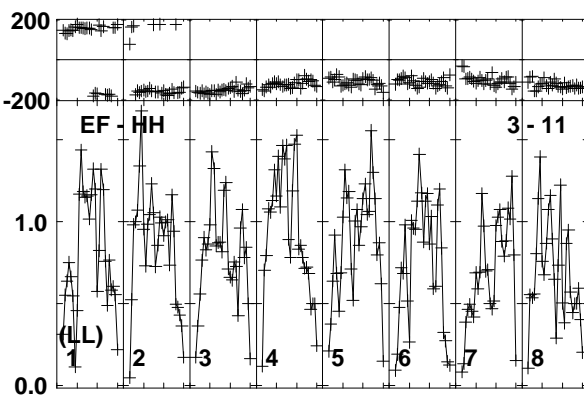
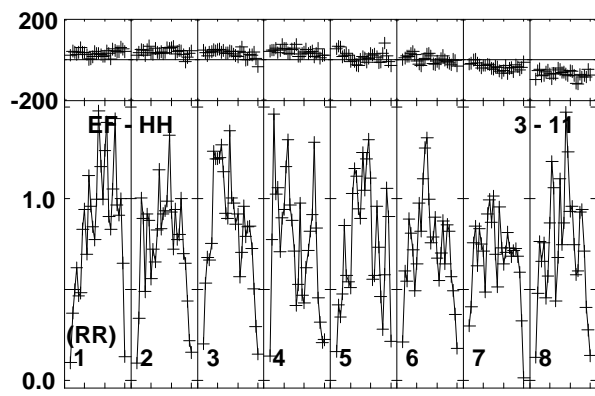
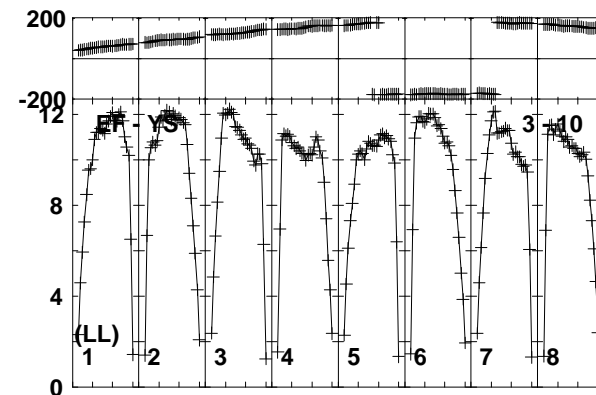
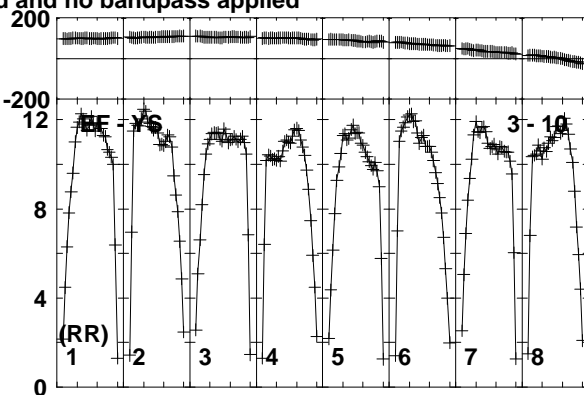
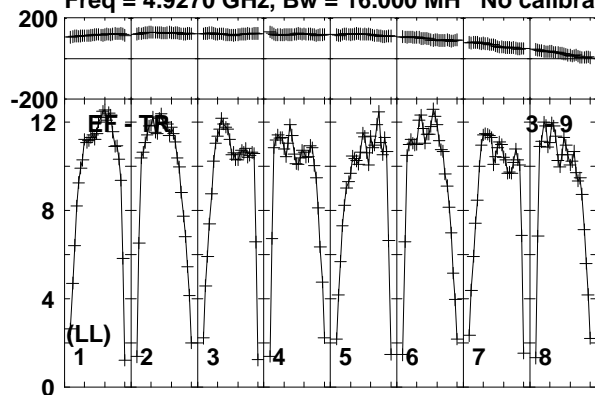

Lower frame: Milli Ampl Jy Top frame: Phas deg  
Vector averaged cross-power spectrum Baseline: EF (03) - TR (09)  
Timerange: 00/14:25:01 to 00/14:25:59

Plot file version 624 created 19-DEC-2018 17:58:58  
J1619+2247 RY007C.UVDATA.1

Freq = 4.9270 GHz, Bw = 16.000 MH No calibration applied and no bandpass applied

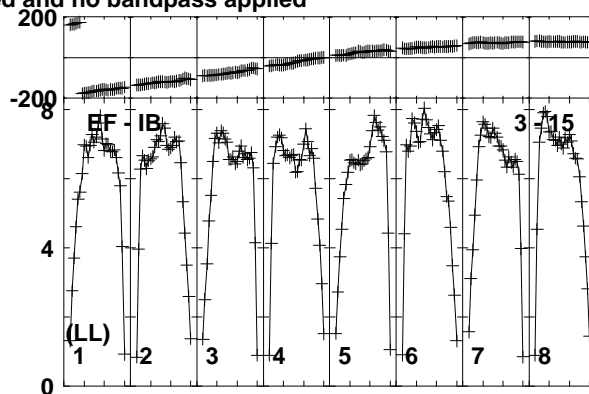
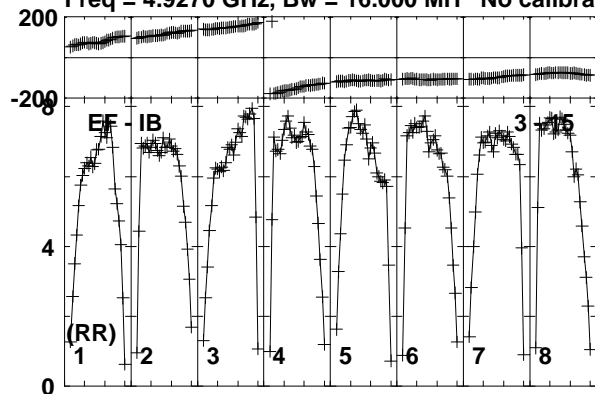

Lower frame: Milli Ampl Jy Top frame: Phas deg  
Vector averaged cross-power spectrum Baseline: EF (03) - IB (15)  
Timerange: 00/14:25:01 to 00/14:25:59

Plot file version 625 created 19-DEC-2018 17:58:58

AT2018\_RY007C.UVDATA.1

Freq = 4.9270 GHz, Bw = 16.000 MH No calibration applied and no bandpass applied

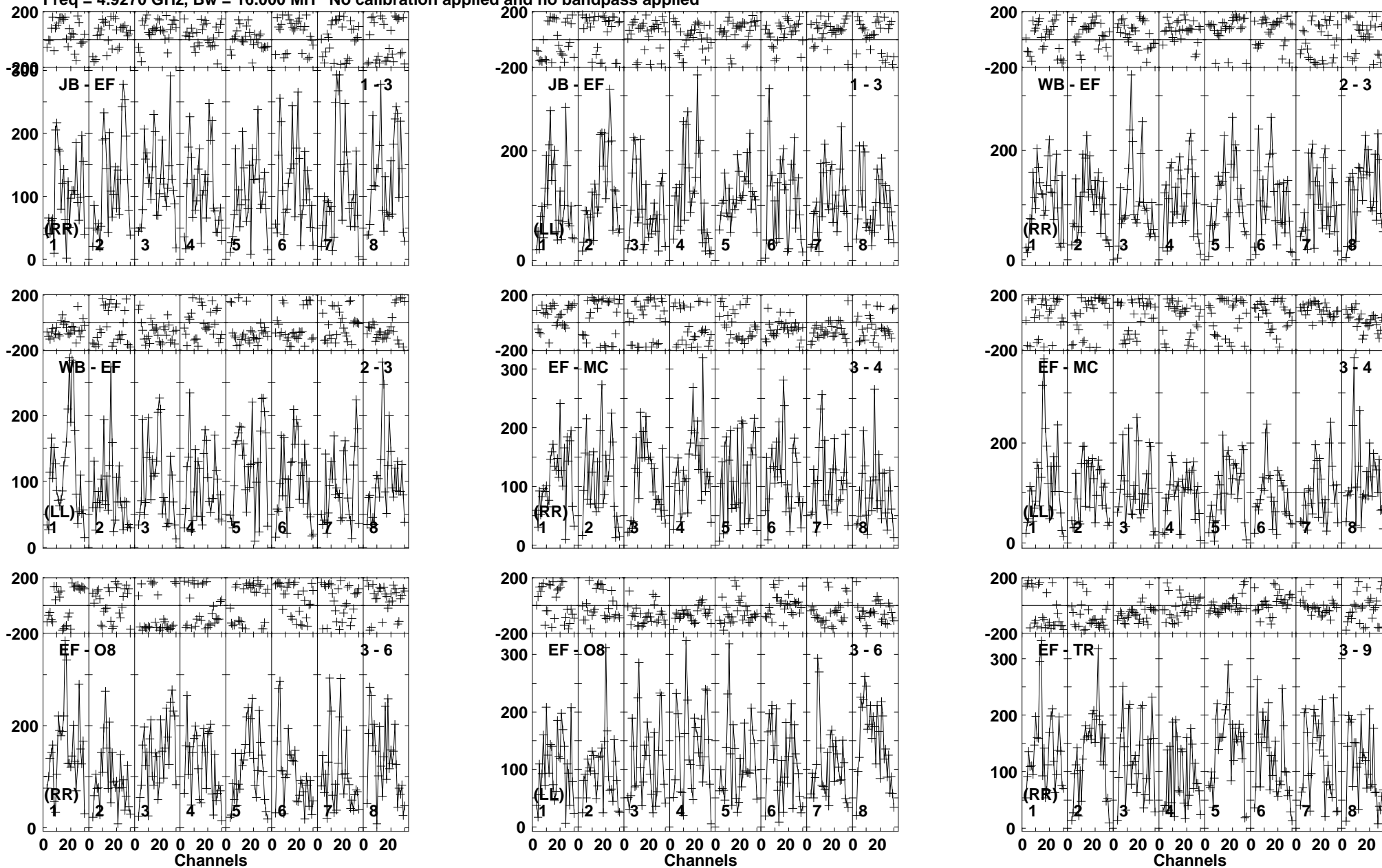

Lower frame: Micro Ampl Jy Top frame: Phas deg  
Vector averaged cross-power spectrum Baseline: JB (01) - EF (03)  
Timerange: 00/14:26:01 to 00/14:28:59

Plot file version 626 created 19-DEC-2018 17:58:58

AT2018\_RY007C.UVDATA.1

Freq = 4.9270 GHz, Bw = 16.000 MH No calibration applied and no bandpass applied

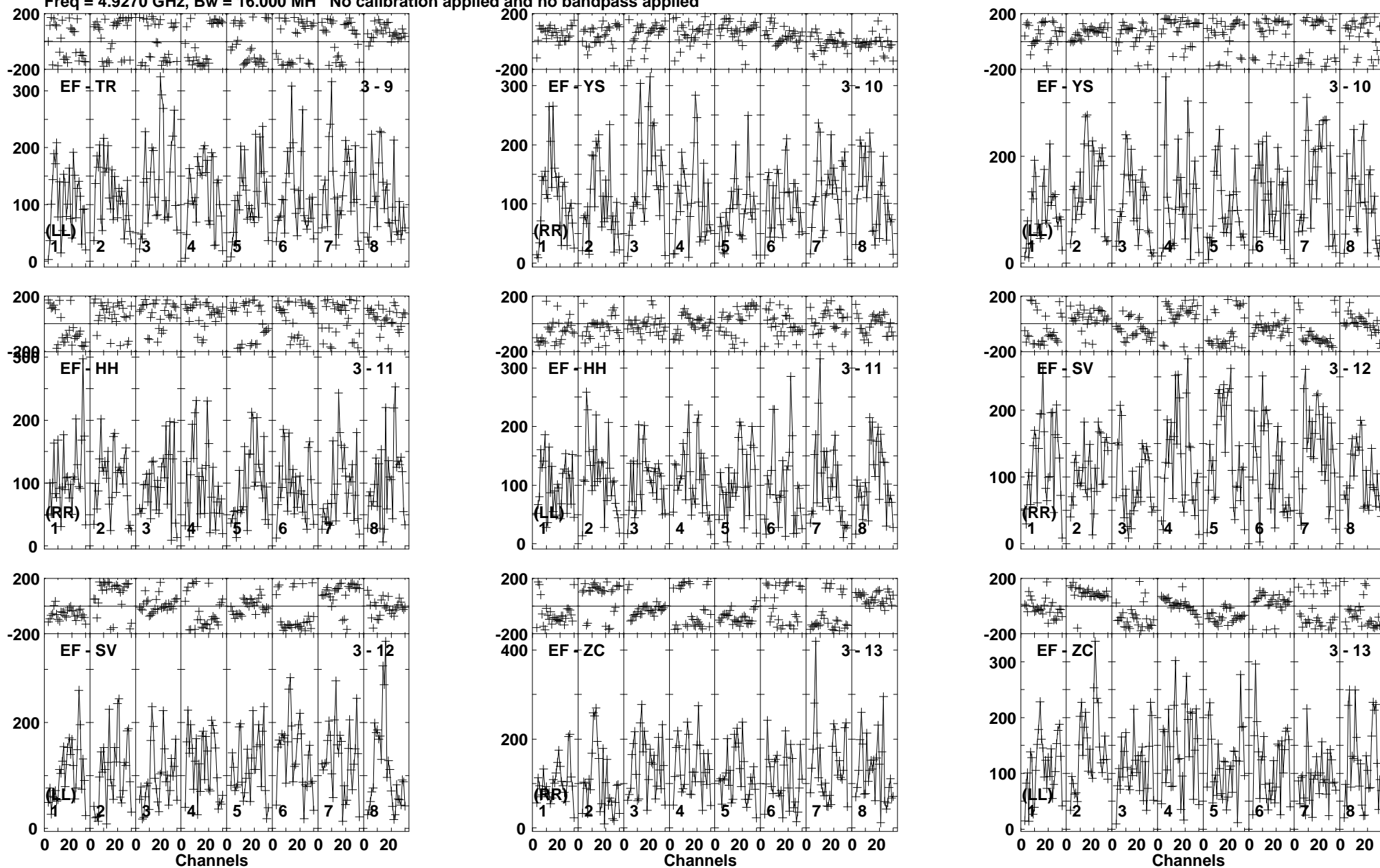

Lower frame: Micro Ampl Jy Top frame: Phas deg  
Vector averaged cross-power spectrum Baseline: EF (03) - TR (09)  
Timerange: 00/14:26:01 to 00/14:28:59



Plot file version 627 created 19-DEC-2018 17:58:58

AT2018\_RY007C.UVDATA.1

Freq = 4.9270 GHz, Bw = 16.000 MH No calibration applied and no bandpass applied

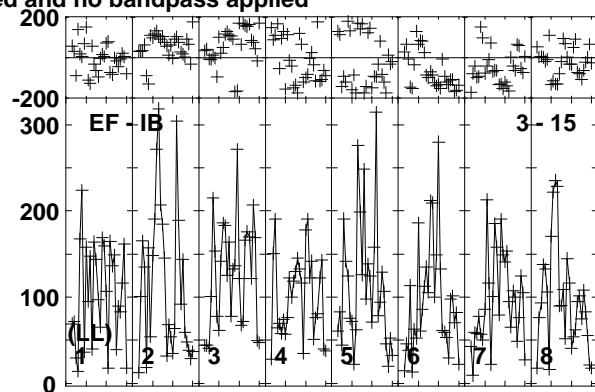
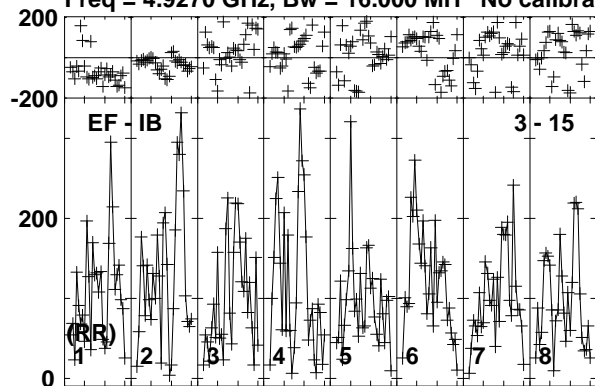

Lower frame: Micro Ampl Jy Top frame: Phas deg  
Vector averaged cross-power spectrum Baseline: EF (03) - IB (15)  
Timerange: 00/14:26:01 to 00/14:28:59

Plot file version 628 created 19-DEC-2018 17:58:58

J1619+2247 RY007C.UVDATA.1

Freq = 4.9270 GHz, Bw = 16.000 MH No calibration applied and no bandpass applied

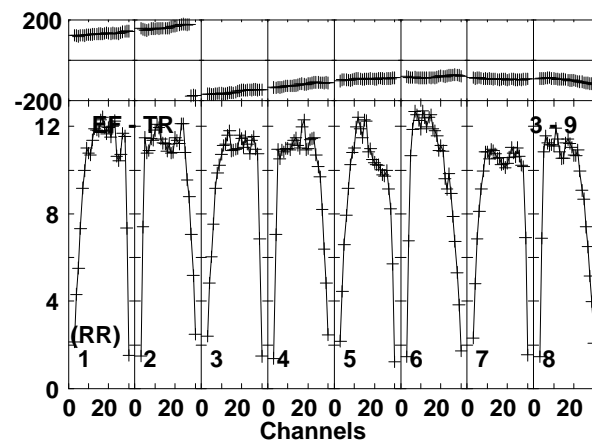
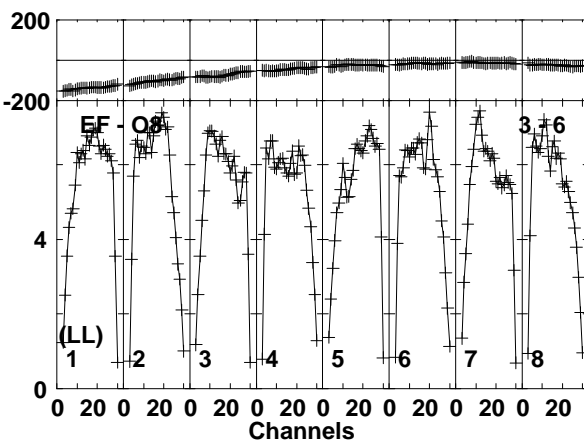
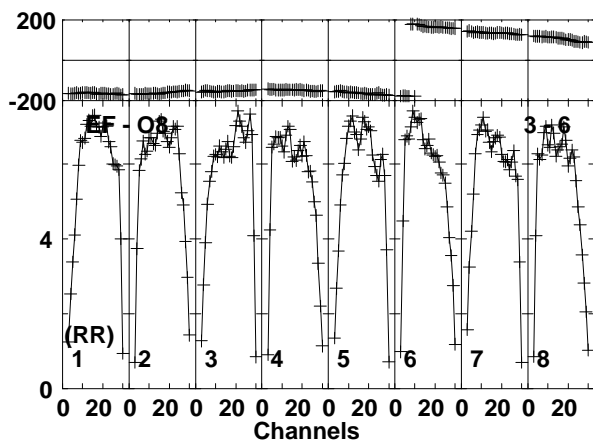
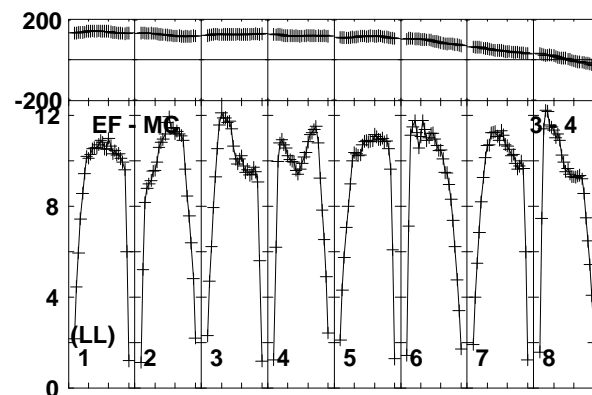
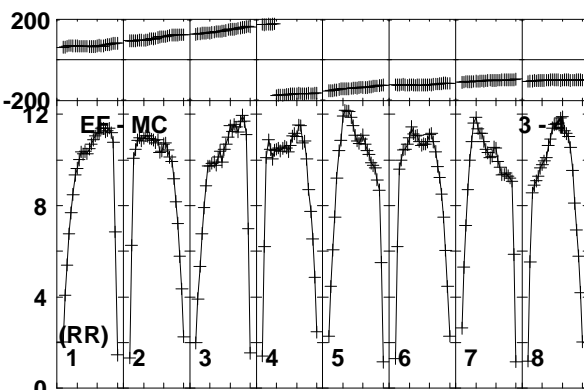
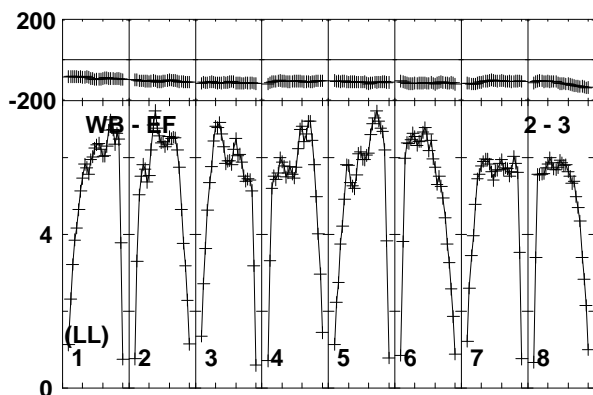
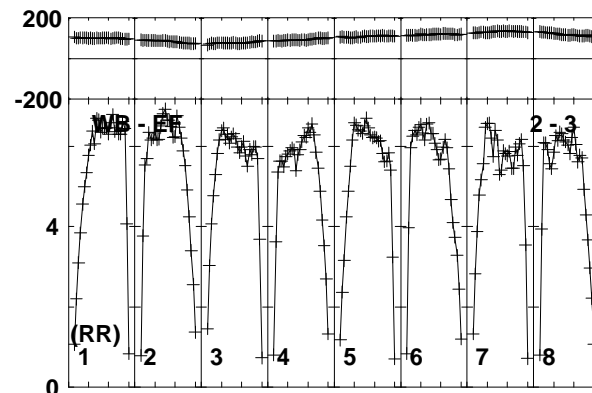
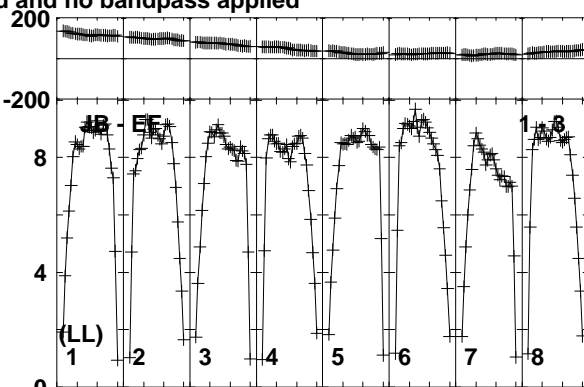
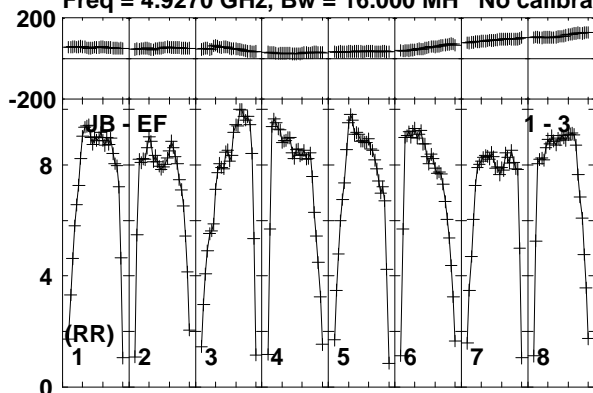

Lower frame: Milli Ampl Jy Top frame: Phas deg  
Vector averaged cross-power spectrum Baseline: JB (01) - EF (03)  
Timerange: 00/14:29:01 to 00/14:29:59

Plot file version 629 created 19-DEC-2018 17:58:58

J1619+2247 RY007C.UVDATA.1

Freq = 4.9270 GHz, Bw = 16.000 MH No calibration applied and no bandpass applied

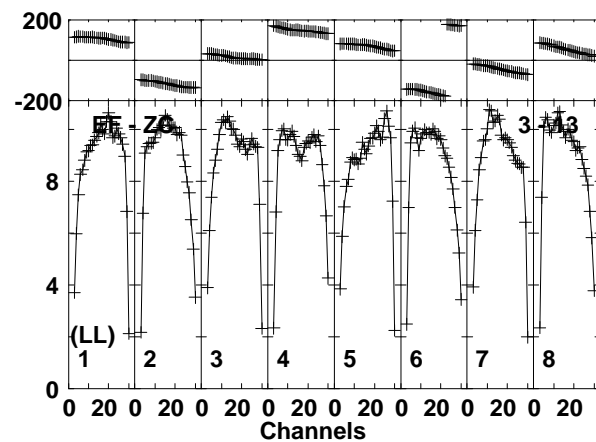
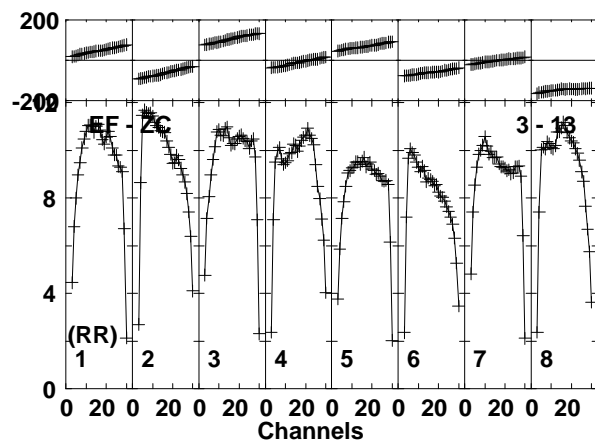
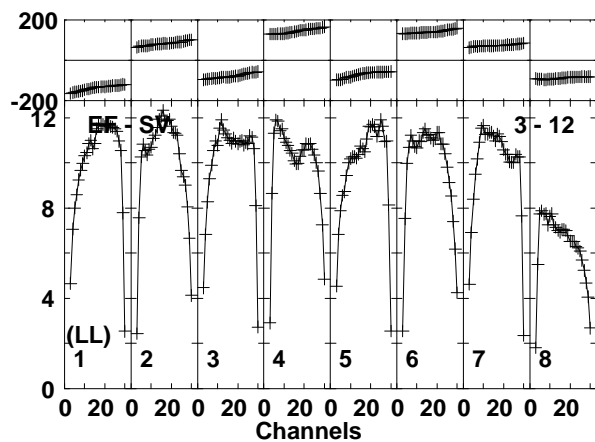
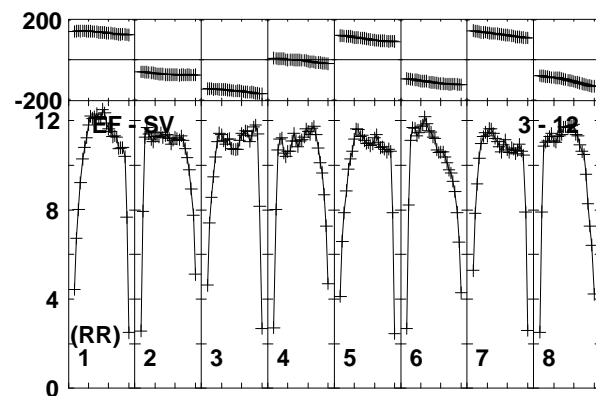
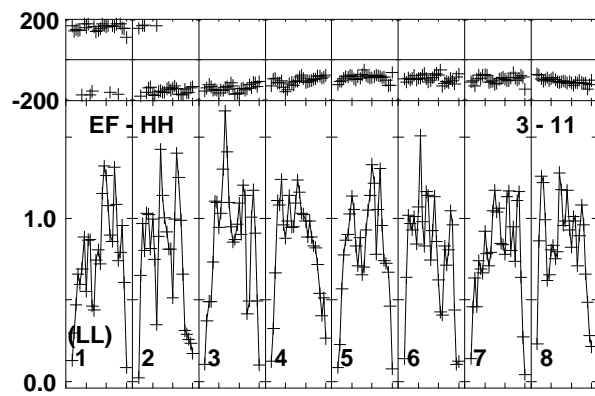
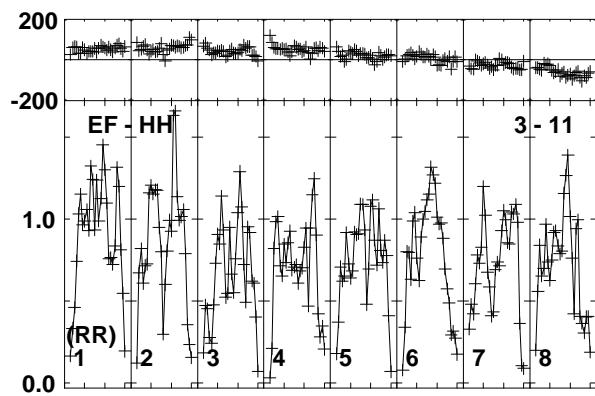
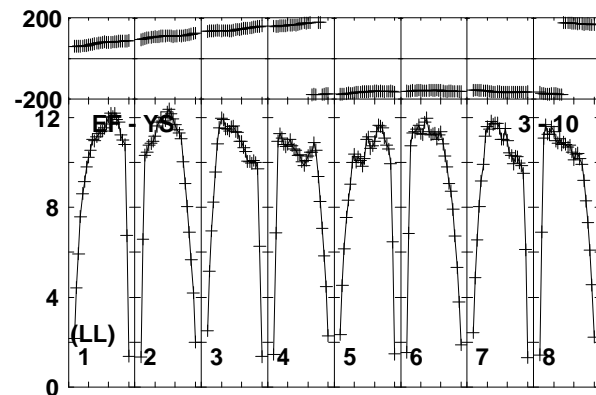
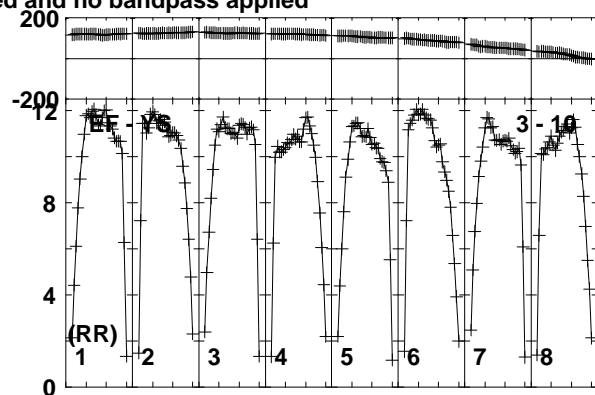
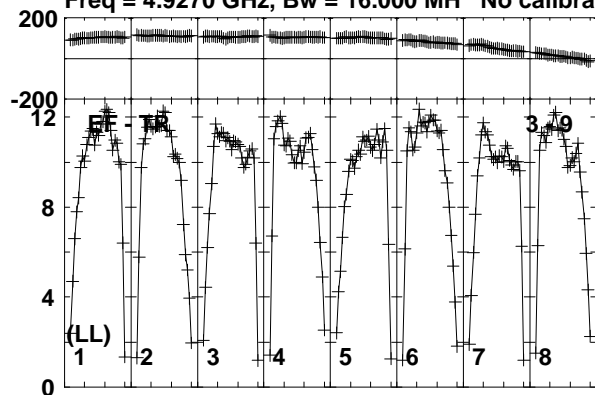

Lower frame: Milli Ampl Jy Top frame: Phas deg  
Vector averaged cross-power spectrum Baseline: EF (03) - TR (09)  
Timerange: 00/14:29:01 to 00/14:29:59

Plot file version 630 created 19-DEC-2018 17:58:58  
J1619+2247 RY007C.UVDATA.1

Freq = 4.9270 GHz, Bw = 16.000 MH No calibration applied and no bandpass applied

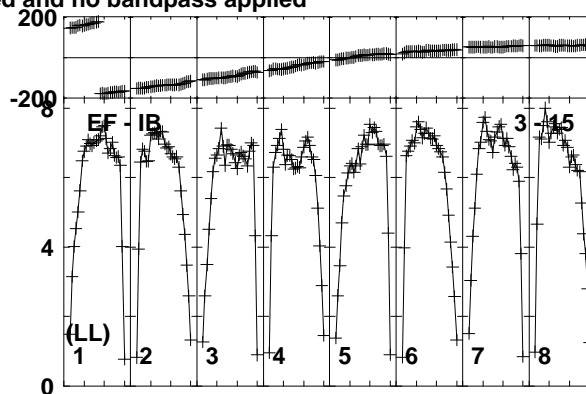
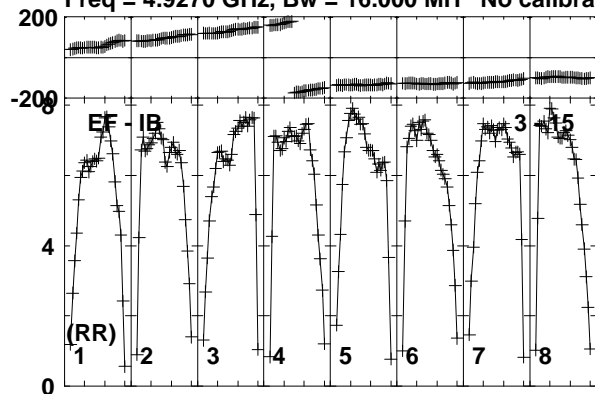

Lower frame: Milli Ampl Jy Top frame: Phas deg  
Vector averaged cross-power spectrum Baseline: EF (03) - IB (15)  
Timerange: 00/14:29:01 to 00/14:29:59

Plot file version 631 created 19-DEC-2018 17:58:58

AT2018\_RY007C.UVDATA.1

Freq = 4.9270 GHz, Bw = 16.000 MH No calibration applied and no bandpass applied

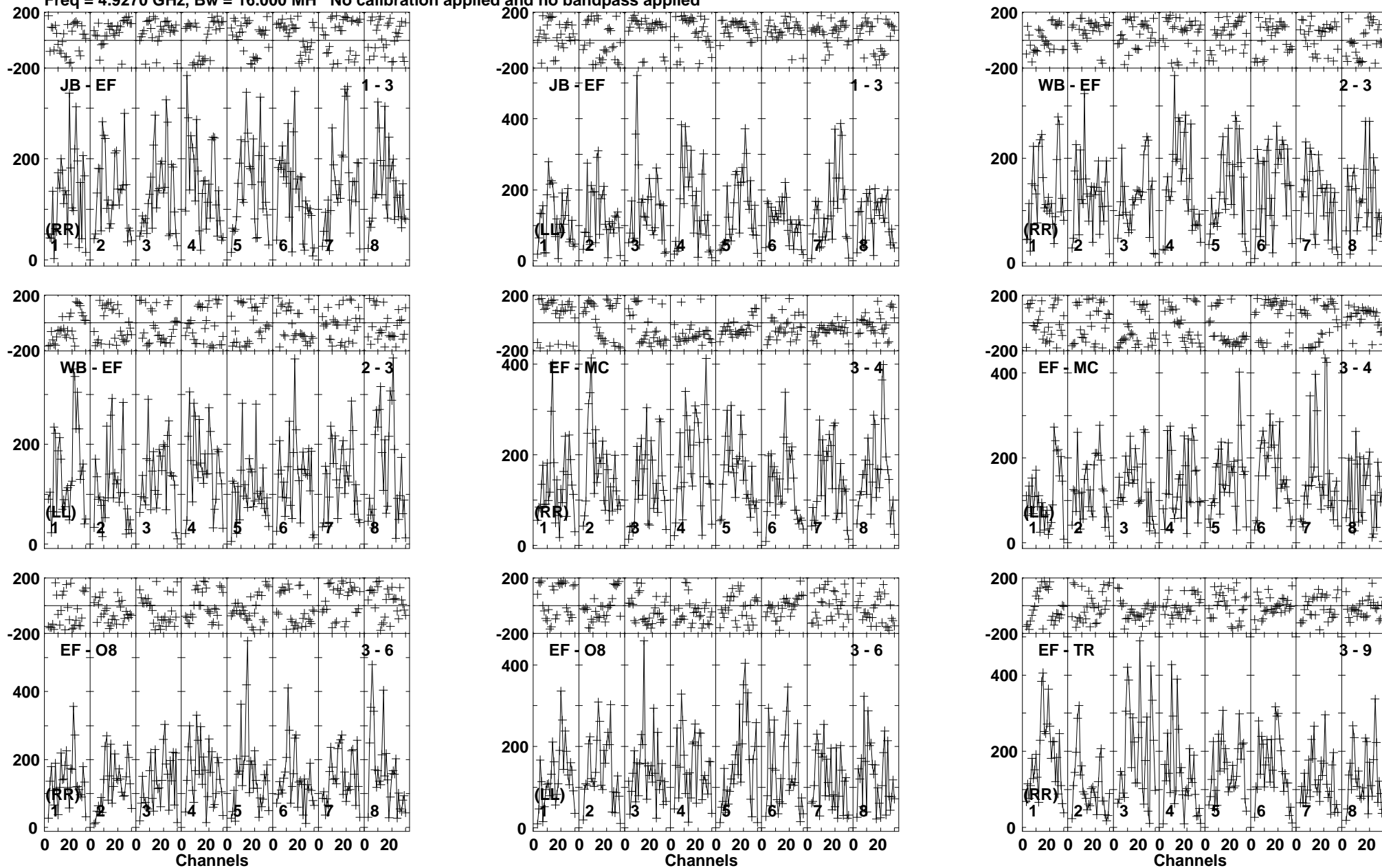

Lower frame: Micro Ampl Jy Top frame: Phas deg  
Vector averaged cross-power spectrum Baseline: JB (01) - EF (03)  
Timerange: 00/14:30:01 to 00/14:31:59

Plot file version 632 created 19-DEC-2018 17:58:58

AT2018\_RY007C.UVDATA.1

Freq = 4.9270 GHz, Bw = 16.000 MH No calibration applied and no bandpass applied

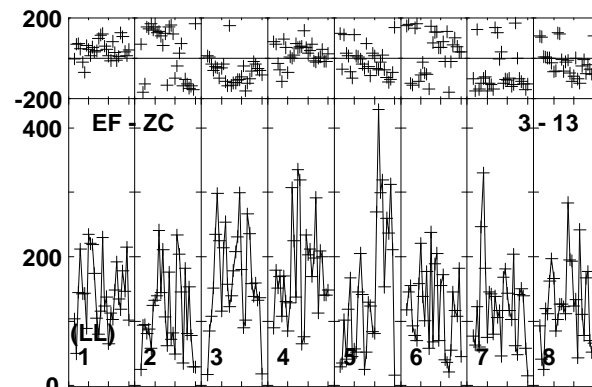
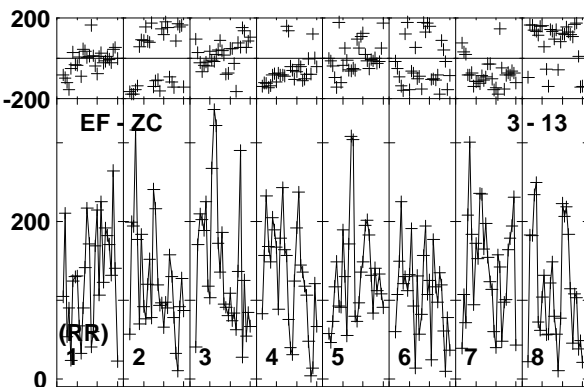
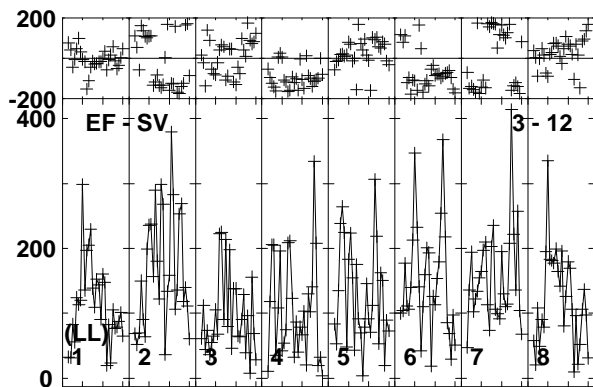
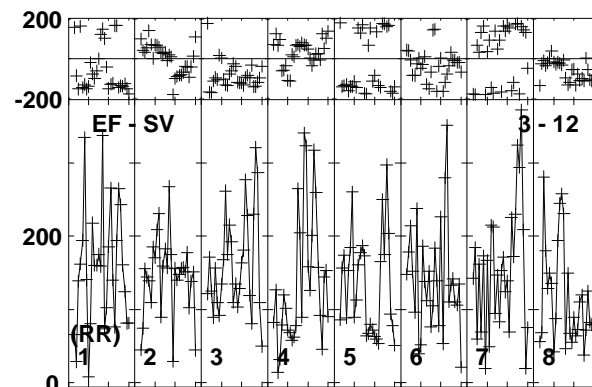
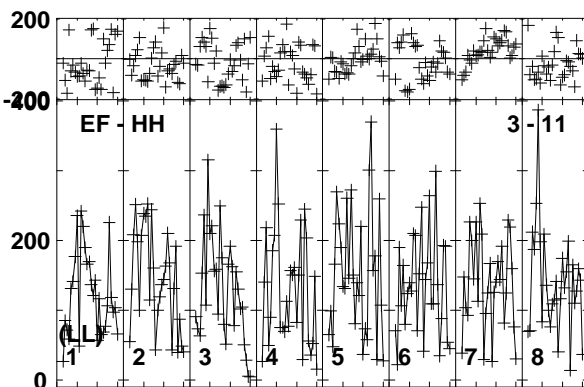
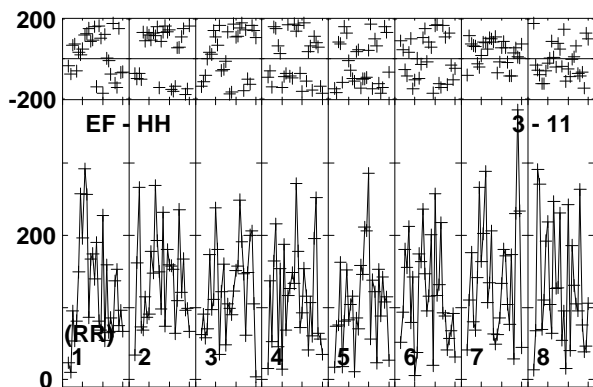
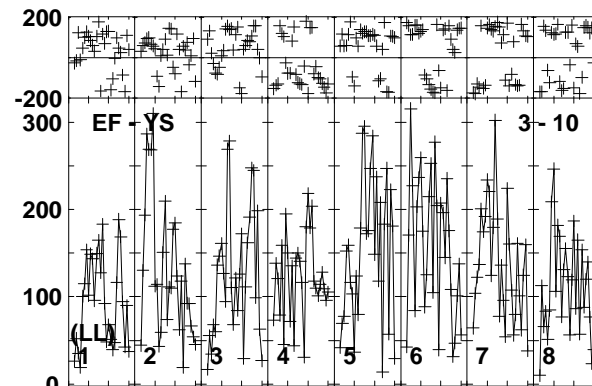
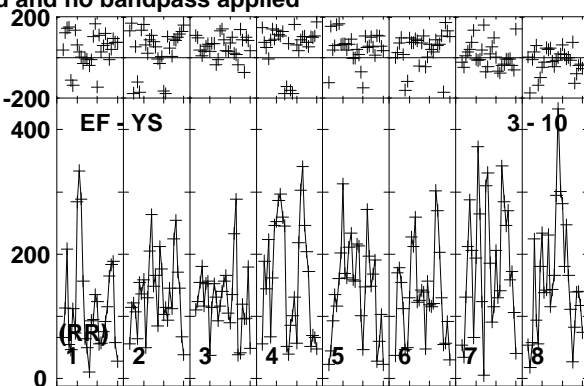
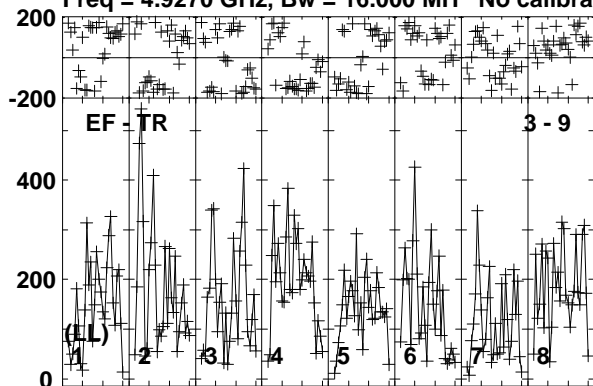

Lower frame: Micro Ampl Jy Top frame: Phas deg  
Vector averaged cross-power spectrum Baseline: EF (03) - TR (09)  
Timerange: 00/14:30:01 to 00/14:31:59

Plot file version 633 created 19-DEC-2018 17:58:58

AT2018\_RY007C.UVDATA.1

Freq = 4.9270 GHz, Bw = 16.000 MH No calibration applied and no bandpass applied

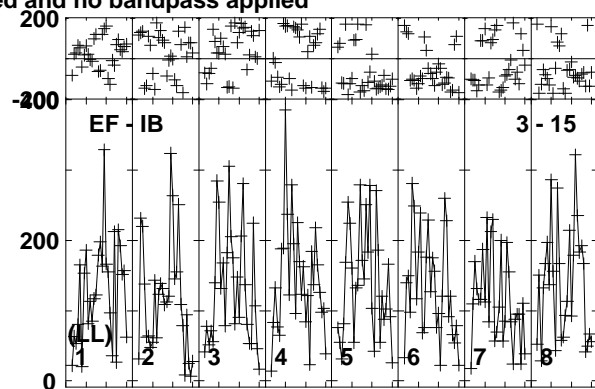
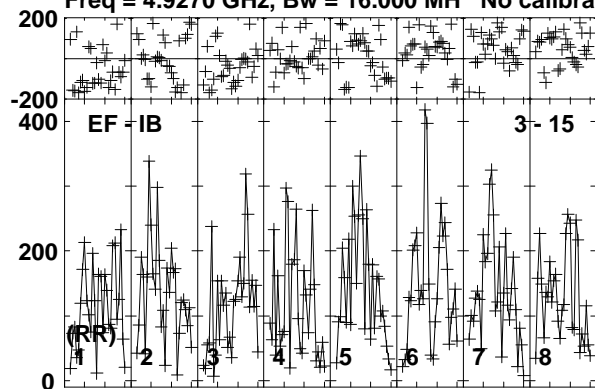

Lower frame: Micro Ampl Jy Top frame: Phas deg  
Vector averaged cross-power spectrum Baseline: EF (03) - IB (15)  
Timerange: 00/14:30:01 to 00/14:31:59

Plot file version 634 created 19-DEC-2018 17:58:58

VLA2 RY007C.UVDATA.1

Freq = 4.9270 GHz, Bw = 16.000 MH No calibration applied and no bandpass applied

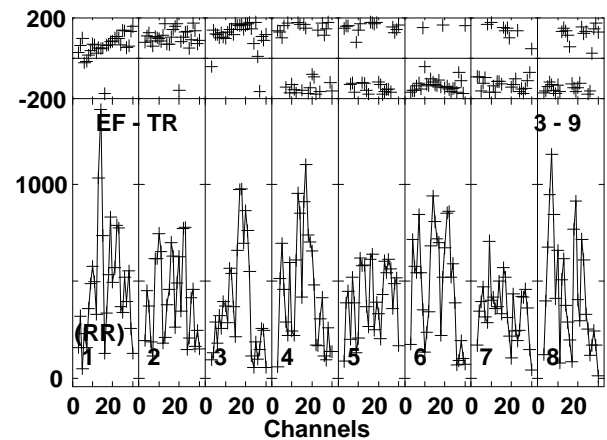
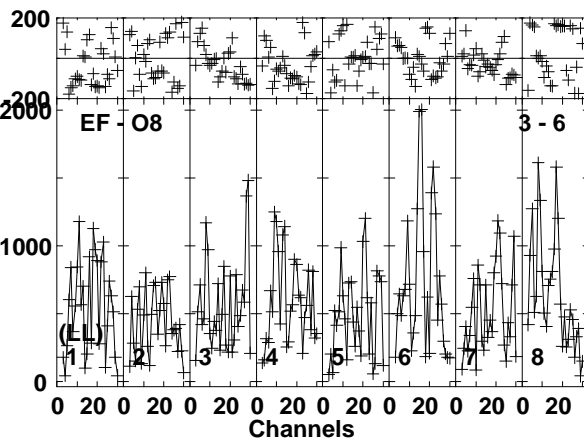
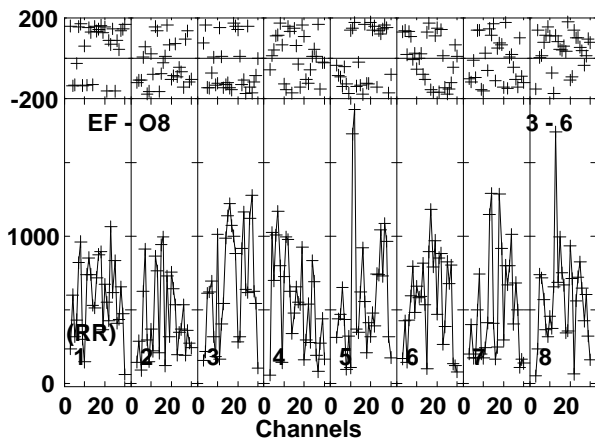
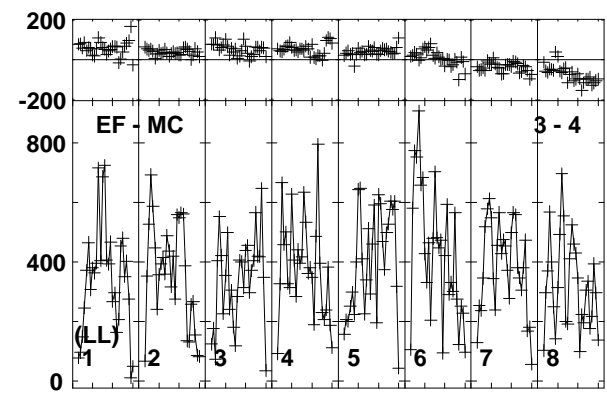
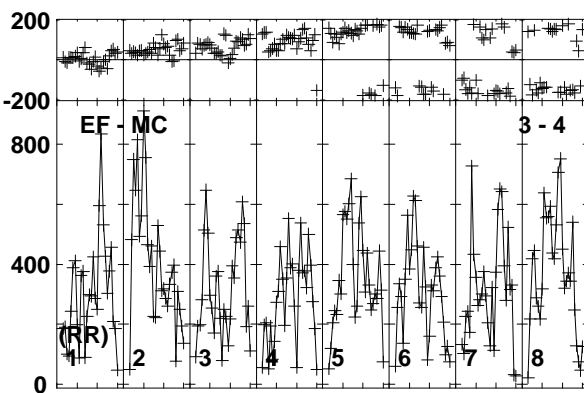
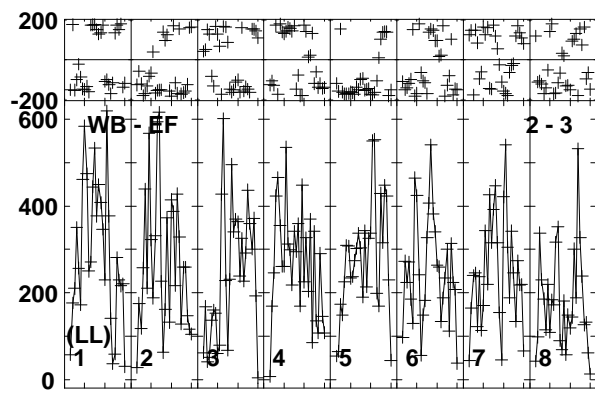
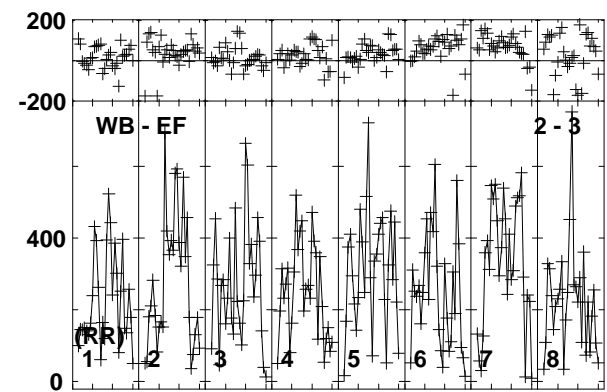
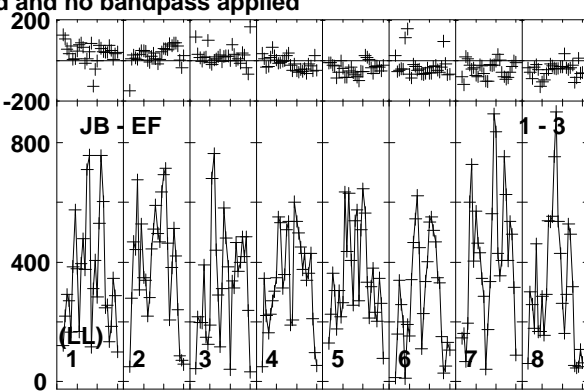
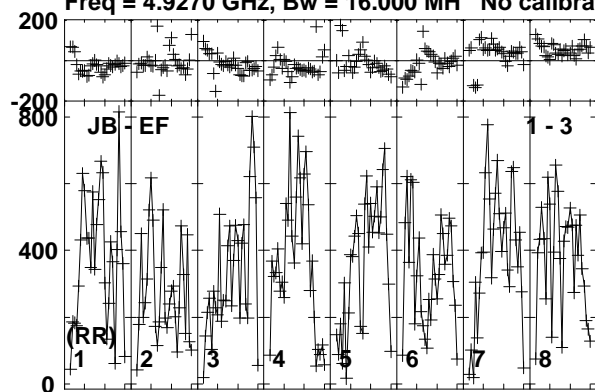

Lower frame: Micro Ampl Jy Top frame: Phas deg  
Vector averaged cross-power spectrum Baseline: JB (01) - EF (03)  
Timerange: 00/14:32:01 to 00/14:32:59



Plot file version 635 created 19-DEC-2018 17:58:58

VLA2 RY007C.UVDATA.1

Freq = 4.9270 GHz, Bw = 16.000 MH No calibration applied and no bandpass applied

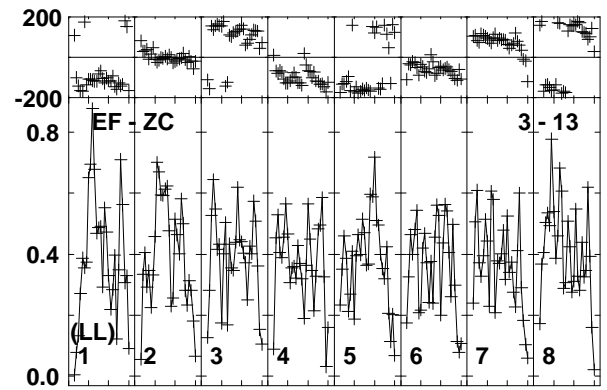
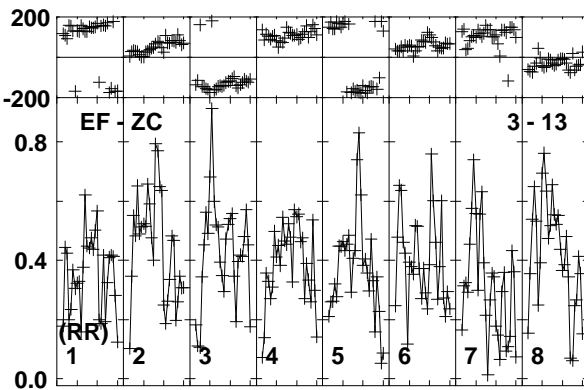
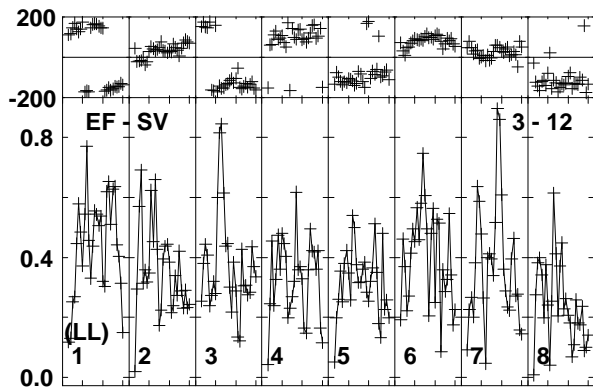
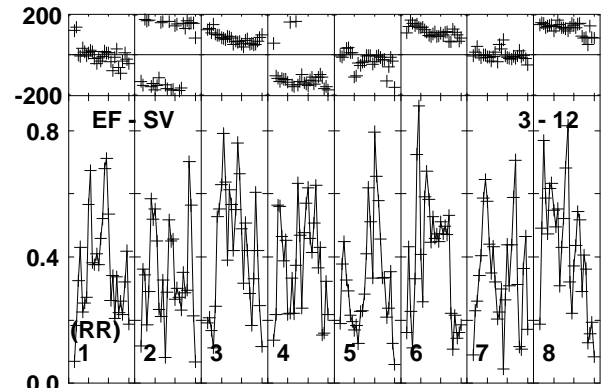
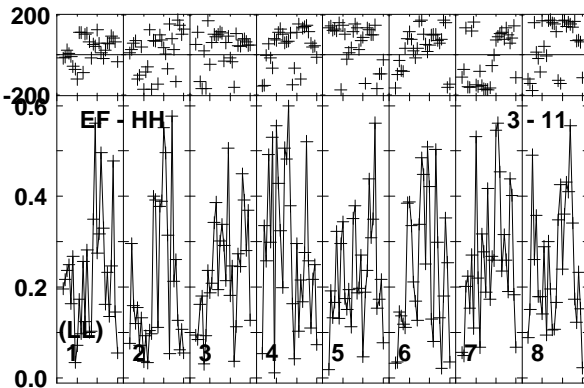
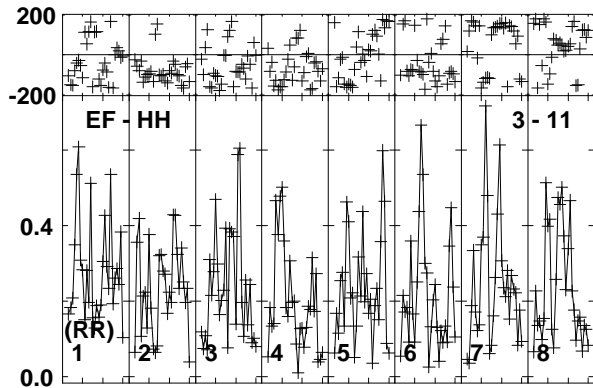
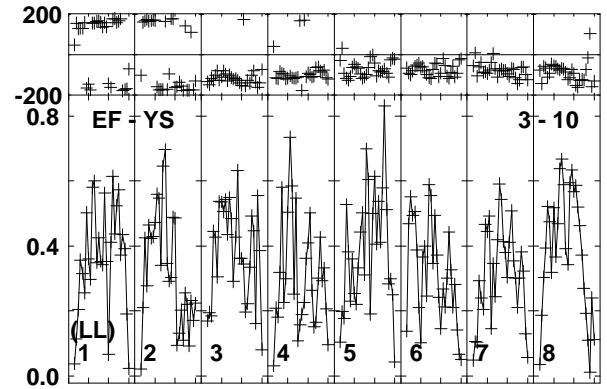
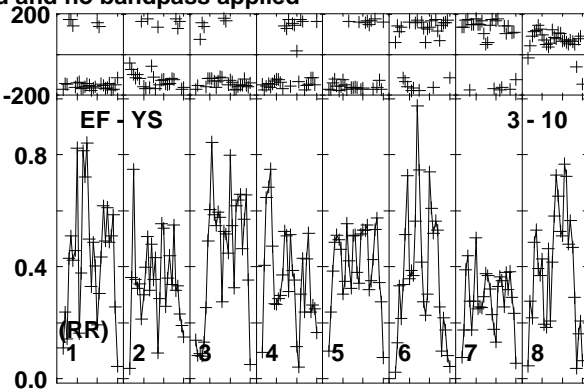
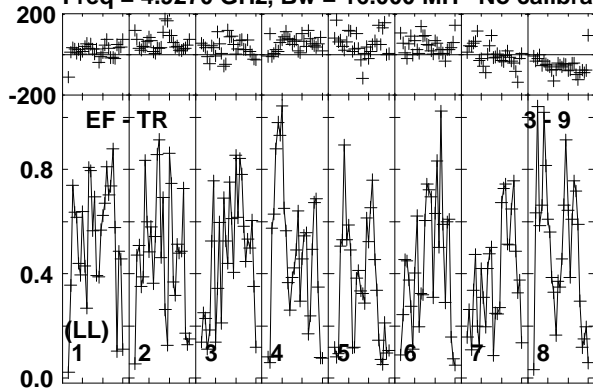

Lower frame: Milli Ampl Jy Top frame: Phas deg  
Vector averaged cross-power spectrum Baseline: EF (03) - TR (09)  
Timerange: 00/14:32:01 to 00/14:32:59

Plot file version 636 created 19-DEC-2018 17:58:58

VLA2 RY007C.UVDATA.1

Freq = 4.9270 GHz, Bw = 16.000 MH No calibration applied and no bandpass applied

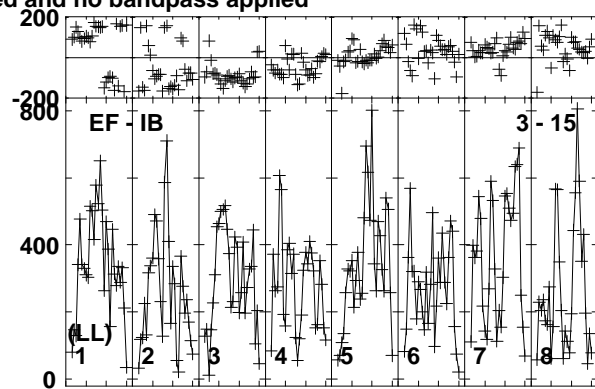
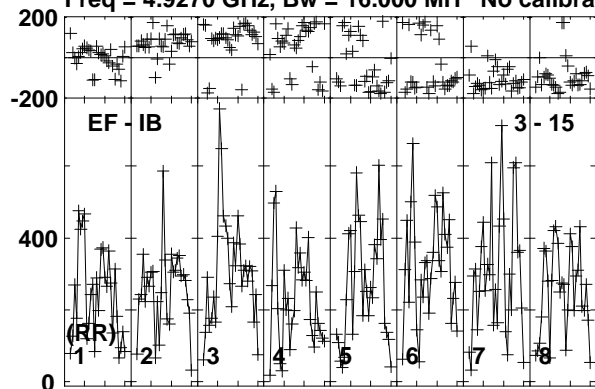

Lower frame: Micro Ampl Jy Top frame: Phas deg  
Vector averaged cross-power spectrum Baseline: EF (03) - IB (15)  
Timerange: 00/14:32:01 to 00/14:32:59

Plot file version 637 created 19-DEC-2018 17:58:58

J1619+2247 RY007C.UVDATA.1

Freq = 4.9270 GHz, Bw = 16.000 MH No calibration applied and no bandpass applied

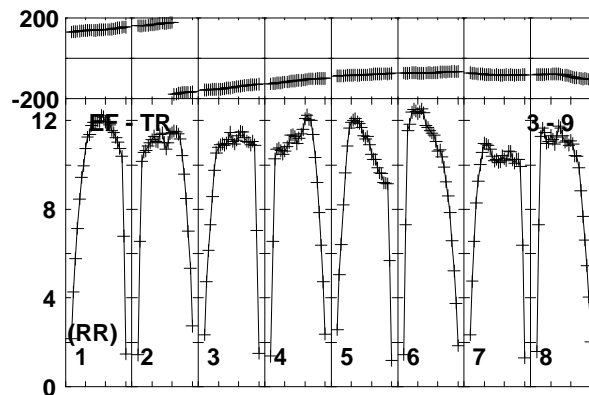
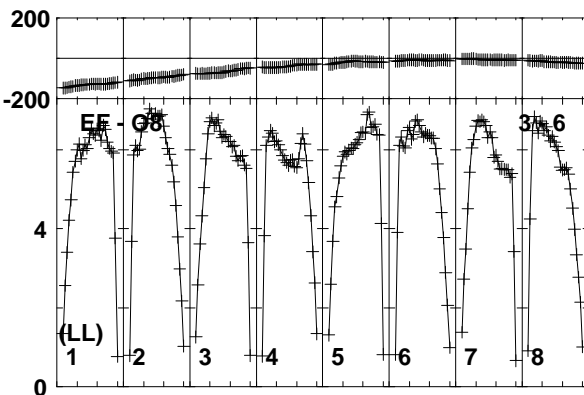
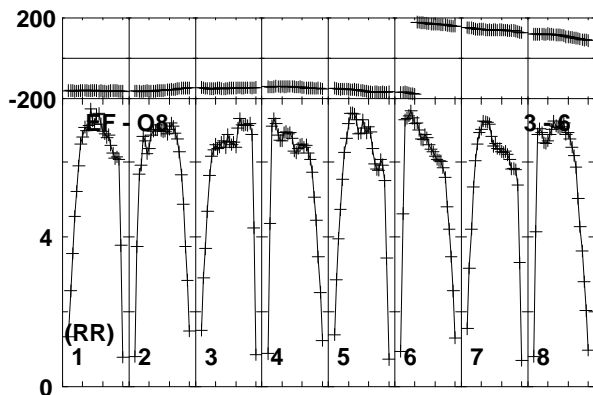
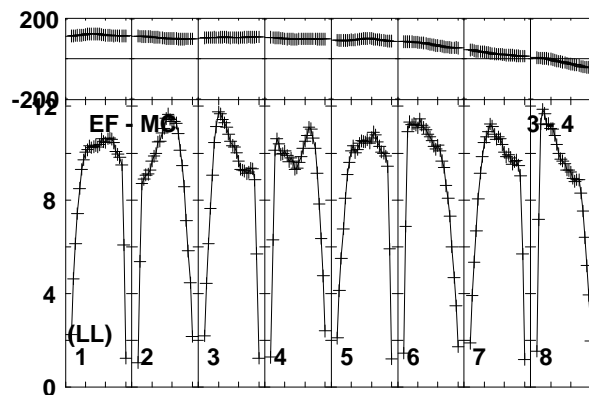
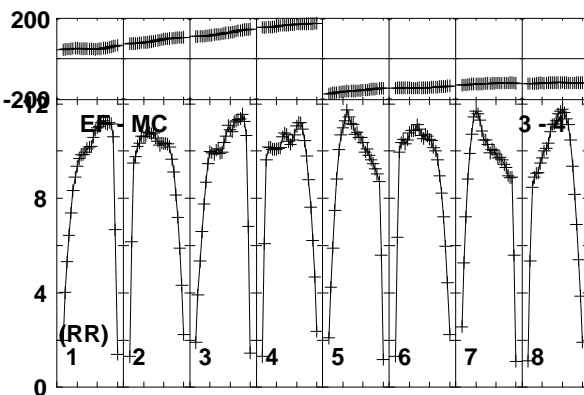
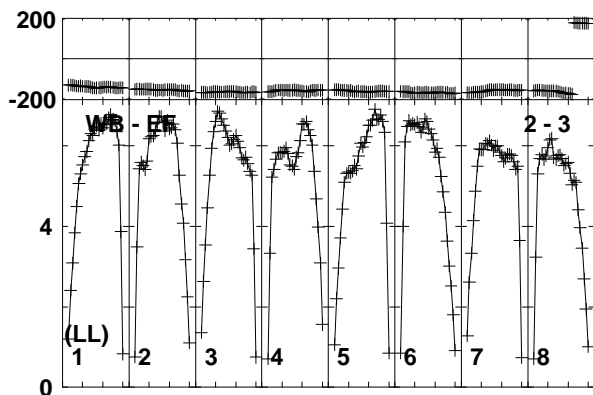
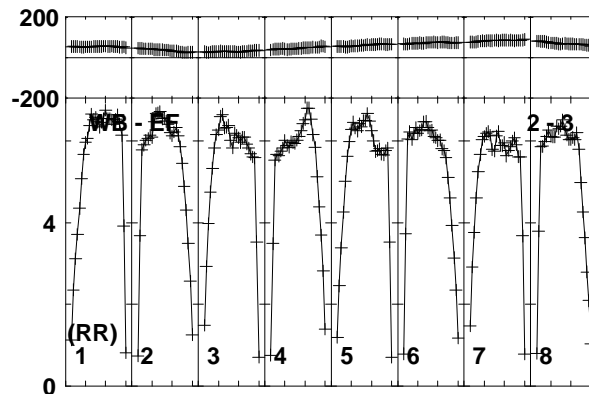
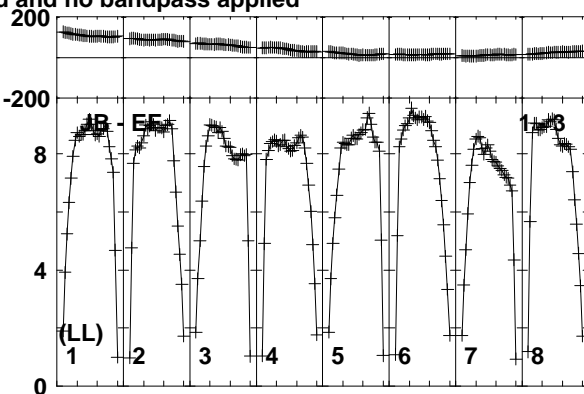
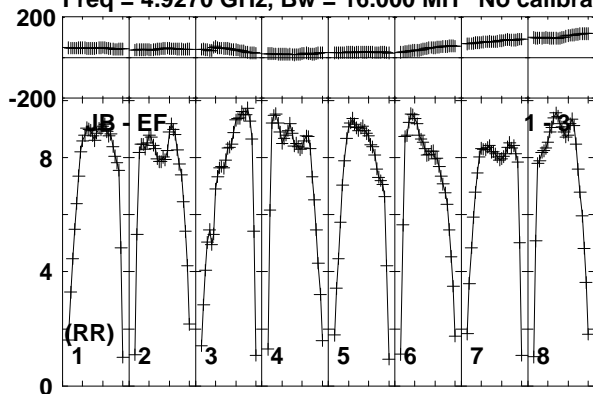

Lower frame: Milli Ampl Jy Top frame: Phas deg  
Vector averaged cross-power spectrum Baseline: JB (01) - EF (03)  
Timerange: 00/14:33:31 to 00/14:34:29

Plot file version 638 created 19-DEC-2018 17:58:58

J1619+2247 RY007C.UVDATA.1

Freq = 4.9270 GHz, Bw = 16.000 MH No calibration applied and no bandpass applied

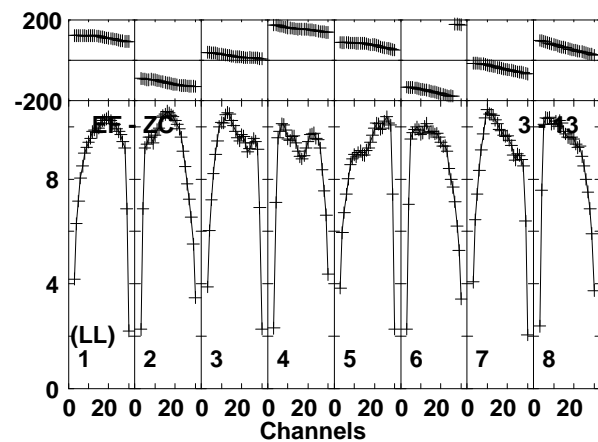
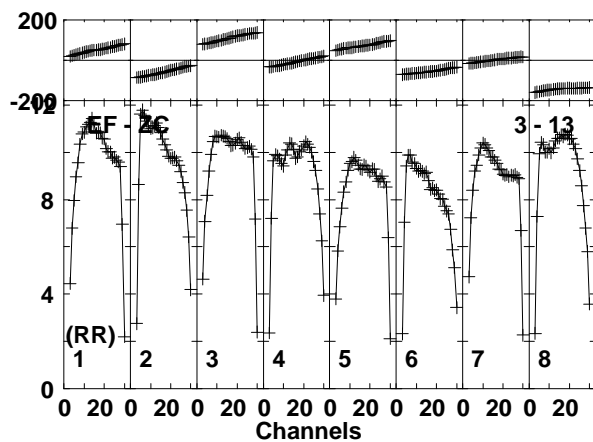
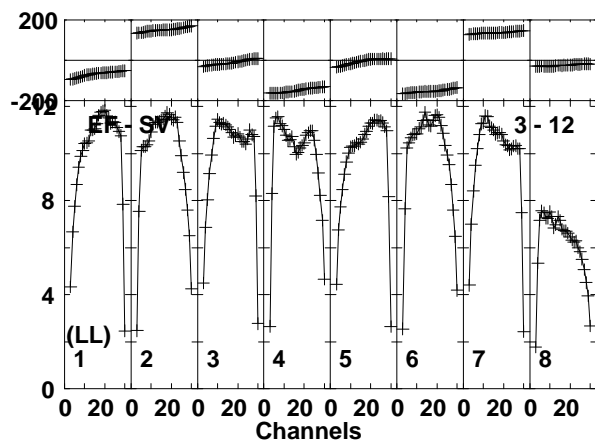
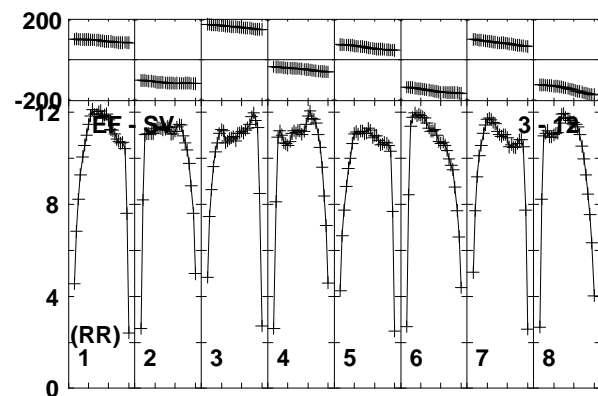
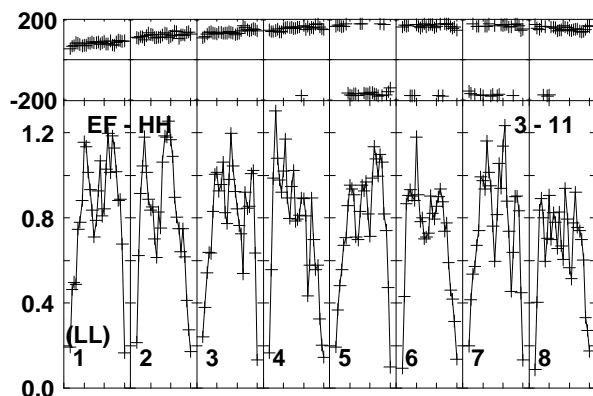
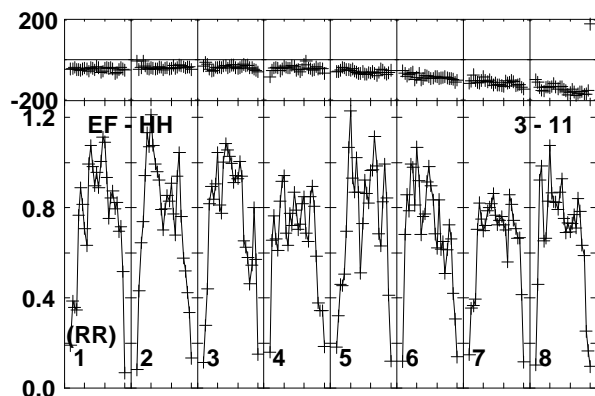
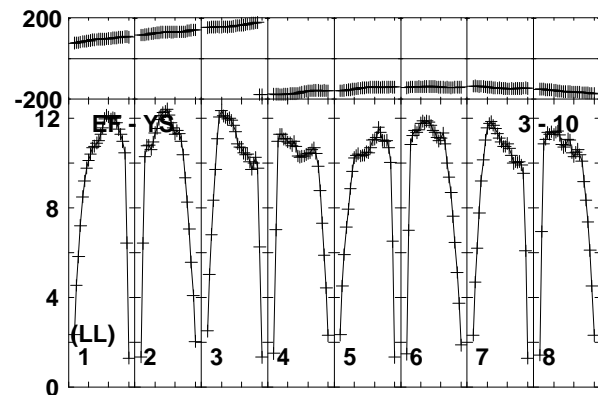
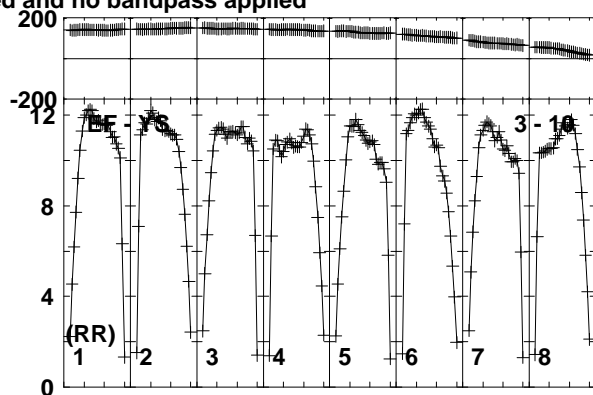
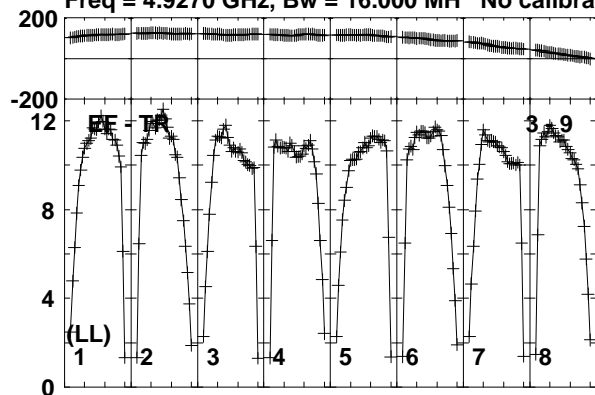

Lower frame: Milli Ampl Jy Top frame: Phas deg  
Vector averaged cross-power spectrum Baseline: EF (03) - TR (09)  
Timerange: 00/14:33:31 to 00/14:34:29

Plot file version 639 created 19-DEC-2018 17:58:58  
J1619+2247 RY007C.UVDATA.1

Freq = 4.9270 GHz, Bw = 16.000 MH No calibration applied and no bandpass applied

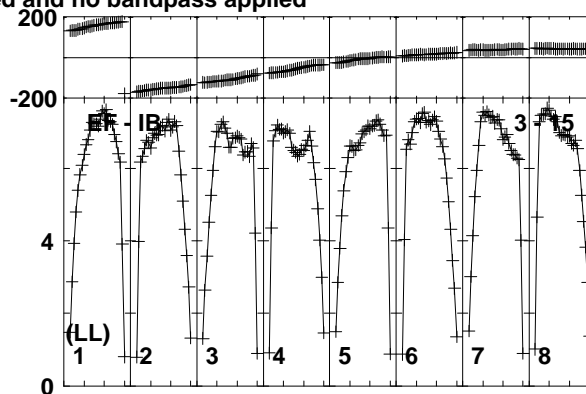
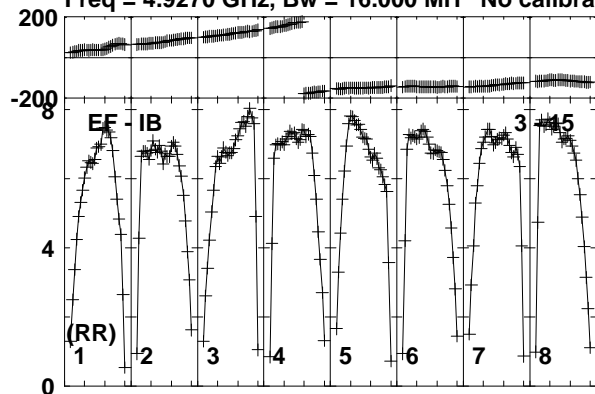

Lower frame: Milli Ampl Jy Top frame: Phas deg  
Vector averaged cross-power spectrum Baseline: EF (03) - IB (15)  
Timerange: 00/14:33:31 to 00/14:34:29

Plot file version 640 created 19-DEC-2018 17:58:58  
 AT2018\_RY007C.UVDATA.1

Freq = 4.9270 GHz, Bw = 16.000 MH No calibration applied and no bandpass applied

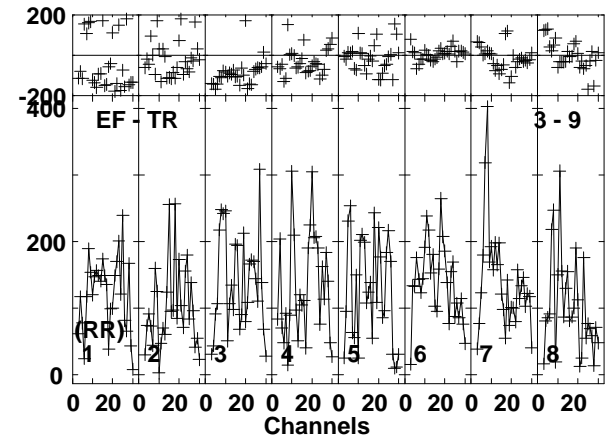
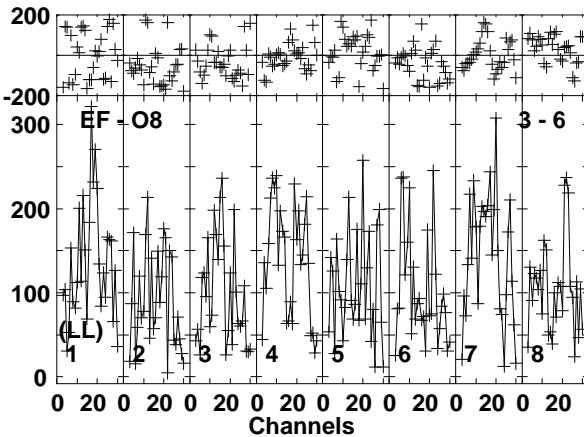
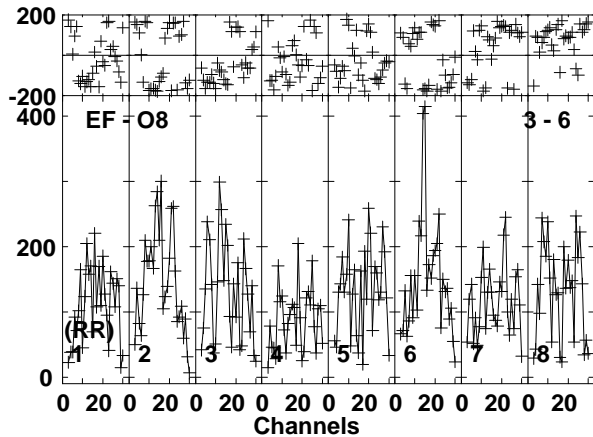
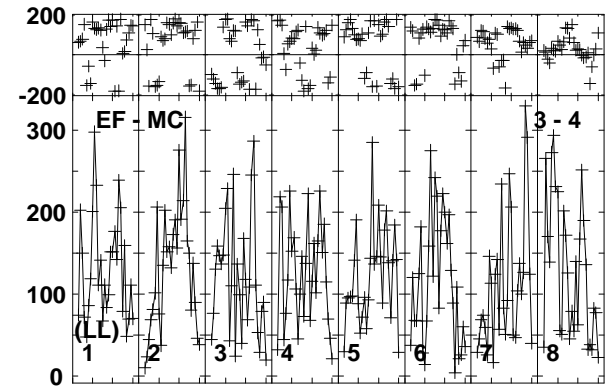
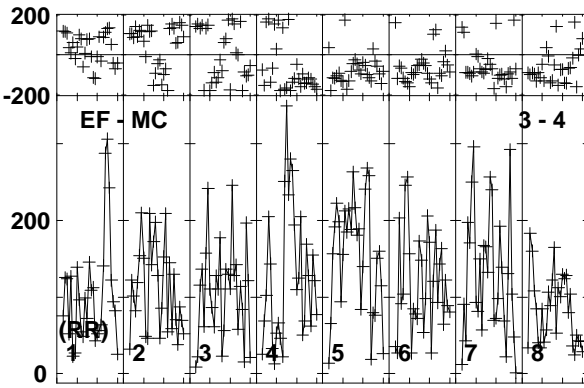
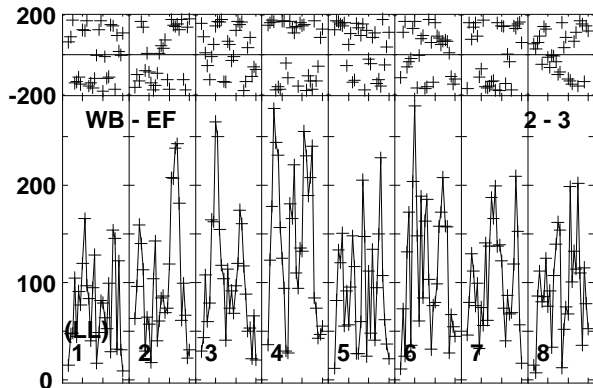
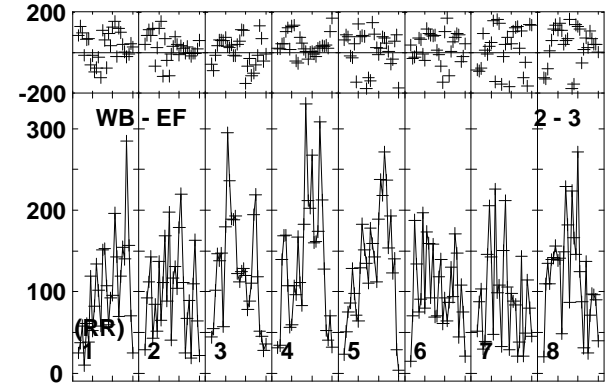
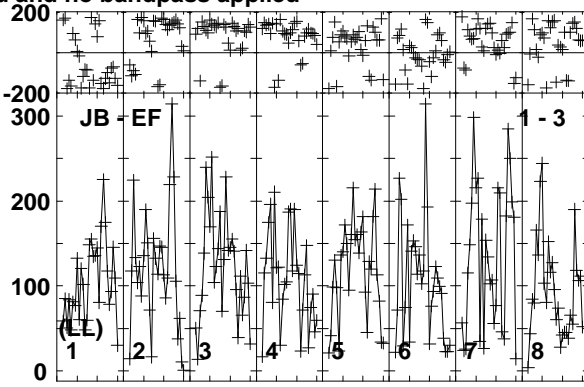
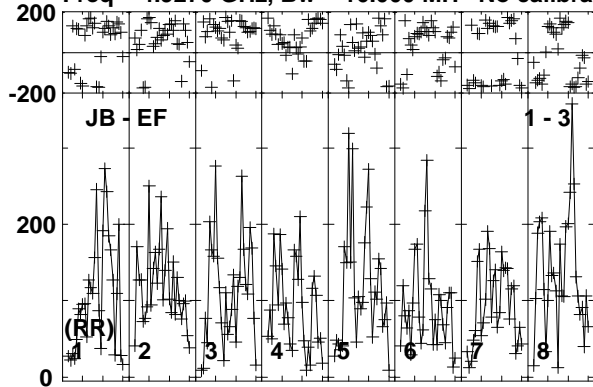

Lower frame: Micro Ampl Jy Top frame: Phas deg  
 Vector averaged cross-power spectrum Baseline: JB (01) - EF (03)  
 Timerange: 00/14:34:31 to 00/14:37:29

Plot file version 641 created 19-DEC-2018 17:58:58

AT2018\_RY007C.UVDATA.1

Freq = 4.9270 GHz, Bw = 16.000 MH No calibration applied and no bandpass applied

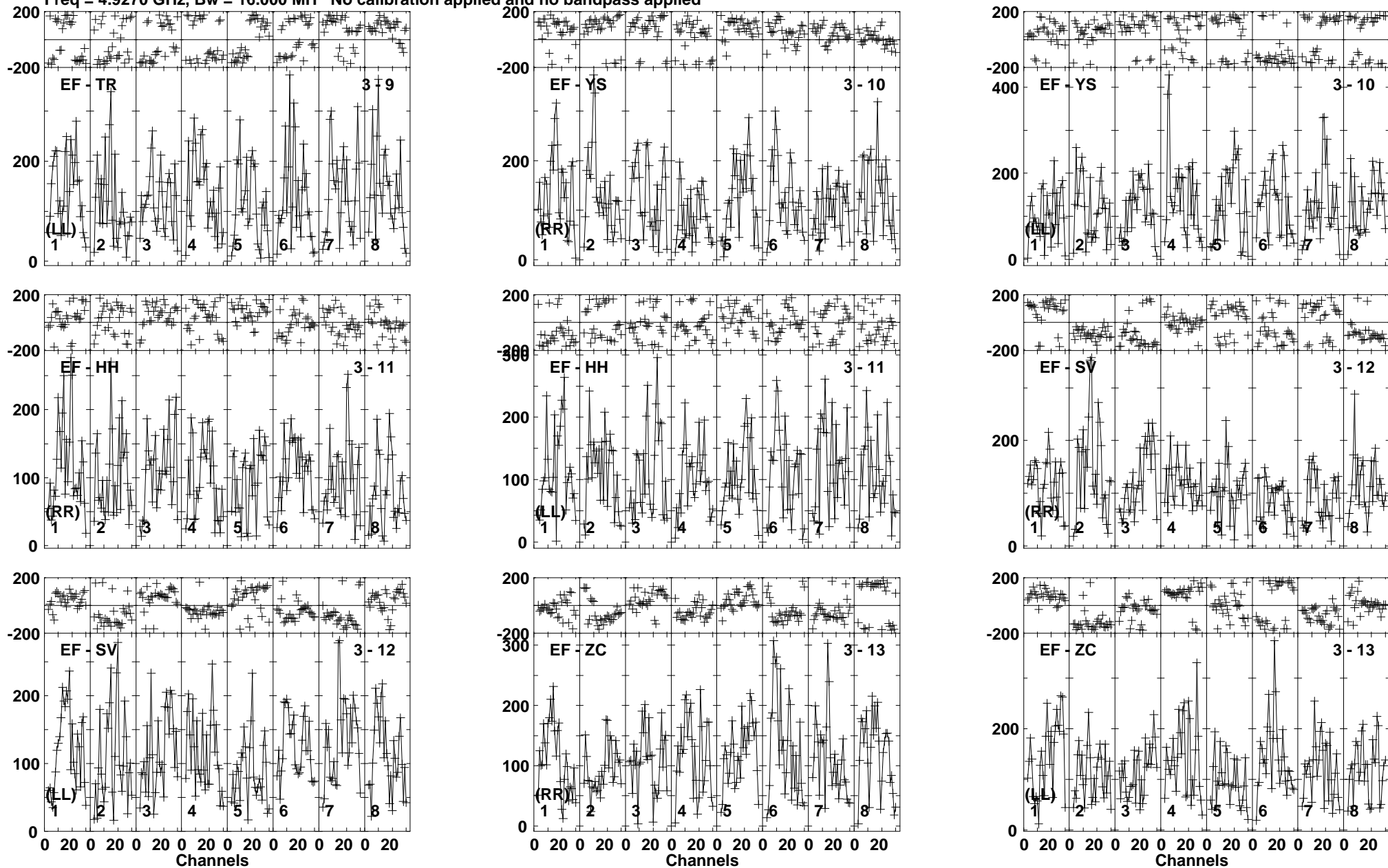

Lower frame: Micro Ampl Jy Top frame: Phas deg  
Vector averaged cross-power spectrum Baseline: EF (03) - TR (09)  
Timerange: 00/14:34:31 to 00/14:37:29

Plot file version 642 created 19-DEC-2018 17:58:58

AT2018 RY007C.UVDATA.1

Freq = 4.9270 GHz, Bw = 16.000 MH No calibration applied and no bandpass applied

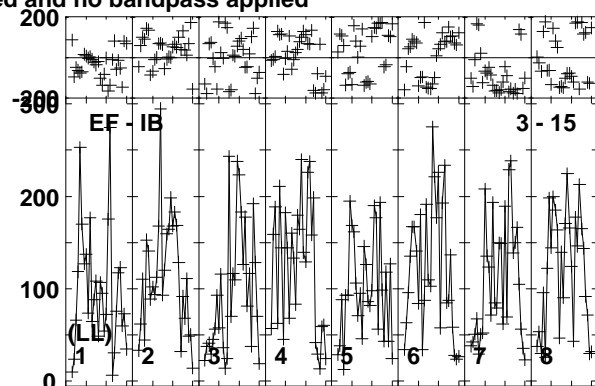
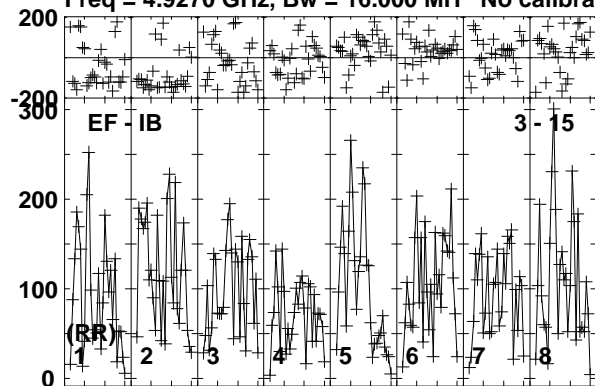

Lower frame: Micro Ampl Jy Top frame: Phas deg  
Vector averaged cross-power spectrum Baseline: EF (03) - IB (15)  
Timerange: 00/14:34:31 to 00/14:37:29



Plot file version 643 created 19-DEC-2018 17:58:58

J1619+2247 RY007C.UVDATA.1

Freq = 4.9270 GHz, Bw = 16.000 MH No calibration applied and no bandpass applied

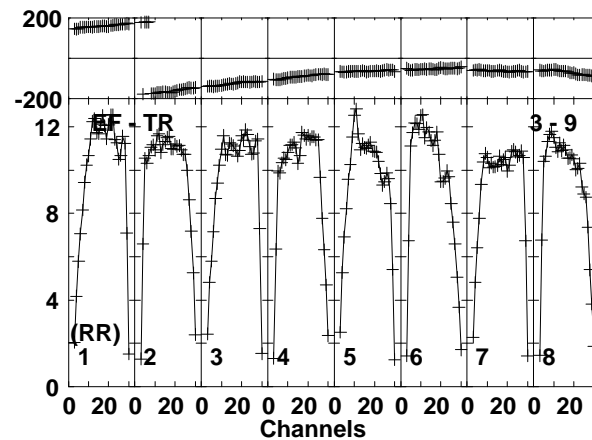
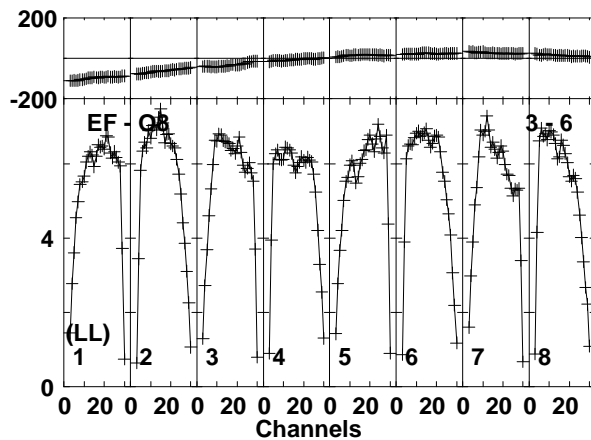
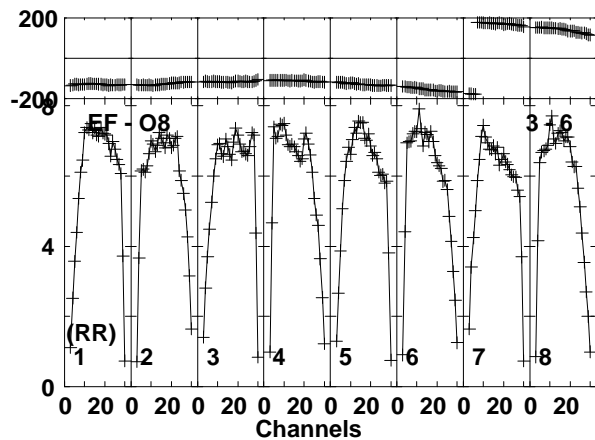
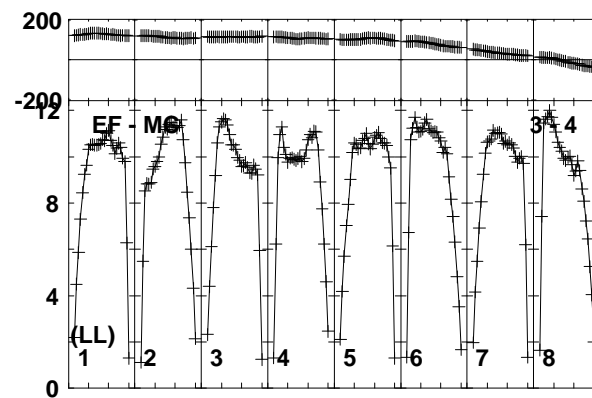
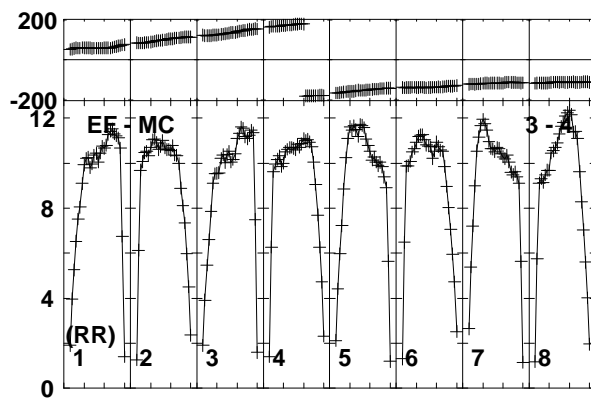
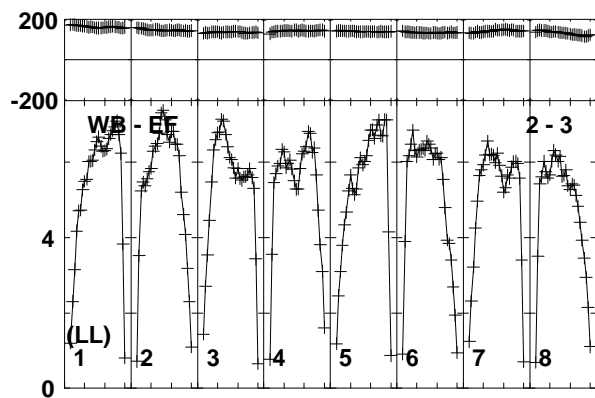
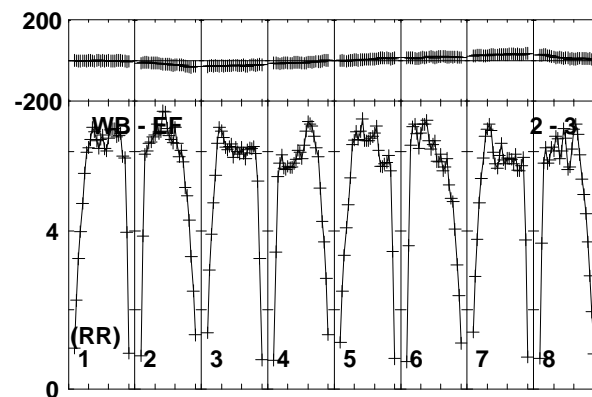
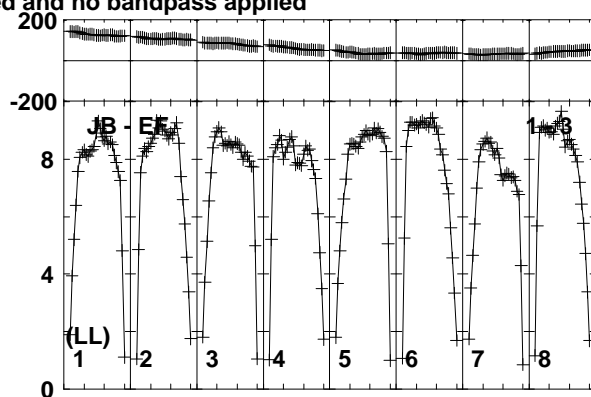
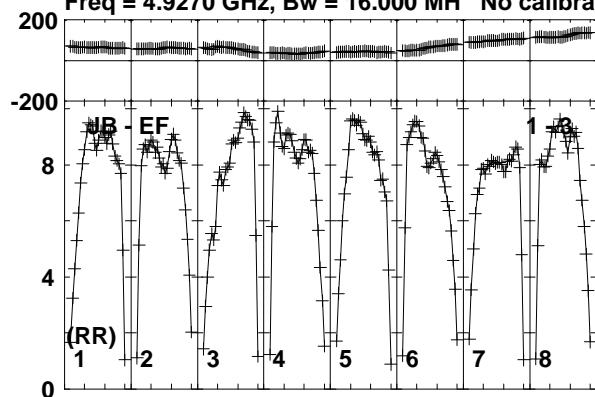

Lower frame: Milli Ampl Jy Top frame: Phas deg  
Vector averaged cross-power spectrum Baseline: JB (01) - EF (03)  
Timerange: 00/14:37:31 to 00/14:38:29

Plot file version 644 created 19-DEC-2018 17:58:58

J1619+2247 RY007C.UVDATA.1

Freq = 4.9270 GHz, Bw = 16.000 MH No calibration applied and no bandpass applied

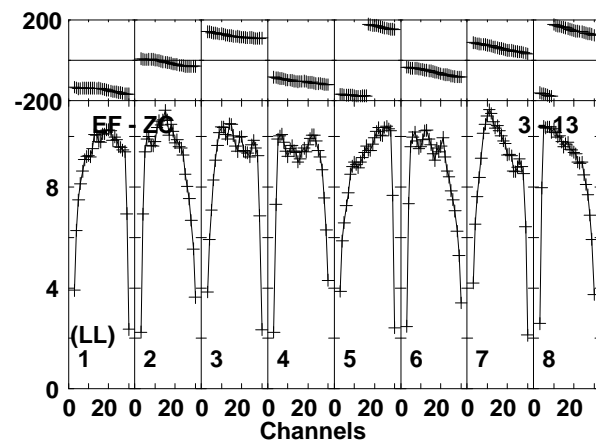
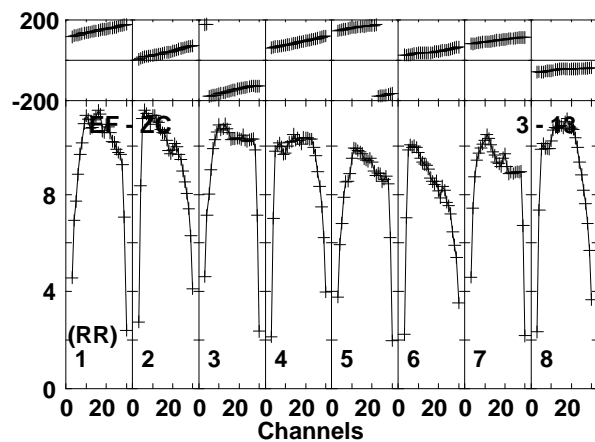
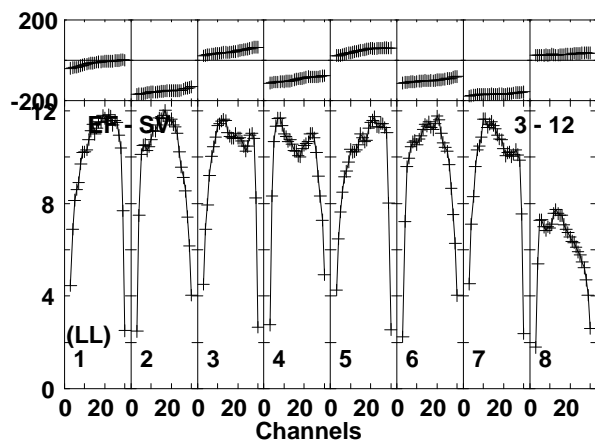
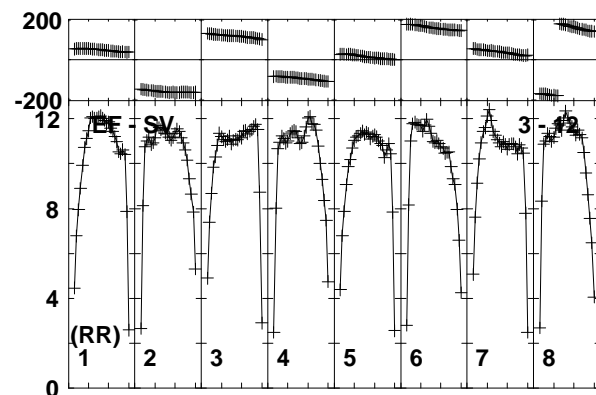
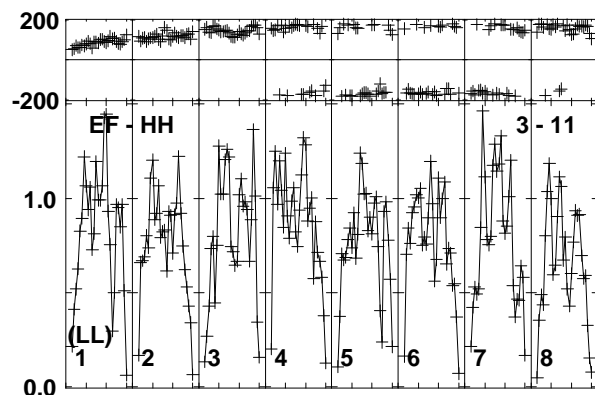
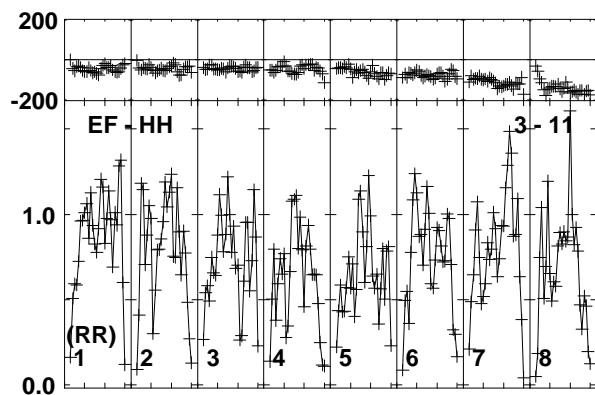
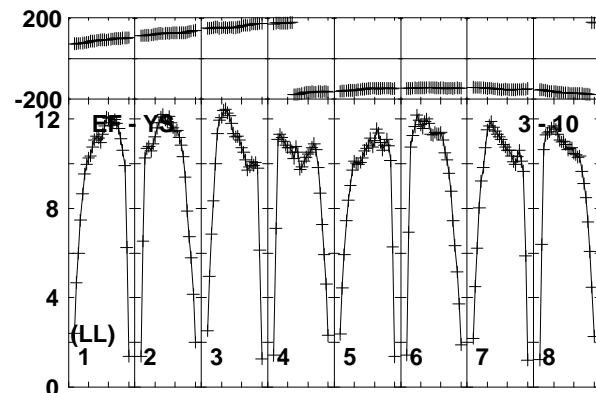
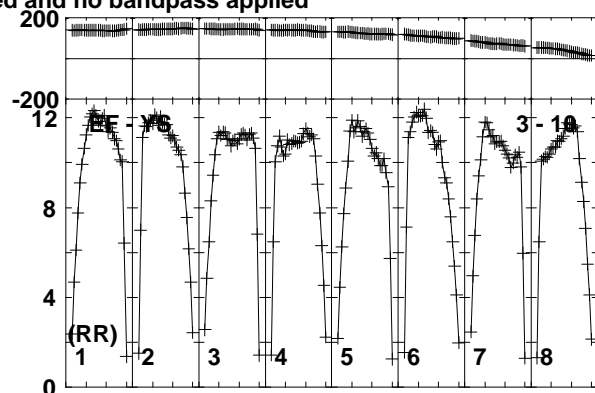
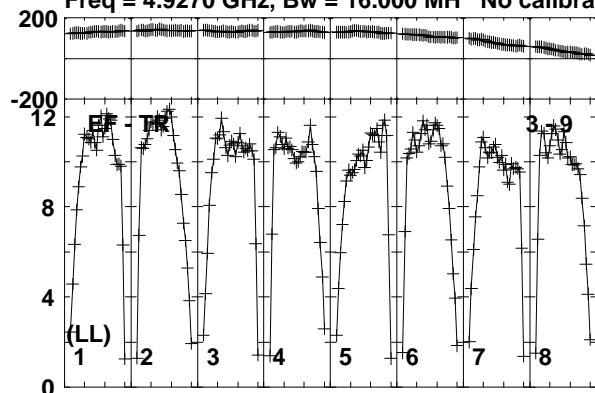

Lower frame: Milli Ampl Jy Top frame: Phas deg  
Vector averaged cross-power spectrum Baseline: EF (03) - TR (09)  
Timerange: 00/14:37:31 to 00/14:38:29

Plot file version 645 created 19-DEC-2018 17:58:59  
J1619+2247 RY007C.UVDATA.1

Freq = 4.9270 GHz, Bw = 16.000 MH No calibration applied and no bandpass applied

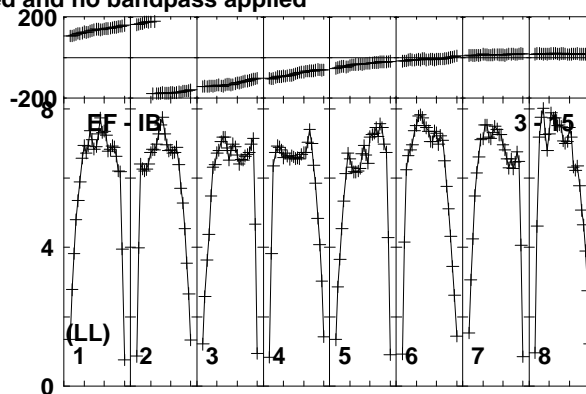
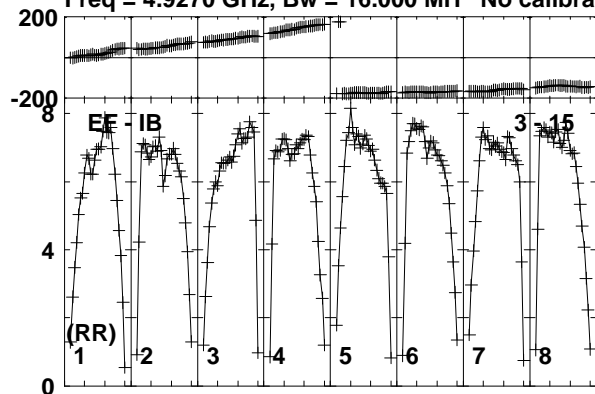

Lower frame: Milli Ampl Jy Top frame: Phas deg  
Vector averaged cross-power spectrum Baseline: EF (03) - IB (15)  
Timerange: 00/14:37:31 to 00/14:38:29

Plot file version 646 created 19-DEC-2018 17:58:59  
 AT2018\_RY007C.UVDATA.1

Freq = 4.9270 GHz, Bw = 16.000 MH No calibration applied and no bandpass applied

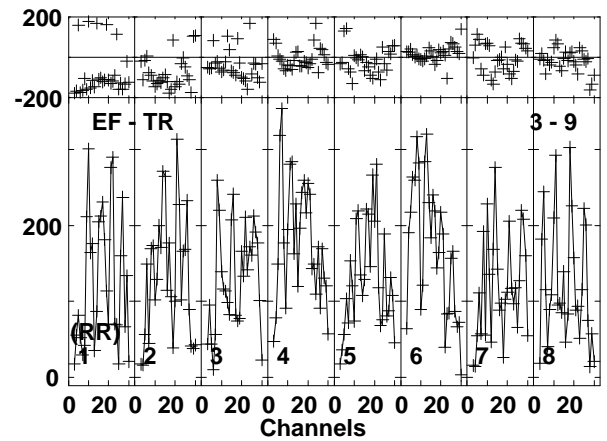
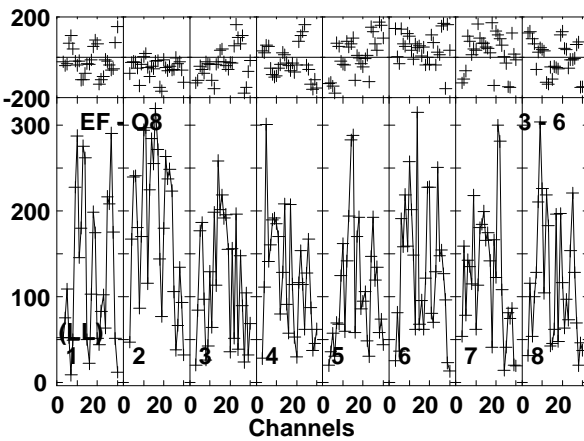
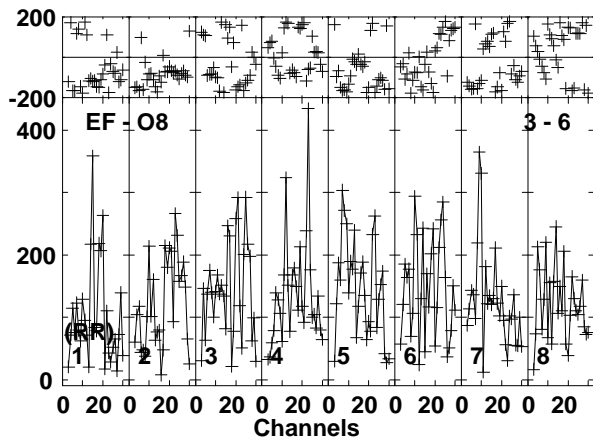
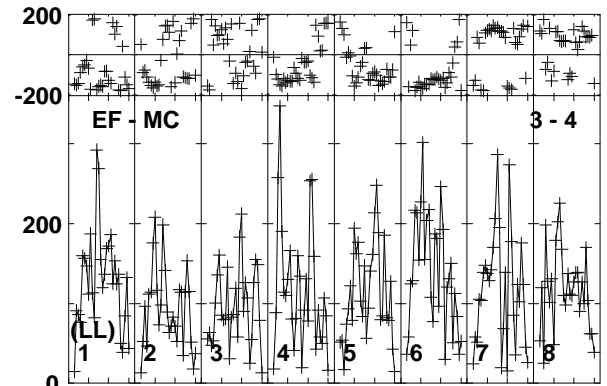
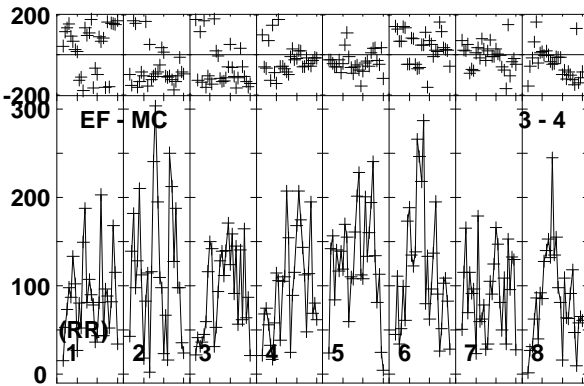
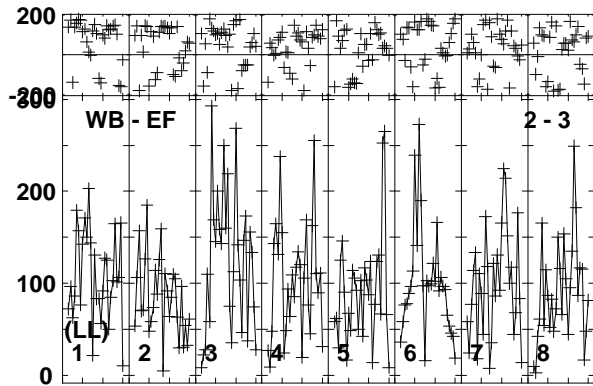
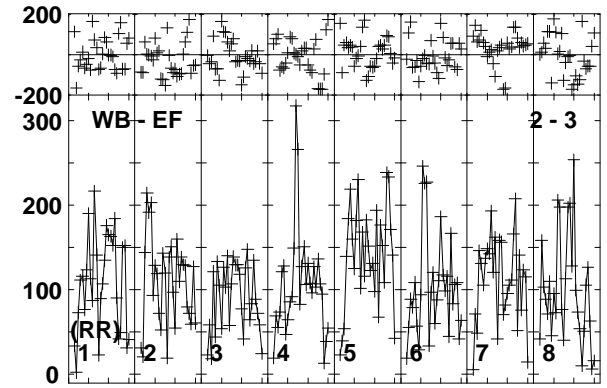
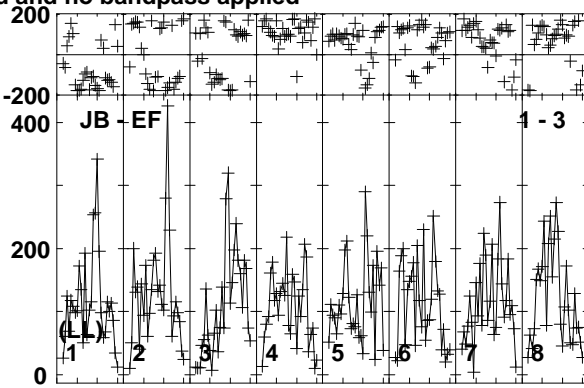
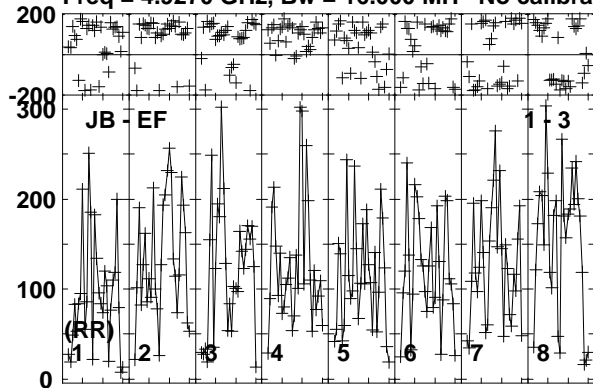

Lower frame: Micro Ampl Jy Top frame: Phas deg  
 Vector averaged cross-power spectrum Baseline: JB (01) - EF (03)  
 Timerange: 00/14:38:31 to 00/14:41:29

Plot file version 647 created 19-DEC-2018 17:58:59

AT2018\_RY007C.UVDATA.1

Freq = 4.9270 GHz, Bw = 16.000 MH No calibration applied and no bandpass applied

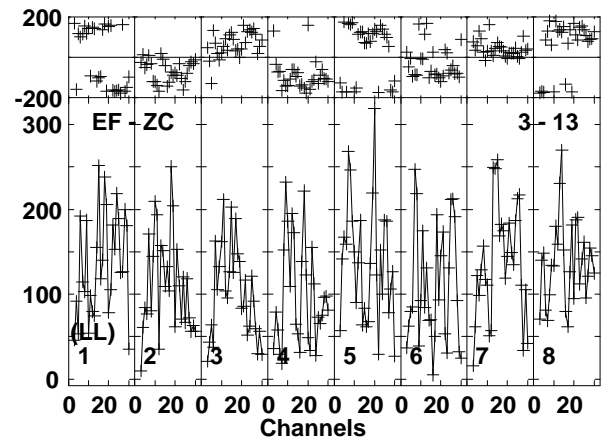
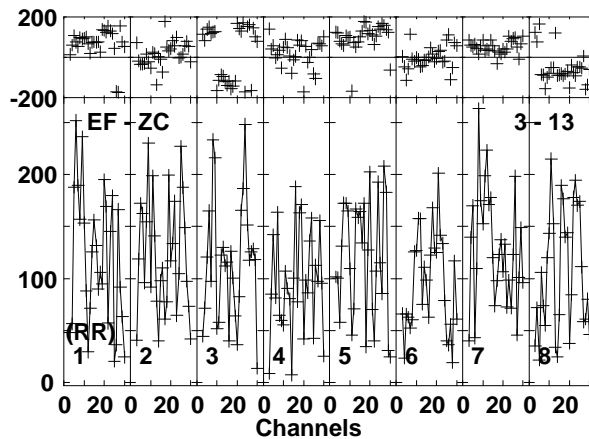
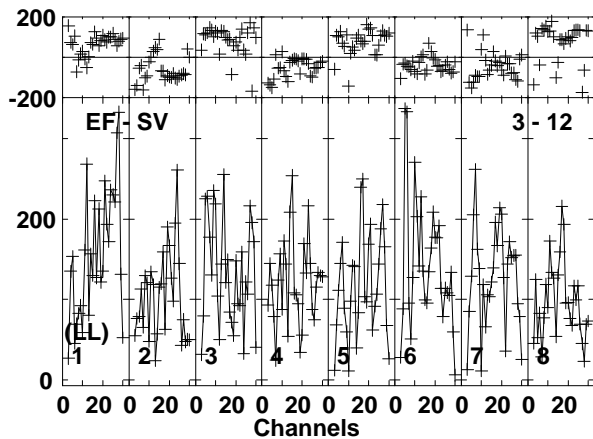
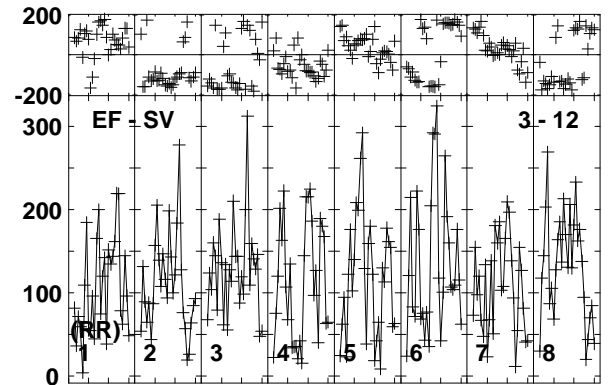
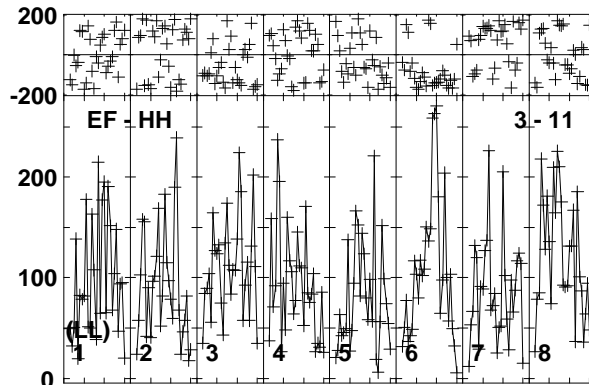
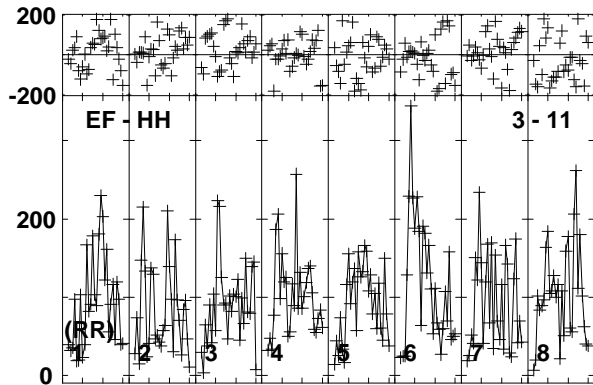
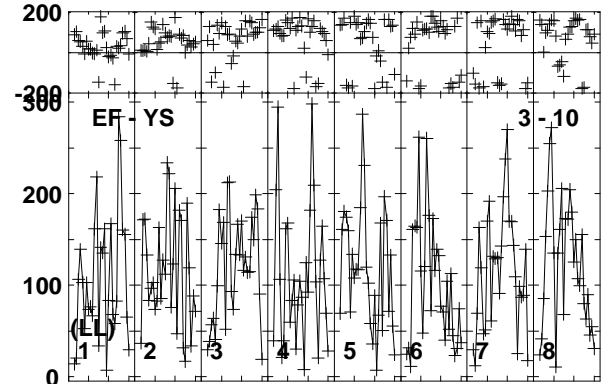
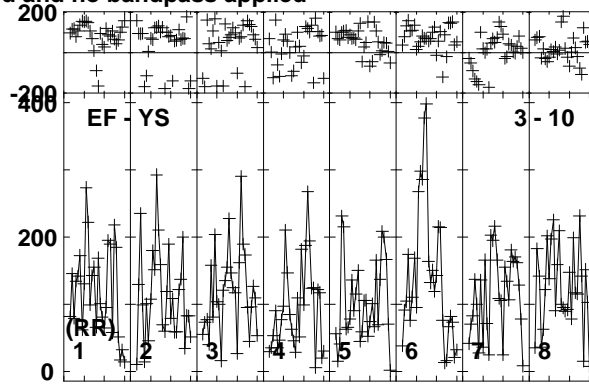
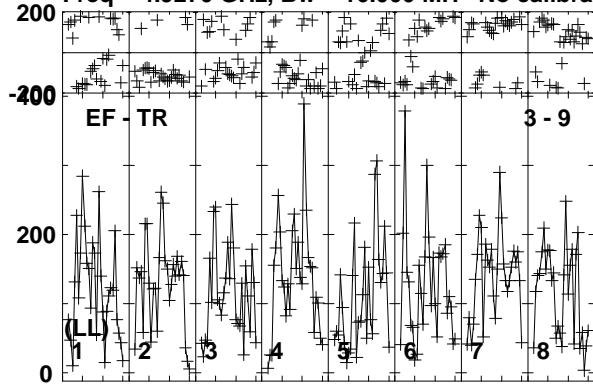

Lower frame: Micro Ampl Jy Top frame: Phas deg  
Vector averaged cross-power spectrum Baseline: EF (03) - TR (09)  
Timerange: 00/14:38:31 to 00/14:41:29

Plot file version 648 created 19-DEC-2018 17:58:59

AT2018\_RY007C.UVDATA.1

Freq = 4.9270 GHz, Bw = 16.000 MH No calibration applied and no bandpass applied

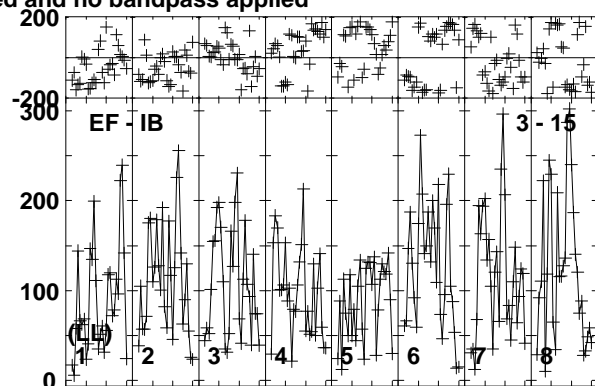
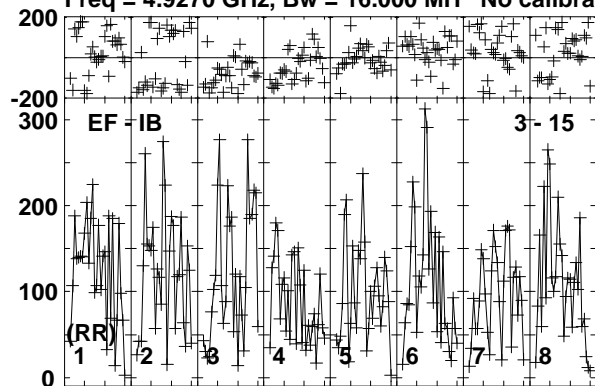

Lower frame: Micro Ampl Jy Top frame: Phas deg  
Vector averaged cross-power spectrum Baseline: EF (03) - IB (15)  
Timerange: 00/14:38:31 to 00/14:41:29

Plot file version 649 created 19-DEC-2018 17:58:59

J1619+2247 RY007C.UVDATA.1

Freq = 4.9270 GHz, Bw = 16.000 MH No calibration applied and no bandpass applied

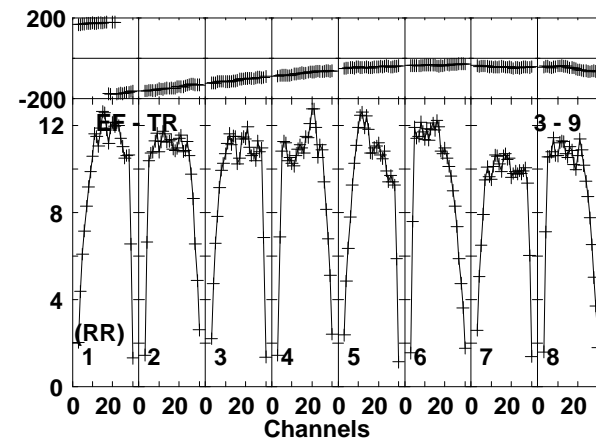
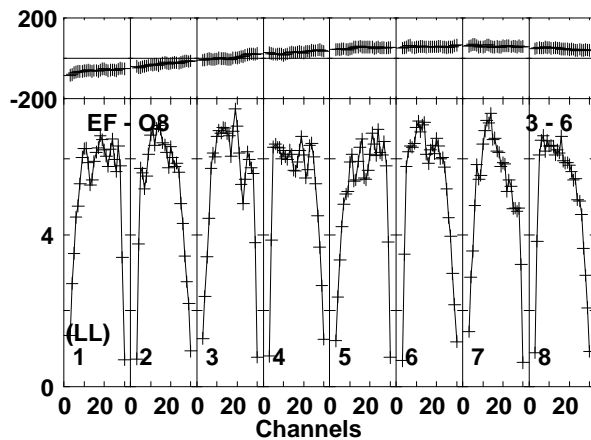
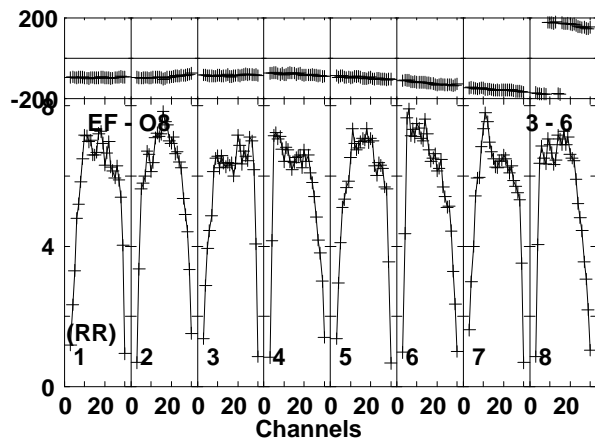
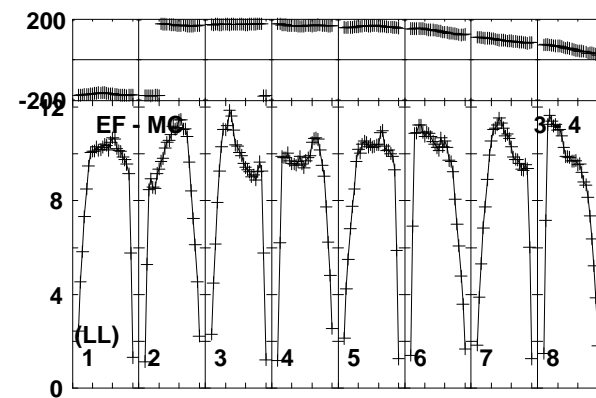
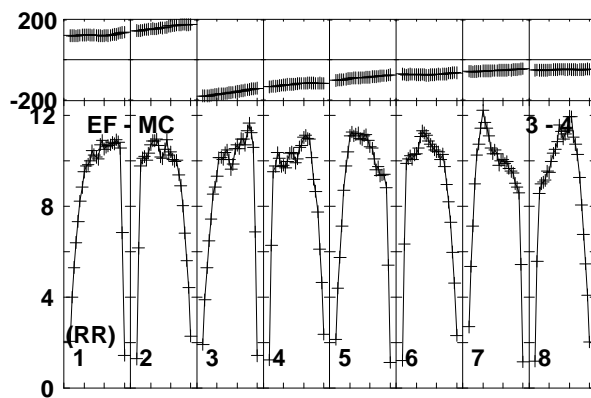
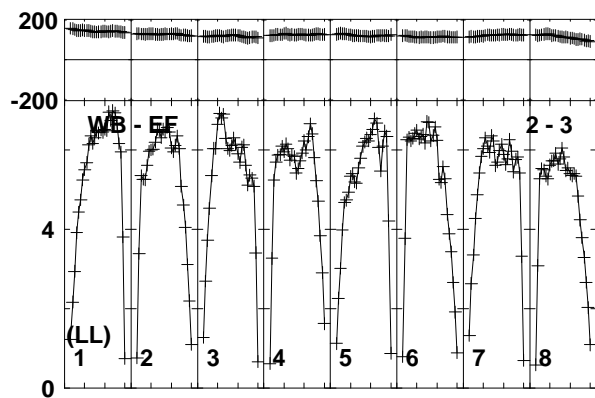
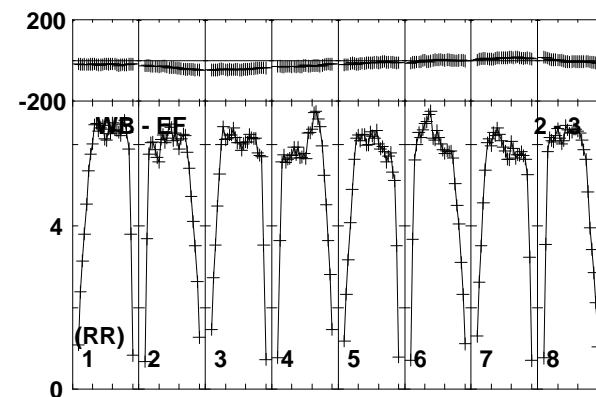
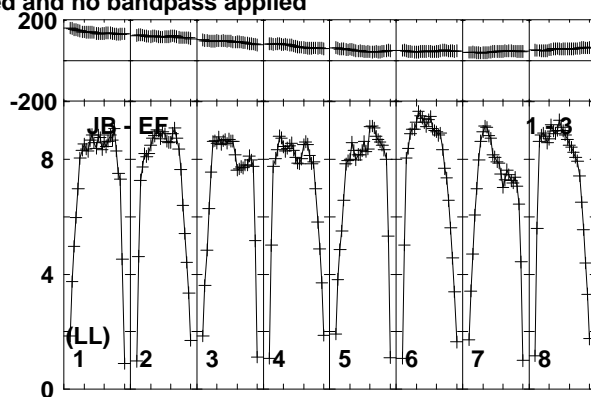
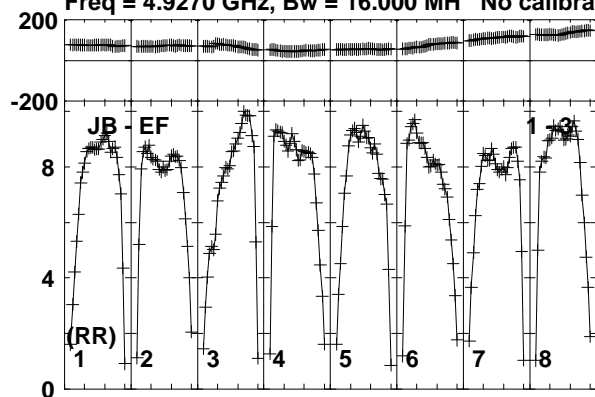

Lower frame: Milli Ampl Jy Top frame: Phas deg  
Vector averaged cross-power spectrum Baseline: JB (01) - EF (03)  
Timerange: 00/14:41:31 to 00/14:42:29

Plot file version 650 created 19-DEC-2018 17:58:59

J1619+2247 RY007C.UVDATA.1

Freq = 4.9270 GHz, Bw = 16.000 MH No calibration applied and no bandpass applied

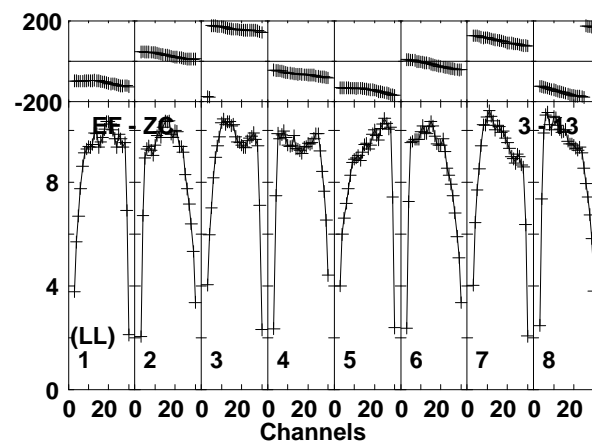
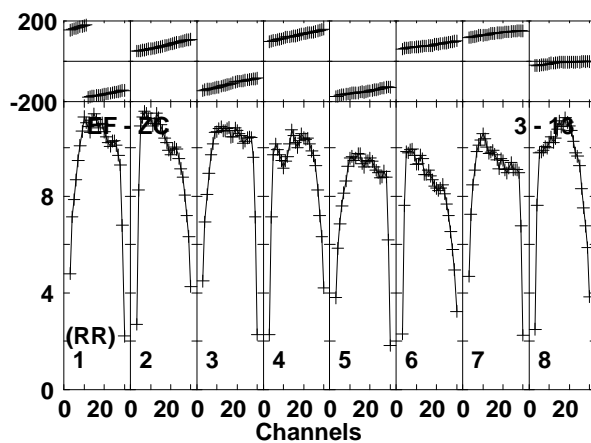
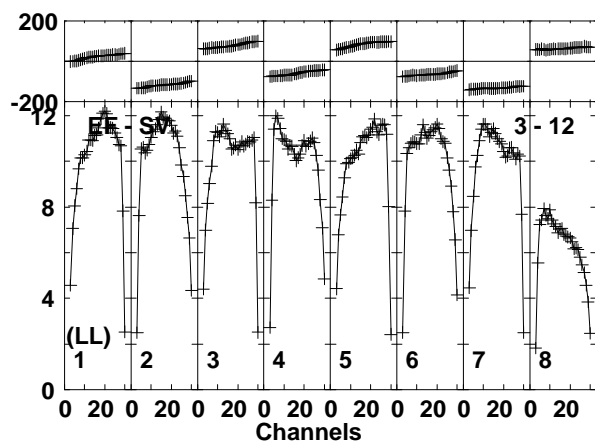
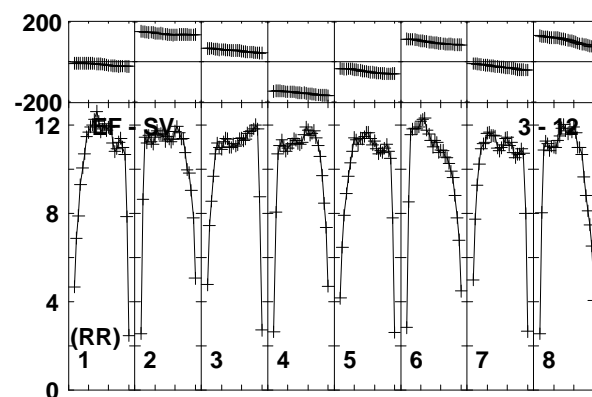
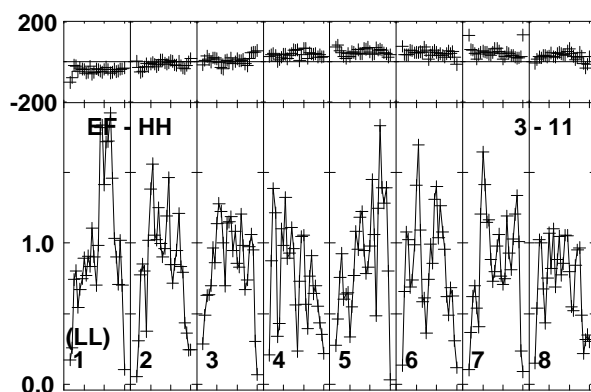
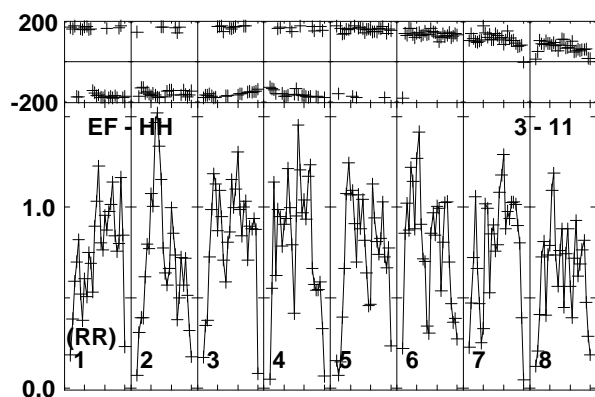
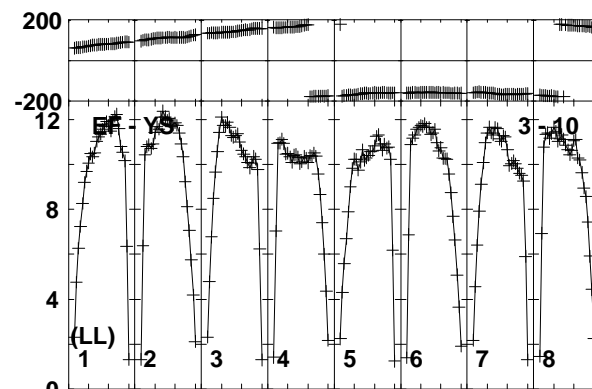
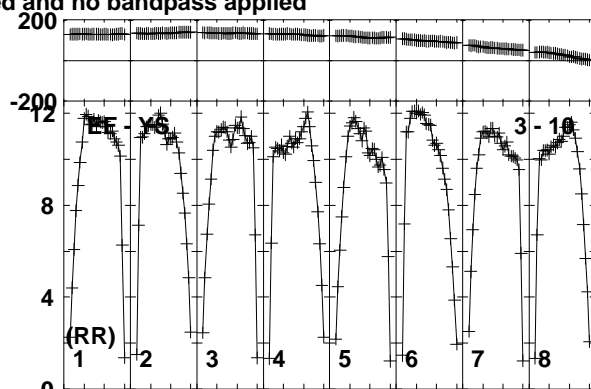
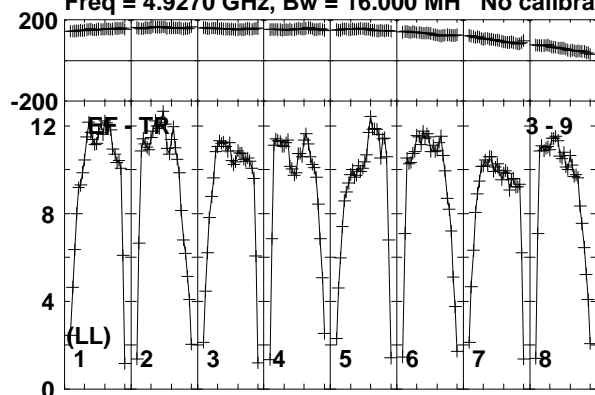

Lower frame: Milli Ampl Jy Top frame: Phas deg  
Vector averaged cross-power spectrum Baseline: EF (03) - TR (09)  
Timerange: 00/14:41:31 to 00/14:42:29



Plot file version 651 created 19-DEC-2018 17:58:59  
J1619+2247 RY007C.UVDATA.1

Freq = 4.9270 GHz, Bw = 16.000 MH No calibration applied and no bandpass applied

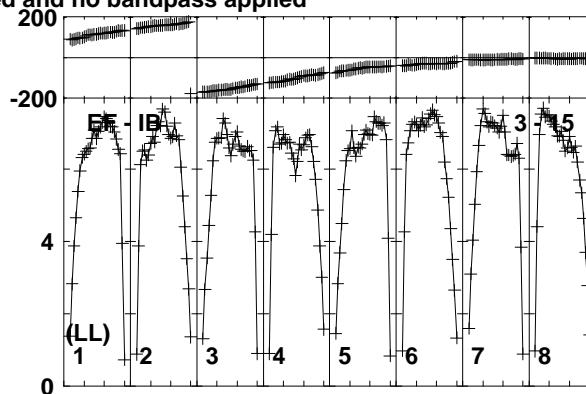
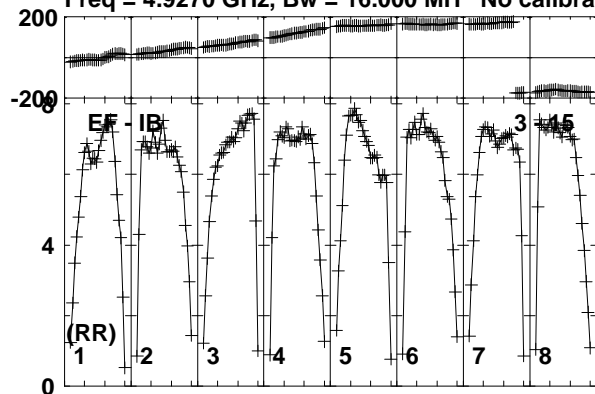

Lower frame: Milli Ampl Jy Top frame: Phas deg  
Vector averaged cross-power spectrum Baseline: EF (03) - IB (15)  
Timerange: 00/14:41:31 to 00/14:42:29

Plot file version 652 created 19-DEC-2018 17:58:59

VLA1 RY007C.UVDATA.1

Freq = 4.9270 GHz, Bw = 16.000 MH No calibration applied and no bandpass applied

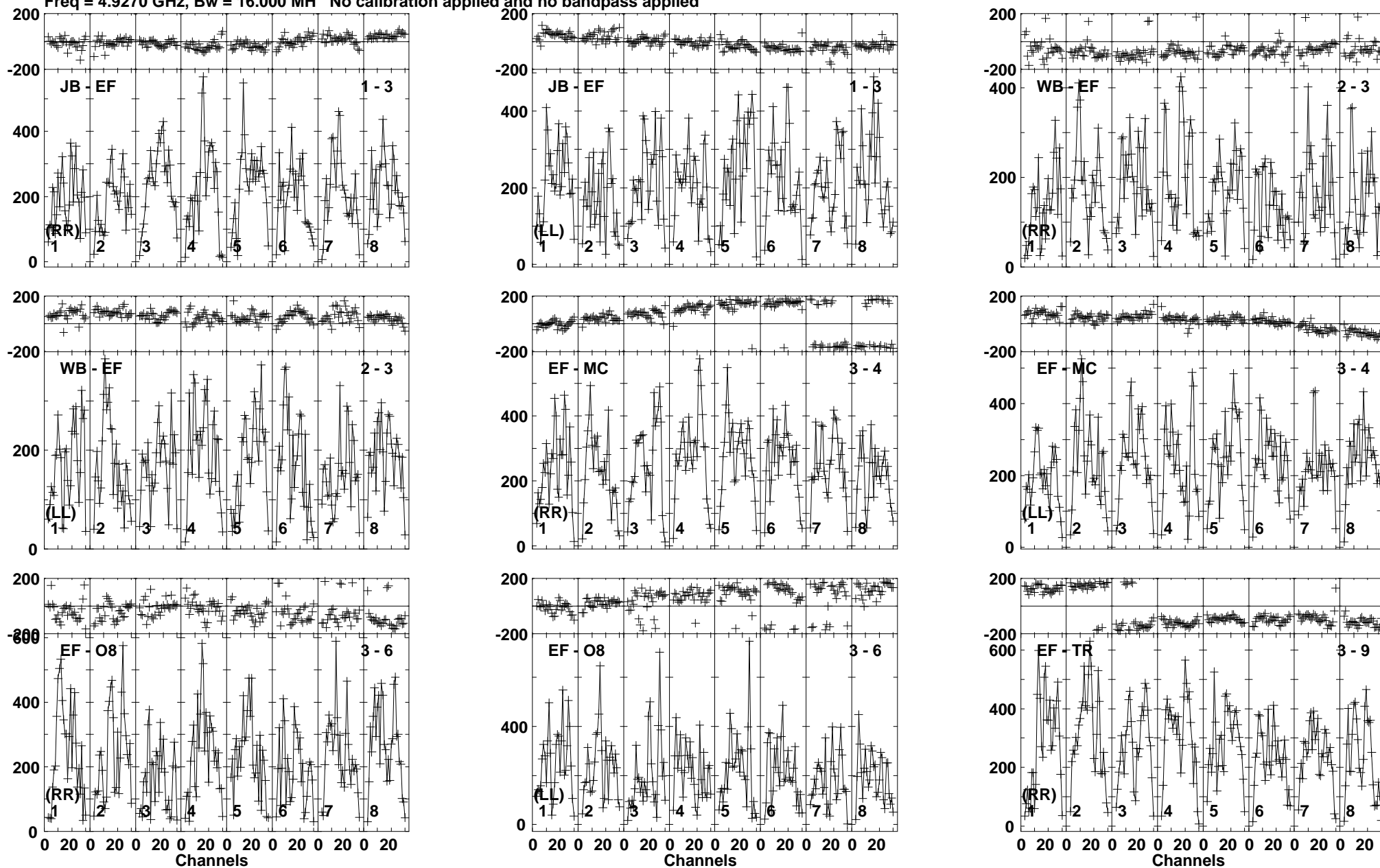

Lower frame: Micro Ampl Jy Top frame: Phas deg  
Vector averaged cross-power spectrum Baseline: JB (01) - EF (03)  
Timerange: 00/14:43:01 to 00/14:44:59

Plot file version 653 created 19-DEC-2018 17:58:59

VLA1 RY007C.UVDATA.1

Freq = 4.9270 GHz, Bw = 16.000 MH No calibration applied and no bandpass applied

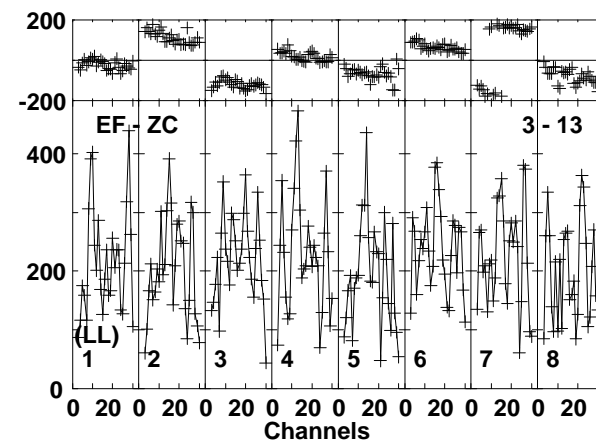
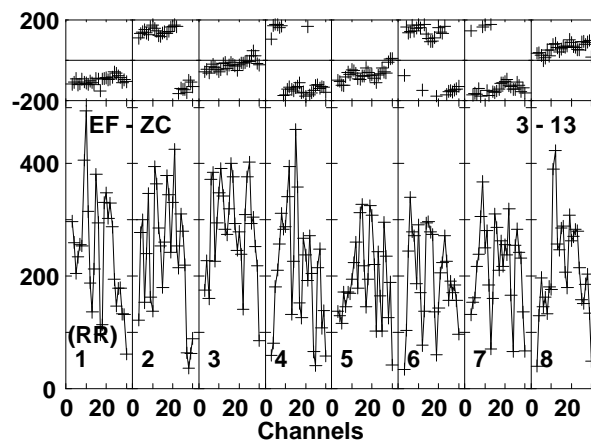
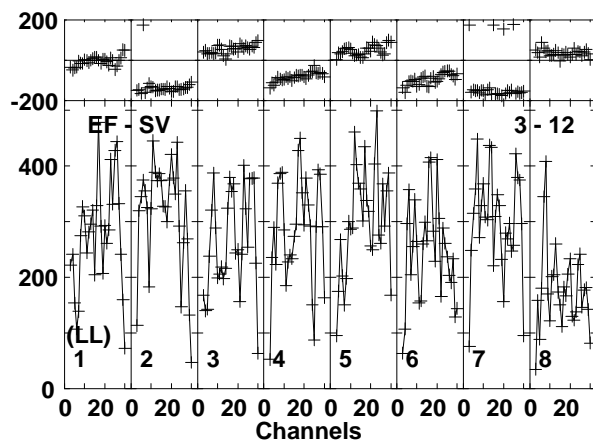
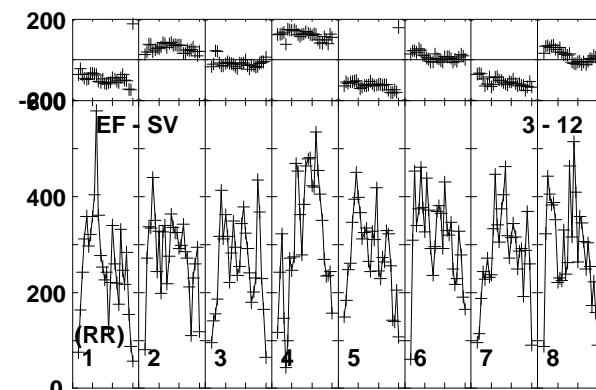
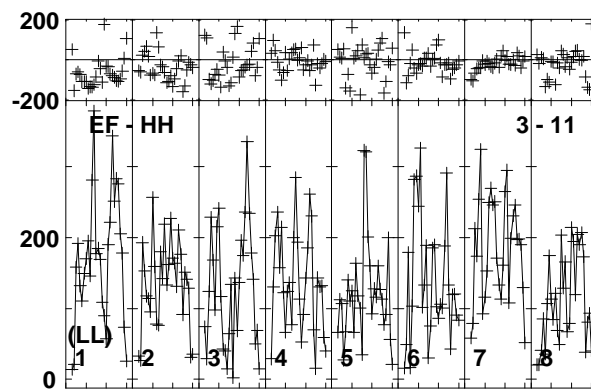
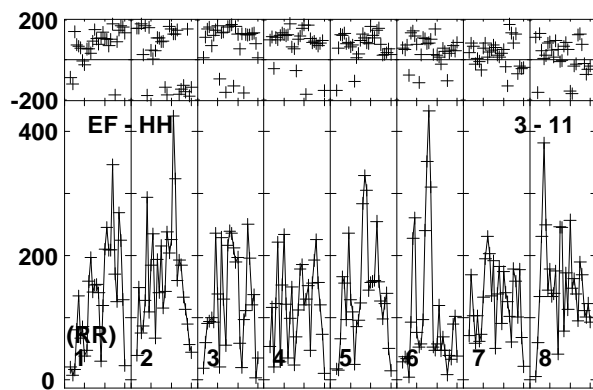
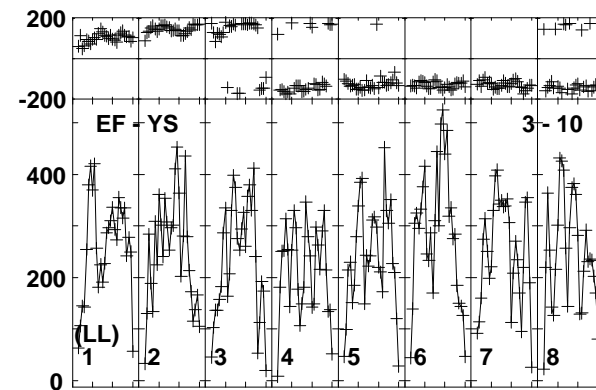
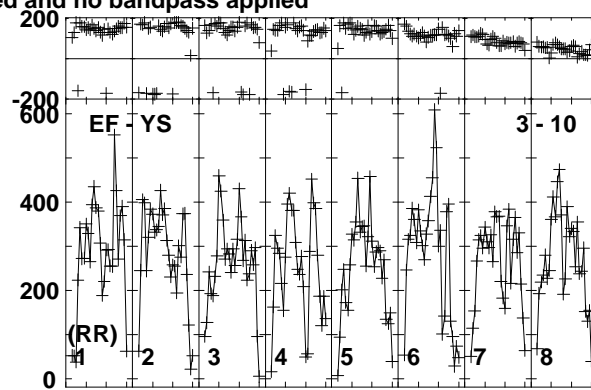
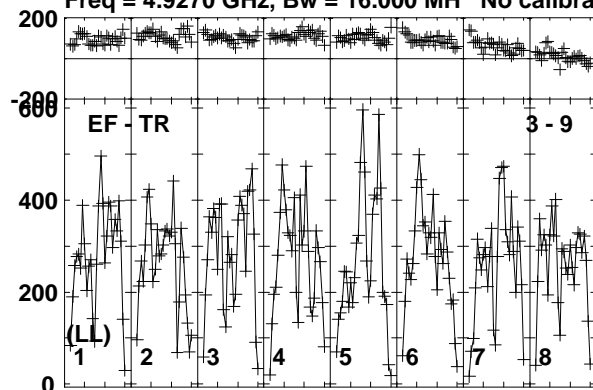

Lower frame: Micro Ampl Jy Top frame: Phas deg  
Vector averaged cross-power spectrum Baseline: EF (03) - TR (09)  
Timerange: 00/14:43:01 to 00/14:44:59

Plot file version 654 created 19-DEC-2018 17:58:59

VLA1 RY007C.UVDATA.1

Freq = 4.9270 GHz, Bw = 16.000 MH No calibration applied and no bandpass applied

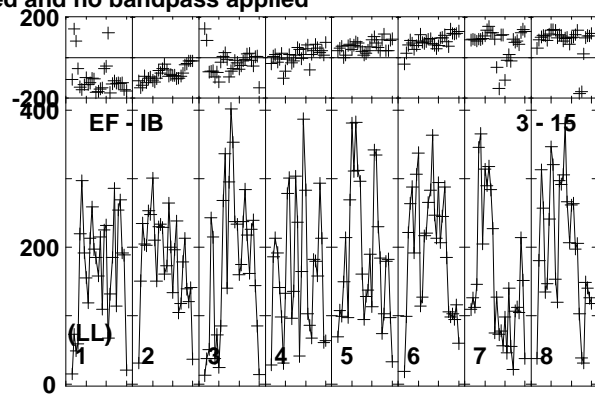
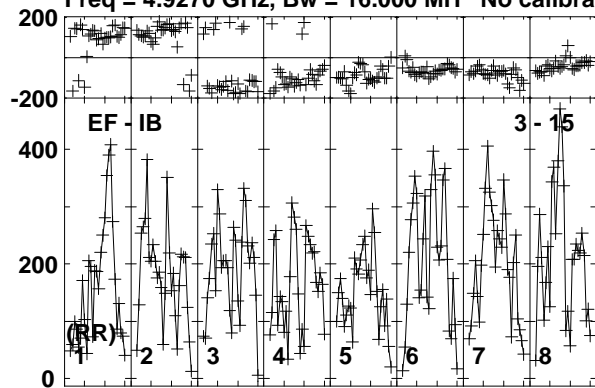

Lower frame: Micro Ampl Jy Top frame: Phas deg  
Vector averaged cross-power spectrum Baseline: EF (03) - IB (15)  
Timerange: 00/14:43:01 to 00/14:44:59

Plot file version 655 created 19-DEC-2018 17:58:59

J1619+2247 RY007C.UVDATA.1

Freq = 4.9270 GHz, Bw = 16.000 MH No calibration applied and no bandpass applied

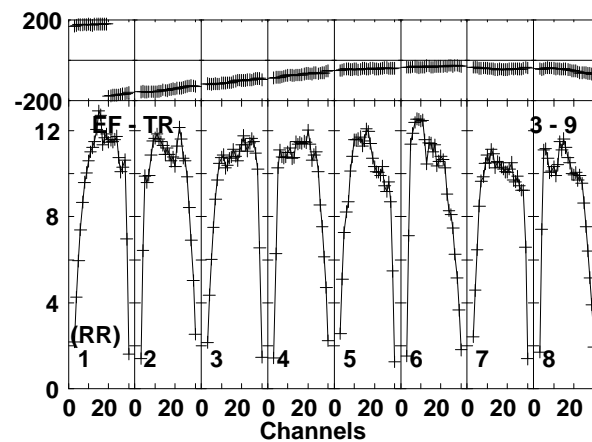
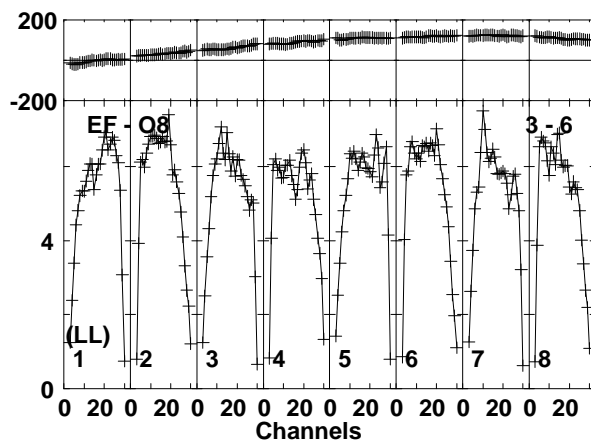
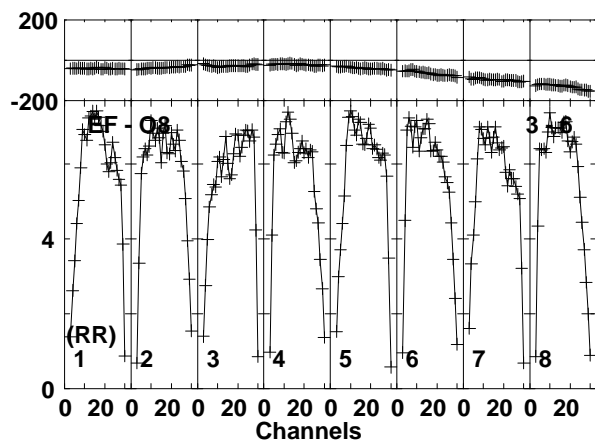
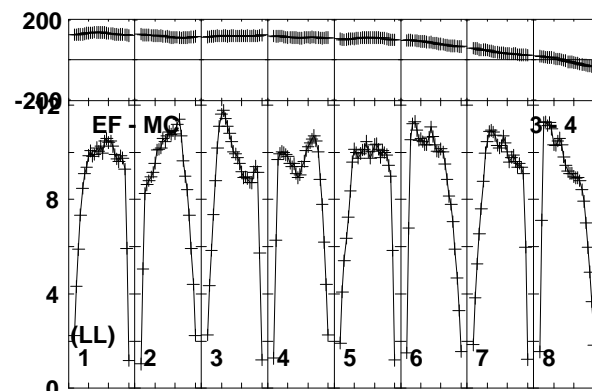
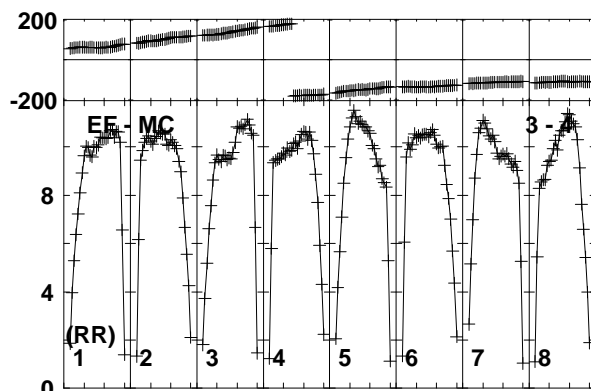
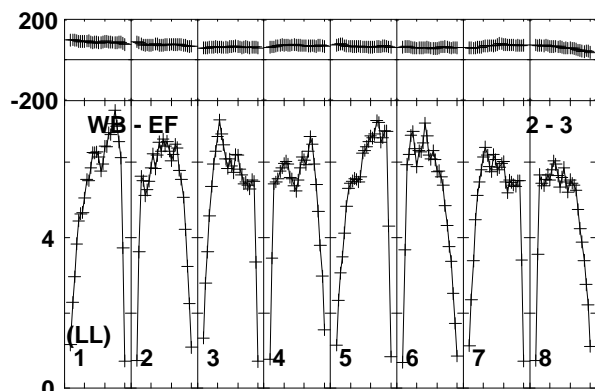
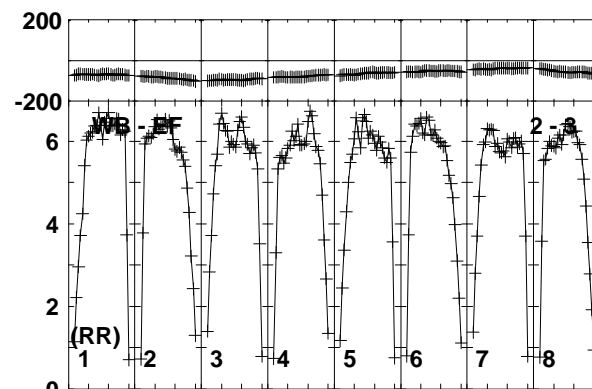
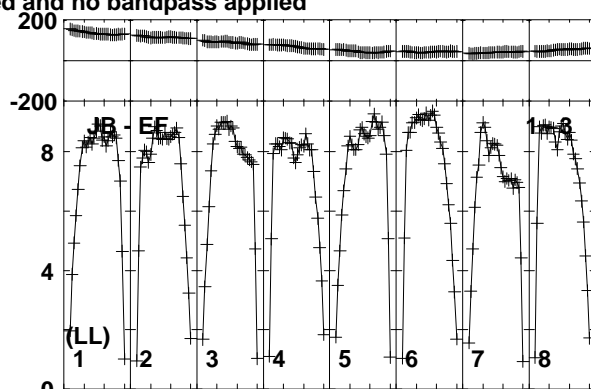
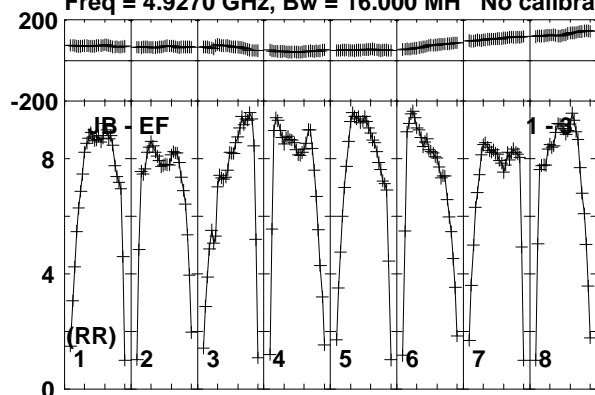

Lower frame: Milli Ampl Jy Top frame: Phas deg  
Vector averaged cross-power spectrum Baseline: JB (01) - EF (03)  
Timerange: 00/14:45:01 to 00/14:45:59

Plot file version 656 created 19-DEC-2018 17:58:59

J1619+2247 RY007C.UVDATA.1

Freq = 4.9270 GHz, Bw = 16.000 MH No calibration applied and no bandpass applied

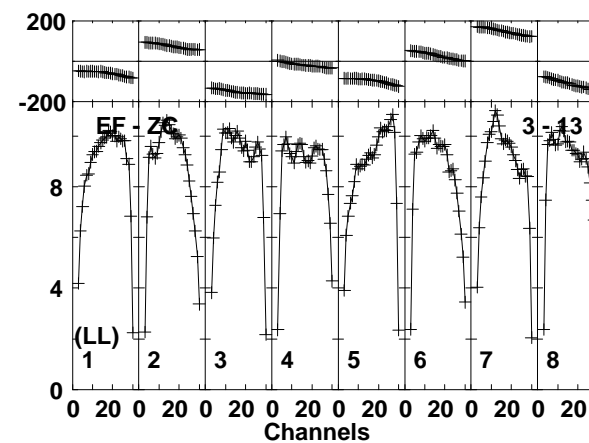
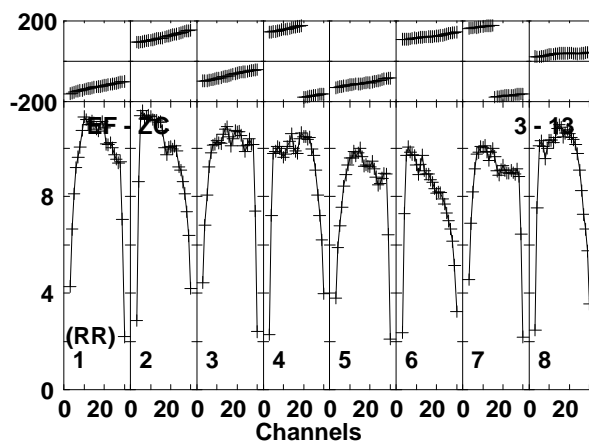
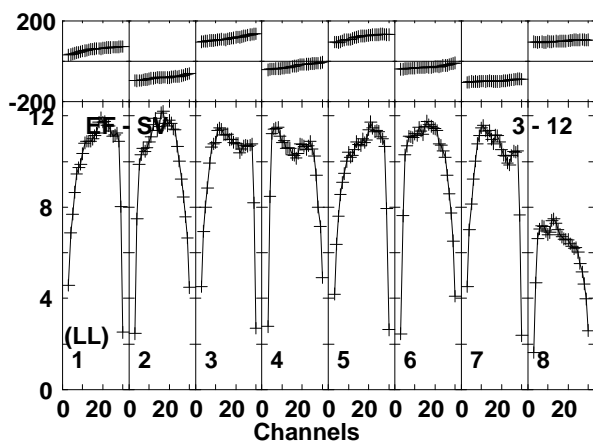
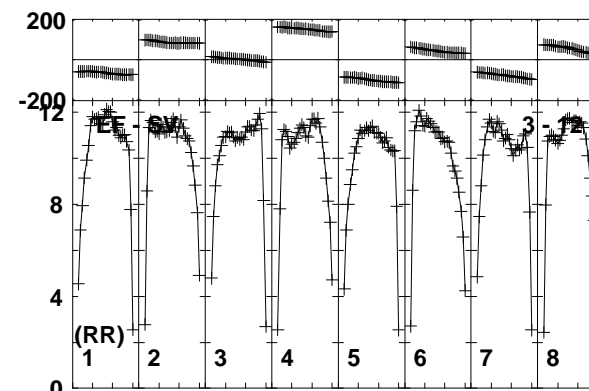
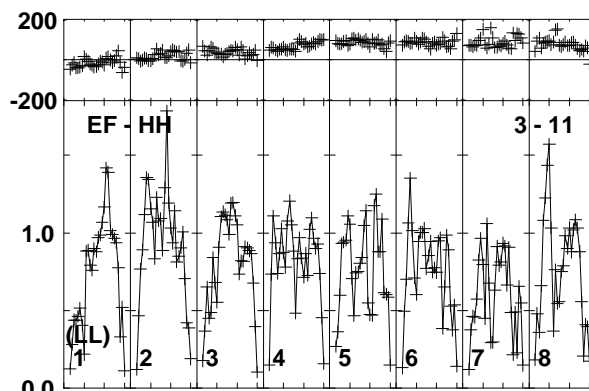
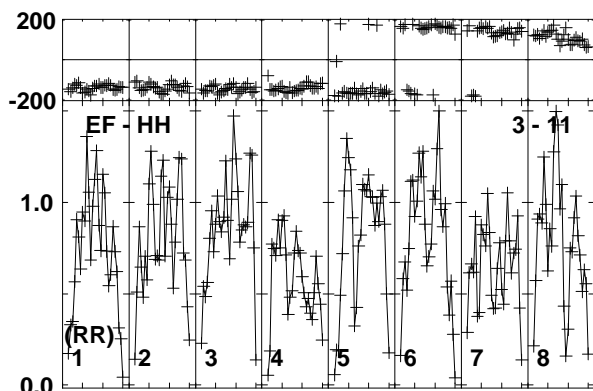
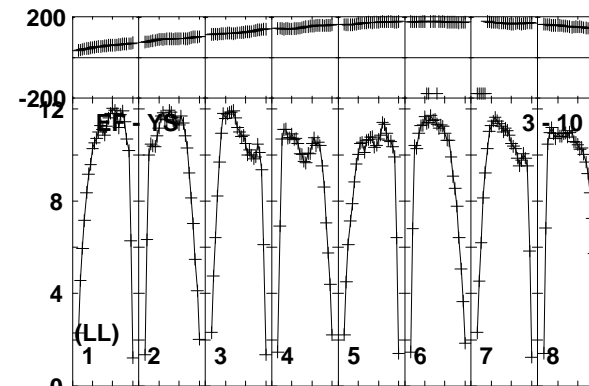
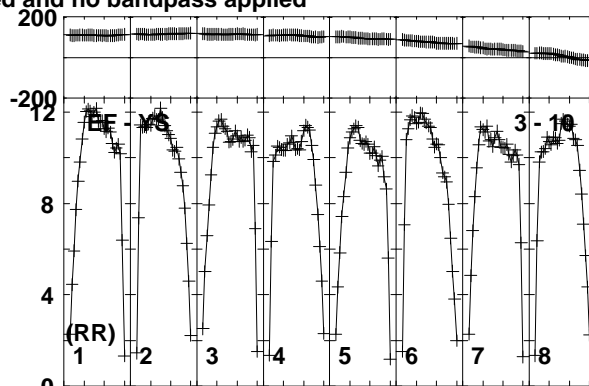
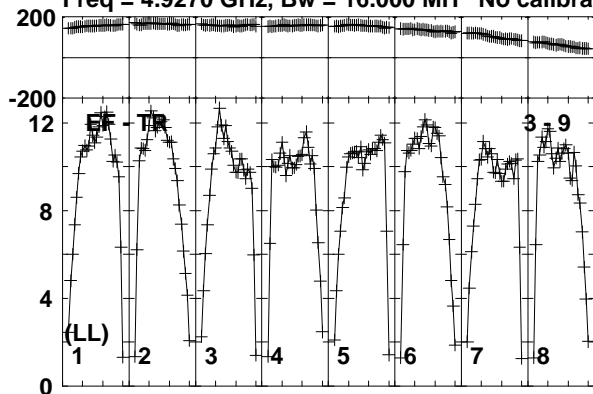

Lower frame: Milli Ampl Jy Top frame: Phas deg  
Vector averaged cross-power spectrum Baseline: EF (03) - TR (09)  
Timerange: 00/14:45:01 to 00/14:45:59

Plot file version 657 created 19-DEC-2018 17:58:59  
J1619+2247 RY007C.UVDATA.1

Freq = 4.9270 GHz, Bw = 16.000 MH No calibration applied and no bandpass applied

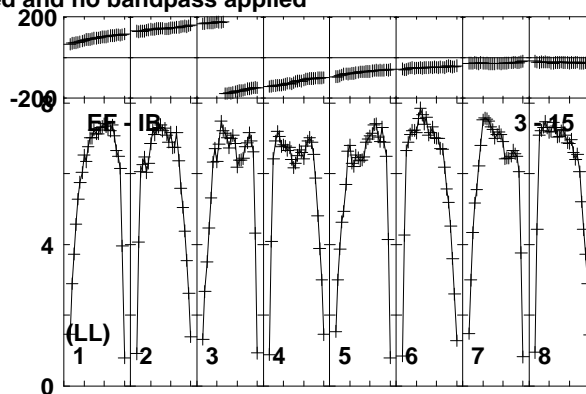
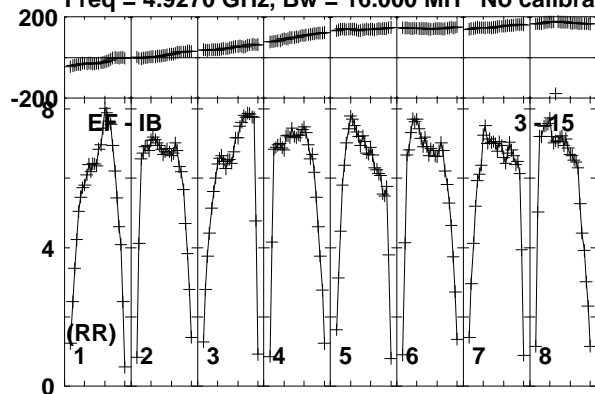

Lower frame: Milli Ampl Jy Top frame: Phas deg  
Vector averaged cross-power spectrum Baseline: EF (03) - IB (15)  
Timerange: 00/14:45:01 to 00/14:45:59

Plot file version 658 created 19-DEC-2018 17:58:59

AT2018\_RY007C.UVDATA.1

Freq = 4.9270 GHz, Bw = 16.000 MH No calibration applied and no bandpass applied

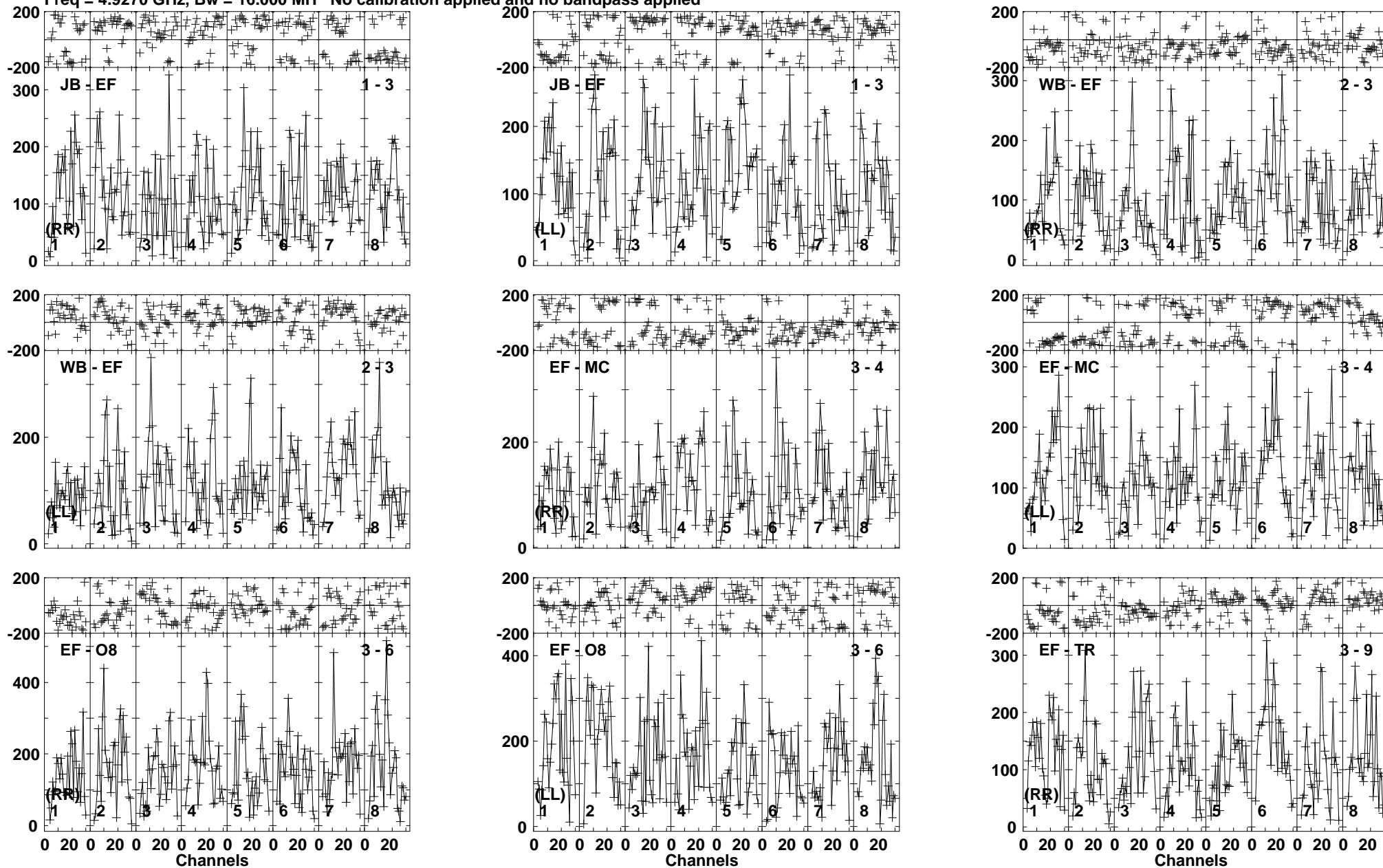

Lower frame: Micro Ampl Jy Top frame: Phas deg  
Vector averaged cross-power spectrum Baseline: JB (01) - EF (03)  
Timerange: 00/14:46:01 to 00/14:48:59



Plot file version 659 created 19-DEC-2018 17:58:59

AT2018\_RY007C.UVDATA.1

Freq = 4.9270 GHz, Bw = 16.000 MH No calibration applied and no bandpass applied

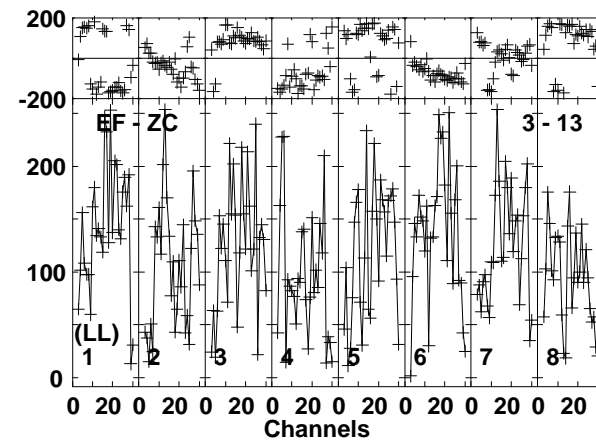
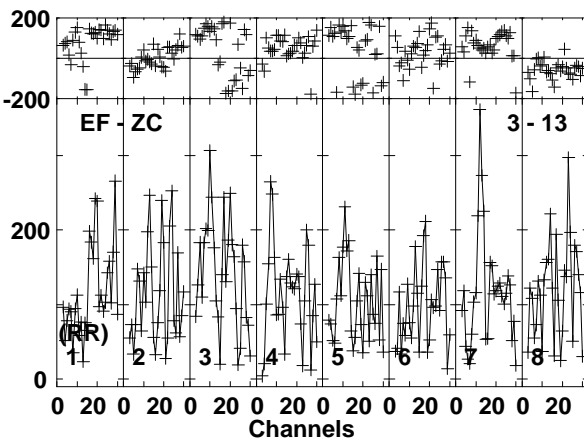
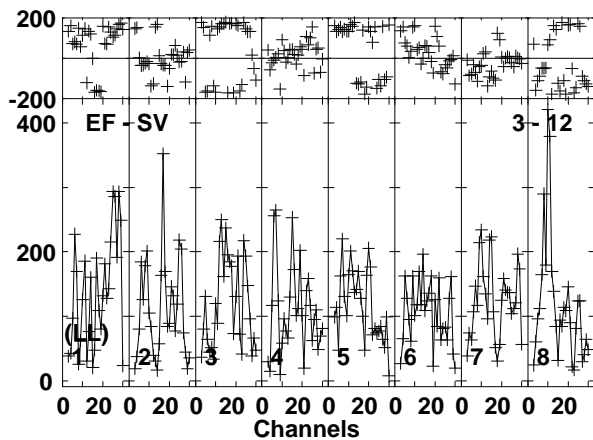
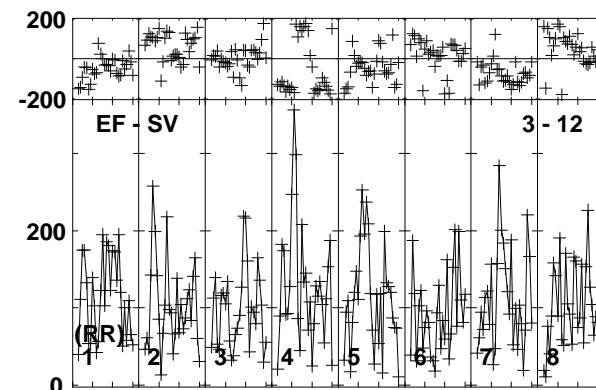
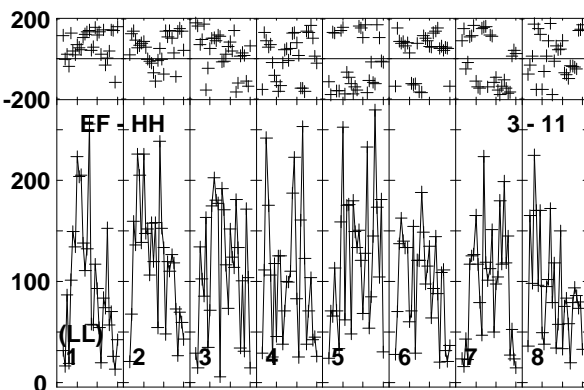
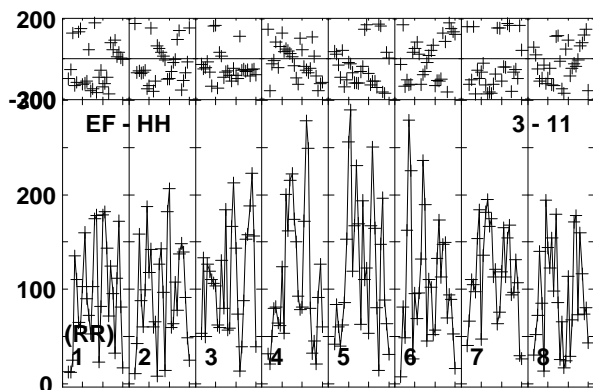
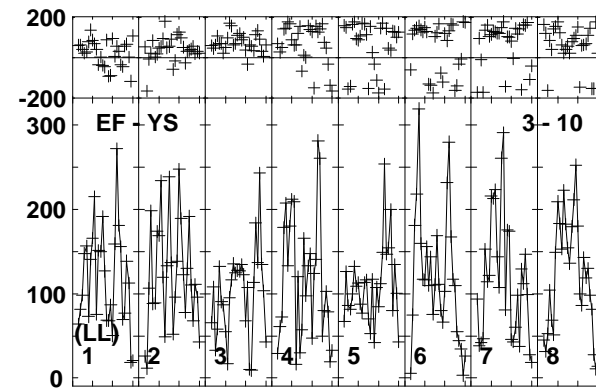
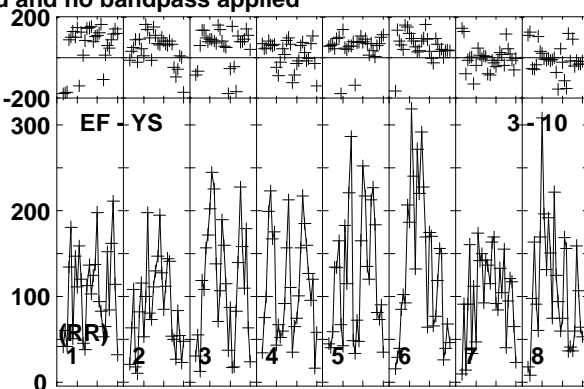
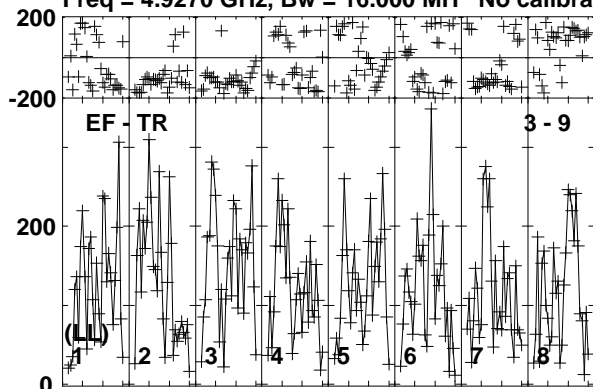

Lower frame: Micro Ampl Jy Top frame: Phas deg  
Vector averaged cross-power spectrum Baseline: EF (03) - TR (09)  
Timerange: 00/14:46:01 to 00/14:48:59

Plot file version 660 created 19-DEC-2018 17:58:59

AT2018\_RY007C.UVDATA.1

Freq = 4.9270 GHz, Bw = 16.000 MH No calibration applied and no bandpass applied

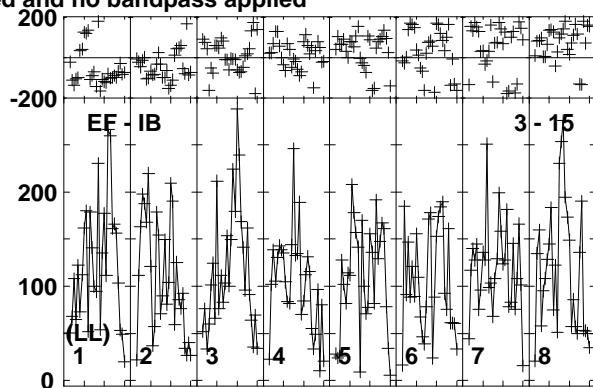
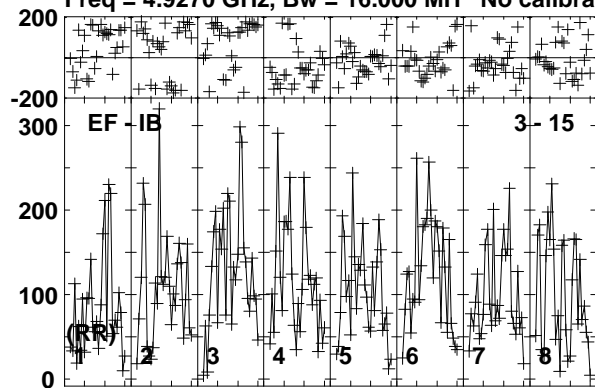

Lower frame: Micro Ampl Jy Top frame: Phas deg  
Vector averaged cross-power spectrum Baseline: EF (03) - IB (15)  
Timerange: 00/14:46:01 to 00/14:48:59

Plot file version 661 created 19-DEC-2018 17:58:59

J1619+2247 RY007C.UVDATA.1

Freq = 4.9270 GHz, Bw = 16.000 MH No calibration applied and no bandpass applied

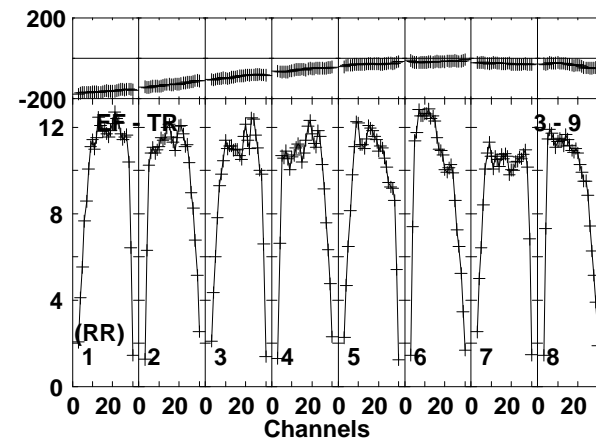
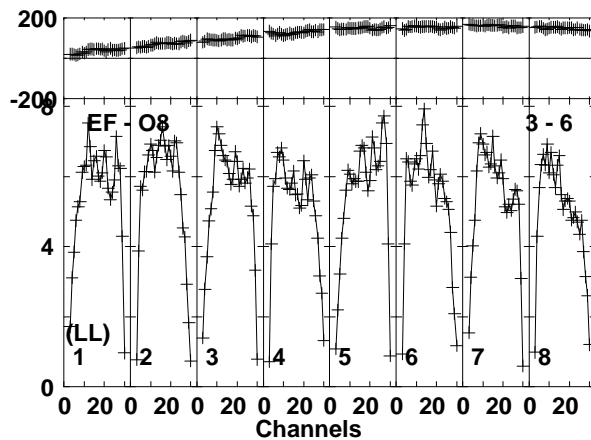
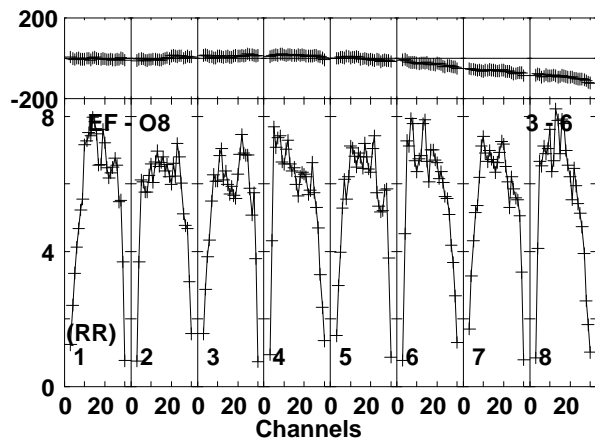
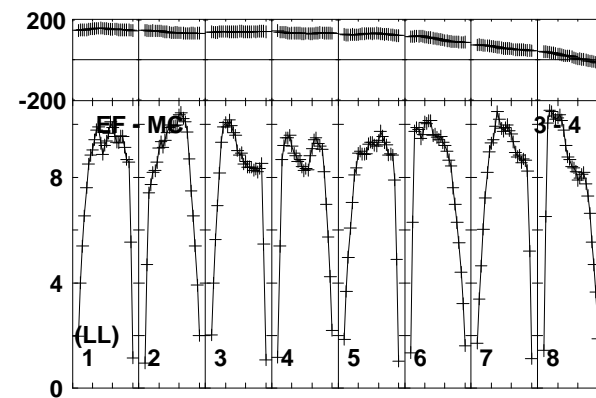
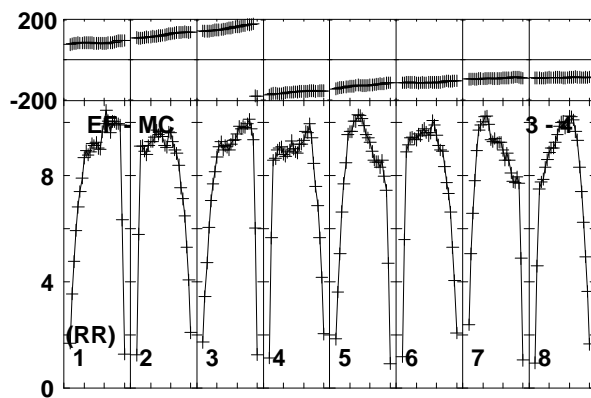
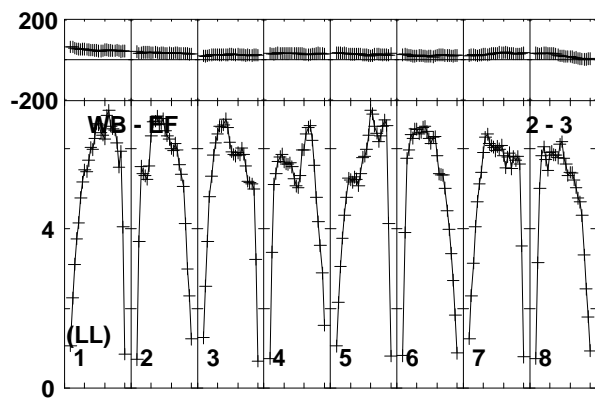
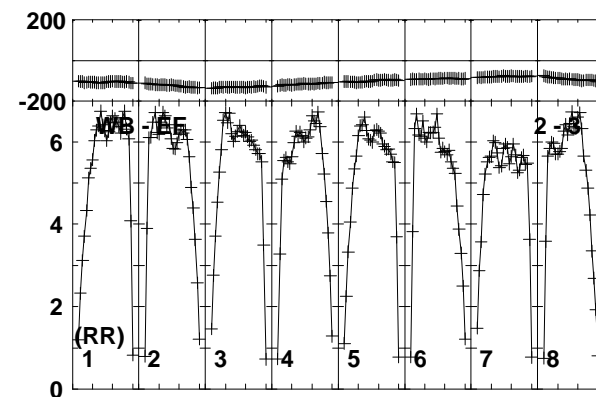
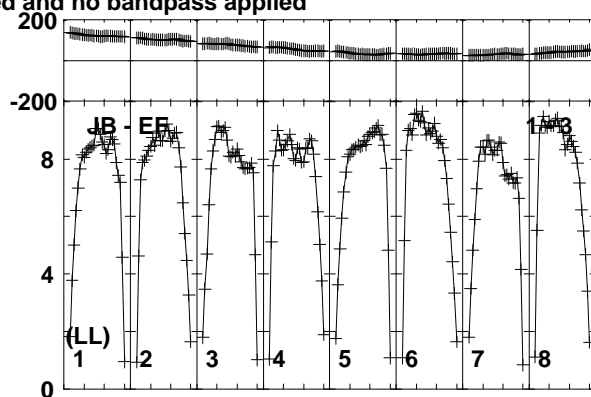
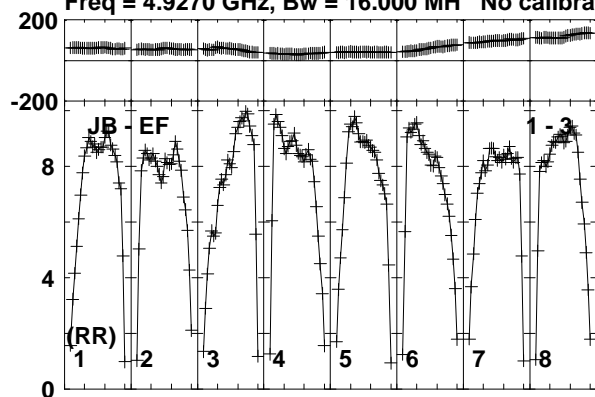

Lower frame: Milli Ampl Jy Top frame: Phas deg  
Vector averaged cross-power spectrum Baseline: JB (01) - EF (03)  
Timerange: 00/14:49:01 to 00/14:49:59

Plot file version 662 created 19-DEC-2018 17:58:59

J1619+2247 RY007C.UVDATA.1

Freq = 4.9270 GHz, Bw = 16.000 MH No calibration applied and no bandpass applied

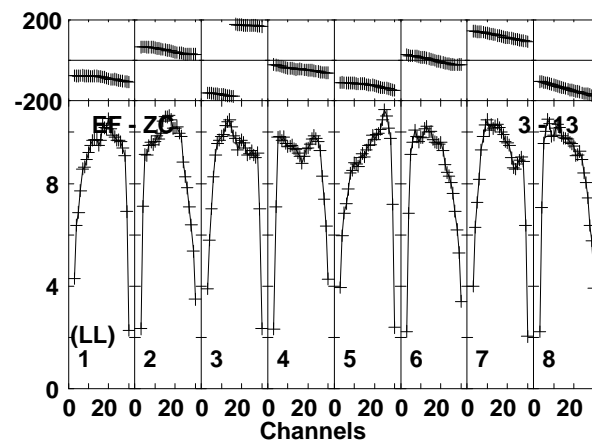
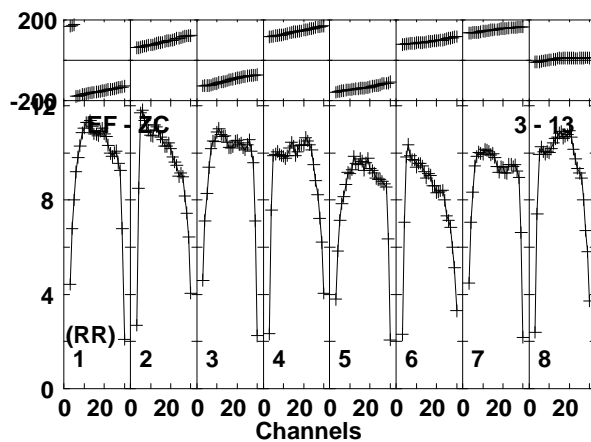
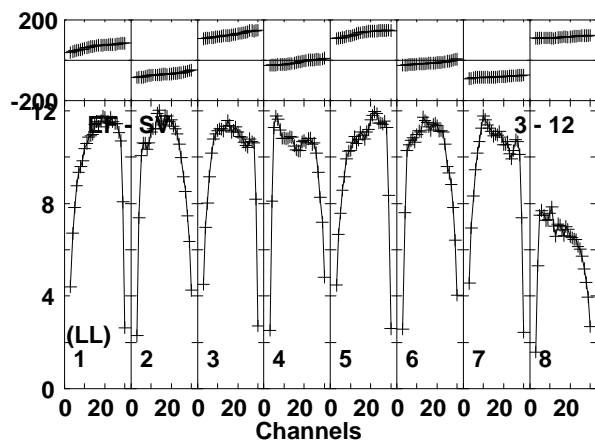
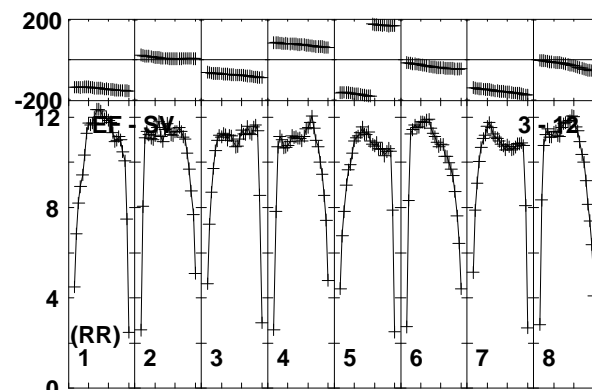
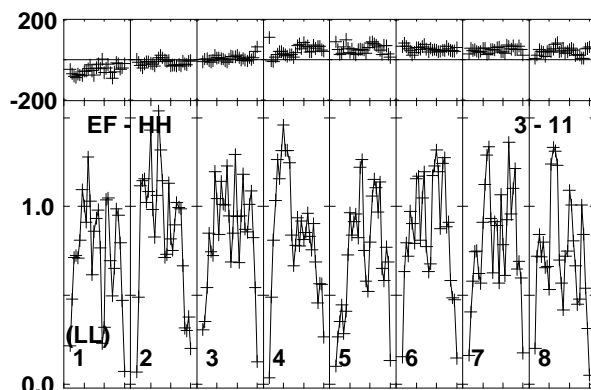
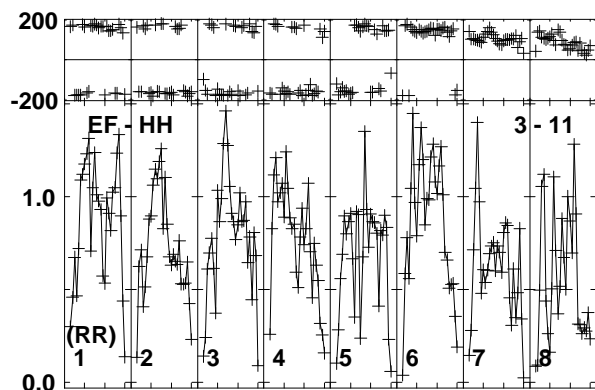
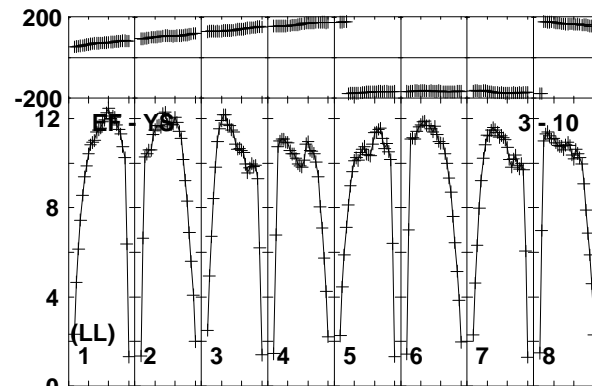
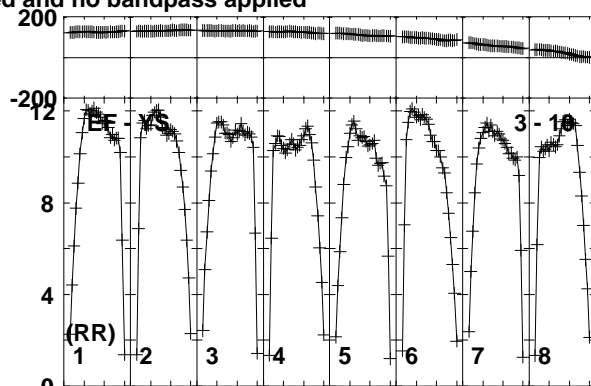
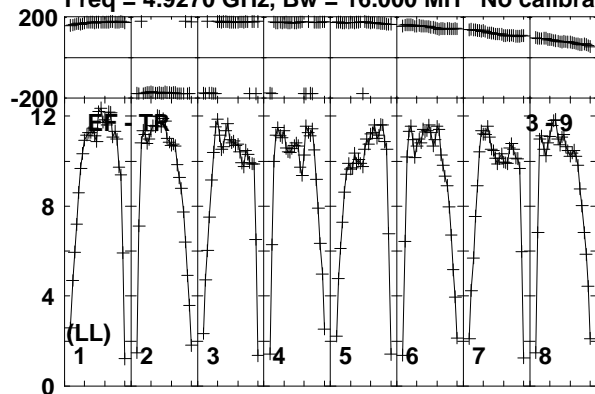

Lower frame: Milli Ampl Jy Top frame: Phas deg  
Vector averaged cross-power spectrum Baseline: EF (03) - TR (09)  
Timerange: 00/14:49:01 to 00/14:49:59

Plot file version 663 created 19-DEC-2018 17:58:59  
J1619+2247 RY007C.UVDATA.1

Freq = 4.9270 GHz, Bw = 16.000 MH No calibration applied and no bandpass applied

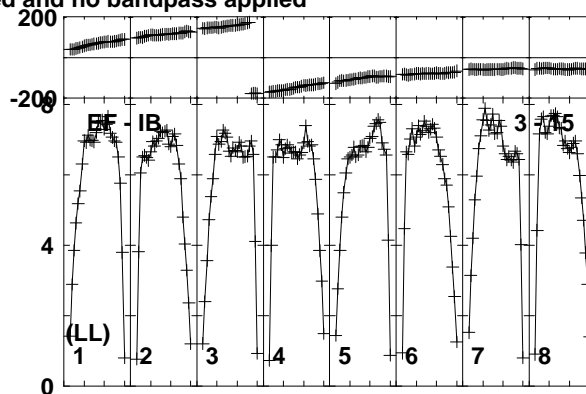
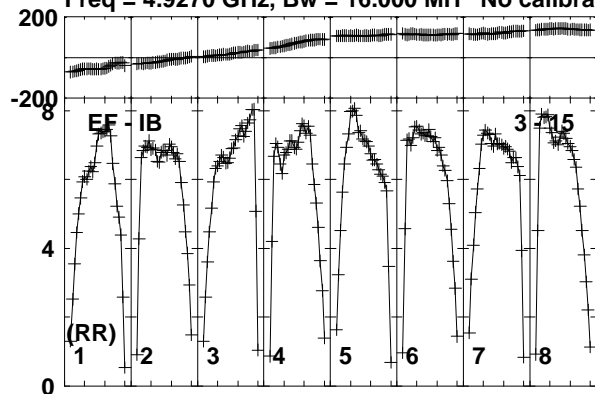

Lower frame: Milli Ampl Jy Top frame: Phas deg  
Vector averaged cross-power spectrum Baseline: EF (03) - IB (15)  
Timerange: 00/14:49:01 to 00/14:49:59

Plot file version 664 created 19-DEC-2018 17:58:59

AT2018\_RY007C.UVDATA.1

Freq = 4.9270 GHz, Bw = 16.000 MH No calibration applied and no bandpass applied

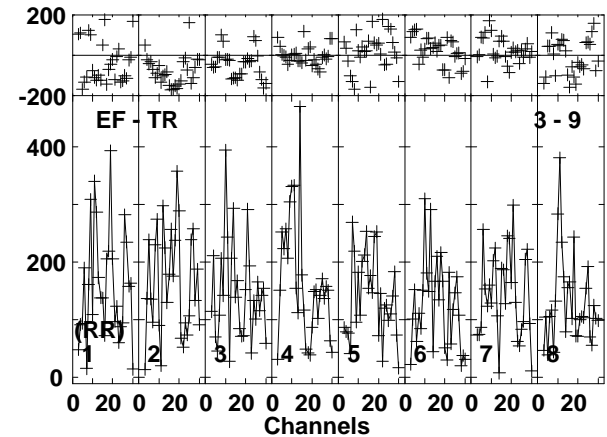
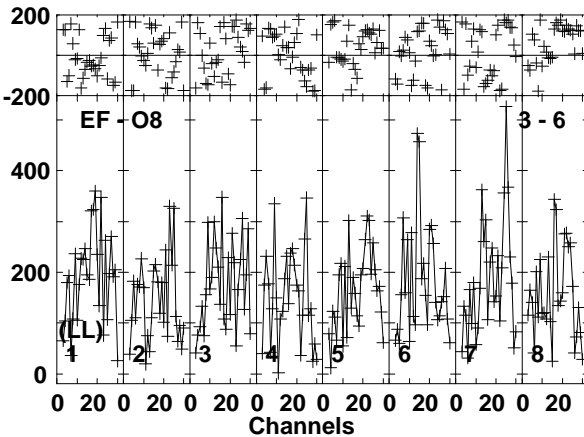
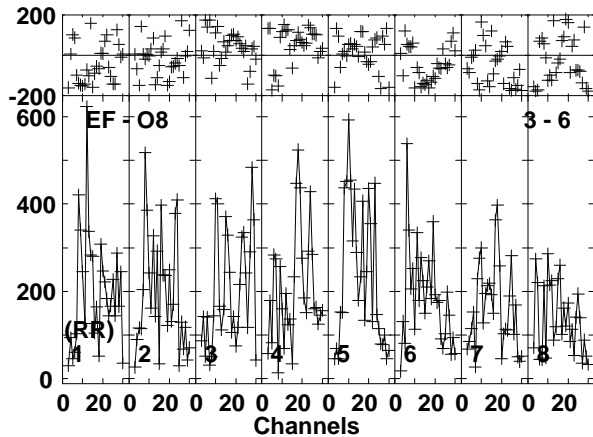
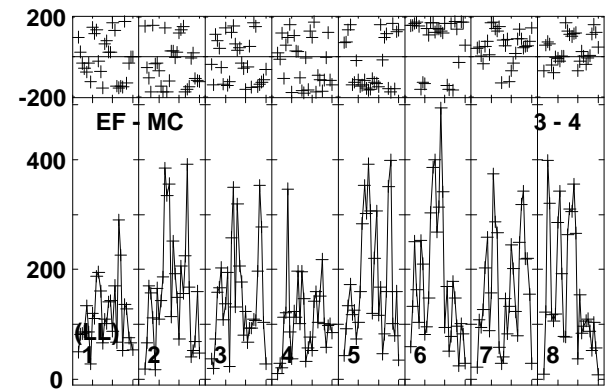
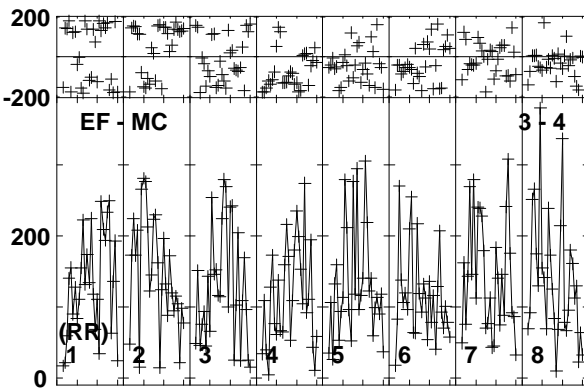
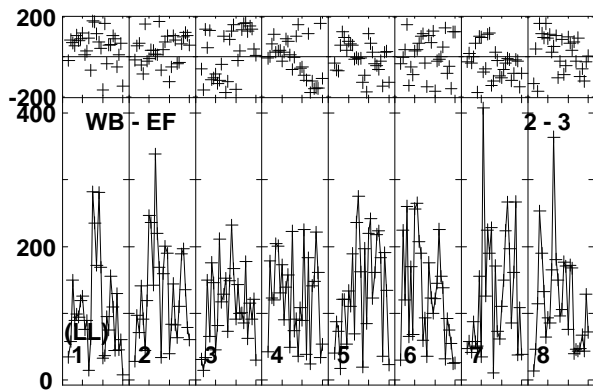
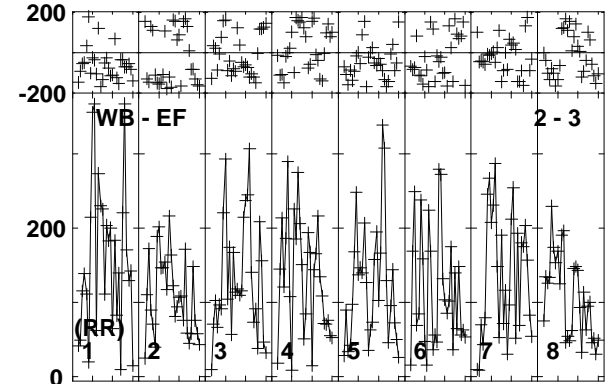
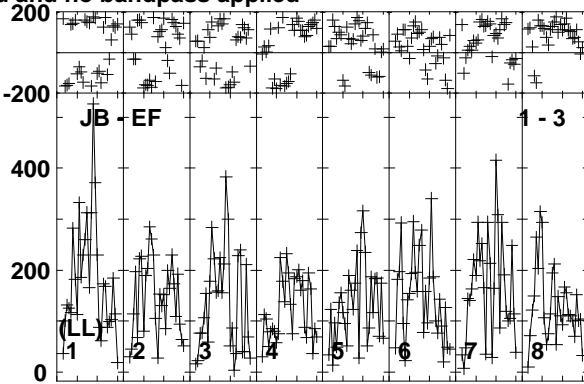
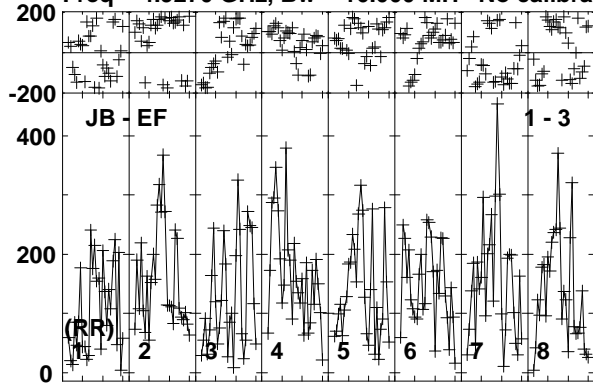

Lower frame: Micro Ampl Jy Top frame: Phas deg  
Vector averaged cross-power spectrum Baseline: JB (01) - EF (03)  
Timerange: 00/14:50:01 to 00/14:51:59

Plot file version 665 created 19-DEC-2018 17:58:59

AT2018\_RY007C.UVDATA.1

Freq = 4.9270 GHz, Bw = 16.000 MH No calibration applied and no bandpass applied

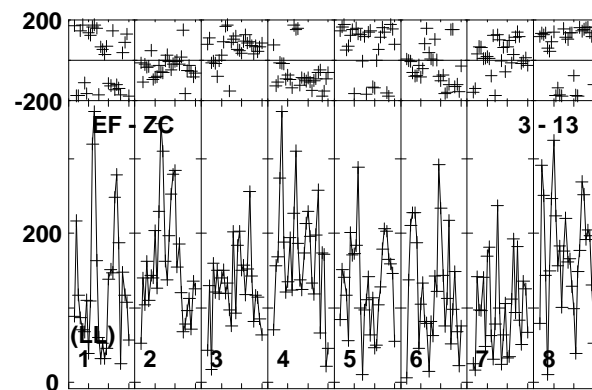
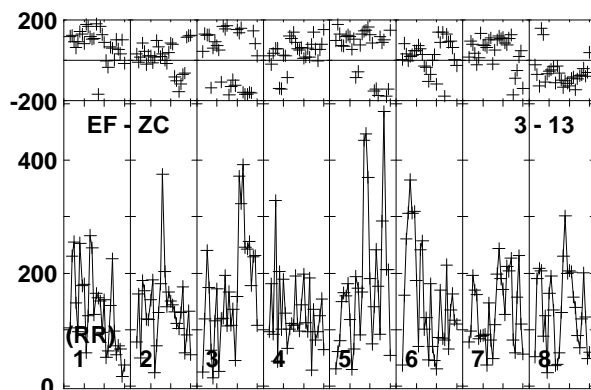
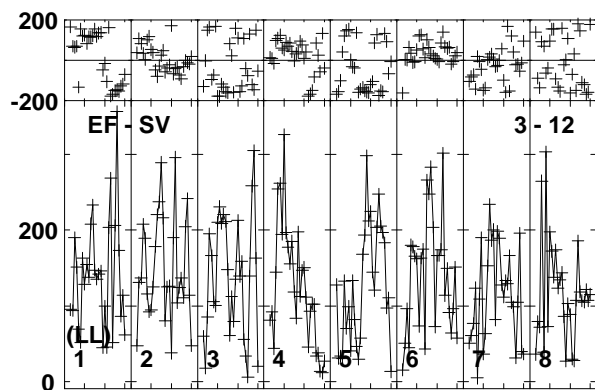
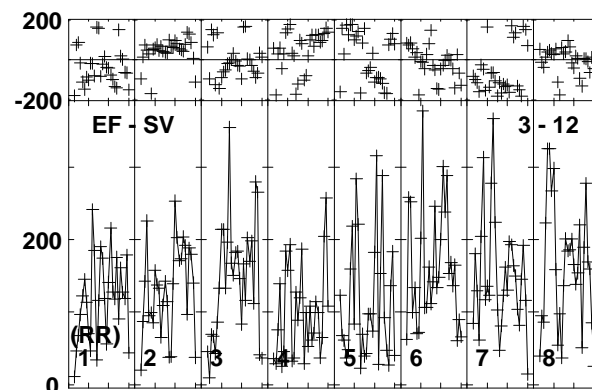
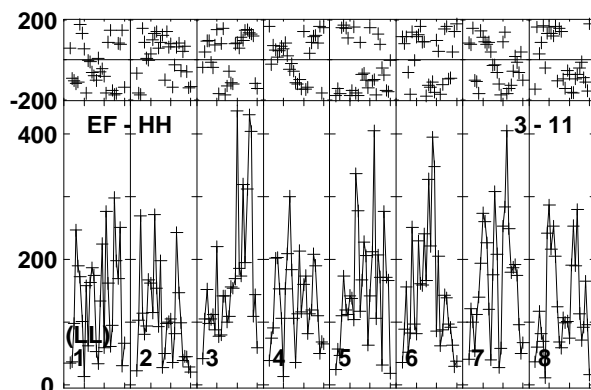
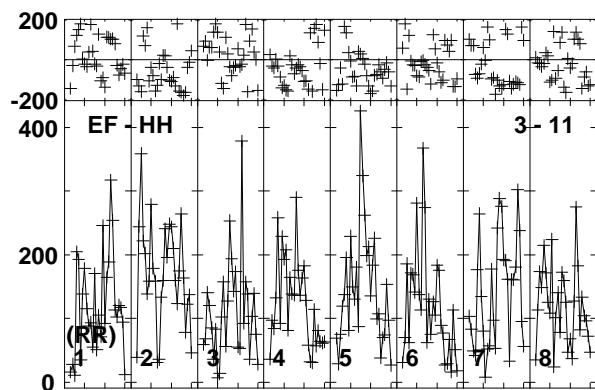
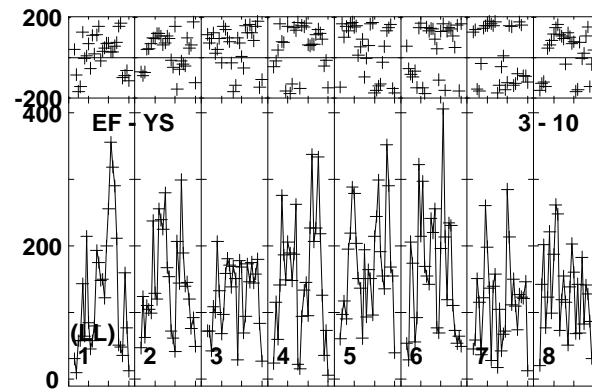
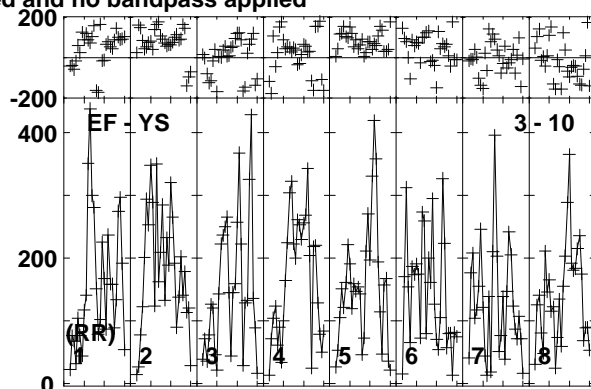
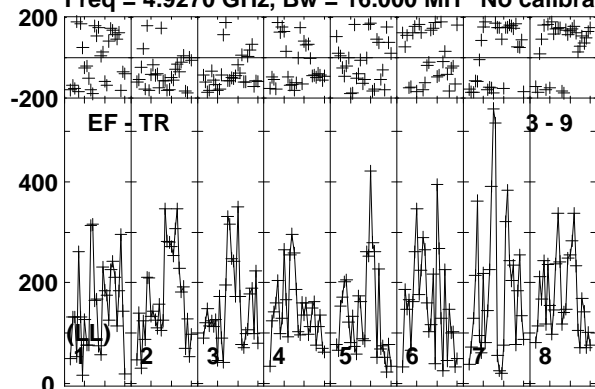

Lower frame: Micro Ampl Jy Top frame: Phas deg  
Vector averaged cross-power spectrum Baseline: EF (03) - TR (09)  
Timerange: 00/14:50:01 to 00/14:51:59

Plot file version 666 created 19-DEC-2018 17:58:59

AT2018\_RY007C.UVDATA.1

Freq = 4.9270 GHz, Bw = 16.000 MH No calibration applied and no bandpass applied

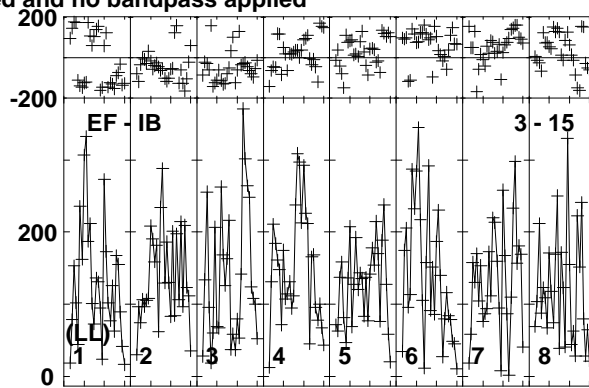
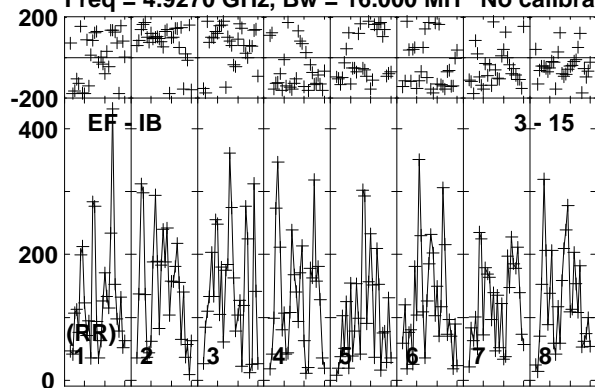

Lower frame: Micro Ampl Jy Top frame: Phas deg  
Vector averaged cross-power spectrum Baseline: EF (03) - IB (15)  
Timerange: 00/14:50:01 to 00/14:51:59



Plot file version 667 created 19-DEC-2018 17:58:59

VLA2\_RY007C.UVDATA.1

Freq = 4.9270 GHz, Bw = 16.000 MH No calibration applied and no bandpass applied

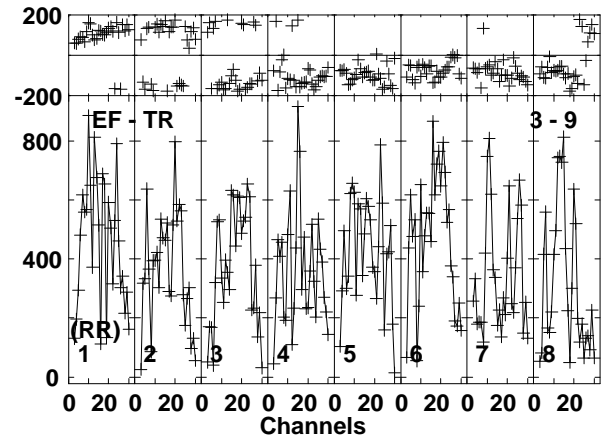
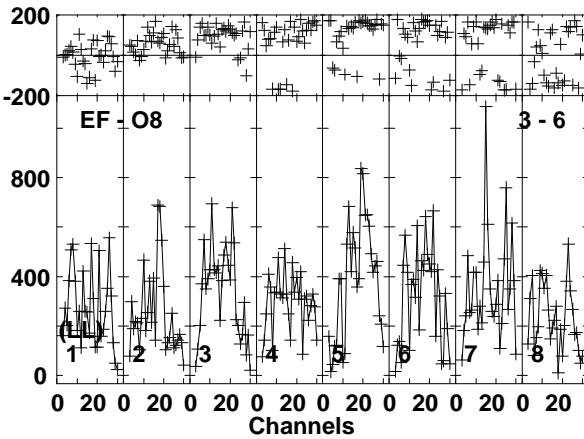
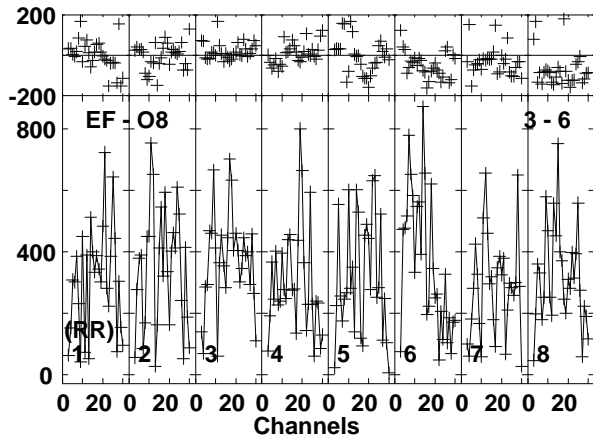
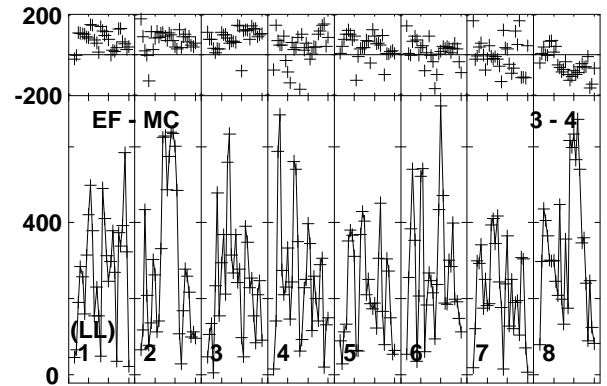
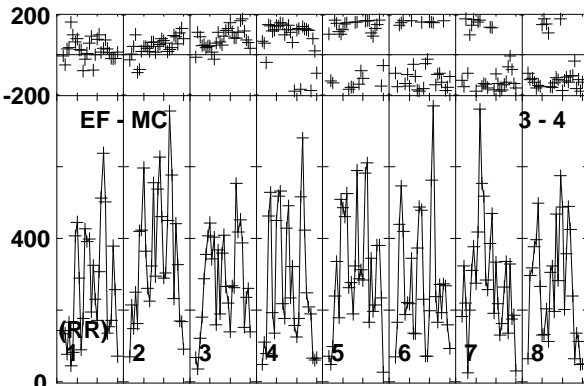
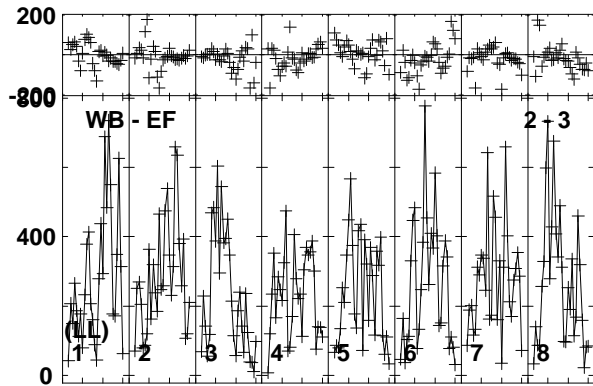
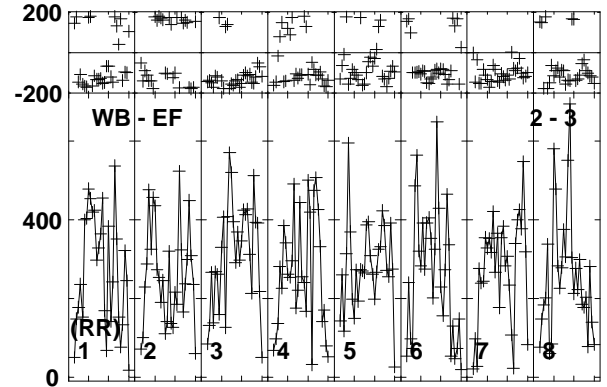
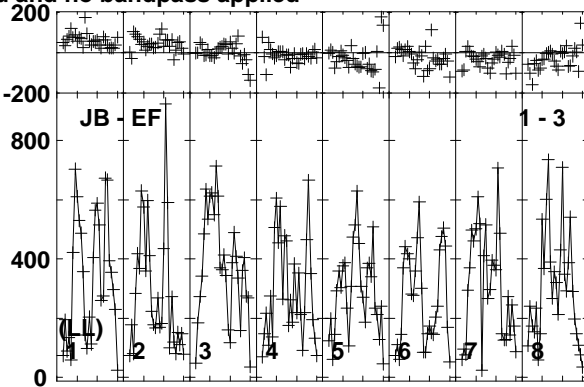
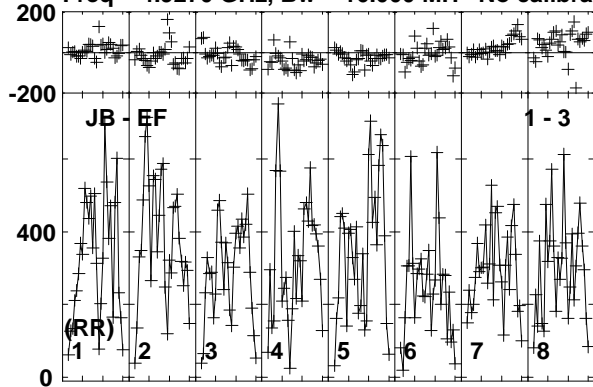

Lower frame: Micro Ampl Jy Top frame: Phas deg  
Vector averaged cross-power spectrum Baseline: JB (01) - EF (03)  
Timerange: 00/14:52:01 to 00/14:52:59

Plot file version 668 created 19-DEC-2018 17:59:00

VLA2 RY007C.UVDATA.1

Freq = 4.9270 GHz, Bw = 16.000 MH No calibration applied and no bandpass applied

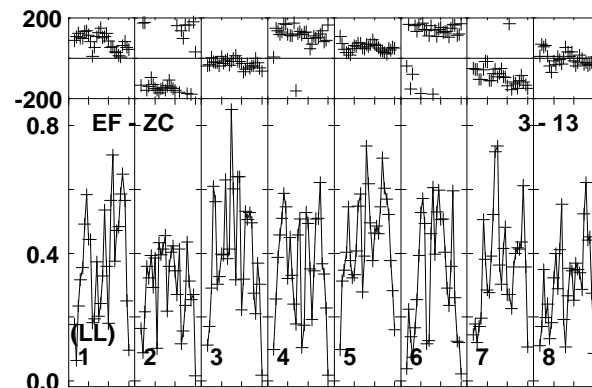
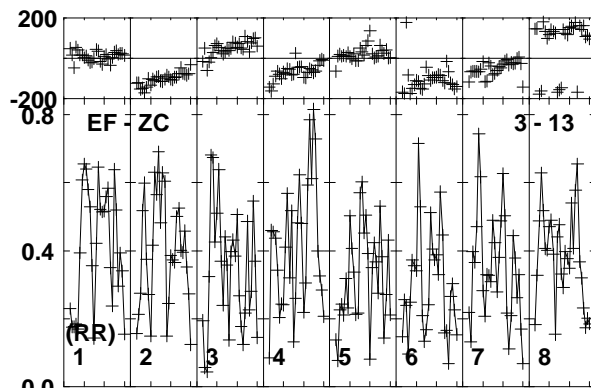
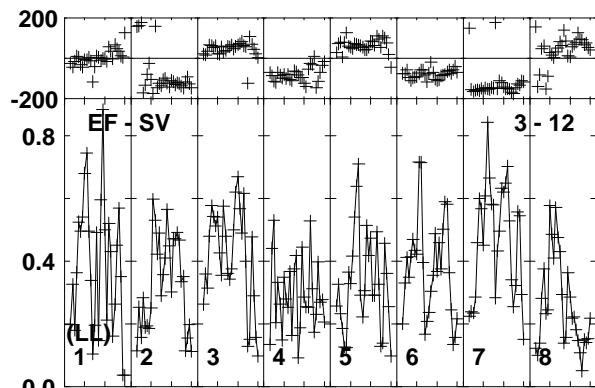
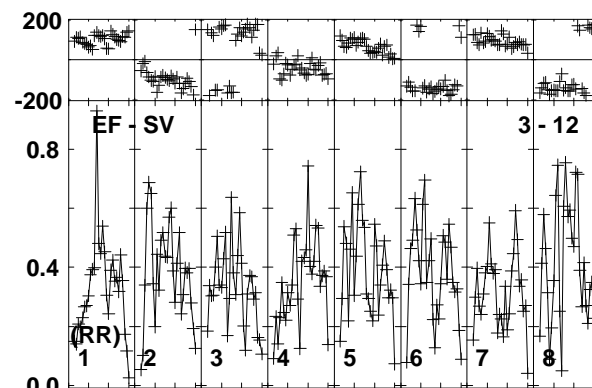
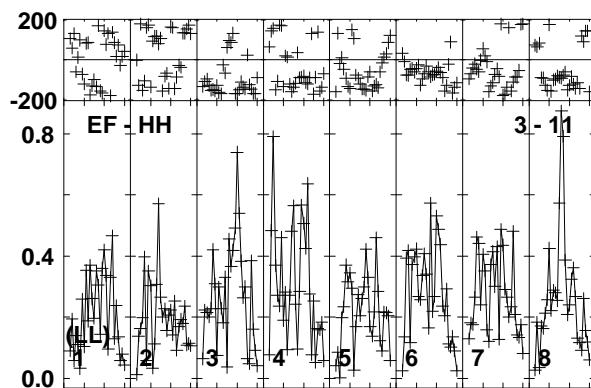
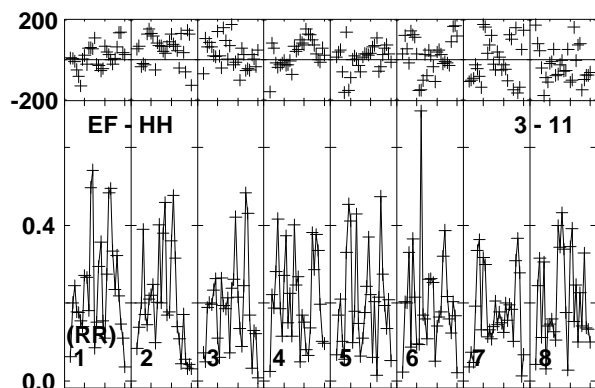
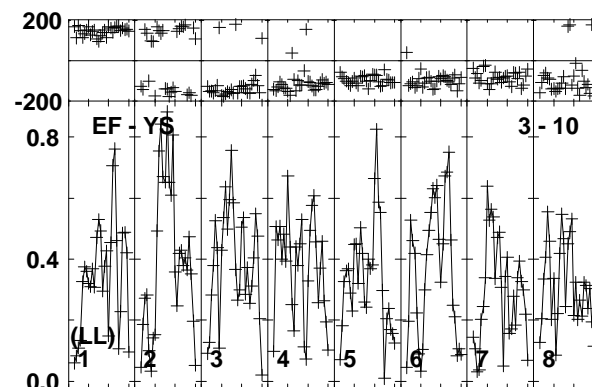
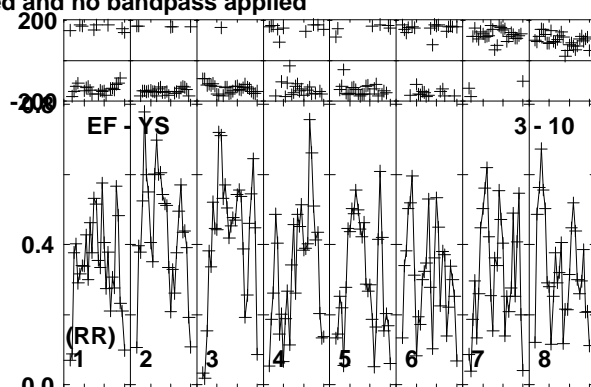
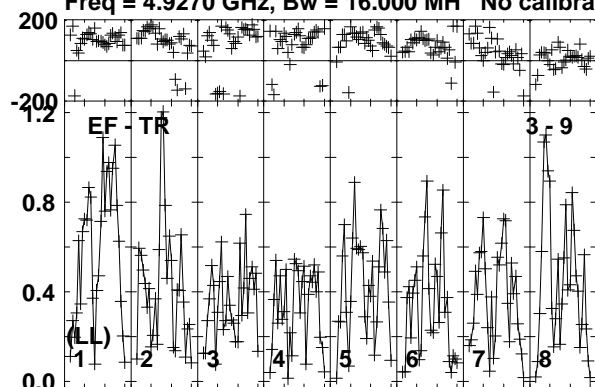

Lower frame: Milli Ampl Jy Top frame: Phas deg  
Vector averaged cross-power spectrum Baseline: EF (03) - TR (09)  
Timerange: 00/14:52:01 to 00/14:52:59

Plot file version 669 created 19-DEC-2018 17:59:00

VLA2 RY007C.UVDATA.1

Freq = 4.9270 GHz, Bw = 16.000 MH No calibration applied and no bandpass applied

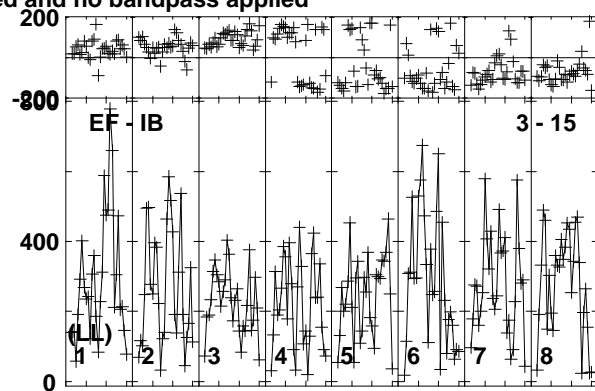
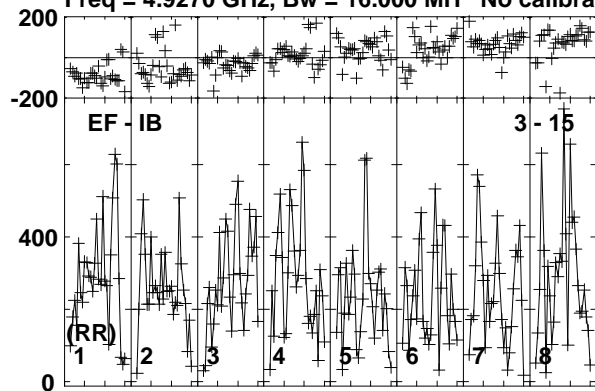

Lower frame: Micro Ampl Jy Top frame: Phas deg  
Vector averaged cross-power spectrum Baseline: EF (03) - IB (15)  
Timerange: 00/14:52:01 to 00/14:52:59

Plot file version 670 created 19-DEC-2018 17:59:00

J1619+2247 RY007C.UVDATA.1

Freq = 4.9270 GHz, Bw = 16.000 MH No calibration applied and no bandpass applied

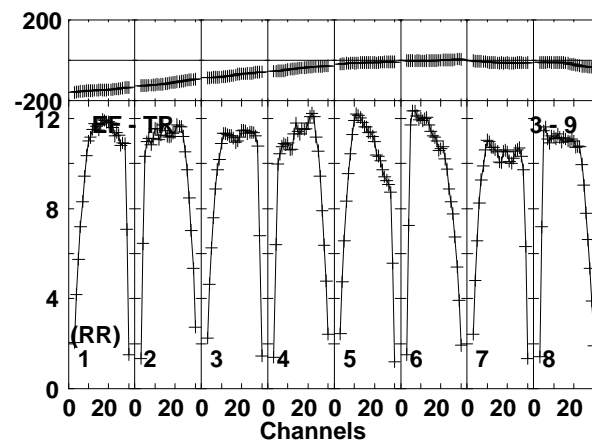
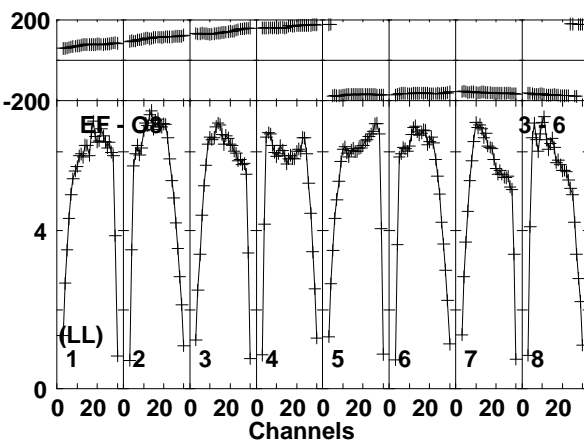
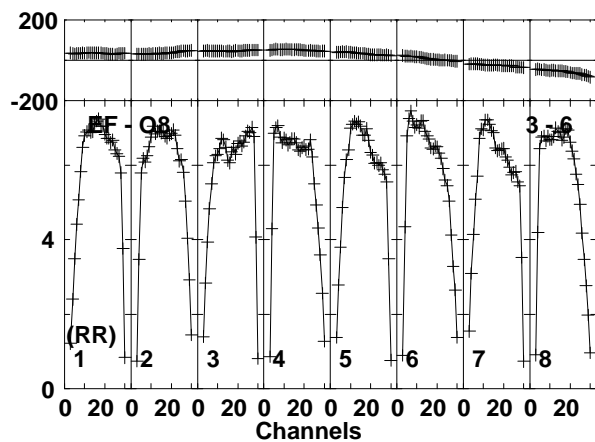
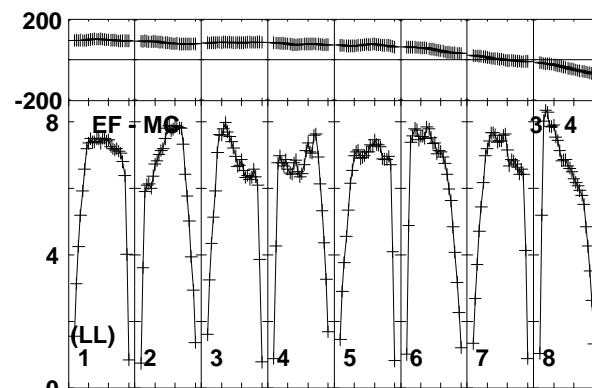
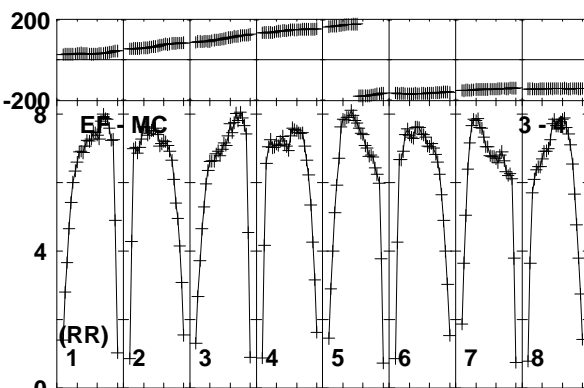
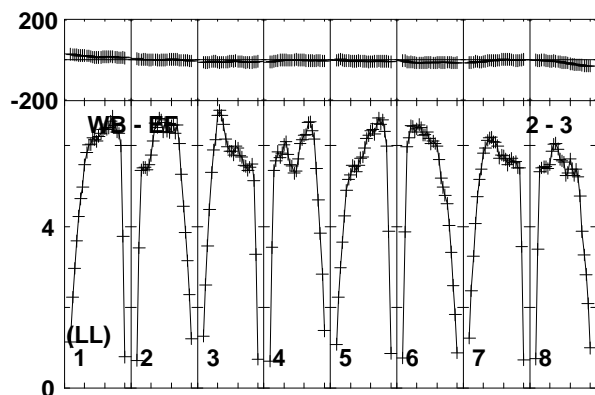
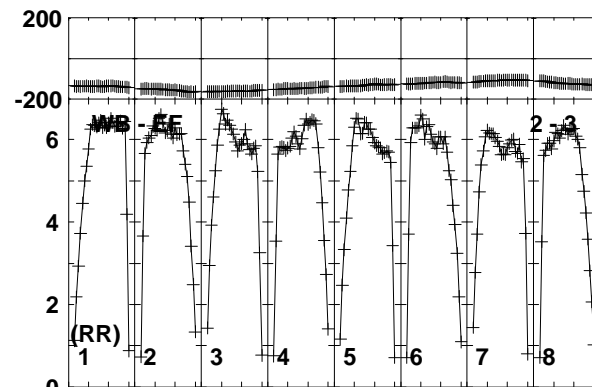
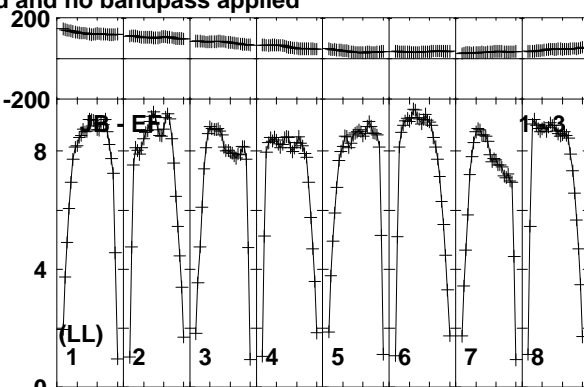
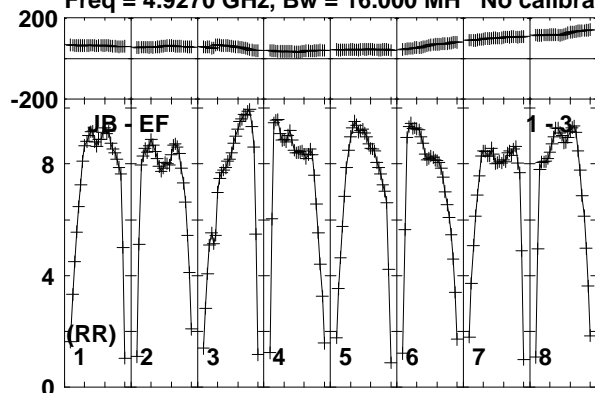

Lower frame: Milli Ampl Jy Top frame: Phas deg  
Vector averaged cross-power spectrum Baseline: JB (01) - EF (03)  
Timerange: 00/14:53:31 to 00/14:54:29

Plot file version 671 created 19-DEC-2018 17:59:00

J1619+2247 RY007C.UVDATA.1

Freq = 4.9270 GHz, Bw = 16.000 MH No calibration applied and no bandpass applied

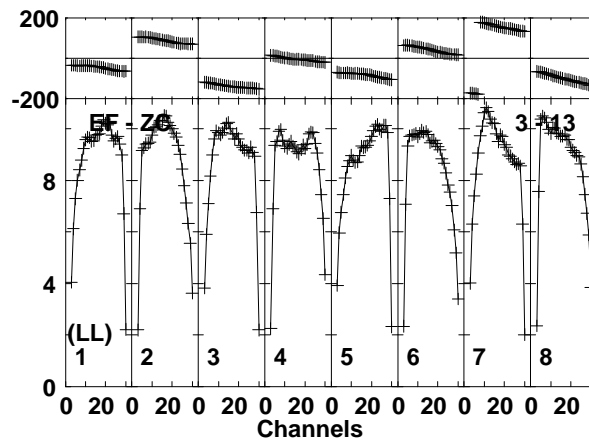
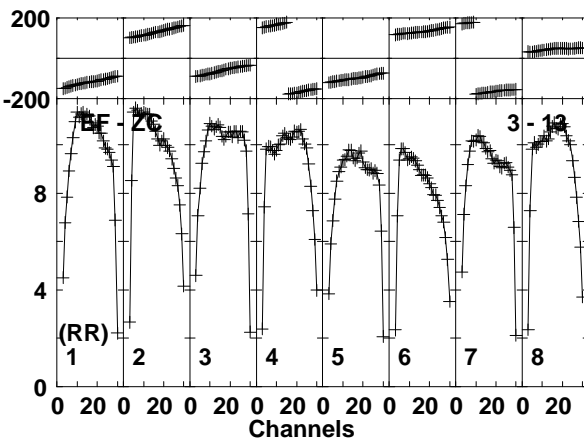
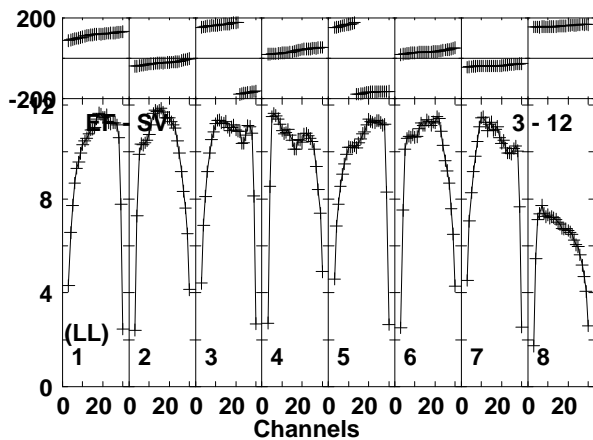
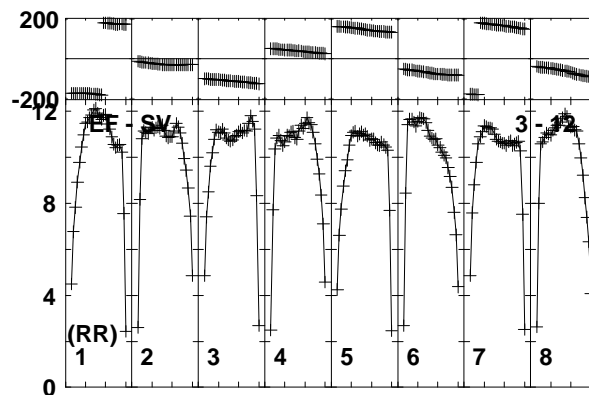
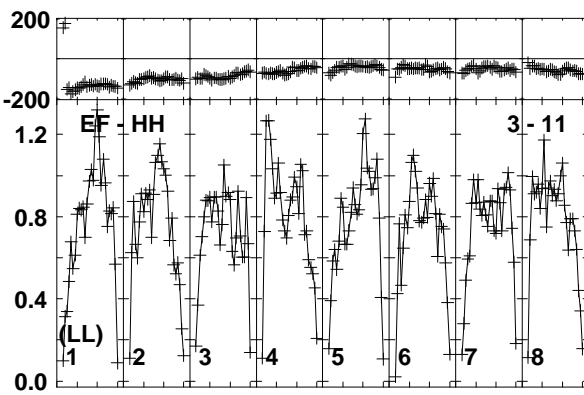
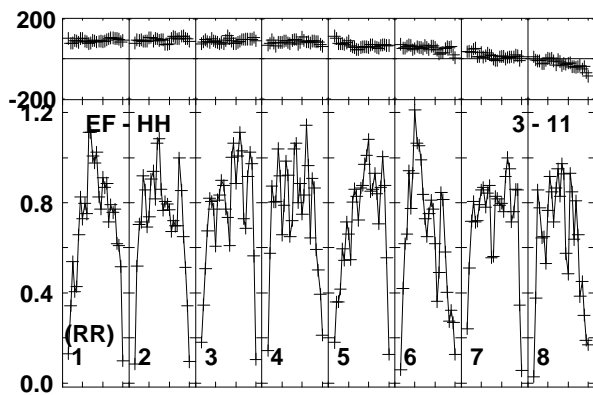
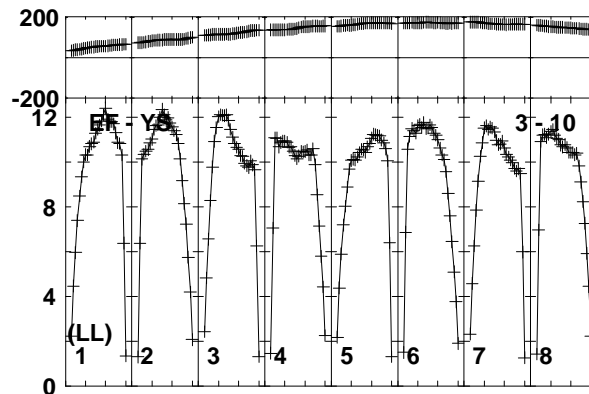
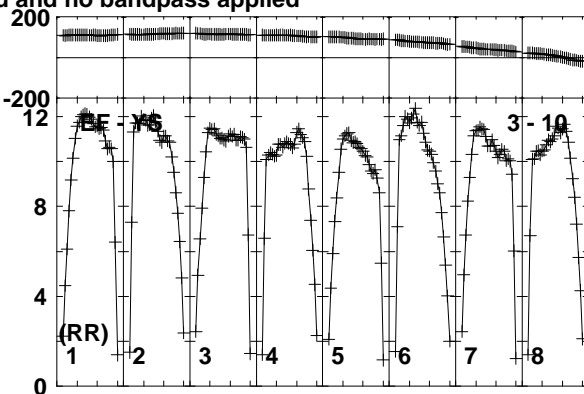
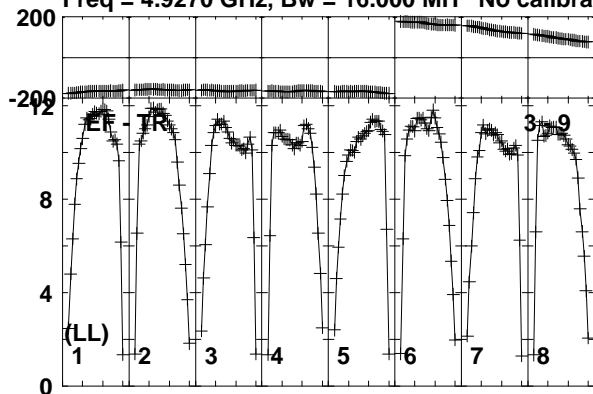

Lower frame: Milli Ampl Jy Top frame: Phas deg  
Vector averaged cross-power spectrum Baseline: EF (03) - TR (09)  
Timerange: 00/14:53:31 to 00/14:54:29

Plot file version 672 created 19-DEC-2018 17:59:00  
J1619+2247 RY007C.UVDATA.1

Freq = 4.9270 GHz, Bw = 16.000 MH No calibration applied and no bandpass applied

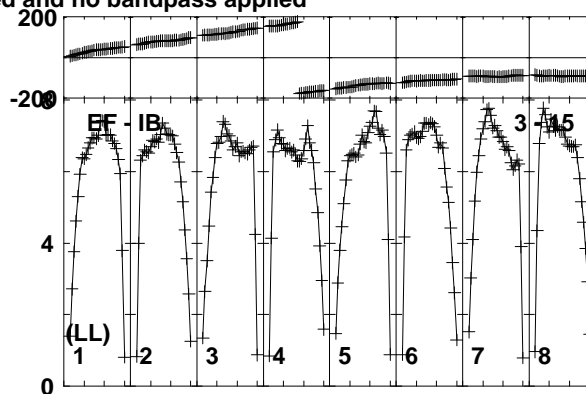
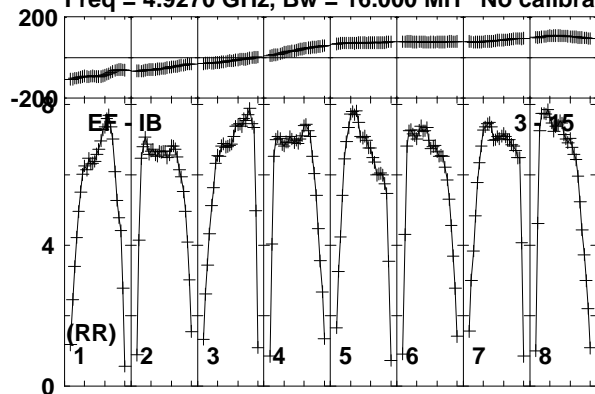

Lower frame: Milli Ampl Jy Top frame: Phas deg  
Vector averaged cross-power spectrum Baseline: EF (03) - IB (15)  
Timerange: 00/14:53:31 to 00/14:54:29

Plot file version 673 created 19-DEC-2018 17:59:00  
 AT2018\_RY007C.UVDATA.1

Freq = 4.9270 GHz, Bw = 16.000 MH No calibration applied and no bandpass applied

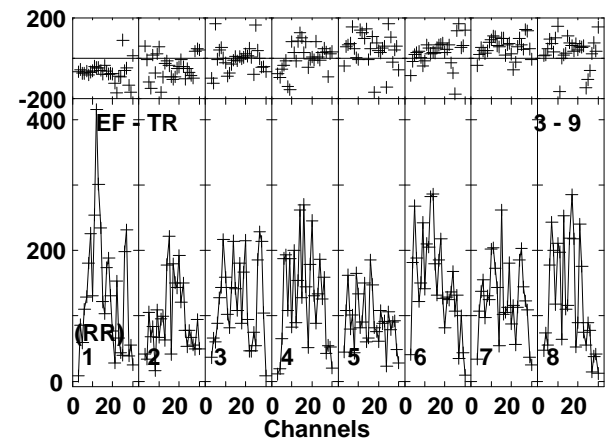
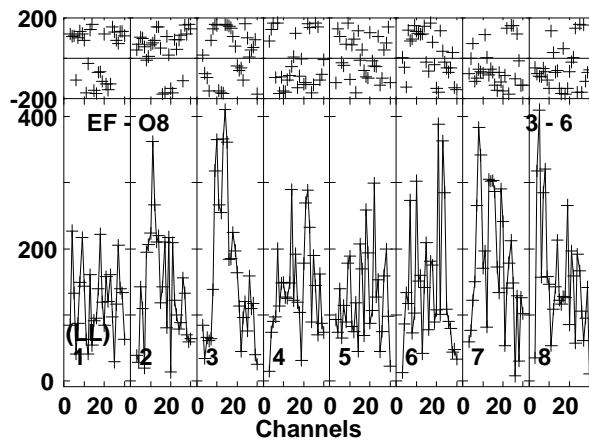
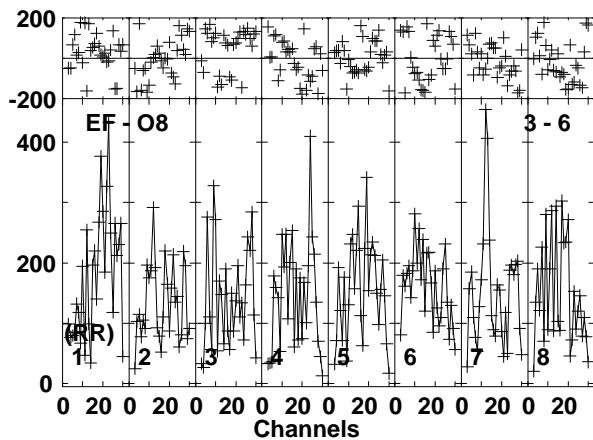
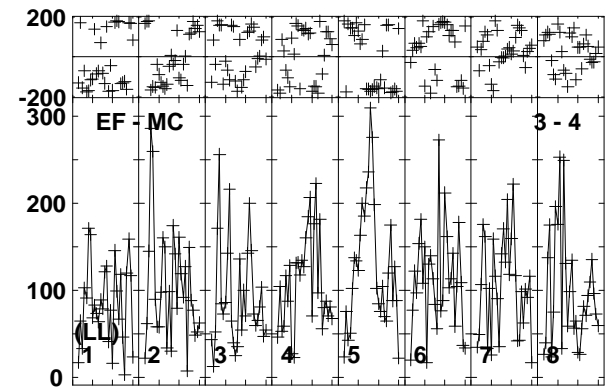
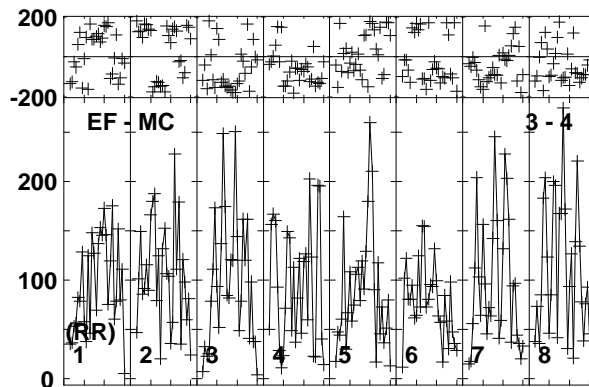
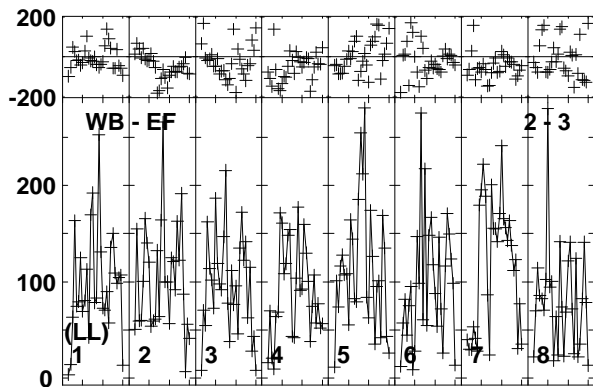
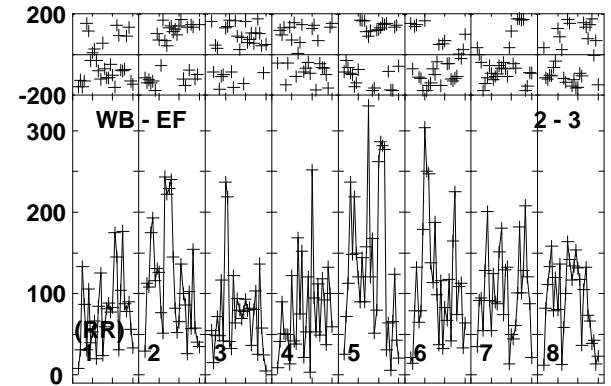
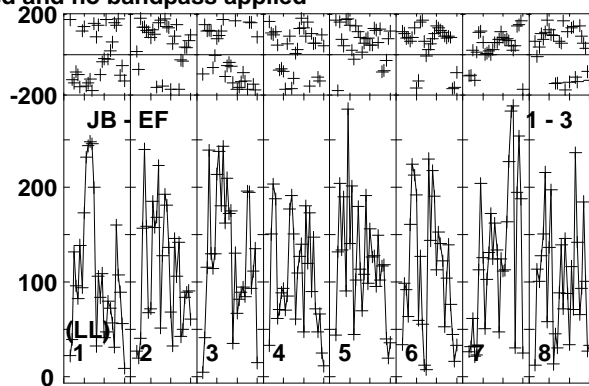
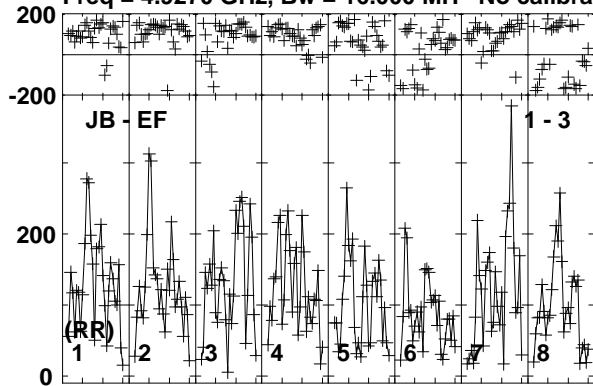

Lower frame: Micro Ampl Jy Top frame: Phas deg  
 Vector averaged cross-power spectrum Baseline: JB (01) - EF (03)  
 Timerange: 00/14:54:31 to 00/14:57:29

Plot file version 674 created 19-DEC-2018 17:59:00  
AT2018\_RY007C.UVDATA.1

Freq = 4.9270 GHz, Bw = 16.000 MH No calibration applied and no bandpass applied

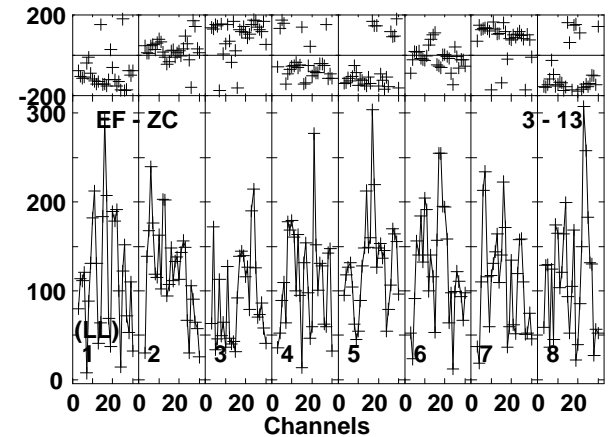
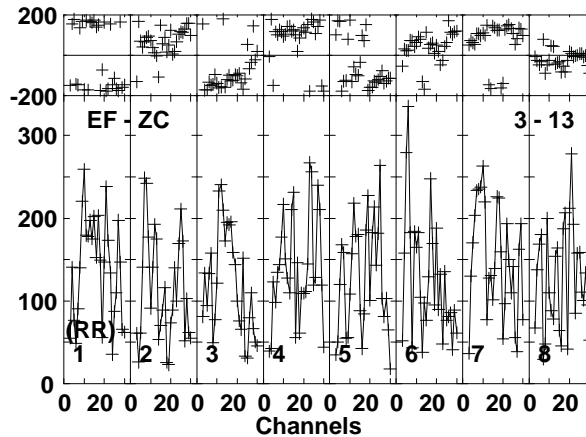
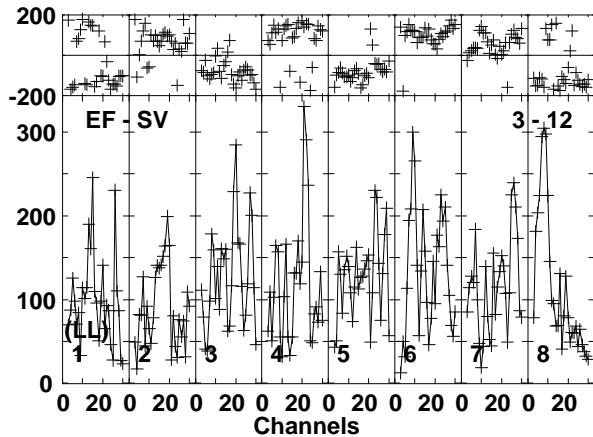
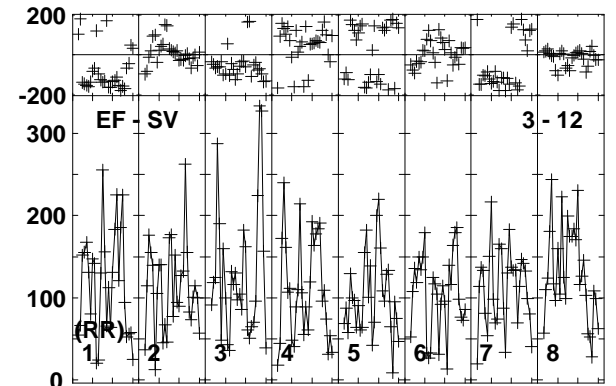
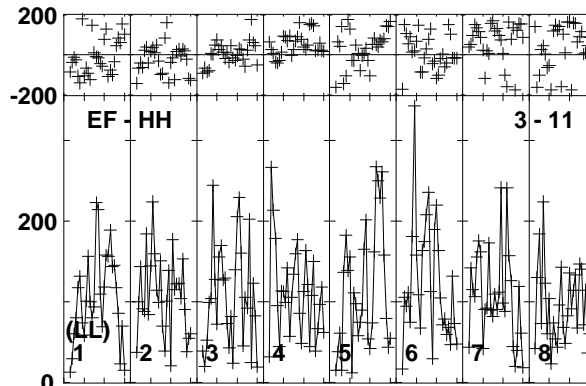
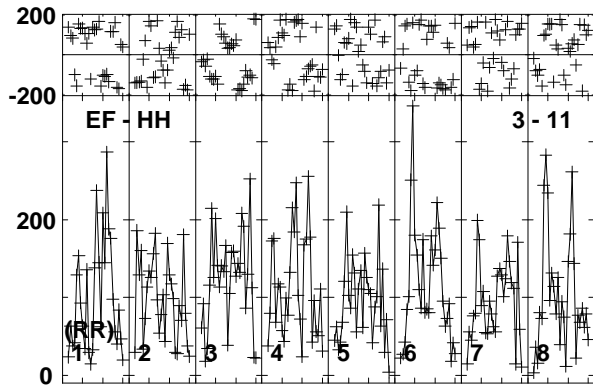
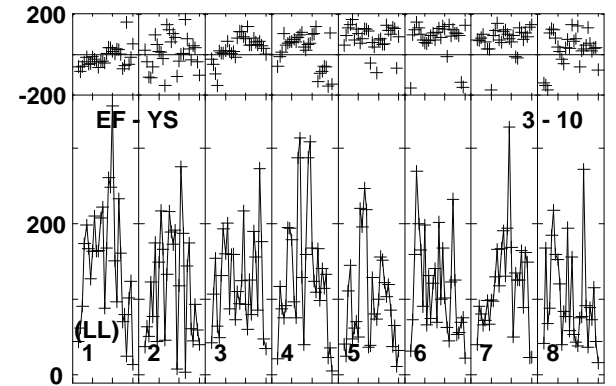
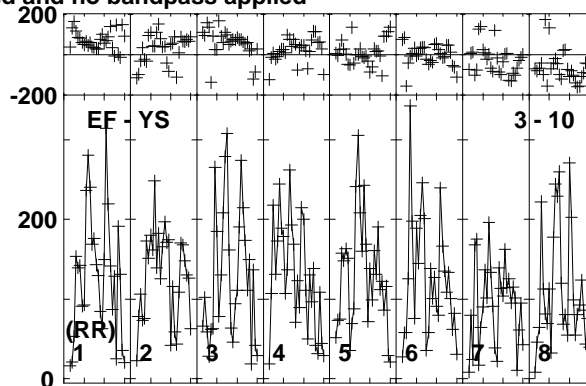
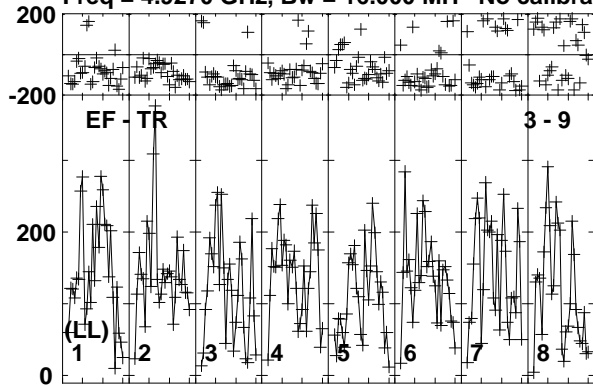

Lower frame: Micro Ampl Jy Top frame: Phas deg  
Vector averaged cross-power spectrum Baseline: EF (03) - TR (09)  
Timerange: 00/14:54:31 to 00/14:57:29



Plot file version 675 created 19-DEC-2018 17:59:00

AT2018\_RY007C.UVDATA.1

Freq = 4.9270 GHz, Bw = 16.000 MH No calibration applied and no bandpass applied

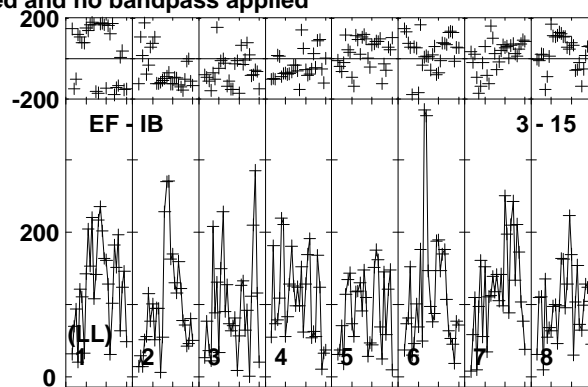
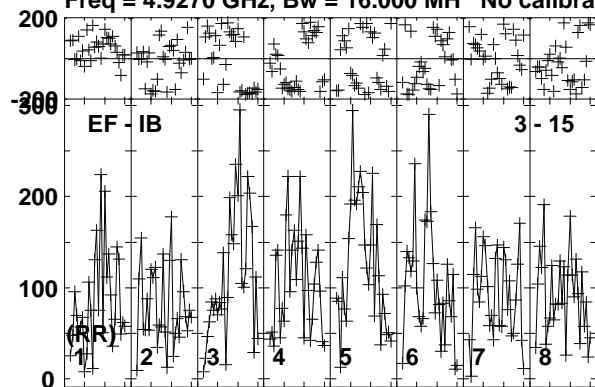

Lower frame: Micro Ampl Jy Top frame: Phas deg  
Vector averaged cross-power spectrum Baseline: EF (03) - IB (15)  
Timerange: 00/14:54:31 to 00/14:57:29

Plot file version 676 created 19-DEC-2018 17:59:00

J1619+2247 RY007C.UVDATA.1

Freq = 4.9270 GHz, Bw = 16.000 MH No calibration applied and no bandpass applied

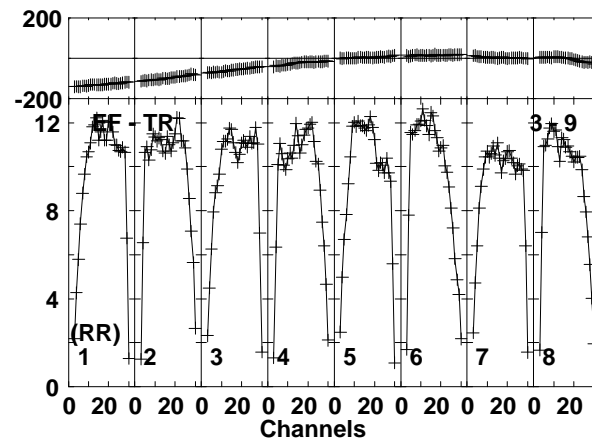
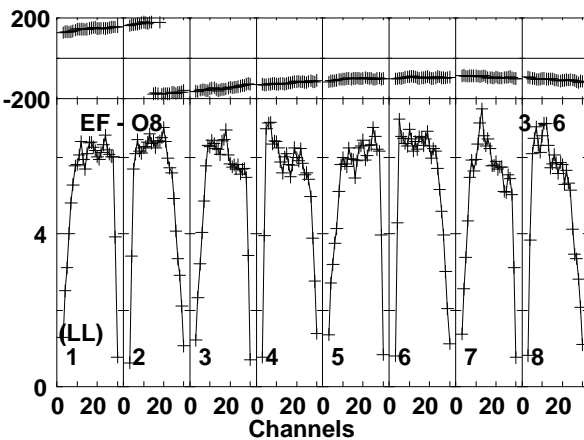
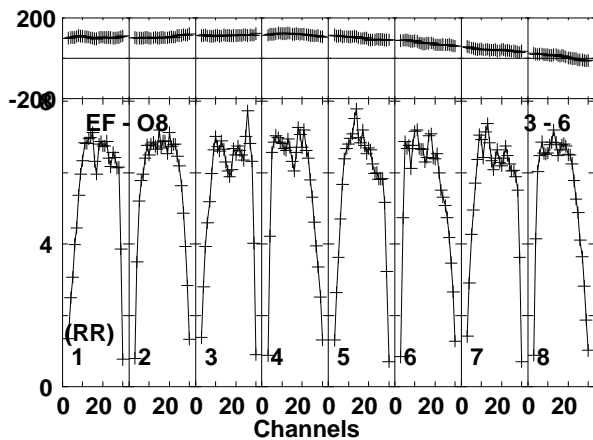
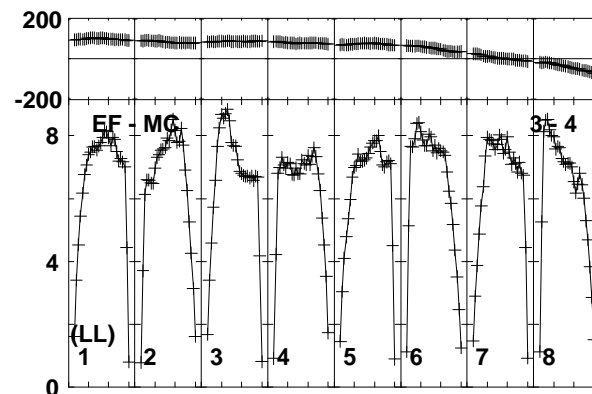
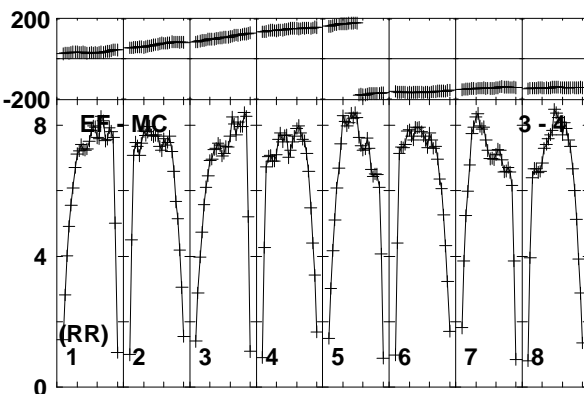
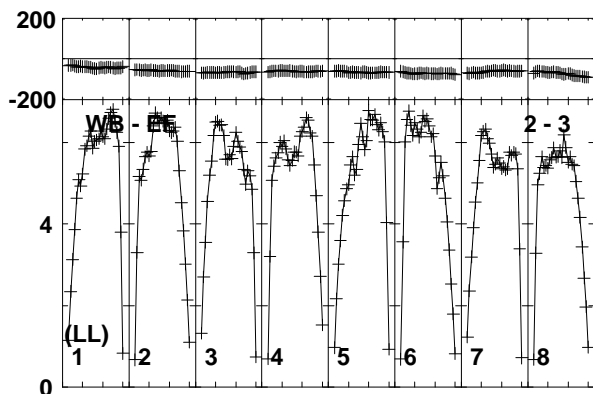
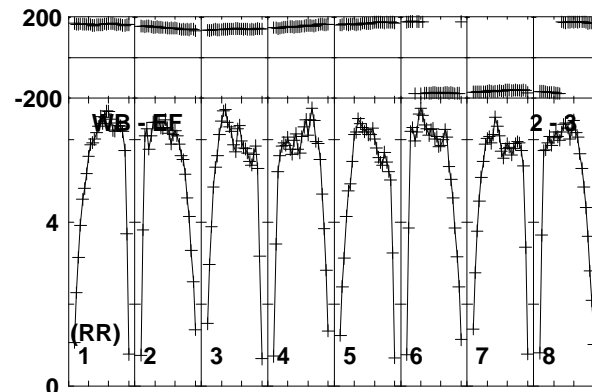
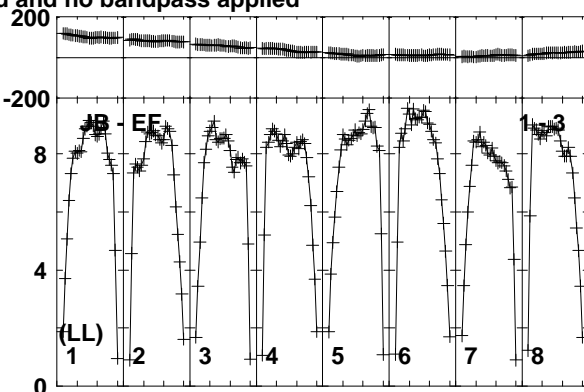
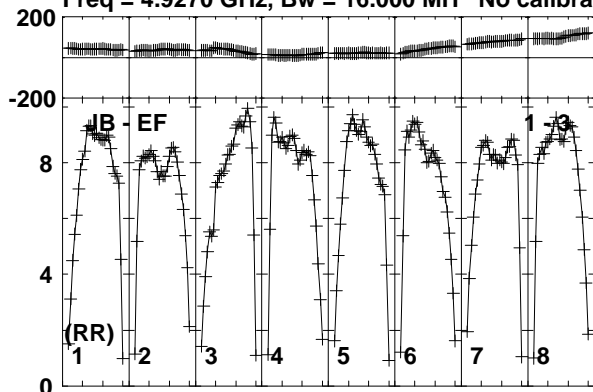

Lower frame: Milli Ampl Jy Top frame: Phas deg  
Vector averaged cross-power spectrum Baseline: JB (01) - EF (03)  
Timerange: 00/14:57:31 to 00/14:58:29

Plot file version 677 created 19-DEC-2018 17:59:00

J1619+2247 RY007C.UVDATA.1

Freq = 4.9270 GHz, Bw = 16.000 MH No calibration applied and no bandpass applied

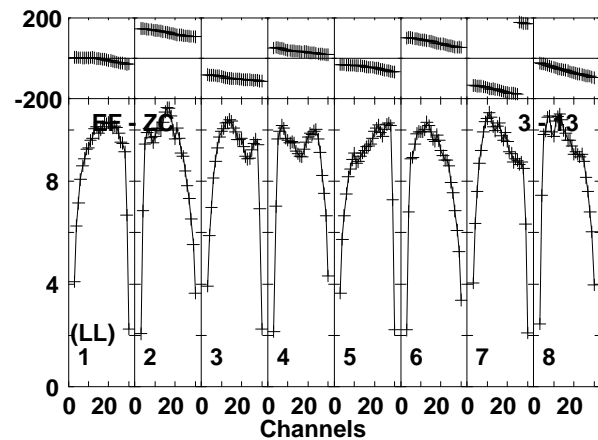
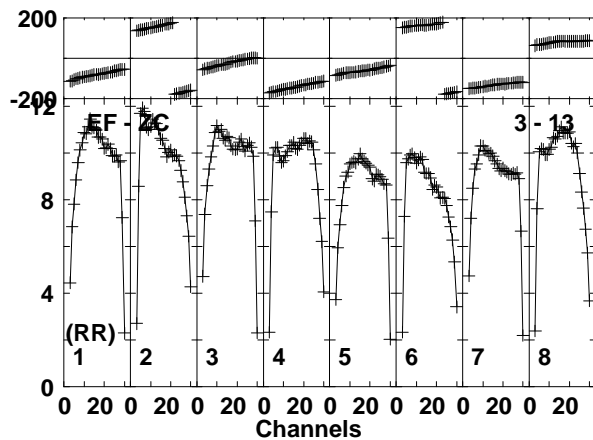
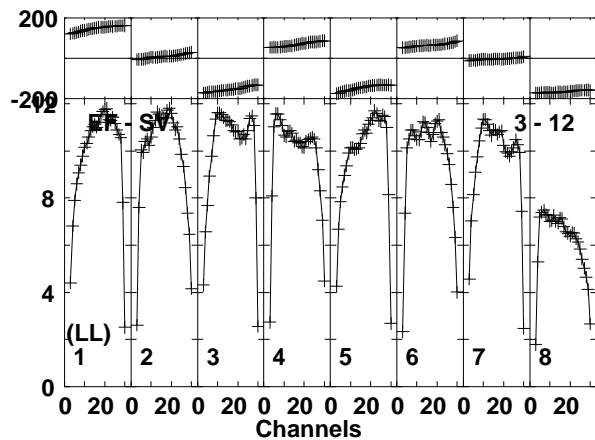
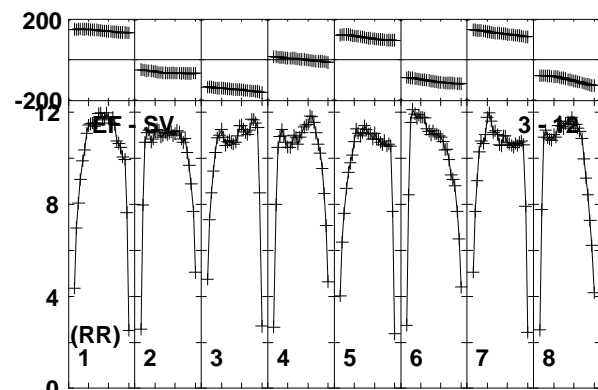
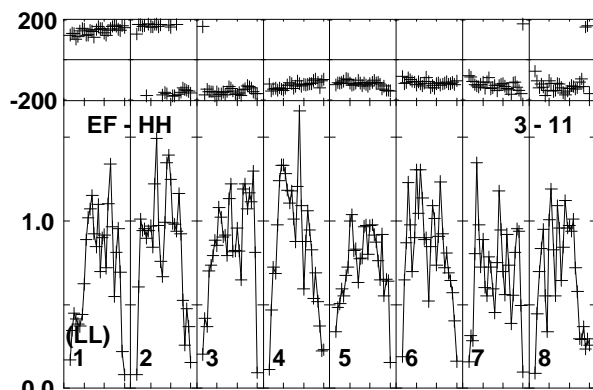
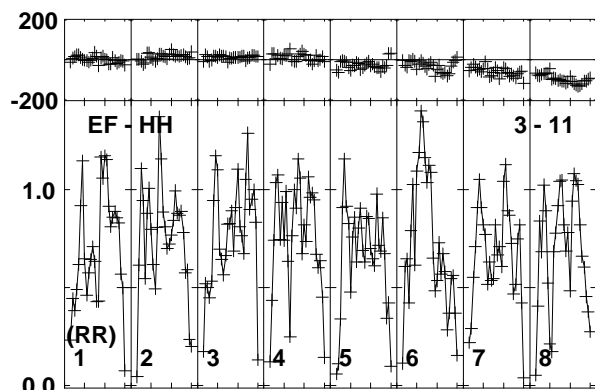
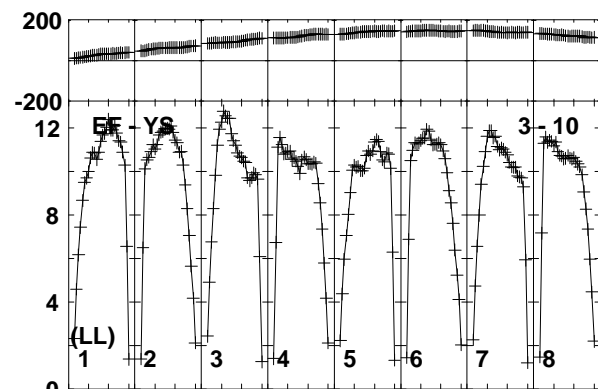
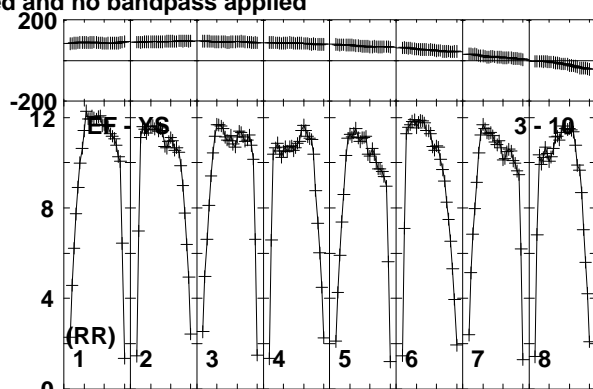
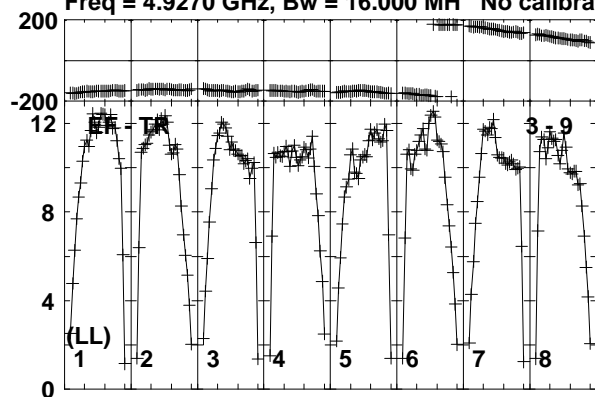

Lower frame: Milli Ampl Jy Top frame: Phas deg  
Vector averaged cross-power spectrum Baseline: EF (03) - TR (09)  
Timerange: 00/14:57:31 to 00/14:58:29

Plot file version 678 created 19-DEC-2018 17:59:00  
J1619+2247 RY007C.UVDATA.1

Freq = 4.9270 GHz, Bw = 16.000 MH No calibration applied and no bandpass applied

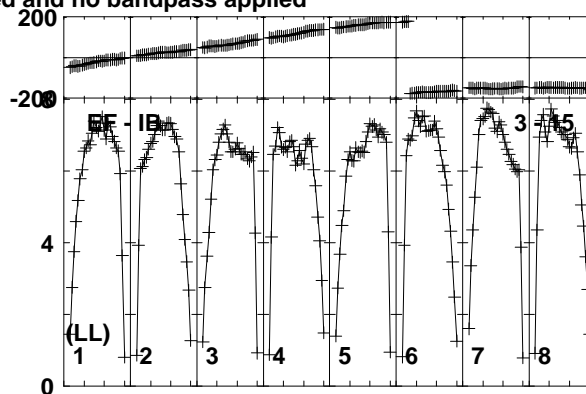
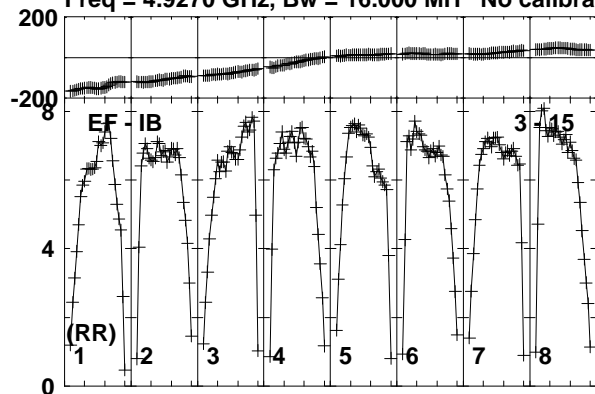

Lower frame: Milli Ampl Jy Top frame: Phas deg  
Vector averaged cross-power spectrum Baseline: EF (03) - IB (15)  
Timerange: 00/14:57:31 to 00/14:58:29

Plot file version 679 created 19-DEC-2018 17:59:00  
AT2018\_RY007C.UVDATA.1

Freq = 4.9270 GHz, Bw = 16.000 MH No calibration applied and no bandpass applied

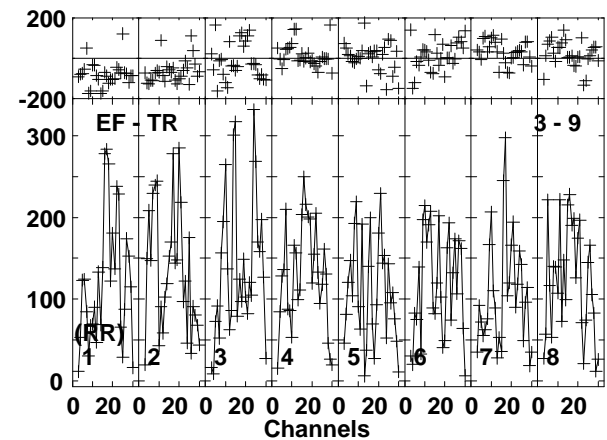
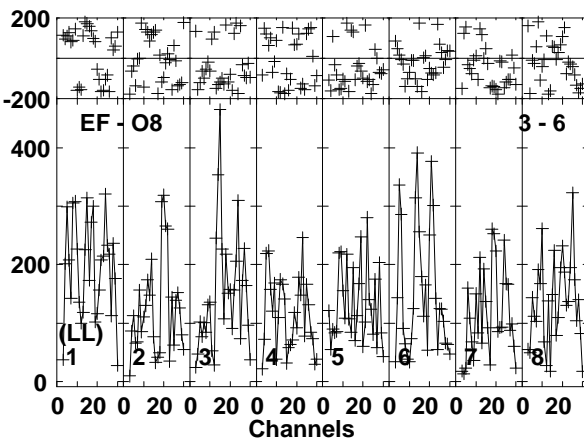
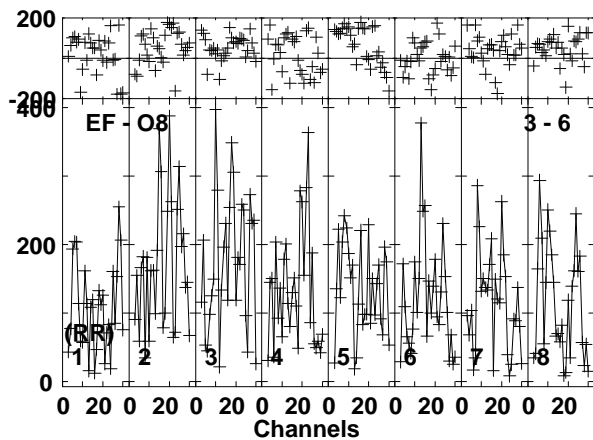
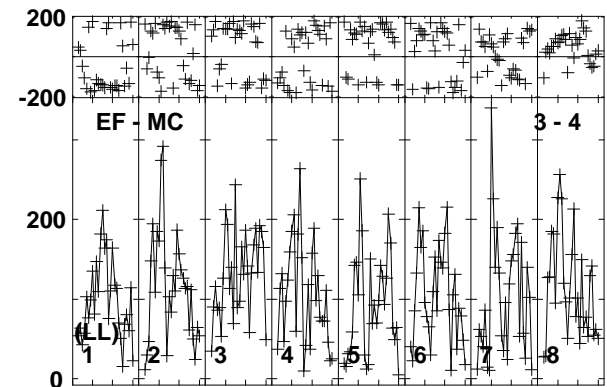
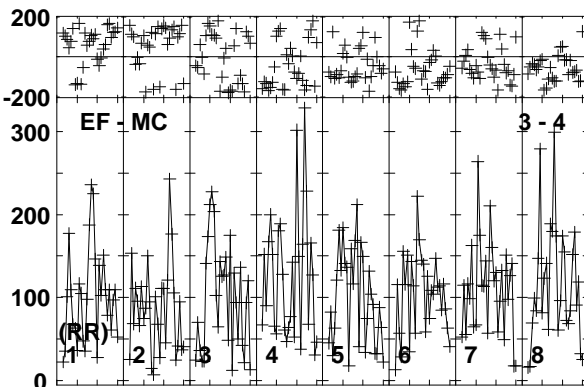
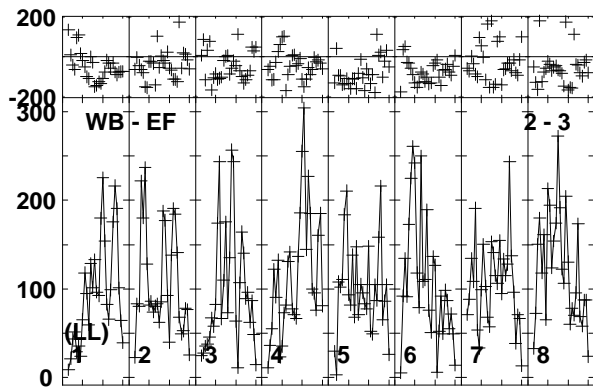
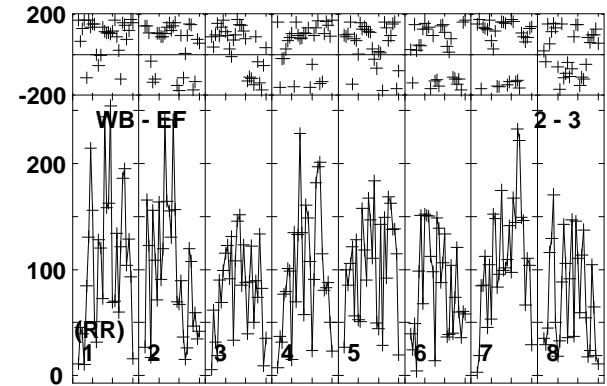
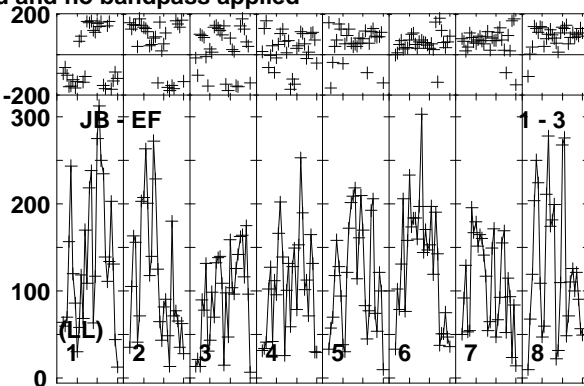
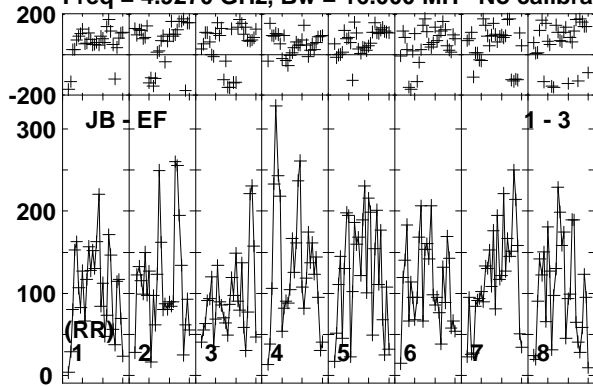

Lower frame: Micro Ampl Jy Top frame: Phas deg  
Vector averaged cross-power spectrum Baseline: JB (01) - EF (03)  
Timerange: 00/14:58:31 to 00/15:01:29

Plot file version 680 created 19-DEC-2018 17:59:00  
AT2018\_RY007C.UVDATA.1

Freq = 4.9270 GHz, Bw = 16.000 MH No calibration applied and no bandpass applied

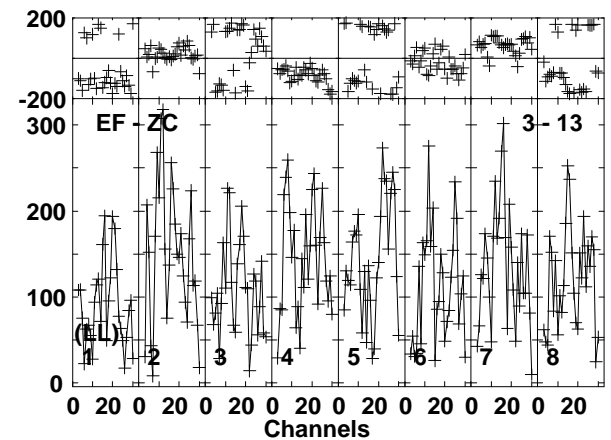
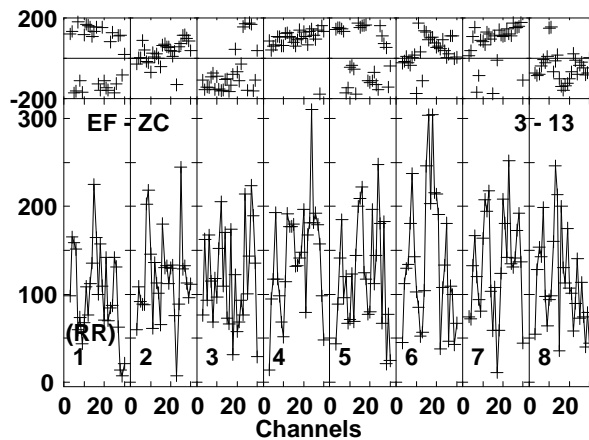
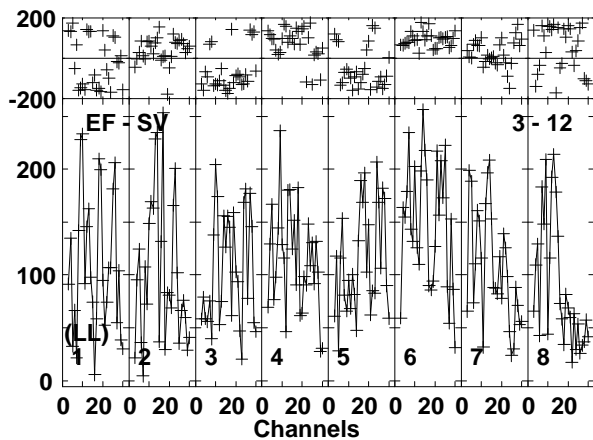
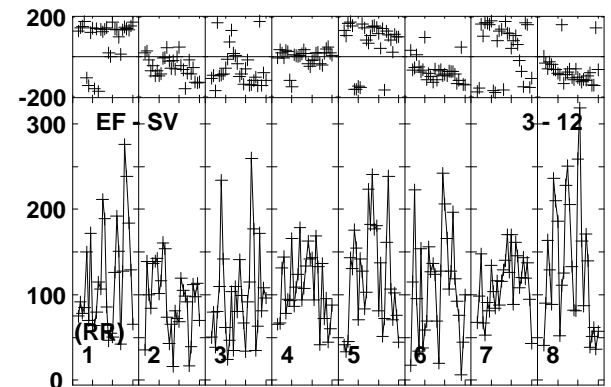
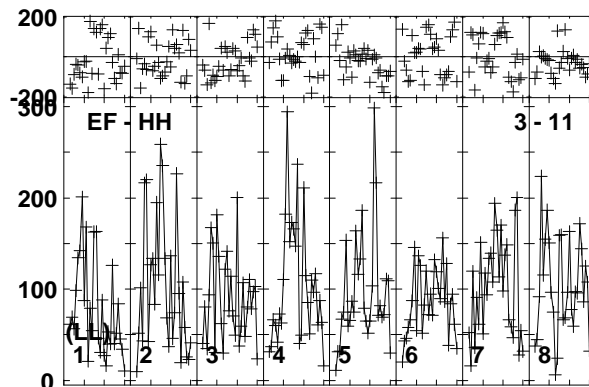
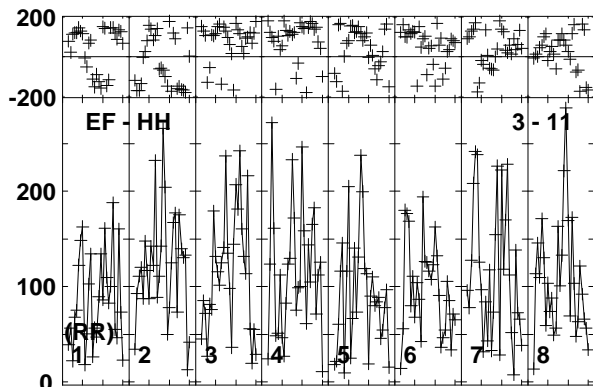
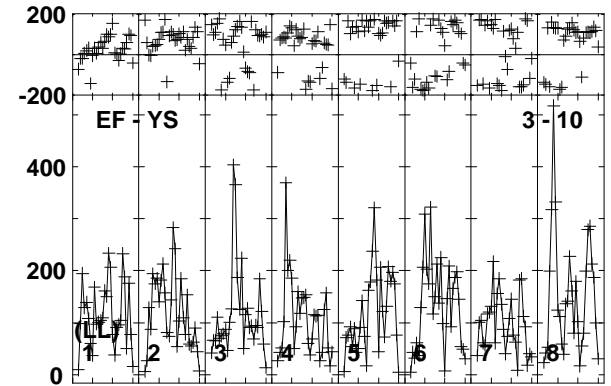
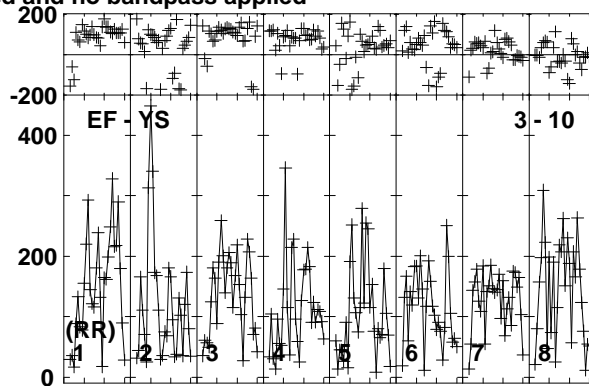
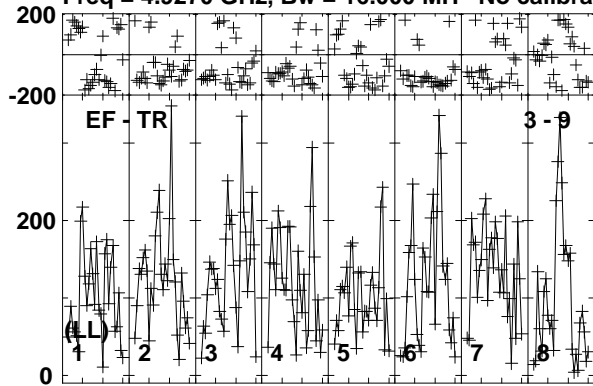

Lower frame: Micro Ampl Jy Top frame: Phas deg  
Vector averaged cross-power spectrum Baseline: EF (03) - TR (09)  
Timerange: 00/14:58:31 to 00/15:01:29

Plot file version 681 created 19-DEC-2018 17:59:00

AT2018\_RY007C.UVDATA.1

Freq = 4.9270 GHz, Bw = 16.000 MH No calibration applied and no bandpass applied

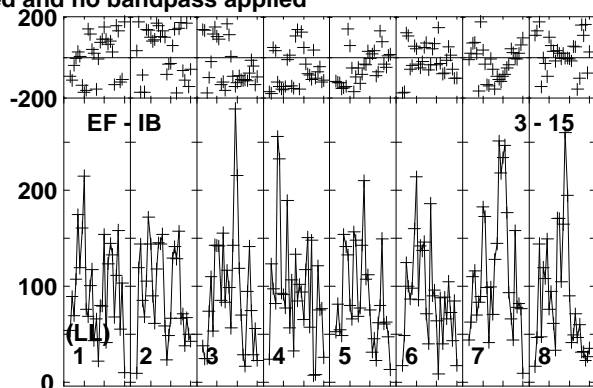
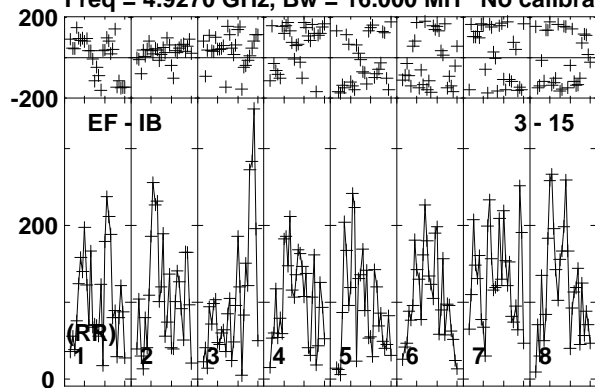

Lower frame: Micro Ampl Jy Top frame: Phas deg  
Vector averaged cross-power spectrum Baseline: EF (03) - IB (15)  
Timerange: 00/14:58:31 to 00/15:01:29

Plot file version 682 created 19-DEC-2018 17:59:00

J1619+2247 RY007C.UVDATA.1

Freq = 4.9270 GHz, Bw = 16.000 MH No calibration applied and no bandpass applied

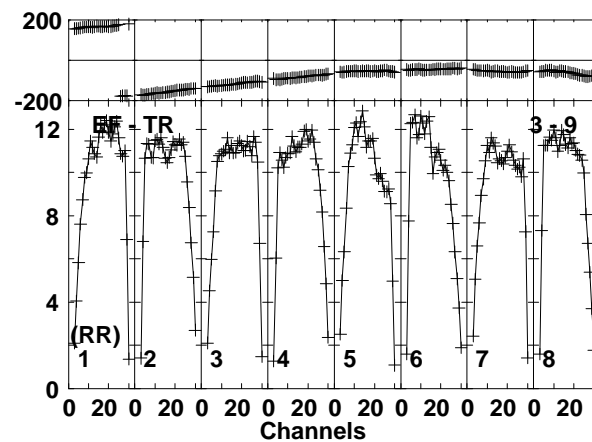
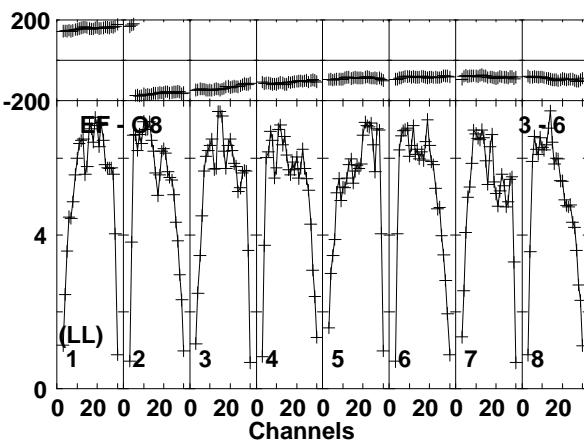
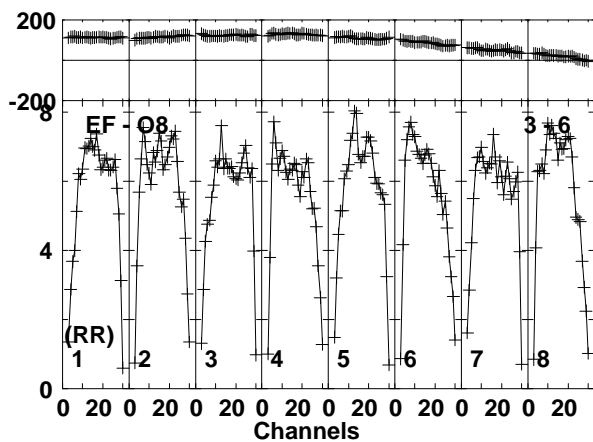
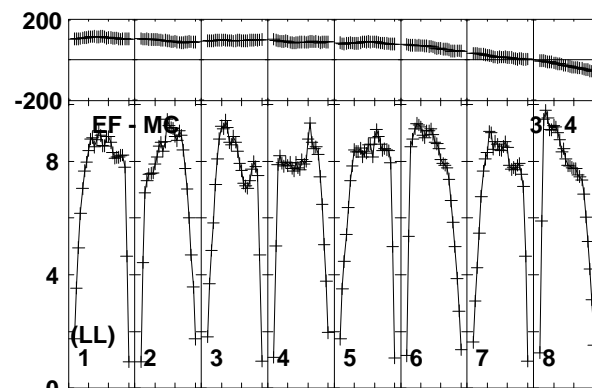
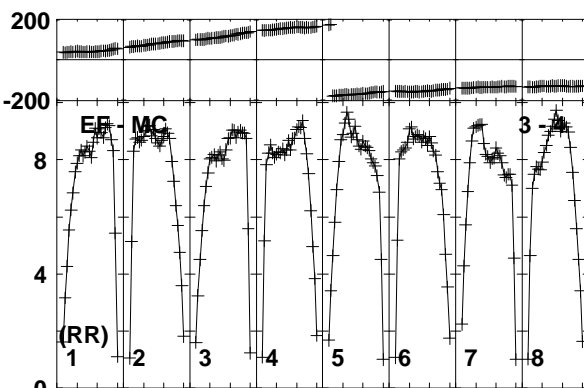
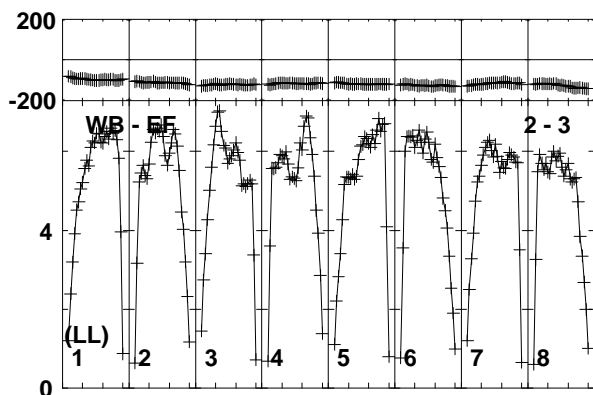
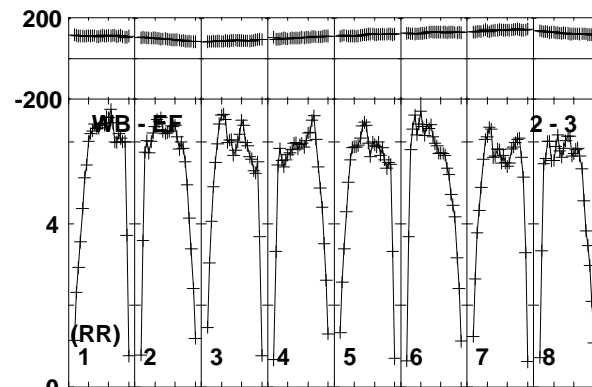
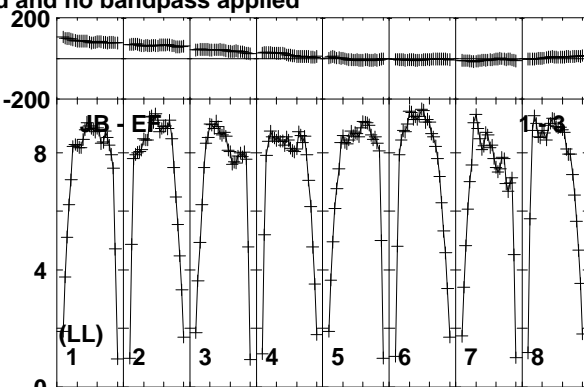
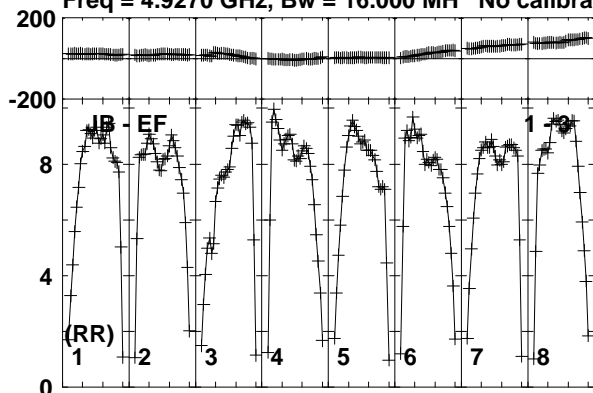

Lower frame: Milli Ampl Jy Top frame: Phas deg  
Vector averaged cross-power spectrum Baseline: JB (01) - EF (03)  
Timerange: 00/15:01:31 to 00/15:02:29



Plot file version 683 created 19-DEC-2018 17:59:00

J1619+2247 RY007C.UVDATA.1

Freq = 4.9270 GHz, Bw = 16.000 MH No calibration applied and no bandpass applied

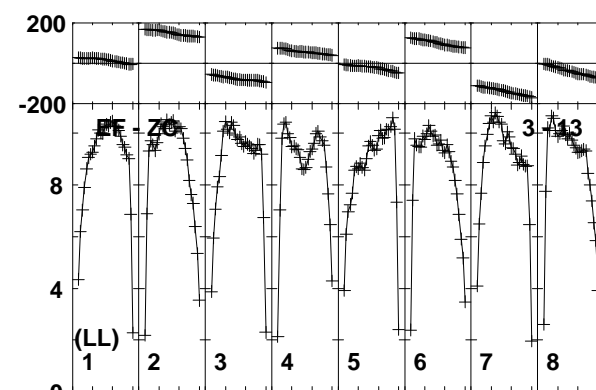
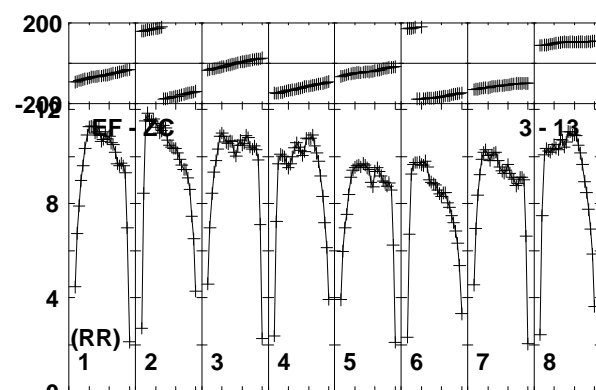
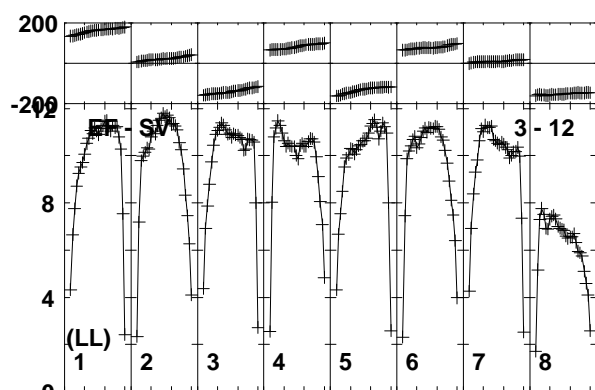
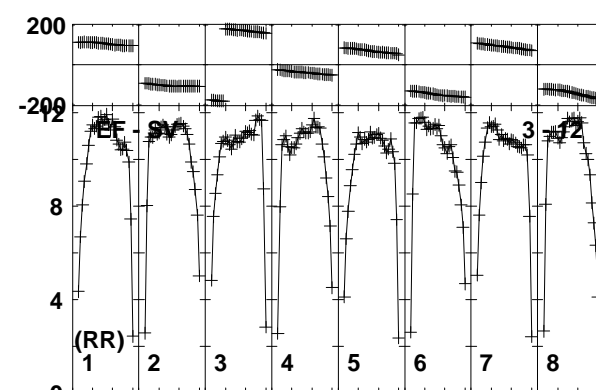
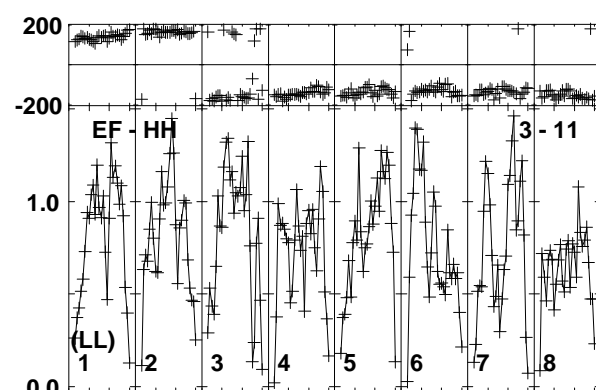
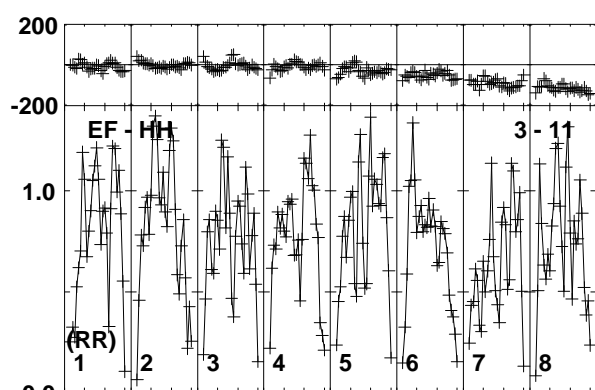
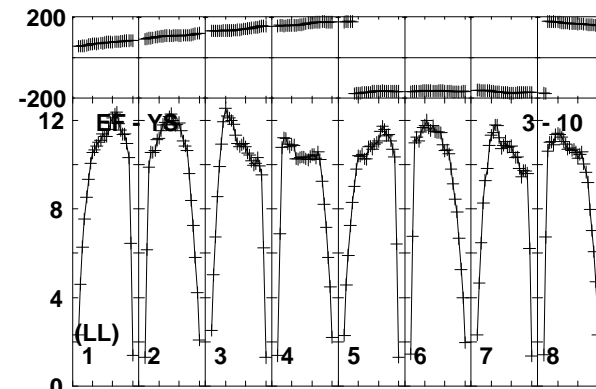
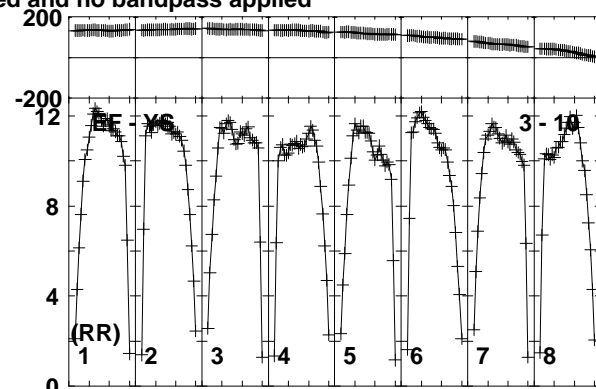
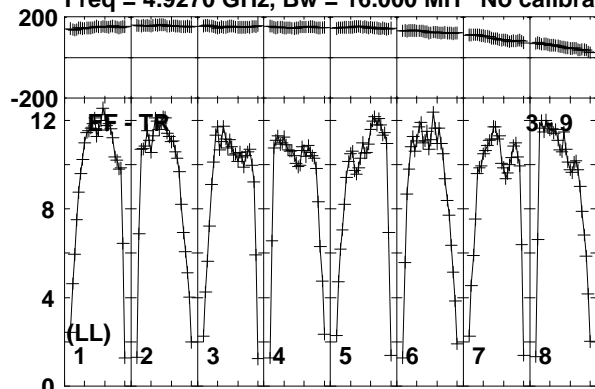

Lower frame: Milli Ampl Jy Top frame: Phas deg  
Vector averaged cross-power spectrum Baseline: EF (03) - TR (09)  
Timerange: 00/15:01:31 to 00/15:02:29

Plot file version 684 created 19-DEC-2018 17:59:00  
J1619+2247 RY007C.UVDATA.1

Freq = 4.9270 GHz, Bw = 16.000 MH No calibration applied and no bandpass applied

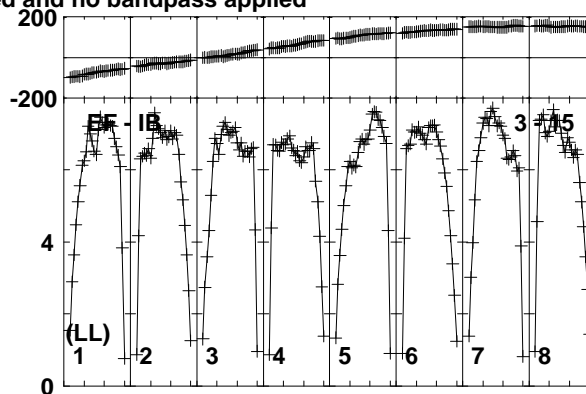
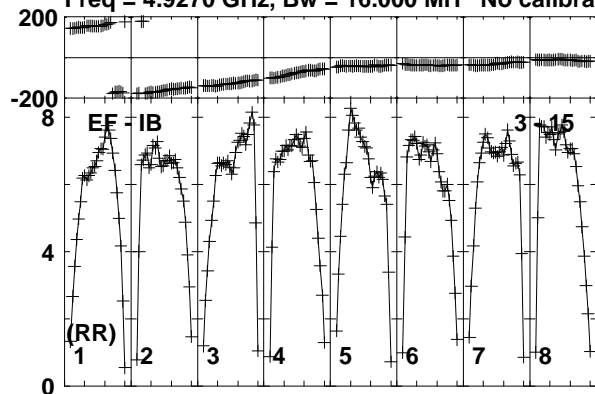

Lower frame: Milli Ampl Jy Top frame: Phas deg  
Vector averaged cross-power spectrum Baseline: EF (03) - IB (15)  
Timerange: 00/15:01:31 to 00/15:02:29

Plot file version 685 created 19-DEC-2018 17:59:00

VLA1 RY007C.UVDATA.1

Freq = 4.9270 GHz, Bw = 16.000 MH No calibration applied and no bandpass applied

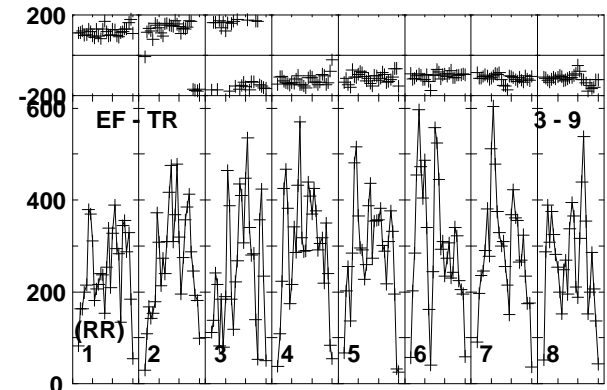
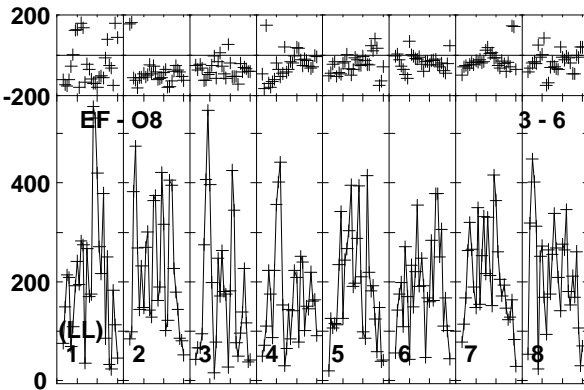
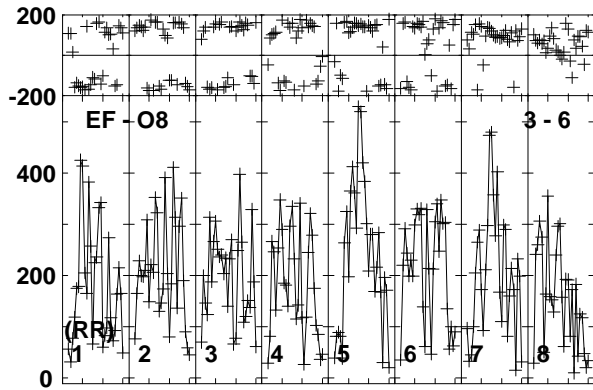
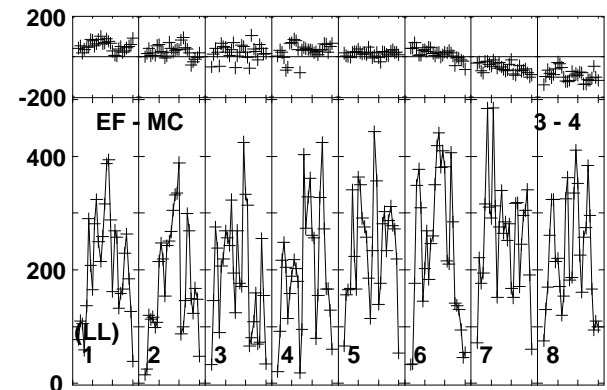
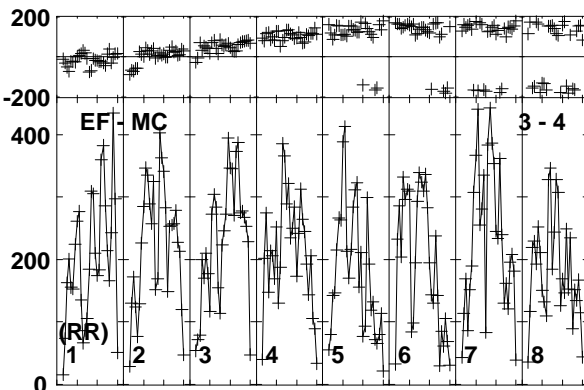
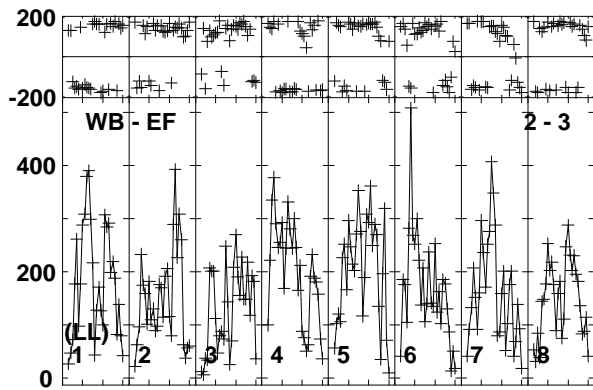
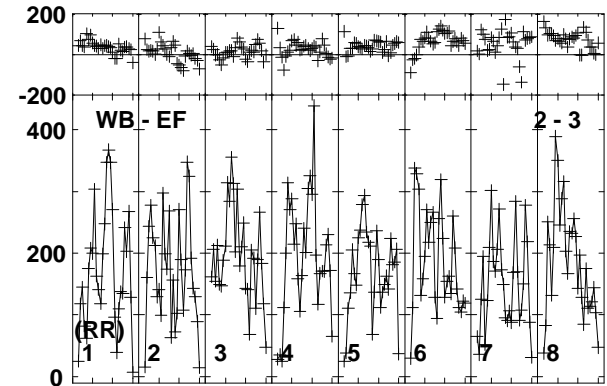
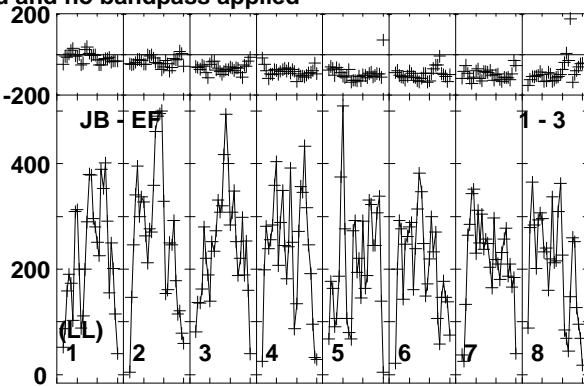
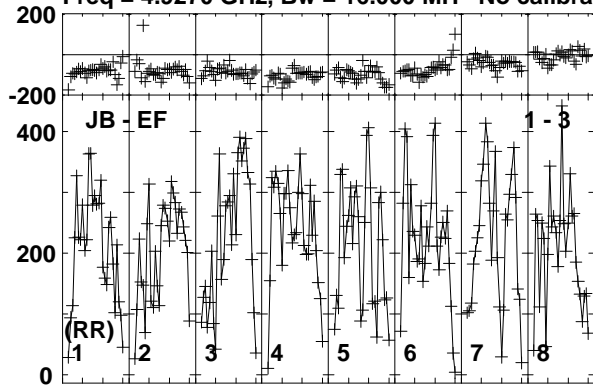

Lower frame: Micro Ampl Jy Top frame: Phas deg  
Vector averaged cross-power spectrum Baseline: JB (01) - EF (03)  
Timerange: 00/15:03:01 to 00/15:04:59

Plot file version 686 created 19-DEC-2018 17:59:00  
 VLA1 RY007C.UVDATA.1  
 Freq = 4.9270 GHz, Bw = 16.000 MH No calibration applied and no bandpass applied

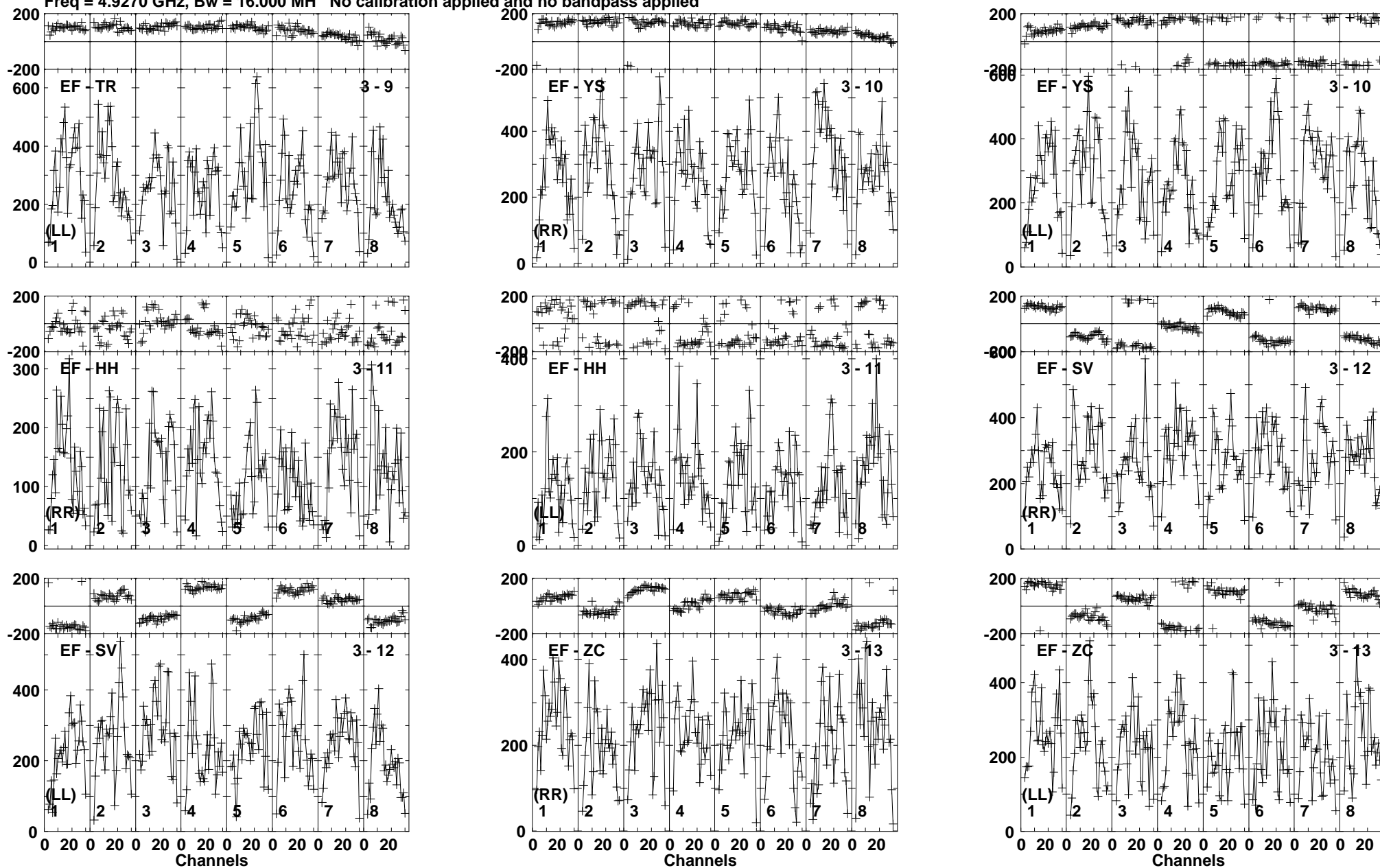

Lower frame: Micro Ampl Jy Top frame: Phas deg  
 Vector averaged cross-power spectrum Baseline: EF (03) - TR (09)  
 Timerange: 00/15:03:01 to 00/15:04:59

Plot file version 687 created 19-DEC-2018 17:59:00

VLA1 RY007C.UVDATA.1

Freq = 4.9270 GHz, Bw = 16.000 MH No calibration applied and no bandpass applied

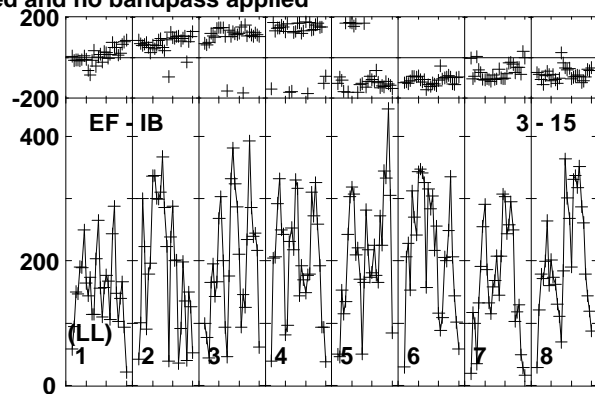
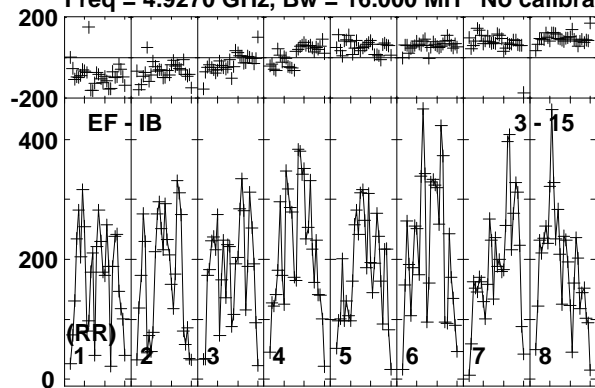

Lower frame: Micro Ampl Jy Top frame: Phas deg  
Vector averaged cross-power spectrum Baseline: EF (03) - IB (15)  
Timerange: 00/15:03:01 to 00/15:04:59

Plot file version 688 created 19-DEC-2018 17:59:00

J1619+2247 RY007C.UVDATA.1

Freq = 4.9270 GHz, Bw = 16.000 MH No calibration applied and no bandpass applied

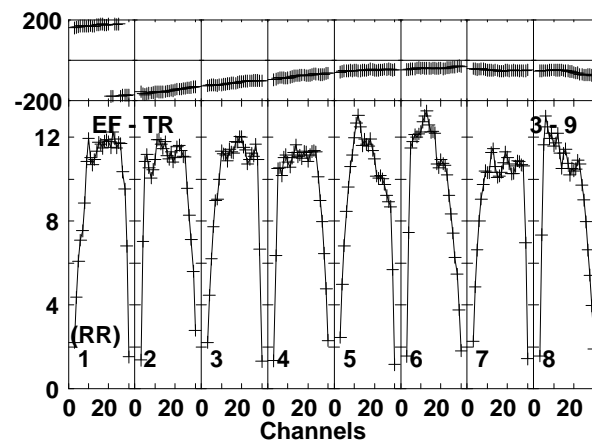
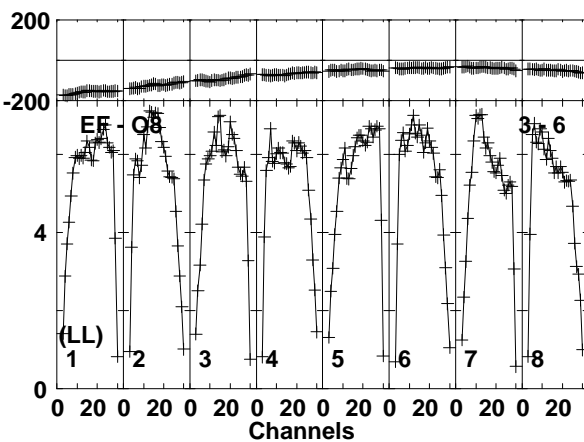
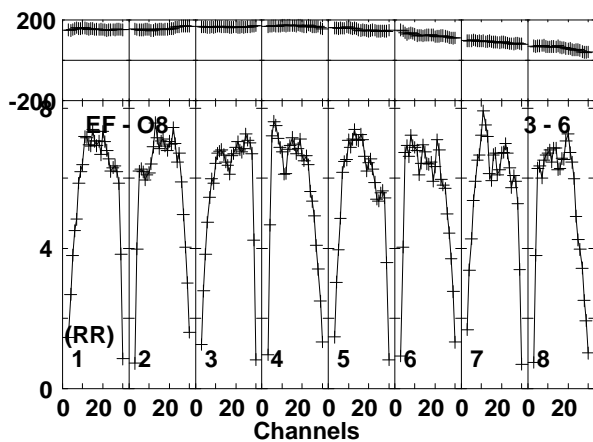
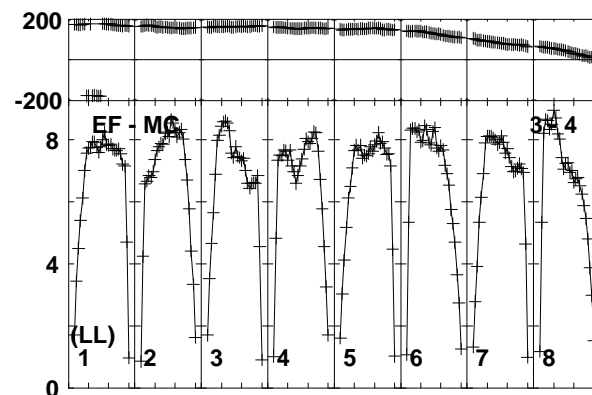
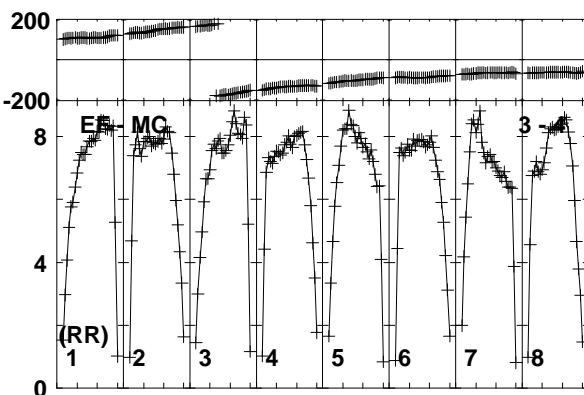
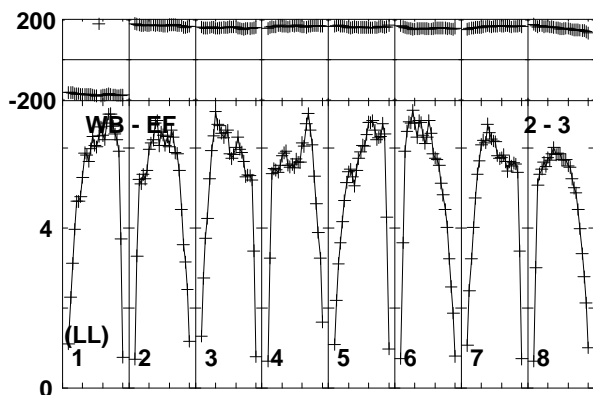
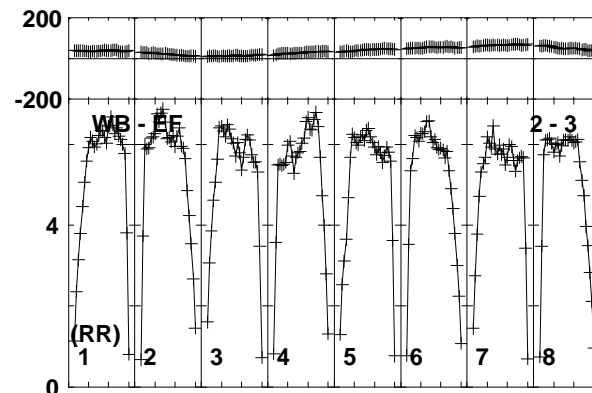
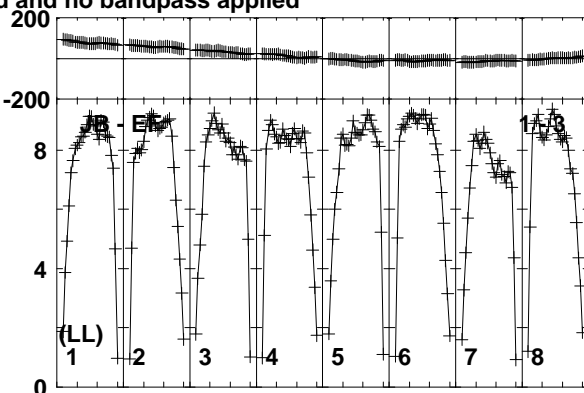
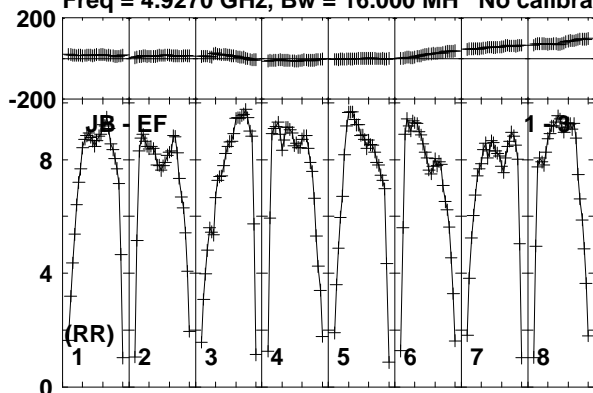

Lower frame: Milli Ampl Jy Top frame: Phas deg  
Vector averaged cross-power spectrum Baseline: JB (01) - EF (03)  
Timerange: 00/15:05:01 to 00/15:05:59

Plot file version 689 created 19-DEC-2018 17:59:00

J1619+2247 RY007C.UVDATA.1

Freq = 4.9270 GHz, Bw = 16.000 MH No calibration applied and no bandpass applied

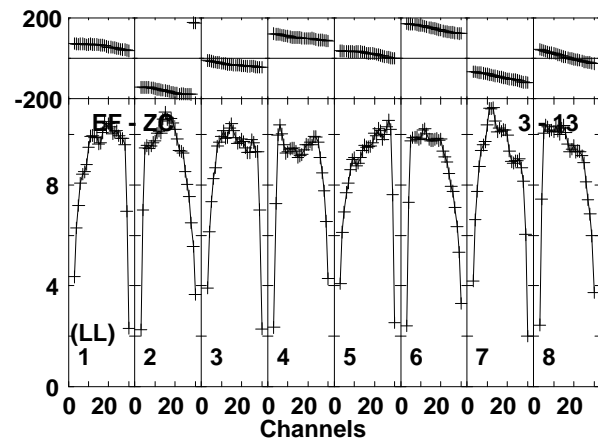
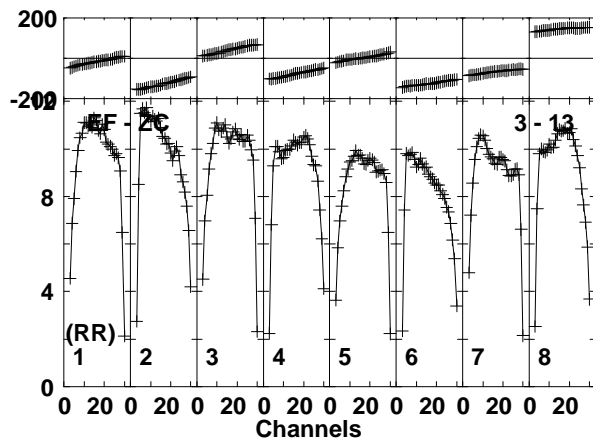
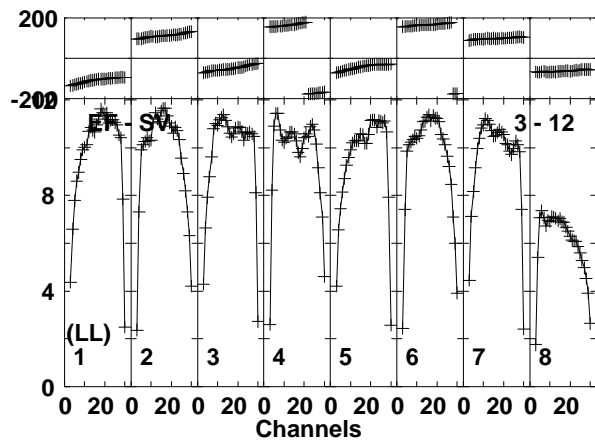
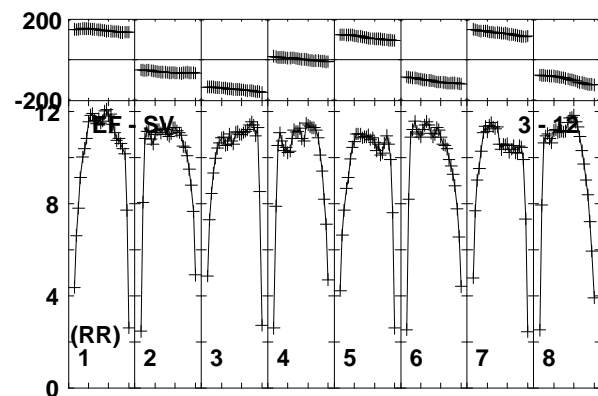
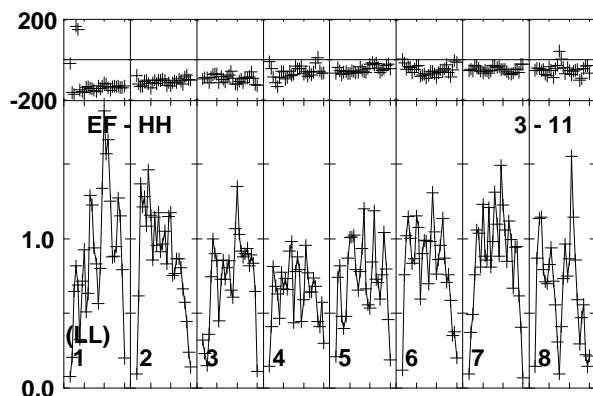
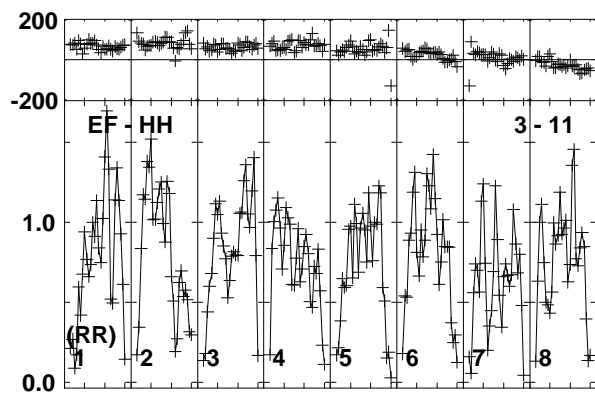
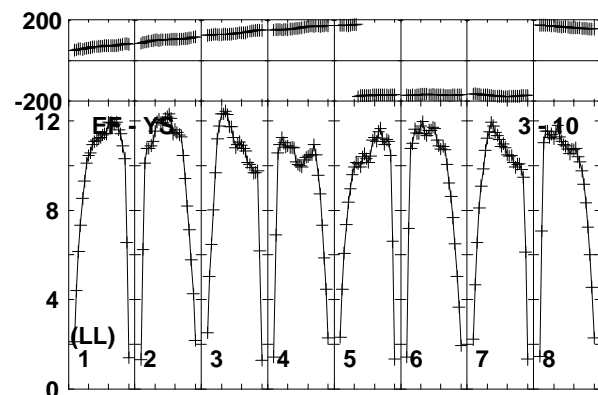
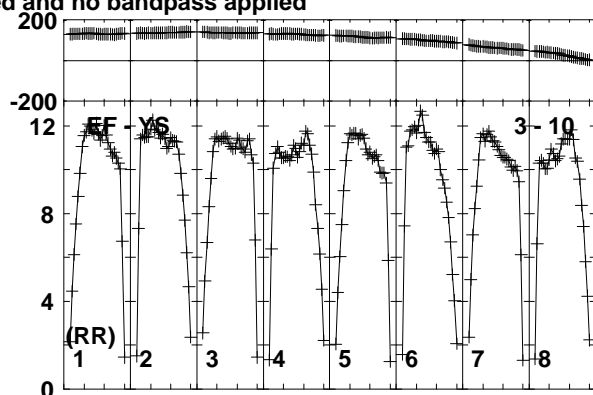
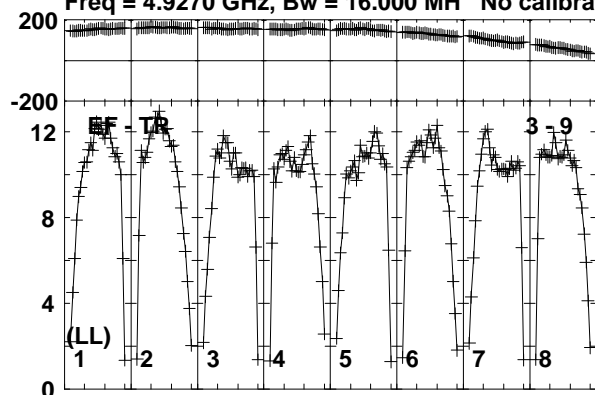

Lower frame: Milli Ampl Jy Top frame: Phas deg  
Vector averaged cross-power spectrum Baseline: EF (03) - TR (09)  
Timerange: 00/15:05:01 to 00/15:05:59

Plot file version 690 created 19-DEC-2018 17:59:01  
J1619+2247 RY007C.UVDATA.1

Freq = 4.9270 GHz, Bw = 16.000 MH No calibration applied and no bandpass applied

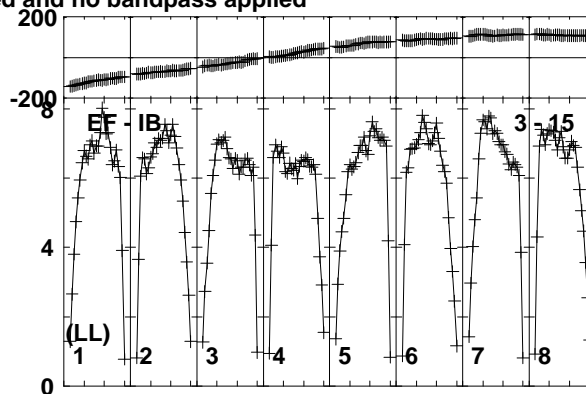
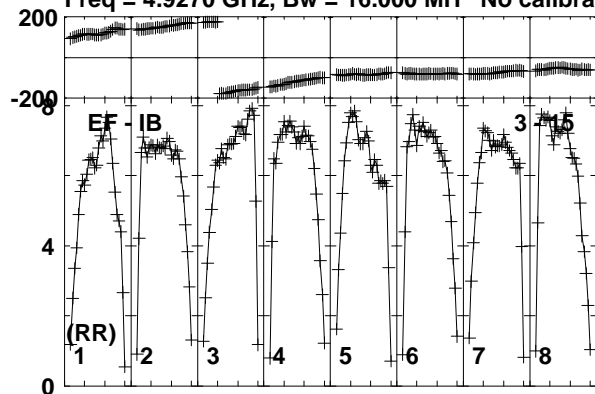

Lower frame: Milli Ampl Jy Top frame: Phas deg  
Vector averaged cross-power spectrum Baseline: EF (03) - IB (15)  
Timerange: 00/15:05:01 to 00/15:05:59



Plot file version 691 created 19-DEC-2018 17:59:01

AT2018\_RY007C.UVDATA.1

Freq = 4.9270 GHz, Bw = 16.000 MH No calibration applied and no bandpass applied

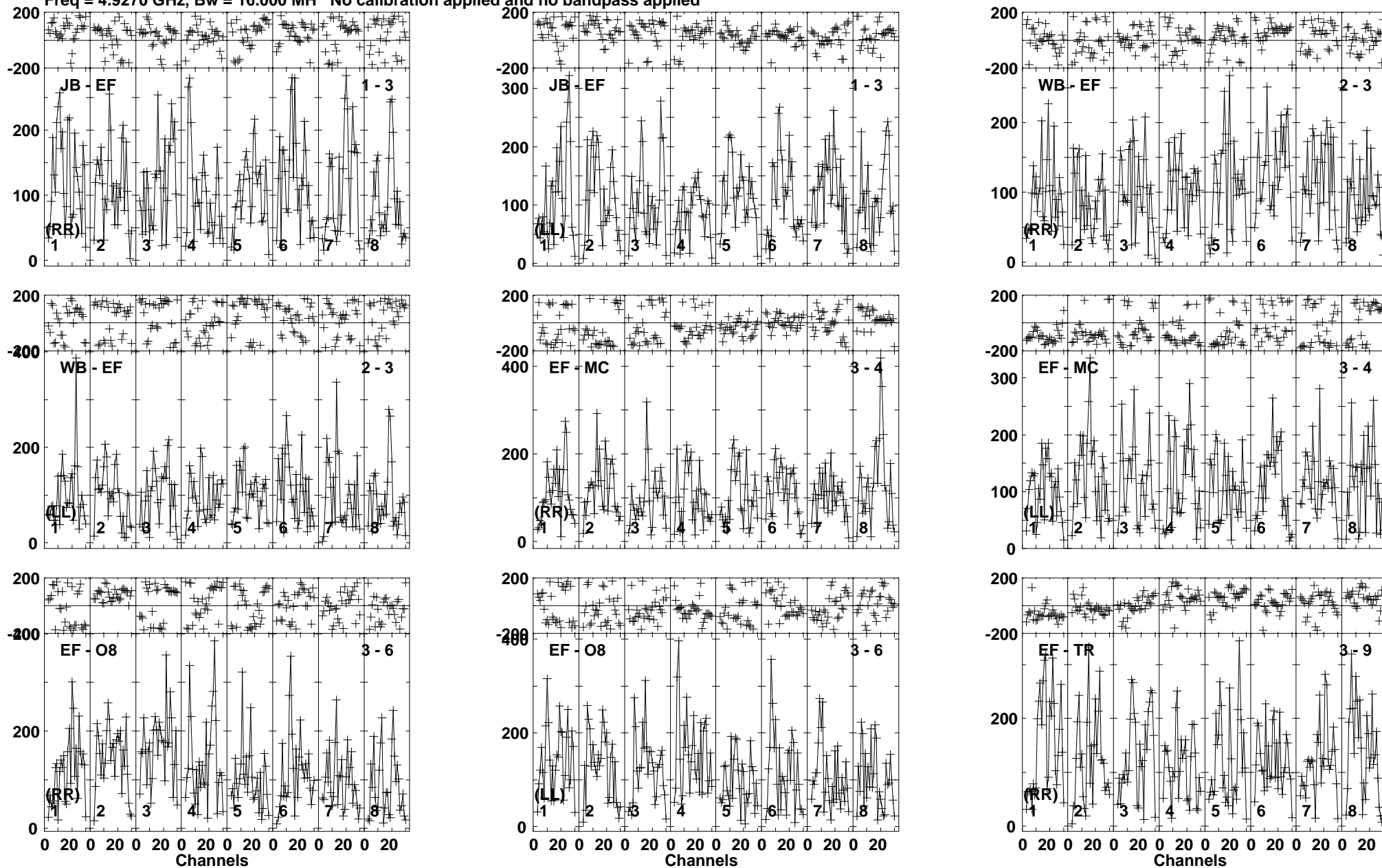

Lower frame: Micro Ampl Jy Top frame: Phas deg  
Vector averaged cross-power spectrum Baseline: JB (01) - EF (03)  
Timerange: 00/15:06:01 to 00/15:08:59

Plot file version 692 created 19-DEC-2018 17:59:01  
AT2018\_RY007C.UVDATA.1

Freq = 4.9270 GHz, Bw = 16.000 MH No calibration applied and no bandpass applied

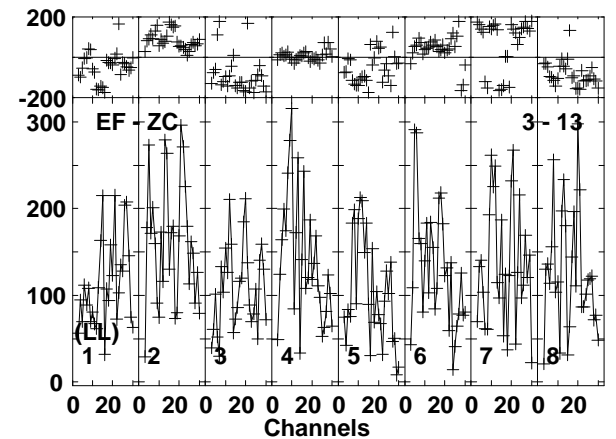
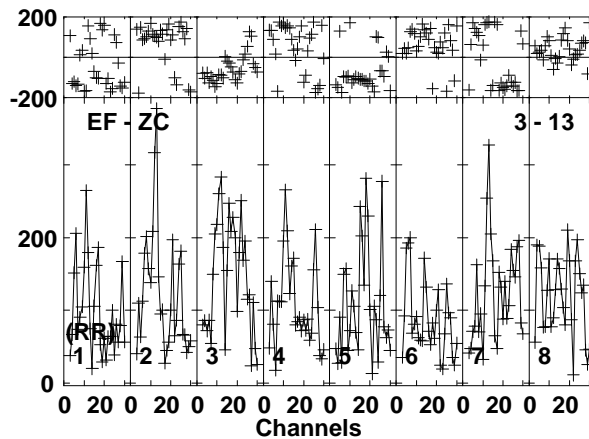
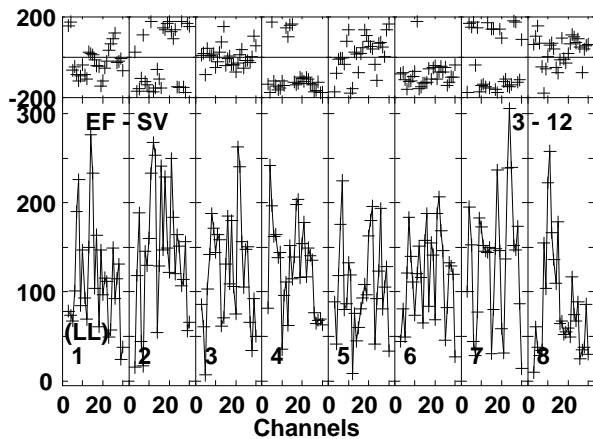
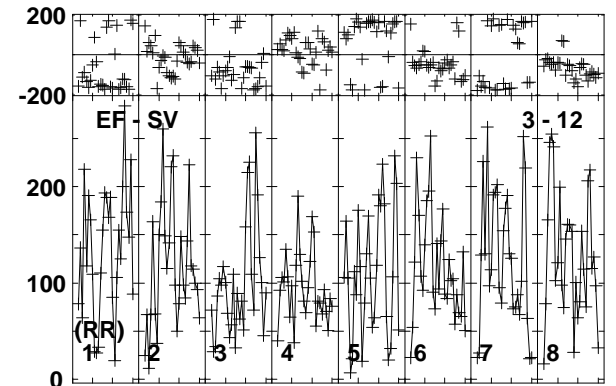
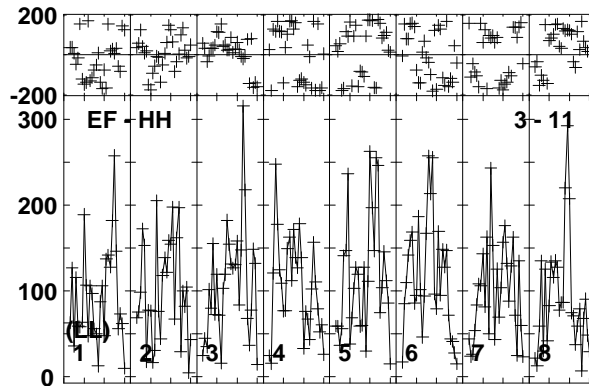
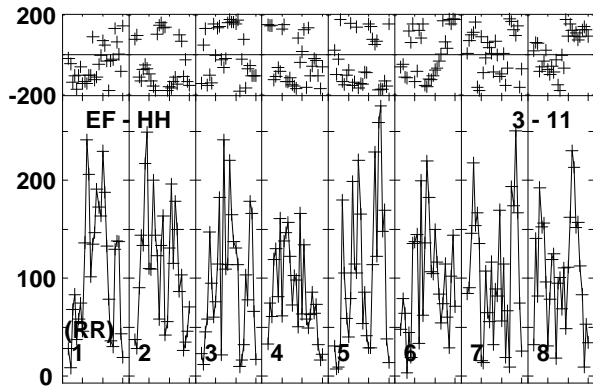
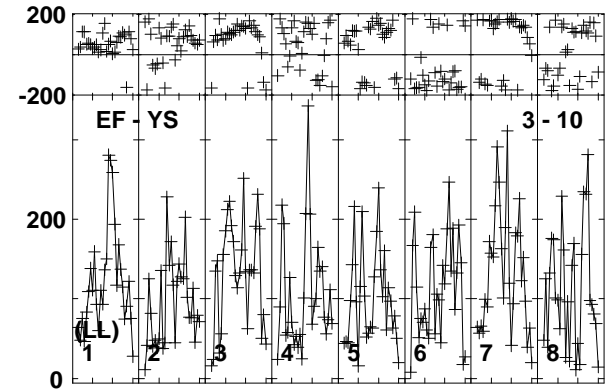
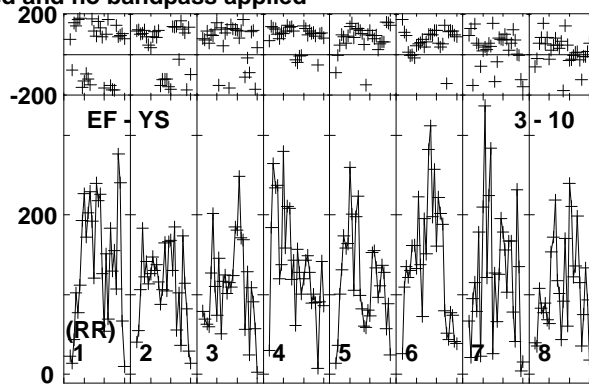
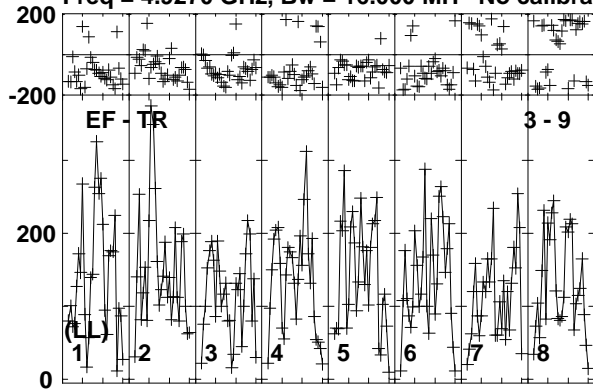

Lower frame: Micro Ampl Jy Top frame: Phas deg  
Vector averaged cross-power spectrum Baseline: EF (03) - TR (09)  
Timerange: 00/15:06:01 to 00/15:08:59

Plot file version 693 created 19-DEC-2018 17:59:01

AT2018\_RY007C.UVDATA.1

Freq = 4.9270 GHz, Bw = 16.000 MH No calibration applied and no bandpass applied

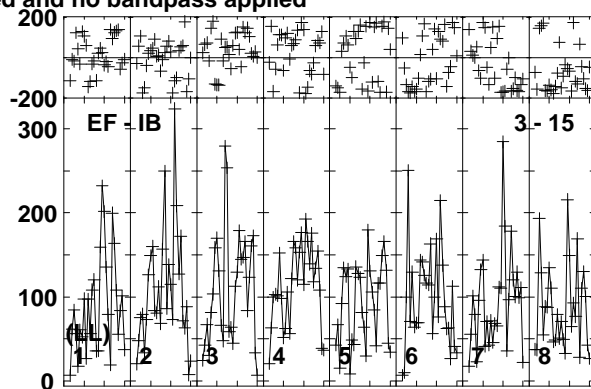
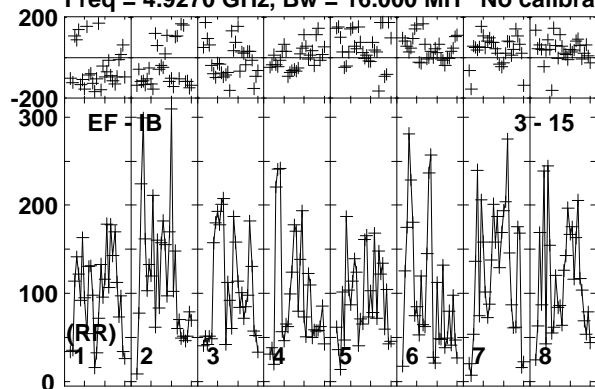

Lower frame: Micro Ampl Jy Top frame: Phas deg  
Vector averaged cross-power spectrum Baseline: EF (03) - IB (15)  
Timerange: 00/15:06:01 to 00/15:08:59

Plot file version 694 created 19-DEC-2018 17:59:01

J1619+2247 RY007C.UVDATA.1

Freq = 4.9270 GHz, Bw = 16.000 MH No calibration applied and no bandpass applied

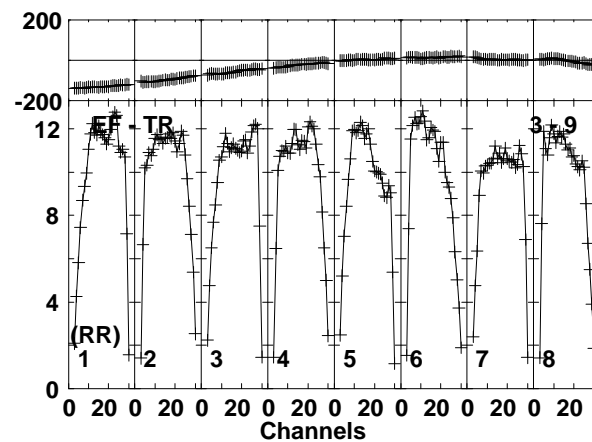
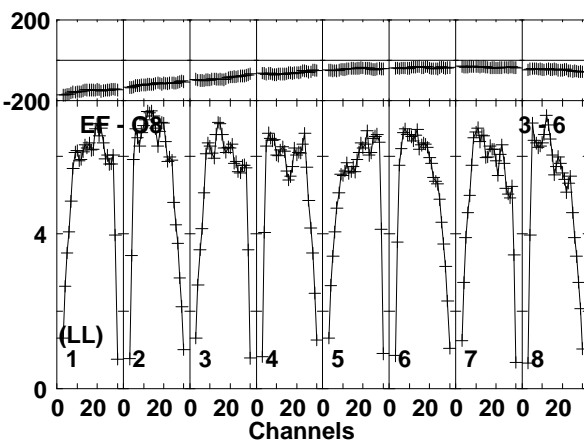
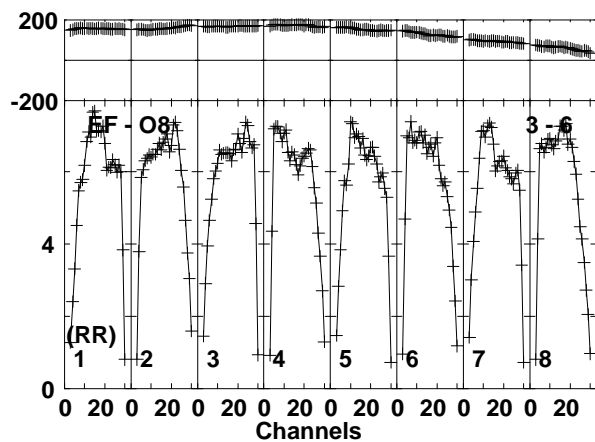
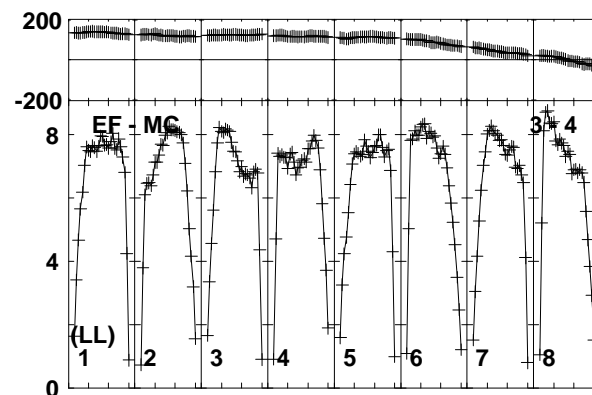
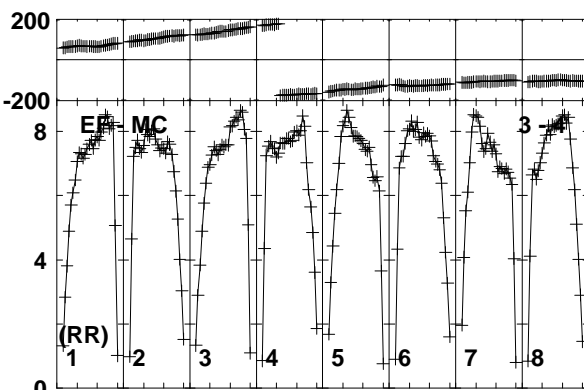
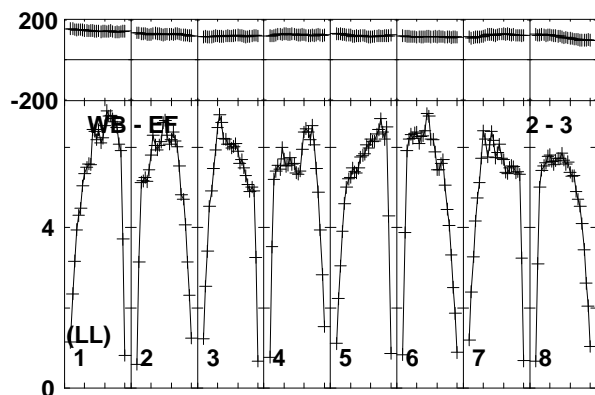
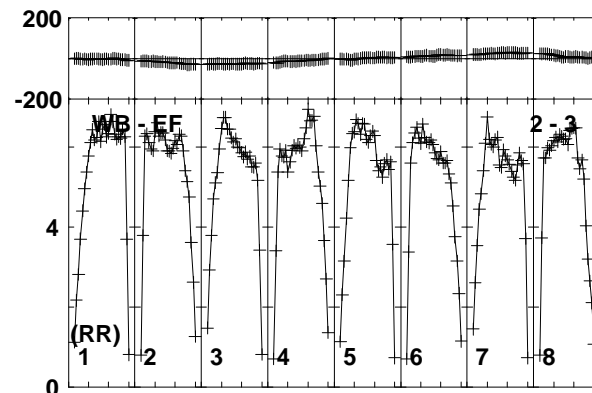
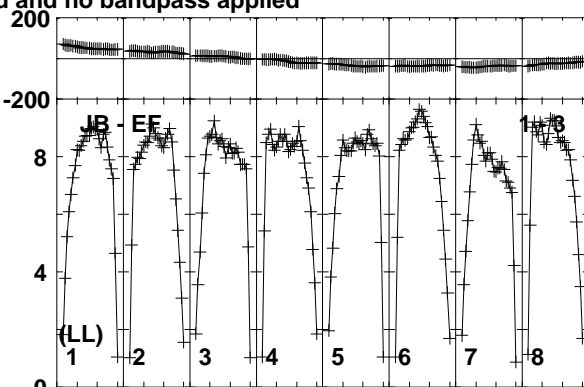
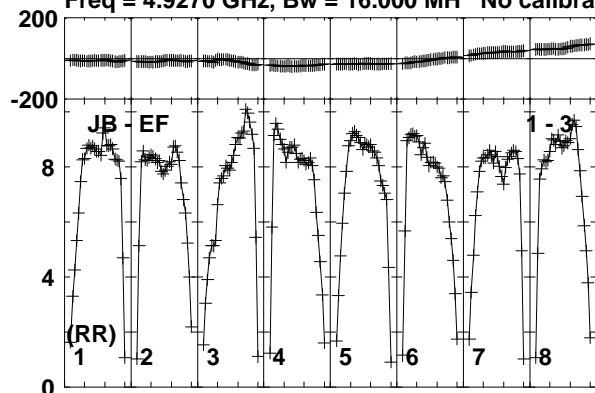

Lower frame: Milli Ampl Jy Top frame: Phas deg  
Vector averaged cross-power spectrum Baseline: JB (01) - EF (03)  
Timerange: 00/15:09:01 to 00/15:09:59

Plot file version 695 created 19-DEC-2018 17:59:01

J1619+2247 RY007C.UVDATA.1

Freq = 4.9270 GHz, Bw = 16.000 MH No calibration applied and no bandpass applied

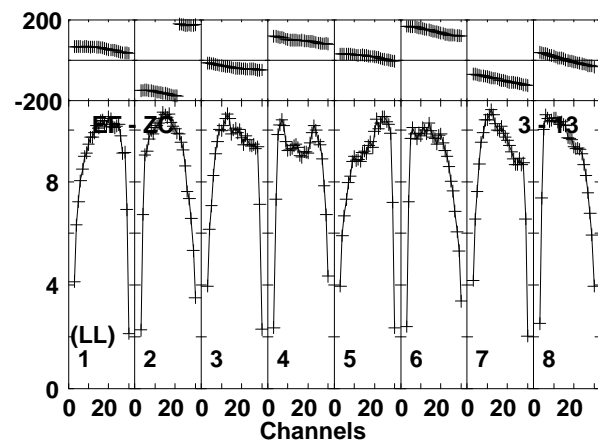
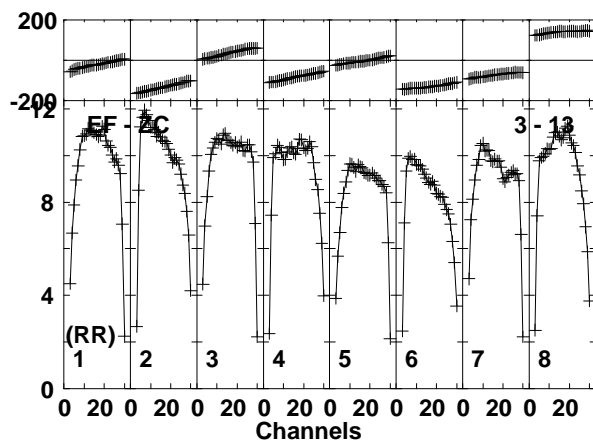
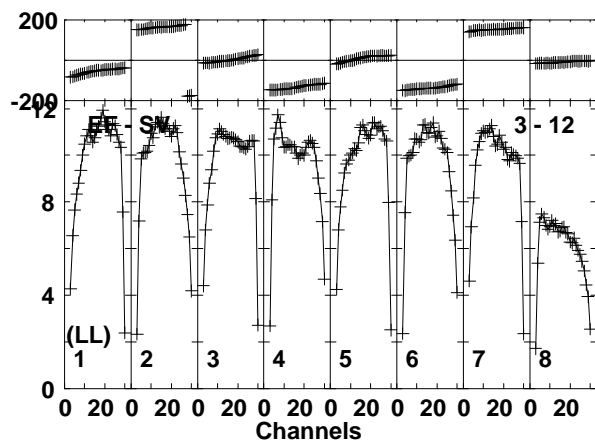
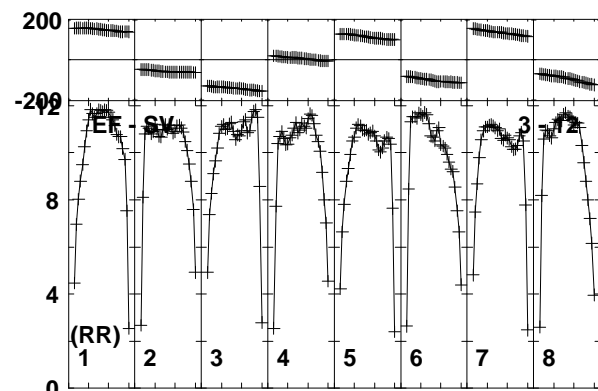
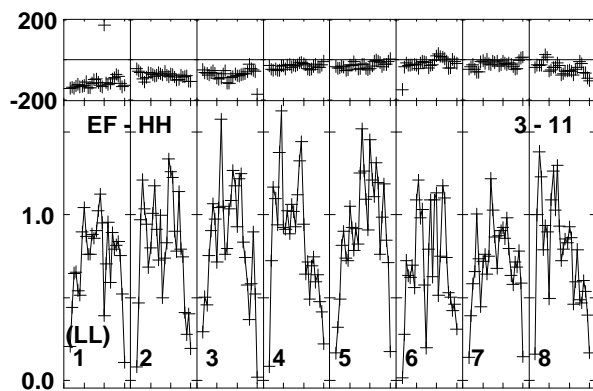
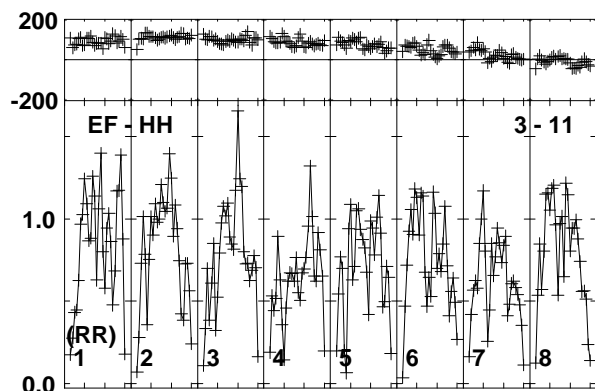
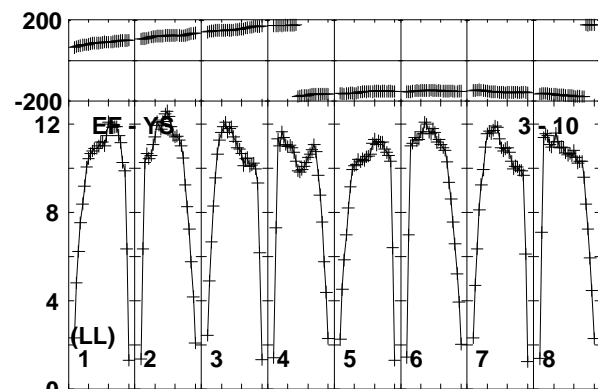
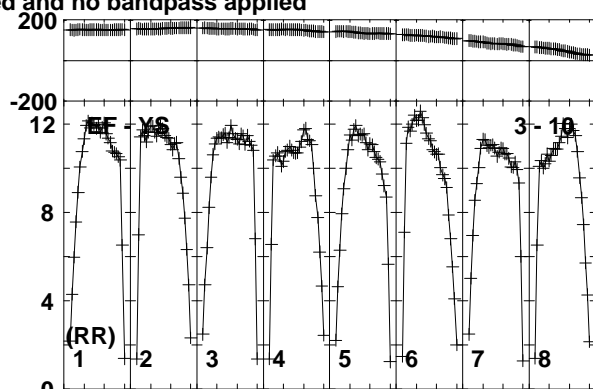
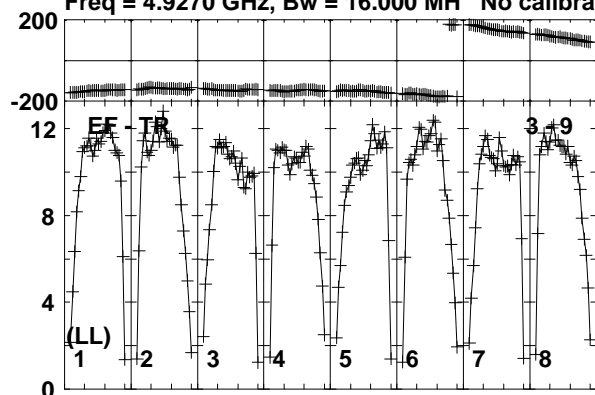

Lower frame: Milli Ampl Jy Top frame: Phas deg  
Vector averaged cross-power spectrum Baseline: EF (03) - TR (09)  
Timerange: 00/15:09:01 to 00/15:09:59

Plot file version 696 created 19-DEC-2018 17:59:01  
J1619+2247 RY007C.UVDATA.1

Freq = 4.9270 GHz, Bw = 16.000 MH No calibration applied and no bandpass applied

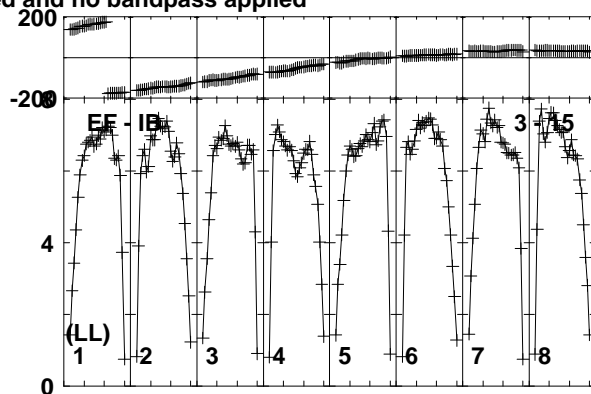
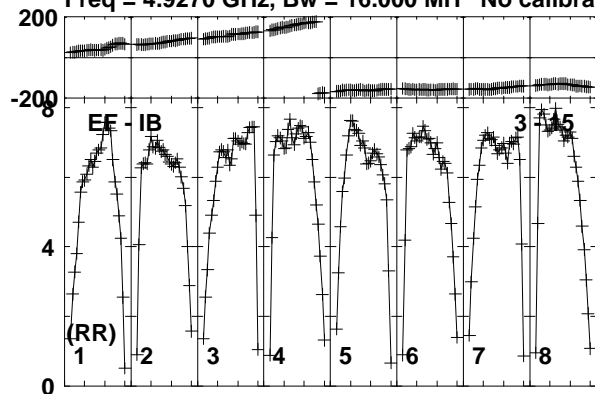

Lower frame: Milli Ampl Jy Top frame: Phas deg  
Vector averaged cross-power spectrum Baseline: EF (03) - IB (15)  
Timerange: 00/15:09:01 to 00/15:09:59

Plot file version 697 created 19-DEC-2018 17:59:01  
AT2018\_RY007C.UVDATA.1

Freq = 4.9270 GHz, Bw = 16.000 MH No calibration applied and no bandpass applied

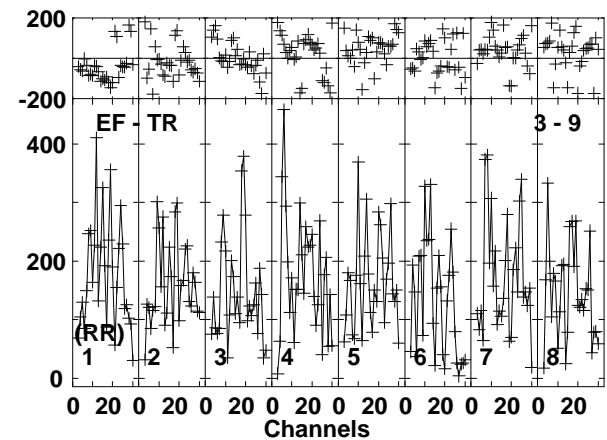
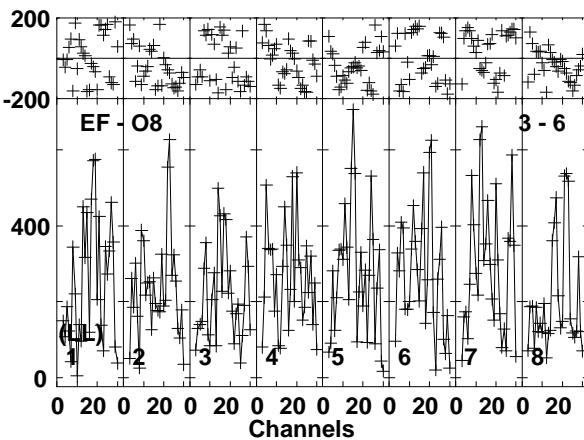
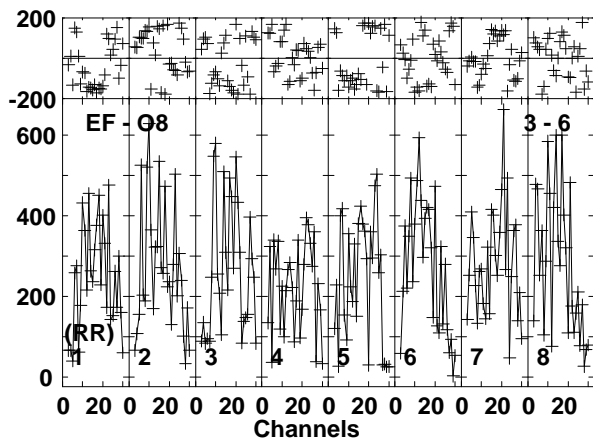
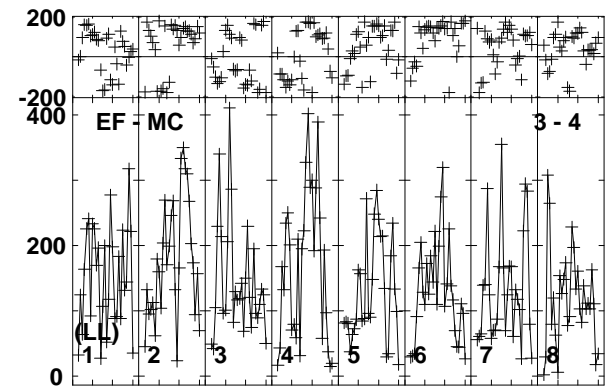
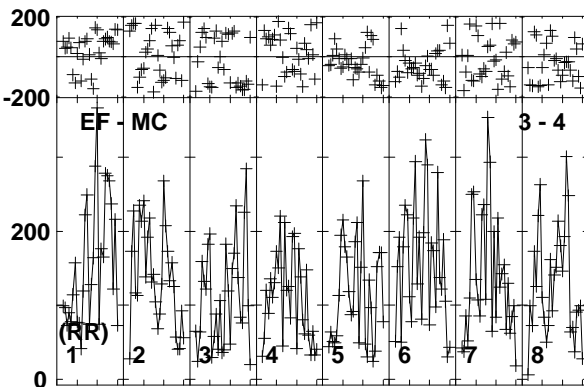
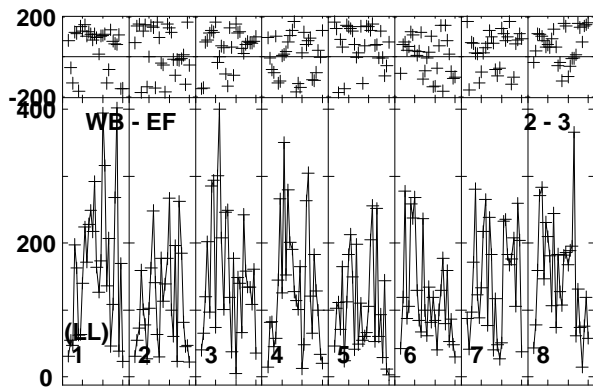
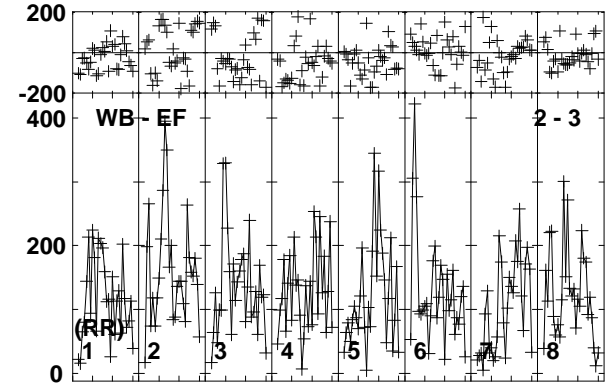
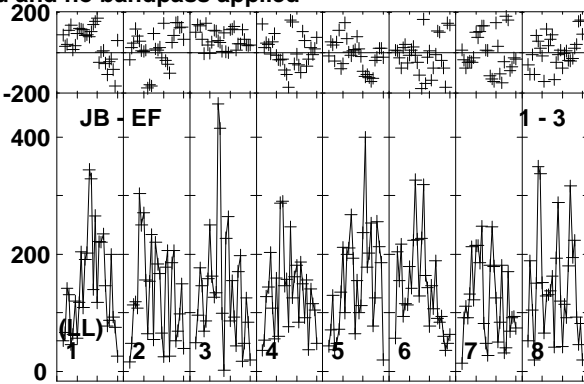
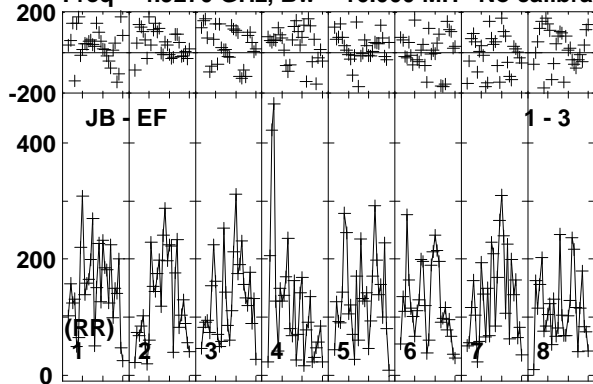

Lower frame: Micro Ampl Jy Top frame: Phas deg  
Vector averaged cross-power spectrum Baseline: JB (01) - EF (03)  
Timerange: 00/15:10:01 to 00/15:11:59

Plot file version 698 created 19-DEC-2018 17:59:01

AT2018\_RY007C.UVDATA.1

Freq = 4.9270 GHz, Bw = 16.000 MH No calibration applied and no bandpass applied

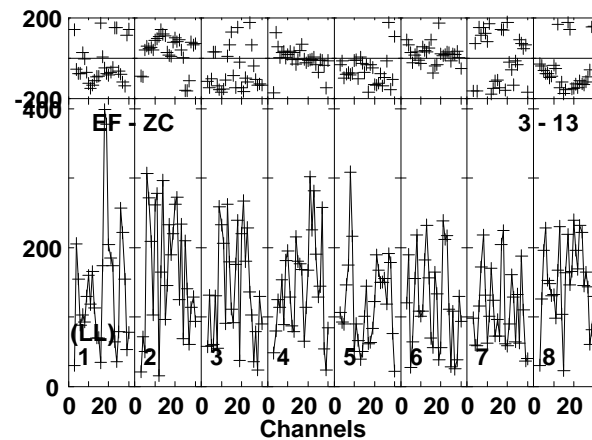
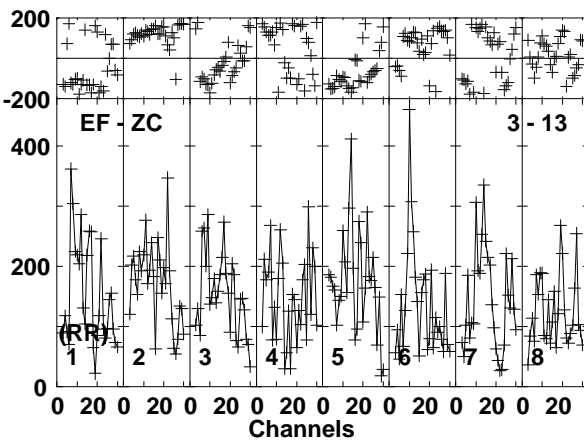
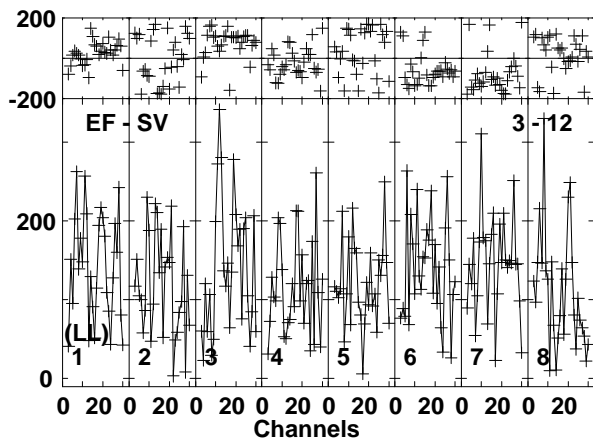
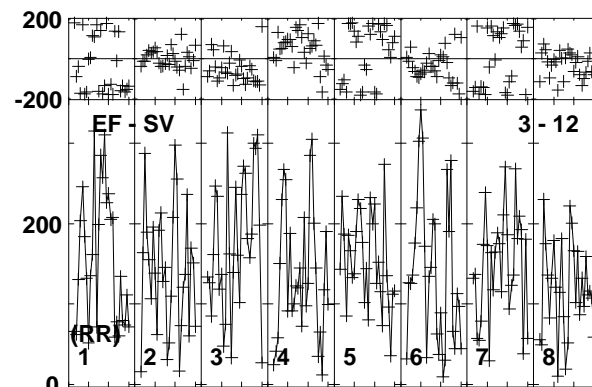
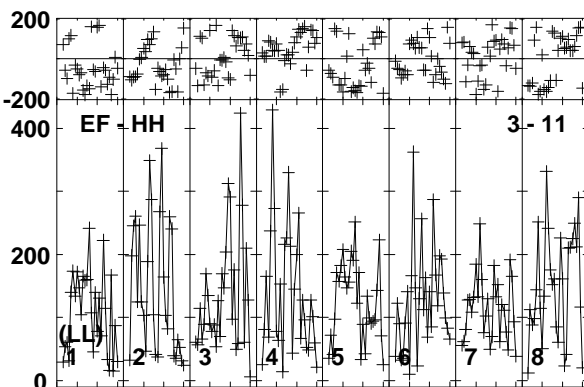
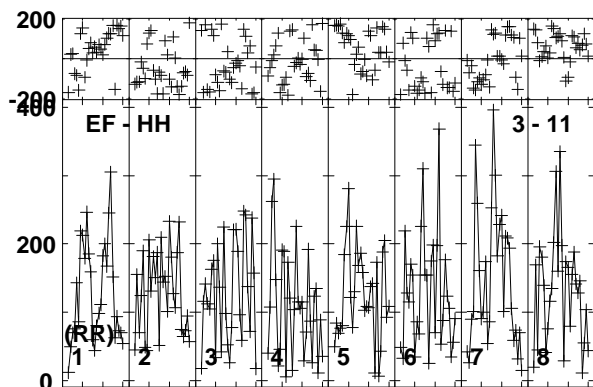
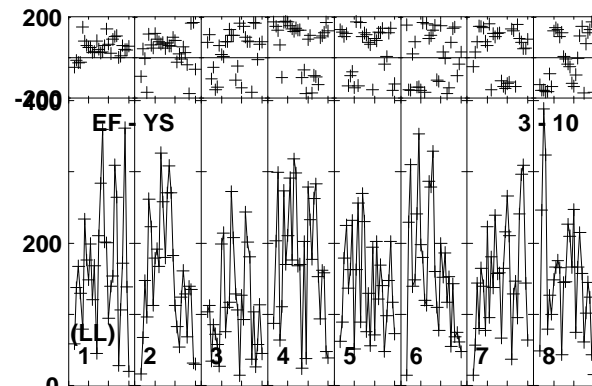
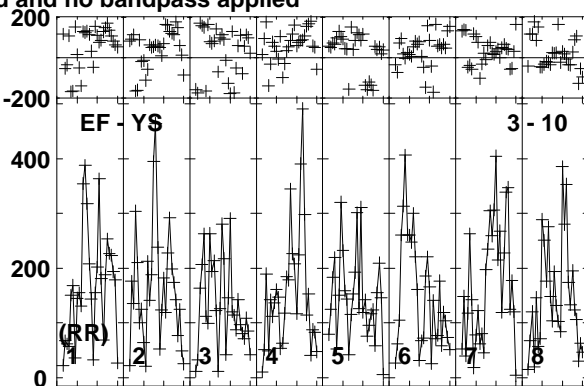
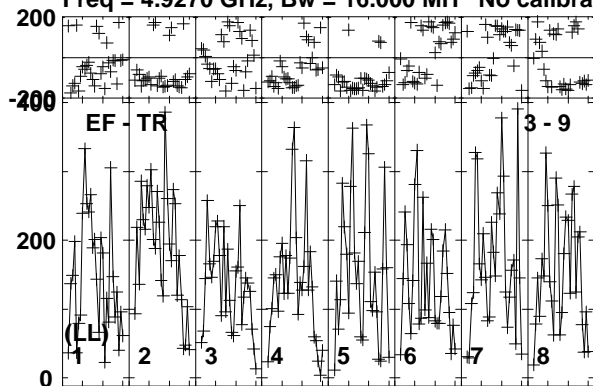

Lower frame: Micro Ampl Jy Top frame: Phas deg  
Vector averaged cross-power spectrum Baseline: EF (03) - TR (09)  
Timerange: 00/15:10:01 to 00/15:11:59



Plot file version 699 created 19-DEC-2018 17:59:01

AT2018\_RY007C.UVDATA.1

Freq = 4.9270 GHz, Bw = 16.000 MH No calibration applied and no bandpass applied

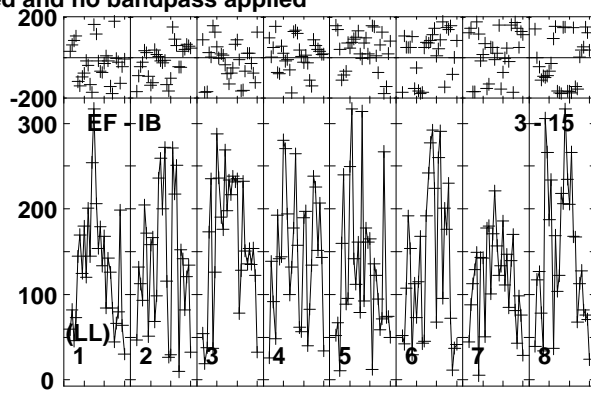
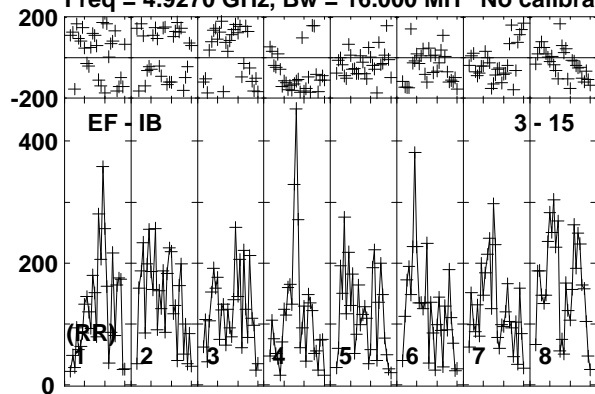

Lower frame: Micro Ampl Jy Top frame: Phas deg  
Vector averaged cross-power spectrum Baseline: EF (03) - IB (15)  
Timerange: 00/15:10:01 to 00/15:11:59

Plot file version 700 created 19-DEC-2018 17:59:01

VLA2 RY007C.UVDATA.1

Freq = 4.9270 GHz, Bw = 16.000 MH No calibration applied and no bandpass applied

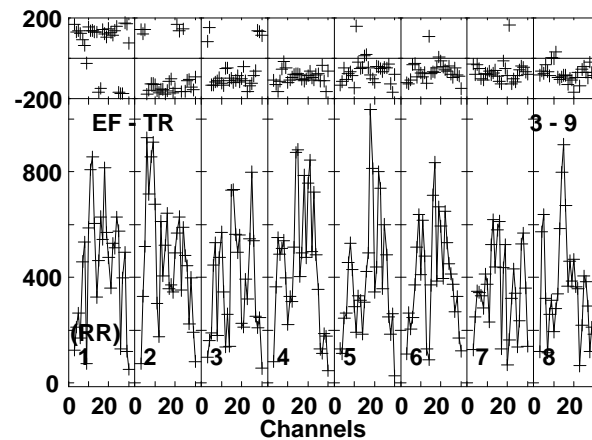
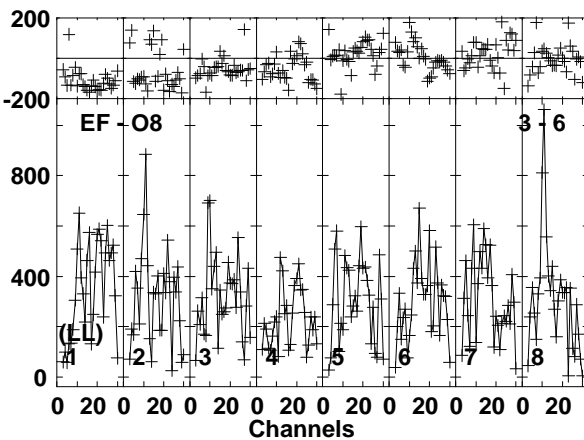
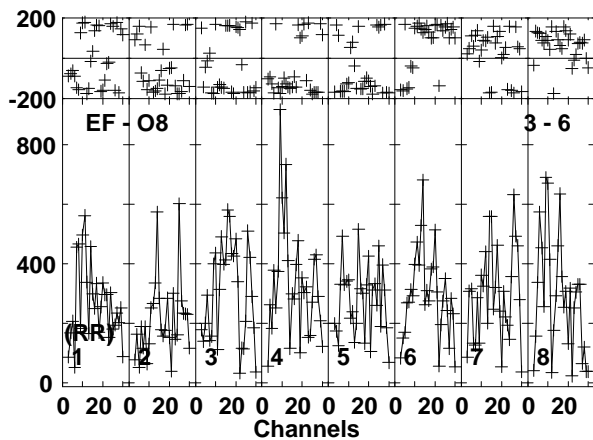
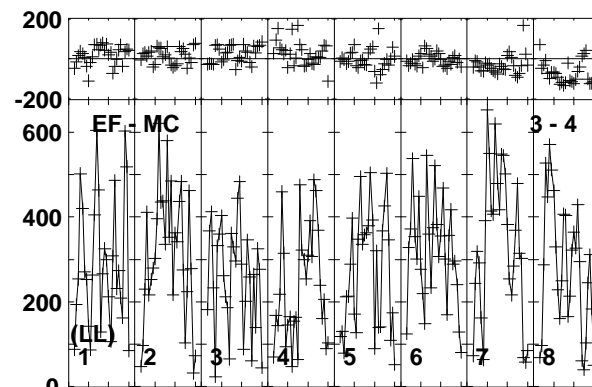
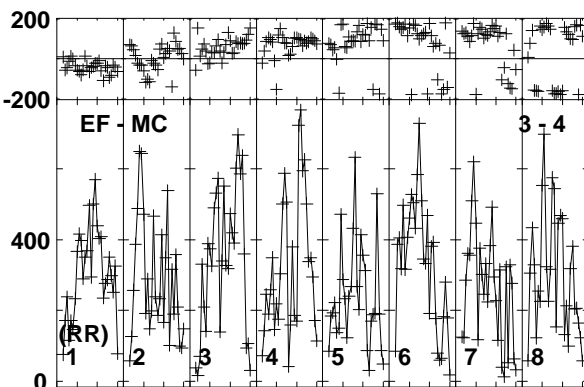
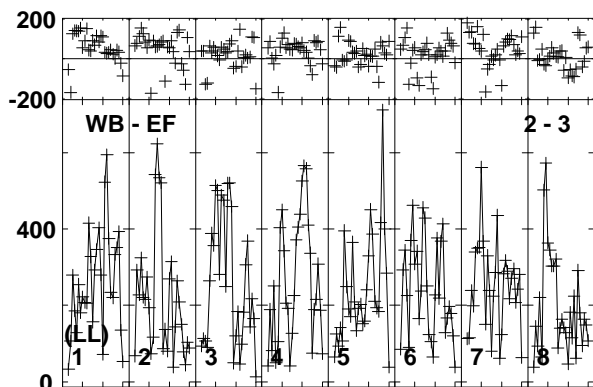
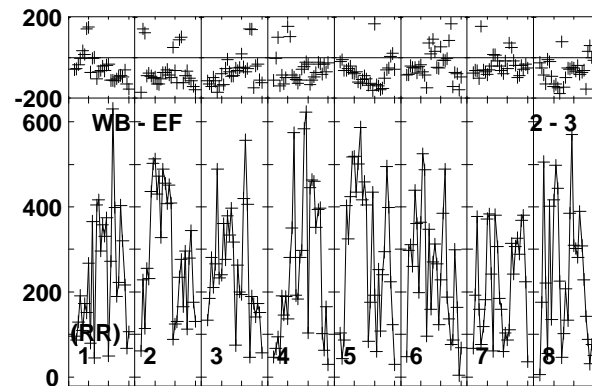
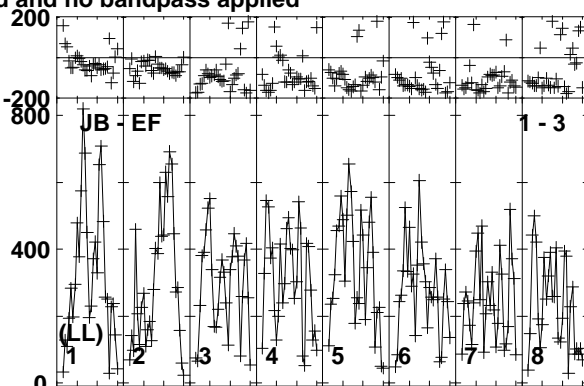
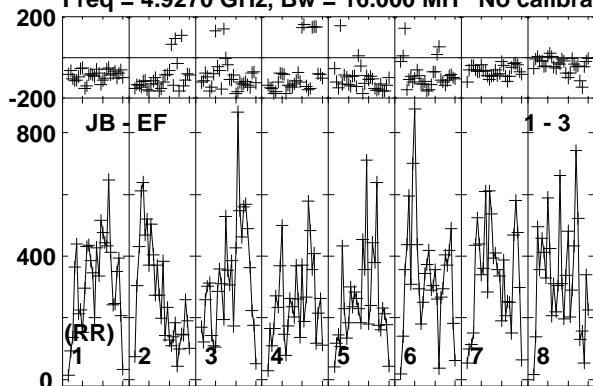

Lower frame: Micro Ampl Jy Top frame: Phas deg  
Vector averaged cross-power spectrum Baseline: JB (01) - EF (03)  
Timerange: 00/15:12:01 to 00/15:12:59

Plot file version 701 created 19-DEC-2018 17:59:01

VLA2 RY007C.UVDATA.1

Freq = 4.9270 GHz, Bw = 16.000 MH No calibration applied and no bandpass applied

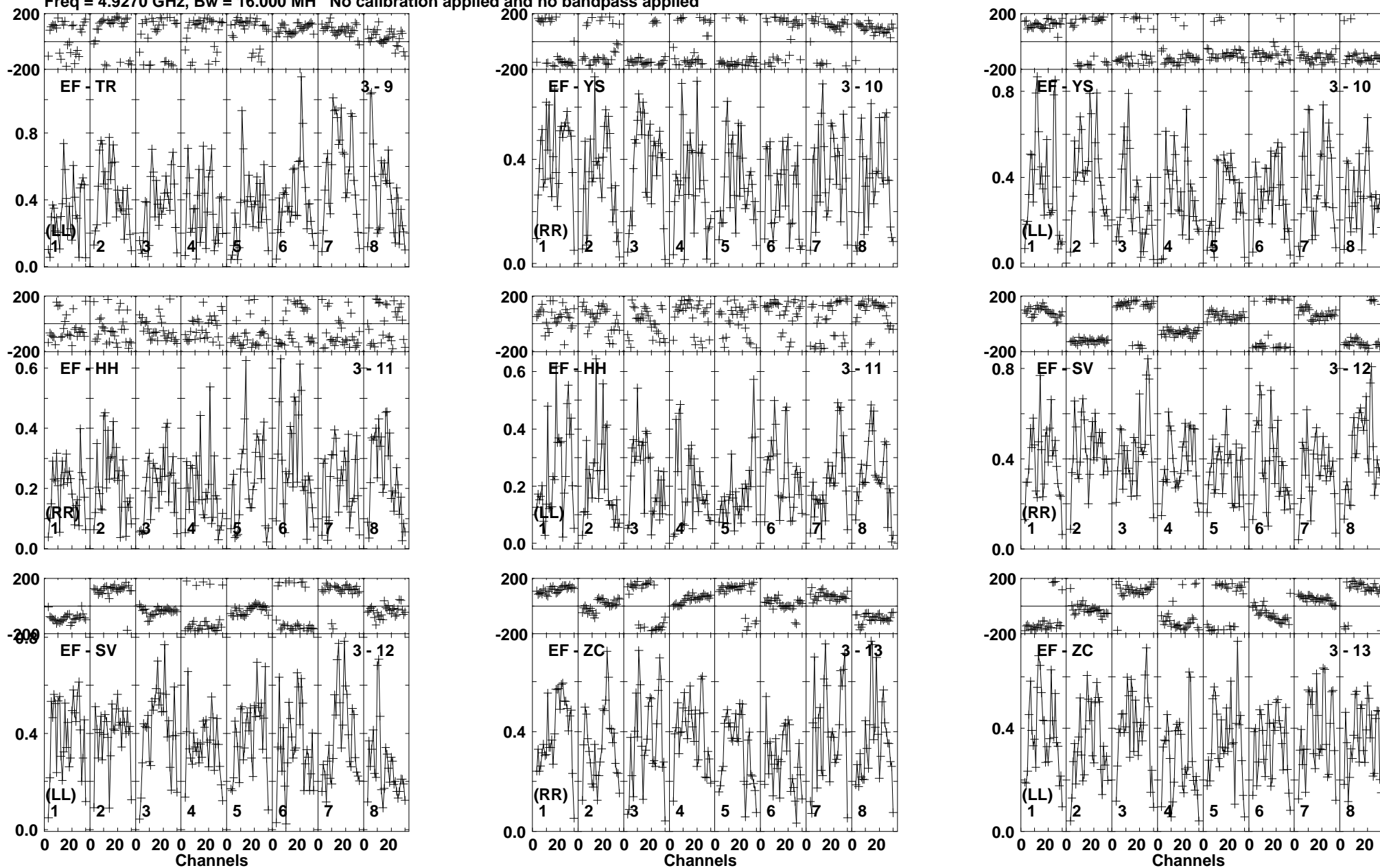

Lower frame: Milli Ampl Jy Top frame: Phas deg  
Vector averaged cross-power spectrum Baseline: EF (03) - TR (09)  
Timerange: 00/15:12:01 to 00/15:12:59

Plot file version 702 created 19-DEC-2018 17:59:01

VLA2 RY007C.UVDATA.1

Freq = 4.9270 GHz, Bw = 16.000 MH No calibration applied and no bandpass applied

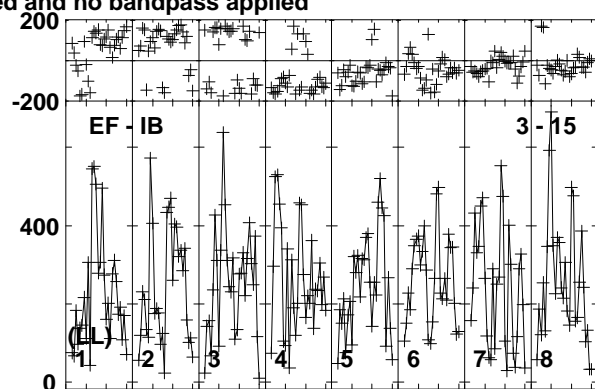
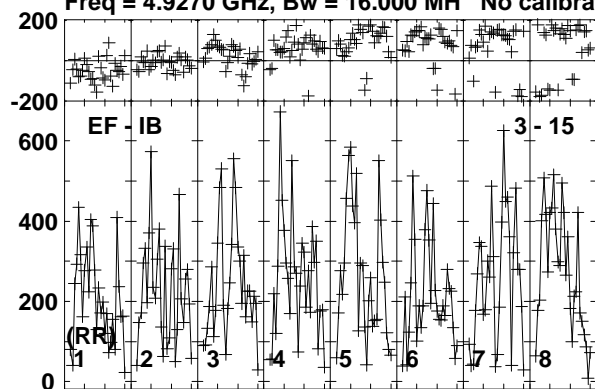

Lower frame: Micro Ampl Jy Top frame: Phas deg  
Vector averaged cross-power spectrum Baseline: EF (03) - IB (15)  
Timerange: 00/15:12:01 to 00/15:12:59

Plot file version 703 created 19-DEC-2018 17:59:01

J1619+2247 RY007C.UVDATA.1

Freq = 4.9270 GHz, Bw = 16.000 MH No calibration applied and no bandpass applied

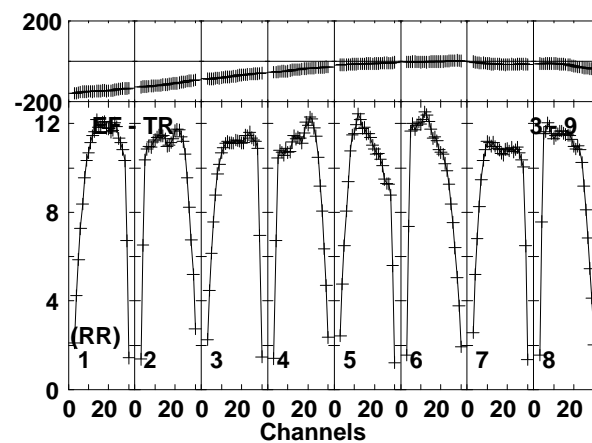
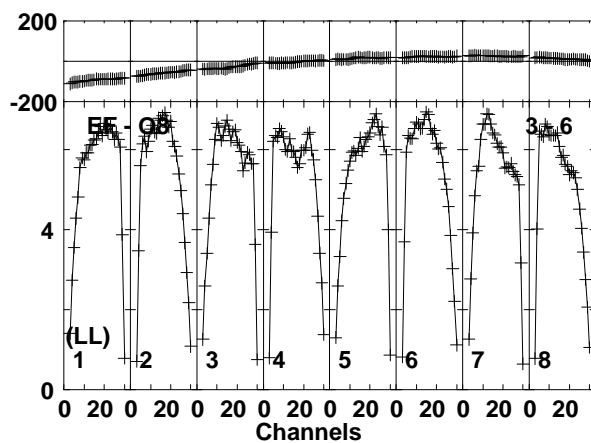
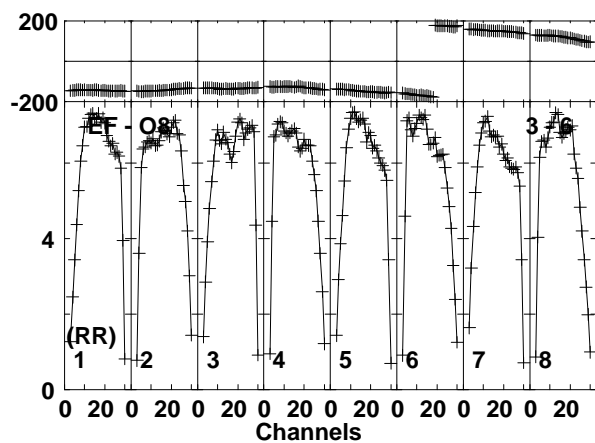
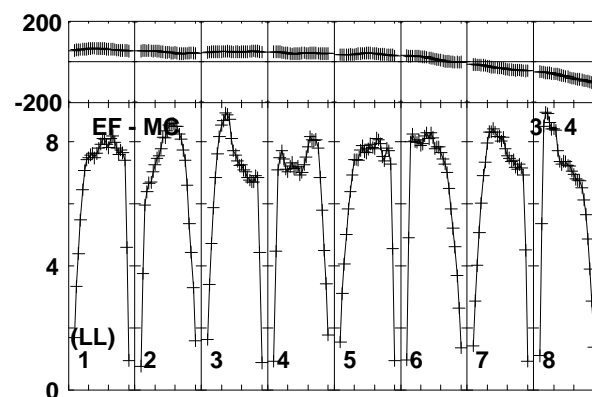
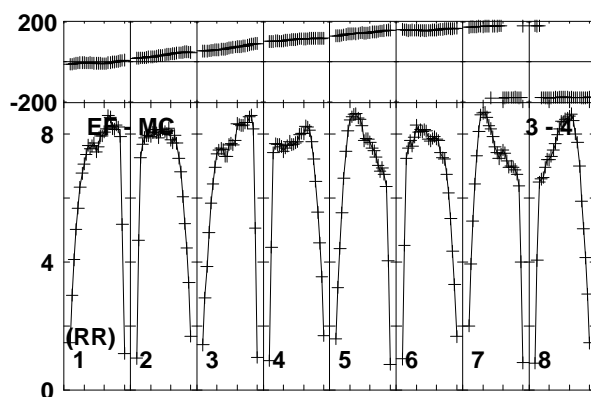
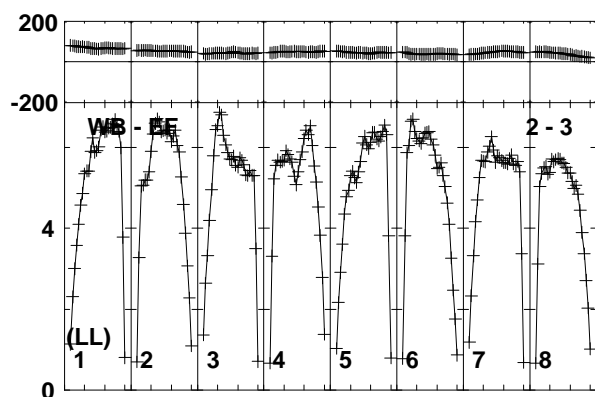
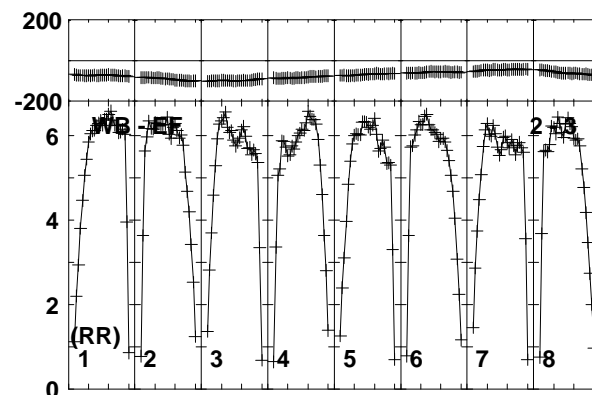
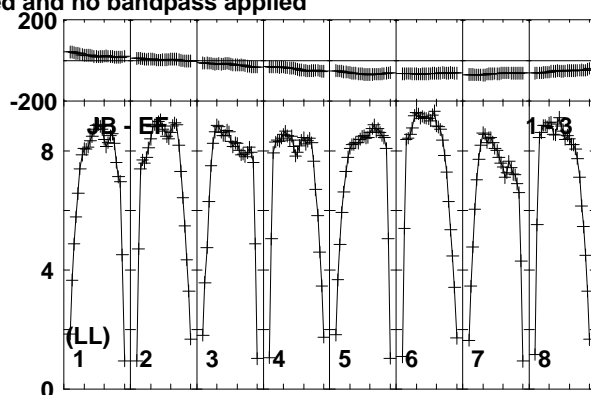
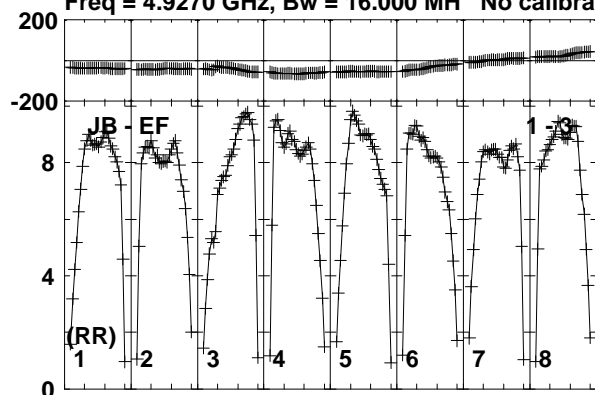

Lower frame: Milli Ampl Jy Top frame: Phas deg  
Vector averaged cross-power spectrum Baseline: JB (01) - EF (03)  
Timerange: 00/15:13:31 to 00/15:14:29

Plot file version 704 created 19-DEC-2018 17:59:01

J1619+2247 RY007C.UVDATA.1

Freq = 4.9270 GHz, Bw = 16.000 MH No calibration applied and no bandpass applied

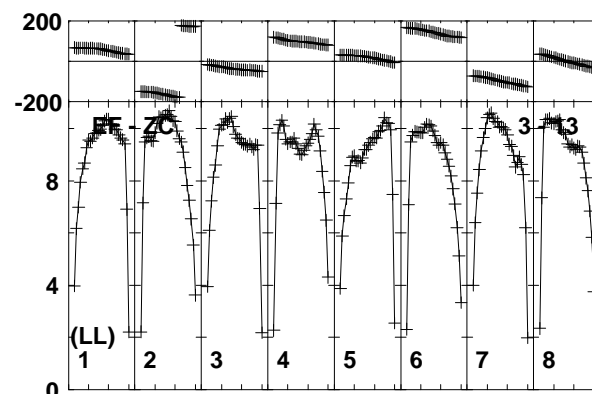
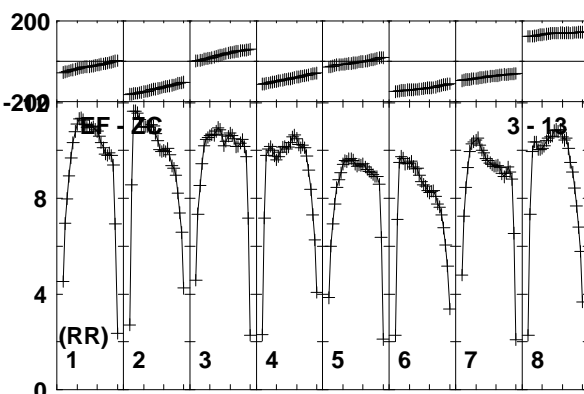
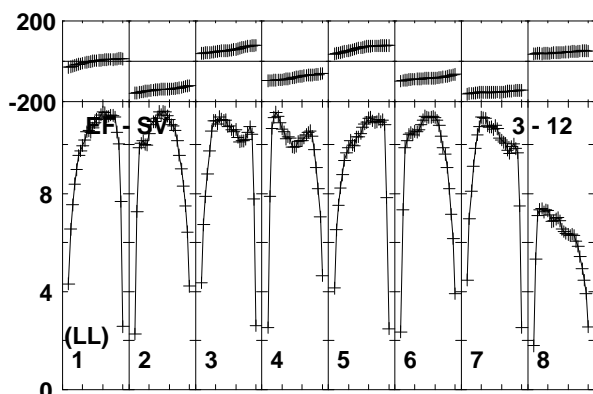
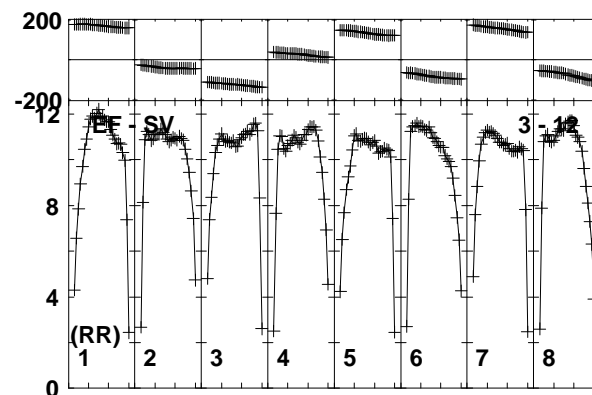
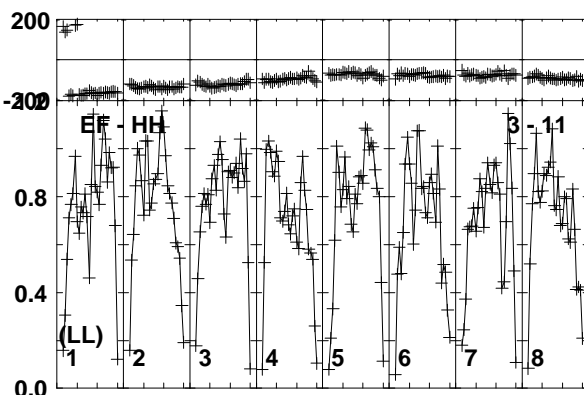
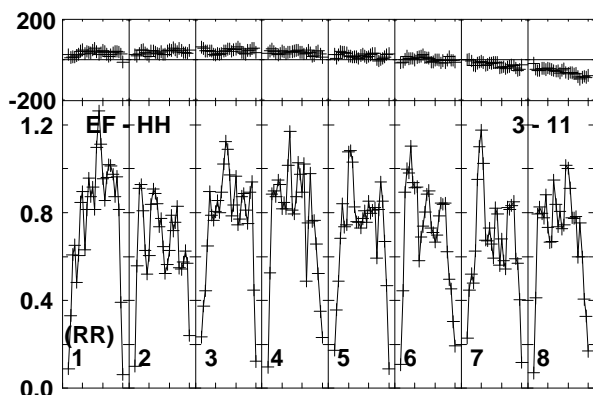
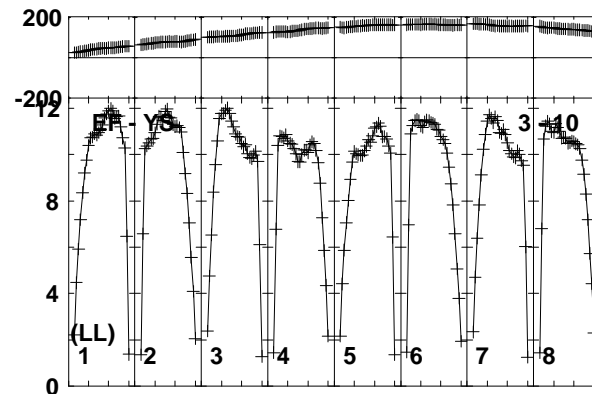
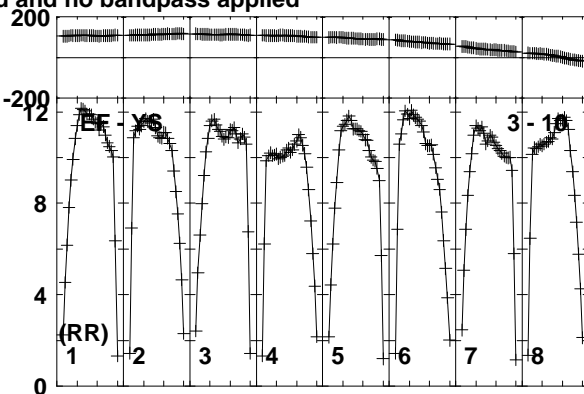
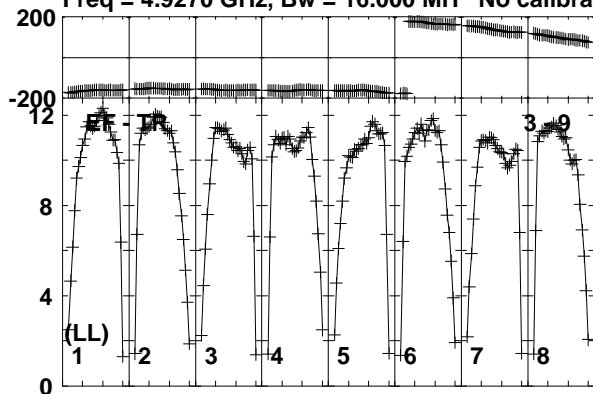

Lower frame: Milli Ampl Jy Top frame: Phas deg  
Vector averaged cross-power spectrum Baseline: EF (03) - TR (09)  
Timerange: 00/15:13:31 to 00/15:14:29

Plot file version 705 created 19-DEC-2018 17:59:01  
J1619+2247 RY007C.UVDATA.1

Freq = 4.9270 GHz, Bw = 16.000 MH No calibration applied and no bandpass applied

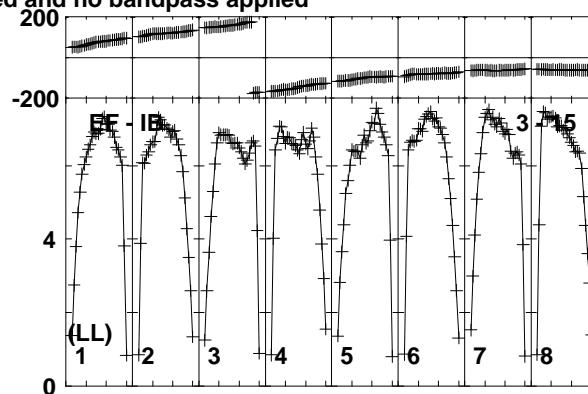
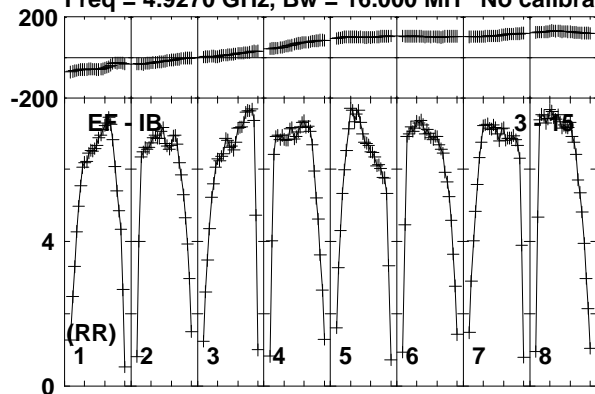

Lower frame: Milli Ampl Jy Top frame: Phas deg  
Vector averaged cross-power spectrum Baseline: EF (03) - IB (15)  
Timerange: 00/15:13:31 to 00/15:14:29

Plot file version 706 created 19-DEC-2018 17:59:01

AT2018\_RY007C.UVDATA.1

Freq = 4.9270 GHz, Bw = 16.000 MH No calibration applied and no bandpass applied

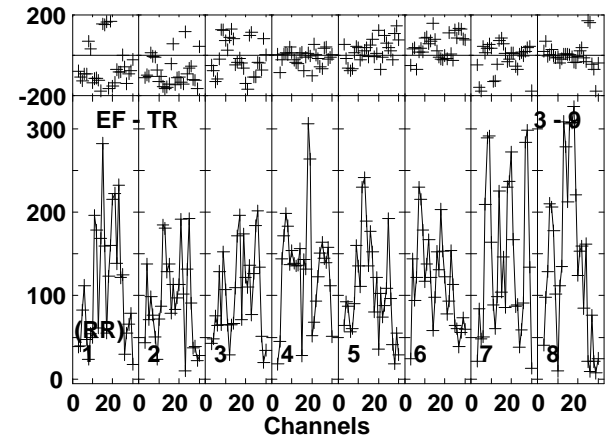
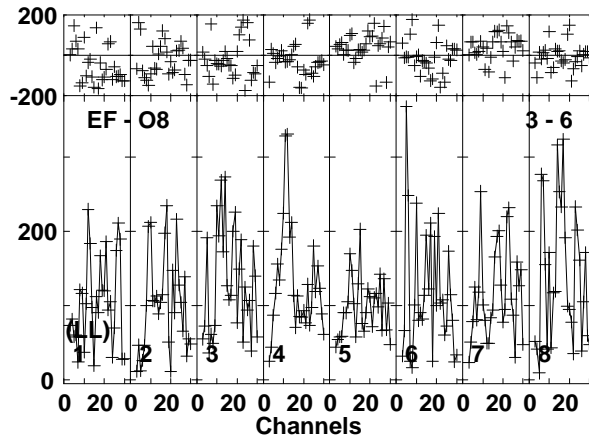
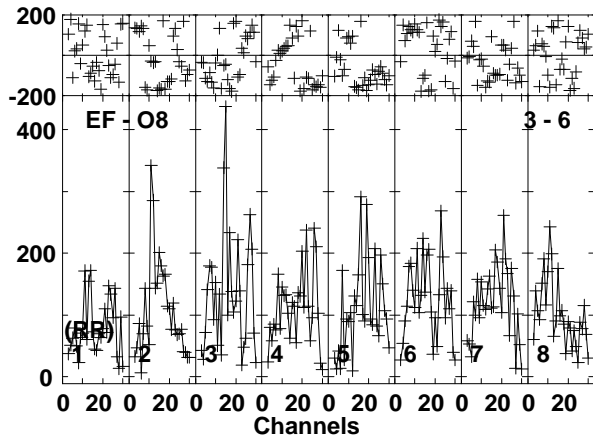
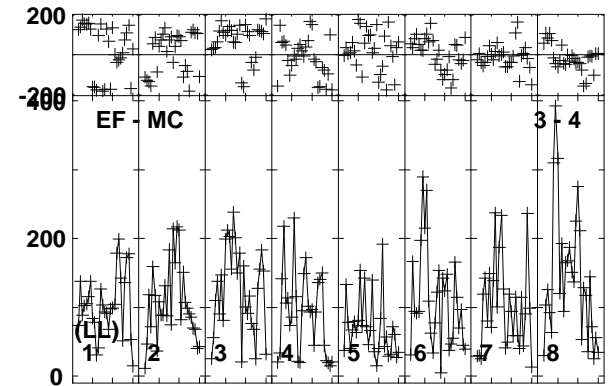
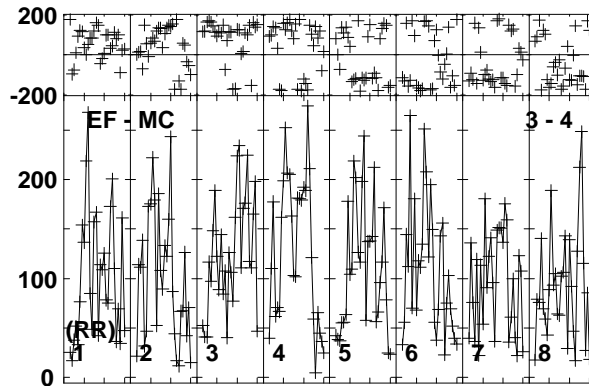
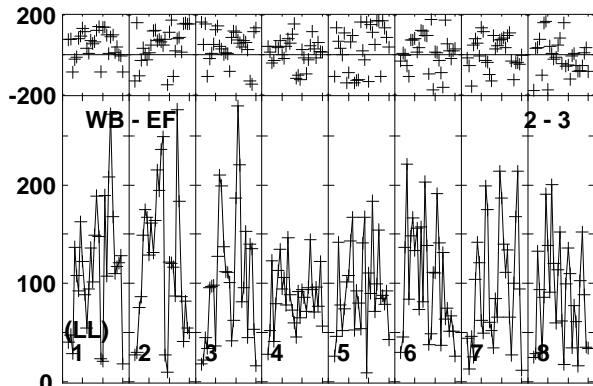
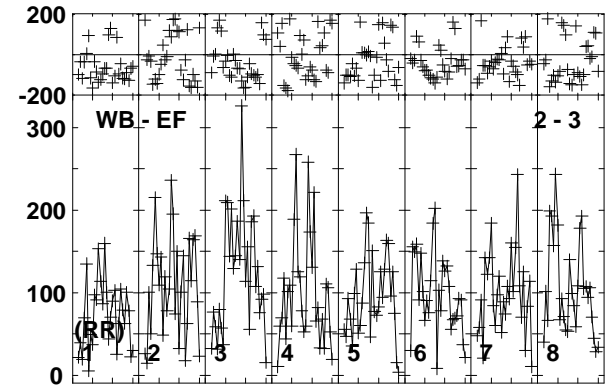
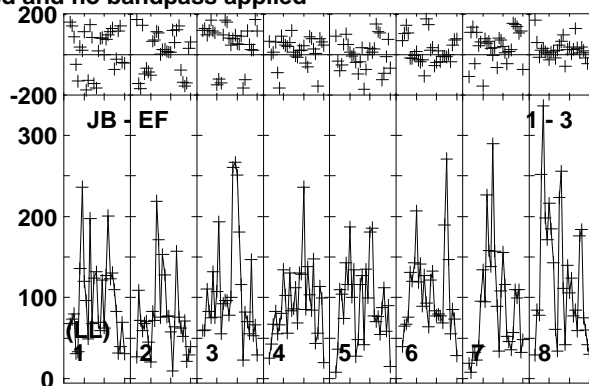
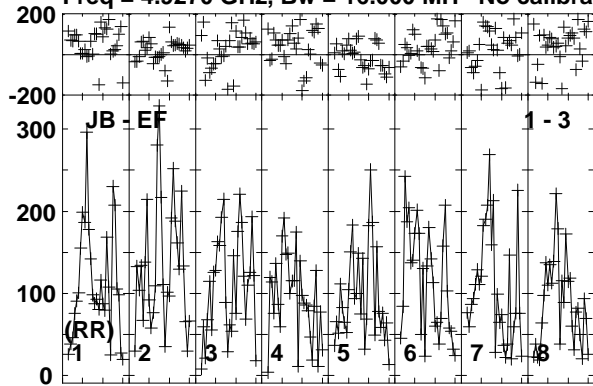

Lower frame: Micro Ampl Jy Top frame: Phas deg  
Vector averaged cross-power spectrum Baseline: JB (01) - EF (03)  
Timerange: 00/15:14:31 to 00/15:17:29



Plot file version 707 created 19-DEC-2018 17:59:01  
AT2018\_RY007C.UVDATA.1

Freq = 4.9270 GHz, Bw = 16.000 MH No calibration applied and no bandpass applied

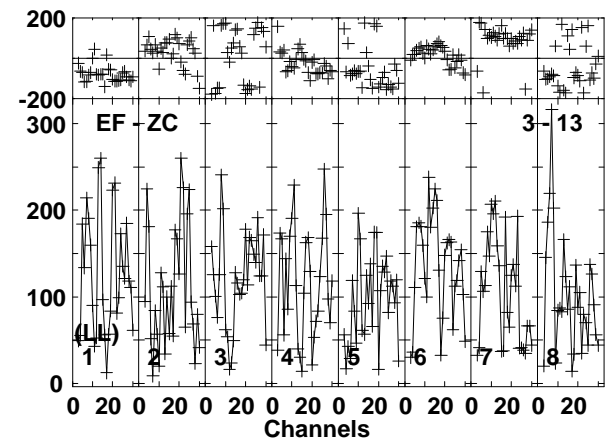
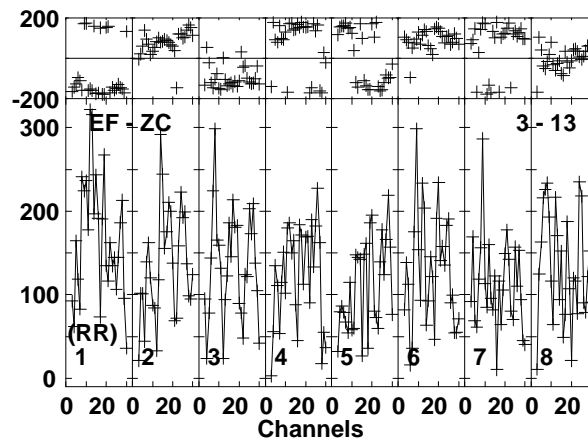
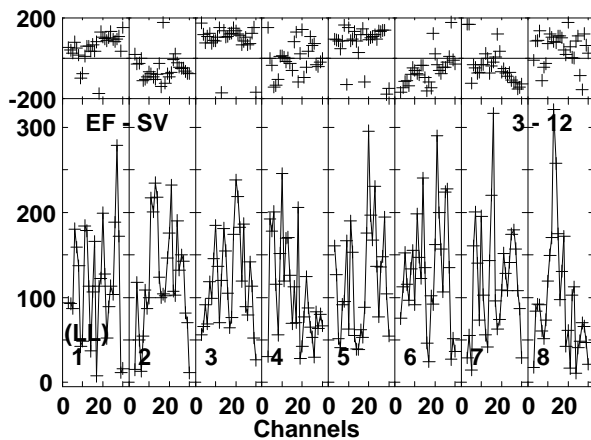
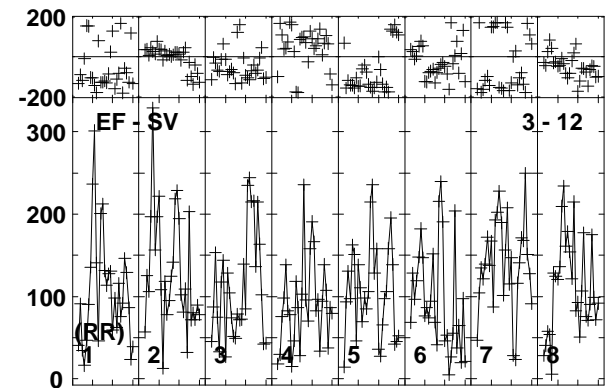
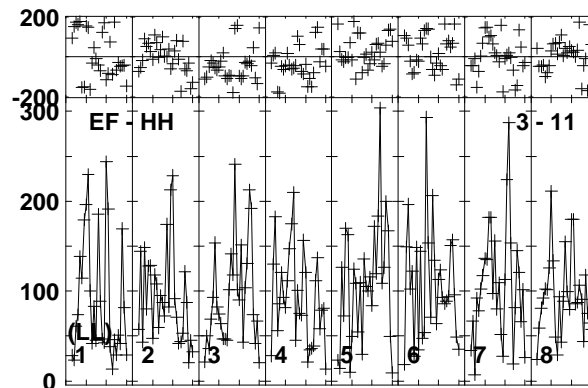
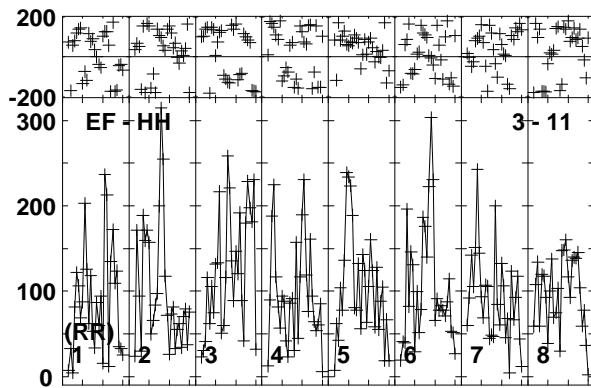
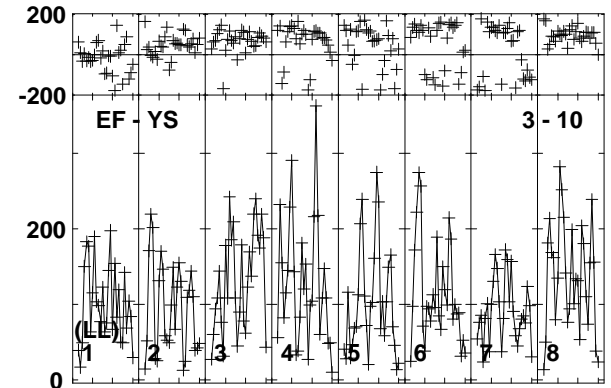
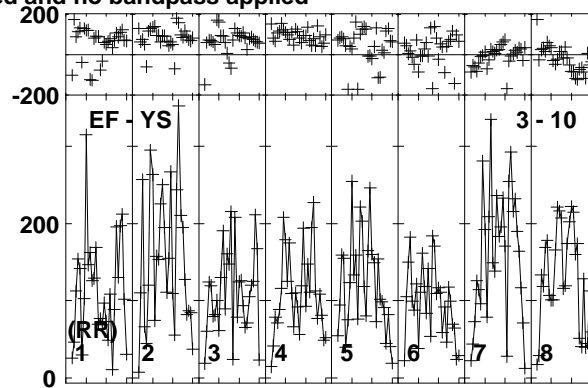
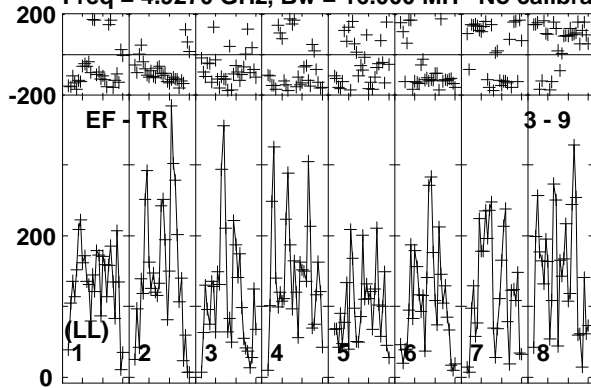

Lower frame: Micro Ampl Jy Top frame: Phas deg  
Vector averaged cross-power spectrum Baseline: EF (03) - TR (09)  
Timerange: 00/15:14:31 to 00/15:17:29

Plot file version 708 created 19-DEC-2018 17:59:01

AT2018\_RY007C.UVDATA.1

Freq = 4.9270 GHz, Bw = 16.000 MH No calibration applied and no bandpass applied

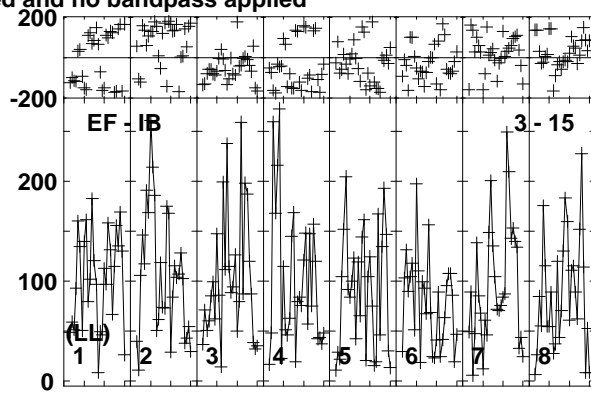
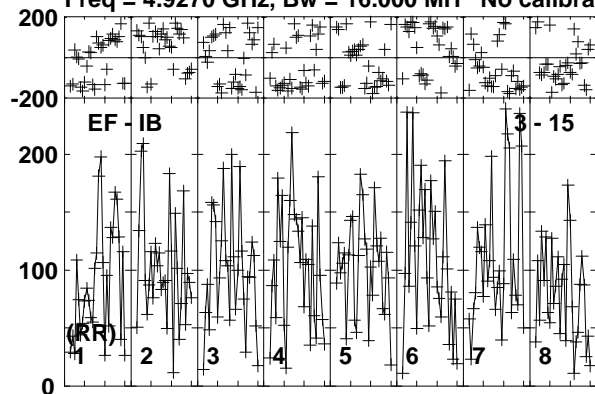

Lower frame: Micro Ampl Jy Top frame: Phas deg  
Vector averaged cross-power spectrum Baseline: EF (03) - IB (15)  
Timerange: 00/15:14:31 to 00/15:17:29

Plot file version 709 created 19-DEC-2018 17:59:01

J1619+2247 RY007C.UVDATA.1

Freq = 4.9270 GHz, Bw = 16.000 MH No calibration applied and no bandpass applied

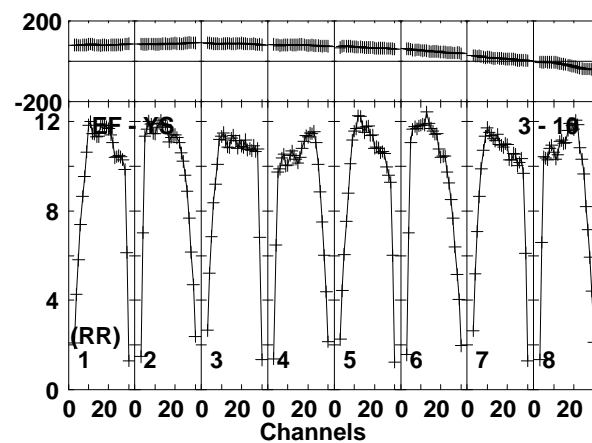
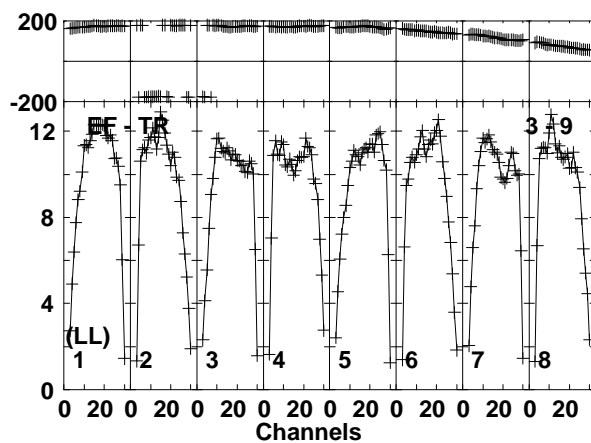
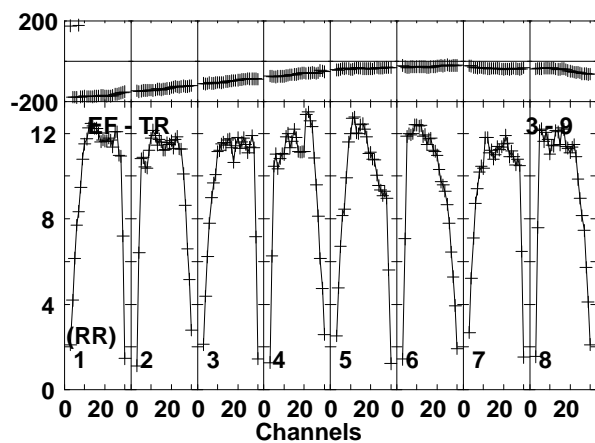
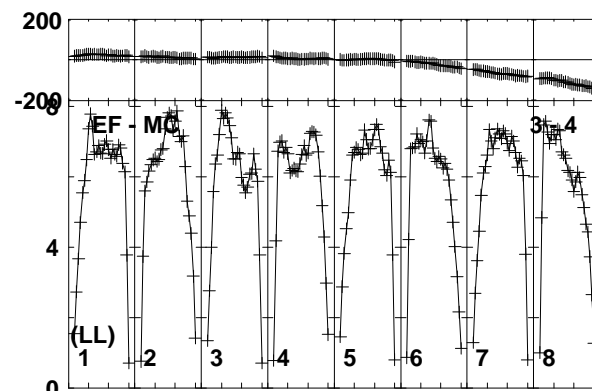
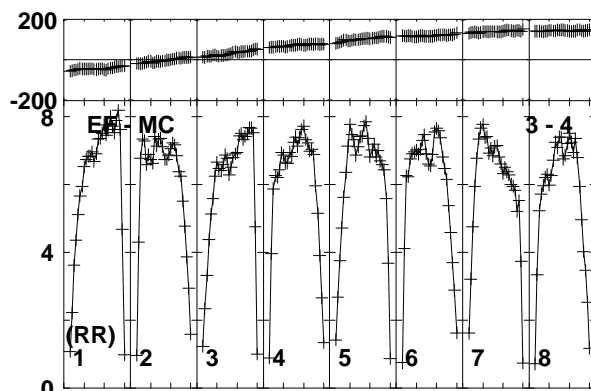
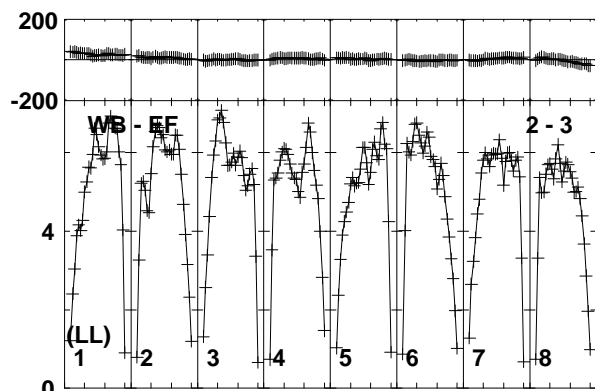
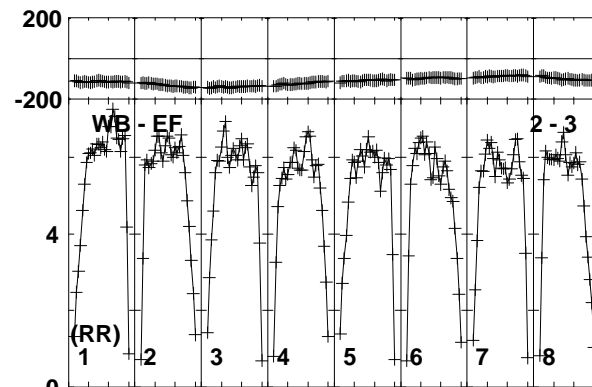
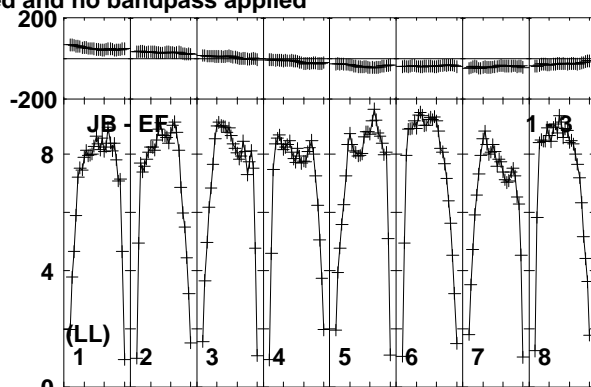
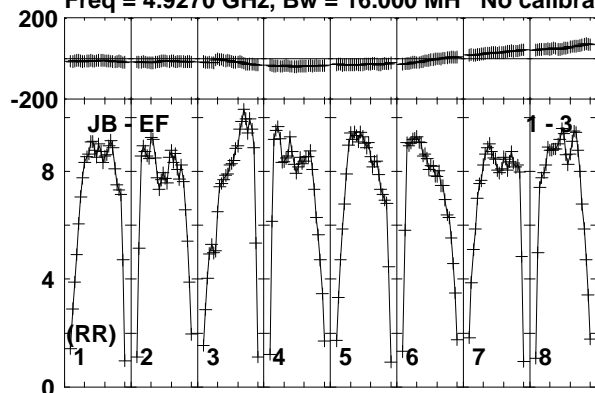

Lower frame: Milli Ampl Jy Top frame: Phas deg  
Vector averaged cross-power spectrum Baseline: JB (01) - EF (03)  
Timerange: 00/15:17:31 to 00/15:18:29

Plot file version 710 created 19-DEC-2018 17:59:01

J1619+2247 RY007C.UVDATA.1

Freq = 4.9270 GHz, Bw = 16.000 MH No calibration applied and no bandpass applied

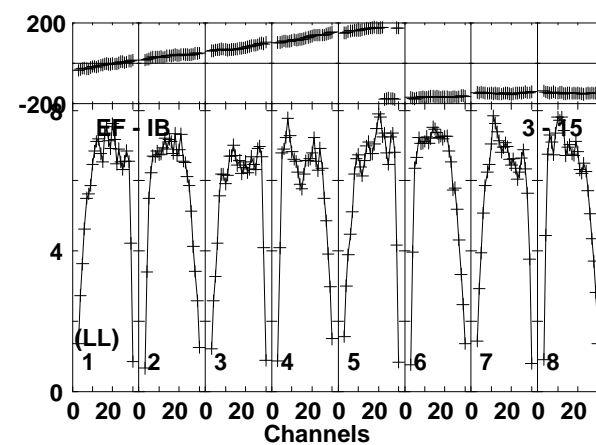
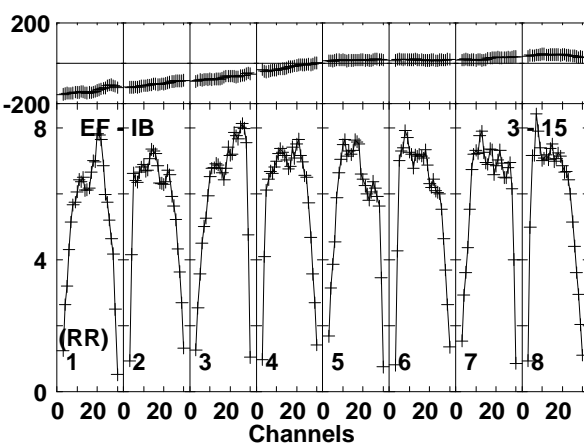
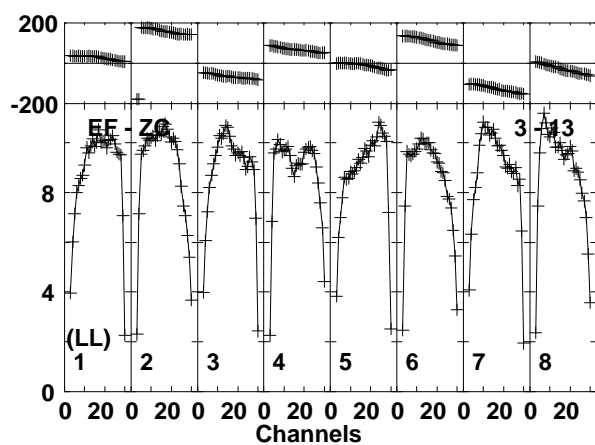
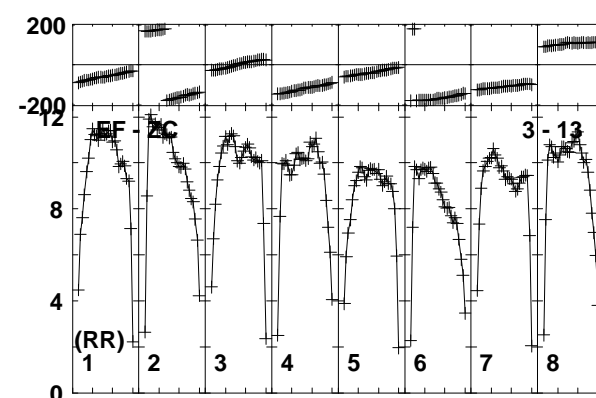
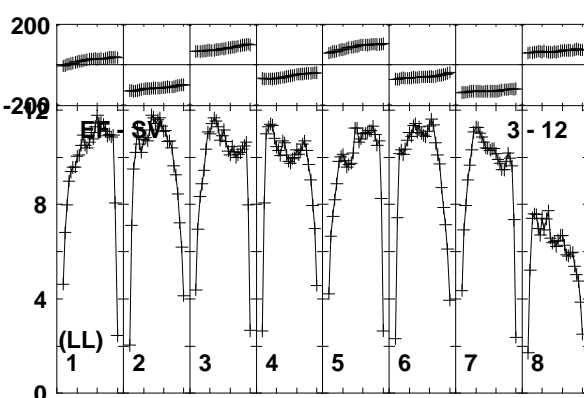
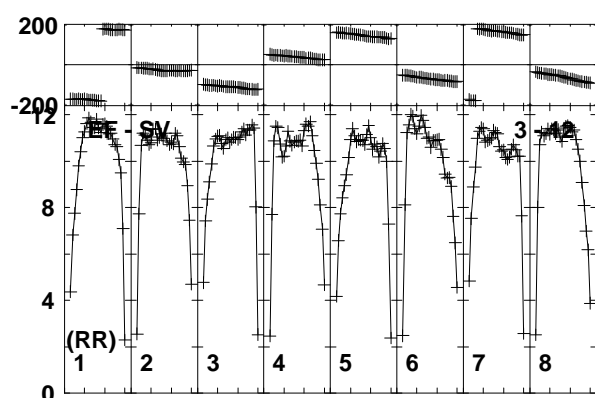
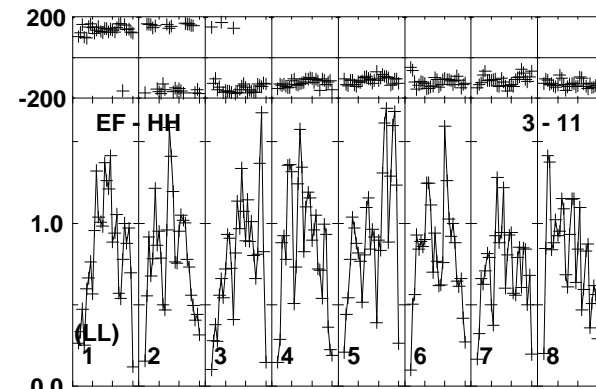
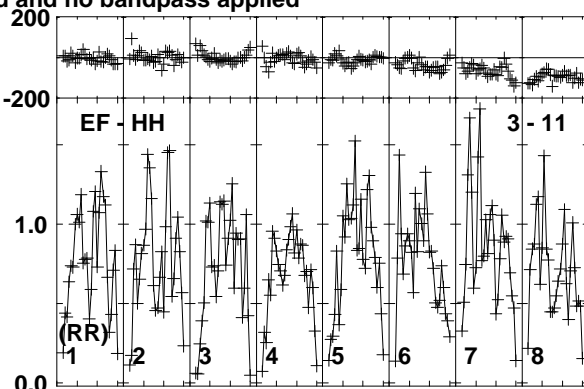
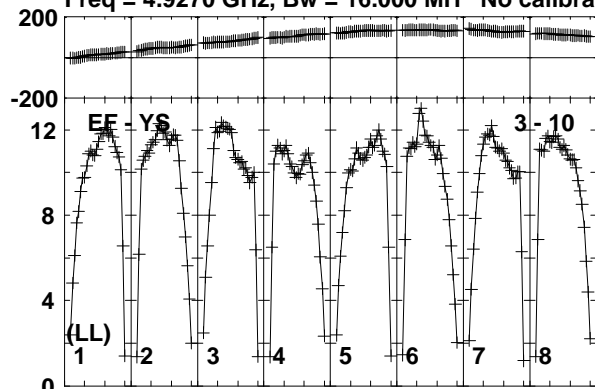

Lower frame: Milli Ampl Jy Top frame: Phas deg  
Vector averaged cross-power spectrum Baseline: EF (03) - YS (10)  
Timerange: 00/15:17:31 to 00/15:18:29

Plot file version 711 created 19-DEC-2018 17:59:01  
 AT2018\_RY007C.UVDATA.1

Freq = 4.9270 GHz, Bw = 16.000 MH No calibration applied and no bandpass applied

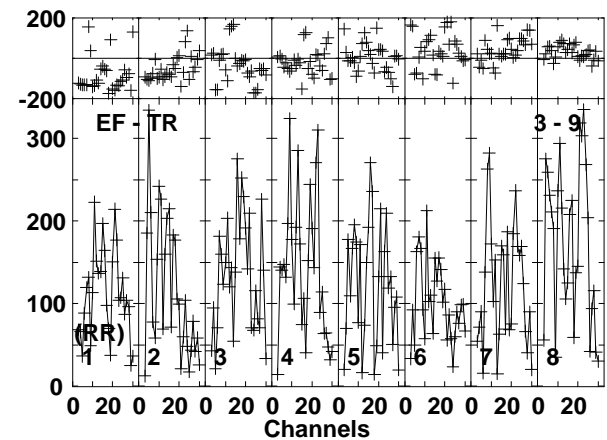
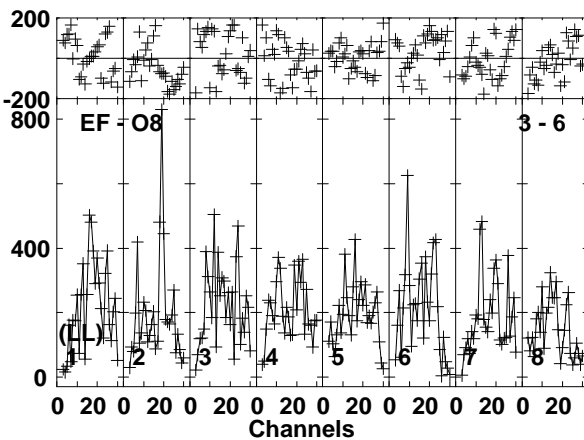
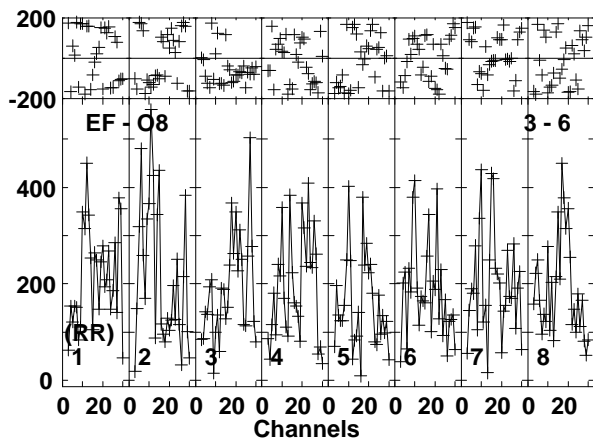
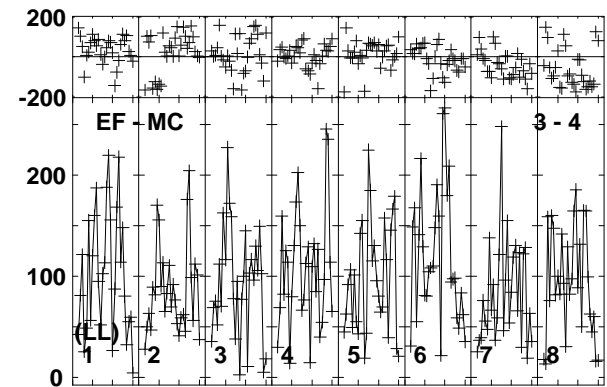
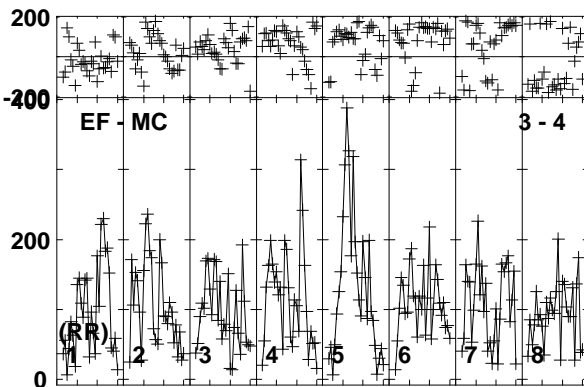
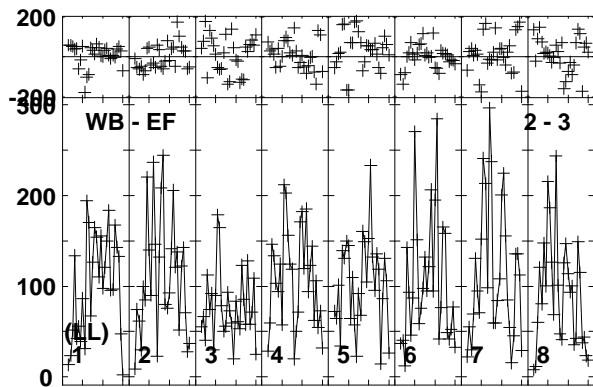
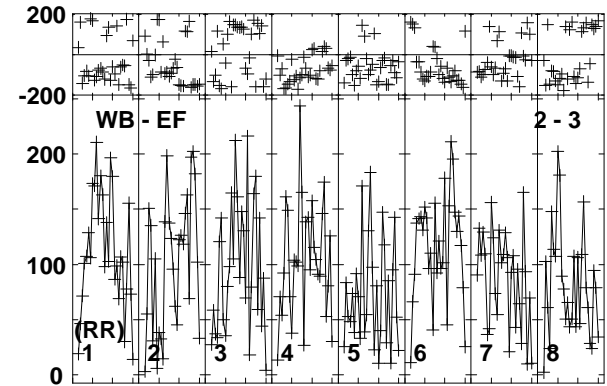
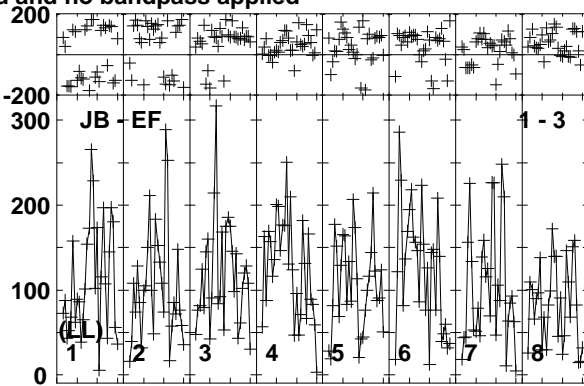
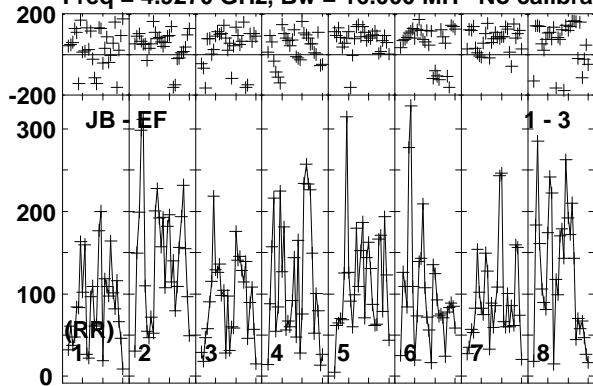

Lower frame: Micro Ampl Jy Top frame: Phas deg  
 Vector averaged cross-power spectrum Baseline: JB (01) - EF (03)  
 Timerange: 00/15:18:31 to 00/15:21:29

Plot file version 712 created 19-DEC-2018 17:59:02

AT2018\_RY007C.UVDATA.1

Freq = 4.9270 GHz, Bw = 16.000 MH No calibration applied and no bandpass applied

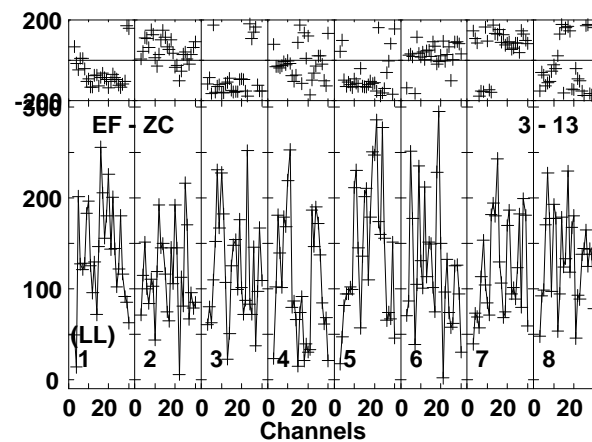
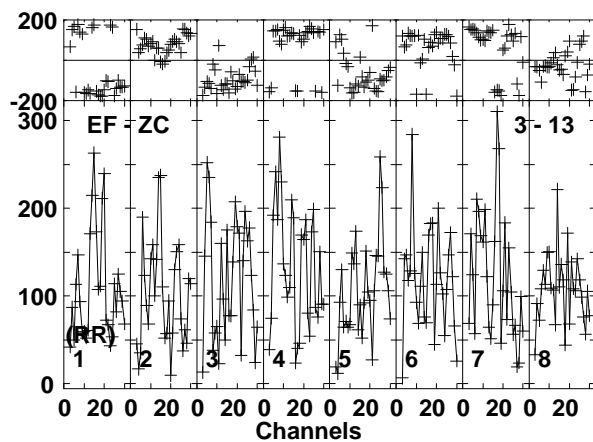
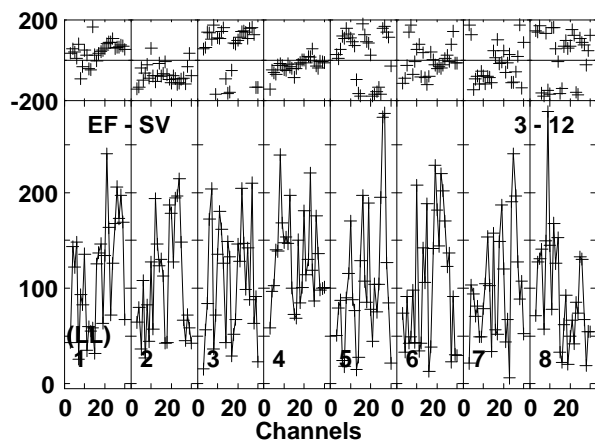
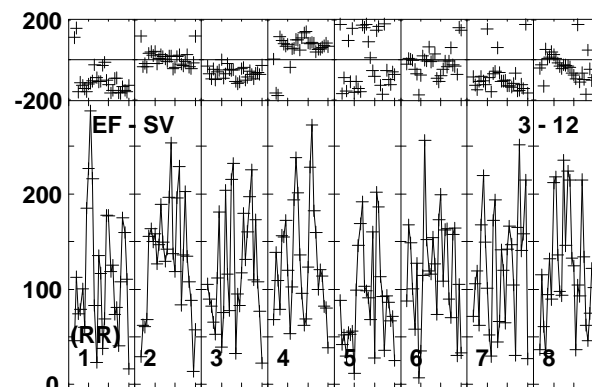
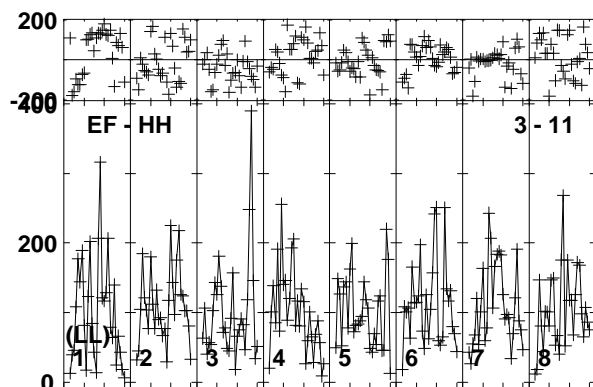
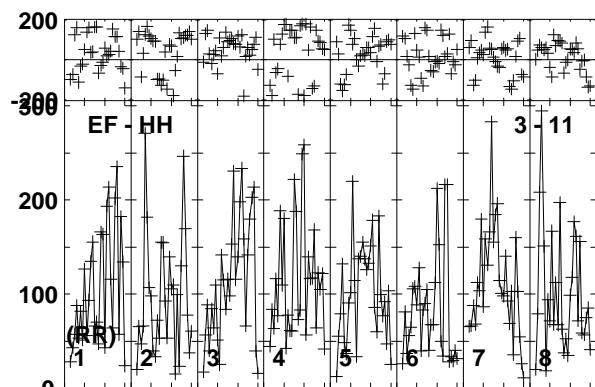
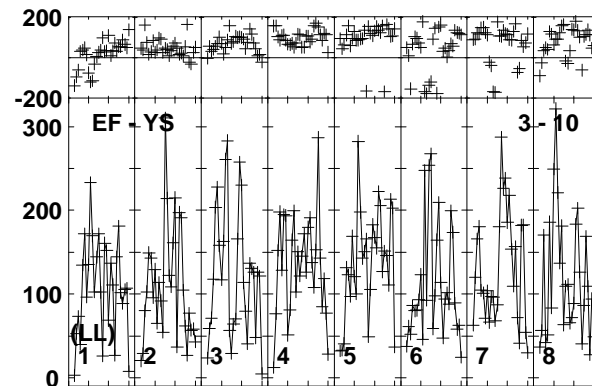
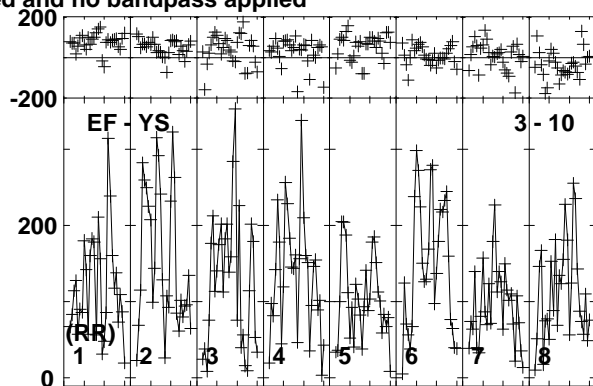
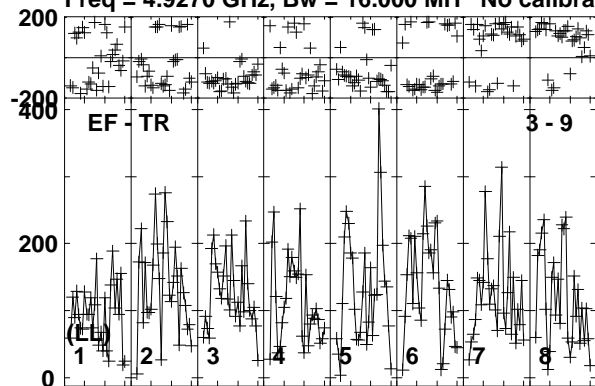

Lower frame: Micro Ampl Jy Top frame: Phas deg  
Vector averaged cross-power spectrum Baseline: EF (03) - TR (09)  
Timerange: 00/15:18:31 to 00/15:21:29

Plot file version 713 created 19-DEC-2018 17:59:02

AT2018\_RY007C.UVDATA.1

Freq = 4.9270 GHz, Bw = 16.000 MH No calibration applied and no bandpass applied

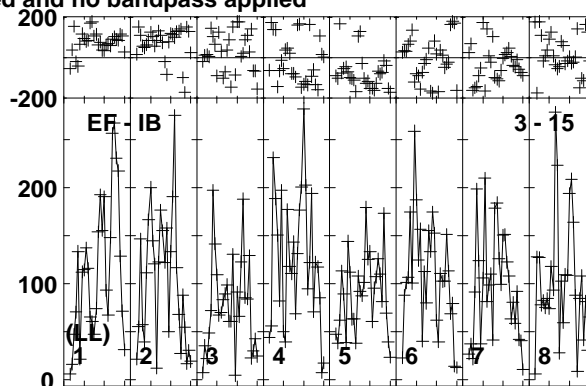
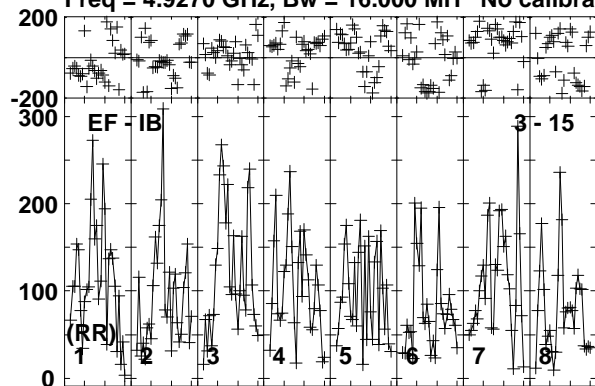

Lower frame: Micro Ampl Jy Top frame: Phas deg  
Vector averaged cross-power spectrum Baseline: EF (03) - IB (15)  
Timerange: 00/15:18:31 to 00/15:21:29

Plot file version 714 created 19-DEC-2018 17:59:02

J1619+2247 RY007C.UVDATA.1

Freq = 4.9270 GHz, Bw = 16.000 MH No calibration applied and no bandpass applied

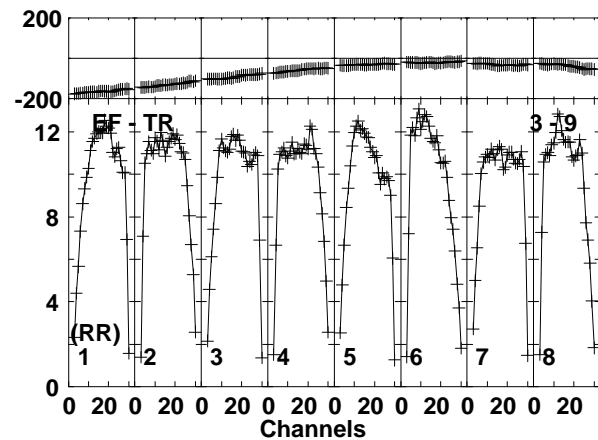
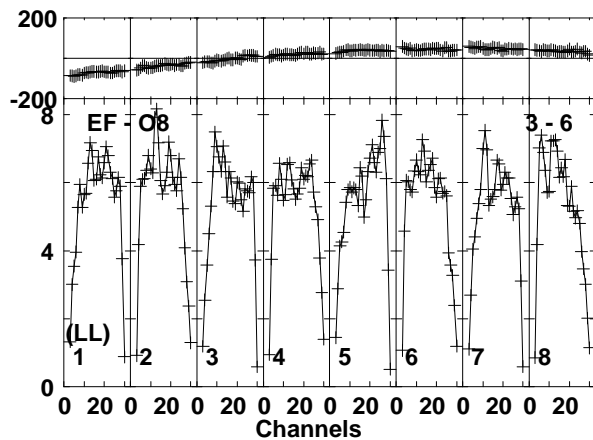
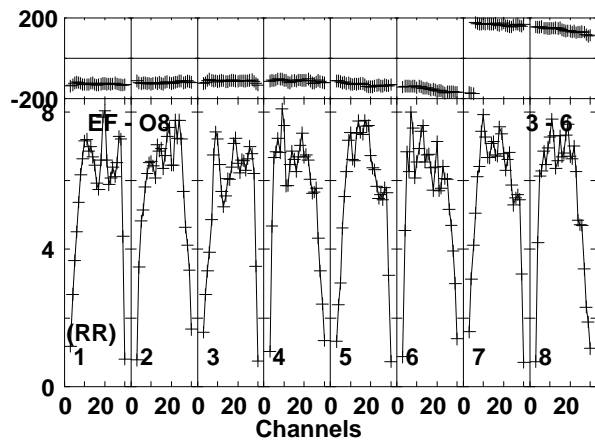
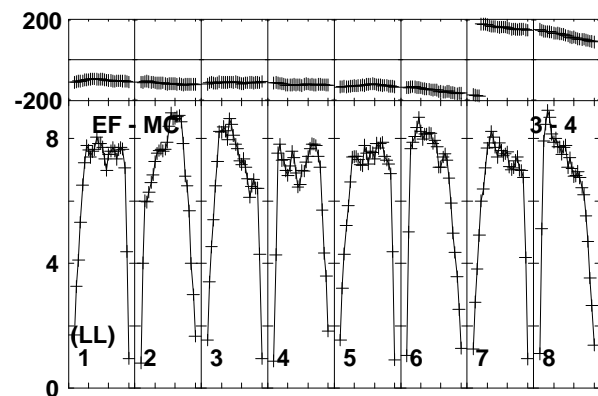
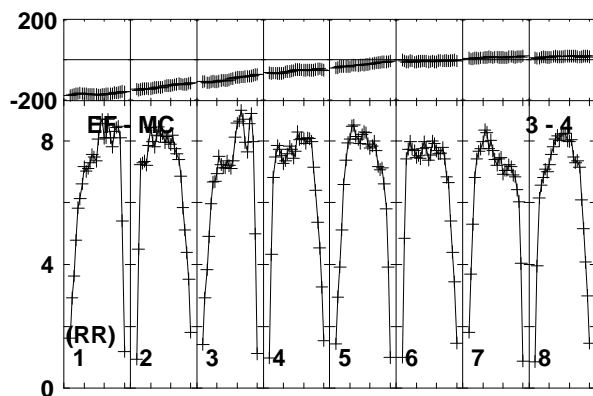
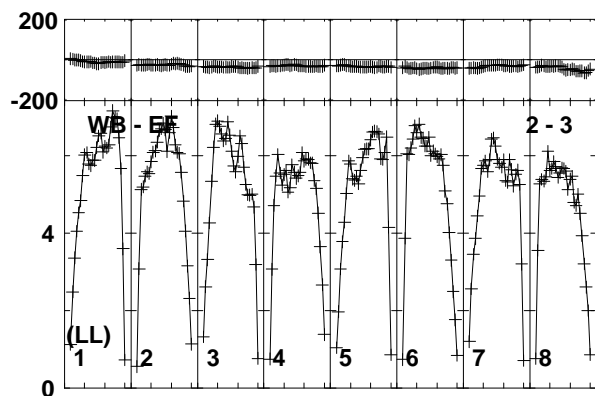
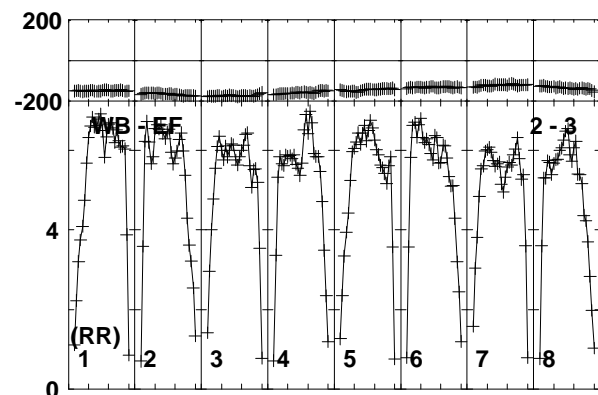
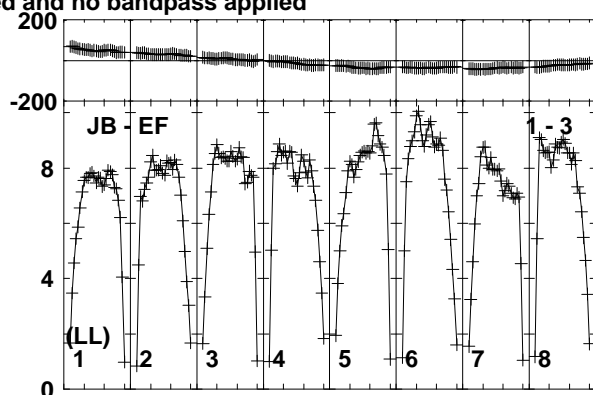
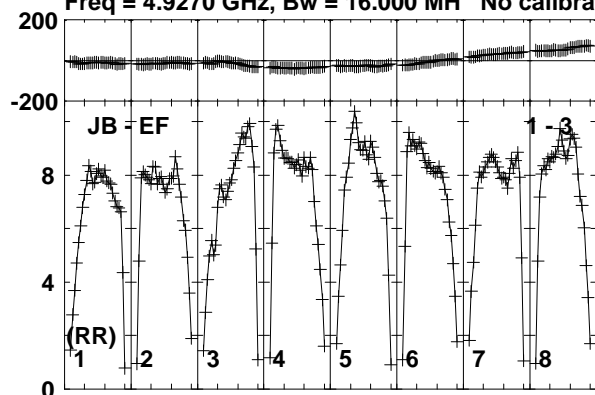

Lower frame: Milli Ampl Jy Top frame: Phas deg  
Vector averaged cross-power spectrum Baseline: JB (01) - EF (03)  
Timerange: 00/15:21:31 to 00/15:22:29



Plot file version 715 created 19-DEC-2018 17:59:02

J1619+2247 RY007C.UVDATA.1

Freq = 4.9270 GHz, Bw = 16.000 MH No calibration applied and no bandpass applied

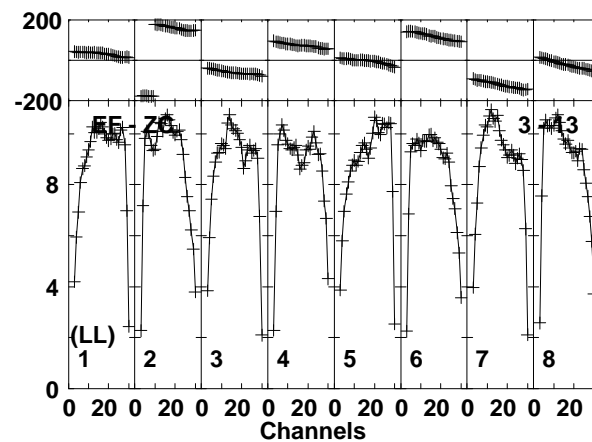
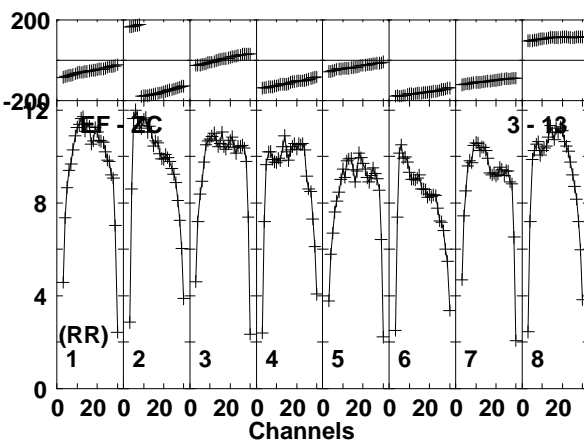
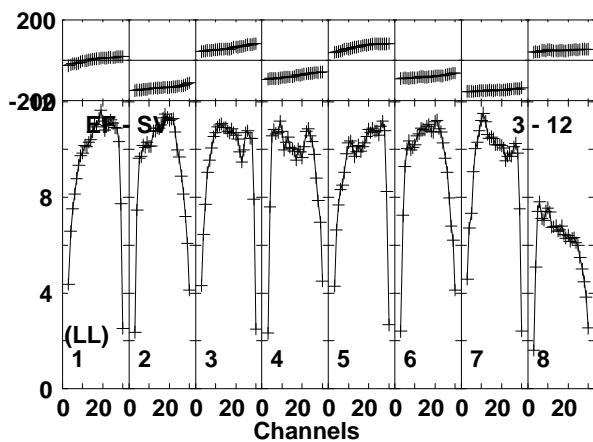
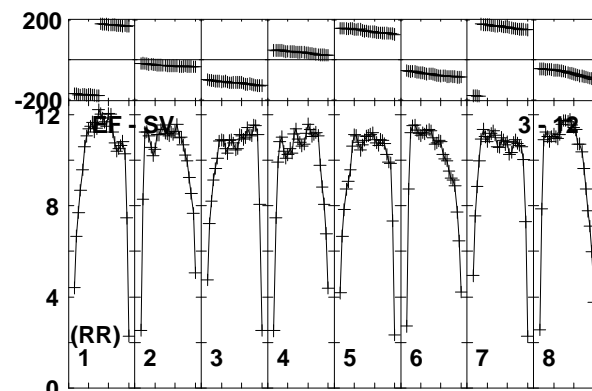
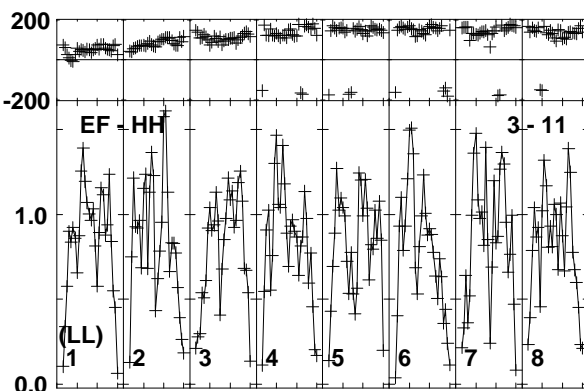
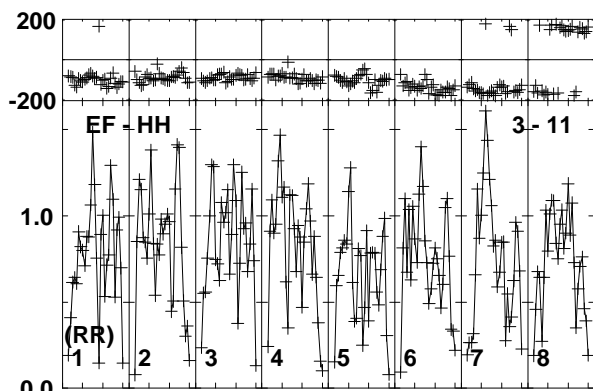
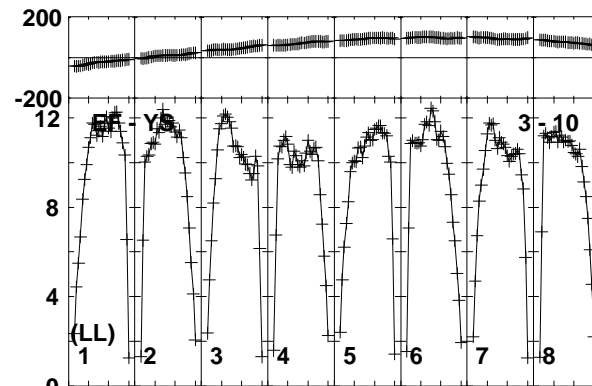
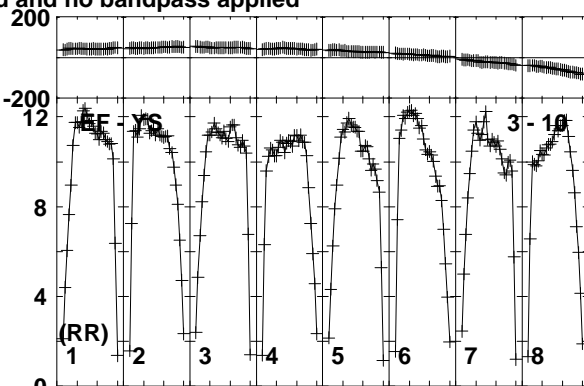
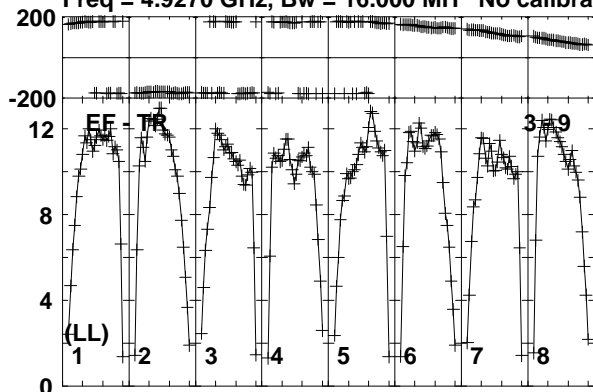

Lower frame: Milli Ampl Jy Top frame: Phas deg  
Vector averaged cross-power spectrum Baseline: EF (03) - TR (09)  
Timerange: 00/15:21:31 to 00/15:22:29

Plot file version 716 created 19-DEC-2018 17:59:02  
J1619+2247 RY007C.UVDATA.1

Freq = 4.9270 GHz, Bw = 16.000 MH No calibration applied and no bandpass applied

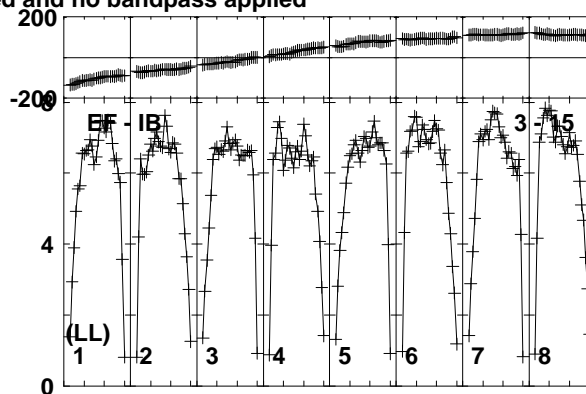
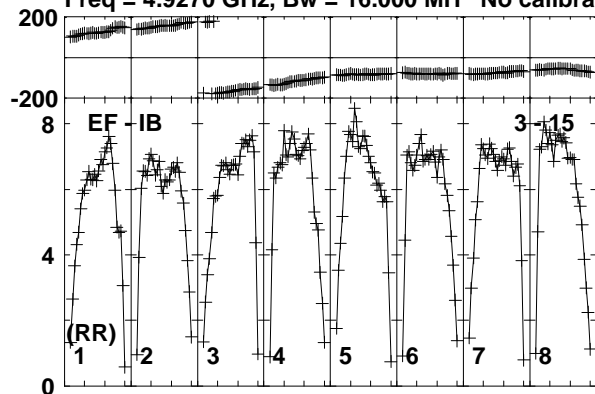

Lower frame: Milli Ampl Jy Top frame: Phas deg  
Vector averaged cross-power spectrum Baseline: EF (03) - IB (15)  
Timerange: 00/15:21:31 to 00/15:22:29

Plot file version 717 created 19-DEC-2018 17:59:02

VLA1 RY007C.UVDATA.1

Freq = 4.9270 GHz, Bw = 16.000 MH No calibration applied and no bandpass applied

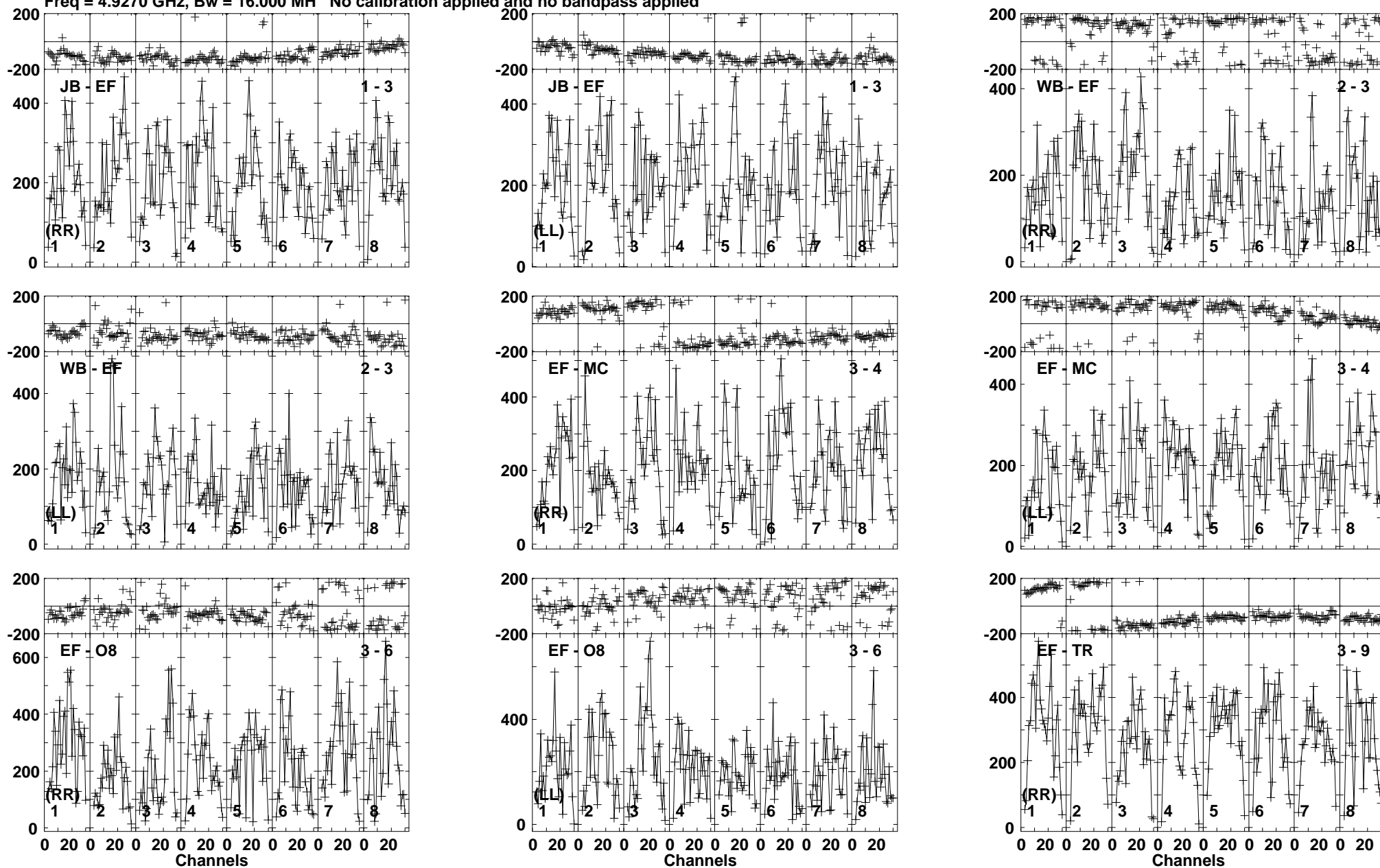

Lower frame: Micro Ampl Jy Top frame: Phas deg  
Vector averaged cross-power spectrum Baseline: JB (01) - EF (03)  
Timerange: 00/15:23:01 to 00/15:24:59

Plot file version 718 created 19-DEC-2018 17:59:02

VLA1 RY007C.UVDATA.1

Freq = 4.9270 GHz, Bw = 16.000 MH No calibration applied and no bandpass applied

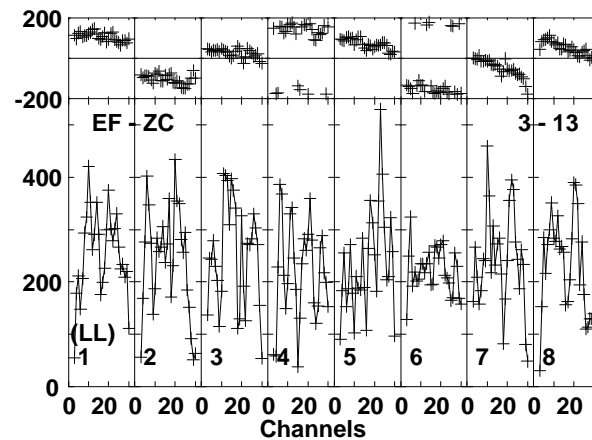
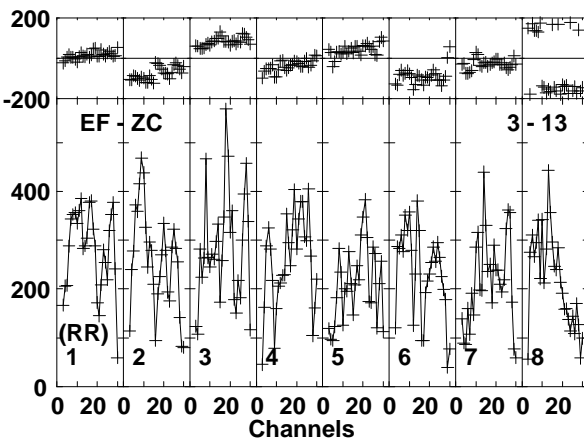
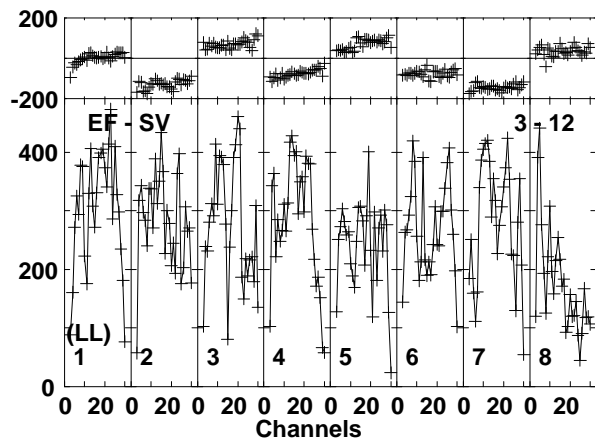
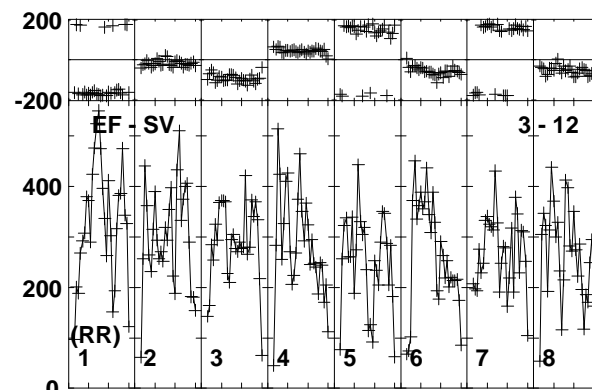
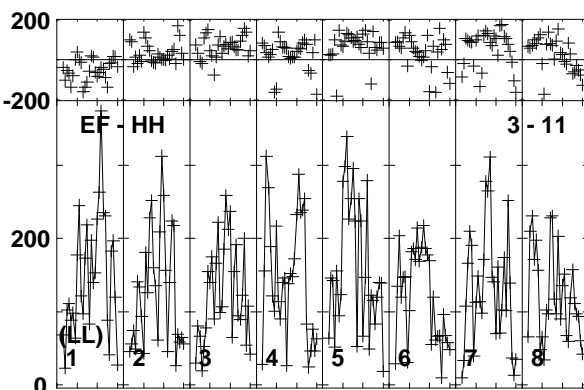
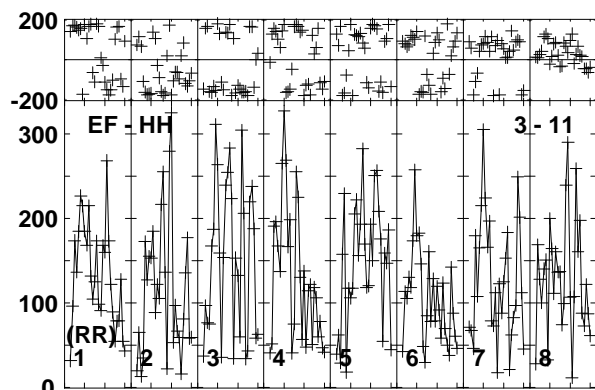
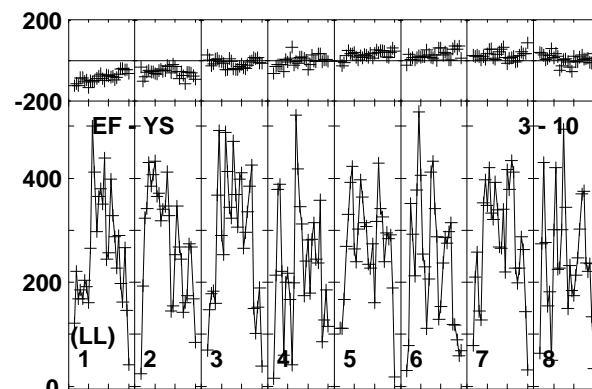
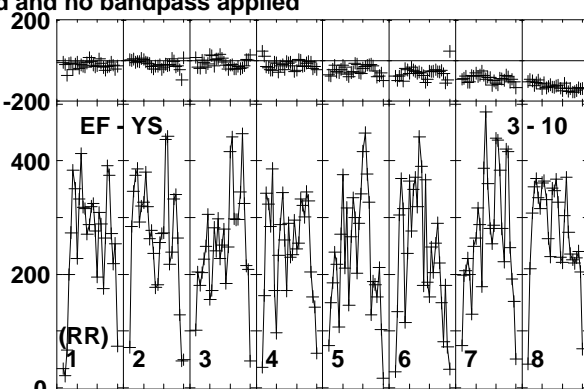
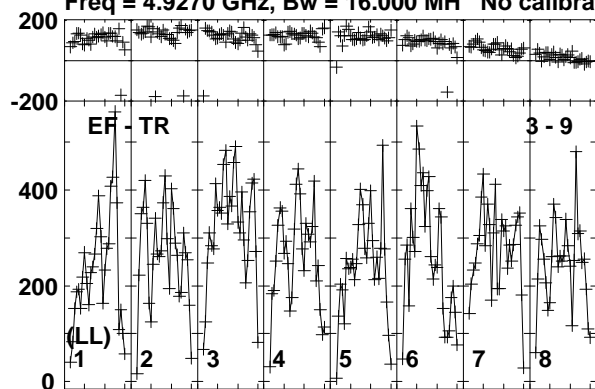

Lower frame: Micro Ampl Jy Top frame: Phas deg  
Vector averaged cross-power spectrum Baseline: EF (03) - TR (09)  
Timerange: 00/15:23:01 to 00/15:24:59

Plot file version 719 created 19-DEC-2018 17:59:02

VLA1 RY007C.UVDATA.1

Freq = 4.9270 GHz, Bw = 16.000 MH No calibration applied and no bandpass applied

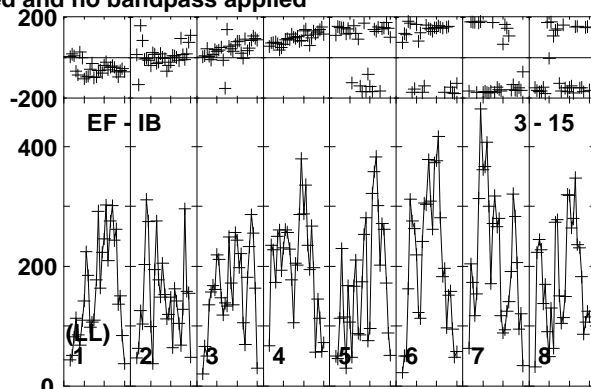
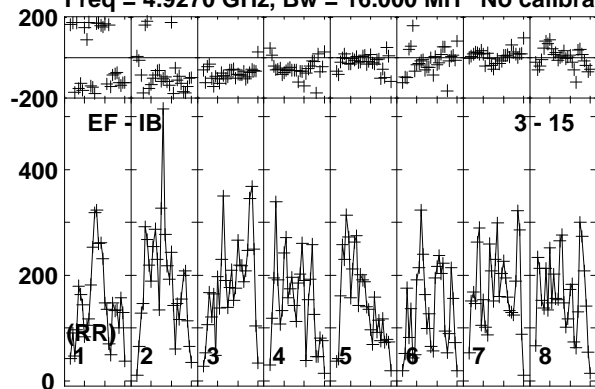

Lower frame: Micro Ampl Jy Top frame: Phas deg  
Vector averaged cross-power spectrum Baseline: EF (03) - IB (15)  
Timerange: 00/15:23:01 to 00/15:24:59

Plot file version 720 created 19-DEC-2018 17:59:02

J1619+2247 RY007C.UVDATA.1

Freq = 4.9270 GHz, Bw = 16.000 MH No calibration applied and no bandpass applied

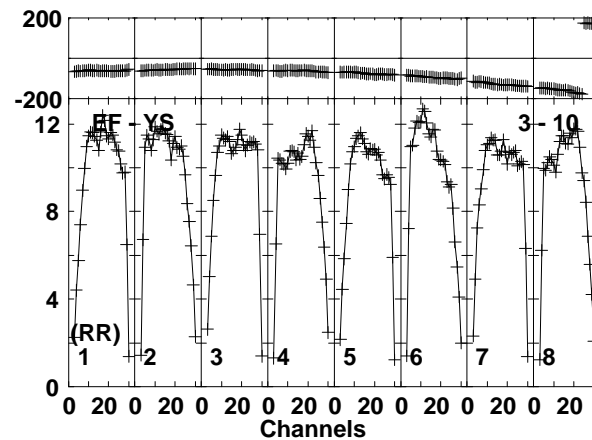
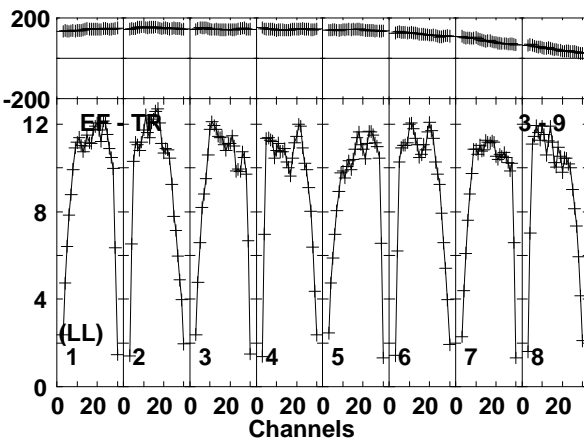
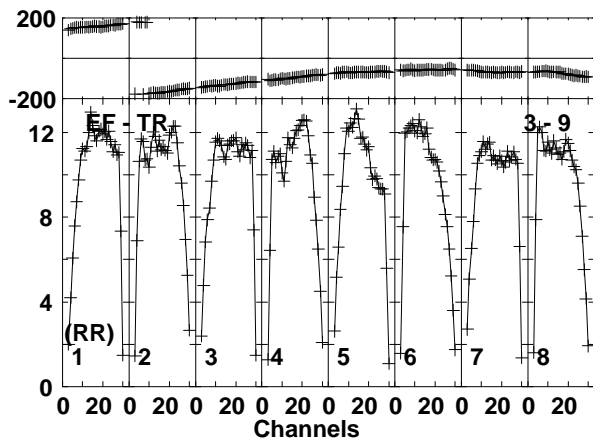
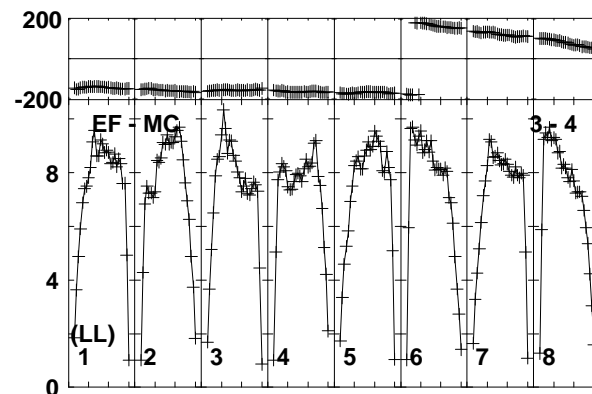
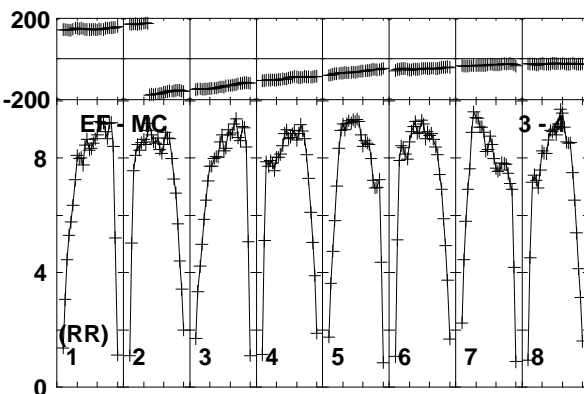
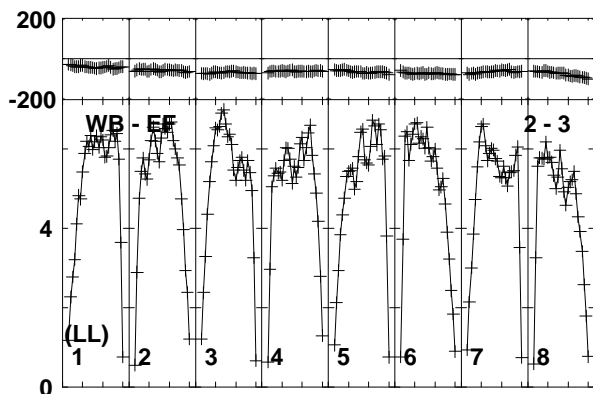
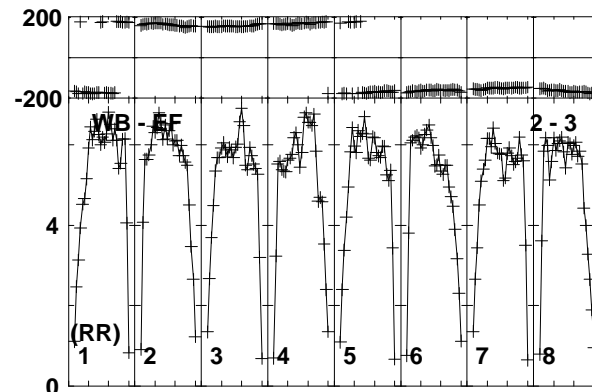
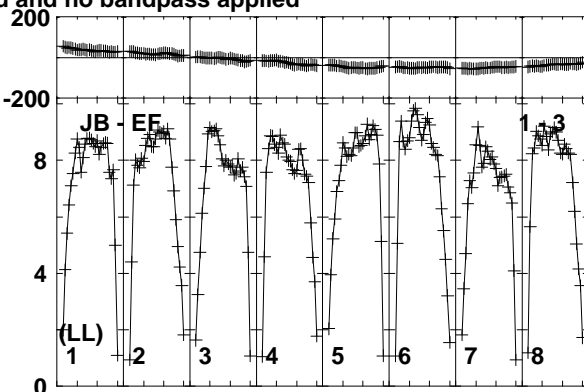
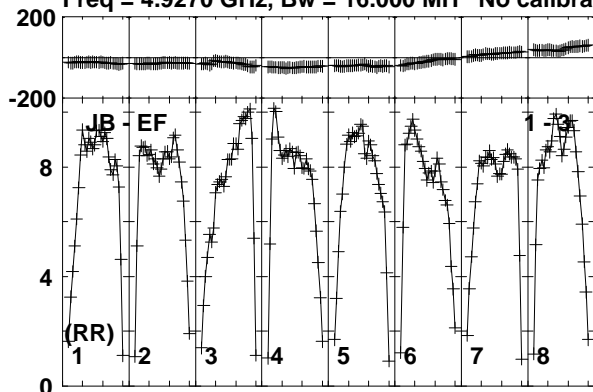

Lower frame: Milli Ampl Jy Top frame: Phas deg  
Vector averaged cross-power spectrum Baseline: JB (01) - EF (03)  
Timerange: 00/15:25:01 to 00/15:25:59

Plot file version 721 created 19-DEC-2018 17:59:02

J1619+2247 RY007C.UVDATA.1

Freq = 4.9270 GHz, Bw = 16.000 MH No calibration applied and no bandpass applied

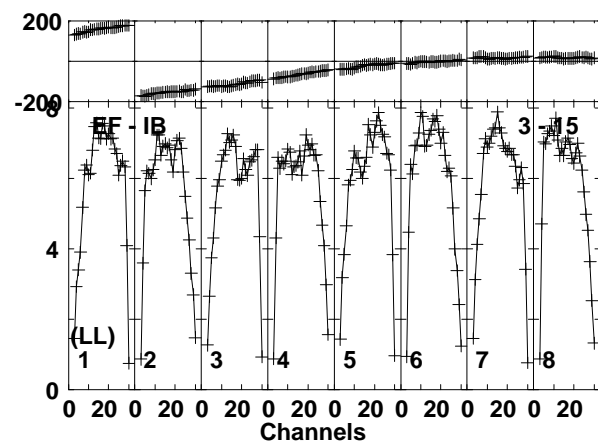
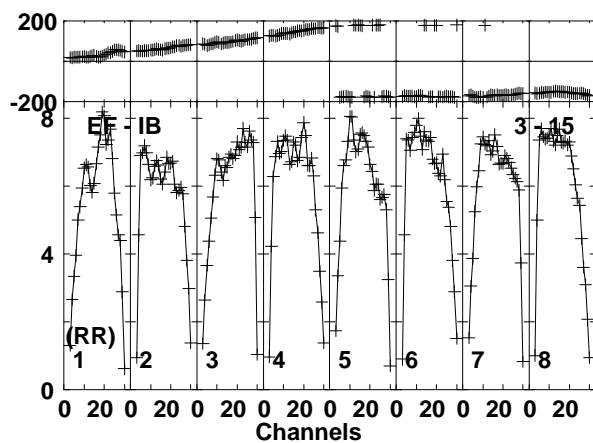
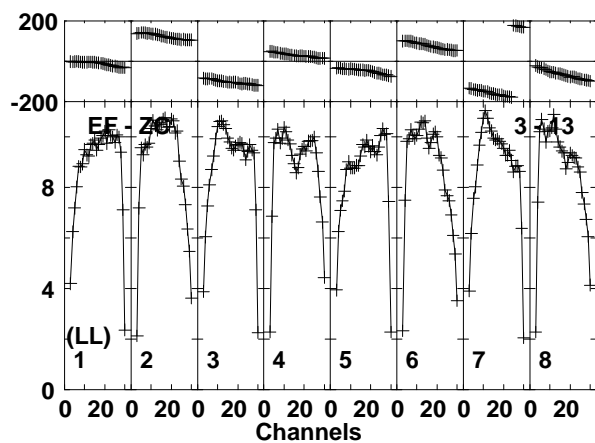
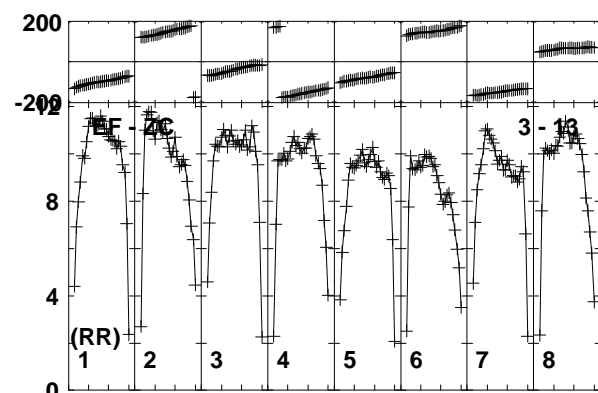
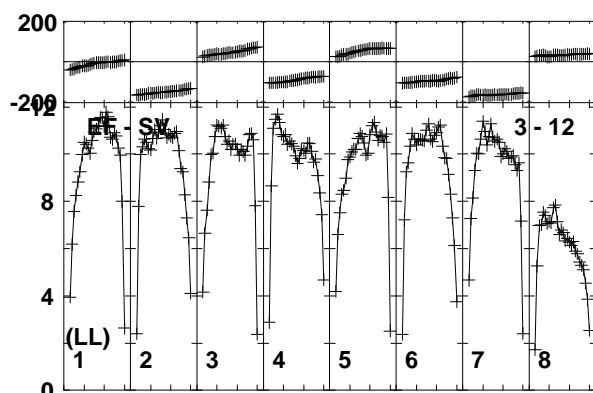
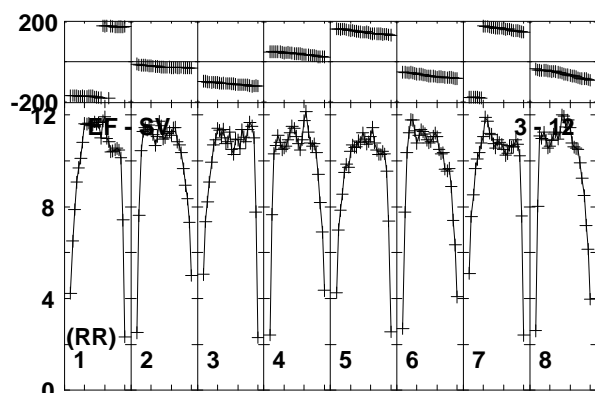
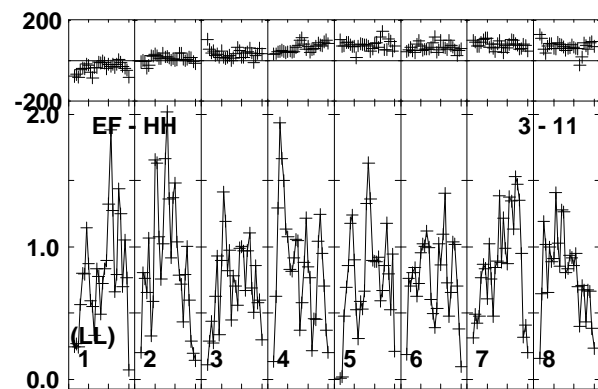
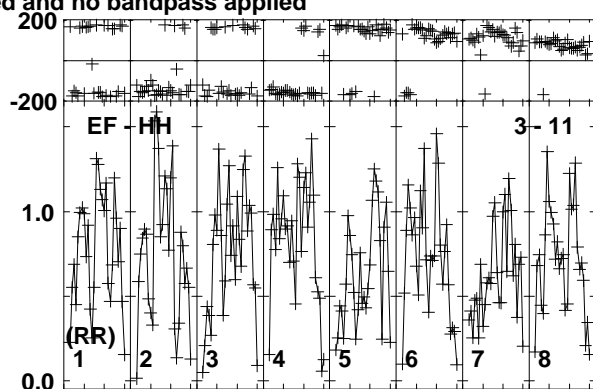
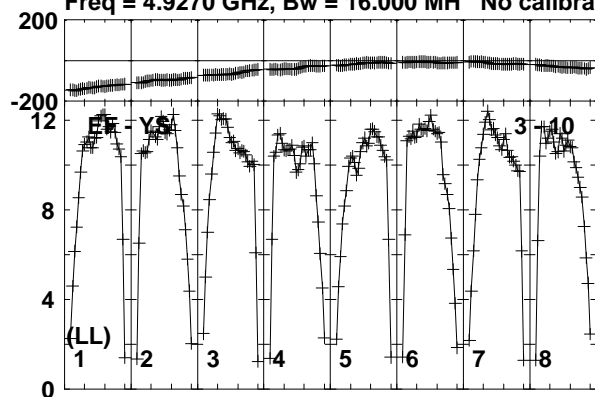

Lower frame: Milli Ampl Jy Top frame: Phas deg  
Vector averaged cross-power spectrum Baseline: EF (03) - YS (10)  
Timerange: 00/15:25:01 to 00/15:25:59

Plot file version 722 created 19-DEC-2018 17:59:02  
AT2018\_RY007C.UVDATA.1

Freq = 4.9270 GHz, Bw = 16.000 MH No calibration applied and no bandpass applied

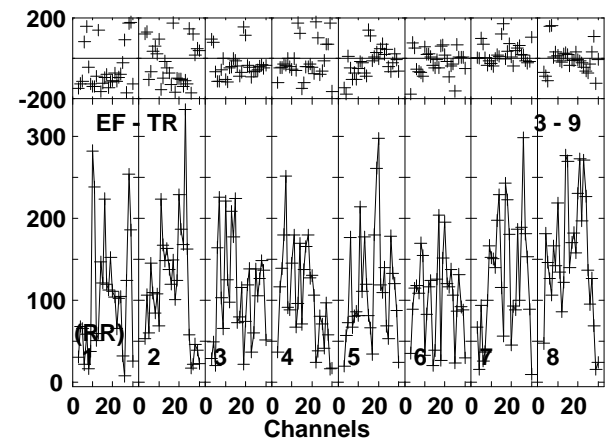
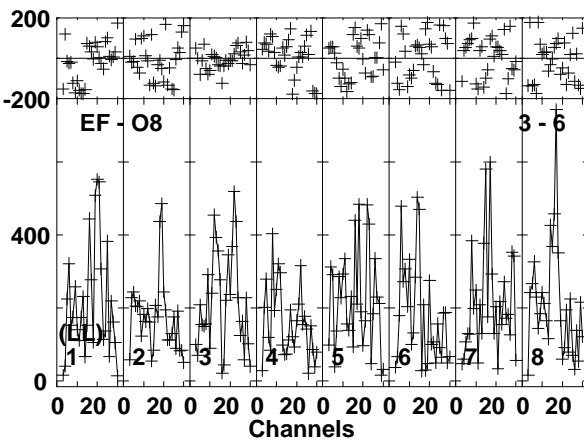
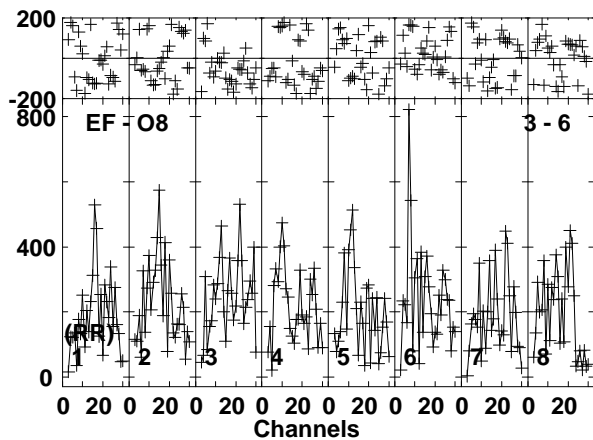
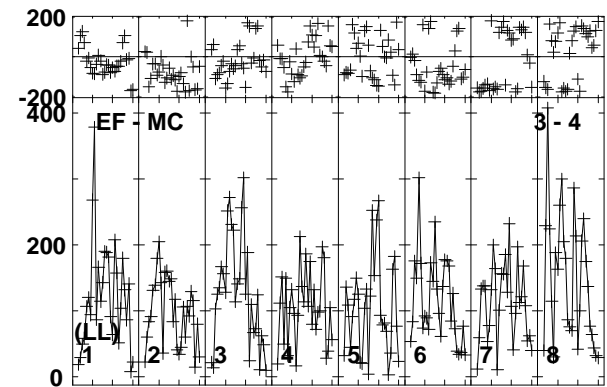
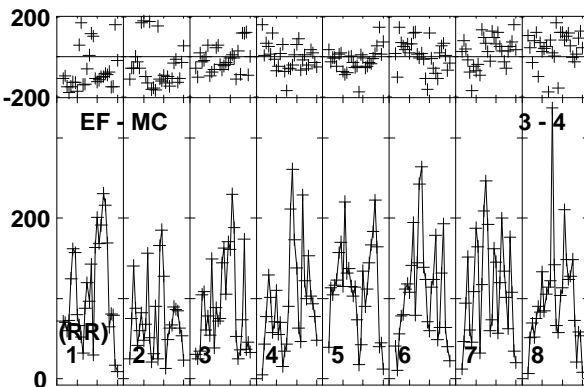
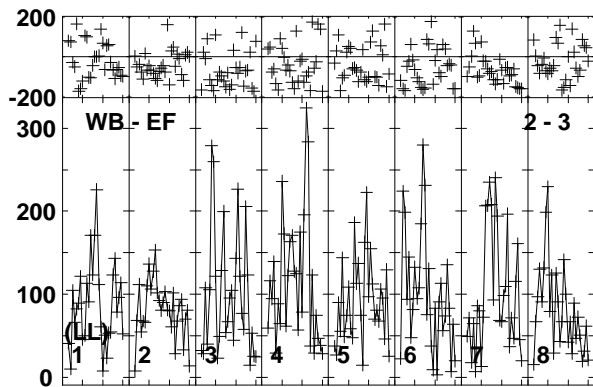
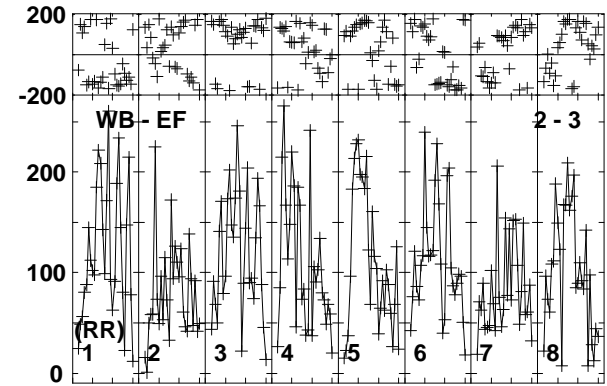
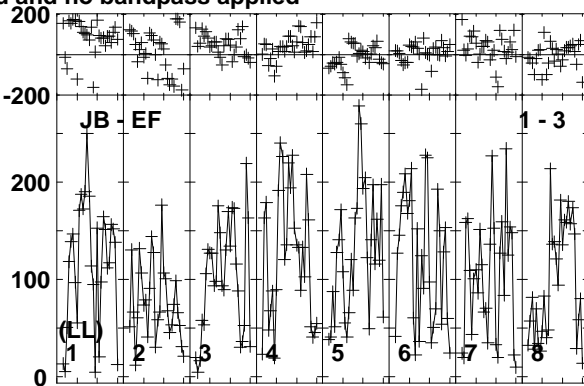
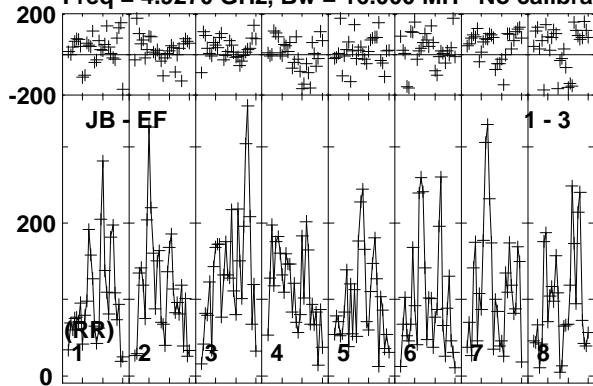

Lower frame: Micro Ampl Jy Top frame: Phas deg  
Vector averaged cross-power spectrum Baseline: JB (01) - EF (03)  
Timerange: 00/15:26:01 to 00/15:28:59



Plot file version 723 created 19-DEC-2018 17:59:02

AT2018\_RY007C.UVDATA.1

Freq = 4.9270 GHz, Bw = 16.000 MH No calibration applied and no bandpass applied

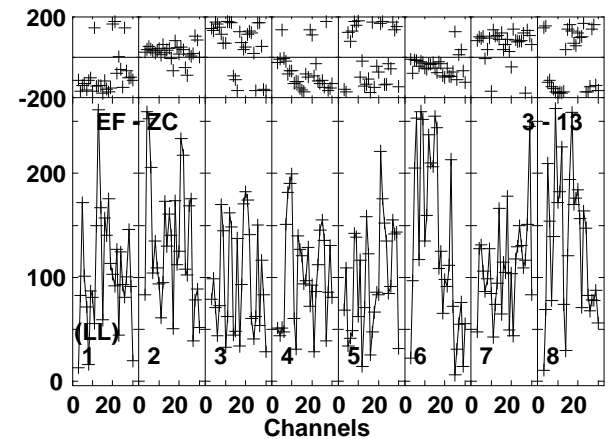
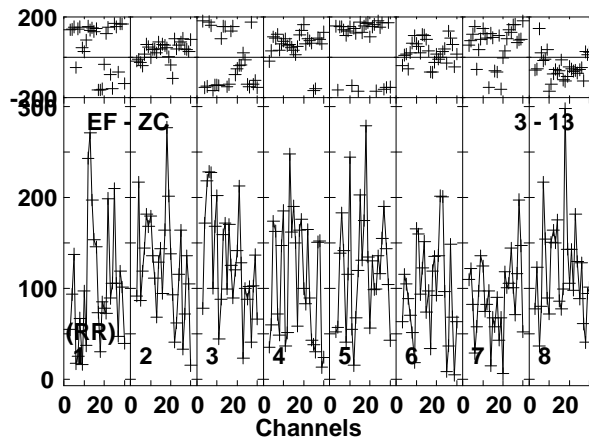
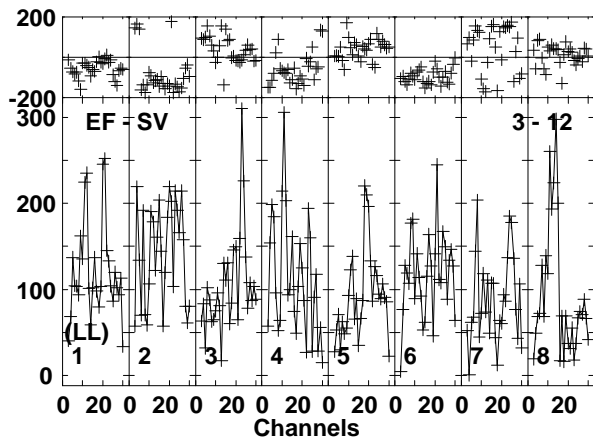
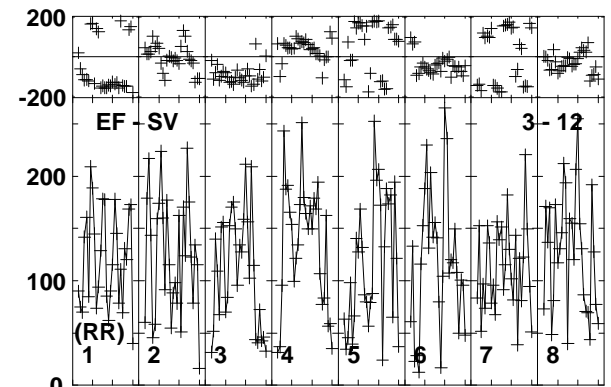
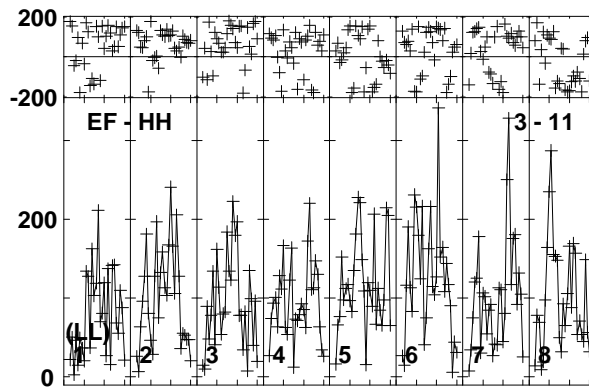
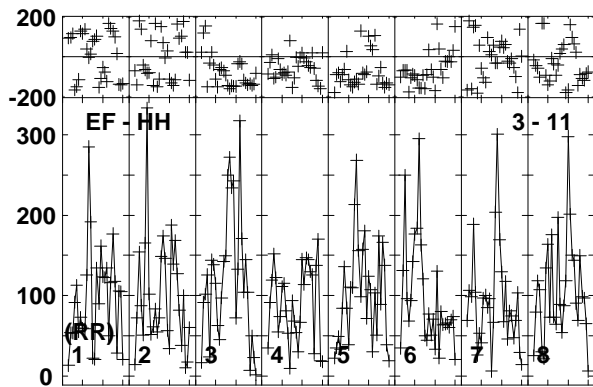
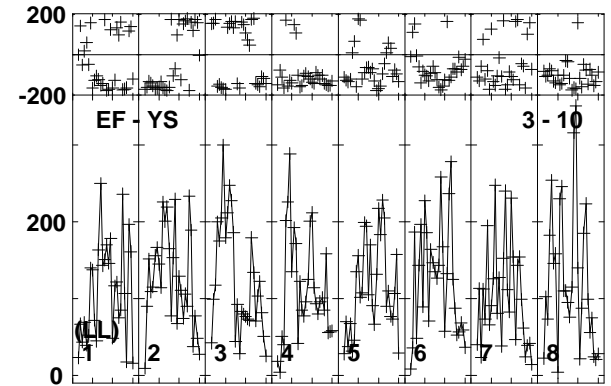
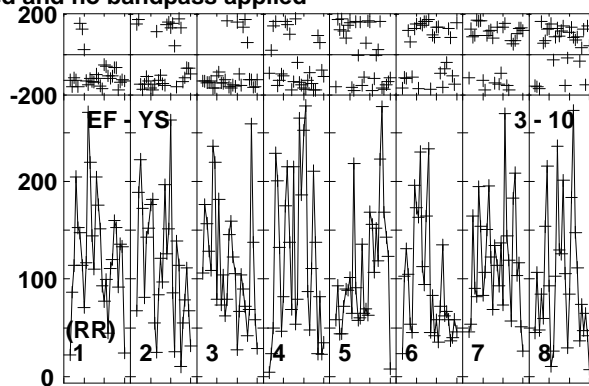
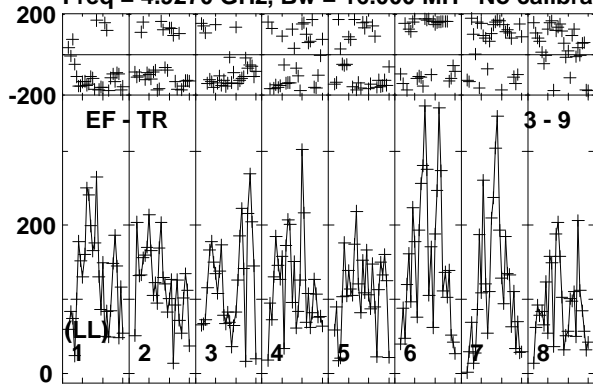

Lower frame: Micro Ampl Jy Top frame: Phas deg  
Vector averaged cross-power spectrum Baseline: EF (03) - TR (09)  
Timerange: 00:15:26:01 to 00:15:28:59

Plot file version 724 created 19-DEC-2018 17:59:02

AT2018\_RY007C.UVDATA.1

Freq = 4.9270 GHz, Bw = 16.000 MH No calibration applied and no bandpass applied

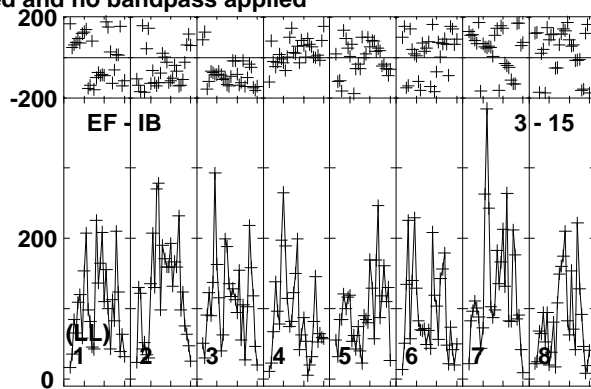
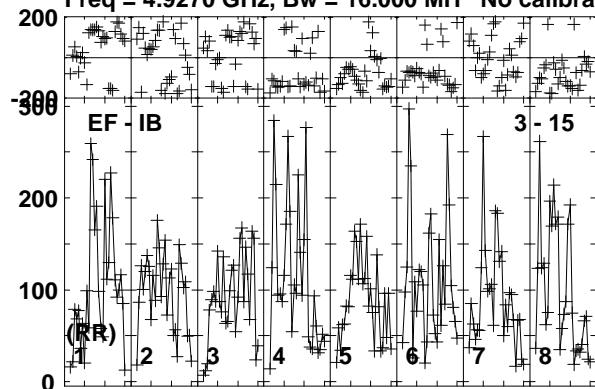

Lower frame: Micro Ampl Jy Top frame: Phas deg  
Vector averaged cross-power spectrum Baseline: EF (03) - IB (15)  
Timerange: 00/15:26:01 to 00/15:28:59

Plot file version 725 created 19-DEC-2018 17:59:02

J1619+2247 RY007C.UVDATA.1

Freq = 4.9270 GHz, Bw = 16.000 MH No calibration applied and no bandpass applied

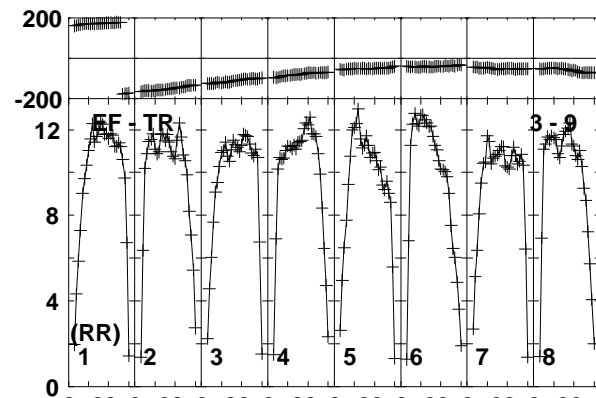
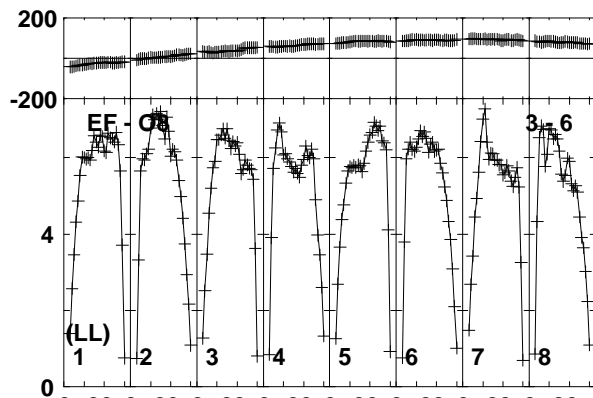
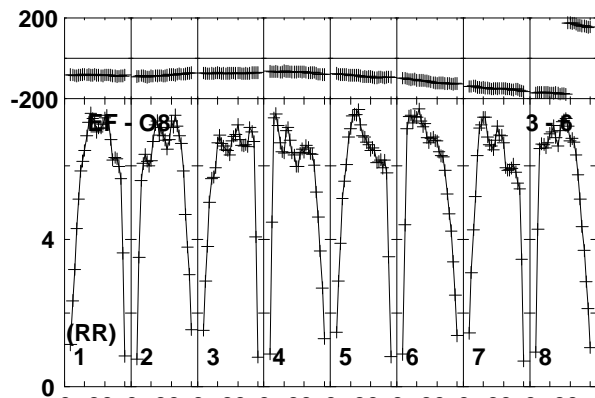
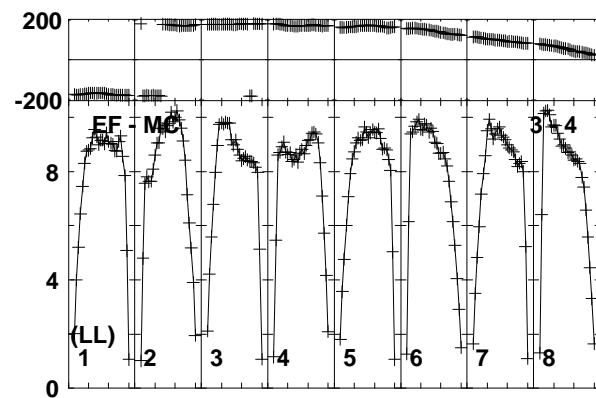
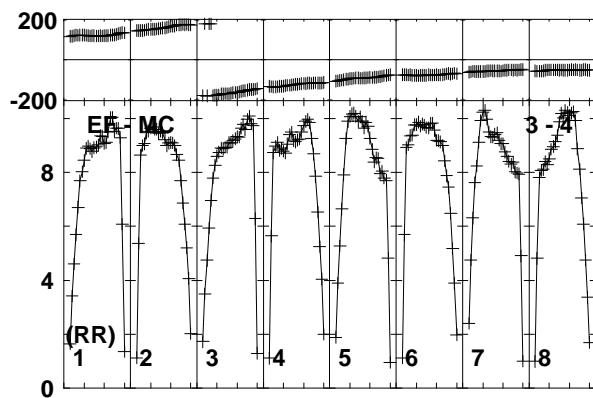
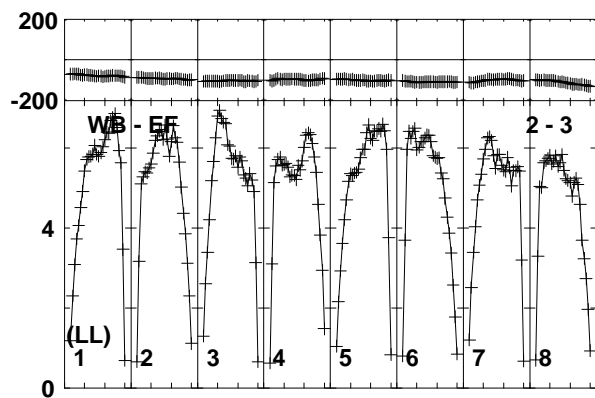
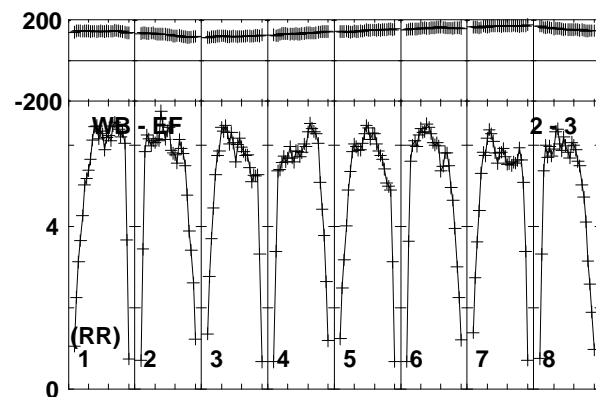
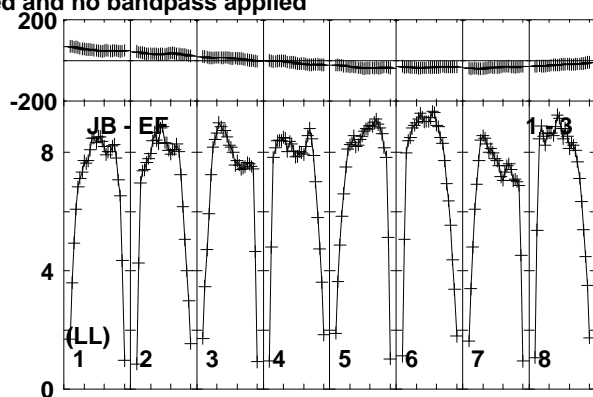
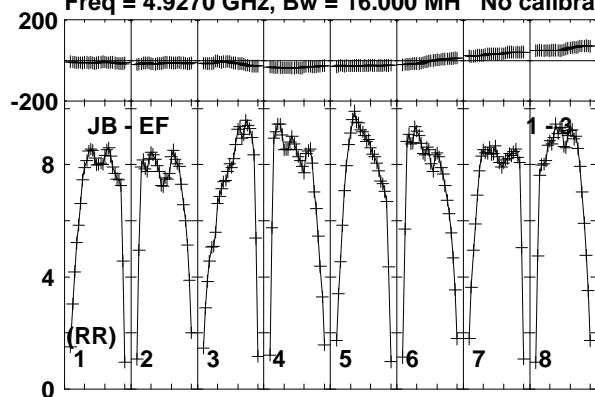

Lower frame: Milli Ampl Jy Top frame: Phas deg  
Vector averaged cross-power spectrum Baseline: JB (01) - EF (03)  
Timerange: 00/15:29:01 to 00/15:29:59

Plot file version 726 created 19-DEC-2018 17:59:02

J1619+2247 RY007C.UVDATA.1

Freq = 4.9270 GHz, Bw = 16.000 MH No calibration applied and no bandpass applied

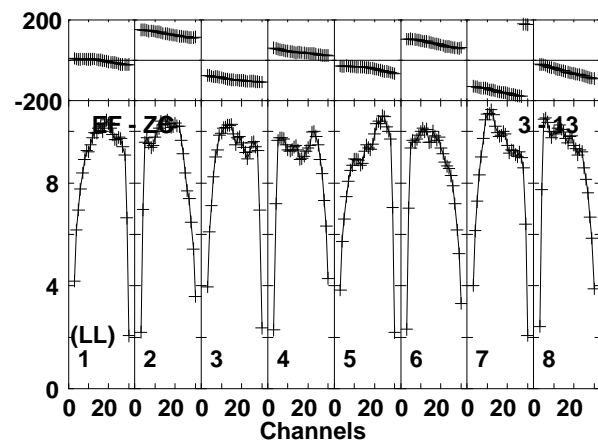
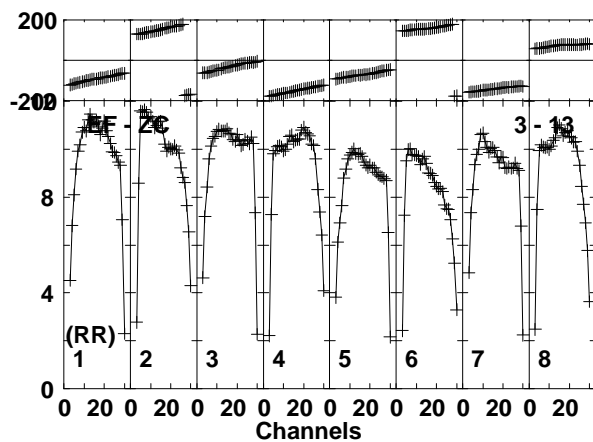
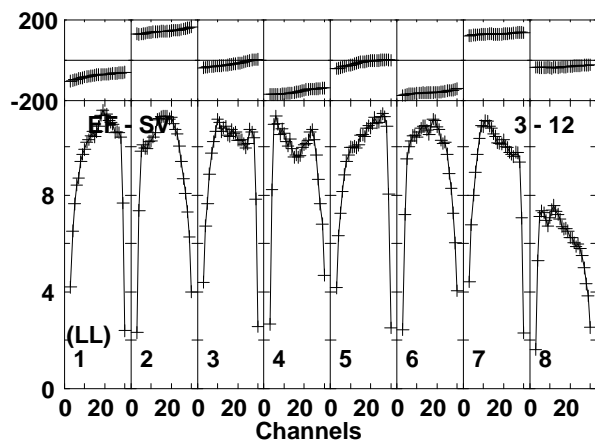
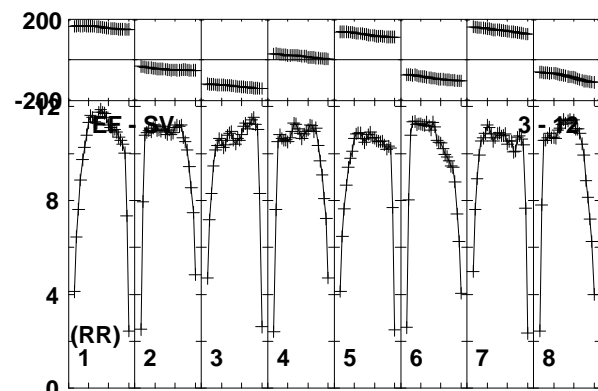
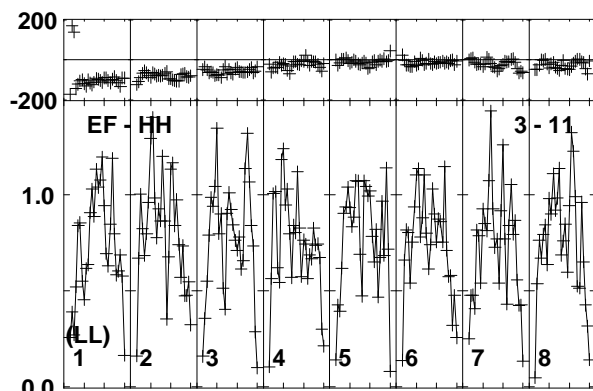
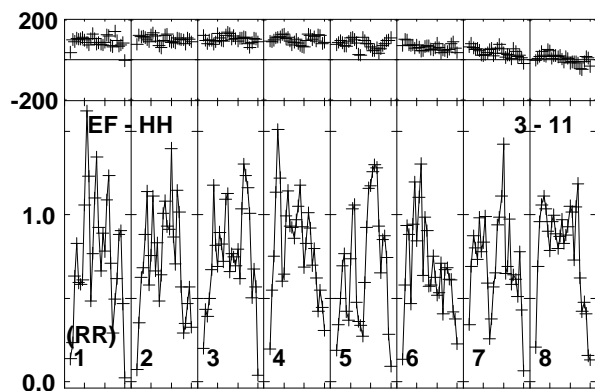
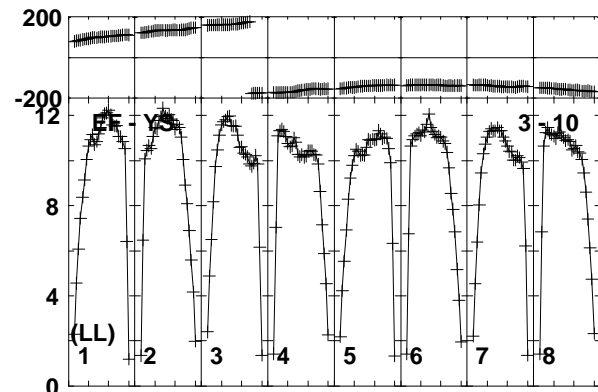
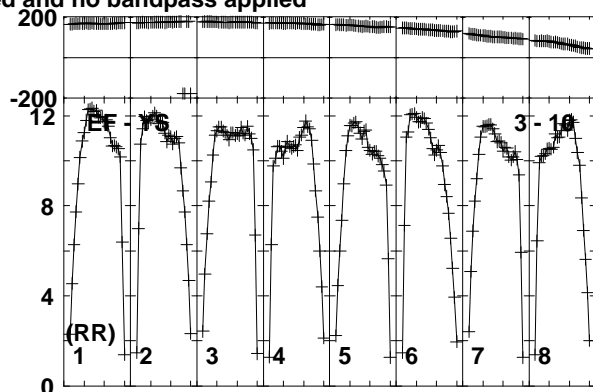
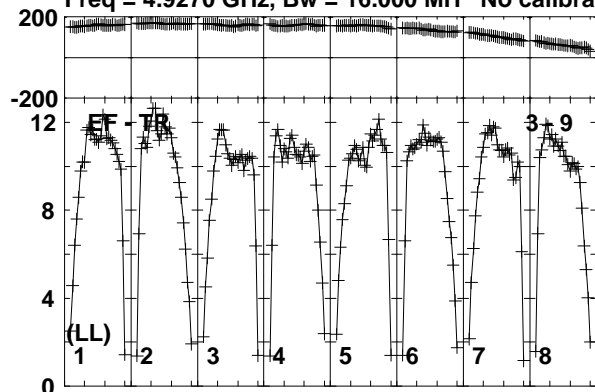

Lower frame: Milli Ampl Jy Top frame: Phas deg  
Vector averaged cross-power spectrum Baseline: EF (03) - TR (09)  
Timerange: 00/15:29:01 to 00/15:29:59

Plot file version 727 created 19-DEC-2018 17:59:02  
J1619+2247 RY007C.UVDATA.1

Freq = 4.9270 GHz, Bw = 16.000 MH No calibration applied and no bandpass applied

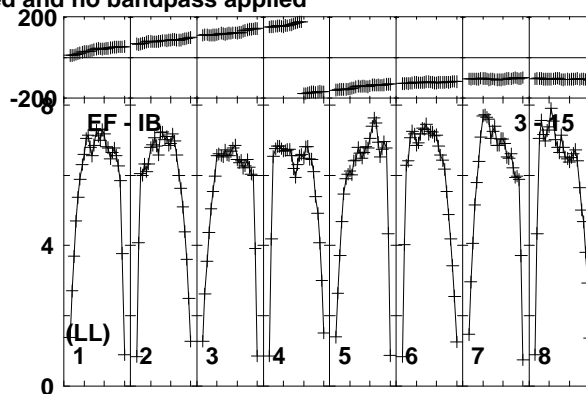
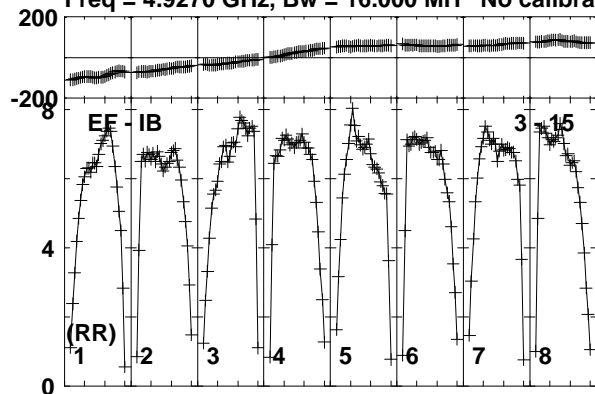

Lower frame: Milli Ampl Jy Top frame: Phas deg  
Vector averaged cross-power spectrum Baseline: EF (03) - IB (15)  
Timerange: 00/15:29:01 to 00/15:29:59

Plot file version 728 created 19-DEC-2018 17:59:02  
AT2018\_RY007C.UVDATA.1

Freq = 4.9270 GHz, Bw = 16.000 MH No calibration applied and no bandpass applied

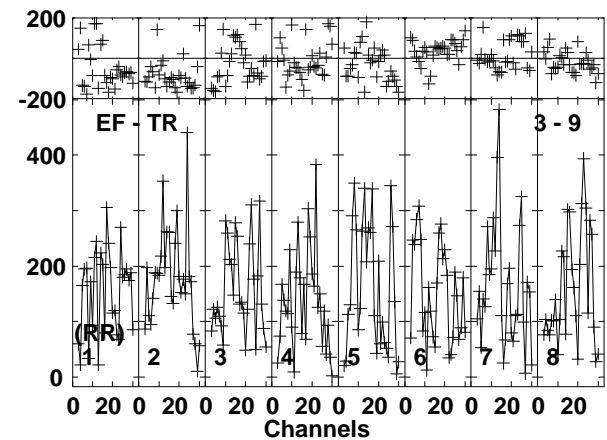
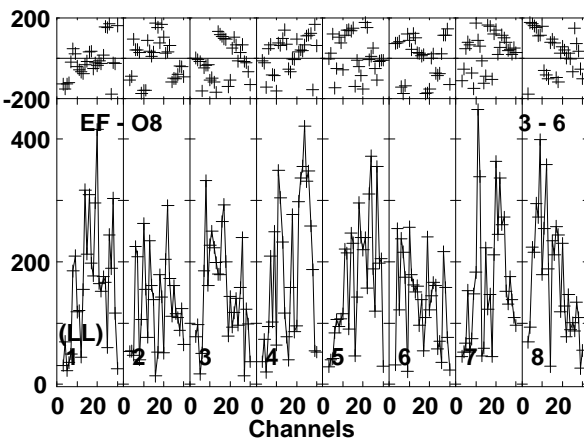
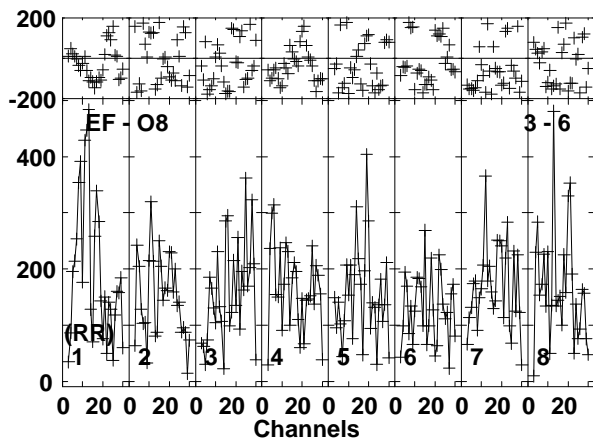
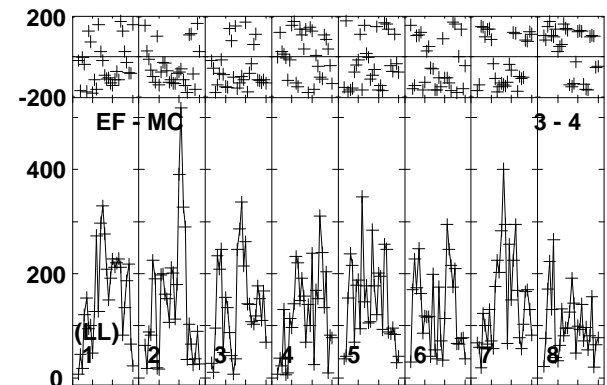
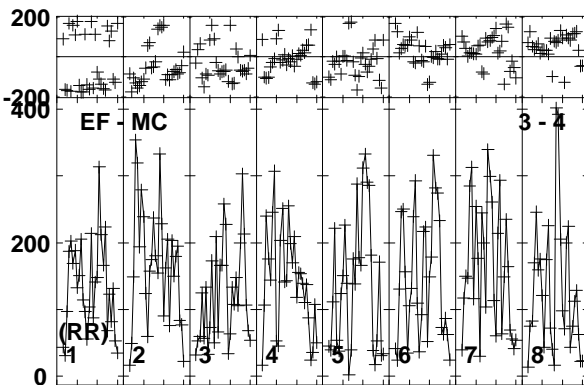
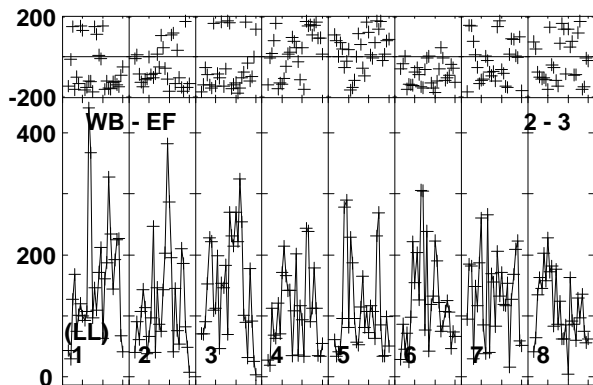
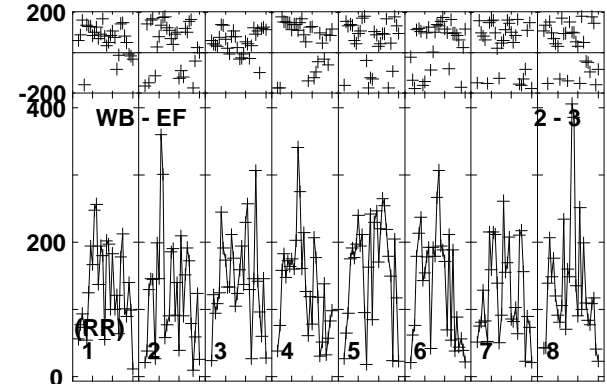
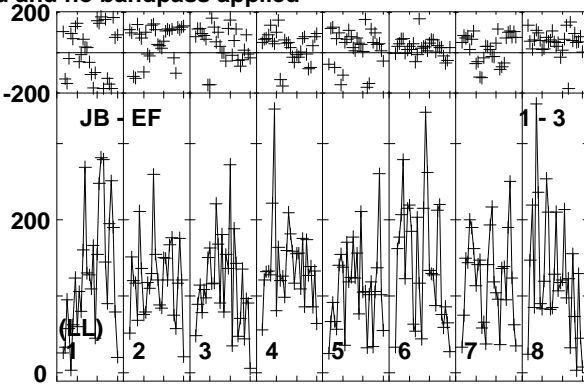
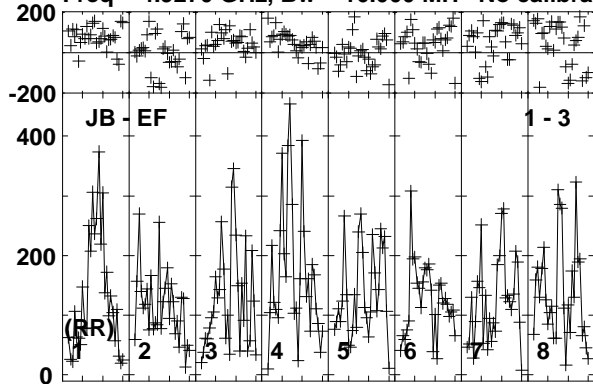

Lower frame: Micro Ampl Jy Top frame: Phas deg  
Vector averaged cross-power spectrum Baseline: JB (01) - EF (03)  
Timerange: 00/15:30:01 to 00/15:31:59

Plot file version 729 created 19-DEC-2018 17:59:02

AT2018\_RY007C.UVDATA.1

Freq = 4.9270 GHz, Bw = 16.000 MH No calibration applied and no bandpass applied

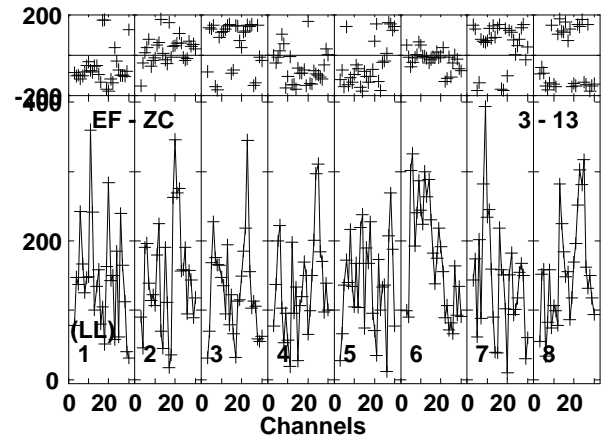
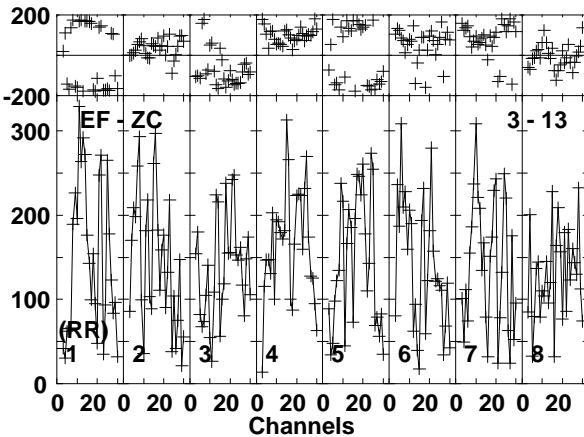
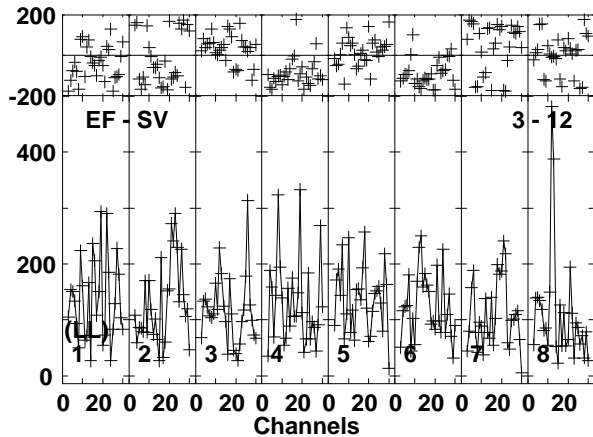
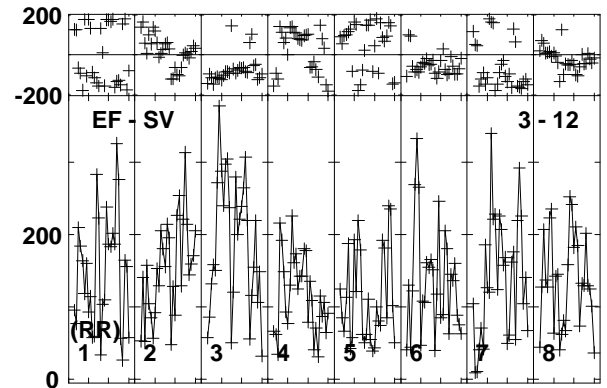
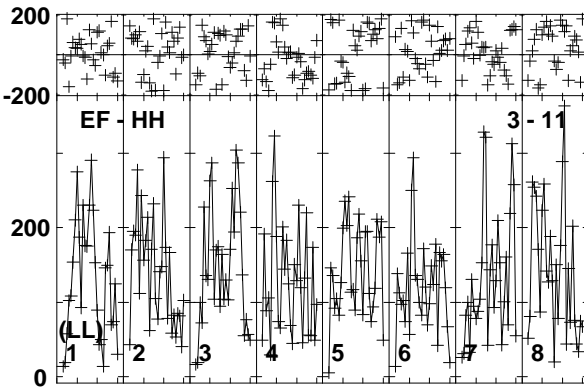
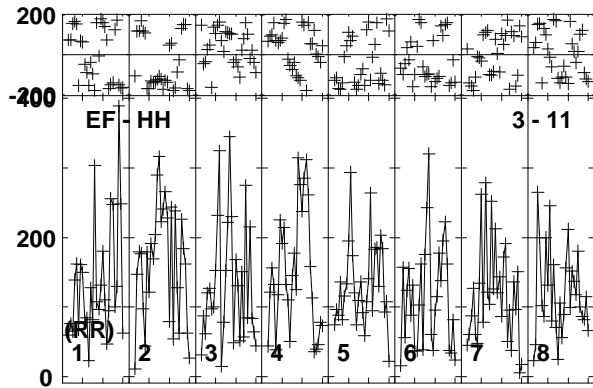
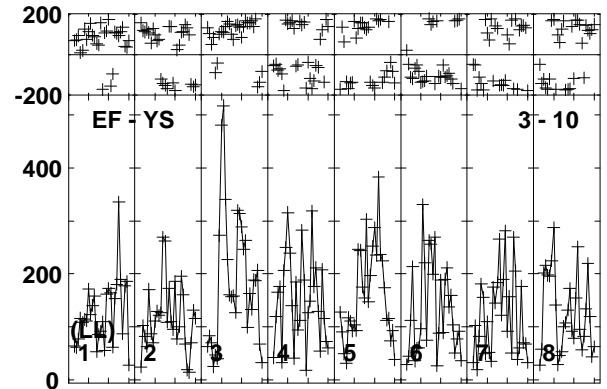
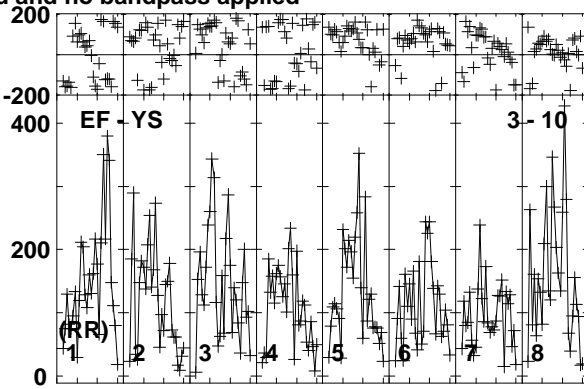
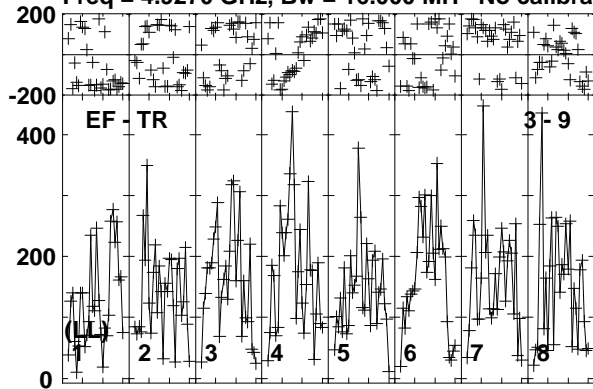

Lower frame: Micro Ampl Jy Top frame: Phas deg  
Vector averaged cross-power spectrum Baseline: EF (03) - TR (09)  
Timerange: 00/15:30:01 to 00/15:31:59

Plot file version 730 created 19-DEC-2018 17:59:02

AT2018\_RY007C.UVDATA.1

Freq = 4.9270 GHz, Bw = 16.000 MH No calibration applied and no bandpass applied

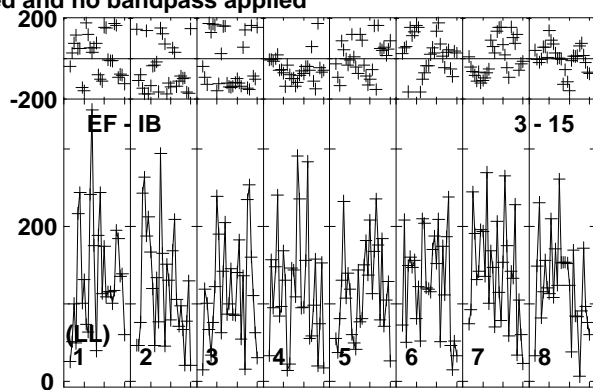
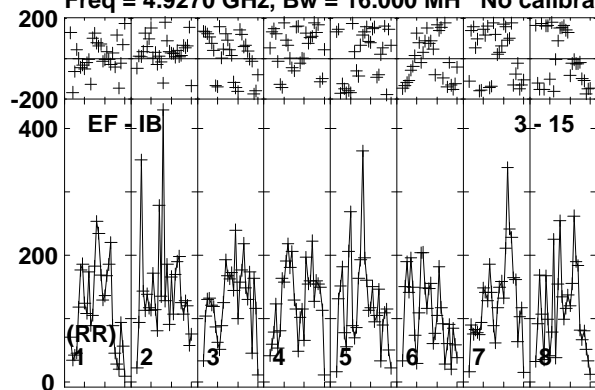

Lower frame: Micro Ampl Jy Top frame: Phas deg  
Vector averaged cross-power spectrum Baseline: EF (03) - IB (15)  
Timerange: 00/15:30:01 to 00/15:31:59



Plot file version 731 created 19-DEC-2018 17:59:02

VLA2 RY007C.UVDATA.1

Freq = 4.9270 GHz, Bw = 16.000 MH No calibration applied and no bandpass applied

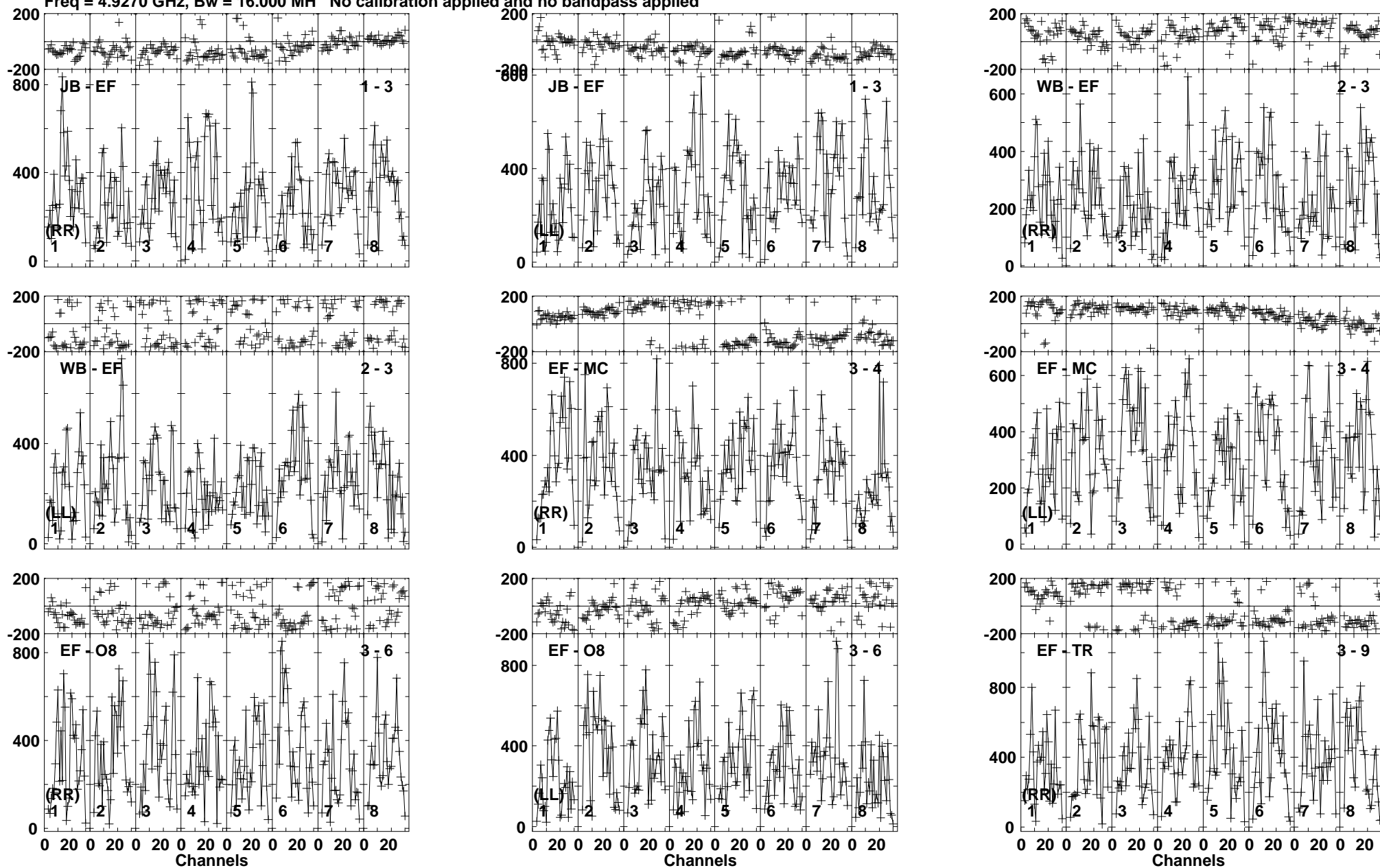

Lower frame: Micro Ampl Jy Top frame: Phas deg  
Vector averaged cross-power spectrum Baseline: JB (01) - EF (03)  
Timerange: 00/15:32:01 to 00/15:32:59

Plot file version 732 created 19-DEC-2018 17:59:02

VLA2\_RY007C.UVDATA.1

Freq = 4.9270 GHz, Bw = 16.000 MH No calibration applied and no bandpass applied

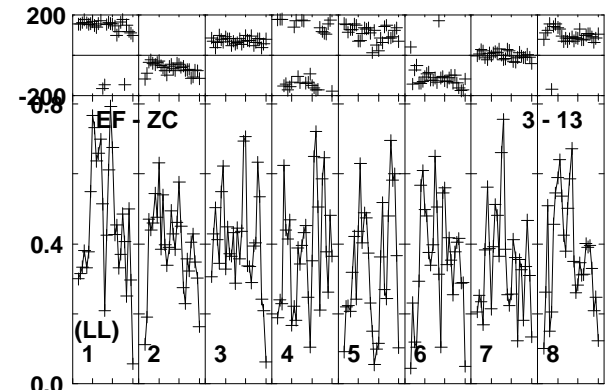
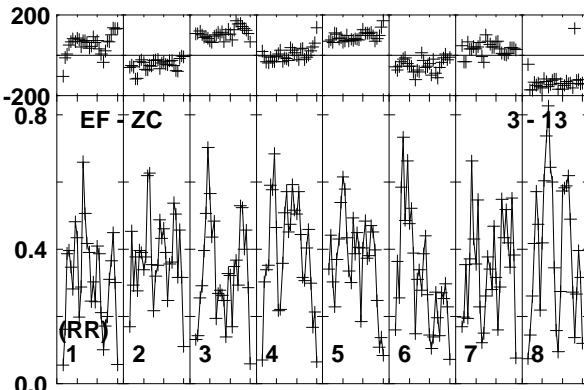
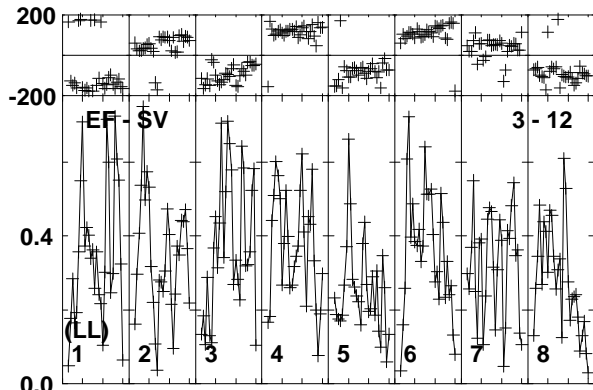
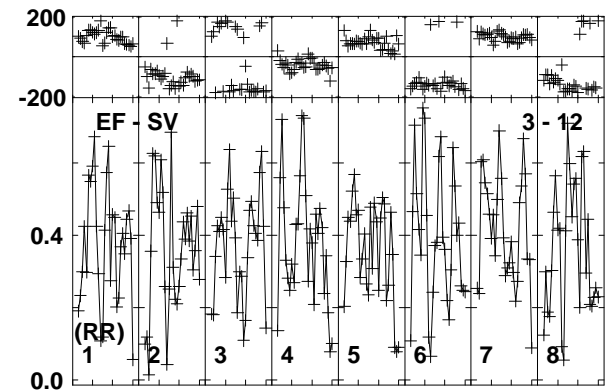
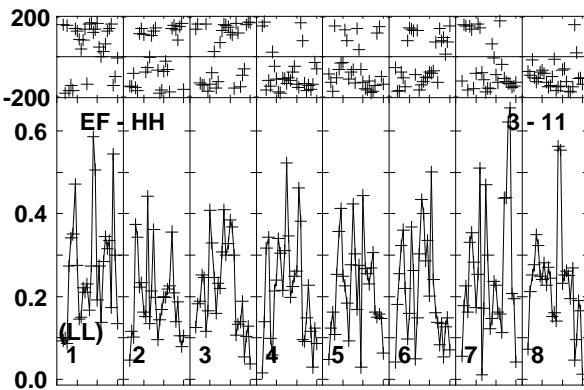
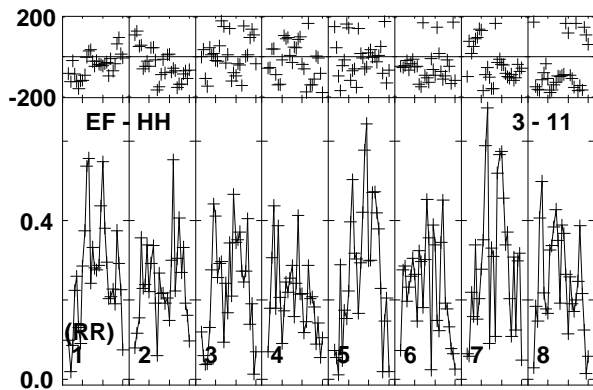
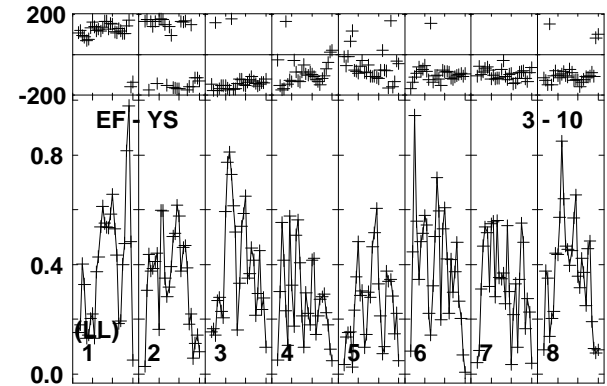
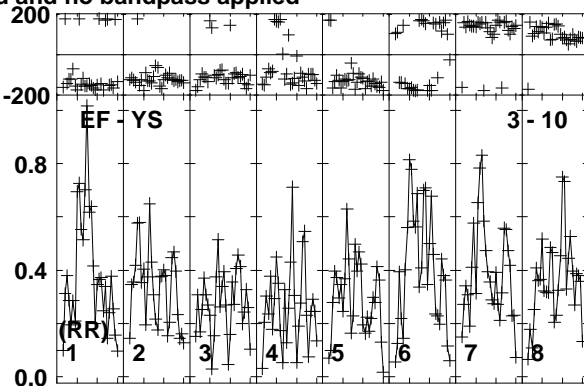
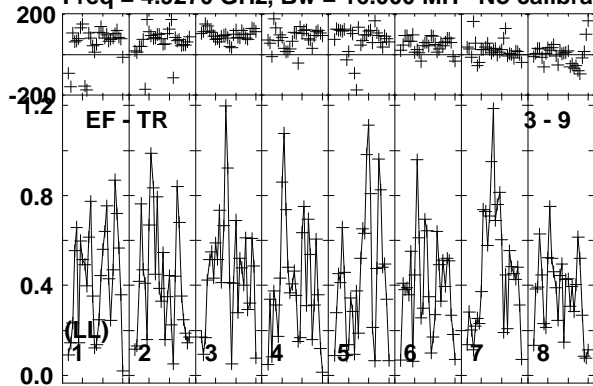

Lower frame: Milli Ampl Jy Top frame: Phas deg  
Vector averaged cross-power spectrum Baseline: EF (03) - TR (09)  
Timerange: 00/15:32:01 to 00/15:32:59

Plot file version 733 created 19-DEC-2018 17:59:02

VLA2 RY007C.UVDATA.1

Freq = 4.9270 GHz, Bw = 16.000 MH No calibration applied and no bandpass applied

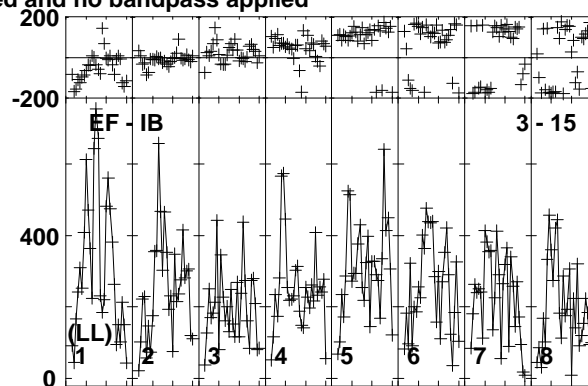
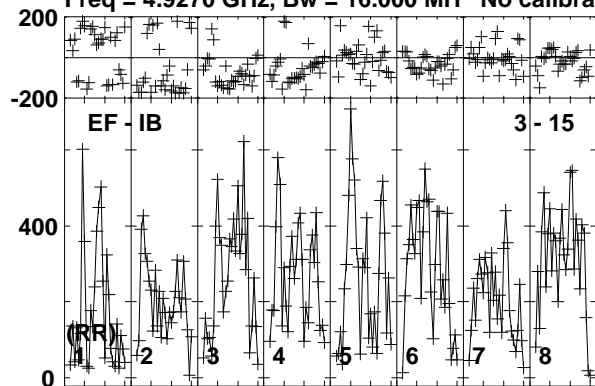

Lower frame: Micro Ampl Jy Top frame: Phas deg  
Vector averaged cross-power spectrum Baseline: EF (03) - IB (15)  
Timerange: 00/15:32:01 to 00/15:32:59

Plot file version 734 created 19-DEC-2018 17:59:02

J1619+2247 RY007C.UVDATA.1

Freq = 4.9270 GHz, Bw = 16.000 MH No calibration applied and no bandpass applied

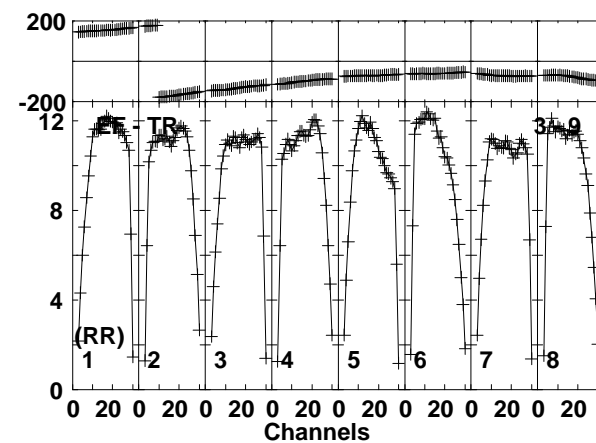
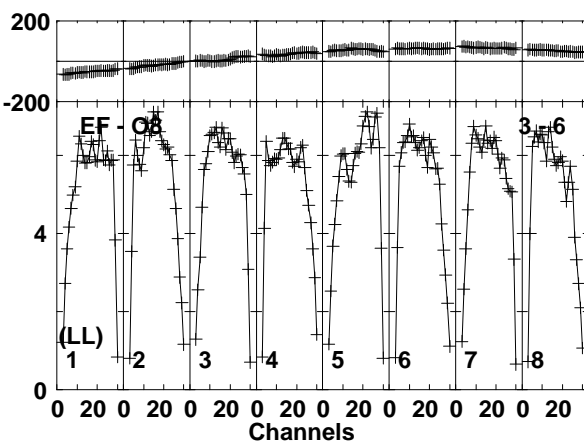
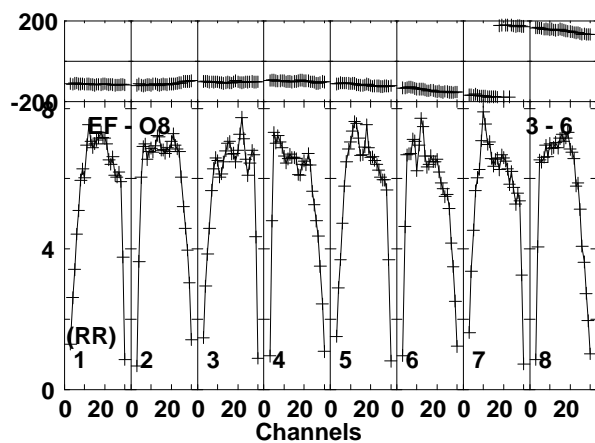
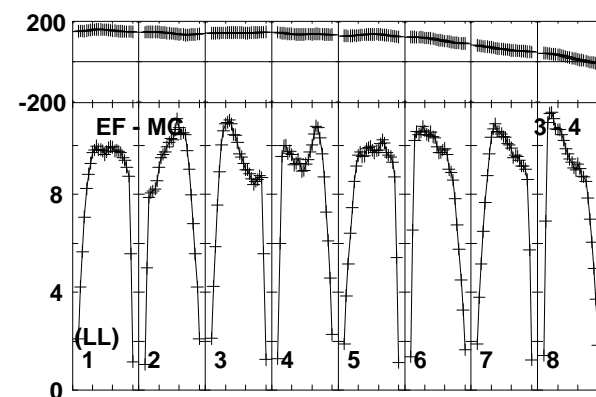
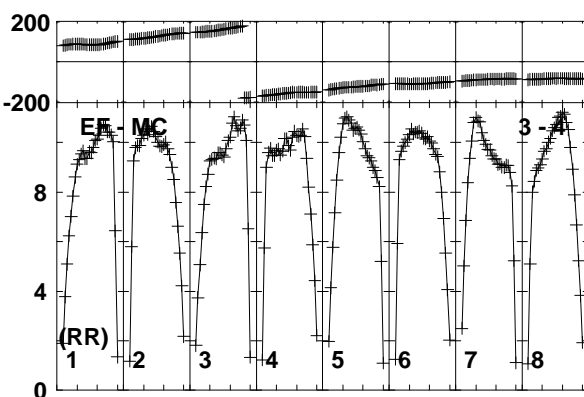
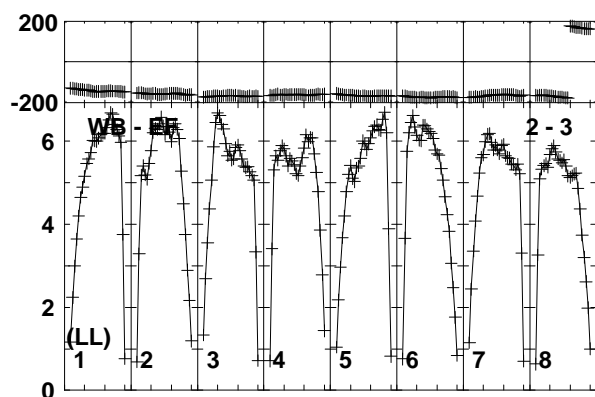
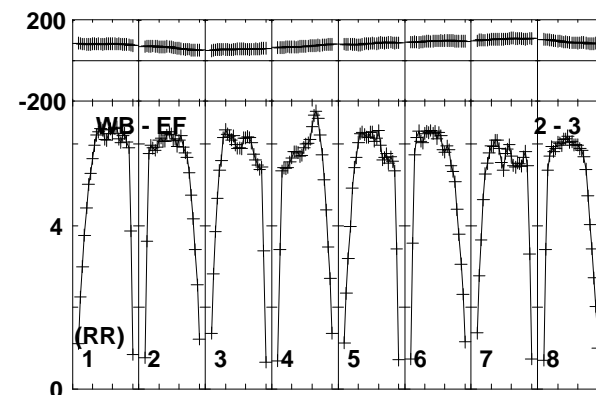
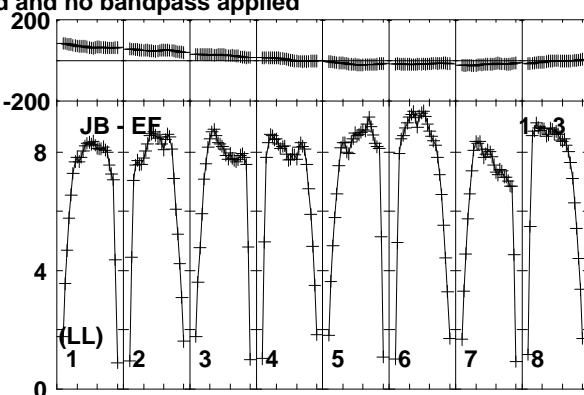
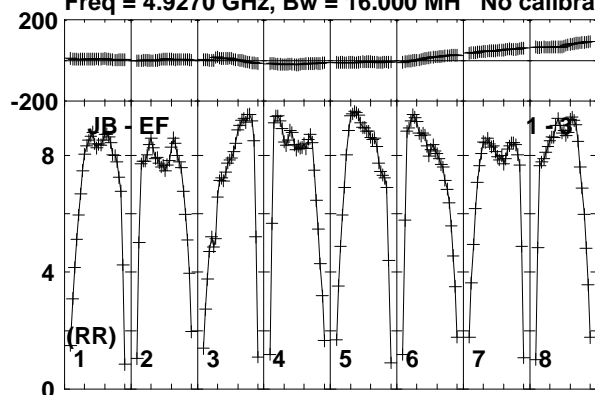

Lower frame: Milli Ampl Jy Top frame: Phas deg  
Vector averaged cross-power spectrum Baseline: JB (01) - EF (03)  
Timerange: 00/15:33:31 to 00/15:34:29

Plot file version 735 created 19-DEC-2018 17:59:02

J1619+2247 RY007C.UVDATA.1

Freq = 4.9270 GHz, Bw = 16.000 MH No calibration applied and no bandpass applied

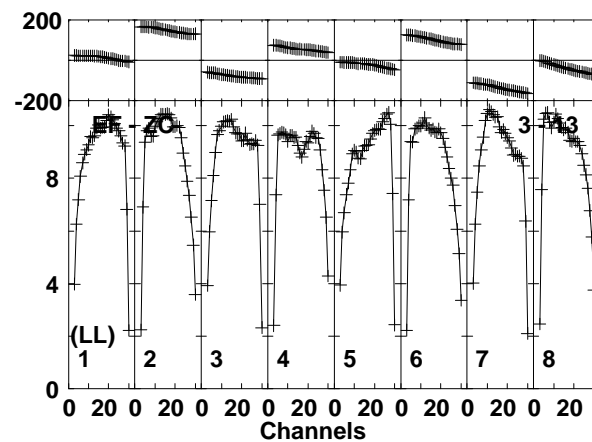
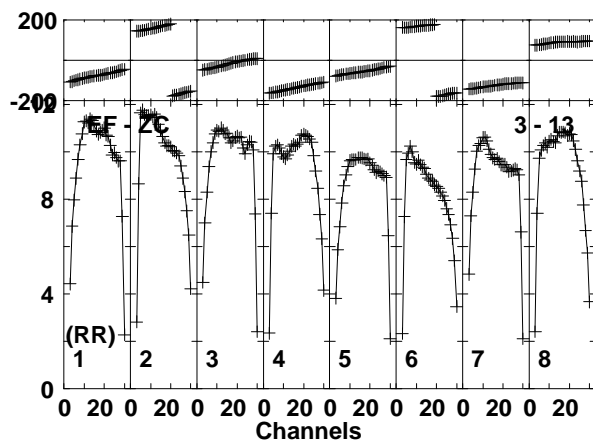
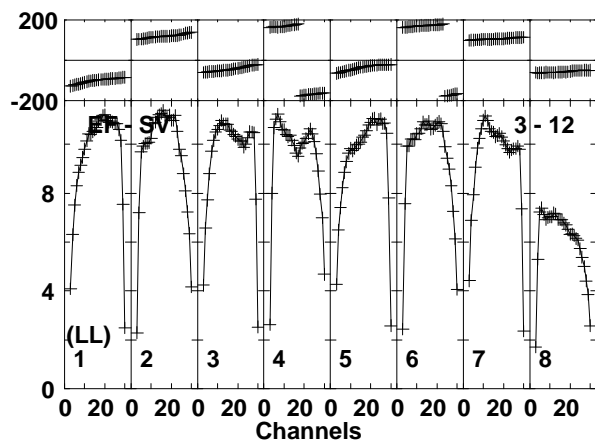
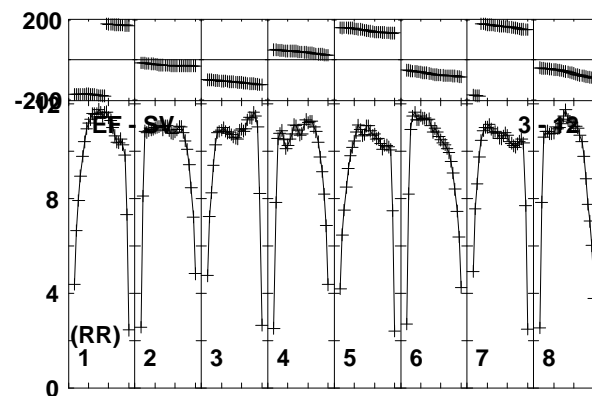
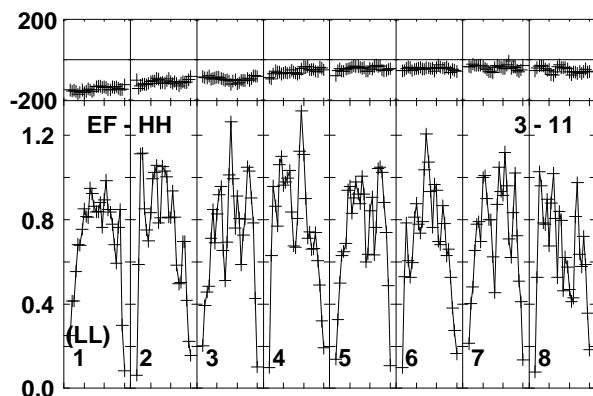
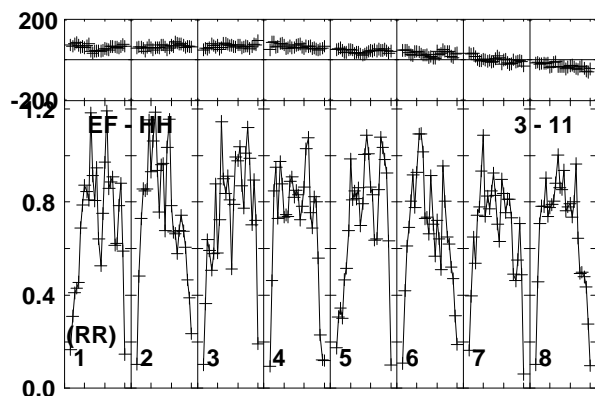
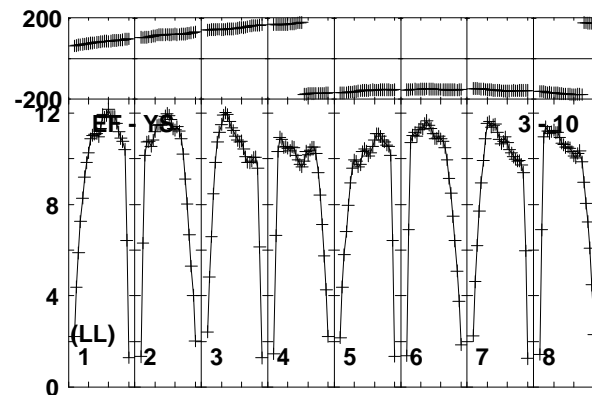
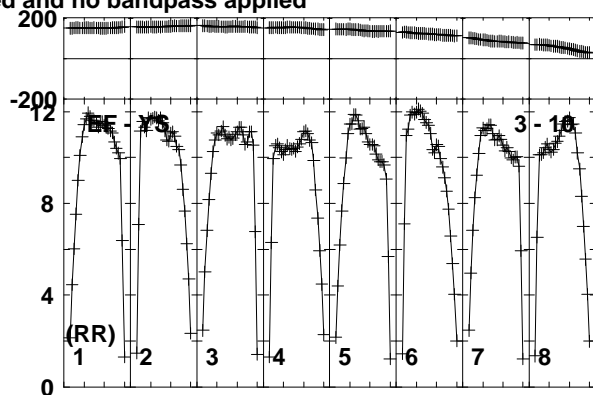
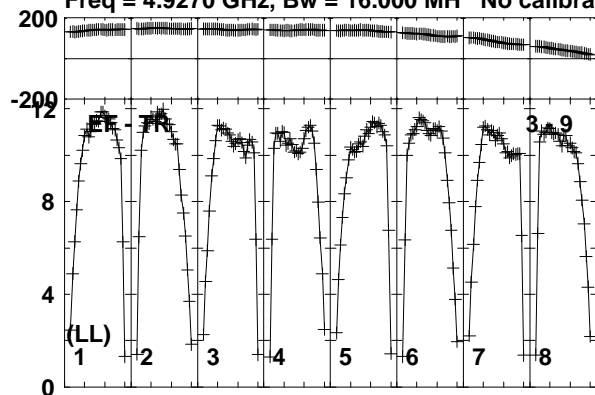

Lower frame: Milli Ampl Jy Top frame: Phas deg  
Vector averaged cross-power spectrum Baseline: EF (03) - TR (09)  
Timerange: 00/15:33:31 to 00/15:34:29

Plot file version 736 created 19-DEC-2018 17:59:03  
J1619+2247 RY007C.UVDATA.1

Freq = 4.9270 GHz, Bw = 16.000 MH No calibration applied and no bandpass applied

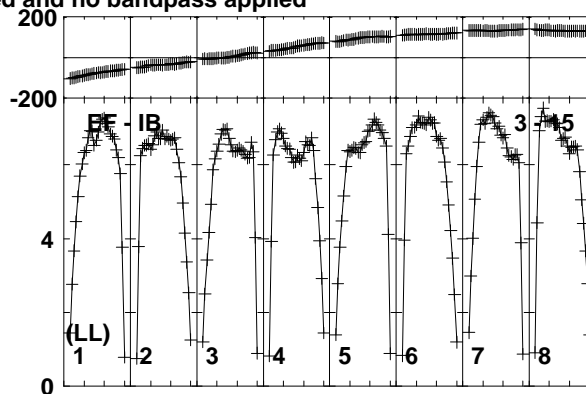
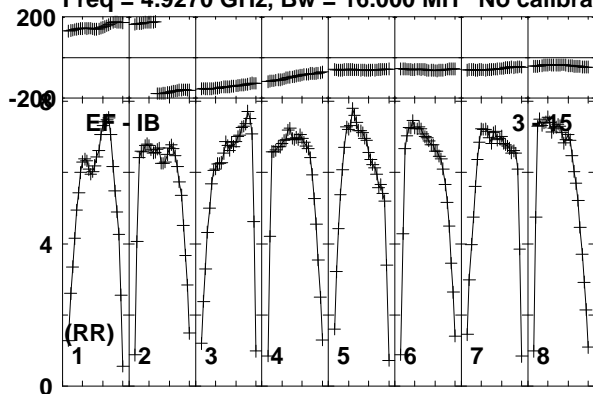

Lower frame: Milli Ampl Jy Top frame: Phas deg  
Vector averaged cross-power spectrum Baseline: EF (03) - IB (15)  
Timerange: 00/15:33:31 to 00/15:34:29

Plot file version 737 created 19-DEC-2018 17:59:03  
 AT2018\_RY007C.UVDATA.1

Freq = 4.9270 GHz, Bw = 16.000 MH No calibration applied and no bandpass applied

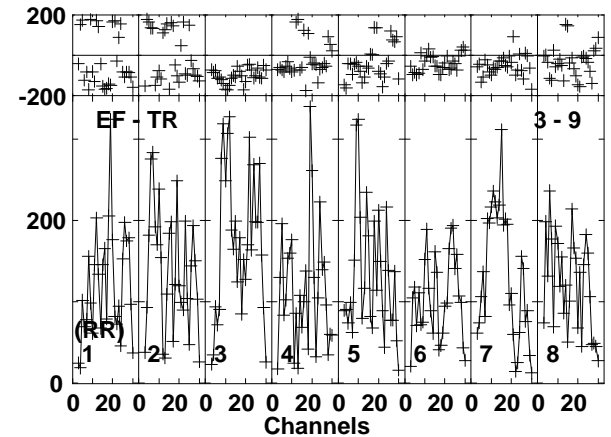
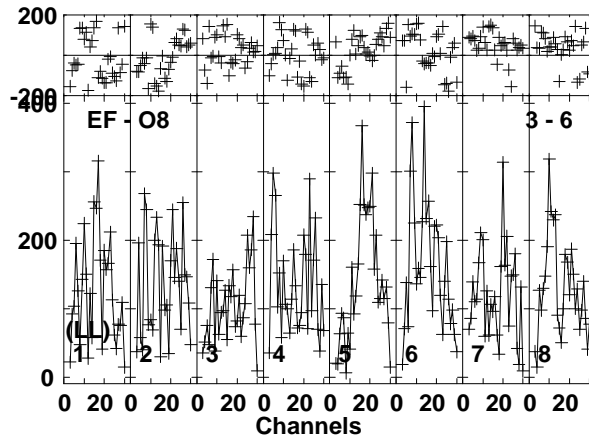
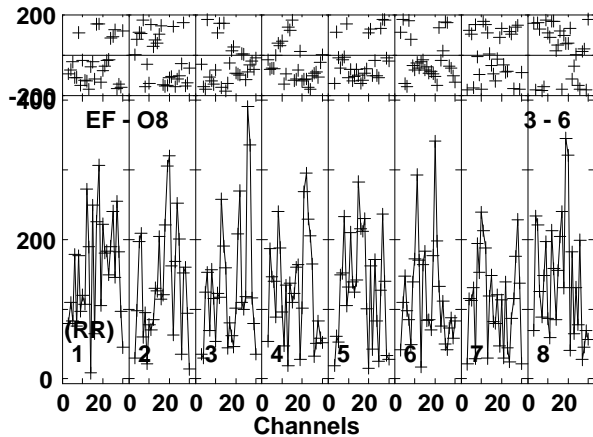
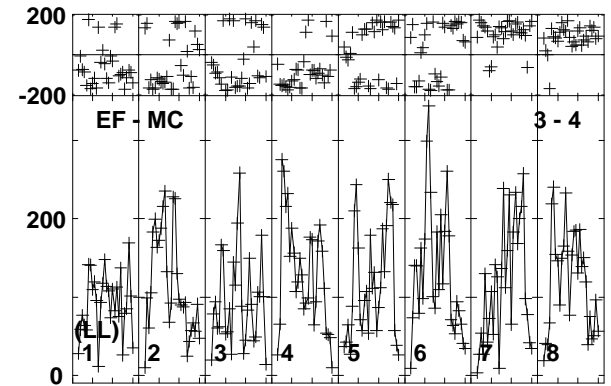
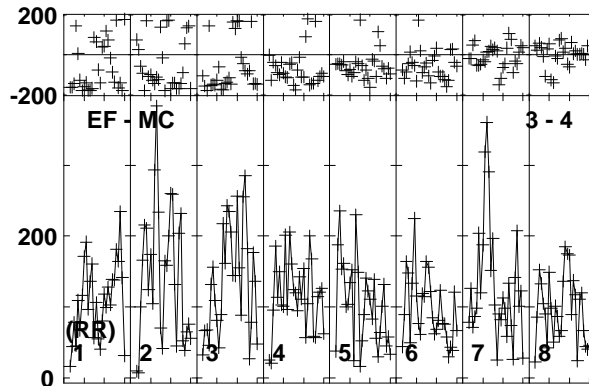
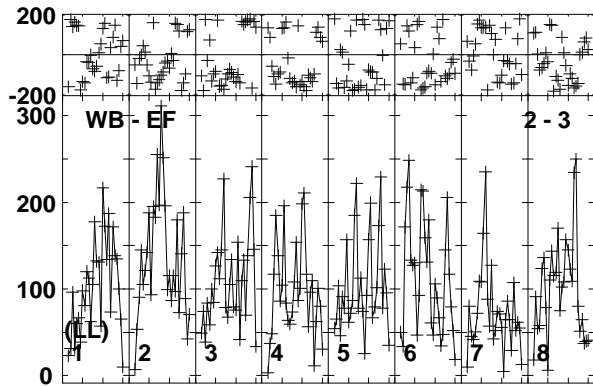
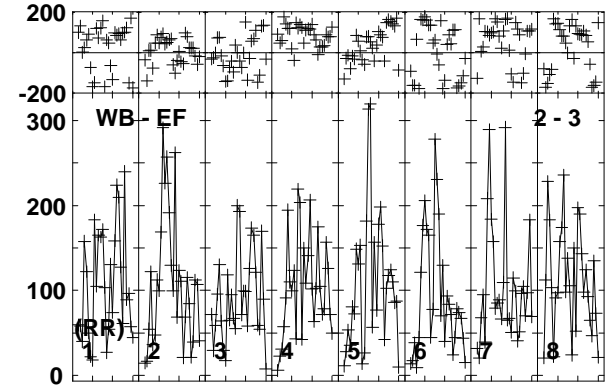
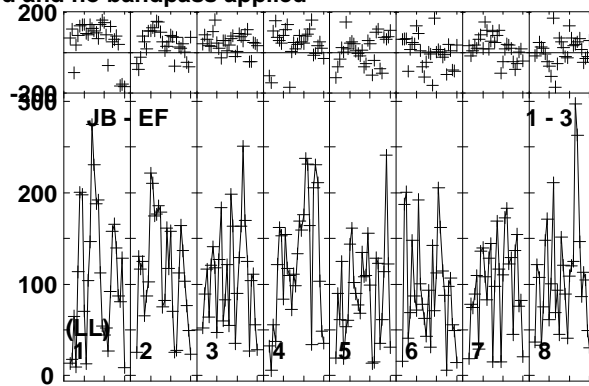
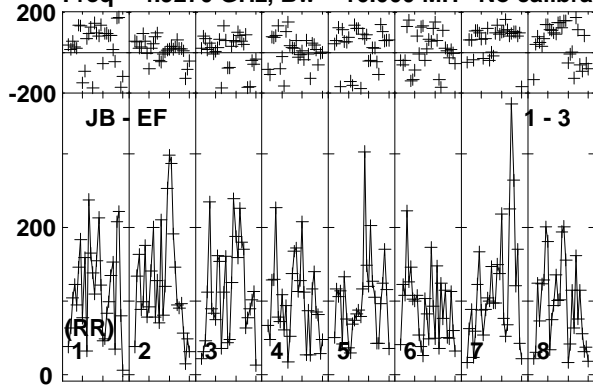

Lower frame: Micro Ampl Jy Top frame: Phas deg  
 Vector averaged cross-power spectrum Baseline: JB (01) - EF (03)  
 Timerange: 00/15:34:31 to 00/15:37:29

Plot file version 738 created 19-DEC-2018 17:59:03

AT2018\_RY007C.UVDATA.1

Freq = 4.9270 GHz, Bw = 16.000 MH No calibration applied and no bandpass applied

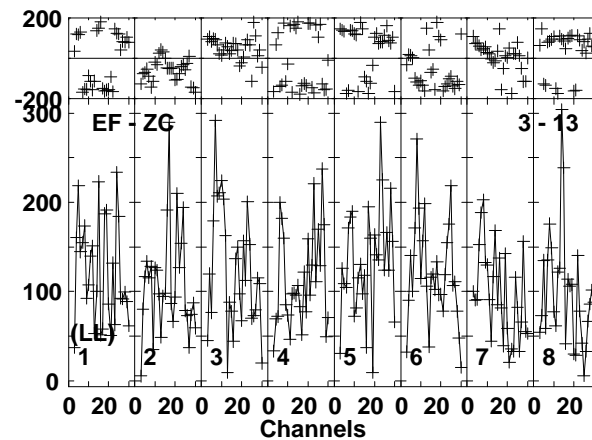
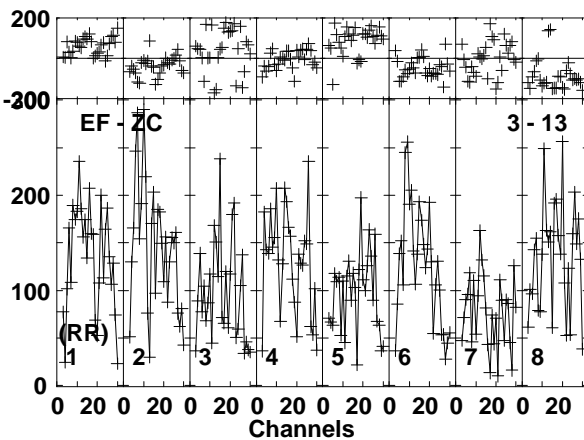
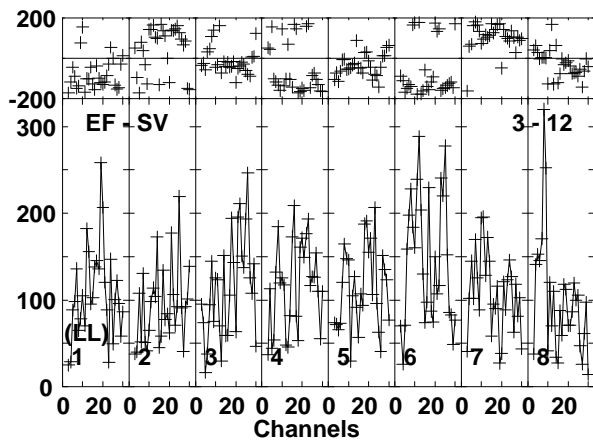
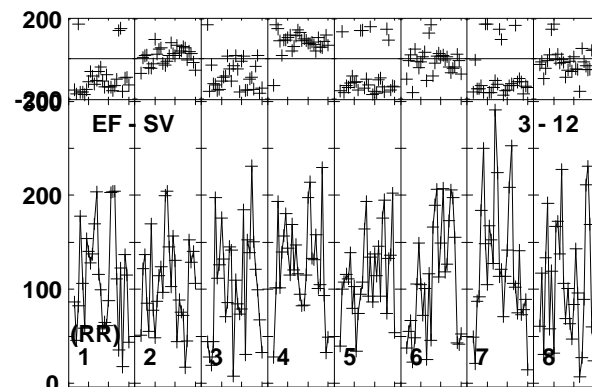
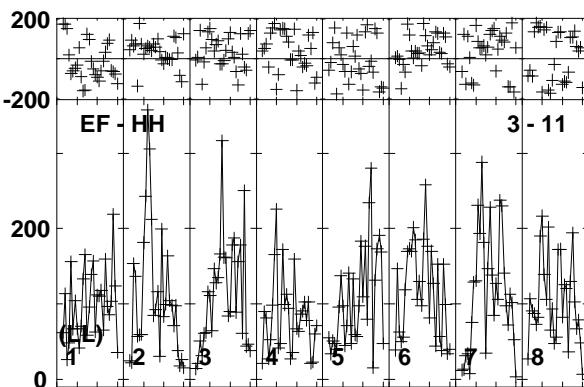
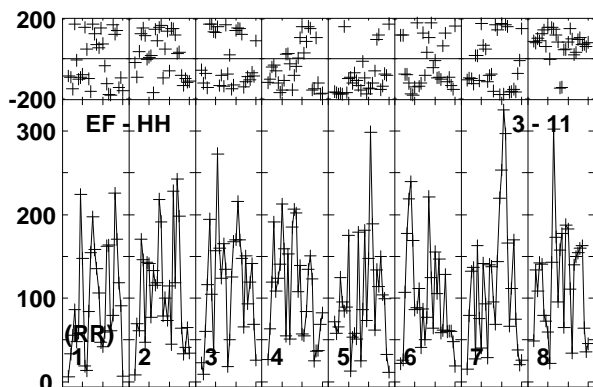
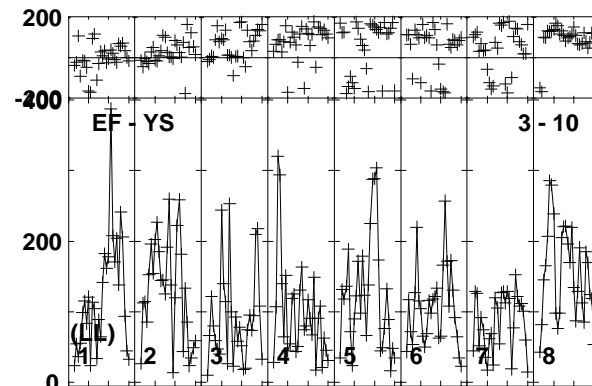
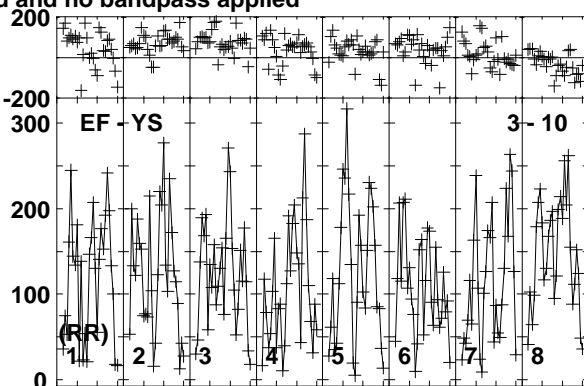
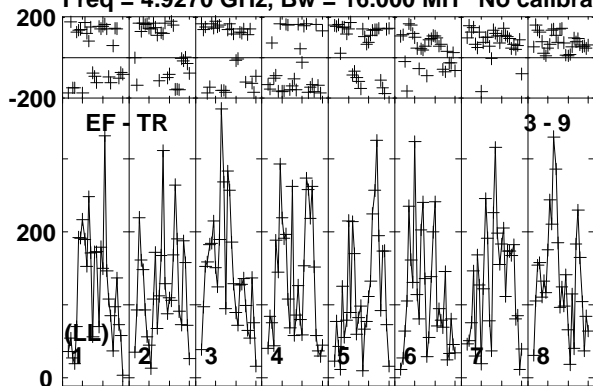

Lower frame: Micro Ampl Jy Top frame: Phas deg  
Vector averaged cross-power spectrum Baseline: EF (03) - TR (09)  
Timerange: 00/15:34:31 to 00/15:37:29



Plot file version 739 created 19-DEC-2018 17:59:03

AT2018\_RY007C.UVDATA.1

Freq = 4.9270 GHz, Bw = 16.000 MH No calibration applied and no bandpass applied

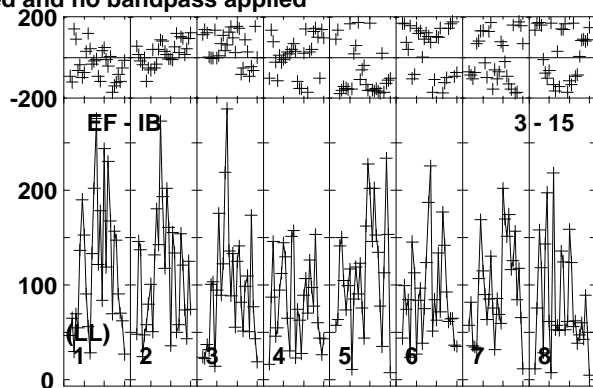
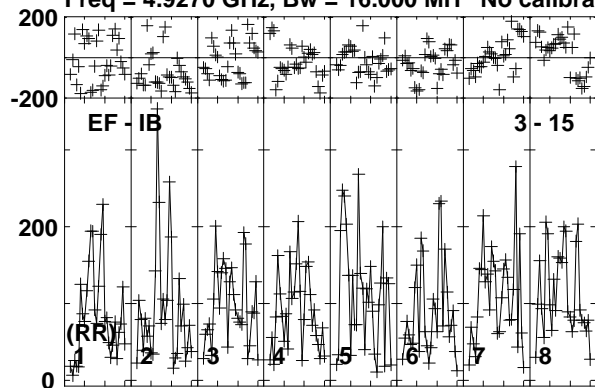

Lower frame: Micro Ampl Jy Top frame: Phas deg  
Vector averaged cross-power spectrum Baseline: EF (03) - IB (15)  
Timerange: 00/15:34:31 to 00/15:37:29

Plot file version 740 created 19-DEC-2018 17:59:03

J1619+2247 RY007C.UVDATA.1

Freq = 4.9270 GHz, Bw = 16.000 MH No calibration applied and no bandpass applied

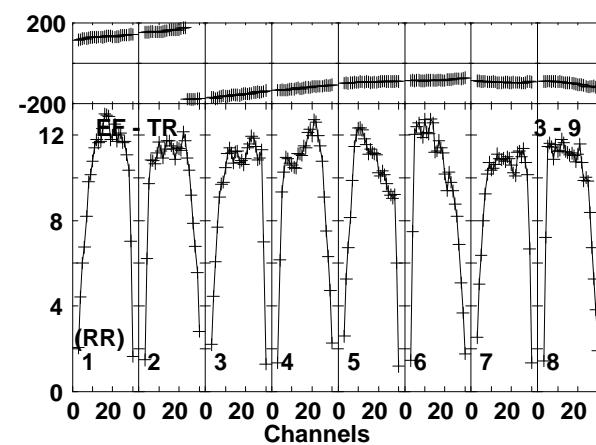
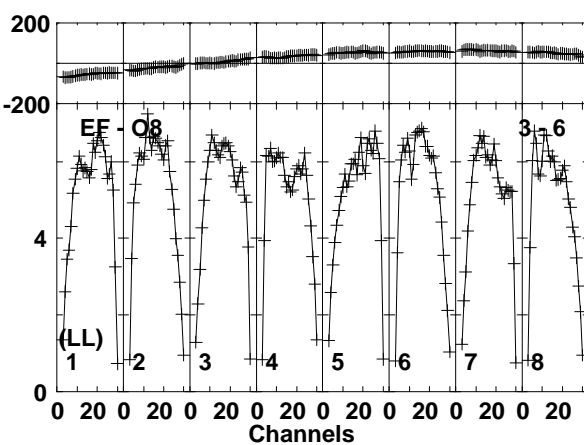
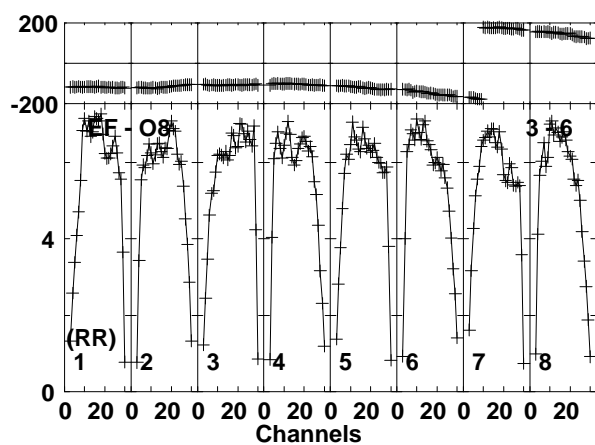
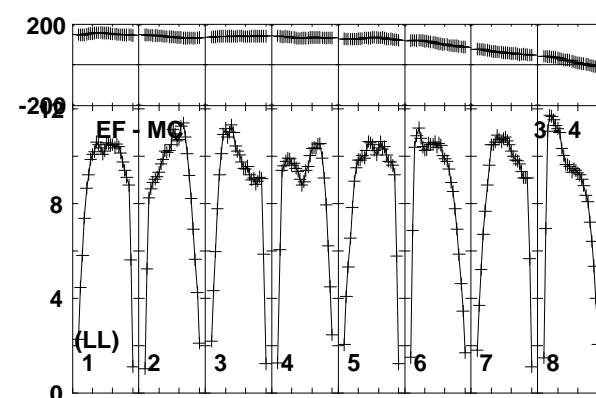
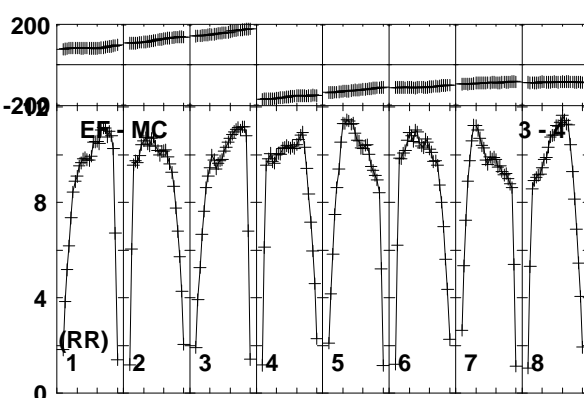
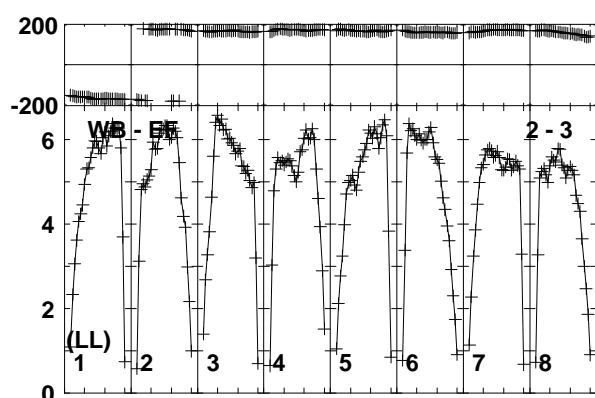
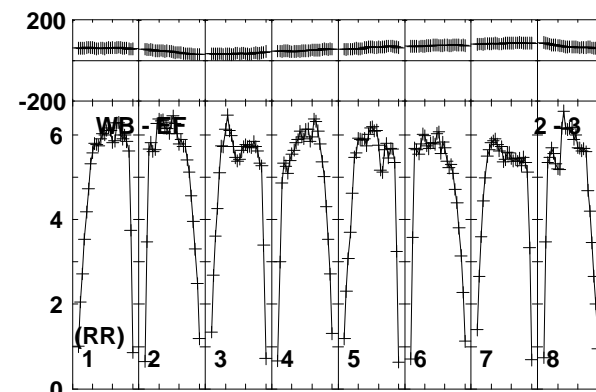
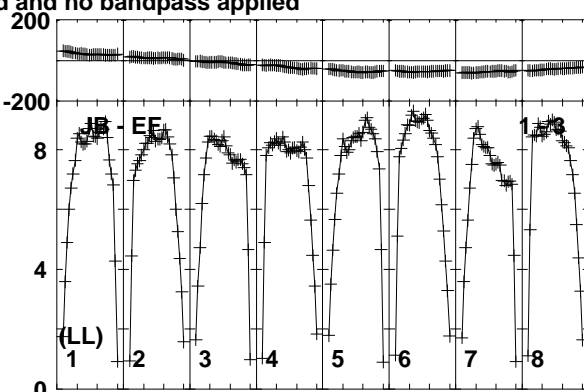
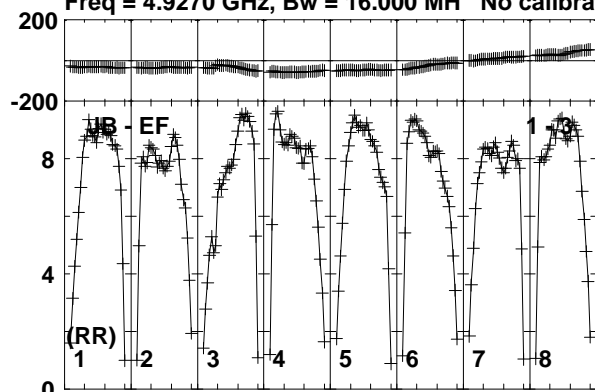

Lower frame: Milli Ampl Jy Top frame: Phas deg  
Vector averaged cross-power spectrum Baseline: JB (01) - EF (03)  
Timerange: 00/15:37:31 to 00/15:38:29

Plot file version 741 created 19-DEC-2018 17:59:03

J1619+2247 RY007C.UVDATA.1

Freq = 4.9270 GHz, Bw = 16.000 MH No calibration applied and no bandpass applied

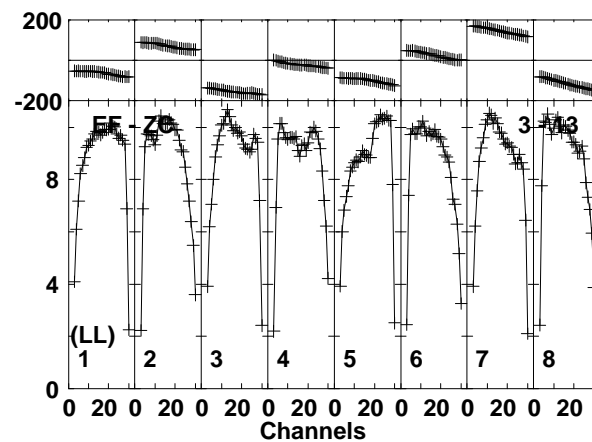
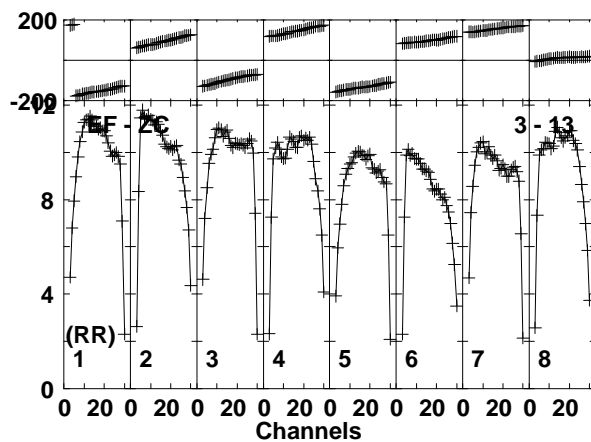
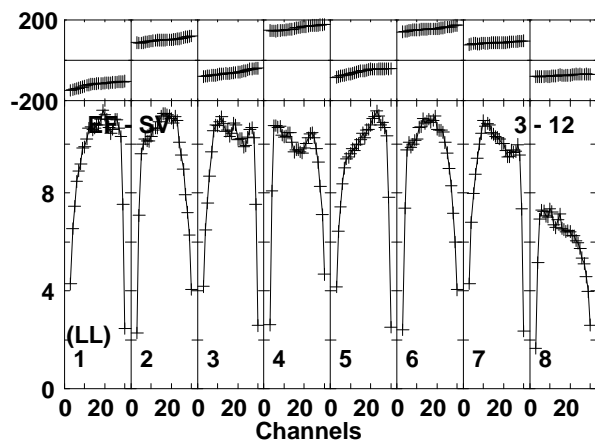
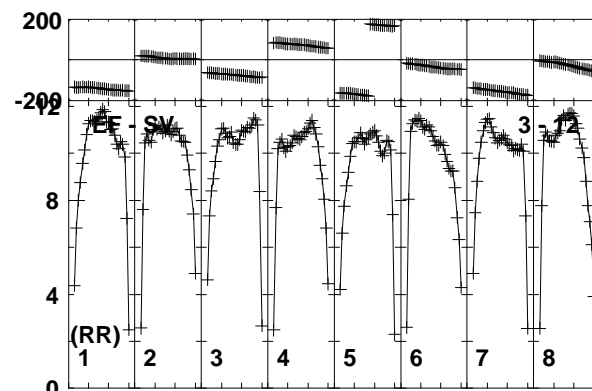
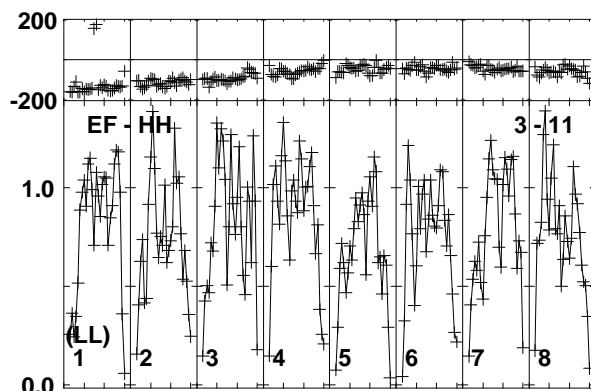
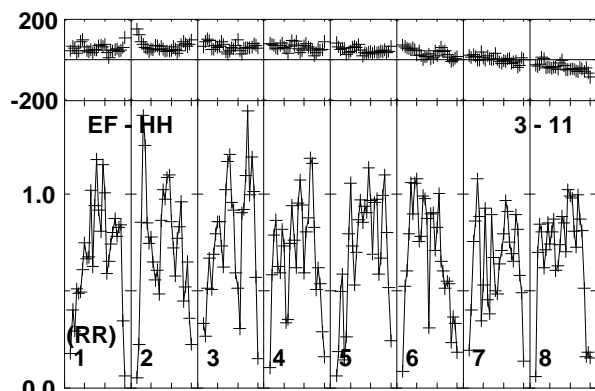
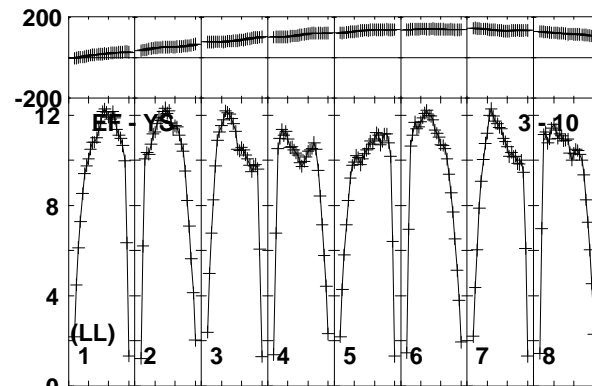
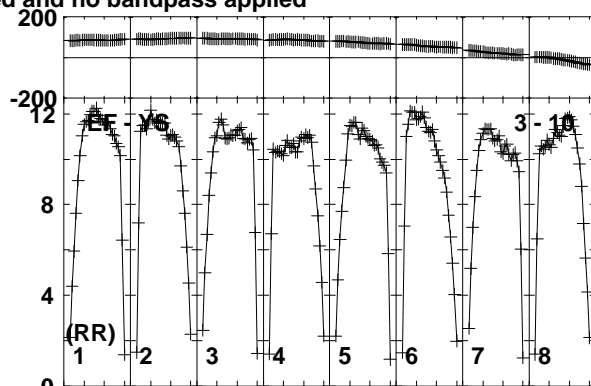
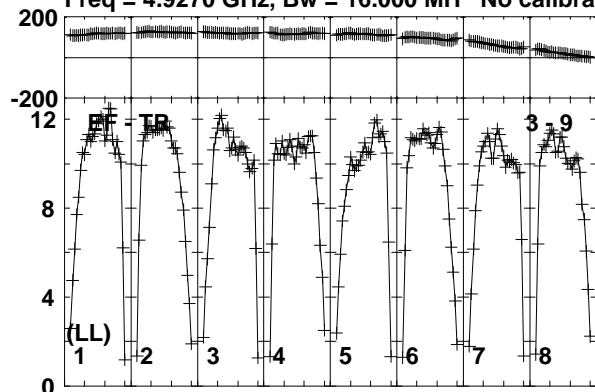

Lower frame: Milli Amp Jy Top frame: Phas deg  
Vector averaged cross-power spectrum Baseline: EF (03) - TR (09)  
Timerange: 00/15:37:31 to 00/15:38:29

Plot file version 742 created 19-DEC-2018 17:59:03  
J1619+2247 RY007C.UVDATA.1

Freq = 4.9270 GHz, Bw = 16.000 MH No calibration applied and no bandpass applied

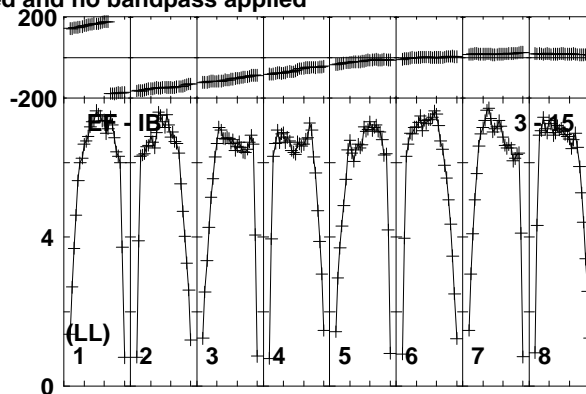
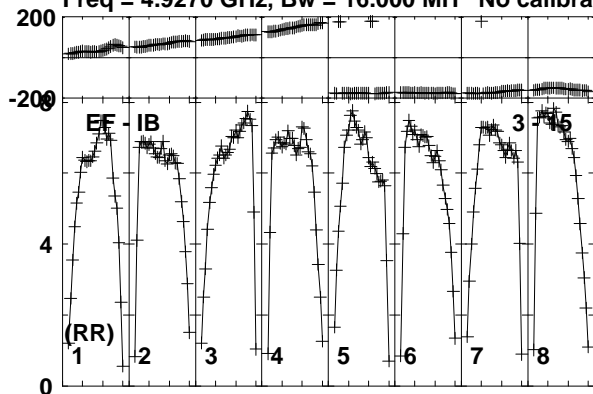

Lower frame: Milli Ampl Jy Top frame: Phas deg  
Vector averaged cross-power spectrum Baseline: EF (03) - IB (15)  
Timerange: 00/15:37:31 to 00/15:38:29

Plot file version 743 created 19-DEC-2018 17:59:03

AT2018\_RY007C.UVDATA.1

Freq = 4.9270 GHz, Bw = 16.000 MH No calibration applied and no bandpass applied

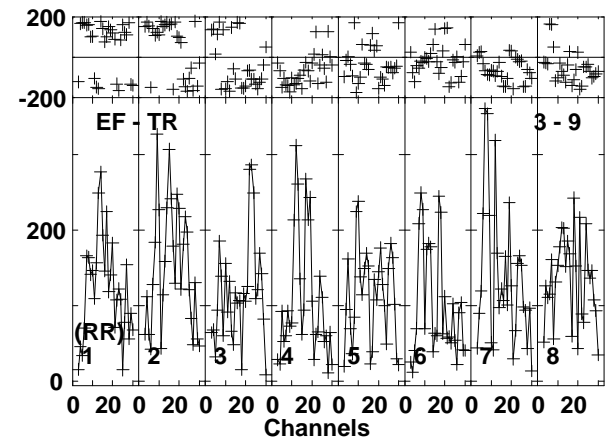
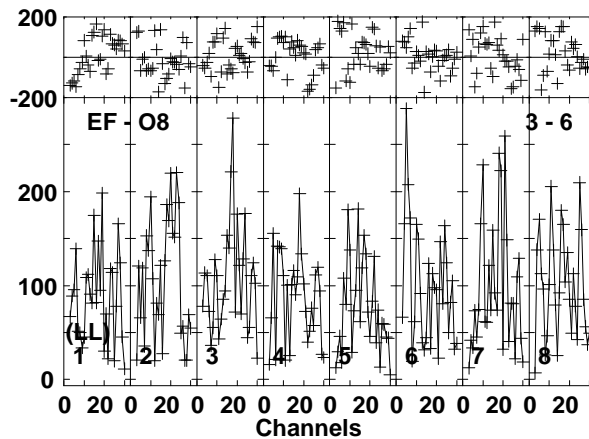
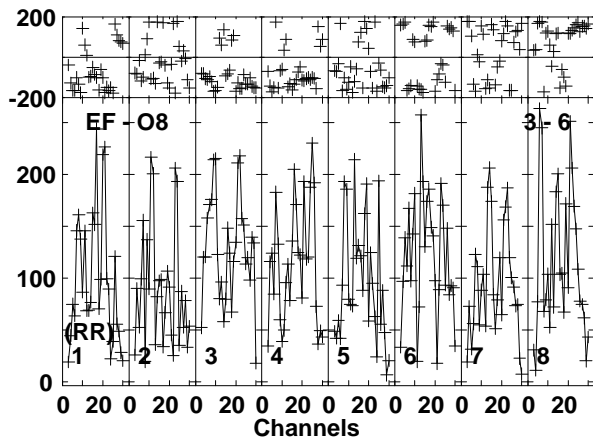
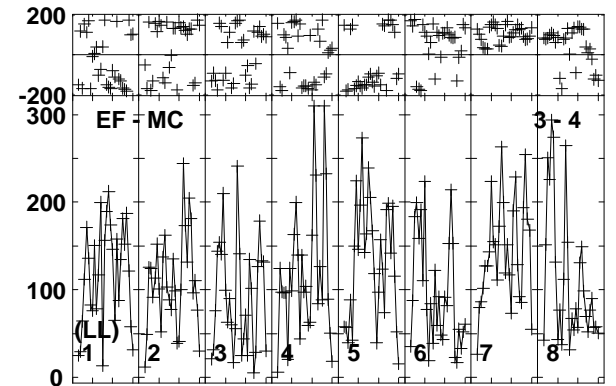
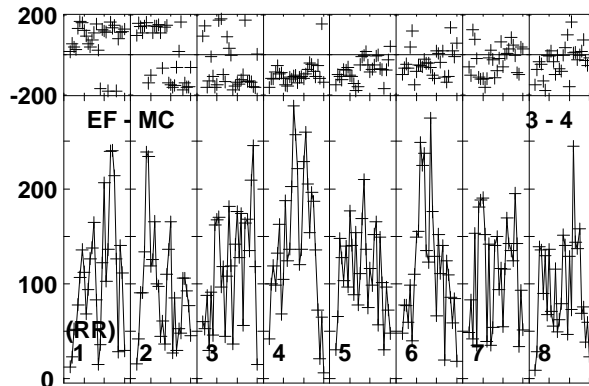
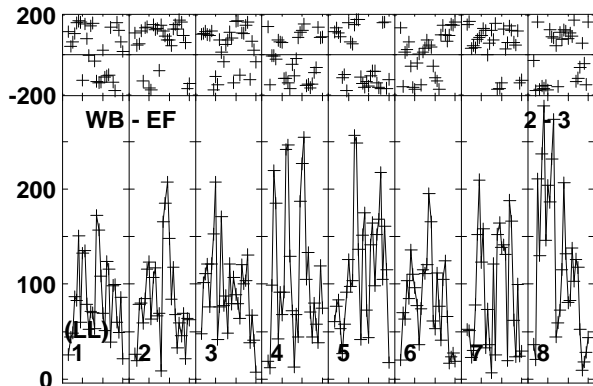
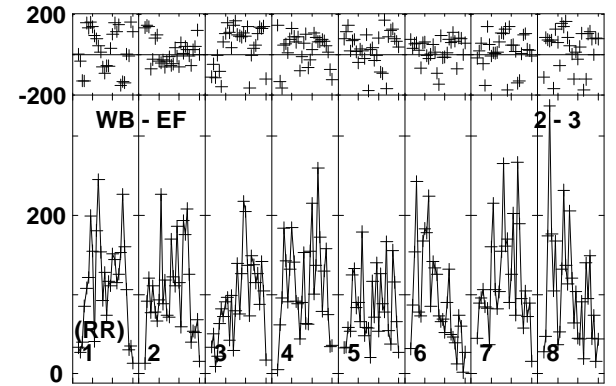
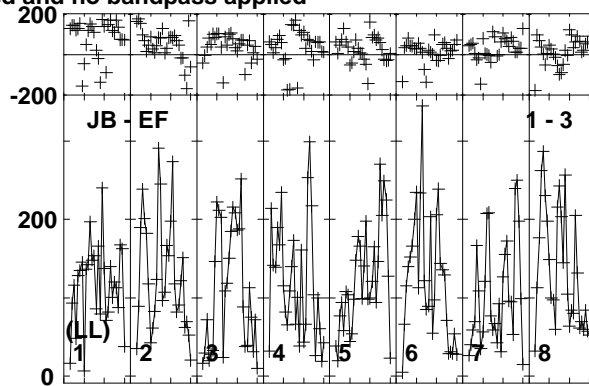
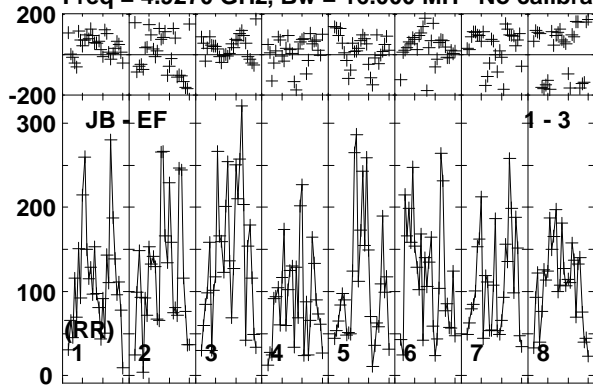

Lower frame: Micro Ampl Jy Top frame: Phas deg  
Vector averaged cross-power spectrum Baseline: JB (01) - EF (03)  
Timerange: 00/15:38:31 to 00/15:41:29

Plot file version 744 created 19-DEC-2018 17:59:03

AT2018\_RY007C.UVDATA.1

Freq = 4.9270 GHz, Bw = 16.000 MH No calibration applied and no bandpass applied

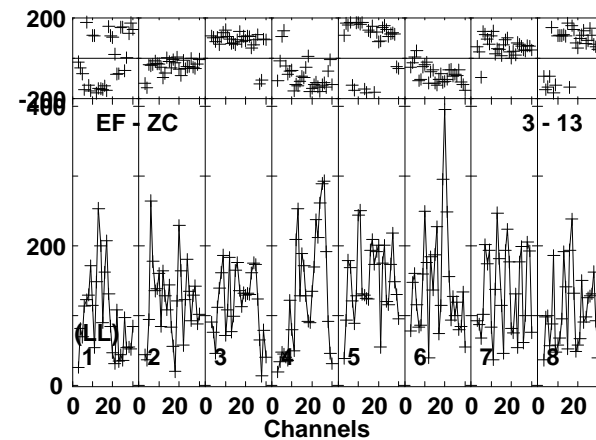
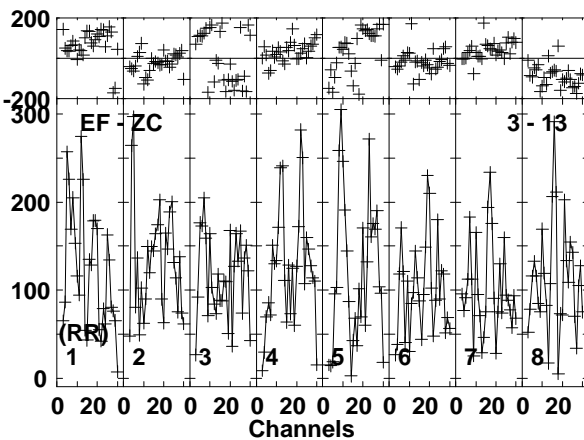
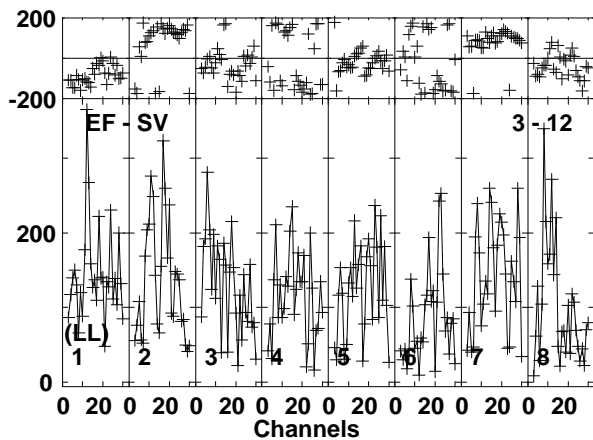
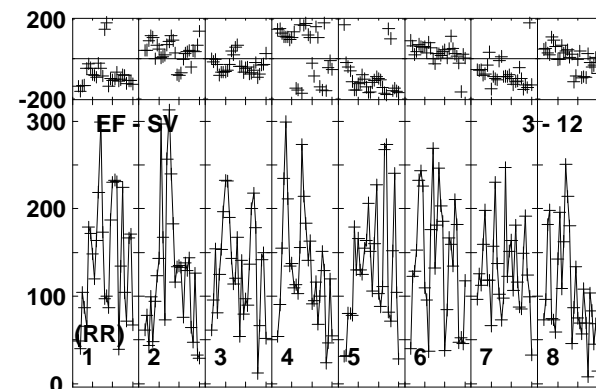
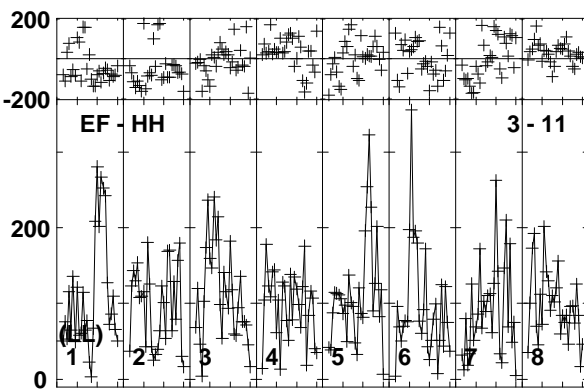
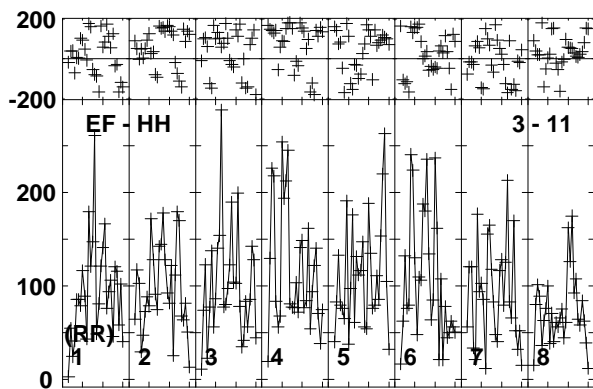
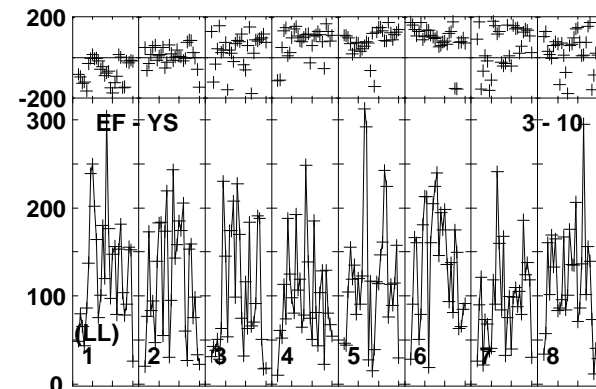
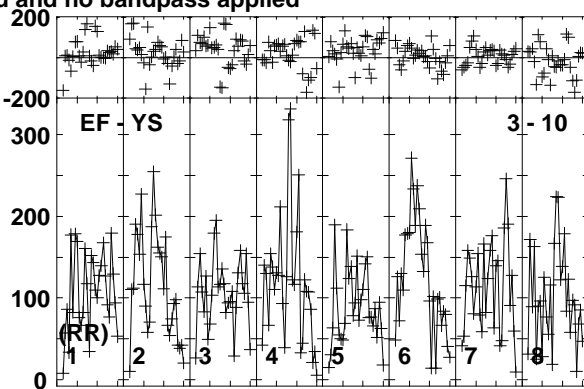
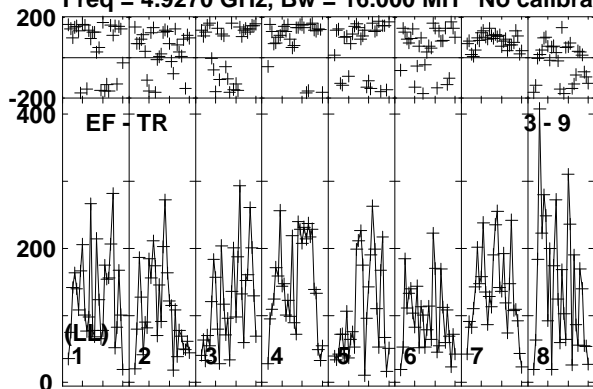

Lower frame: Micro Ampl Jy Top frame: Phas deg  
Vector averaged cross-power spectrum Baseline: EF (03) - TR (09)  
Timerange: 00/15:38:31 to 00/15:41:29

Plot file version 745 created 19-DEC-2018 17:59:03

AT2018\_RY007C.UVDATA.1

Freq = 4.9270 GHz, Bw = 16.000 MH No calibration applied and no bandpass applied

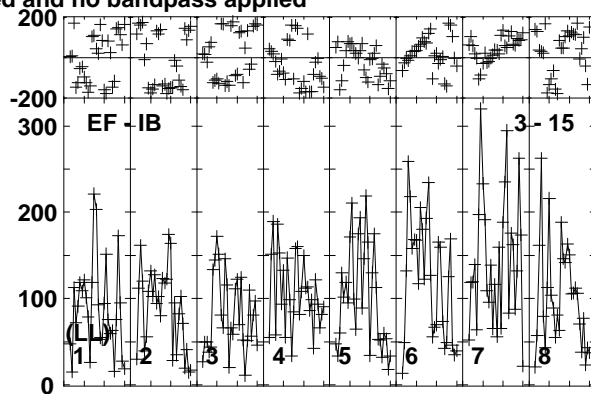
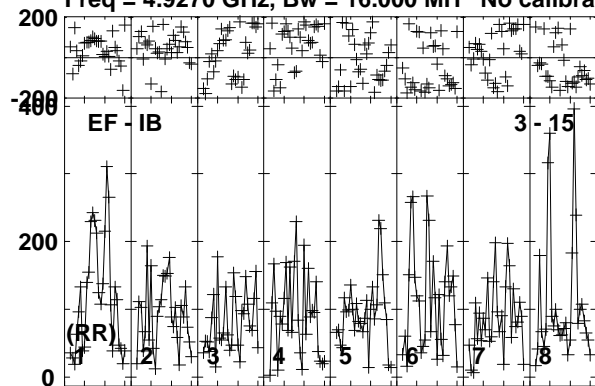

Lower frame: Micro Ampl Jy Top frame: Phas deg  
Vector averaged cross-power spectrum Baseline: EF (03) - IB (15)  
Timerange: 00/15:38:31 to 00/15:41:29

Plot file version 746 created 19-DEC-2018 17:59:03

J1619+2247 RY007C.UVDATA.1

Freq = 4.9270 GHz, Bw = 16.000 MH No calibration applied and no bandpass applied

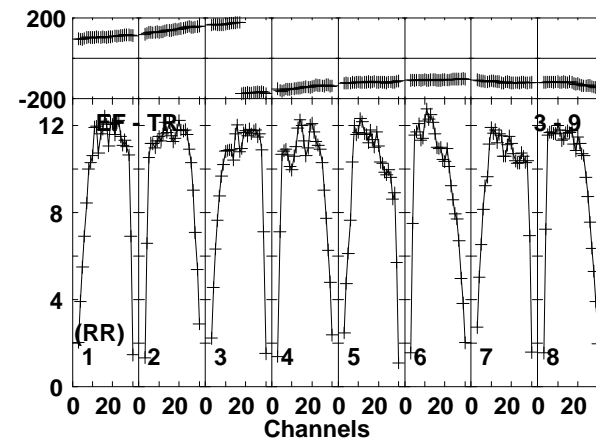
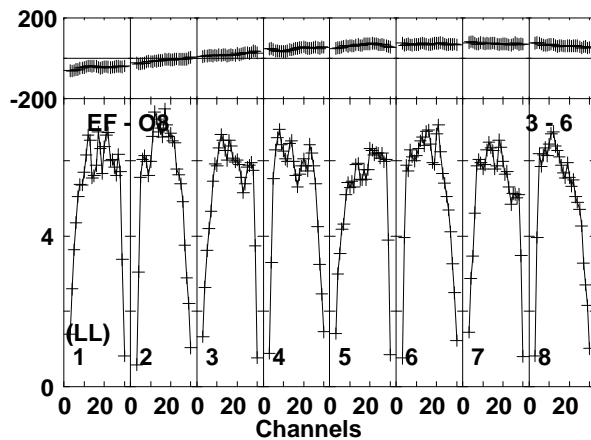
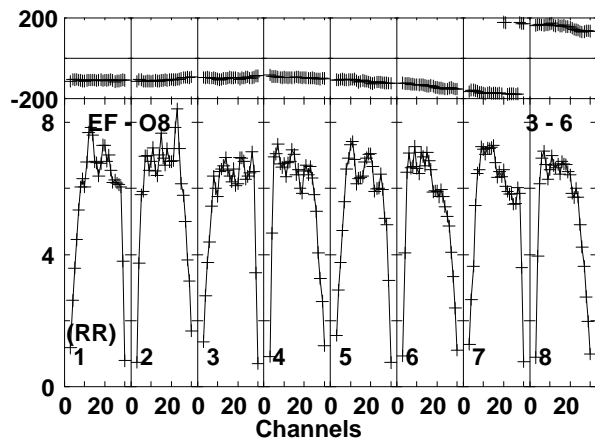
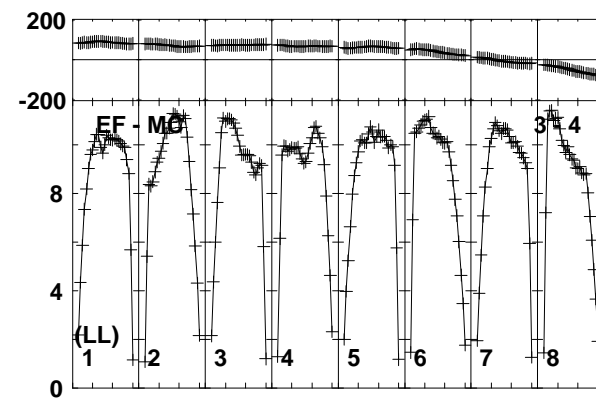
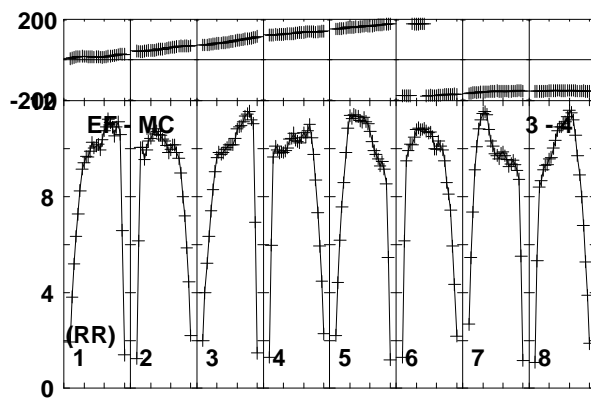
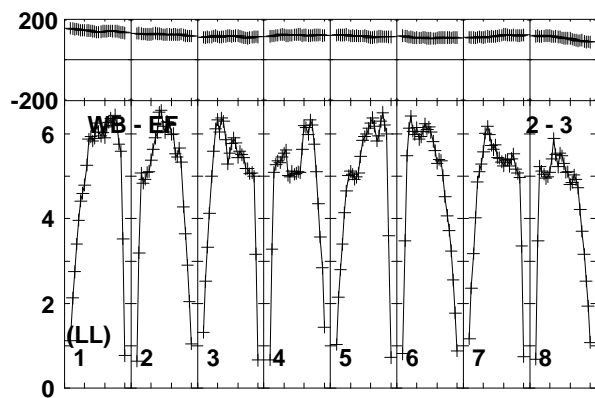
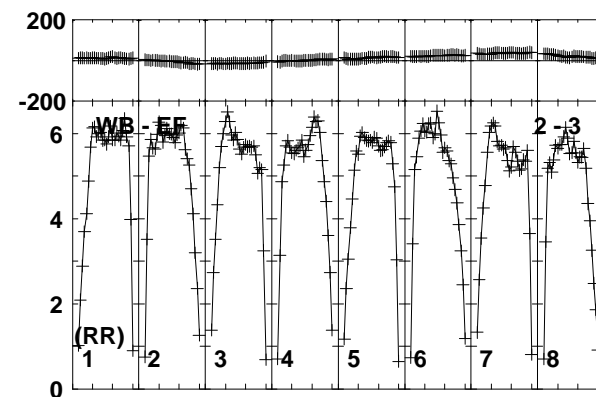
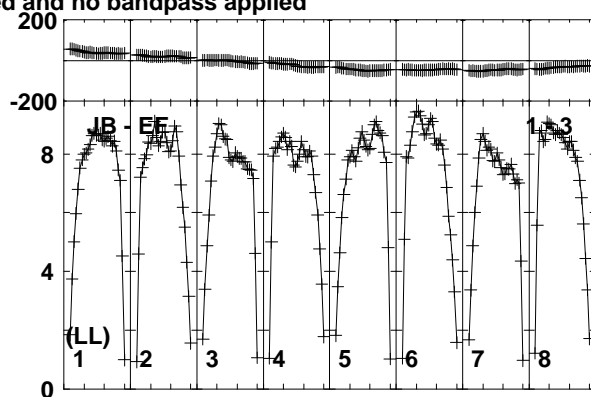
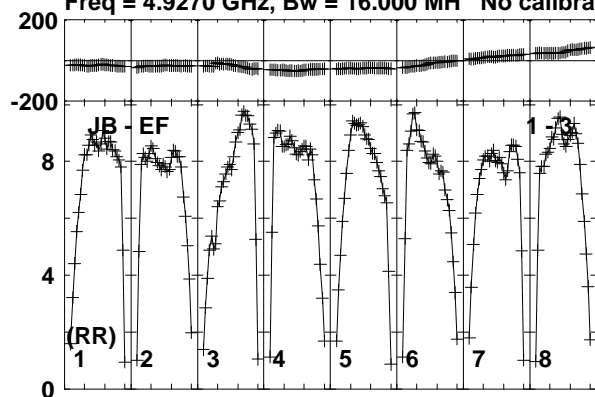

Lower frame: Milli Ampl Jy Top frame: Phas deg  
Vector averaged cross-power spectrum Baseline: JB (01) - EF (03)  
Timerange: 00/15:41:31 to 00/15:42:29



Plot file version 747 created 19-DEC-2018 17:59:03

J1619+2247 RY007C.UVDATA.1

Freq = 4.9270 GHz, Bw = 16.000 MH No calibration applied and no bandpass applied

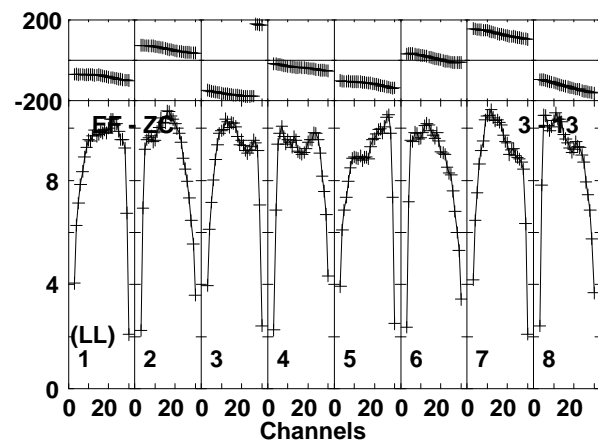
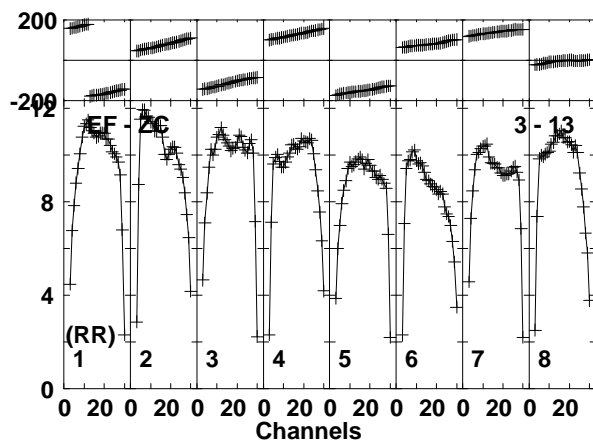
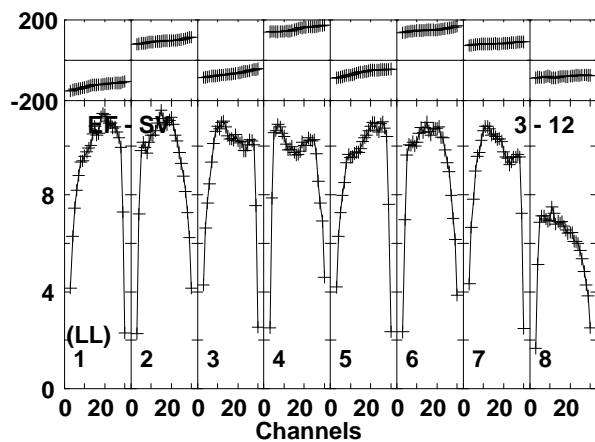
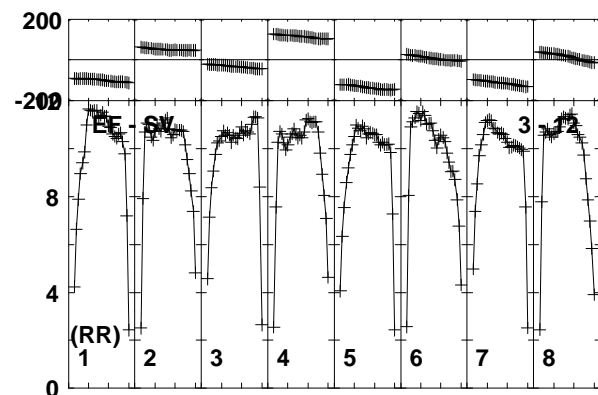
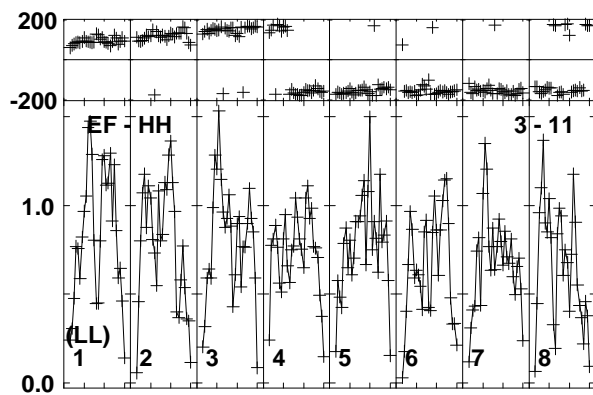
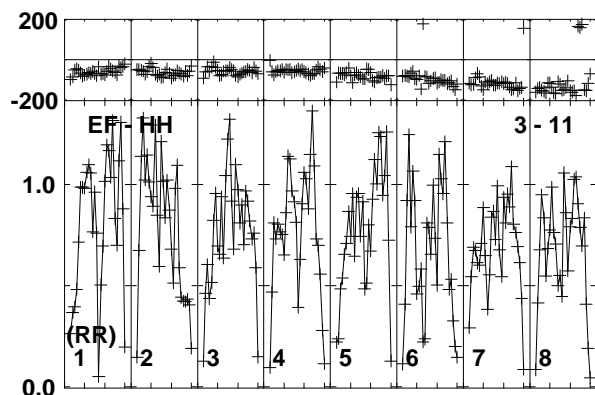
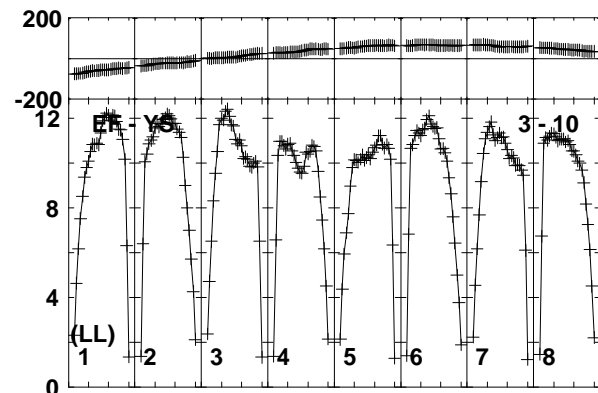
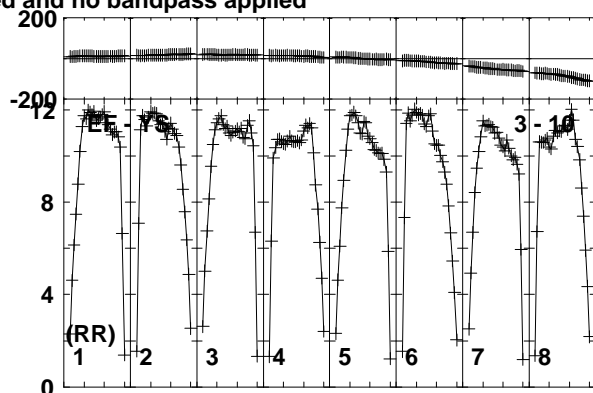
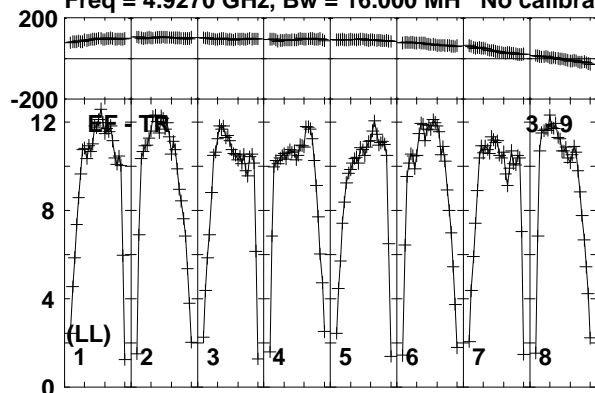

Lower frame: Milli Ampl Jy Top frame: Phas deg  
Vector averaged cross-power spectrum Baseline: EF (03) - TR (09)  
Timerange: 00/15:41:31 to 00/15:42:29

Plot file version 748 created 19-DEC-2018 17:59:03

J1619+2247 RY007C.UVDATA.1

Freq = 4.9270 GHz, Bw = 16.000 MH No calibration applied and no bandpass applied

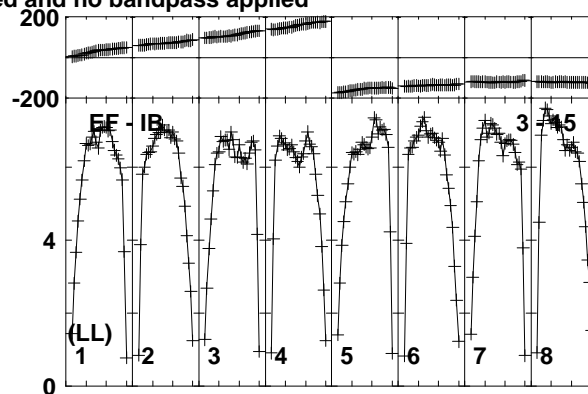
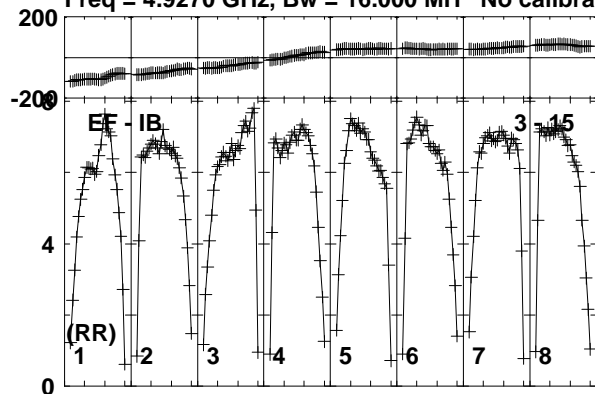

Lower frame: Milli Ampl Jy Top frame: Phas deg  
Vector averaged cross-power spectrum Baseline: EF (03) - IB (15)  
Timerange: 00/15:41:31 to 00/15:42:29

Plot file version 749 created 19-DEC-2018 17:59:03

VLA1 RY007C.UVDATA.1

Freq = 4.9270 GHz, Bw = 16.000 MH No calibration applied and no bandpass applied

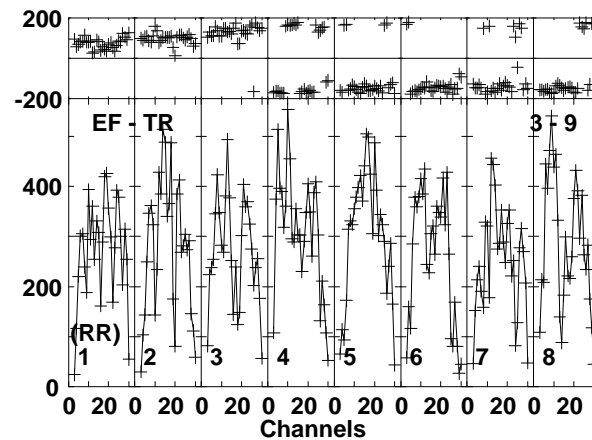
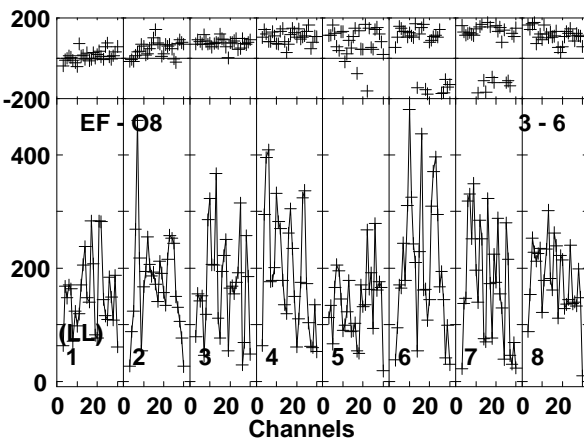
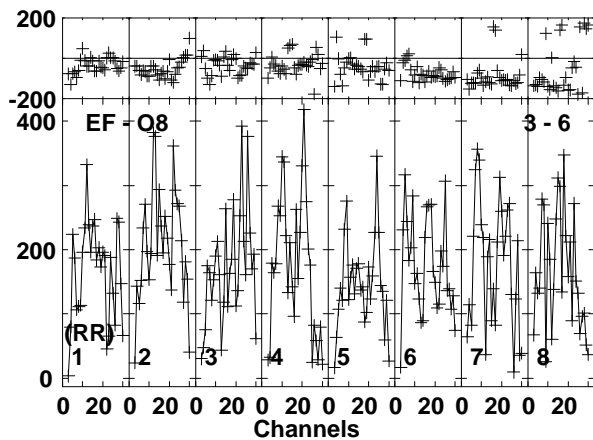
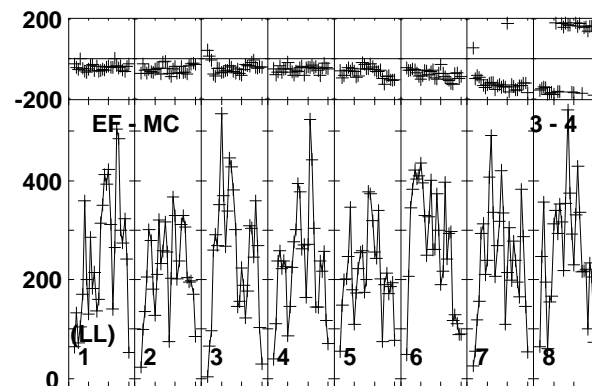
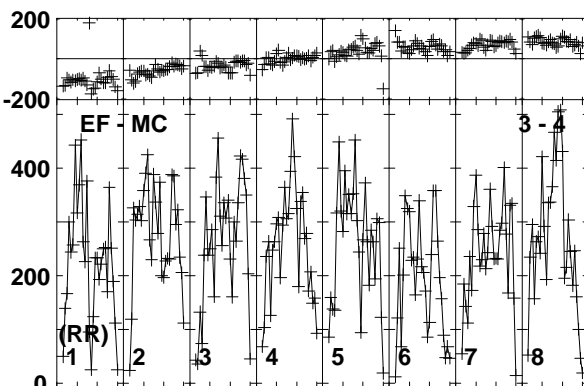
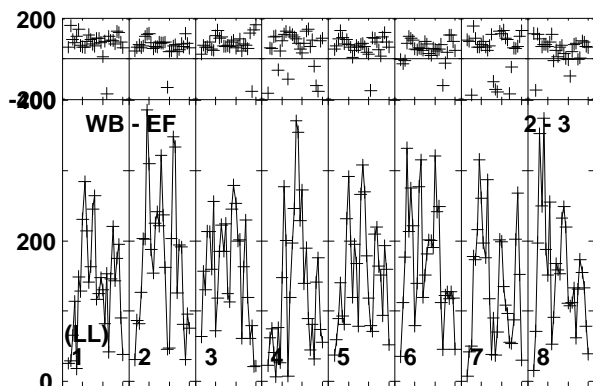
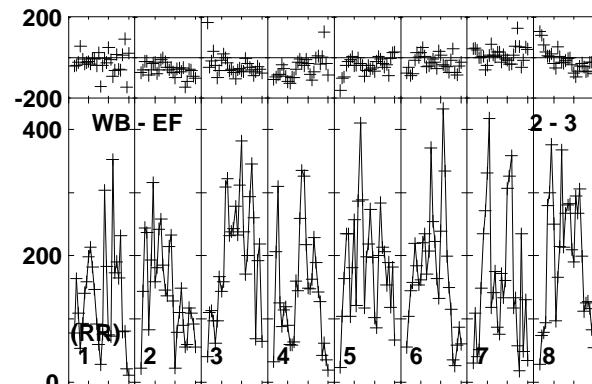
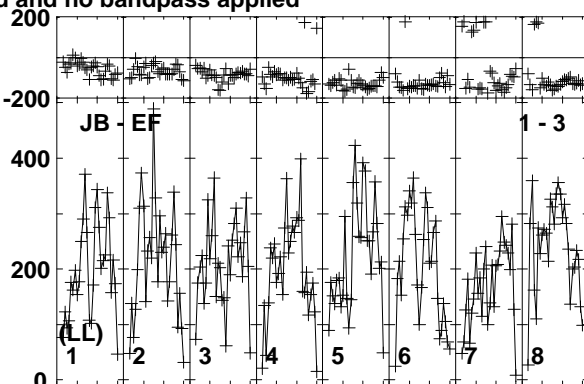
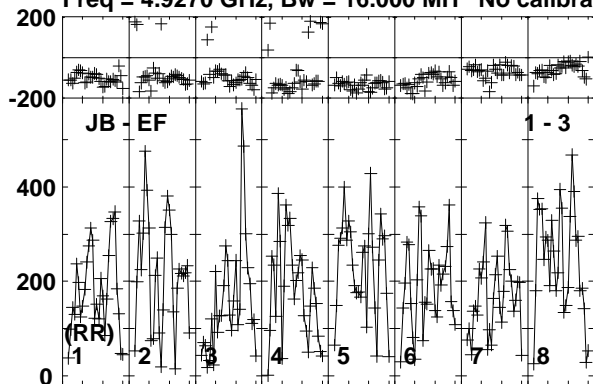

Lower frame: Micro Ampl Jy Top frame: Phas deg  
Vector averaged cross-power spectrum Baseline: JB (01) - EF (03)  
Timerange: 00/15:43:01 to 00/15:44:59

Plot file version 750 created 19-DEC-2018 17:59:03

VLA1 RY007C.UVDATA.1

Freq = 4.9270 GHz, Bw = 16.000 MH No calibration applied and no bandpass applied

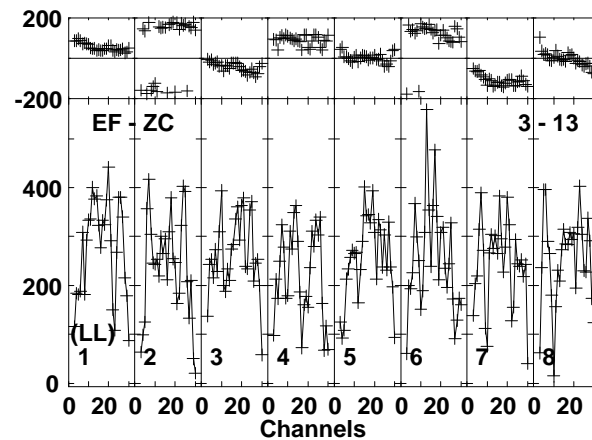
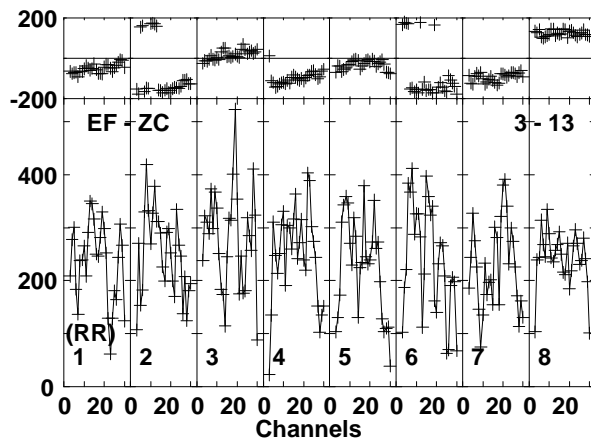
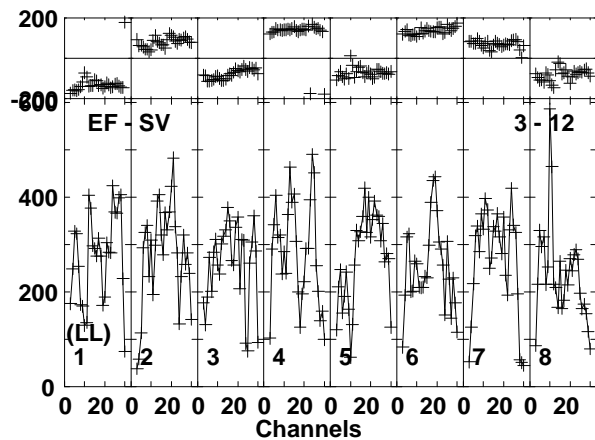
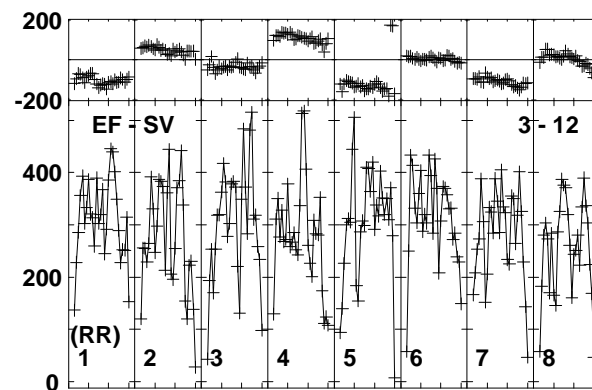
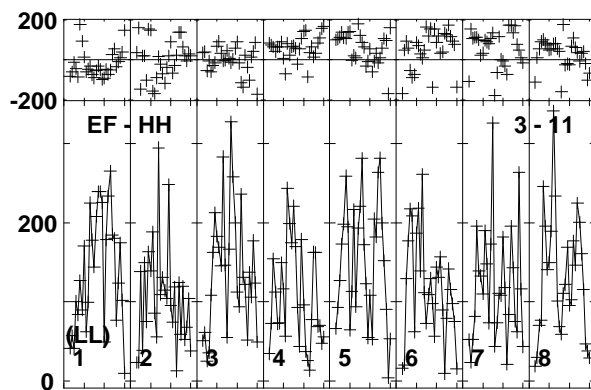
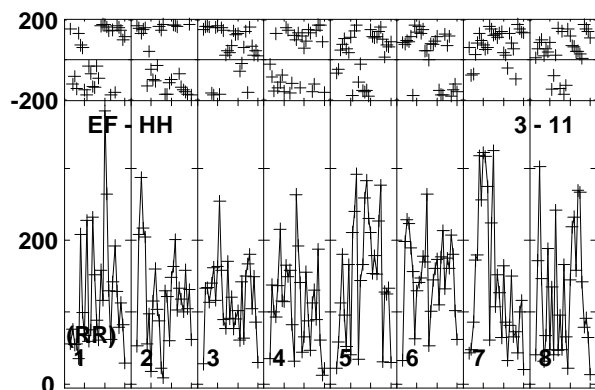
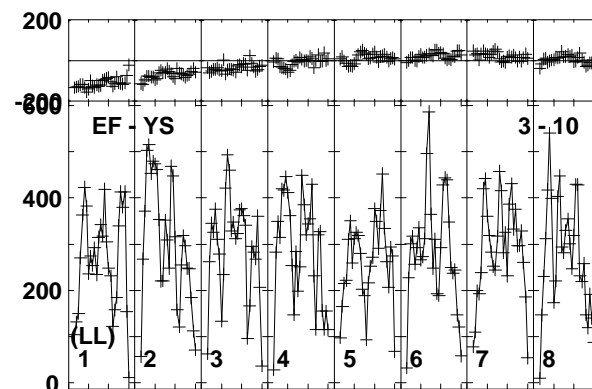
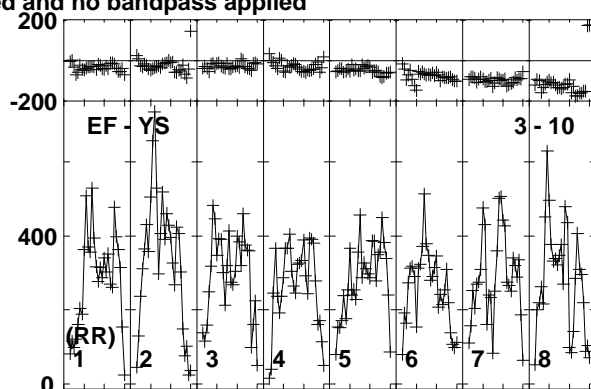
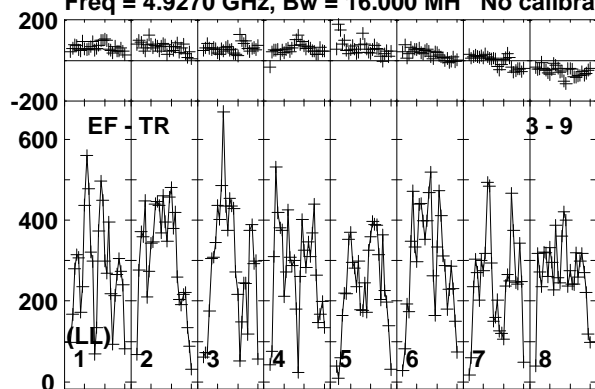

Lower frame: Micro Ampl Jy Top frame: Phas deg  
Vector averaged cross-power spectrum Baseline: EF (03) - TR (09)  
Timerange: 00:15:43:01 to 00:15:44:59

Plot file version 751 created 19-DEC-2018 17:59:03

VLA1 RY007C.UVDATA.1

Freq = 4.9270 GHz, Bw = 16.000 MH No calibration applied and no bandpass applied

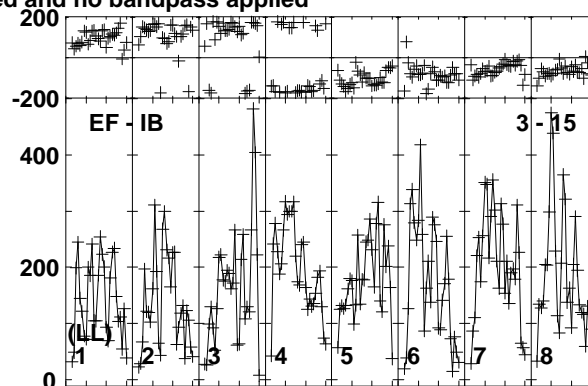
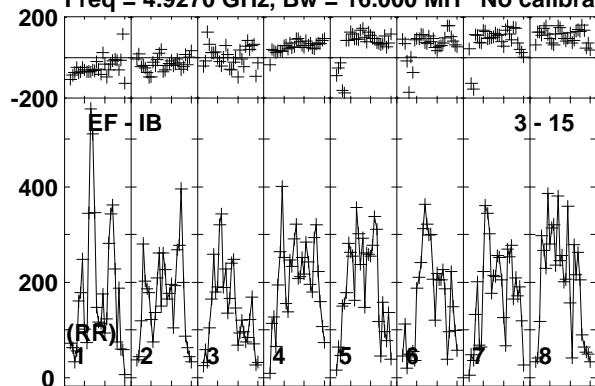

Lower frame: Micro Ampl Jy Top frame: Phas deg  
Vector averaged cross-power spectrum Baseline: EF (03) - IB (15)  
Timerange: 00/15:43:01 to 00/15:44:59

Plot file version 752 created 19-DEC-2018 17:59:03

J1619+2247 RY007C.UVDATA.1

Freq = 4.9270 GHz, Bw = 16.000 MH No calibration applied and no bandpass applied

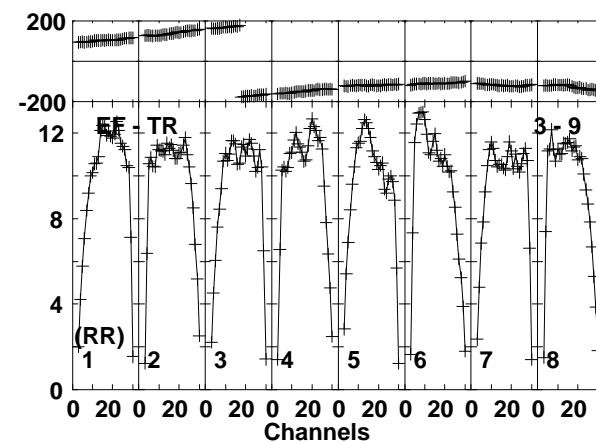
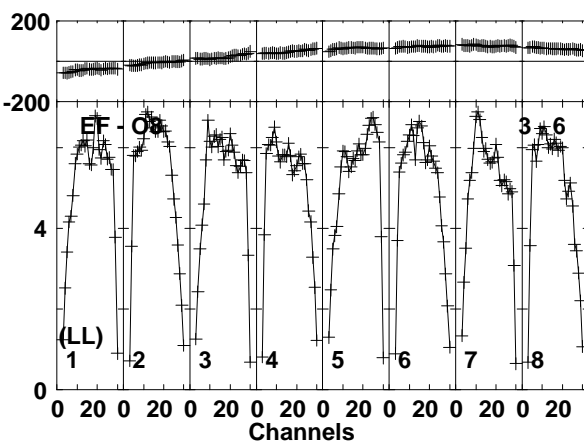
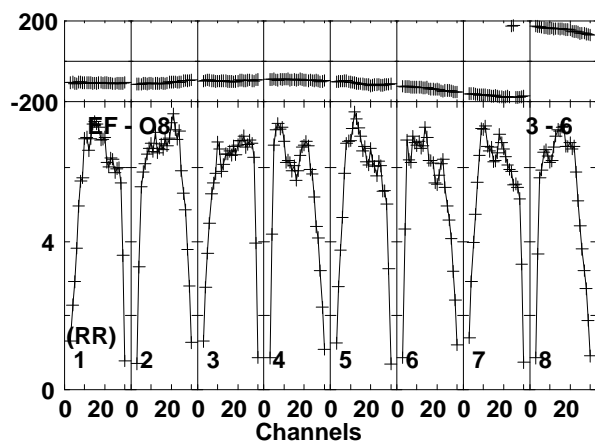
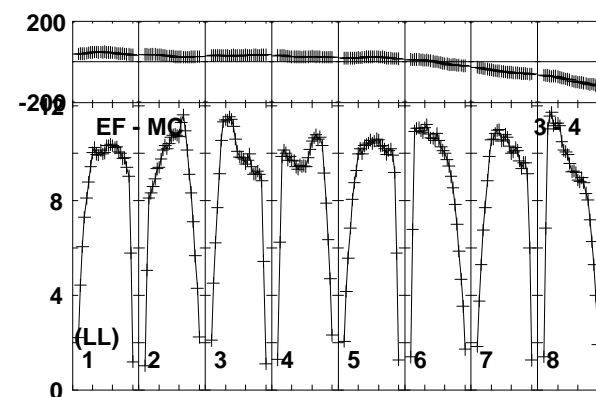
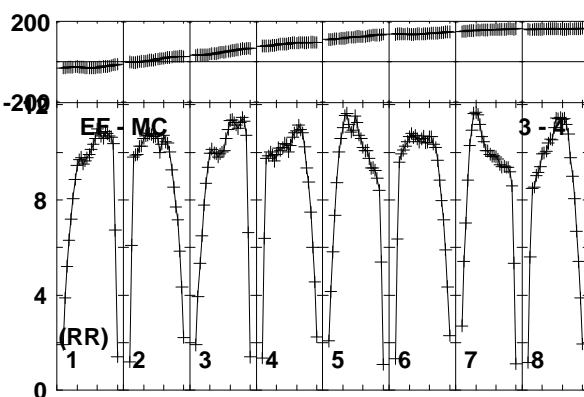
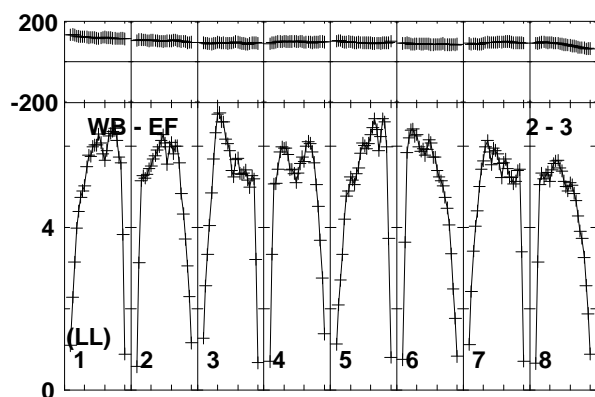
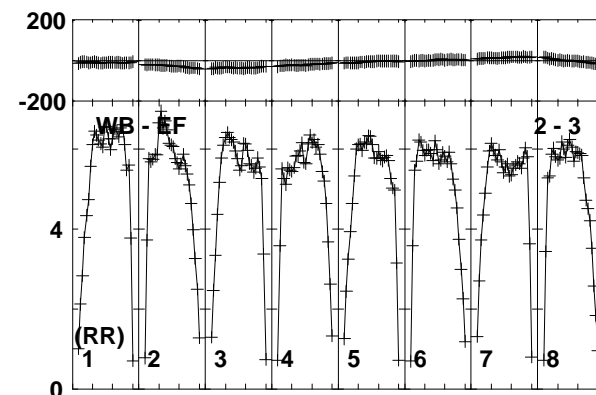
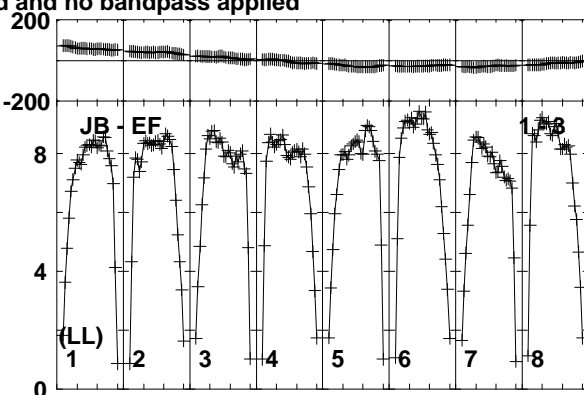
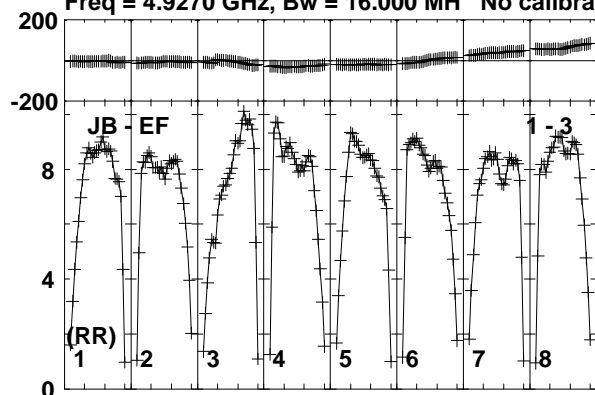

Lower frame: Milli Ampl Jy Top frame: Phas deg  
Vector averaged cross-power spectrum Baseline: JB (01) - EF (03)  
Timerange: 00/15:45:01 to 00/15:45:59

Plot file version 753 created 19-DEC-2018 17:59:03

J1619+2247 RY007C.UVDATA.1

Freq = 4.9270 GHz, Bw = 16.000 MH No calibration applied and no bandpass applied

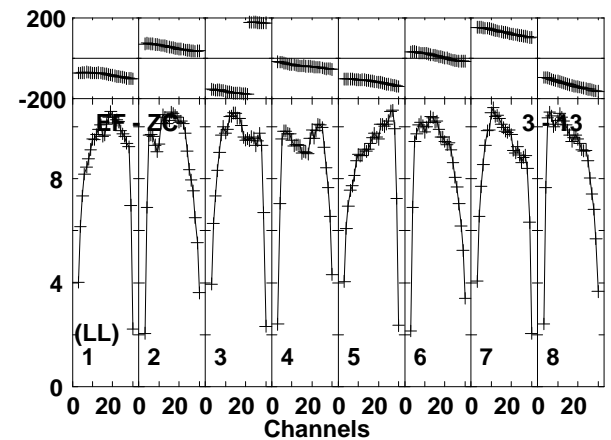
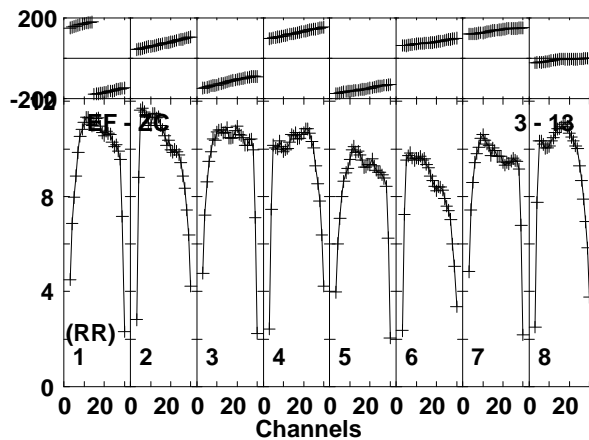
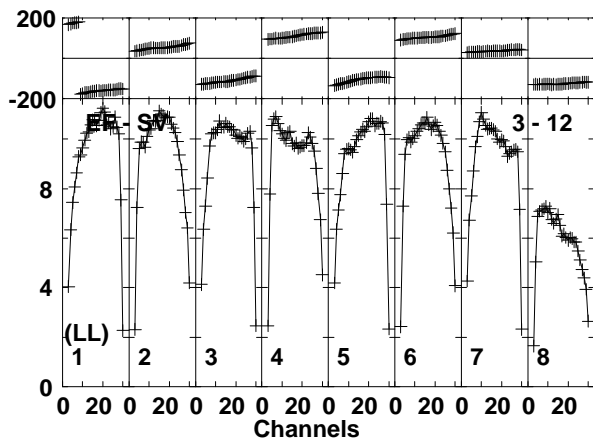
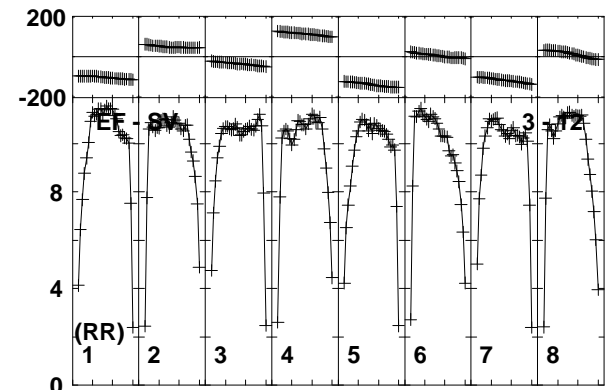
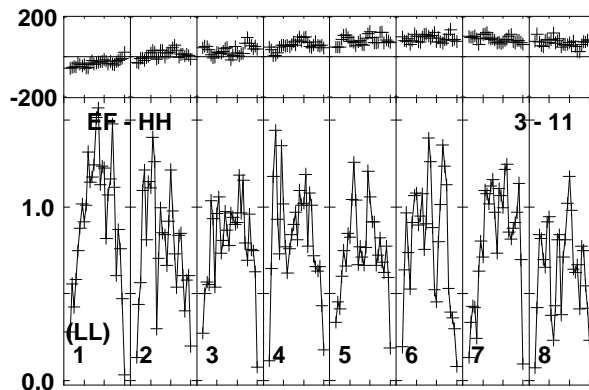
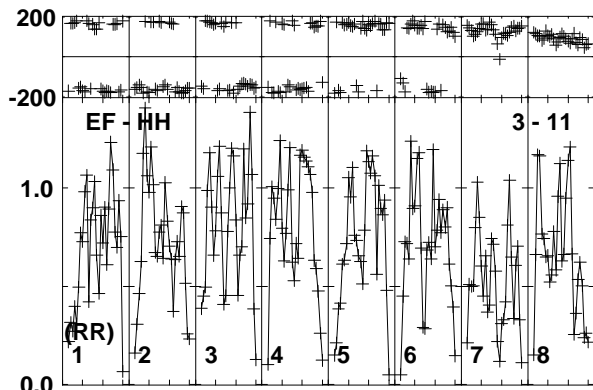
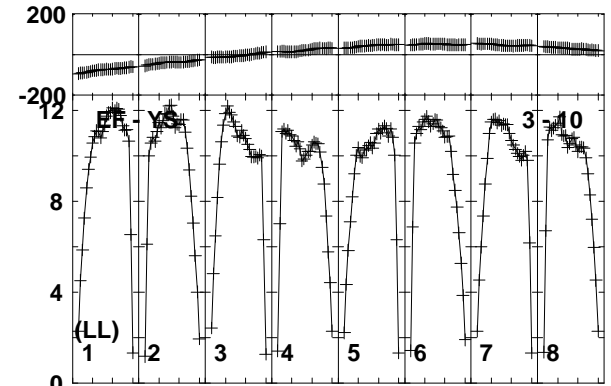
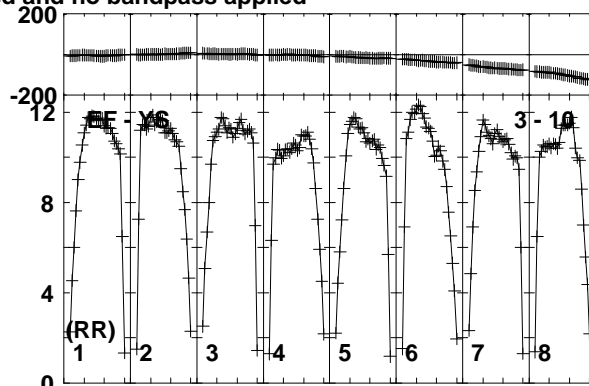
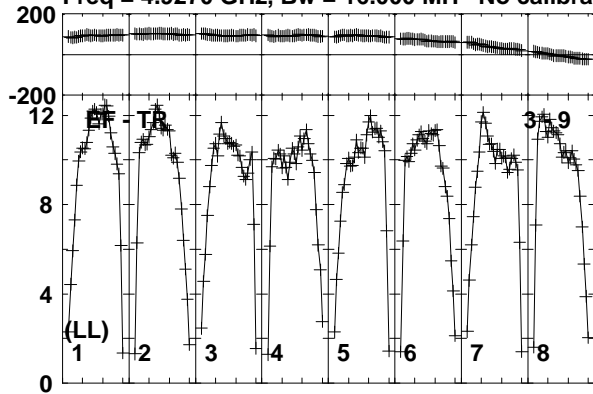

Lower frame: Milli Ampl Jy Top frame: Phas deg  
Vector averaged cross-power spectrum Baseline: EF (03) - TR (09)  
Timerange: 00:15:45:01 to 00:15:45:59

Plot file version 754 created 19-DEC-2018 17:59:03  
J1619+2247 RY007C.UVDATA.1

Freq = 4.9270 GHz, Bw = 16.000 MH No calibration applied and no bandpass applied

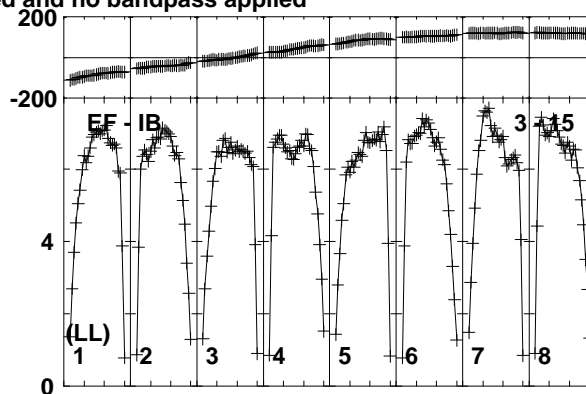
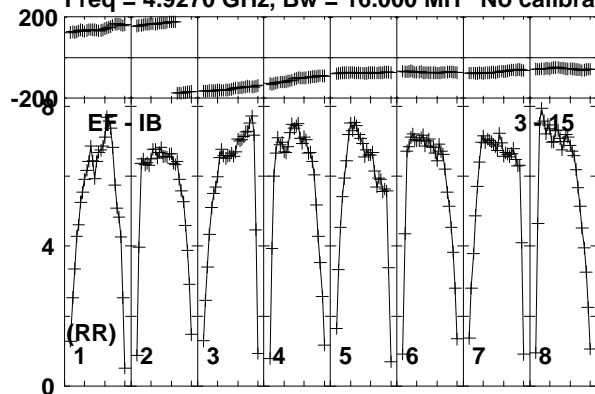

Lower frame: Milli Ampl Jy Top frame: Phas deg  
Vector averaged cross-power spectrum Baseline: EF (03) - IB (15)  
Timerange: 00/15:45:01 to 00/15:45:59



Plot file version 755 created 19-DEC-2018 17:59:03

AT2018\_RY007C.UVDATA.1

Freq = 4.9270 GHz, Bw = 16.000 MH No calibration applied and no bandpass applied

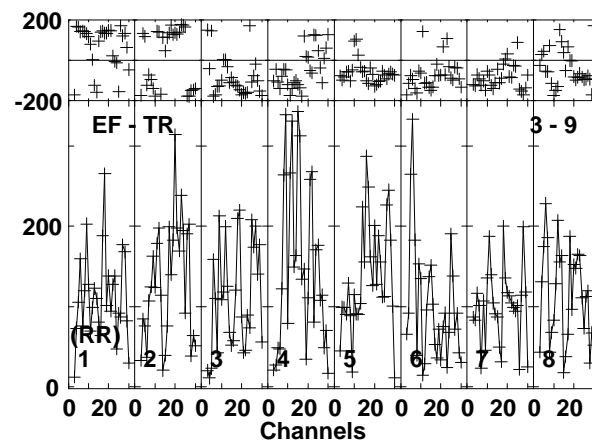
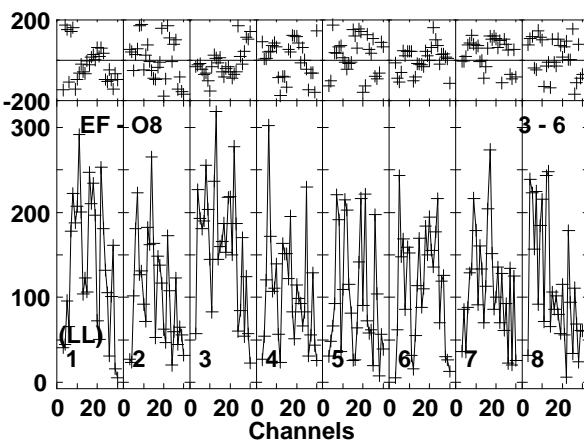
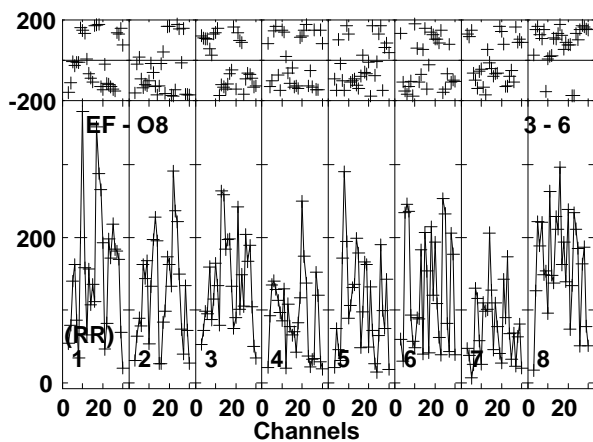
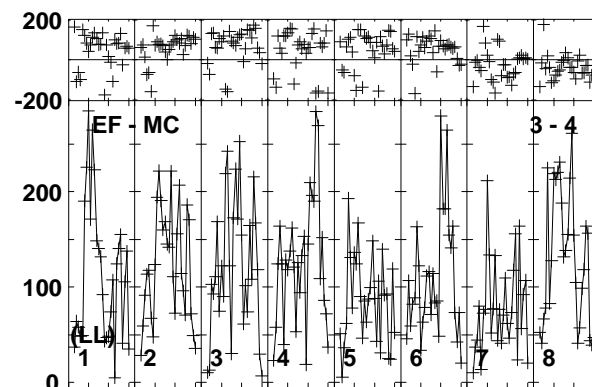
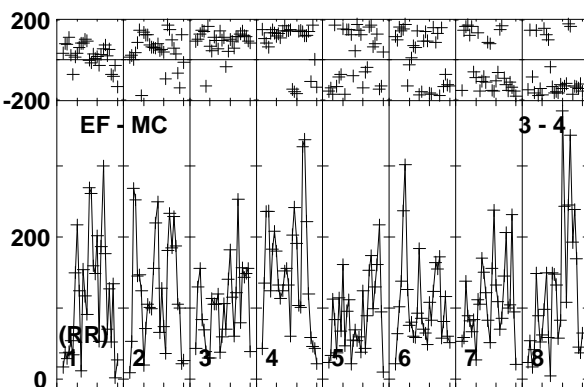
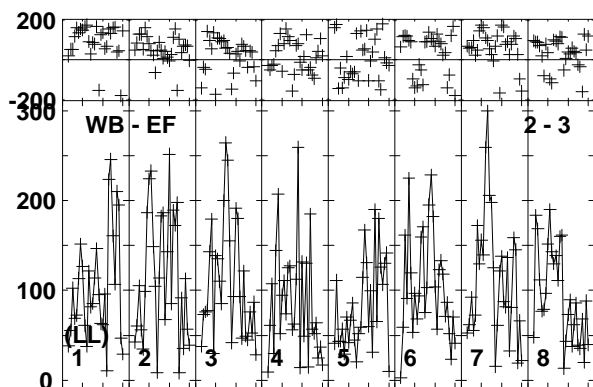
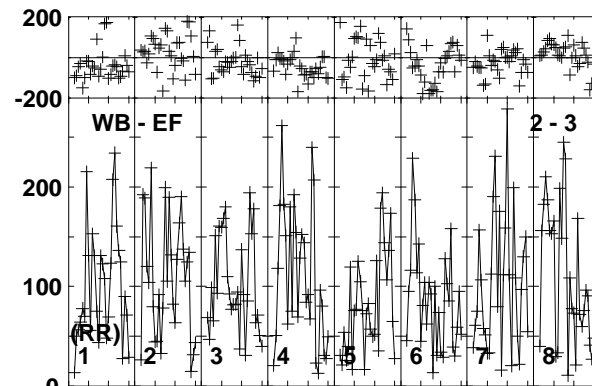
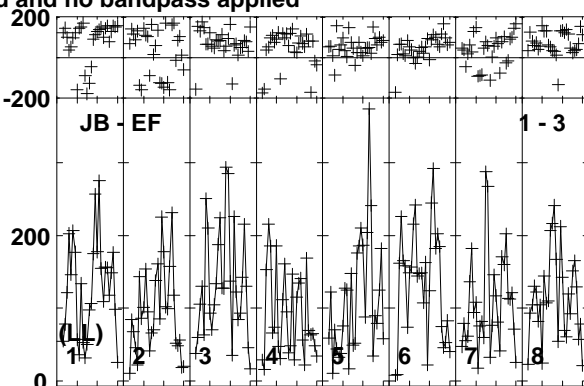
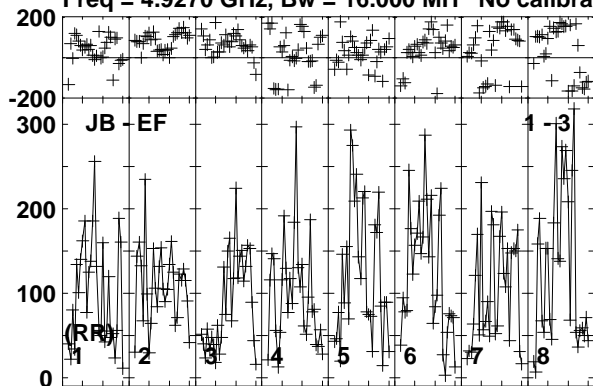

Lower frame: Micro Ampl Jy Top frame: Phas deg  
Vector averaged cross-power spectrum Baseline: JB (01) - EF (03)  
Timerange: 00/15:46:01 to 00/15:48:59

Plot file version 756 created 19-DEC-2018 17:59:03

AT2018\_RY007C.UVDATA.1

Freq = 4.9270 GHz, Bw = 16.000 MH No calibration applied and no bandpass applied

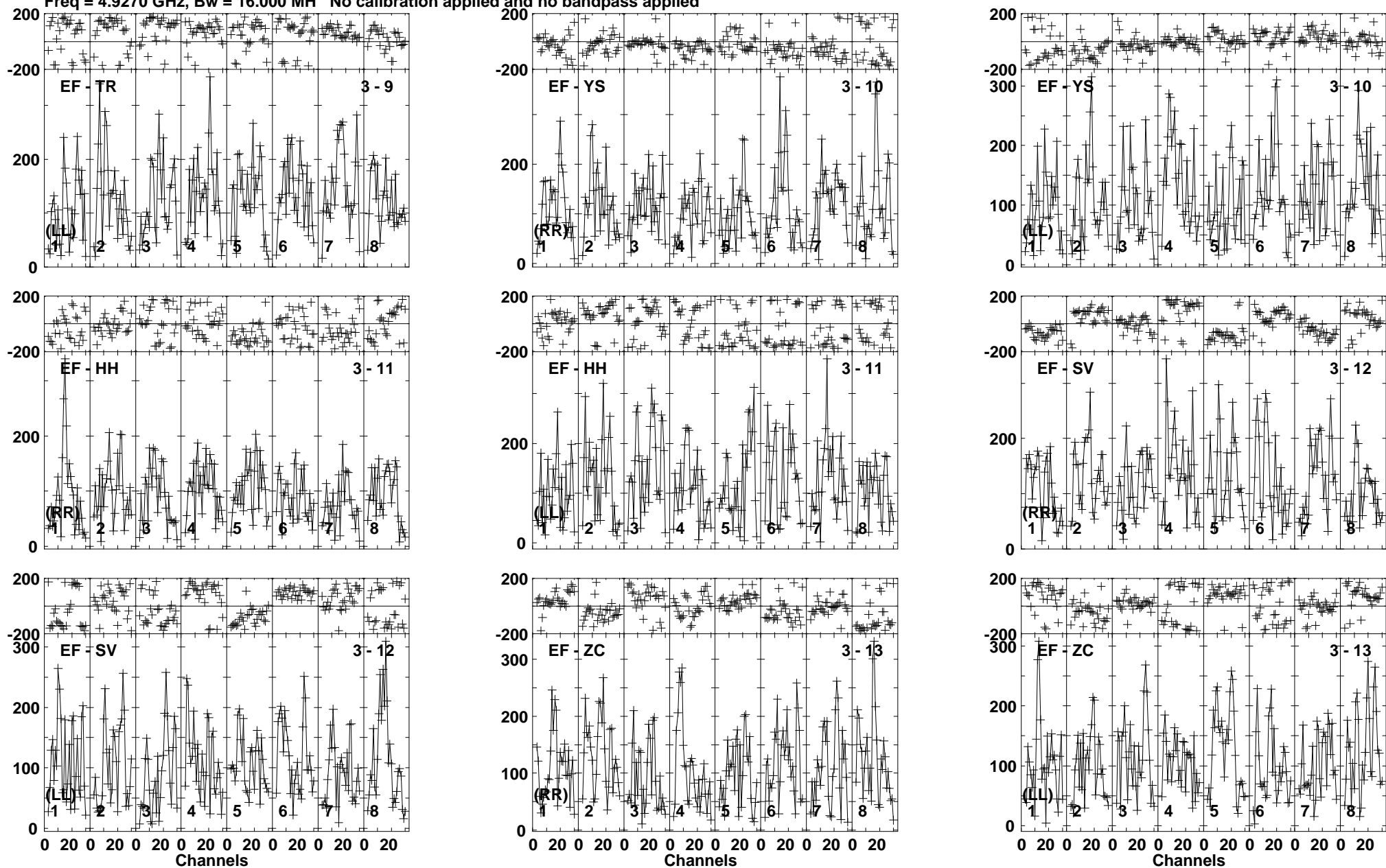

Lower frame: Micro Ampl Jy Top frame: Phas deg  
Vector averaged cross-power spectrum Baseline: EF (03) - TR (09)  
Timerange: 00/15:46:01 to 00/15:48:59

Plot file version 757 created 19-DEC-2018 17:59:04

AT2018\_RY007C.UVDATA.1

Freq = 4.9270 GHz, Bw = 16.000 MH No calibration applied and no bandpass applied

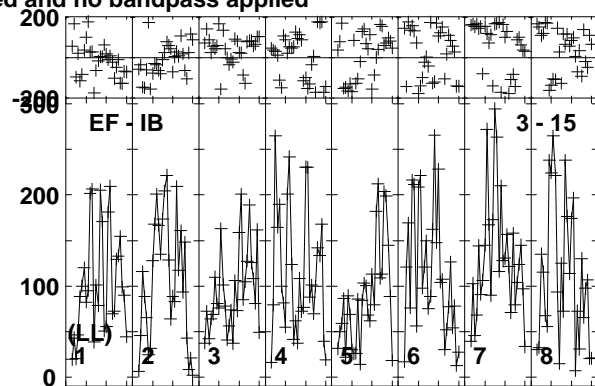
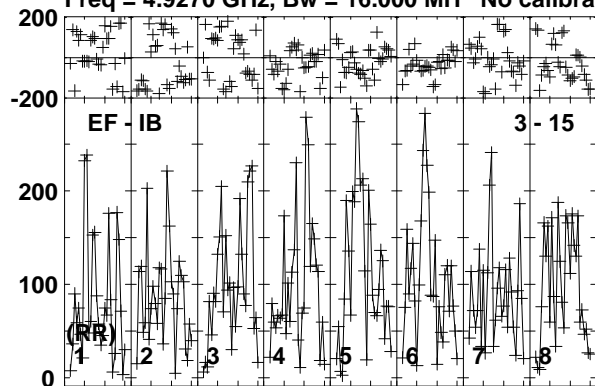

Lower frame: Micro Ampl Jy Top frame: Phas deg  
Vector averaged cross-power spectrum Baseline: EF (03) - IB (15)  
Timerange: 00/15:46:01 to 00/15:48:59

Plot file version 758 created 19-DEC-2018 17:59:04

J1619+2247 RY007C.UVDATA.1

Freq = 4.9270 GHz, Bw = 16.000 MH No calibration applied and no bandpass applied

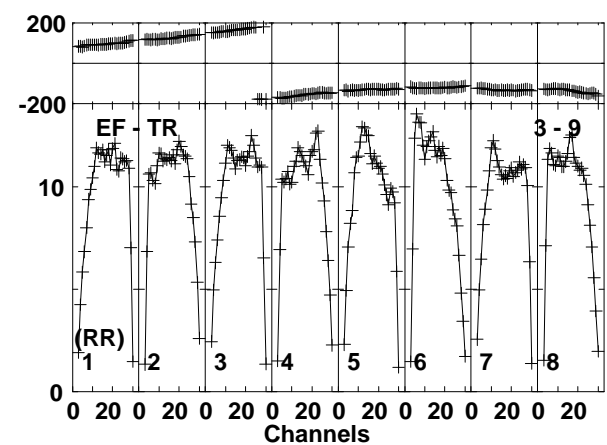
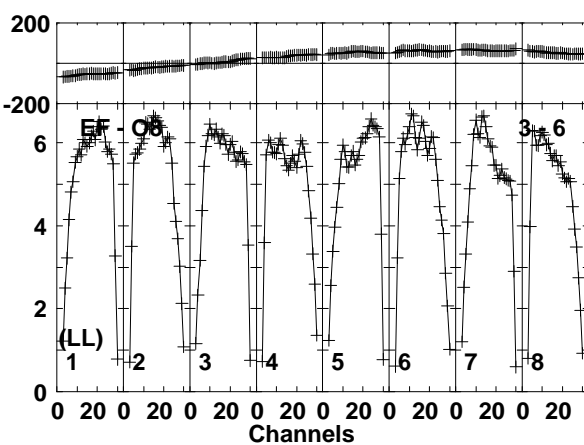
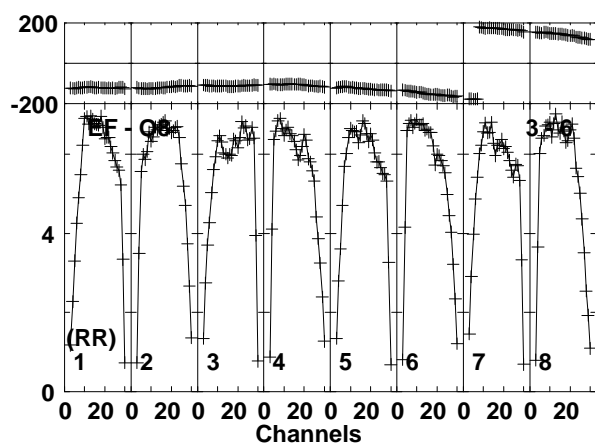
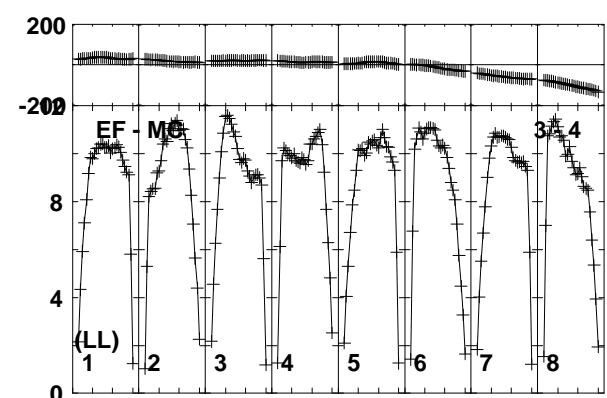
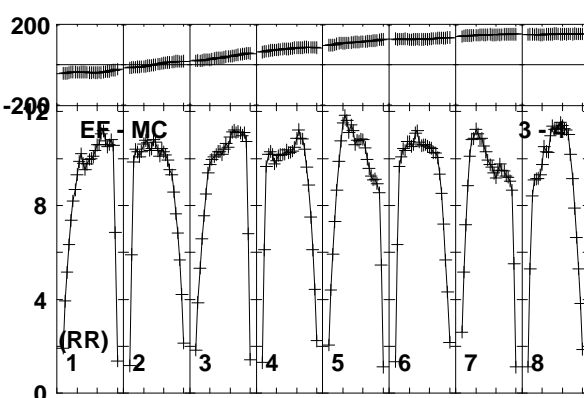
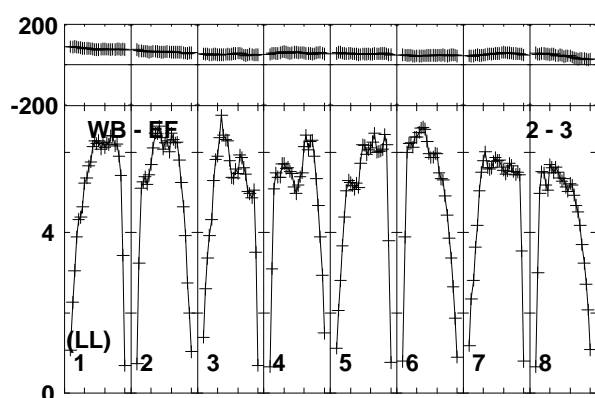
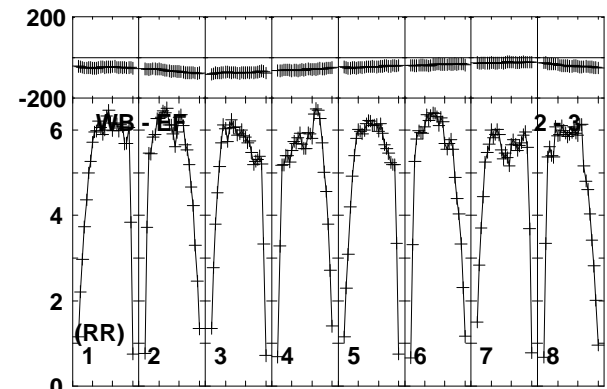
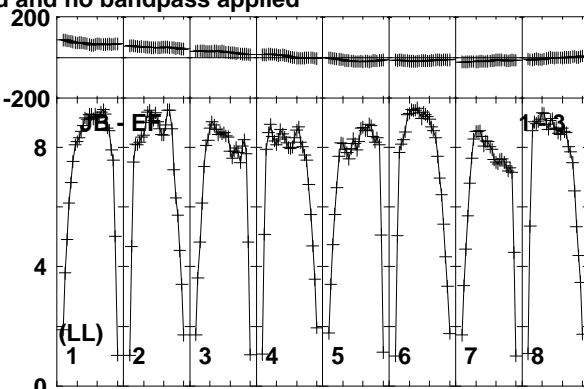
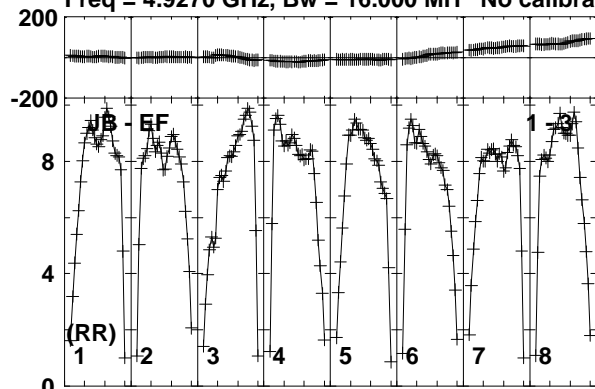

Lower frame: Milli Ampl Jy Top frame: Phas deg  
Vector averaged cross-power spectrum Baseline: JB (01) - EF (03)  
Timerange: 00/15:49:01 to 00/15:49:59

Plot file version 759 created 19-DEC-2018 17:59:04

J1619+2247 RY007C.UVDATA.1

Freq = 4.9270 GHz, Bw = 16.000 MH No calibration applied and no bandpass applied

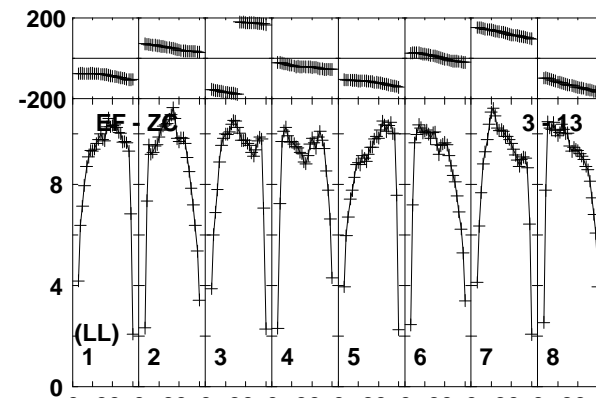
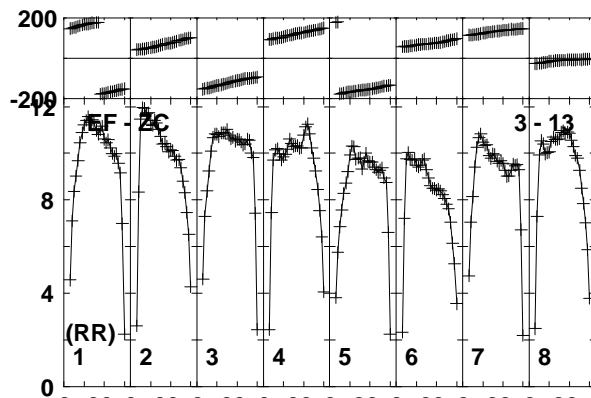
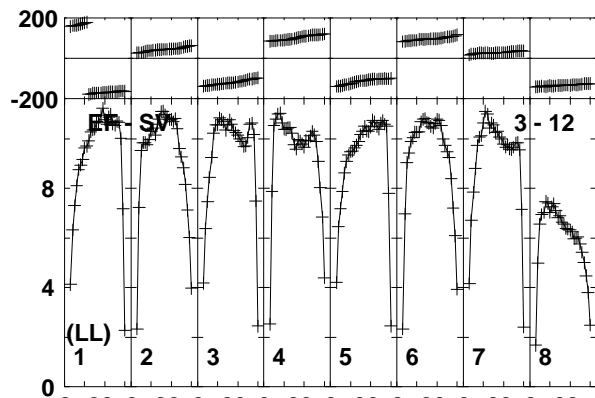
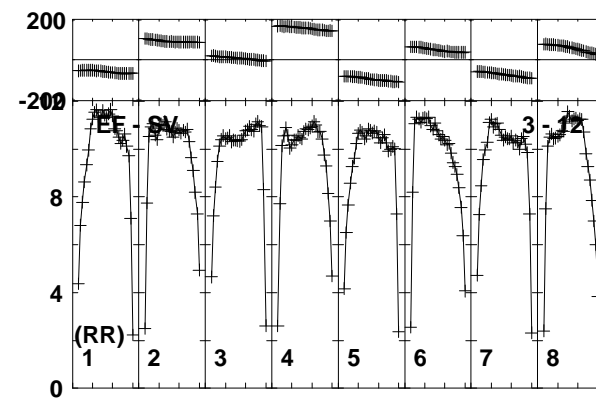
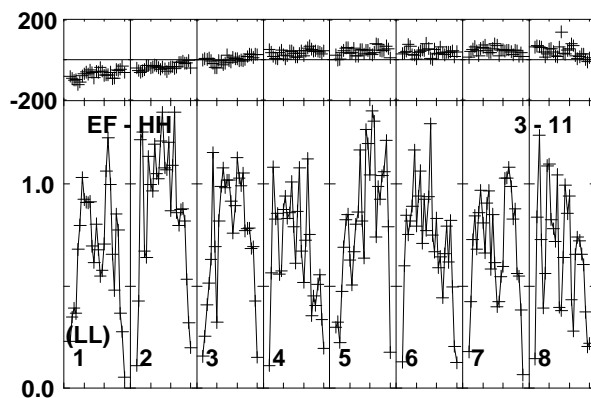
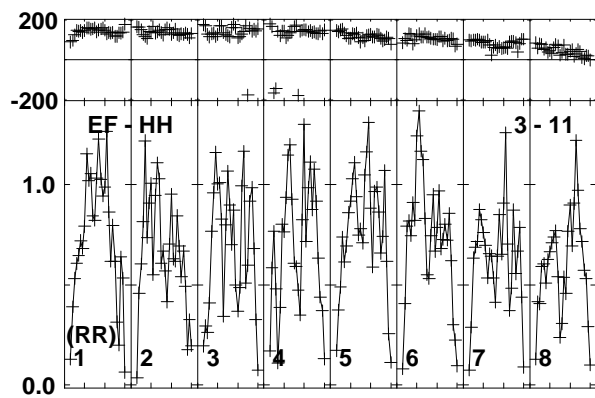
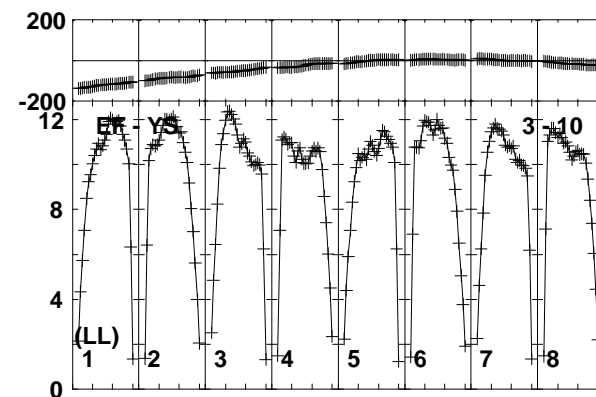
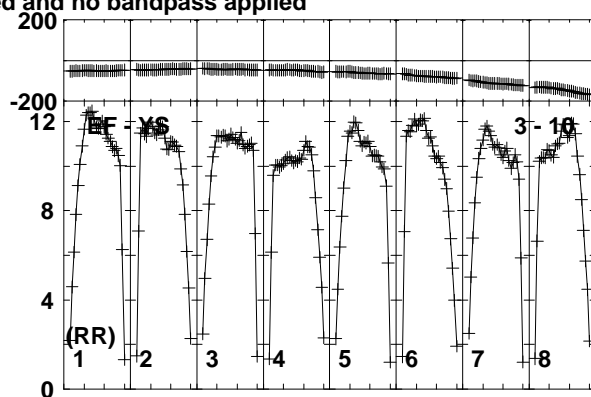
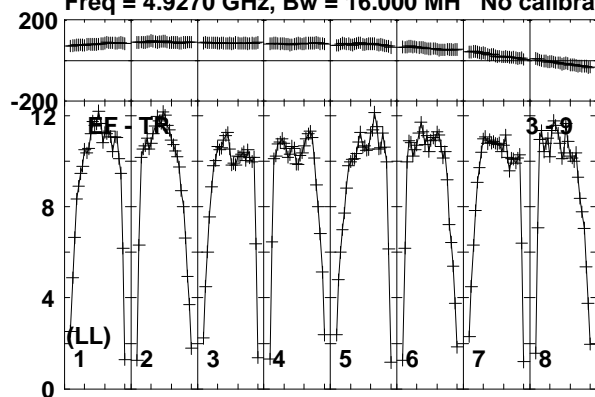

Lower frame: Milli Ampl Jy Top frame: Phas deg  
Vector averaged cross-power spectrum Baseline: EF (03) - TR (09)  
Timerange: 00:15:49:01 to 00:15:49:59

Plot file version 760 created 19-DEC-2018 17:59:04  
J1619+2247 RY007C.UVDATA.1

Freq = 4.9270 GHz, Bw = 16.000 MH No calibration applied and no bandpass applied

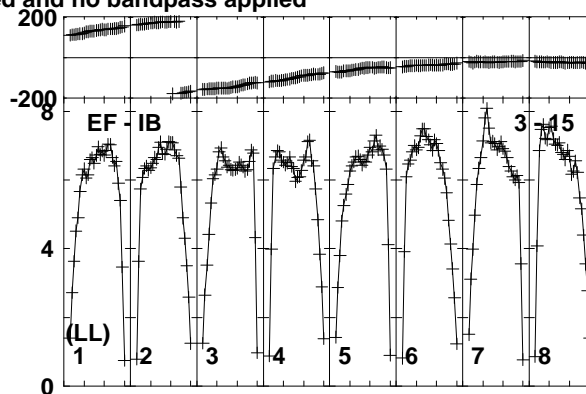
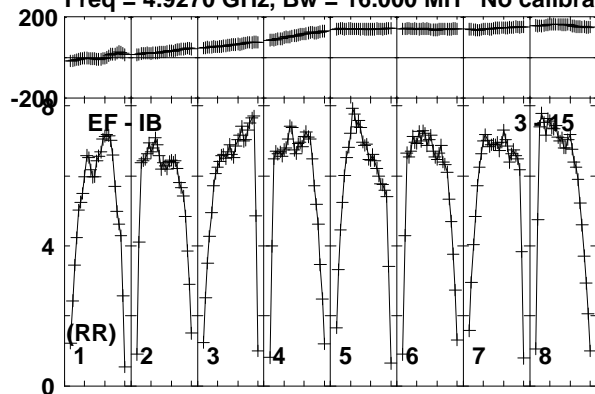

Lower frame: Milli Ampl Jy Top frame: Phas deg  
Vector averaged cross-power spectrum Baseline: EF (03) - IB (15)  
Timerange: 00/15:49:01 to 00/15:49:59

Plot file version 761 created 19-DEC-2018 17:59:04

AT2018\_RY007C.UVDATA.1

Freq = 4.9270 GHz, Bw = 16.000 MH No calibration applied and no bandpass applied

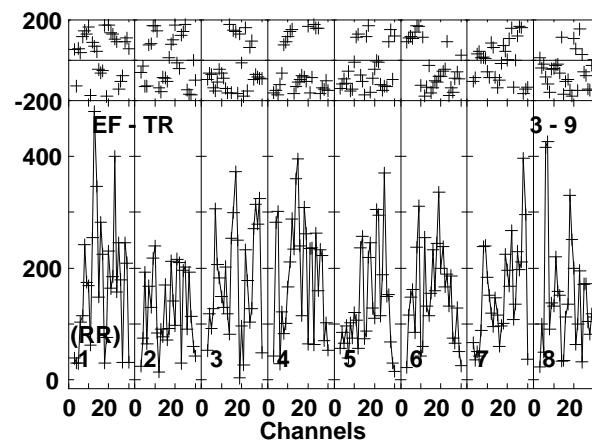
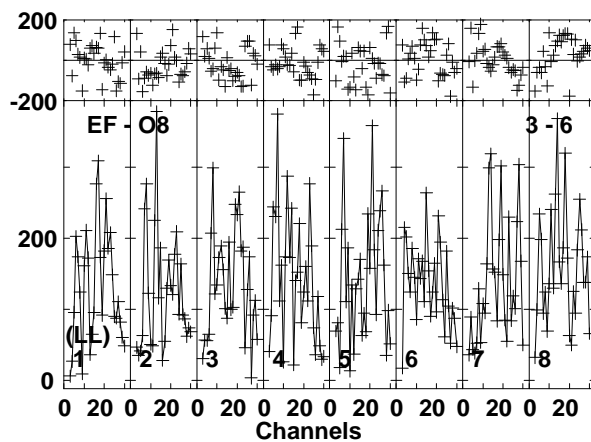
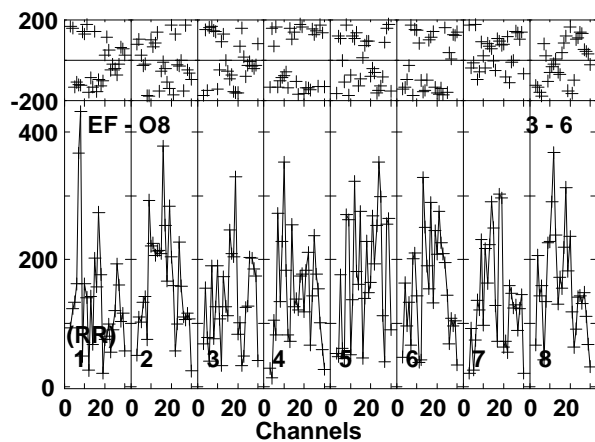
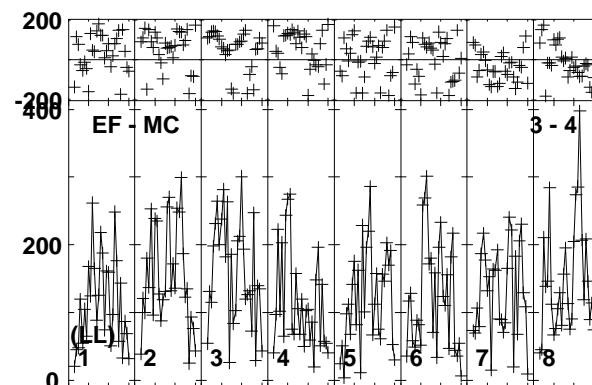
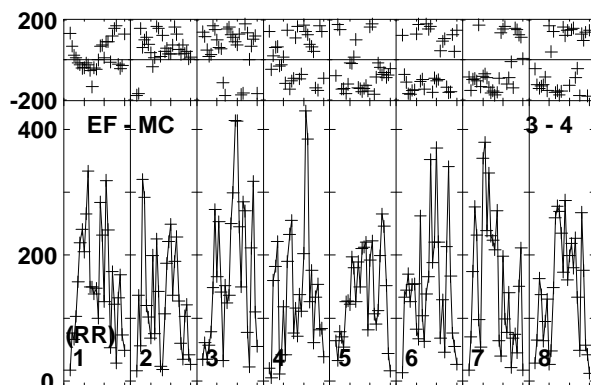
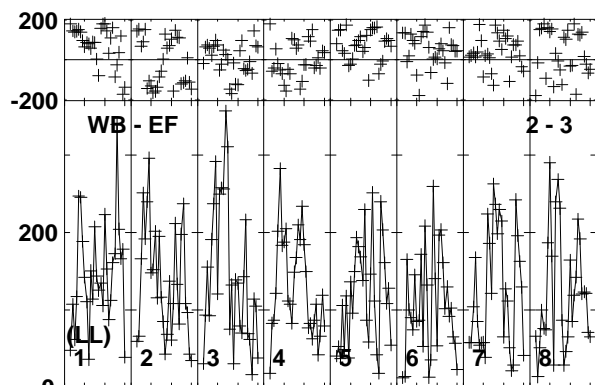
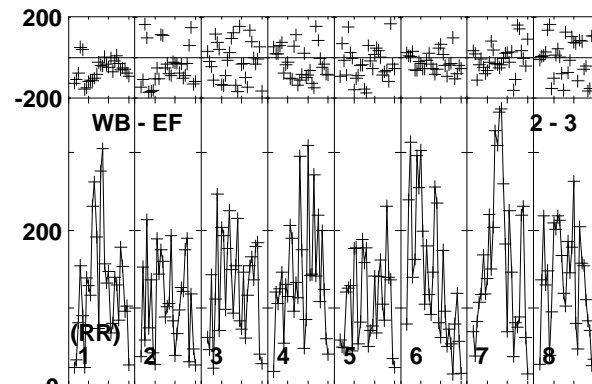
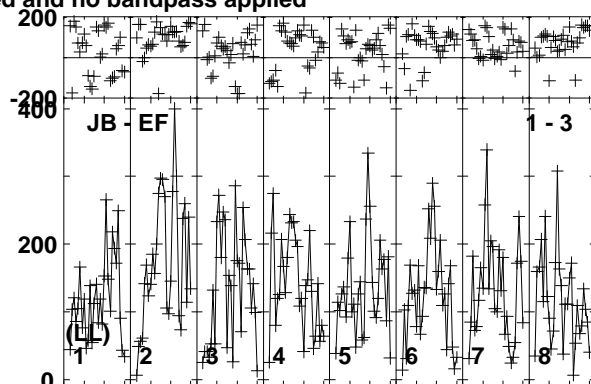
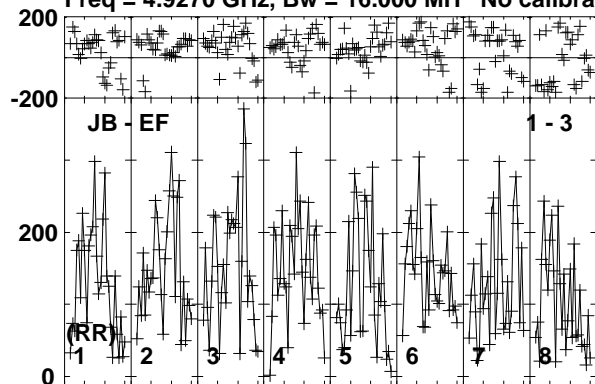

Lower frame: Micro Ampl Jy Top frame: Phas deg  
Vector averaged cross-power spectrum Baseline: JB (01) - EF (03)  
Timerange: 00/15:50:01 to 00/15:51:59

Plot file version 762 created 19-DEC-2018 17:59:04  
AT2018\_RY007C.UVDATA.1

Freq = 4.9270 GHz, Bw = 16.000 MH No calibration applied and no bandpass applied

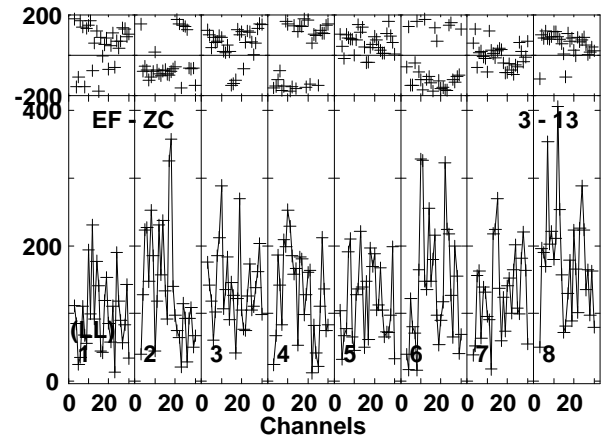
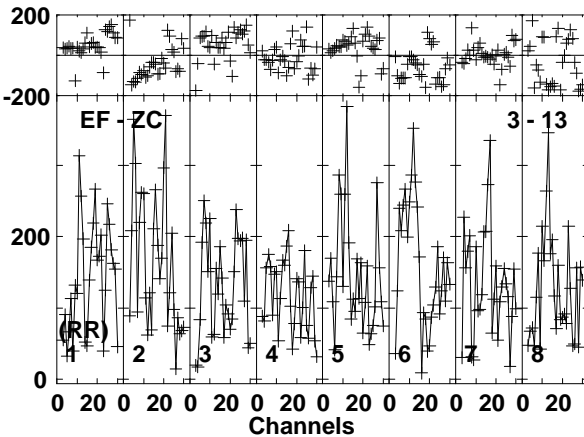
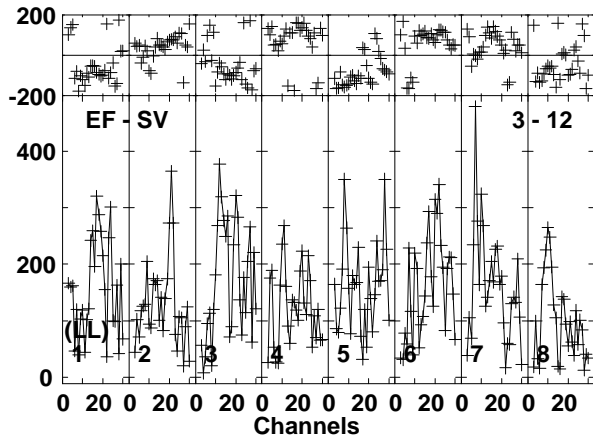
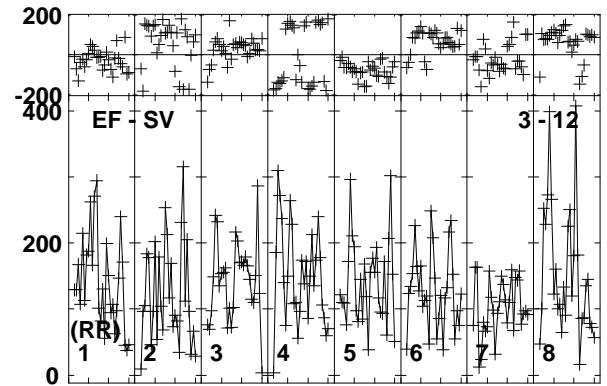
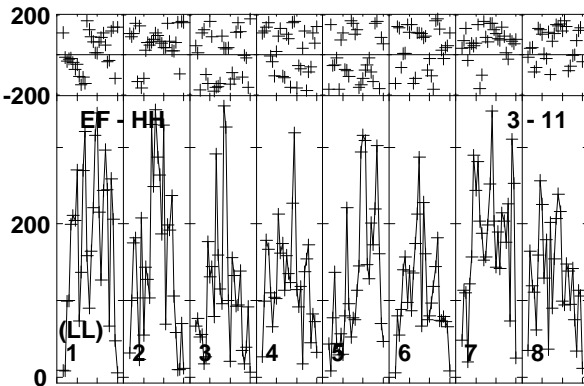
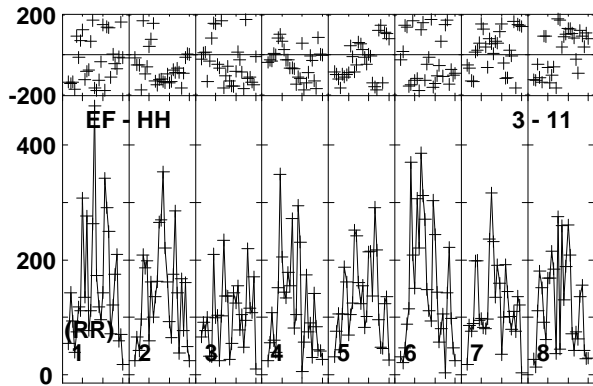
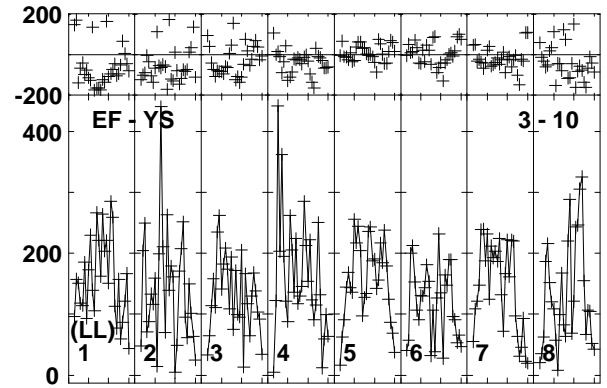
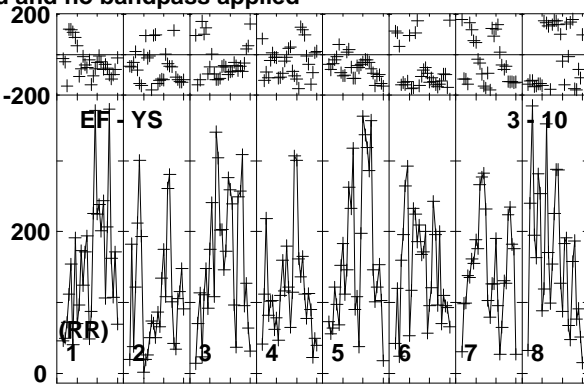
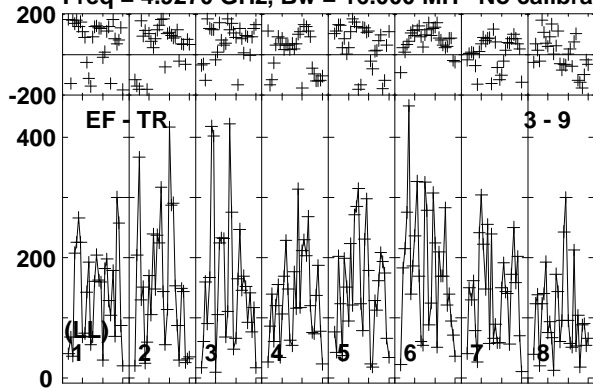

Lower frame: Micro Ampl Jy Top frame: Phas deg  
Vector averaged cross-power spectrum Baseline: EF (03) - TR (09)  
Timerange: 00/15:50:01 to 00/15:51:59



Plot file version 763 created 19-DEC-2018 17:59:04

AT2018\_RY007C.UVDATA.1

Freq = 4.9270 GHz, Bw = 16.000 MH No calibration applied and no bandpass applied

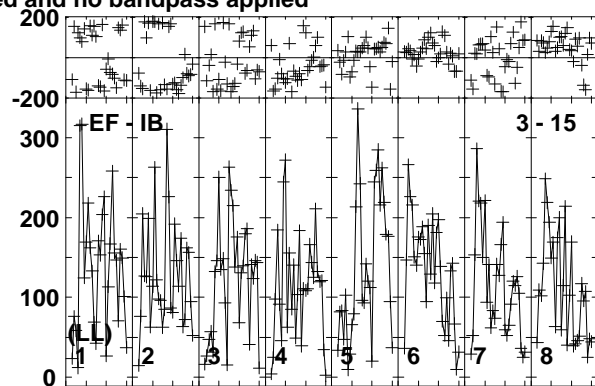
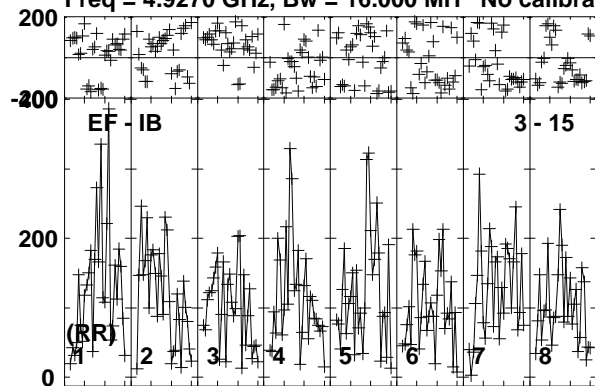

Lower frame: Micro Ampl Jy Top frame: Phas deg  
Vector averaged cross-power spectrum Baseline: EF (03) - IB (15)  
Timerange: 00/15:50:01 to 00/15:51:59

Plot file version 764 created 19-DEC-2018 17:59:04

VLA2 RY007C.UVDATA.1

Freq = 4.9270 GHz, Bw = 16.000 MH No calibration applied and no bandpass applied

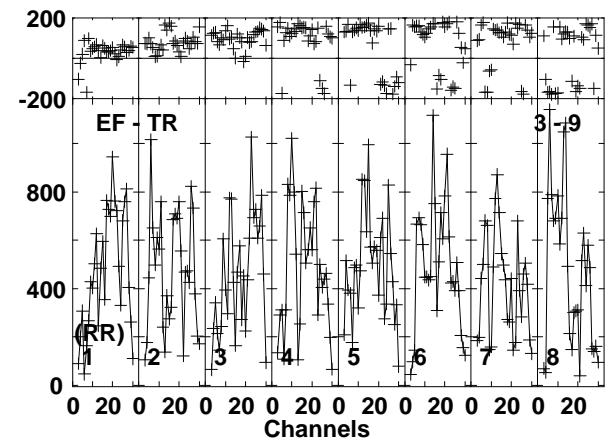
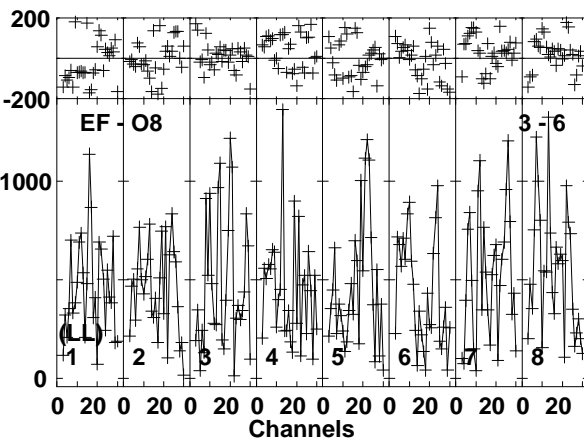
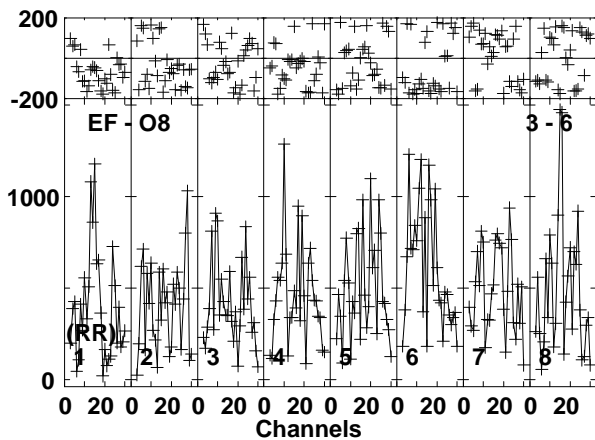
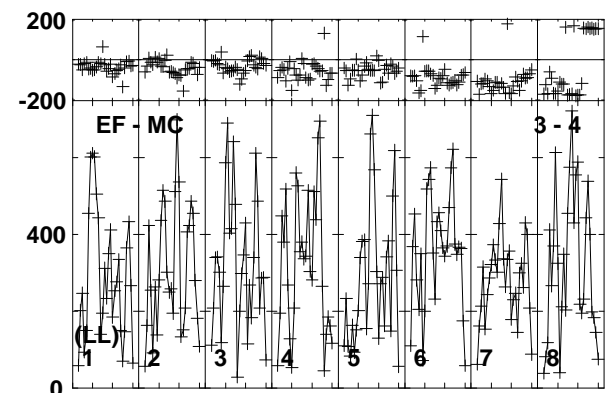
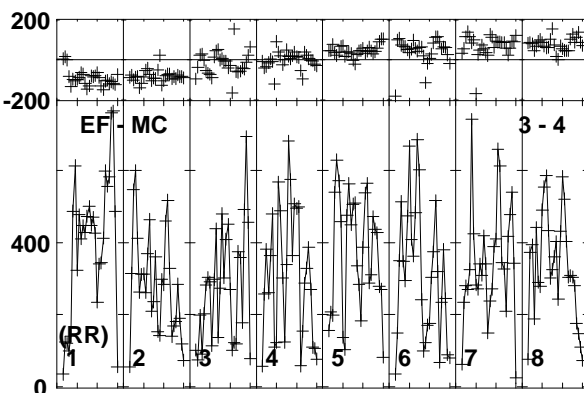
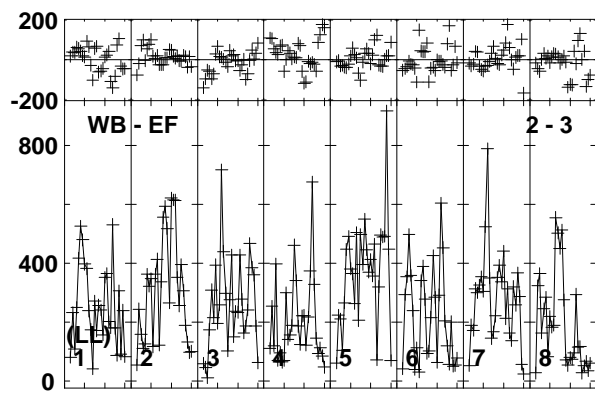
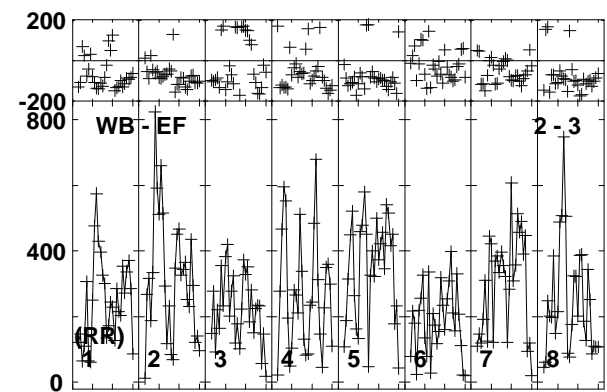
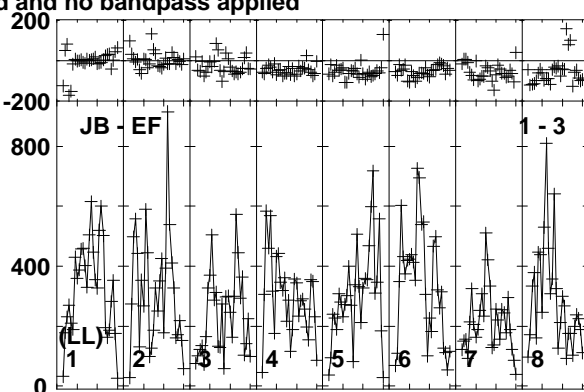
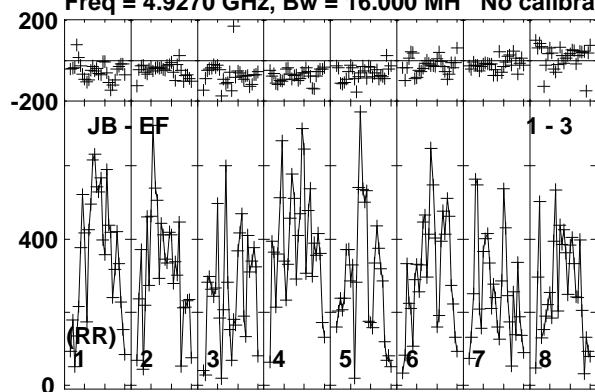

Lower frame: Micro Ampl Jy Top frame: Phas deg  
Vector averaged cross-power spectrum Baseline: JB (01) - EF (03)  
Timerange: 00/15:52:01 to 00/15:52:59

Plot file version 765 created 19-DEC-2018 17:59:04

VLA2 RY007C.UVDATA.1

Freq = 4.9270 GHz, Bw = 16.000 MH No calibration applied and no bandpass applied

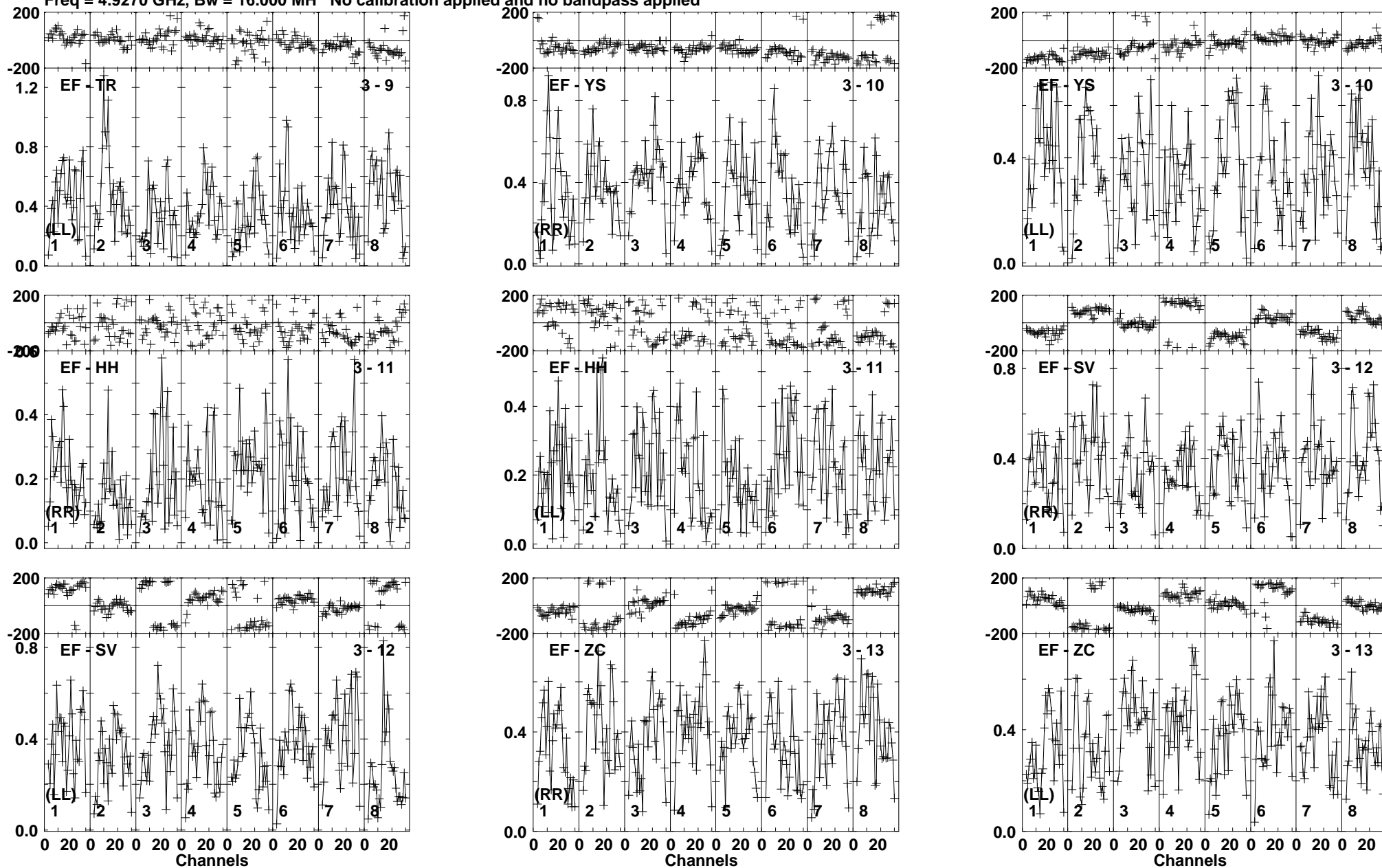

Lower frame: Milli Ampl Jy Top frame: Phas deg  
Vector averaged cross-power spectrum Baseline: EF (03) - TR (09)  
Timerange: 00/15:52:01 to 00/15:52:59

Plot file version 766 created 19-DEC-2018 17:59:04

VLA2 RY007C.UVDATA.1

Freq = 4.9270 GHz, Bw = 16.000 MH No calibration applied and no bandpass applied

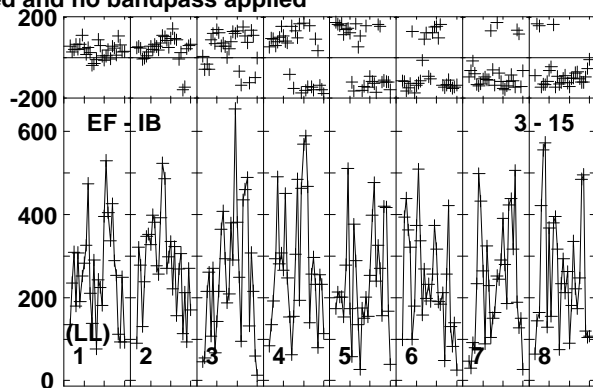
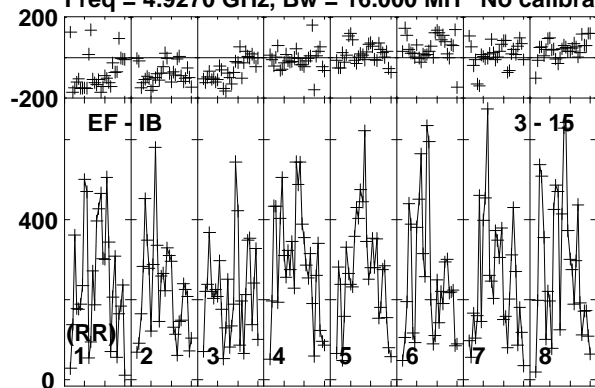

Lower frame: Micro Ampl Jy Top frame: Phas deg  
Vector averaged cross-power spectrum Baseline: EF (03) - IB (15)  
Timerange: 00/15:52:01 to 00/15:52:59

Plot file version 767 created 19-DEC-2018 17:59:04

J1619+2247 RY007C.UVDATA.1

Freq = 4.9270 GHz, Bw = 16.000 MH No calibration applied and no bandpass applied

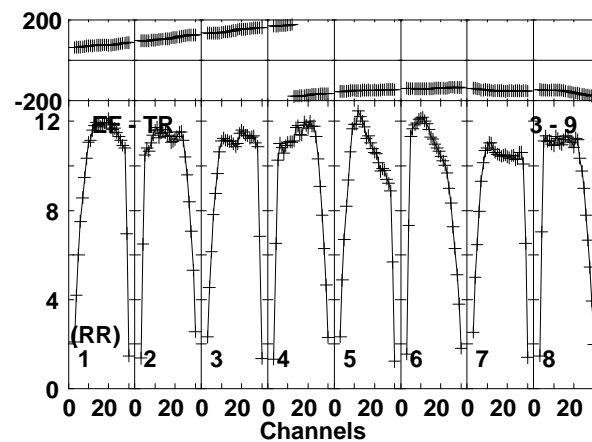
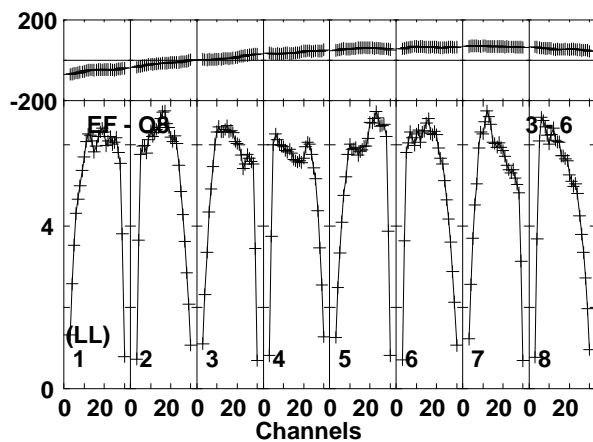
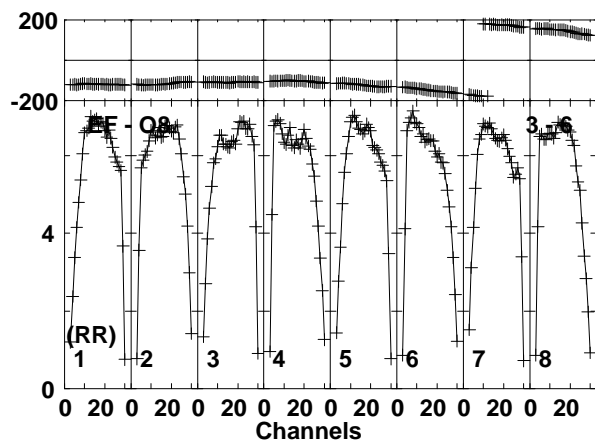
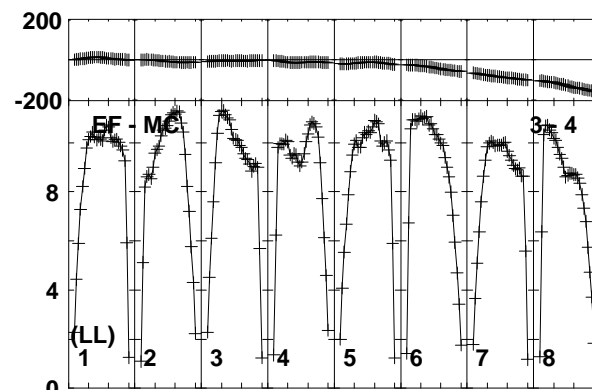
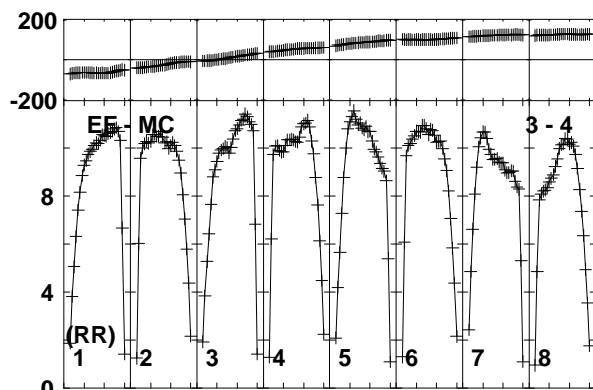
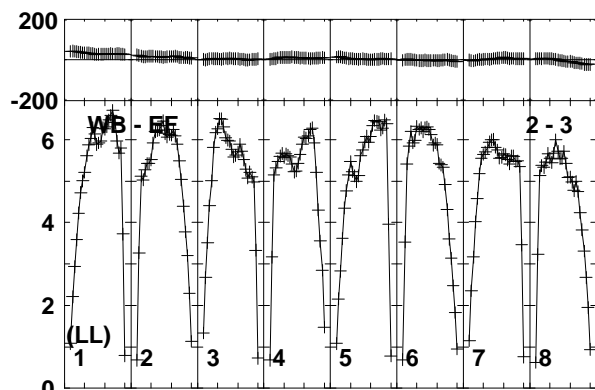
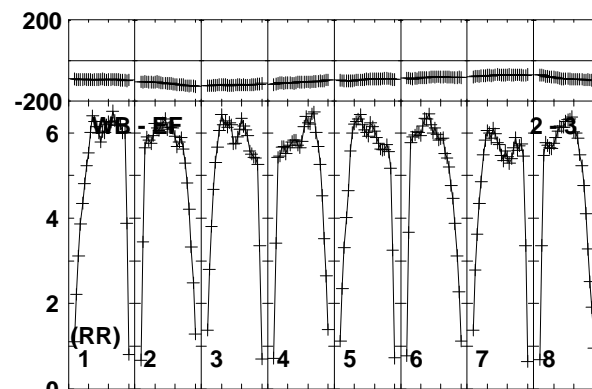
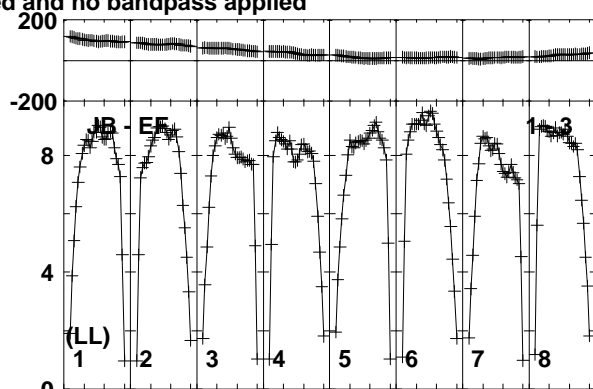
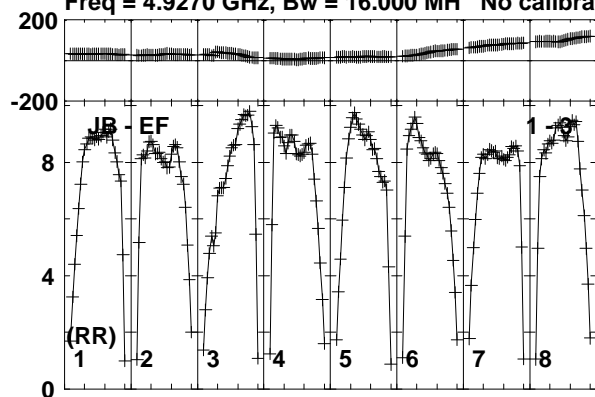

Lower frame: Milli Ampl Jy Top frame: Phas deg  
Vector averaged cross-power spectrum Baseline: JB (01) - EF (03)  
Timerange: 00/15:53:31 to 00/15:54:29

Plot file version 768 created 19-DEC-2018 17:59:04

J1619+2247 RY007C.UVDATA.1

Freq = 4.9270 GHz, Bw = 16.000 MH No calibration applied and no bandpass applied

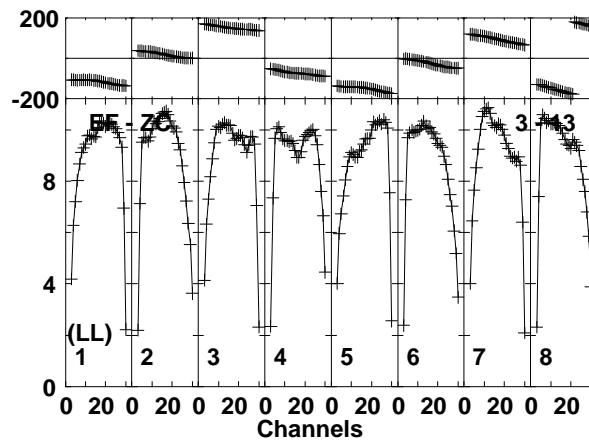
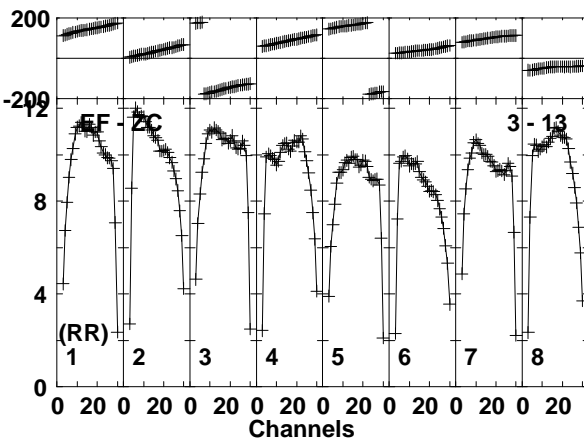
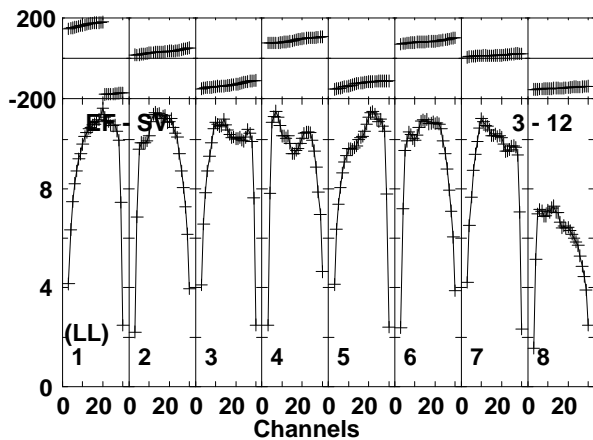
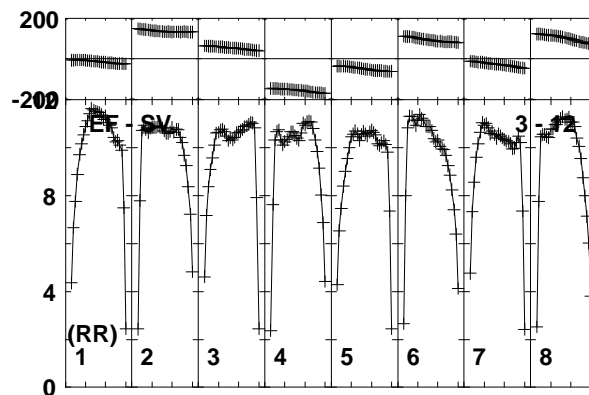
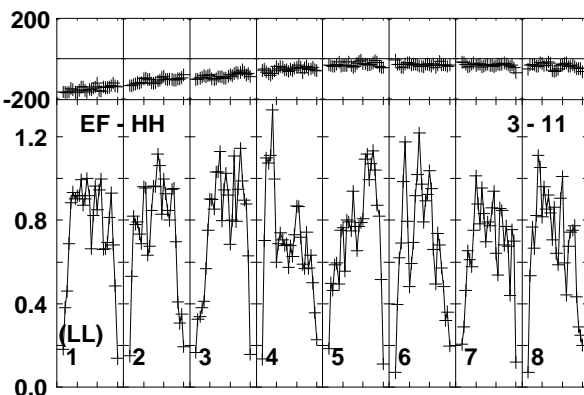
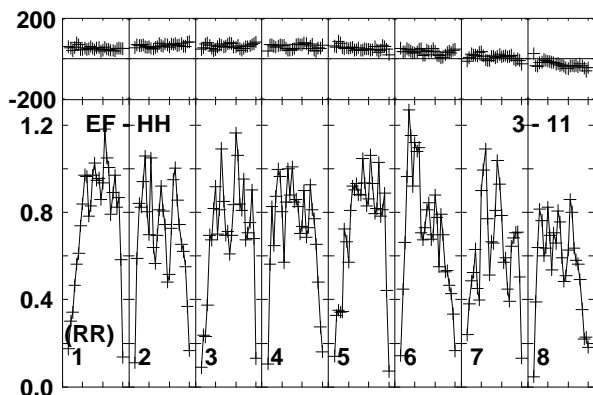
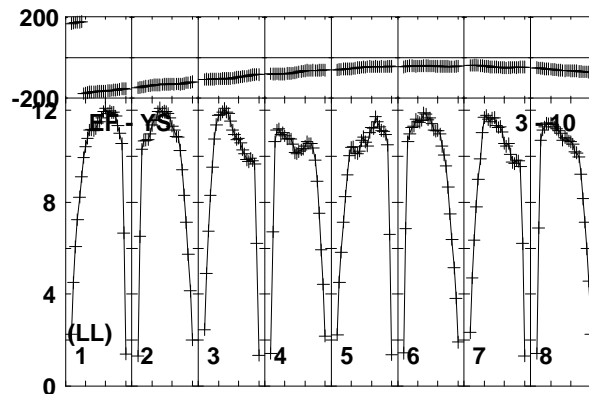
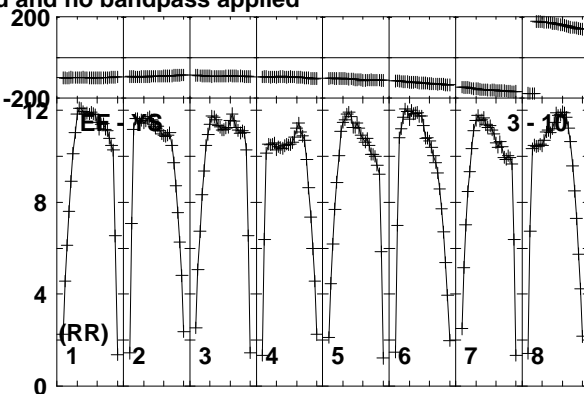
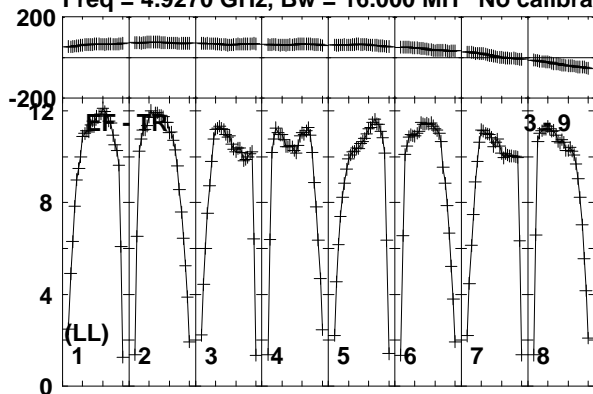

Lower frame: Milli Ampl Jy Top frame: Phas deg  
Vector averaged cross-power spectrum Baseline: EF (03) - TR (09)  
Timerange: 00/15:53:31 to 00/15:54:29

Plot file version 769 created 19-DEC-2018 17:59:04  
J1619+2247 RY007C.UVDATA.1

Freq = 4.9270 GHz, Bw = 16.000 MH No calibration applied and no bandpass applied

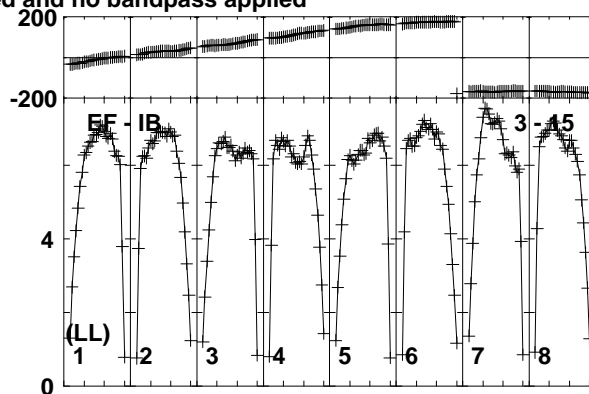
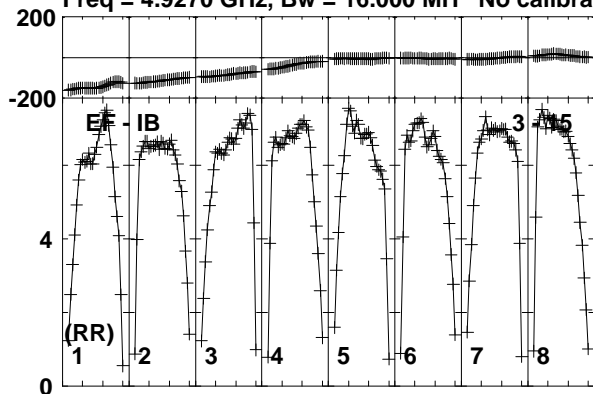

Lower frame: Milli Ampl Jy Top frame: Phas deg  
Vector averaged cross-power spectrum Baseline: EF (03) - IB (15)  
Timerange: 00/15:53:31 to 00/15:54:29

Plot file version 770 created 19-DEC-2018 17:59:04

AT2018\_RY007C.UVDATA.1

Freq = 4.9270 GHz, Bw = 16.000 MH No calibration applied and no bandpass applied

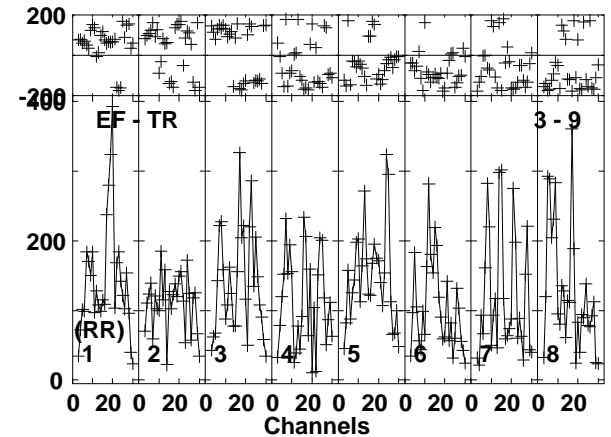
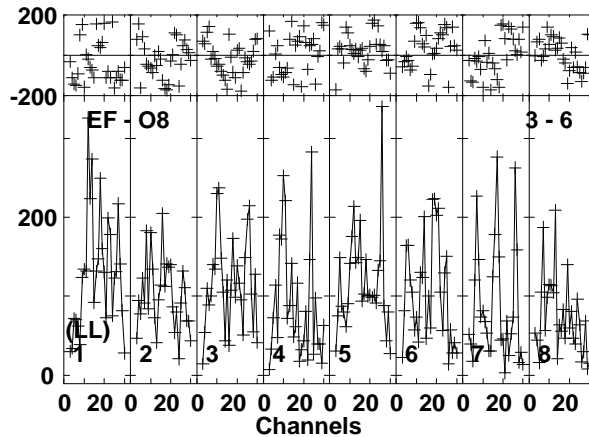
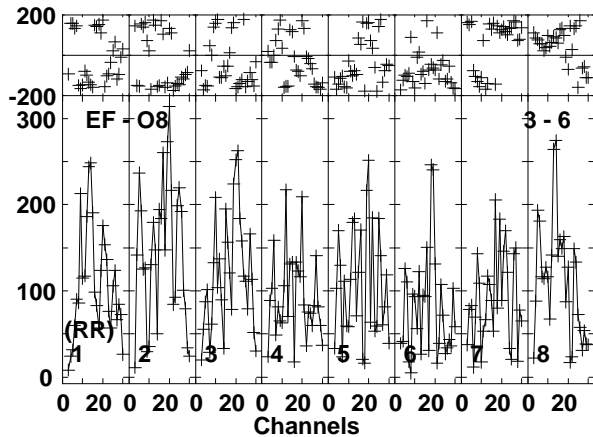
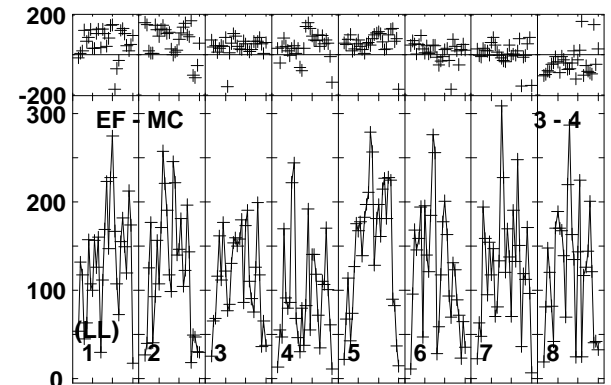
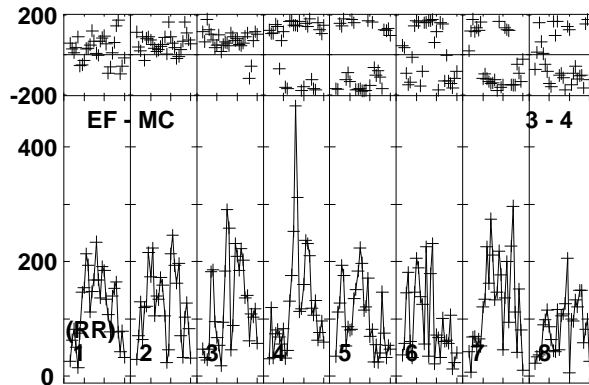
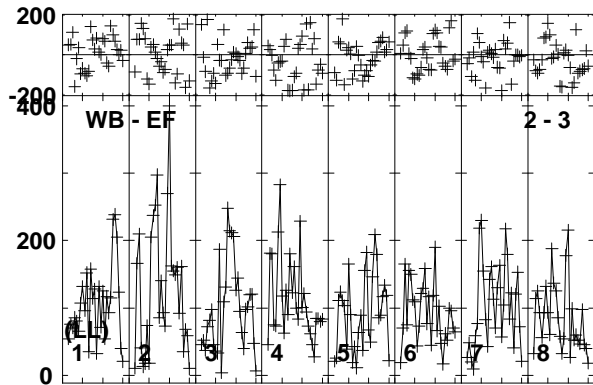
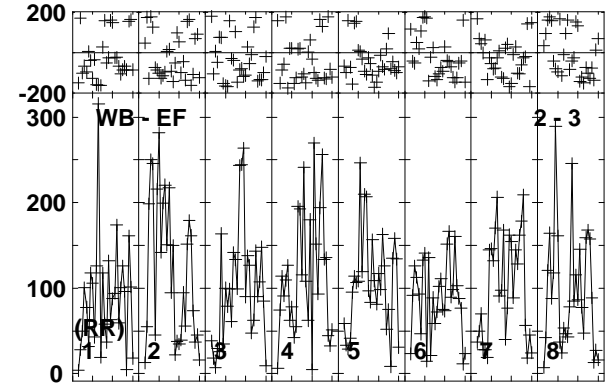
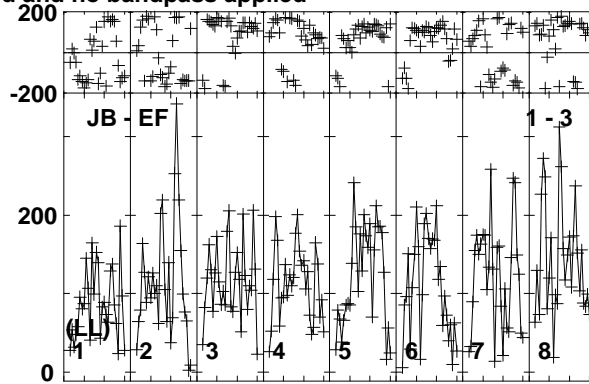
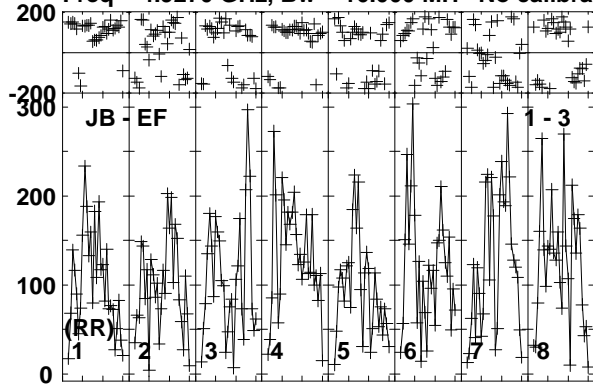

Lower frame: Micro Ampl Jy Top frame: Phas deg  
Vector averaged cross-power spectrum Baseline: JB (01) - EF (03)  
Timerange: 00/15:54:31 to 00/15:57:29



Plot file version 771 created 19-DEC-2018 17:59:04

AT2018\_RY007C.UVDATA.1

Freq = 4.9270 GHz, Bw = 16.000 MH No calibration applied and no bandpass applied

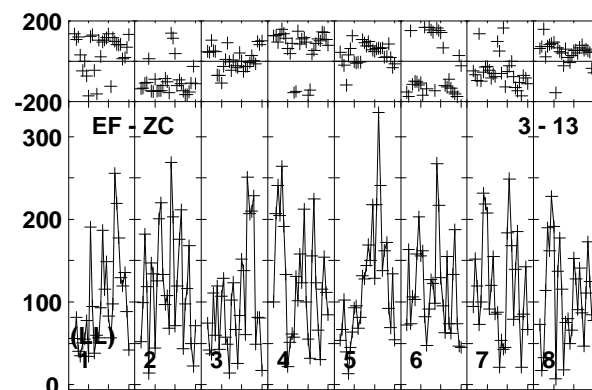
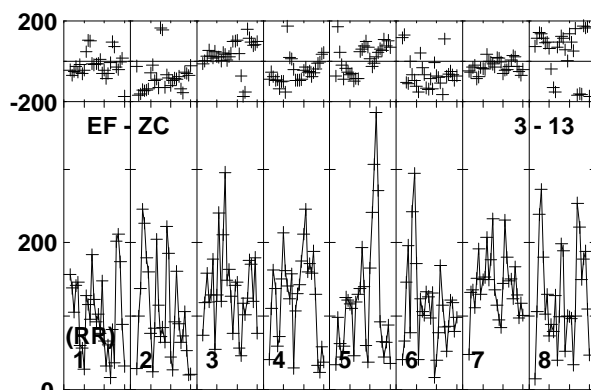
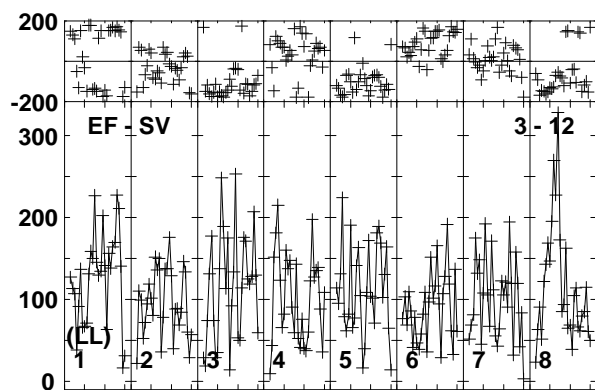
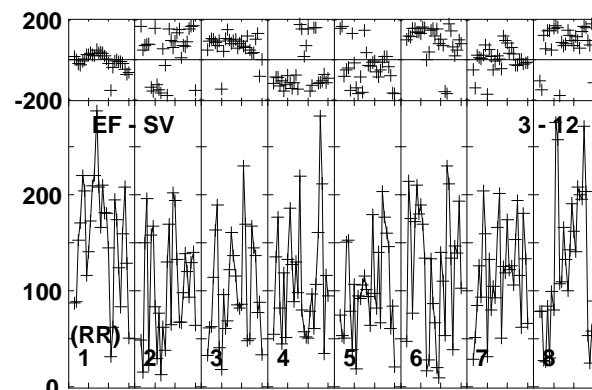
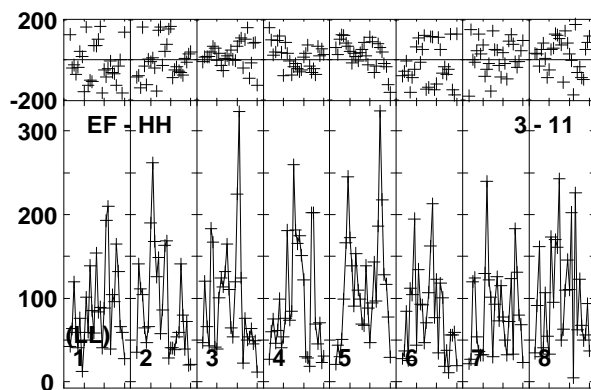
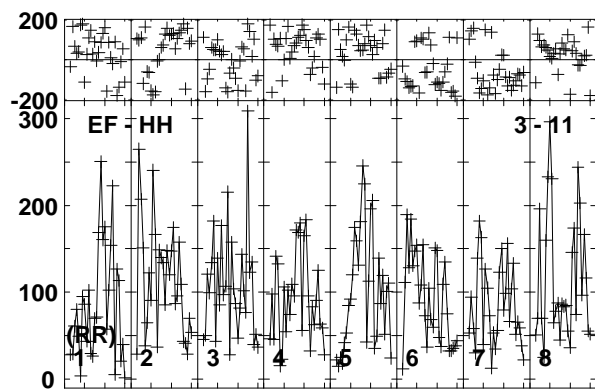
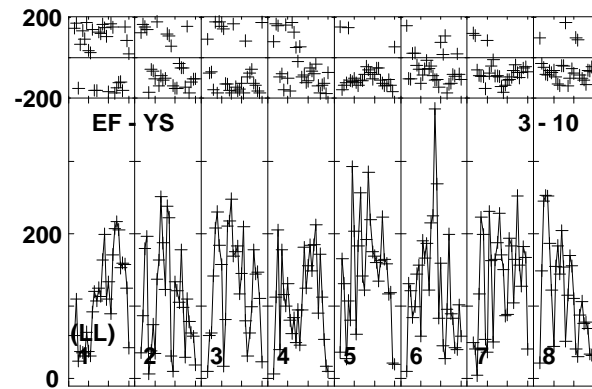
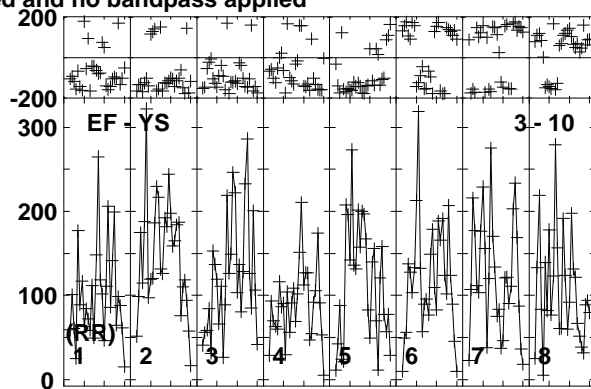
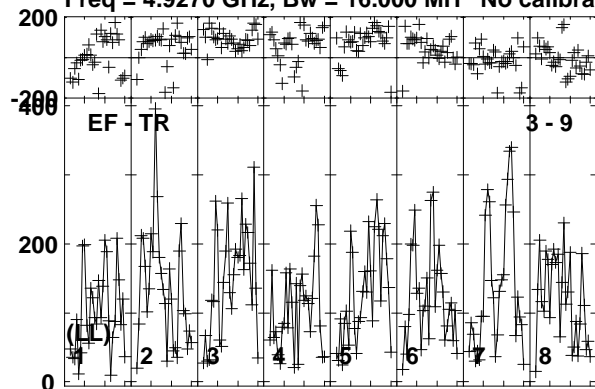

Lower frame: Micro Ampl Jy Top frame: Phas deg  
Vector averaged cross-power spectrum Baseline: EF (03) - TR (09)  
Timerange: 00/15:54:31 to 00/15:57:29

Plot file version 772 created 19-DEC-2018 17:59:04

AT2018\_RY007C.UVDATA.1

Freq = 4.9270 GHz, Bw = 16.000 MH No calibration applied and no bandpass applied

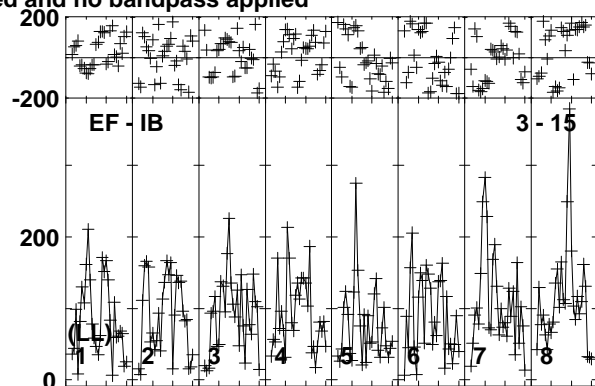
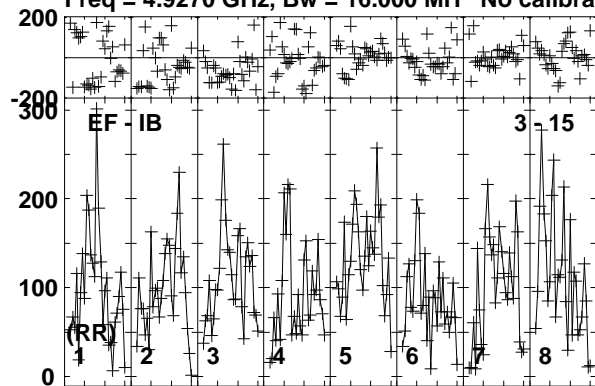

Lower frame: Micro Ampl Jy Top frame: Phas deg  
Vector averaged cross-power spectrum Baseline: EF (03) - IB (15)  
Timerange: 00/15:54:31 to 00/15:57:29

Plot file version 773 created 19-DEC-2018 17:59:04

J1619+2247 RY007C.UVDATA.1

Freq = 4.9270 GHz, Bw = 16.000 MH No calibration applied and no bandpass applied

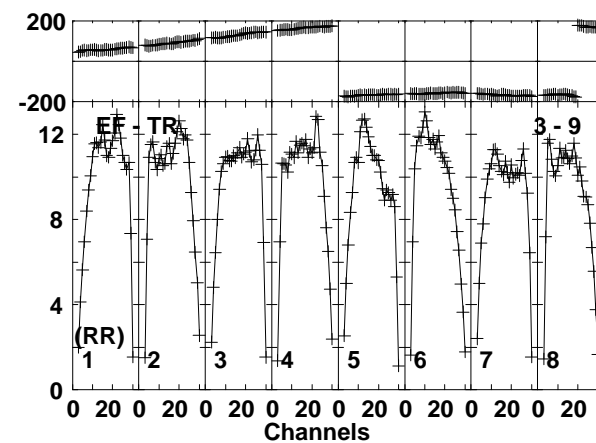
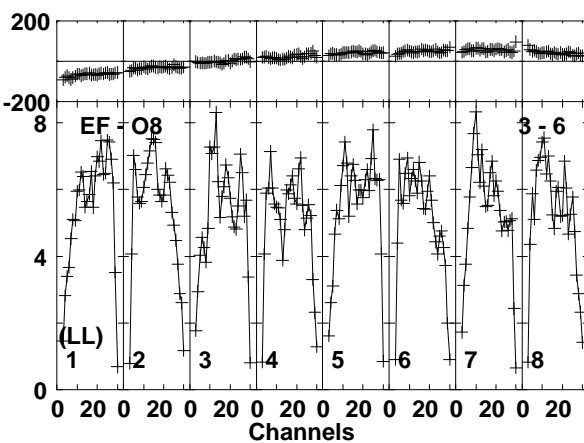
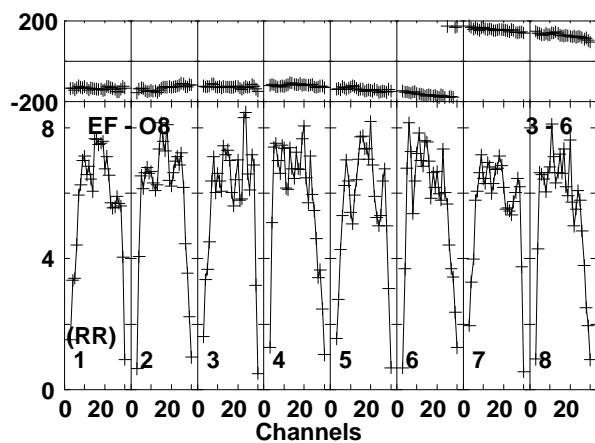
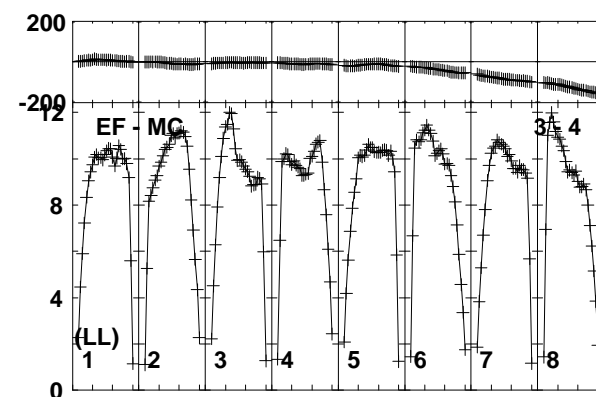
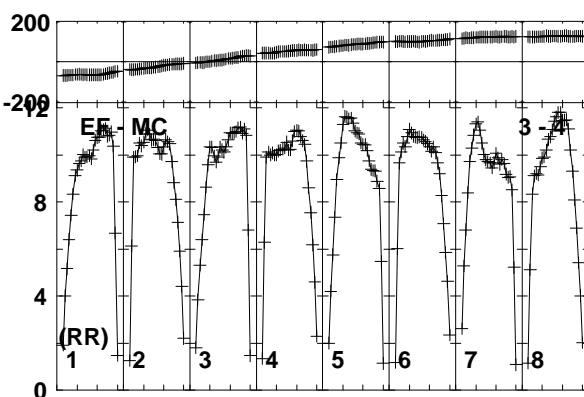
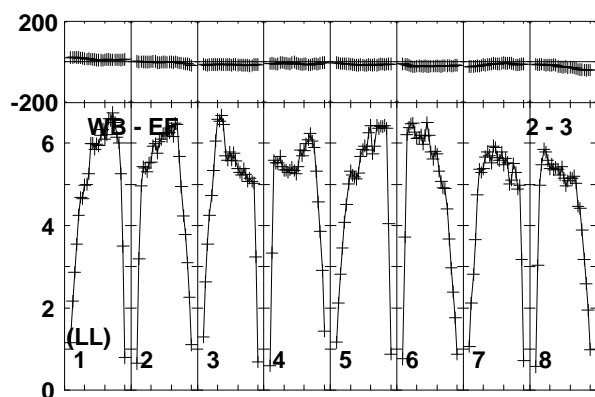
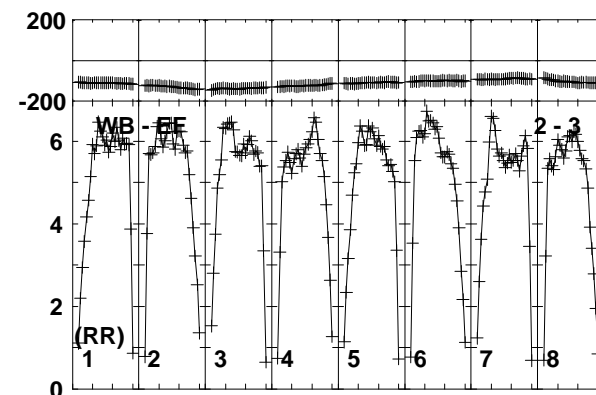
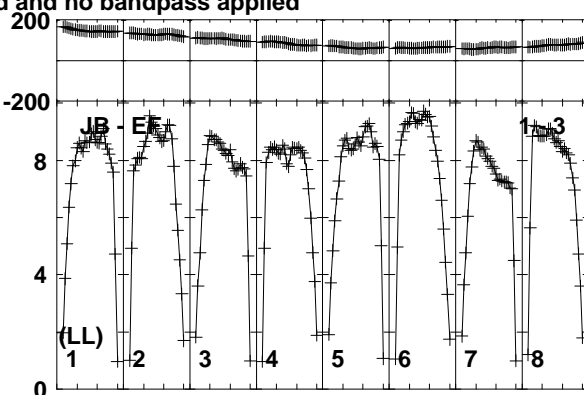
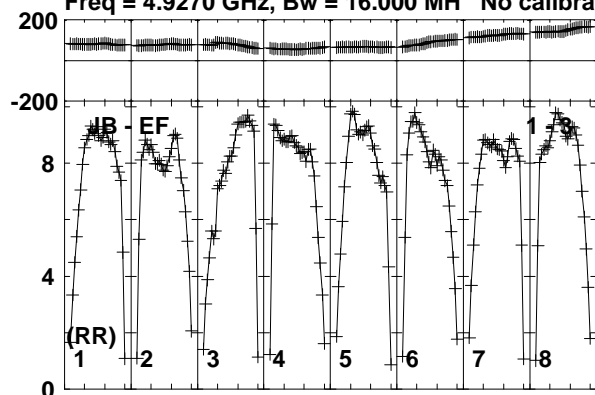

Lower frame: Milli Ampl Jy Top frame: Phas deg  
Vector averaged cross-power spectrum Baseline: JB (01) - EF (03)  
Timerange: 00/15:57:31 to 00/15:58:29

Plot file version 774 created 19-DEC-2018 17:59:04

J1619+2247 RY007C.UVDATA.1

Freq = 4.9270 GHz, Bw = 16.000 MH No calibration applied and no bandpass applied

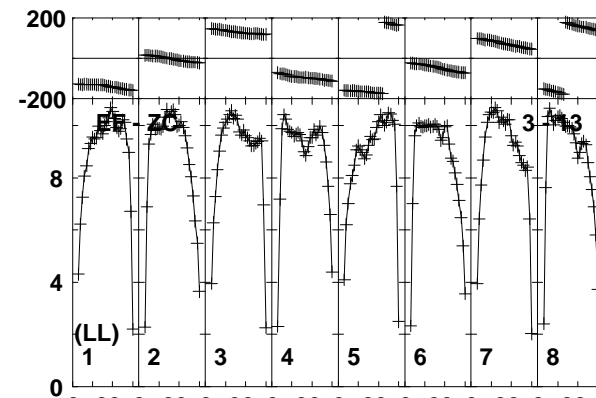
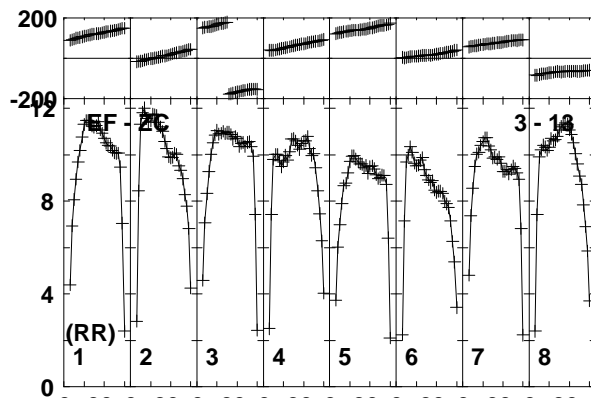
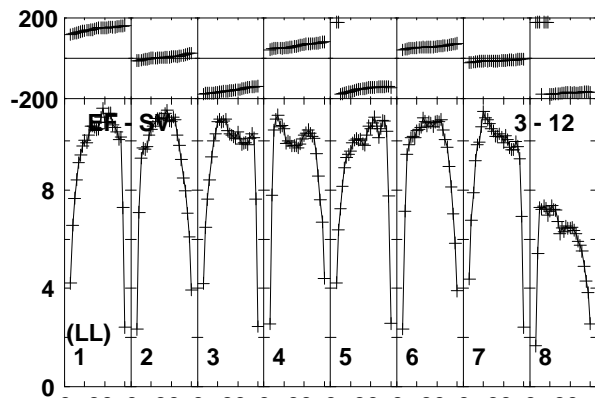
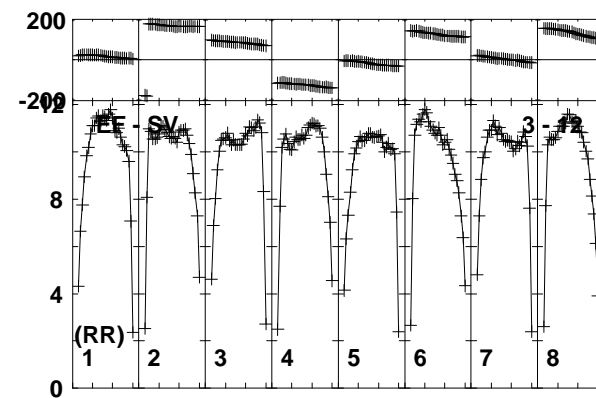
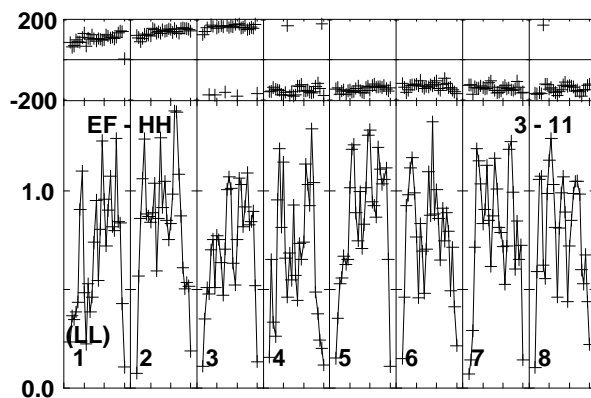
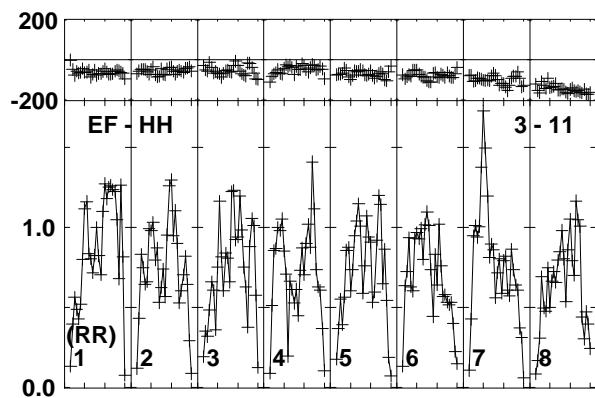
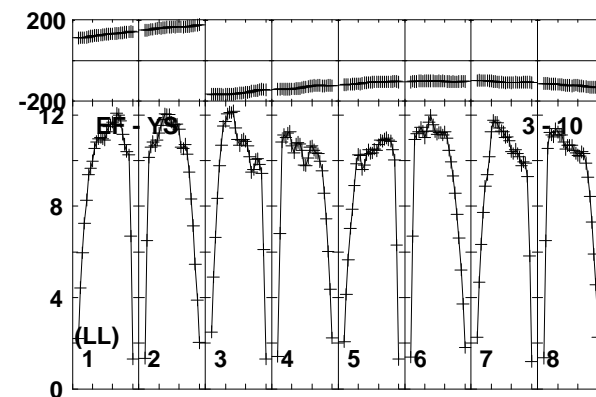
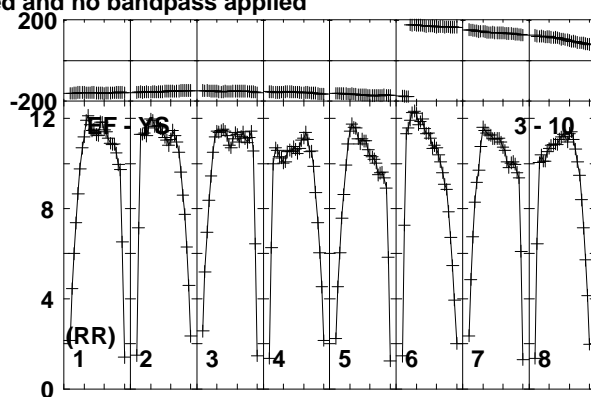
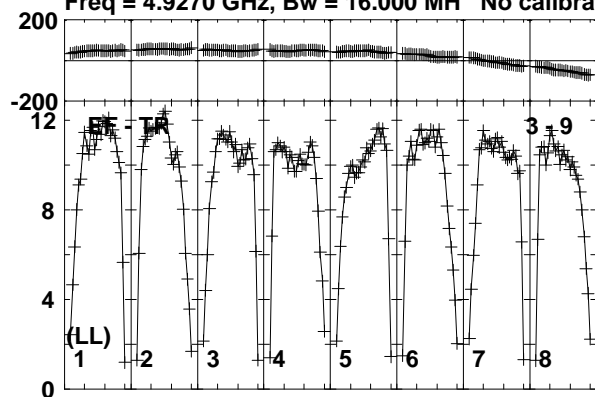

Lower frame: Milli Ampl Jy Top frame: Phas deg  
Vector averaged cross-power spectrum Baseline: EF (03) - TR (09)  
Timerange: 00:15:57:31 to 00:15:58:29

Plot file version 775 created 19-DEC-2018 17:59:04  
J1619+2247 RY007C.UVDATA.1

Freq = 4.9270 GHz, Bw = 16.000 MH No calibration applied and no bandpass applied

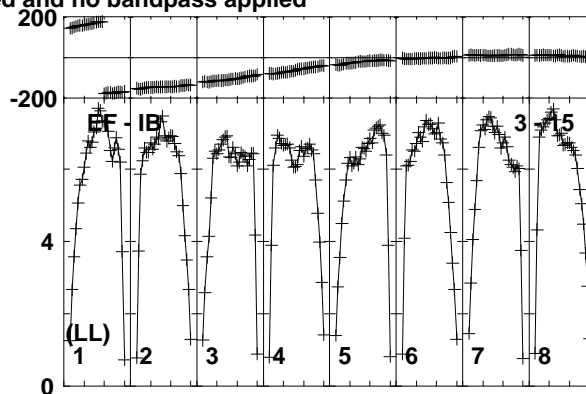
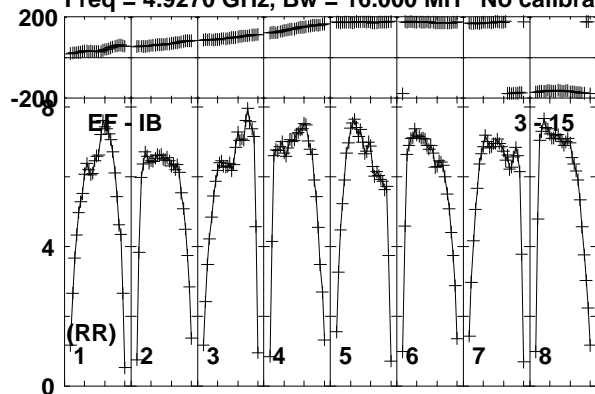

Lower frame: Milli Ampl Jy Top frame: Phas deg  
Vector averaged cross-power spectrum Baseline: EF (03) - IB (15)  
Timerange: 00/15:57:31 to 00/15:58:29

Plot file version 776 created 19-DEC-2018 17:59:04

AT2018\_RY007C.UVDATA.1

Freq = 4.9270 GHz, Bw = 16.000 MH No calibration applied and no bandpass applied

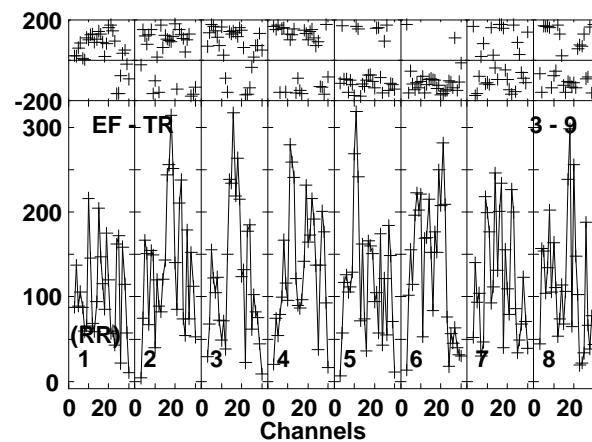
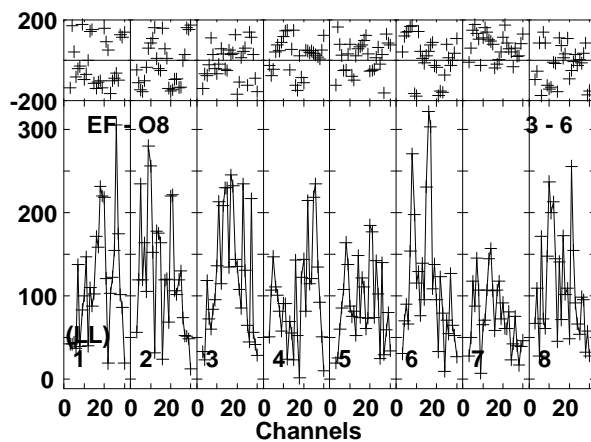
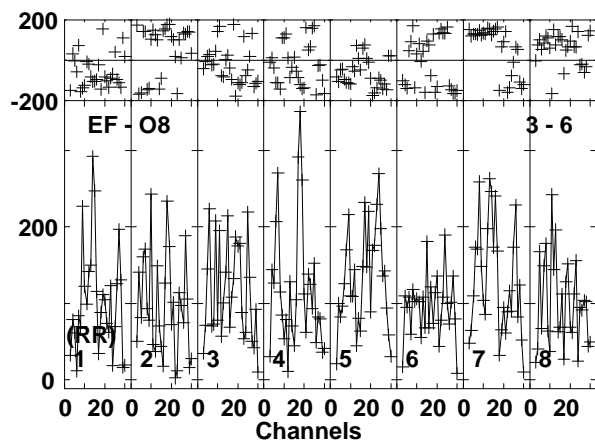
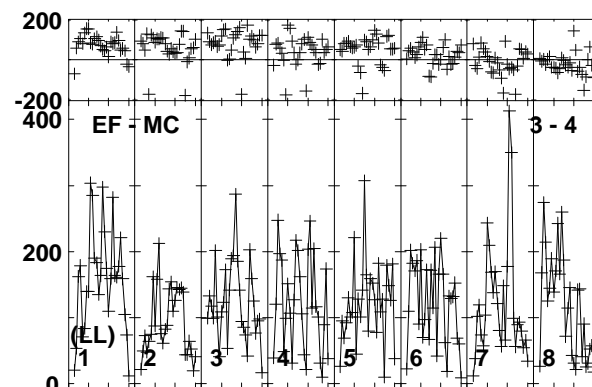
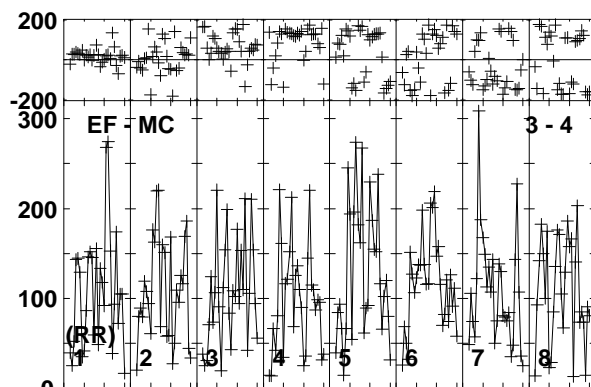
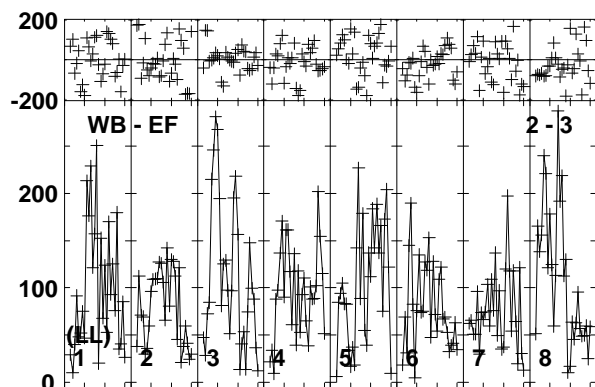
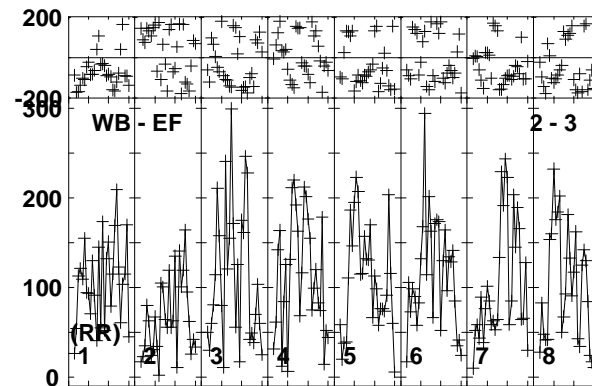
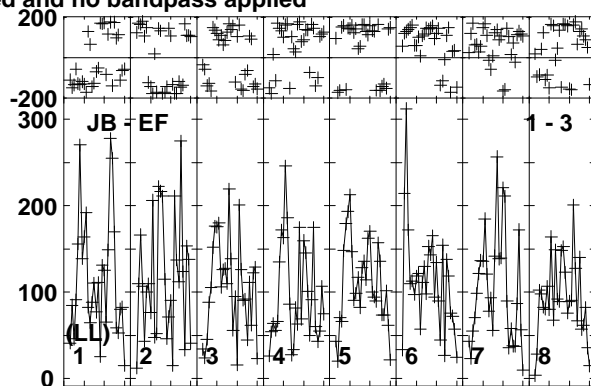
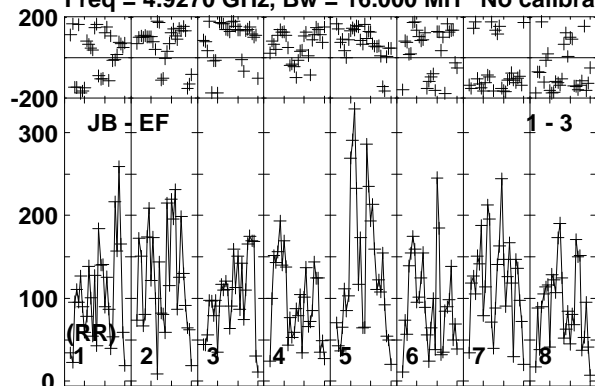

Lower frame: Micro Ampl Jy Top frame: Phas deg  
Vector averaged cross-power spectrum Baseline: JB (01) - EF (03)  
Timerange: 00/15:58:31 to 00/16:01:29

Plot file version 777 created 19-DEC-2018 17:59:04

AT2018\_RY007C.UVDATA.1

Freq = 4.9270 GHz, Bw = 16.000 MH No calibration applied and no bandpass applied

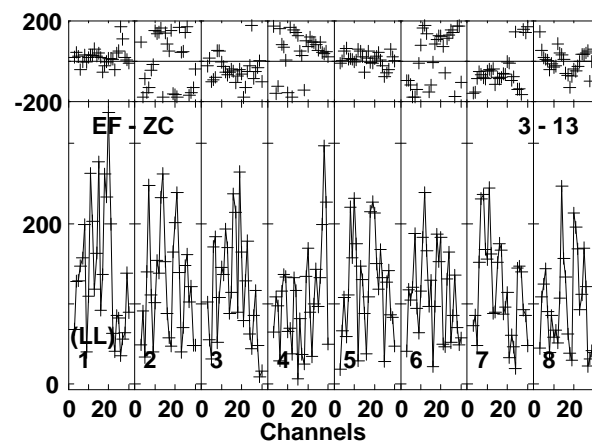
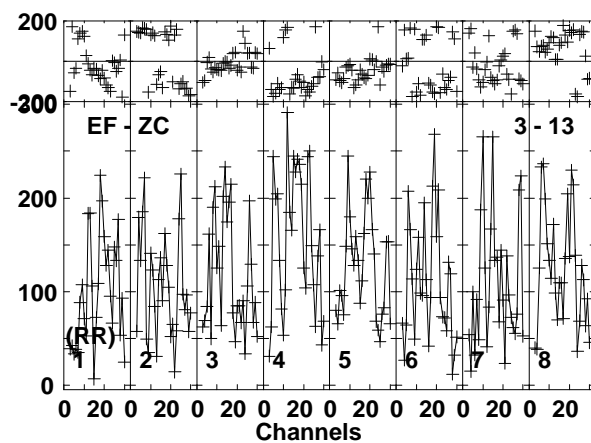
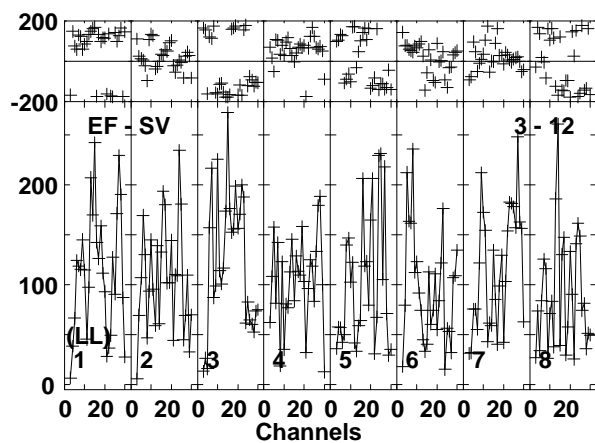
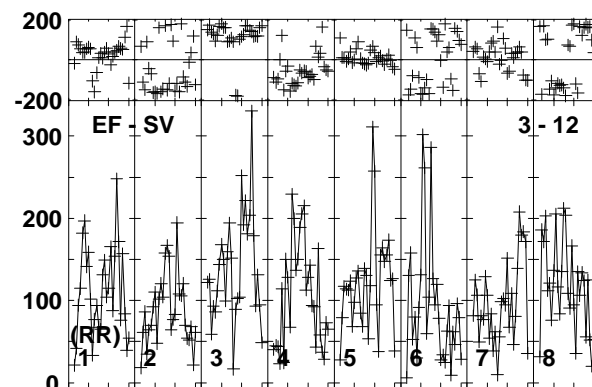
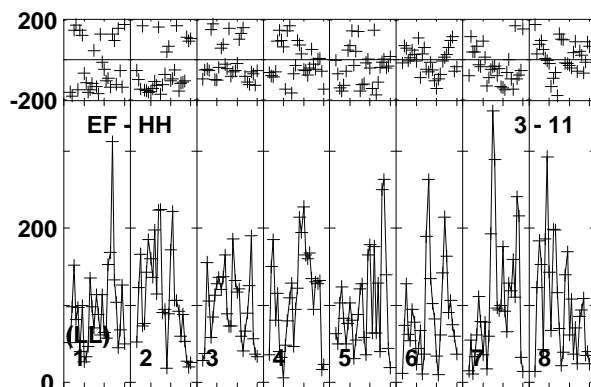
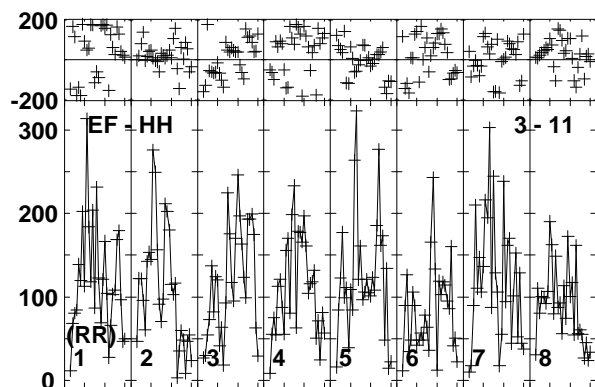
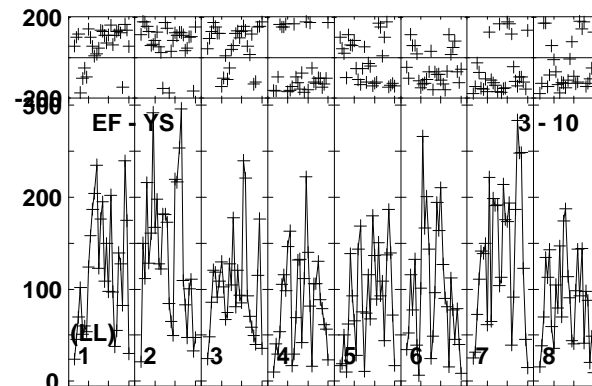
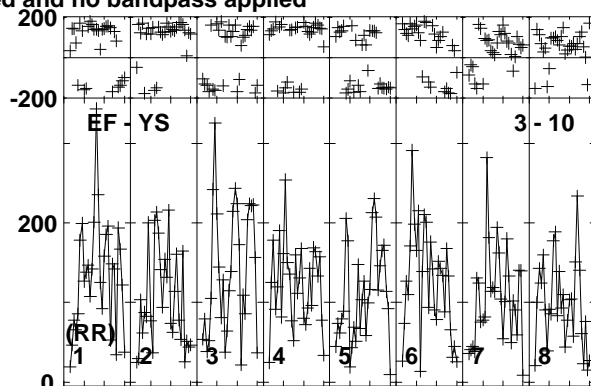
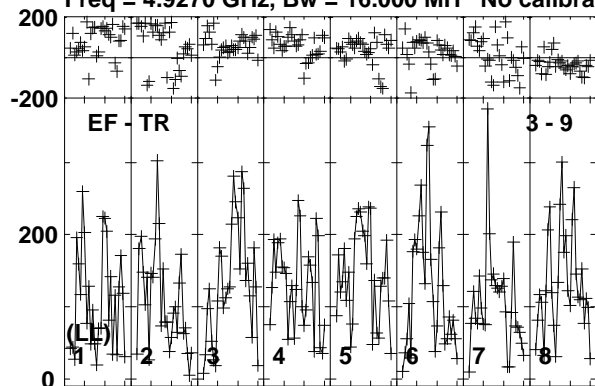

Lower frame: Micro Ampl Jy Top frame: Phas deg  
Vector averaged cross-power spectrum Baseline: EF (03) - TR (09)  
Timerange: 00/15:58:31 to 00/16:01:29

Plot file version 778 created 19-DEC-2018 17:59:05

AT2018\_RY007C.UVDATA.1

Freq = 4.9270 GHz, Bw = 16.000 MH No calibration applied and no bandpass applied

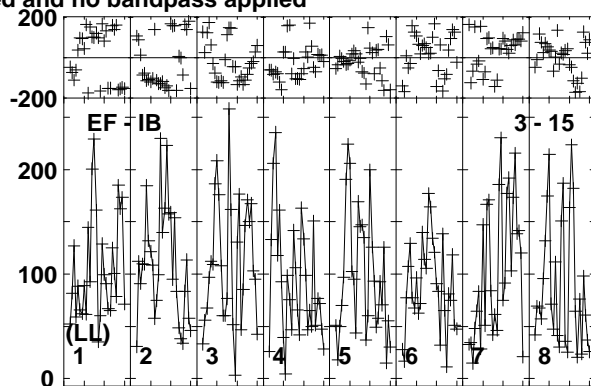
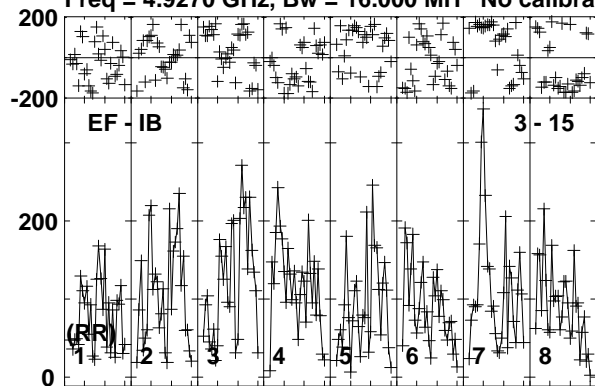

Lower frame: Micro Ampl Jy Top frame: Phas deg  
Vector averaged cross-power spectrum Baseline: EF (03) - IB (15)  
Timerange: 00/15:58:31 to 00/16:01:29



Plot file version 779 created 19-DEC-2018 17:59:05

J1619+2247 RY007C.UVDATA.1

Freq = 4.9270 GHz, Bw = 16.000 MH No calibration applied and no bandpass applied

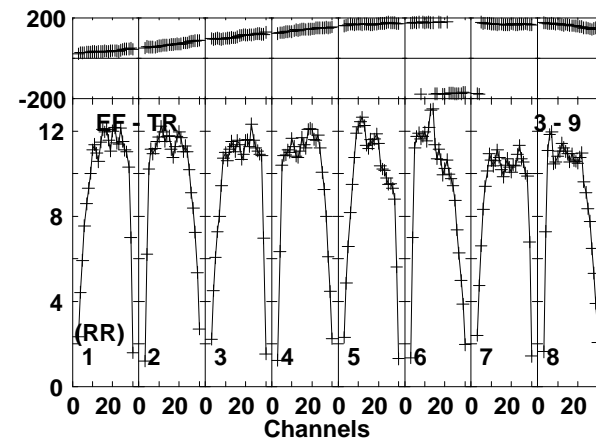
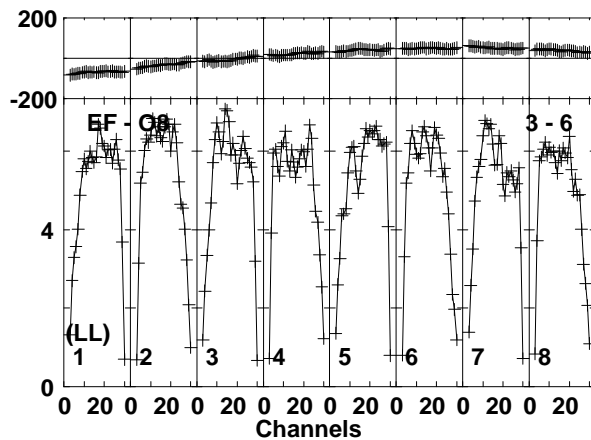
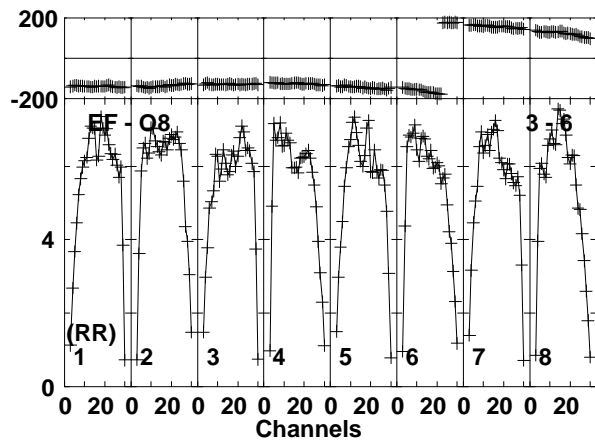
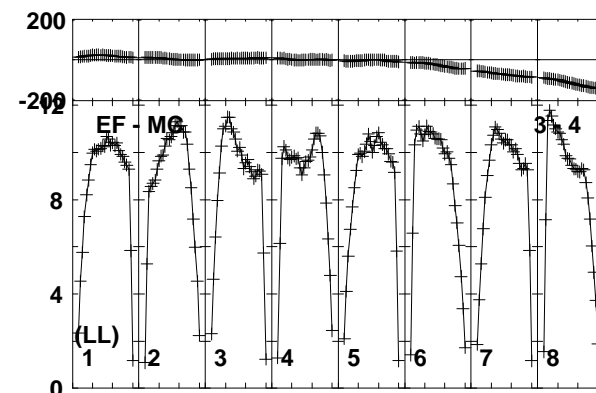
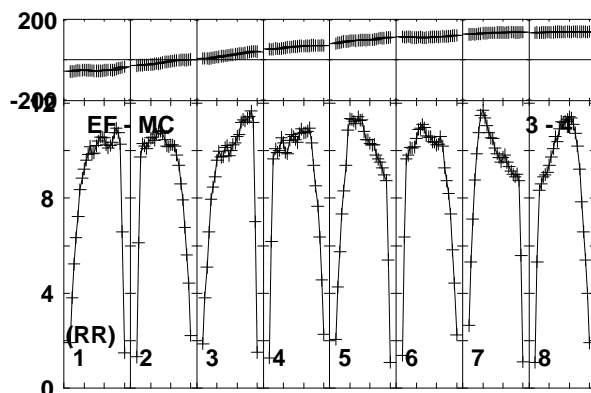
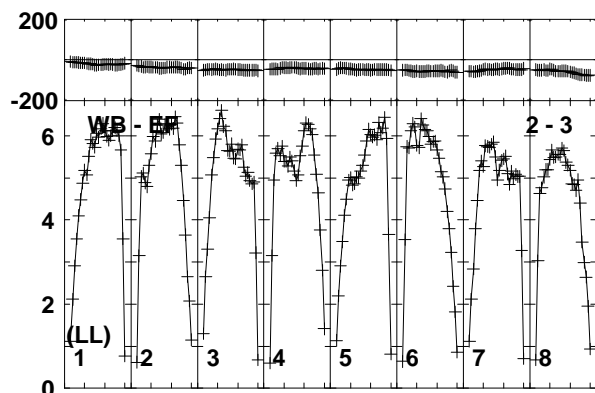
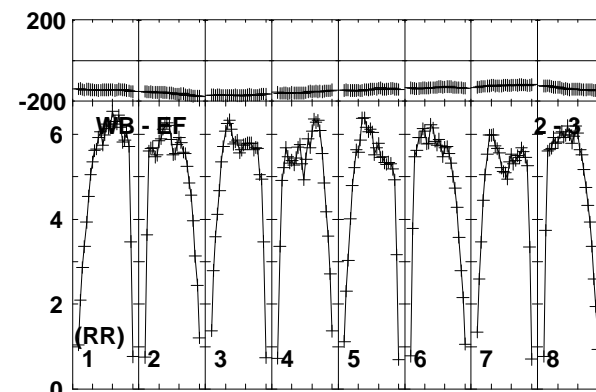
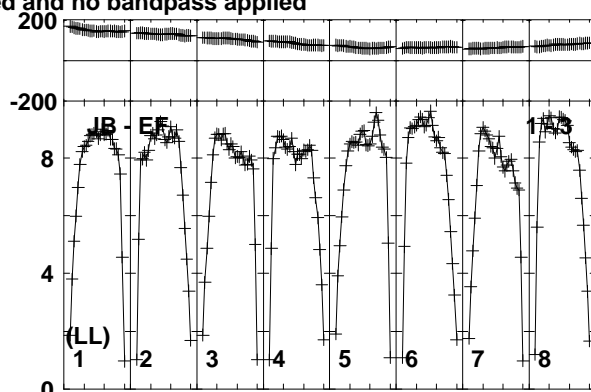
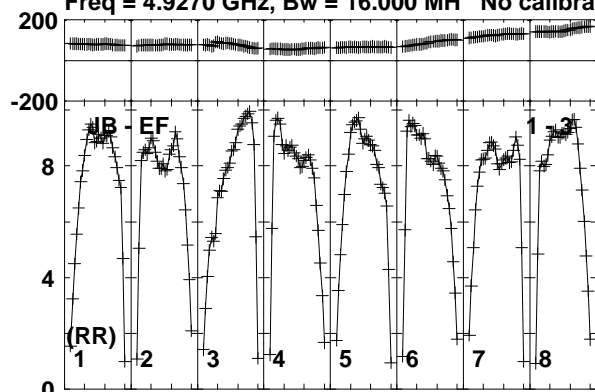

Lower frame: Milli Ampl Jy Top frame: Phas deg  
Vector averaged cross-power spectrum Baseline: JB (01) - EF (03)  
Timerange: 00/16:01:31 to 00/16:02:29

Plot file version 780 created 19-DEC-2018 17:59:05

J1619+2247 RY007C.UVDATA.1

Freq = 4.9270 GHz, Bw = 16.000 MH No calibration applied and no bandpass applied

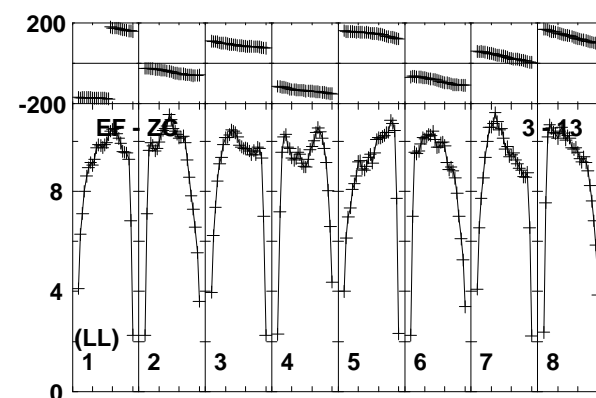
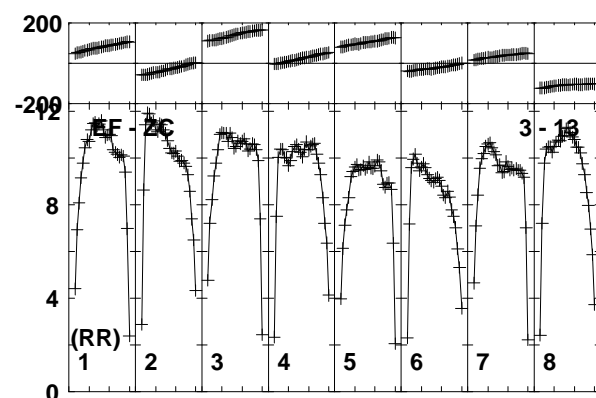
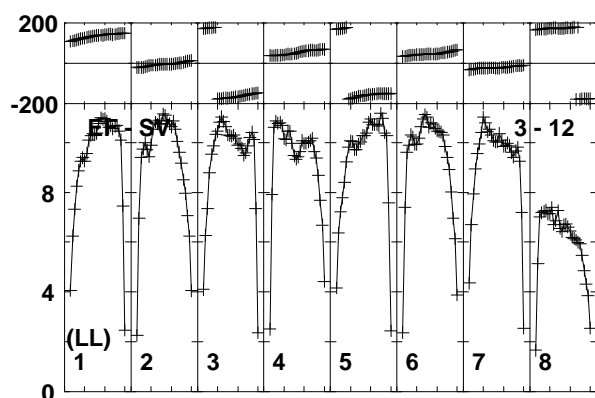
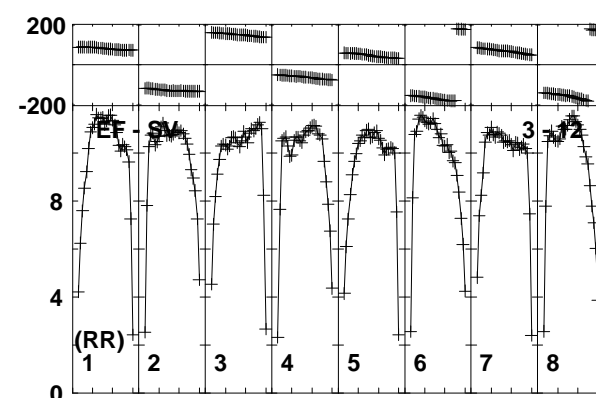
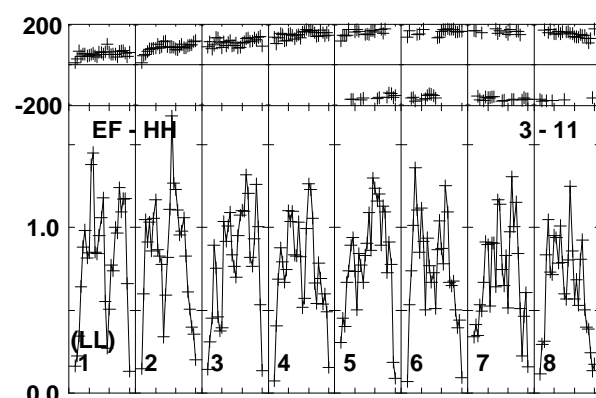
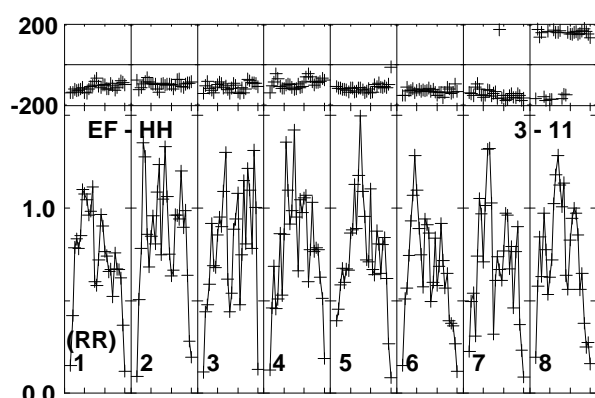
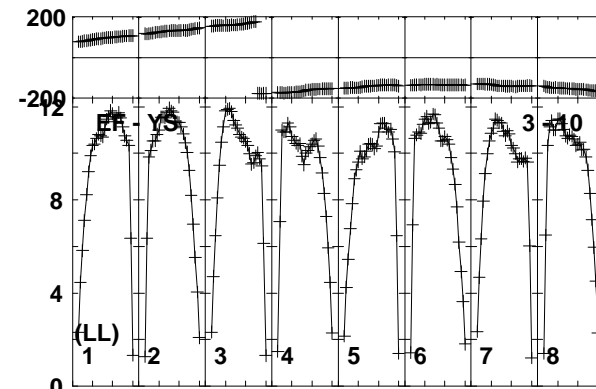
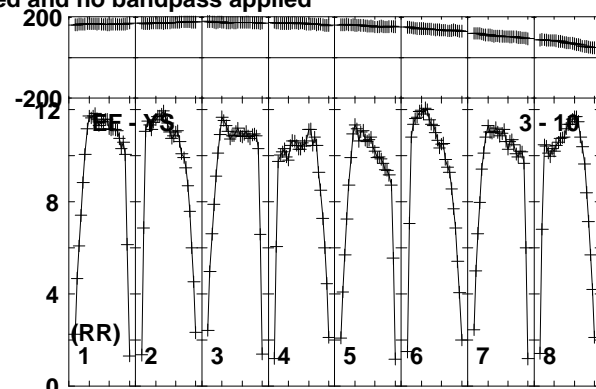
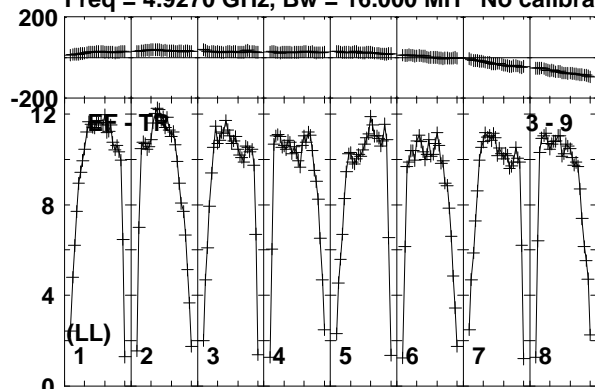

Lower frame: Milli Ampl Jy Top frame: Phas deg  
Vector averaged cross-power spectrum Baseline: EF (03) - TR (09)  
Timerange: 00/16:01:31 to 00/16:02:29

Plot file version 781 created 19-DEC-2018 17:59:05  
J1619+2247 RY007C.UVDATA.1

Freq = 4.9270 GHz, Bw = 16.000 MH No calibration applied and no bandpass applied

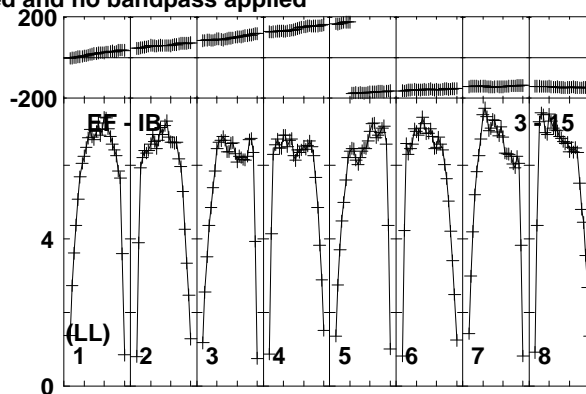
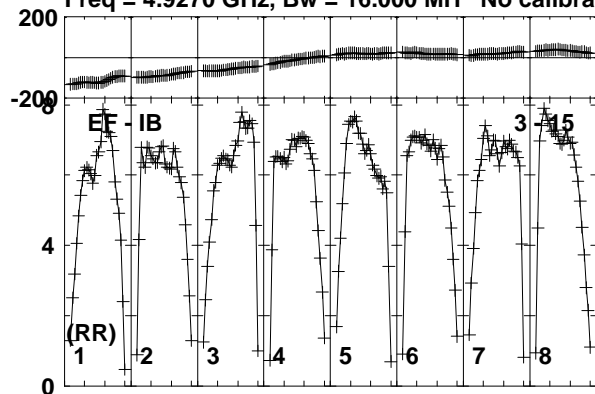

Lower frame: Milli Ampl Jy Top frame: Phas deg  
Vector averaged cross-power spectrum Baseline: EF (03) - IB (15)  
Timerange: 00/16:01:31 to 00/16:02:29

Plot file version 782 created 19-DEC-2018 17:59:05

VLA1 RY007C.UVDATA.1

Freq = 4.9270 GHz, Bw = 16.000 MH No calibration applied and no bandpass applied

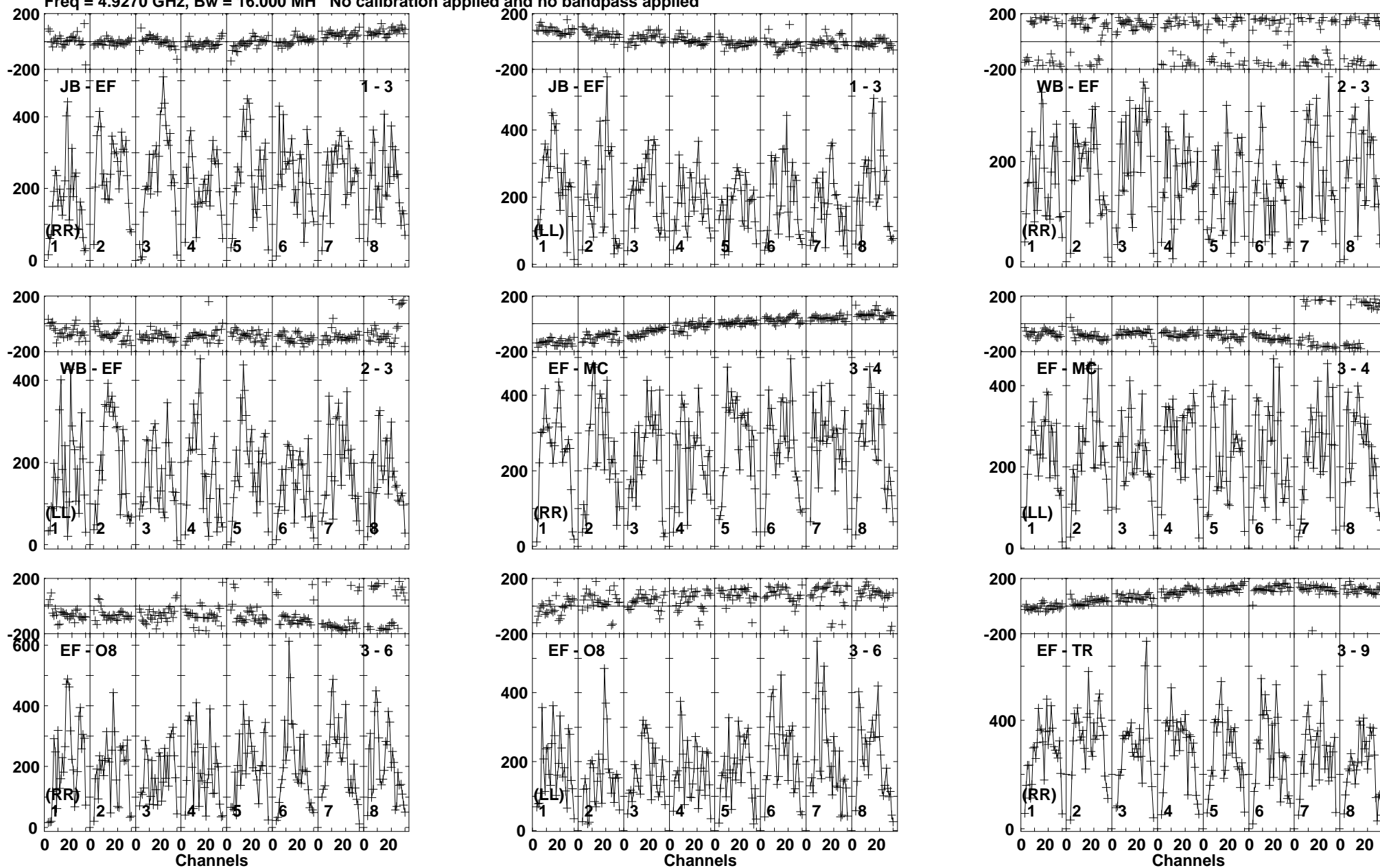

Lower frame: Micro Ampl Jy Top frame: Phas deg  
Vector averaged cross-power spectrum Baseline: JB (01) - EF (03)  
Timerange: 00/16:03:01 to 00/16:04:59

Plot file version 783 created 19-DEC-2018 17:59:05

VLA1 RY007C.UVDATA.1

Freq = 4.9270 GHz, Bw = 16.000 MH No calibration applied and no bandpass applied

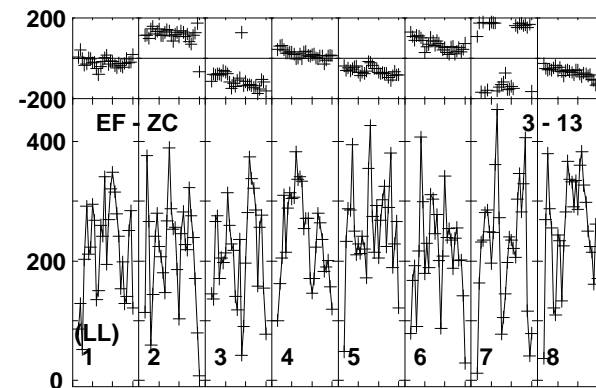
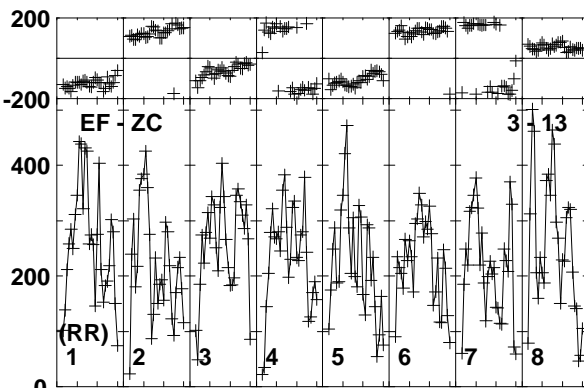
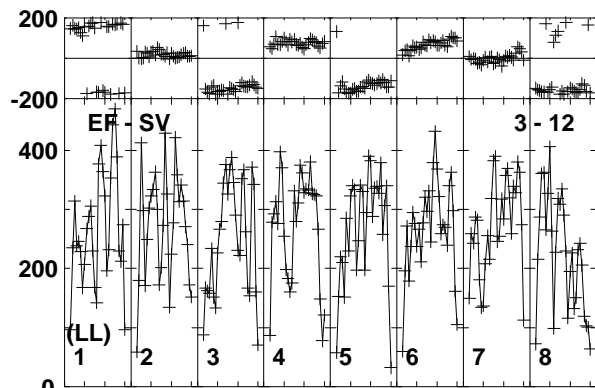
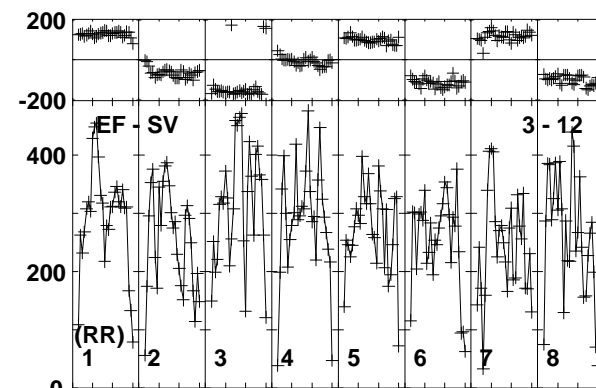
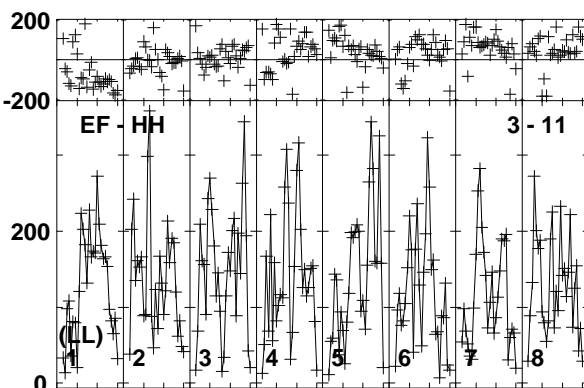
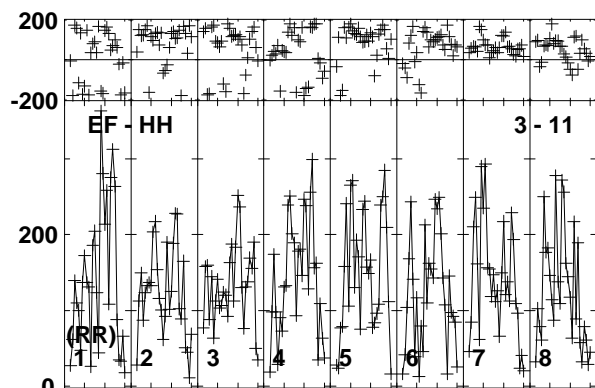
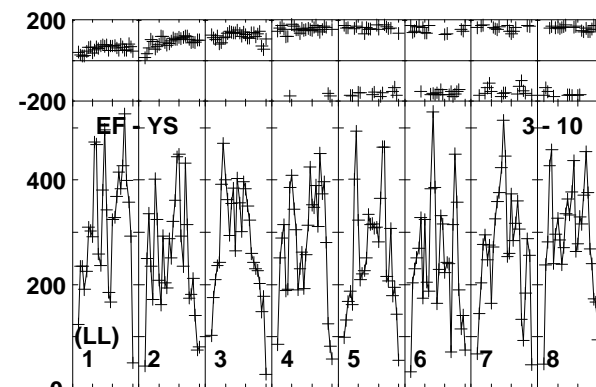
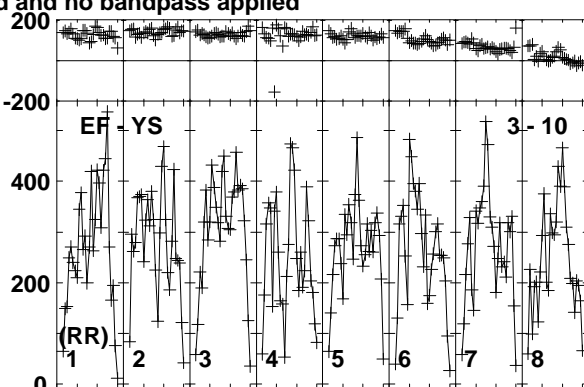
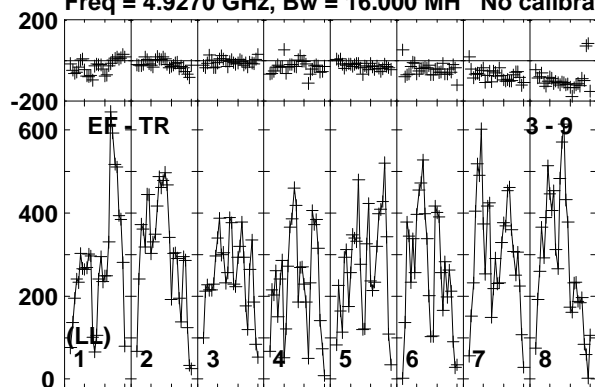

Lower frame: Micro Ampl Jy Top frame: Phas deg  
Vector averaged cross-power spectrum Baseline: EF (03) - TR (09)  
Timerange: 00/16:03:01 to 00/16:04:59

Plot file version 784 created 19-DEC-2018 17:59:05

VLA1 RY007C.UVDATA.1

Freq = 4.9270 GHz, Bw = 16.000 MH No calibration applied and no bandpass applied

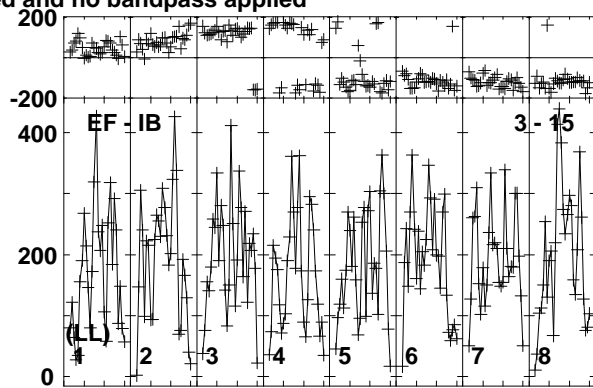
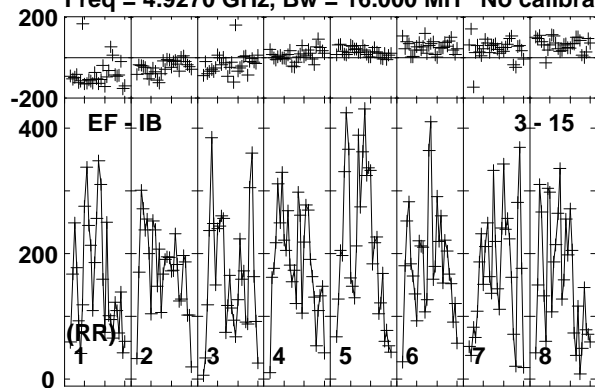

Lower frame: Micro Ampl Jy Top frame: Phas deg  
Vector averaged cross-power spectrum Baseline: EF (03) - IB (15)  
Timerange: 00/16:03:01 to 00/16:04:59

Plot file version 785 created 19-DEC-2018 17:59:05

J1619+2247 RY007C.UVDATA.1

Freq = 4.9270 GHz, Bw = 16.000 MH No calibration applied and no bandpass applied

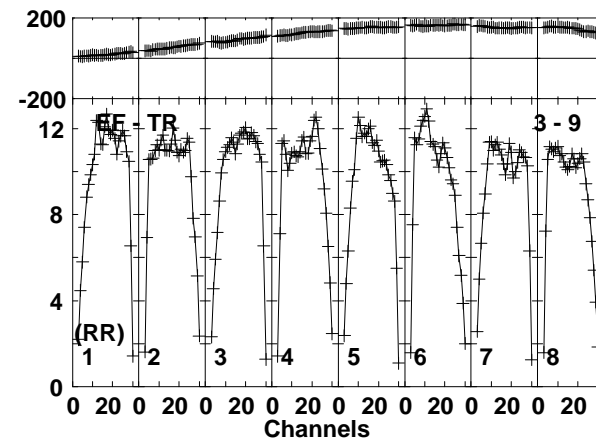
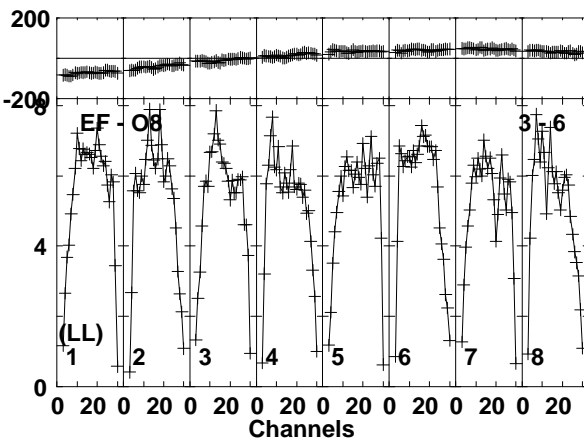
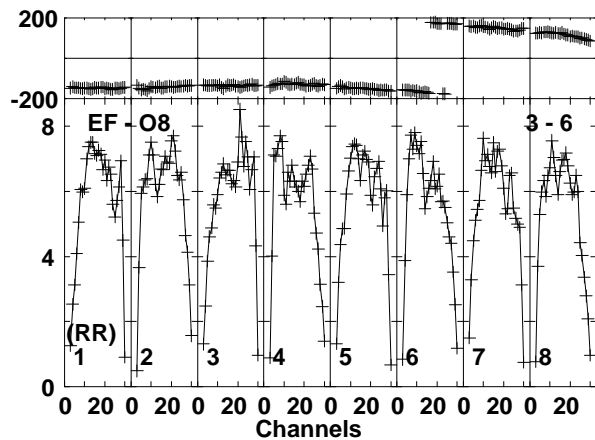
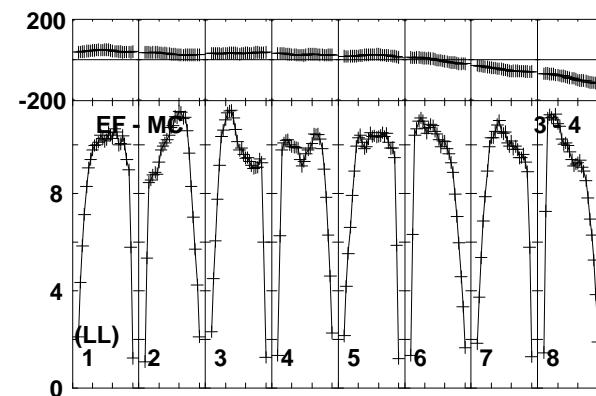
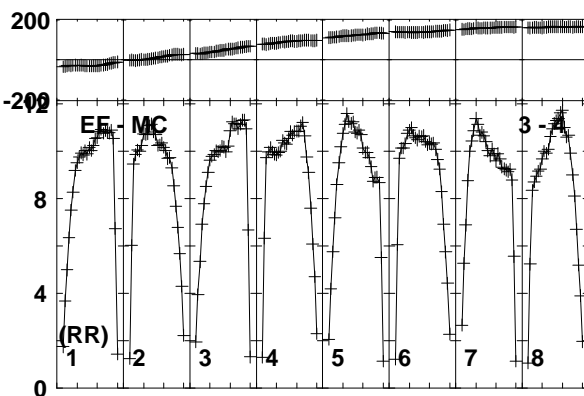
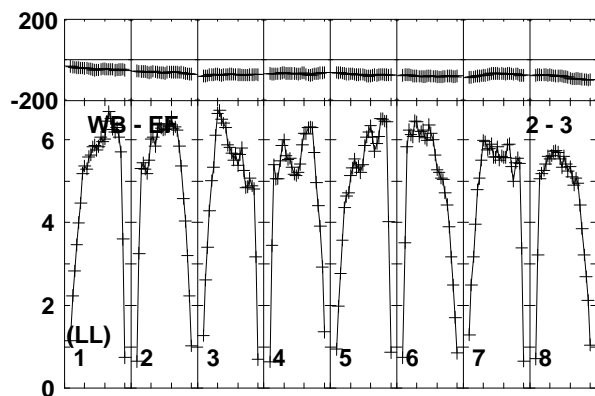
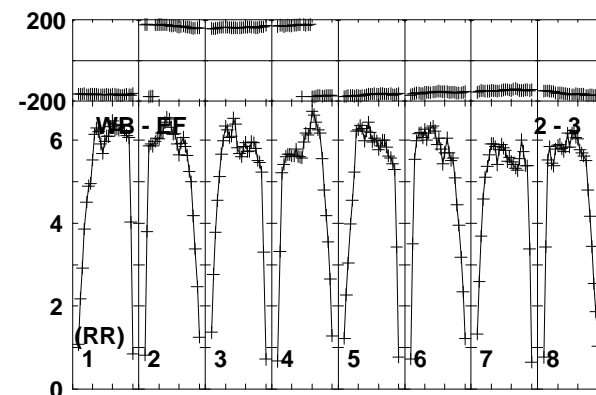
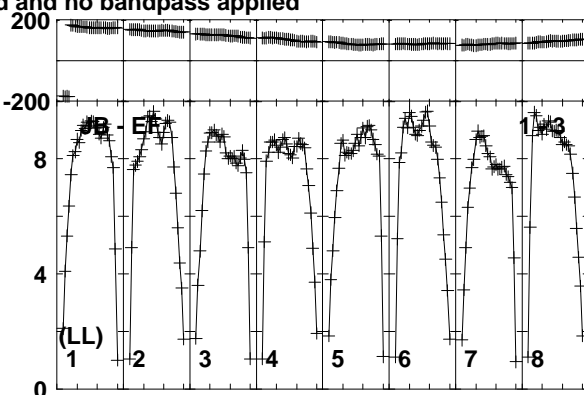
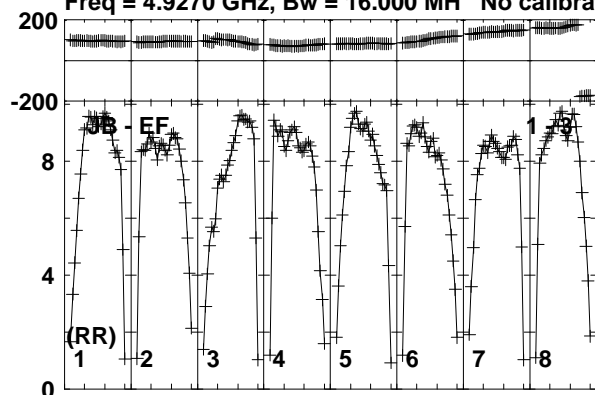

Lower frame: Milli Ampl Jy Top frame: Phas deg  
Vector averaged cross-power spectrum Baseline: JB (01) - EF (03)  
Timerange: 00/16:05:01 to 00/16:05:59

Plot file version 786 created 19-DEC-2018 17:59:05

J1619+2247 RY007C.UVDATA.1

Freq = 4.9270 GHz, Bw = 16.000 MH No calibration applied and no bandpass applied

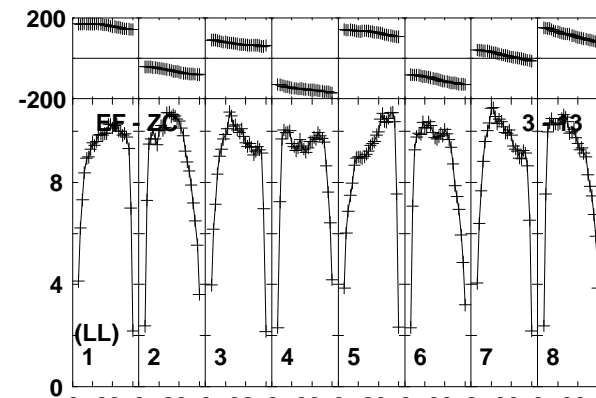
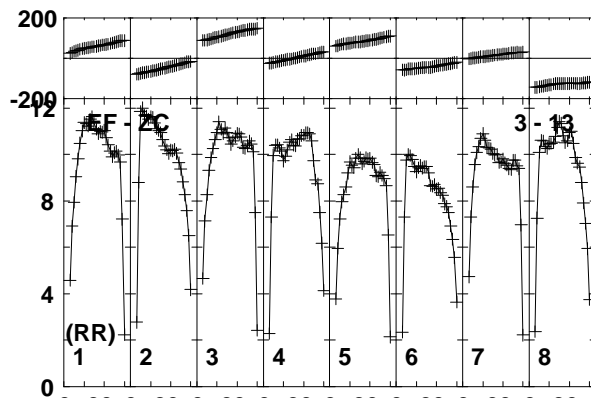
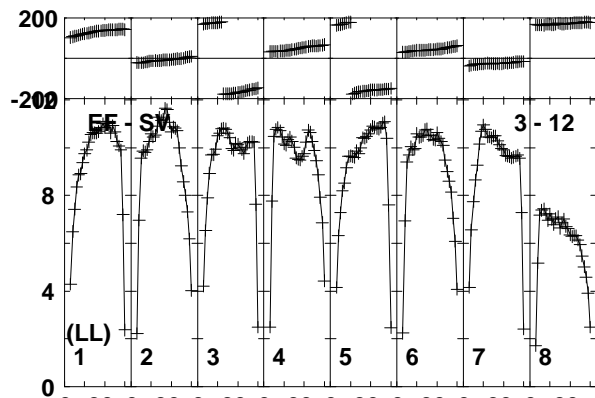
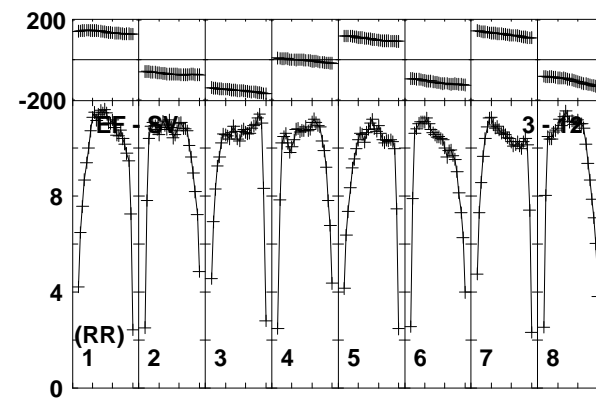
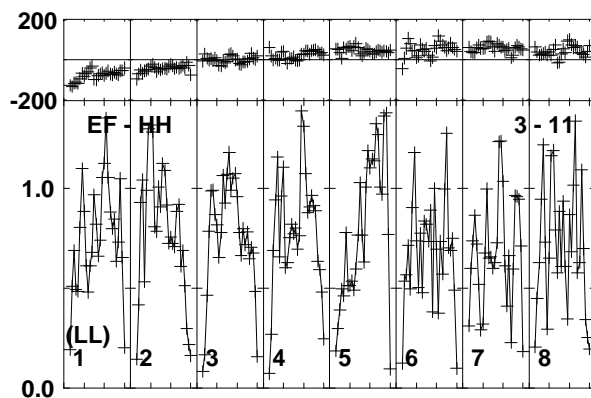
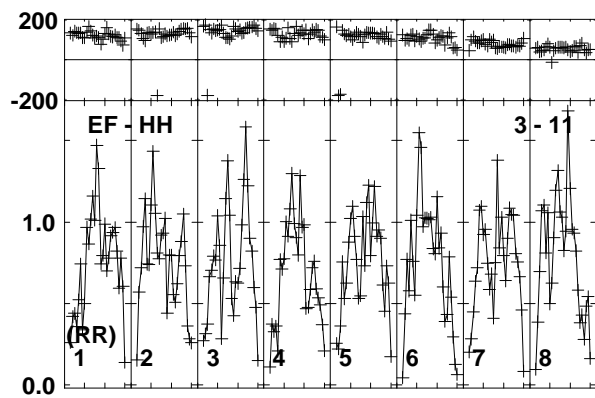
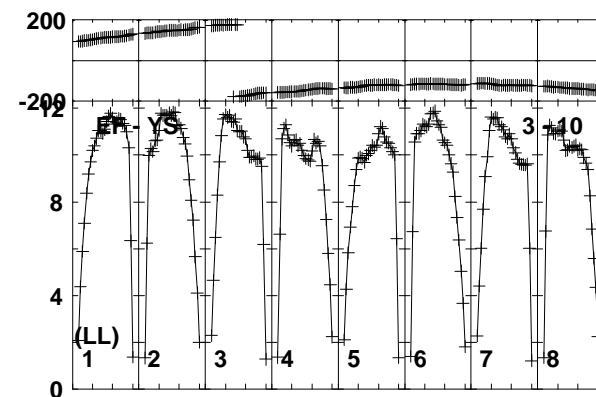
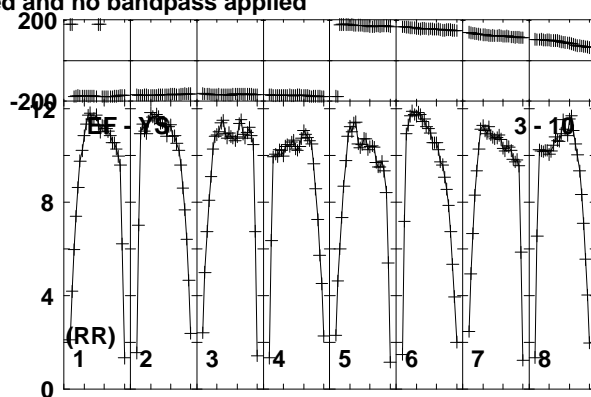
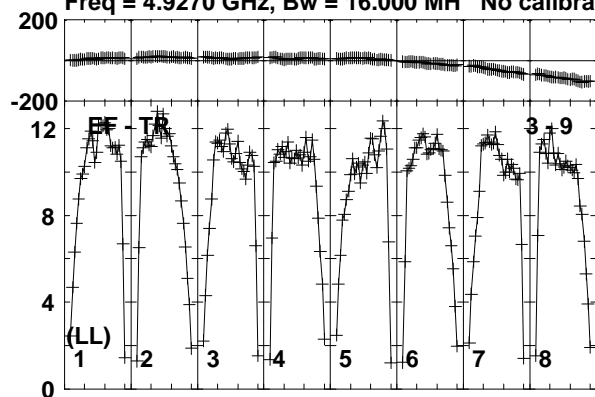

Lower frame: Milli Ampl Jy Top frame: Phas deg  
Vector averaged cross-power spectrum Baseline: EF (03) - TR (09)  
Timerange: 00/16:05:01 to 00/16:05:59



Plot file version 787 created 19-DEC-2018 17:59:05  
J1619+2247 RY007C.UVDATA.1

Freq = 4.9270 GHz, Bw = 16.000 MH No calibration applied and no bandpass applied

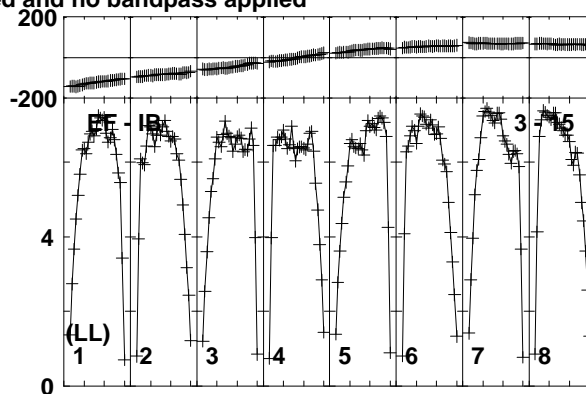
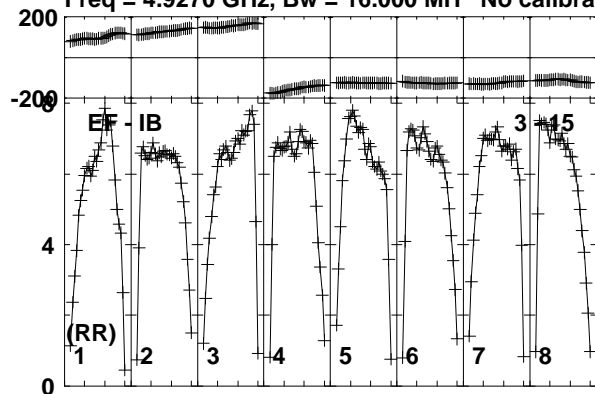

Lower frame: Milli Ampl Jy Top frame: Phas deg  
Vector averaged cross-power spectrum Baseline: EF (03) - IB (15)  
Timerange: 00/16:05:01 to 00/16:05:59

Plot file version 788 created 19-DEC-2018 17:59:05

AT2018\_RY007C.UVDATA.1

Freq = 4.9270 GHz, Bw = 16.000 MH No calibration applied and no bandpass applied

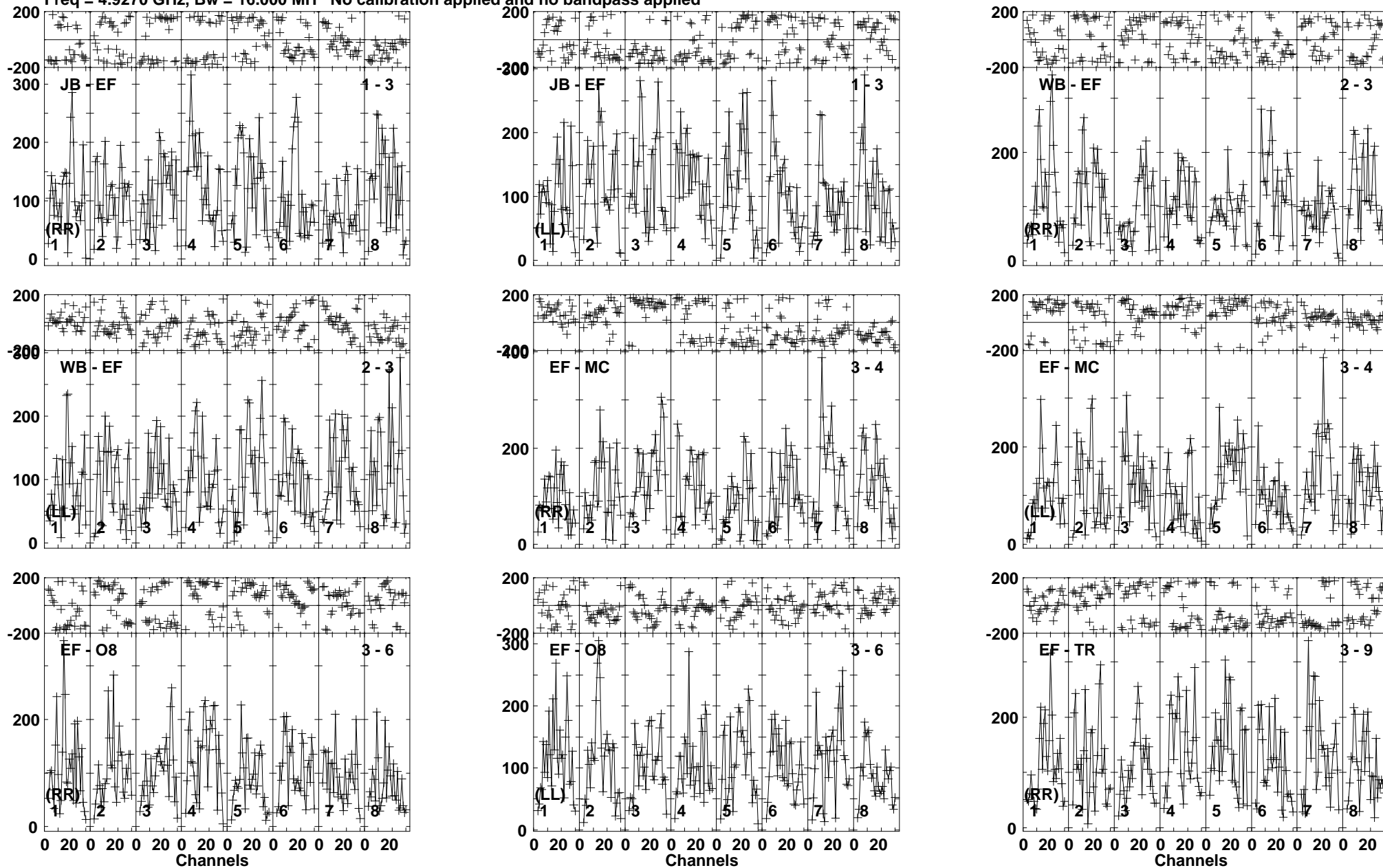

Lower frame: Micro Ampl Jy Top frame: Phas deg  
Vector averaged cross-power spectrum Baseline: JB (01) - EF (03)  
Timerange: 00/16:06:01 to 00/16:08:59

Plot file version 789 created 19-DEC-2018 17:59:05

AT2018\_RY007C.UVDATA.1

Freq = 4.9270 GHz, Bw = 16.000 MH No calibration applied and no bandpass applied

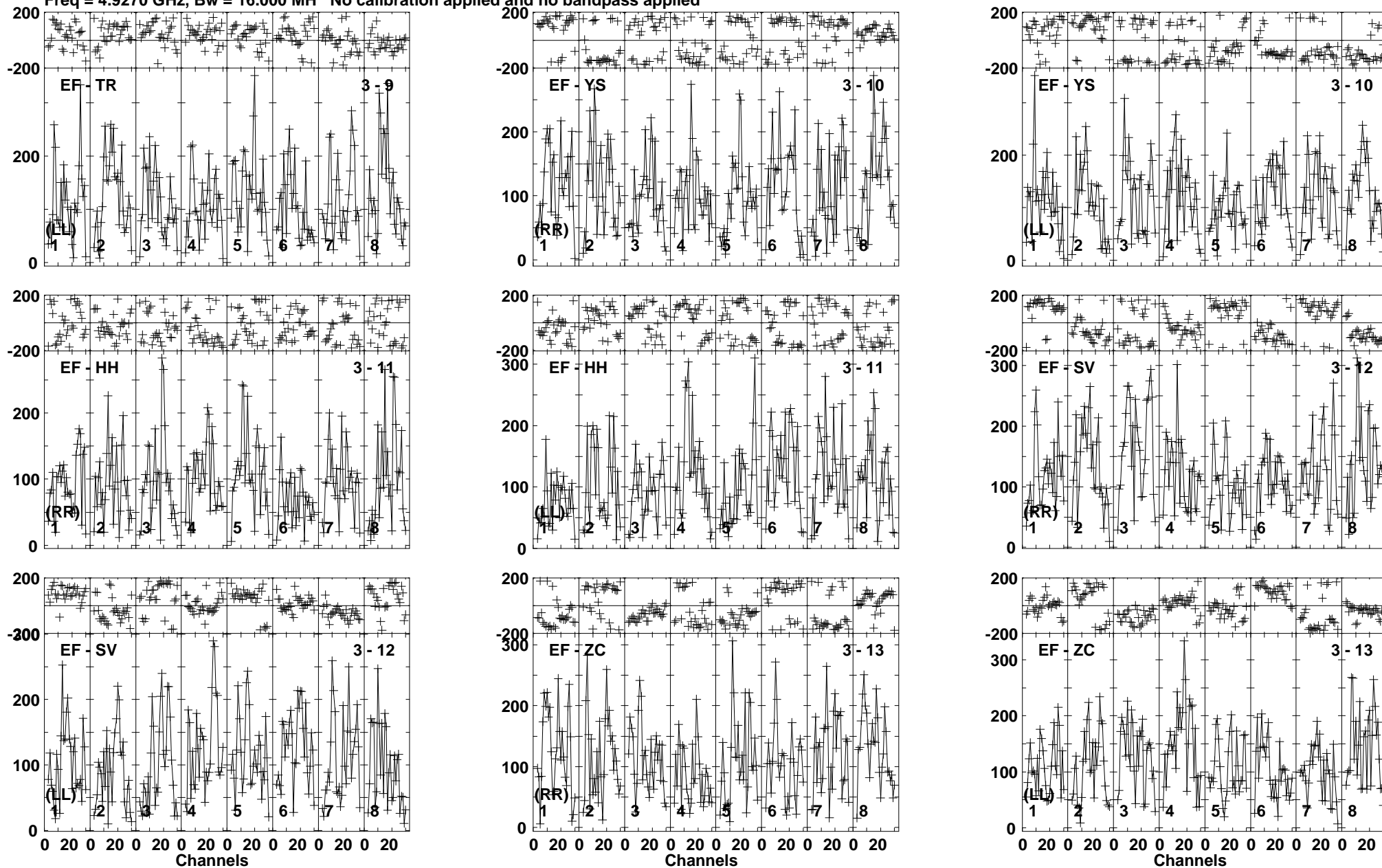

Lower frame: Micro Ampl Jy Top frame: Phas deg  
Vector averaged cross-power spectrum Baseline: EF (03) - TR (09)  
Timerange: 00/16:06:01 to 00/16:08:59

Plot file version 790 created 19-DEC-2018 17:59:05

AT2018\_RY007C.UVDATA.1

Freq = 4.9270 GHz, Bw = 16.000 MH No calibration applied and no bandpass applied

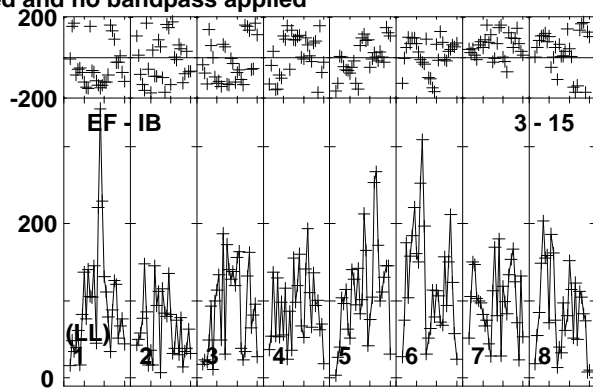
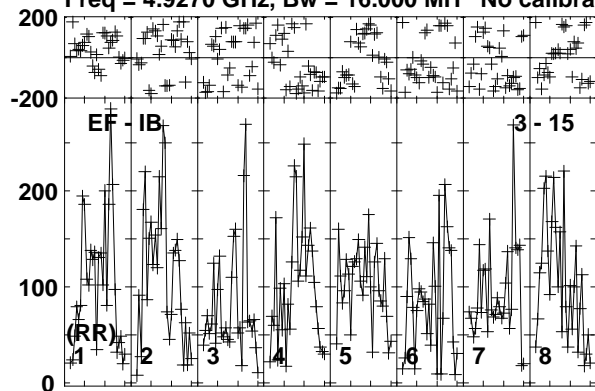

Lower frame: Micro Ampl Jy Top frame: Phas deg  
Vector averaged cross-power spectrum Baseline: EF (03) - IB (15)  
Timerange: 00/16:06:01 to 00/16:08:59

Plot file version 791 created 19-DEC-2018 17:59:05

J1619+2247 RY007C.UVDATA.1

Freq = 4.9270 GHz, Bw = 16.000 MH No calibration applied and no bandpass applied

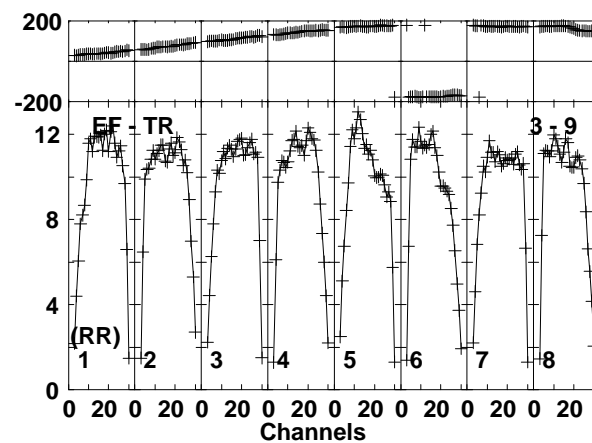
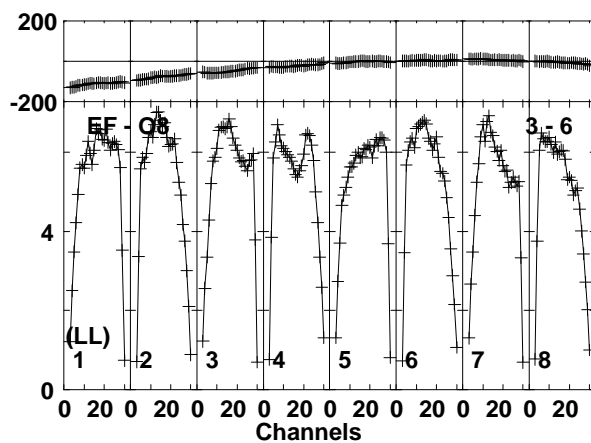
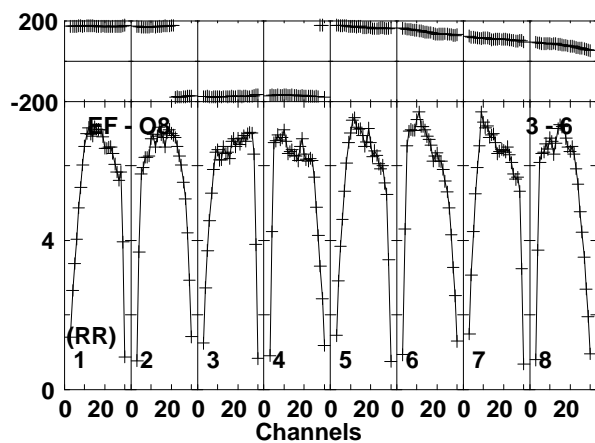
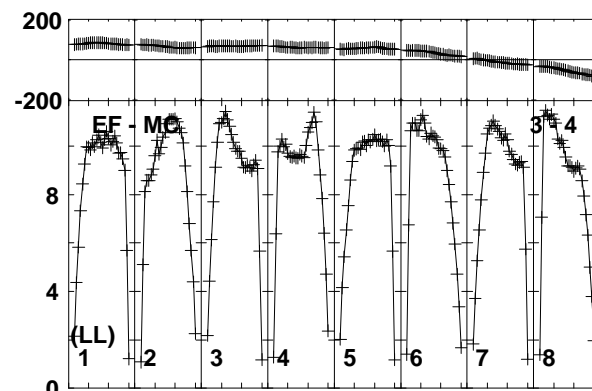
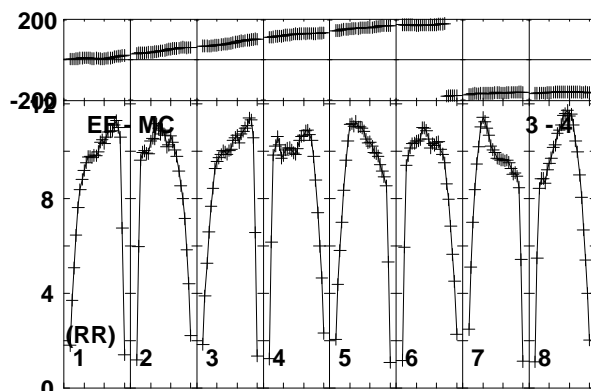
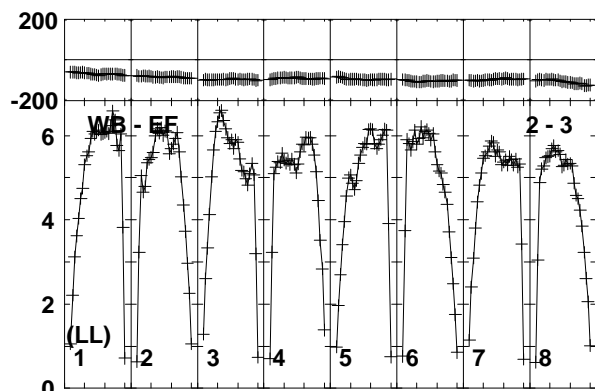
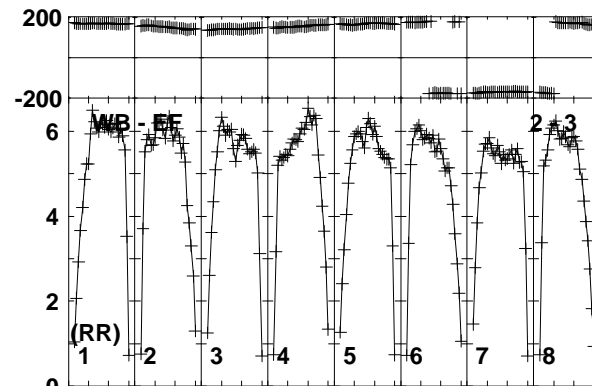
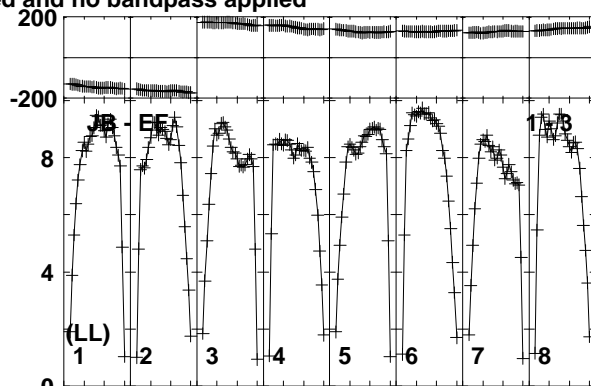
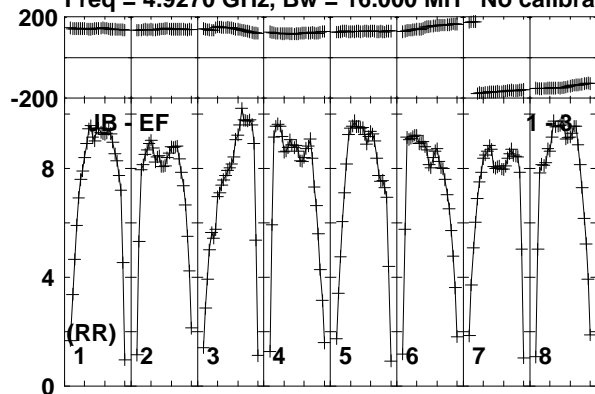

Lower frame: Milli Ampl Jy Top frame: Phas deg  
Vector averaged cross-power spectrum Baseline: JB (01) - EF (03)  
Timerange: 00/16:09:01 to 00/16:09:59

Plot file version 792 created 19-DEC-2018 17:59:05

J1619+2247 RY007C.UVDATA.1

Freq = 4.9270 GHz, Bw = 16.000 MH No calibration applied and no bandpass applied

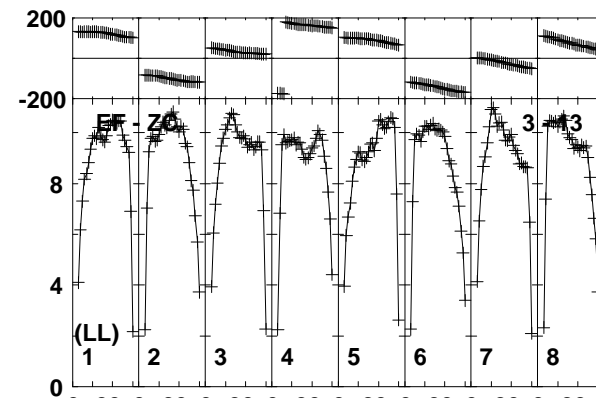
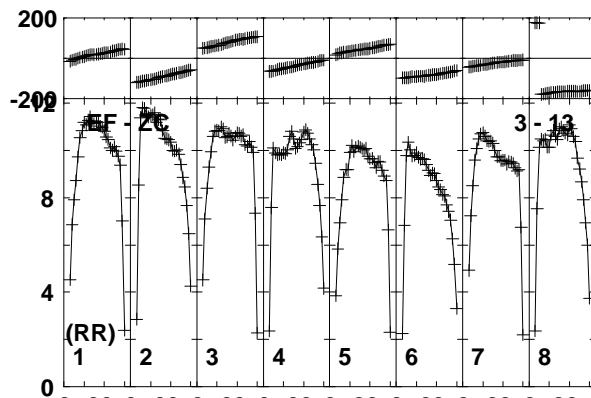
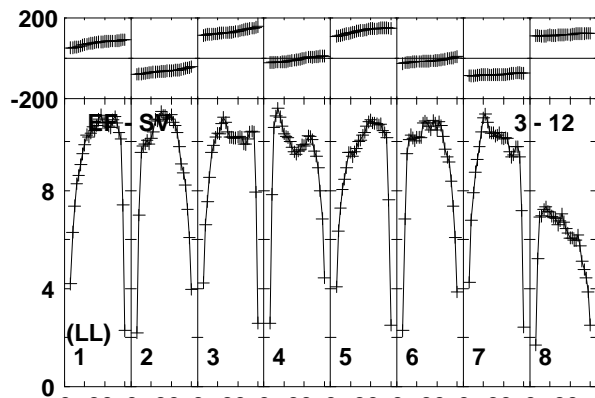
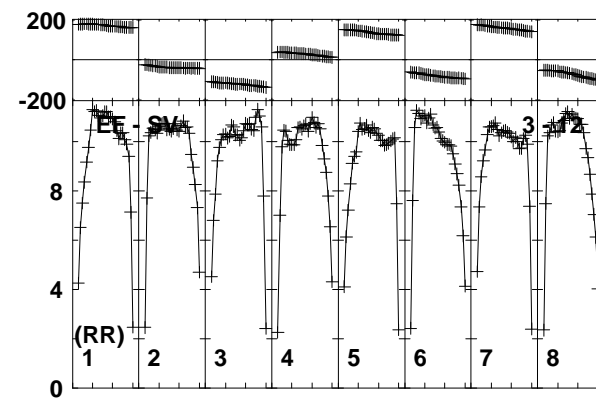
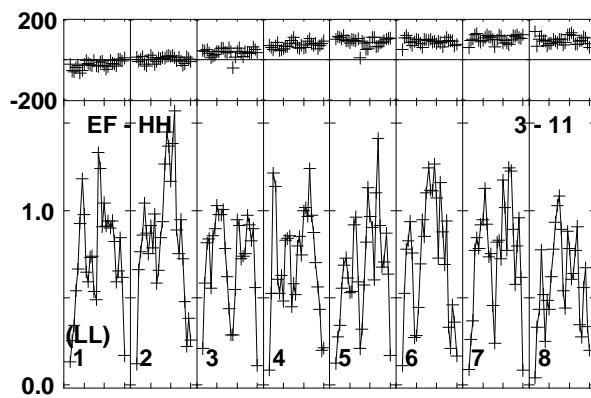
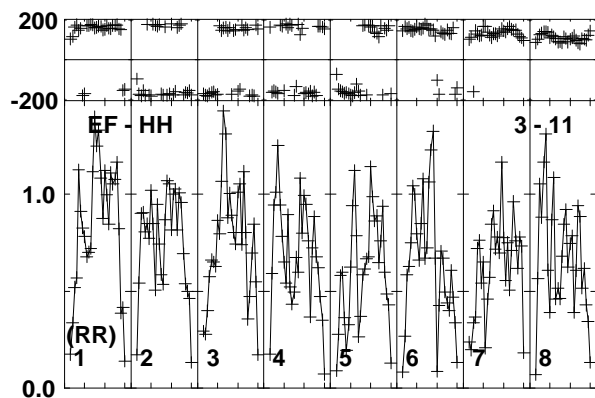
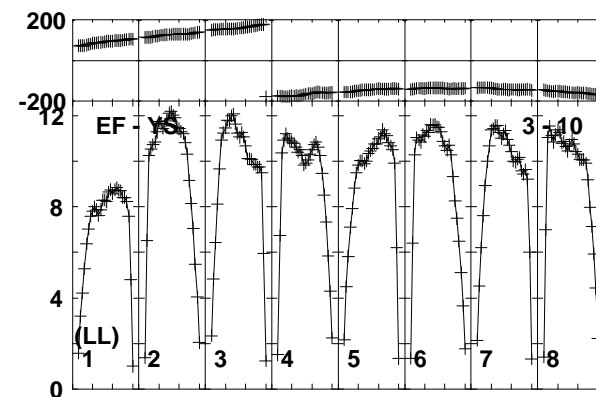
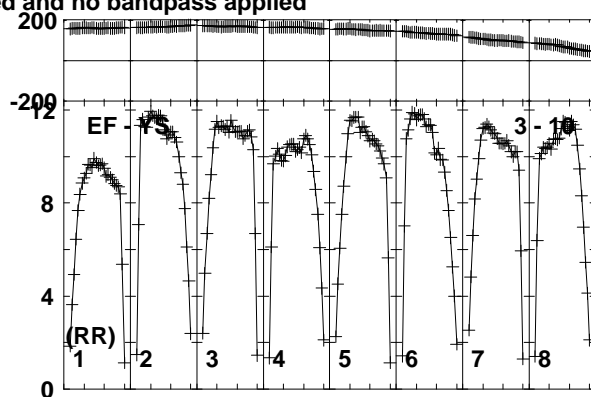
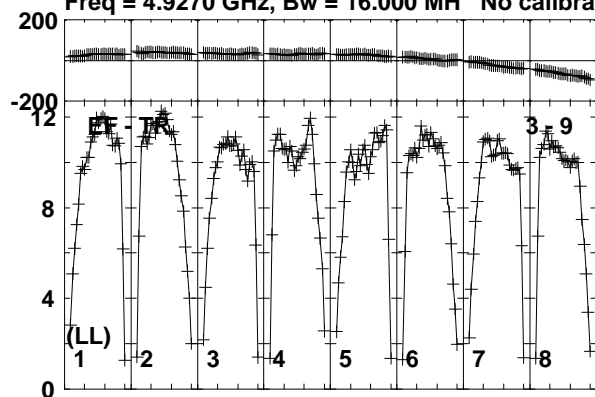

Lower frame: Milli Ampl Jy Top frame: Phas deg  
Vector averaged cross-power spectrum Baseline: EF (03) - TR (09)  
Timerange: 00/16:09:01 to 00/16:09:59

Plot file version 793 created 19-DEC-2018 17:59:05  
J1619+2247 RY007C.UVDATA.1

Freq = 4.9270 GHz, Bw = 16.000 MH No calibration applied and no bandpass applied

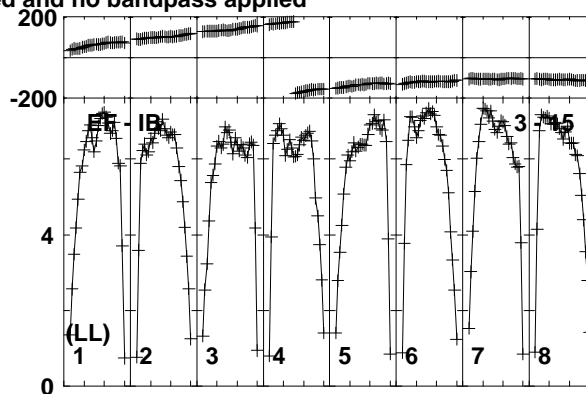
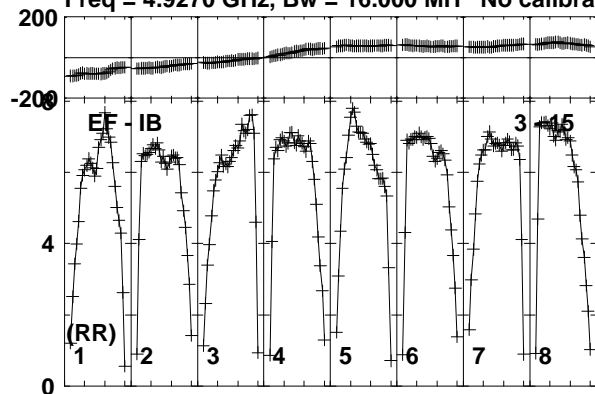

Lower frame: Milli Ampl Jy Top frame: Phas deg  
Vector averaged cross-power spectrum Baseline: EF (03) - IB (15)  
Timerange: 00/16:09:01 to 00/16:09:59

Plot file version 794 created 19-DEC-2018 17:59:05

AT2018\_RY007C.UVDATA.1

Freq = 4.9270 GHz, Bw = 16.000 MH No calibration applied and no bandpass applied

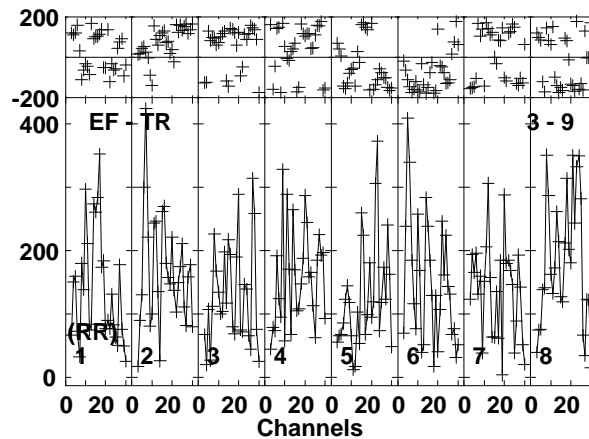
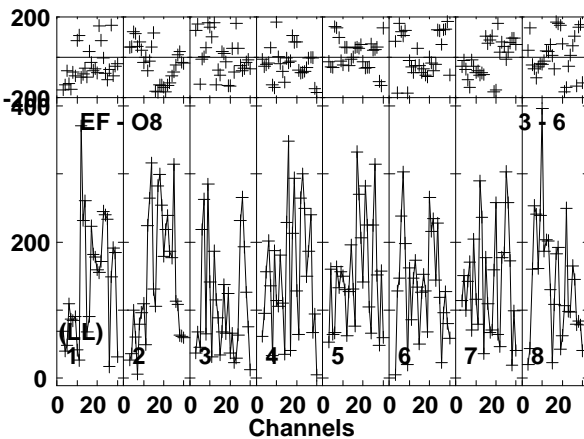
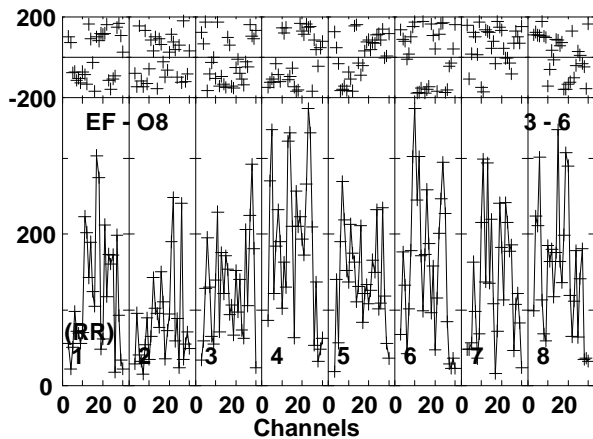
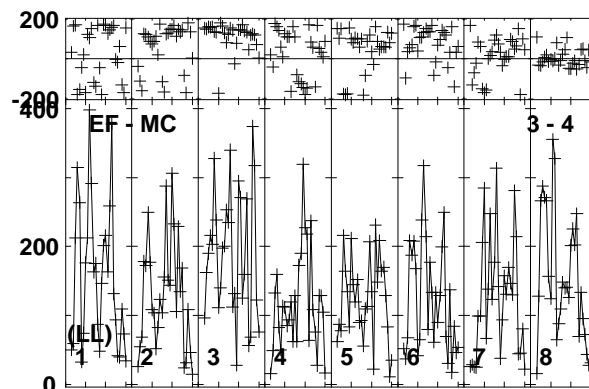
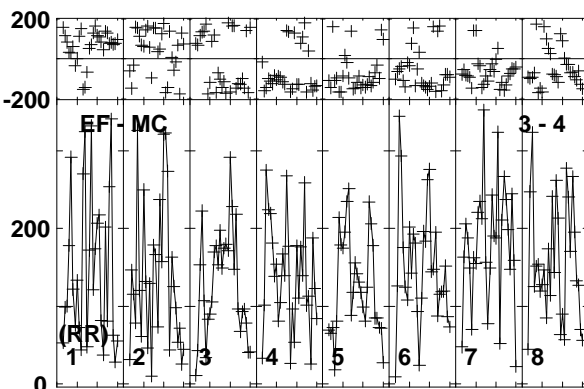
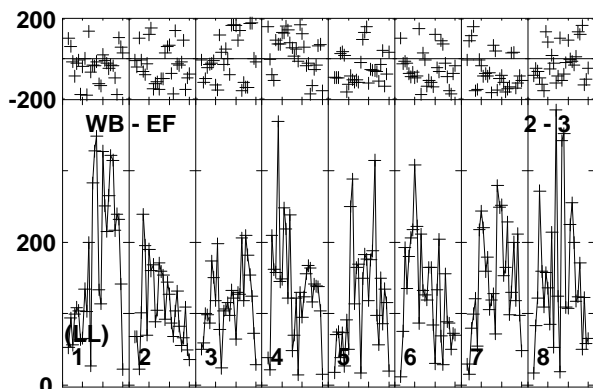
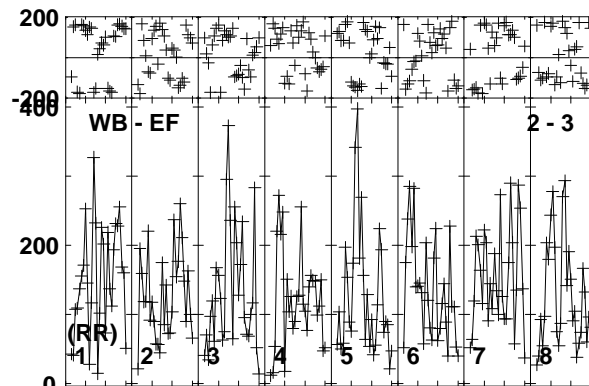
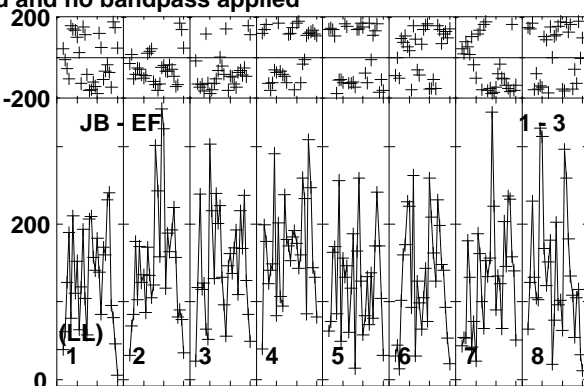
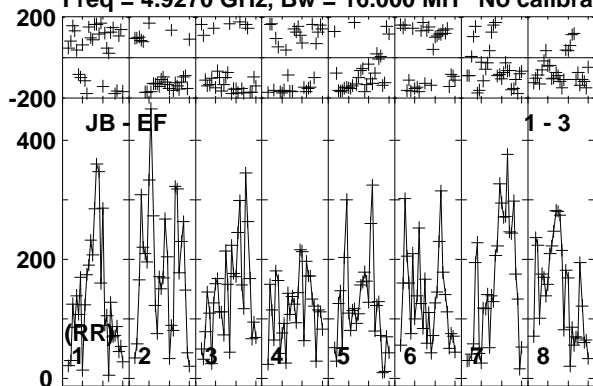

Lower frame: Micro Ampl Jy Top frame: Phas deg  
Vector averaged cross-power spectrum Baseline: JB (01) - EF (03)  
Timerange: 00/16:10:01 to 00/16:11:59



Plot file version 795 created 19-DEC-2018 17:59:05  
 AT2018\_RY007C.UVDATA.1

Freq = 4.9270 GHz, Bw = 16.000 MH No calibration applied and no bandpass applied

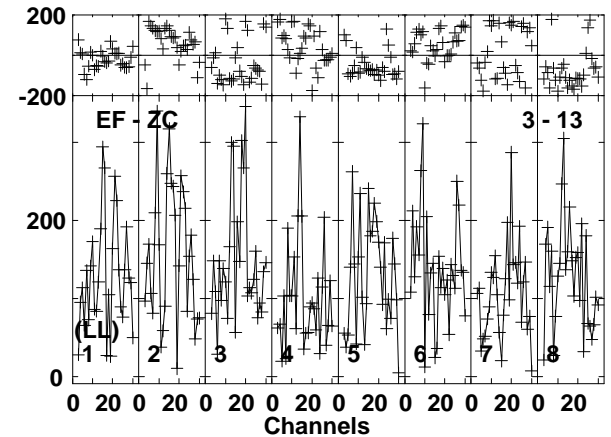
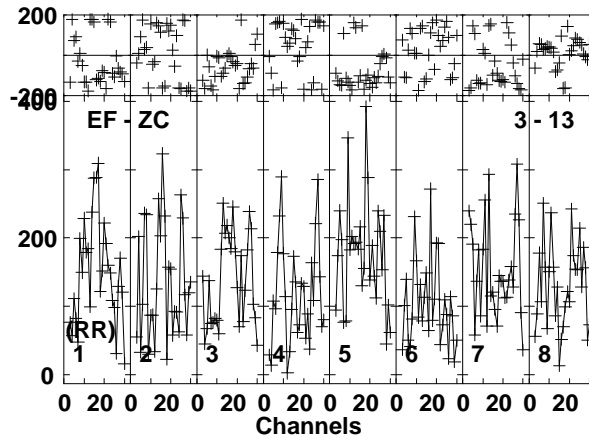
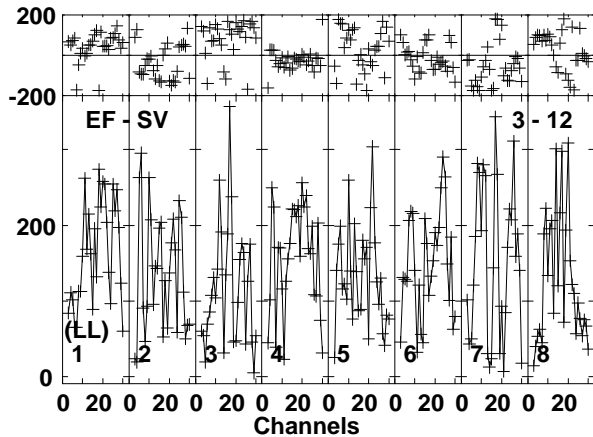
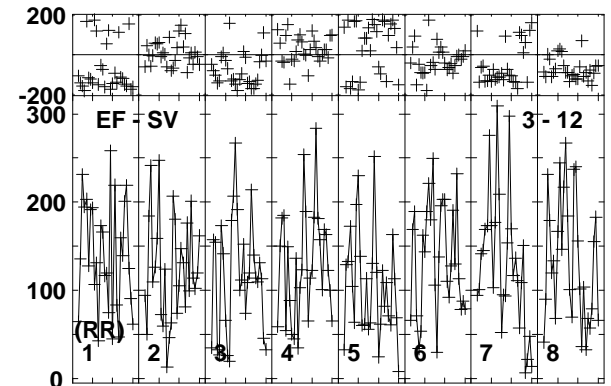
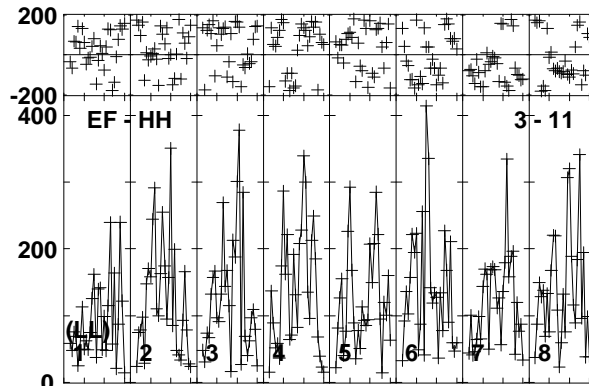
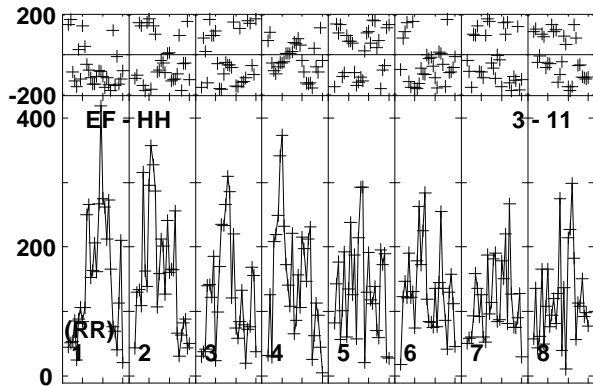
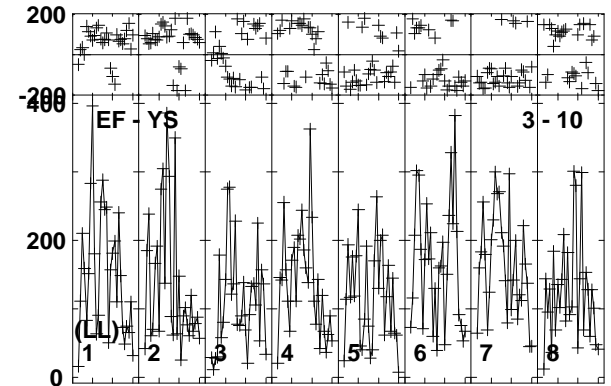
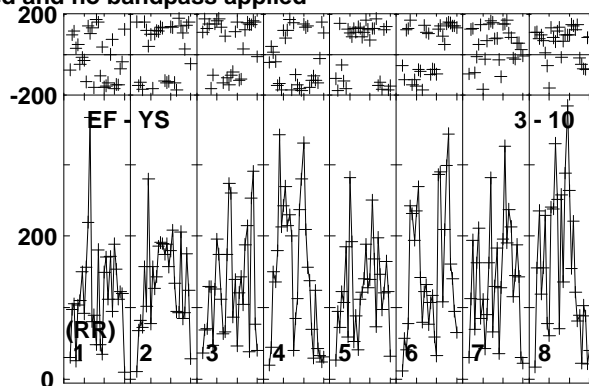
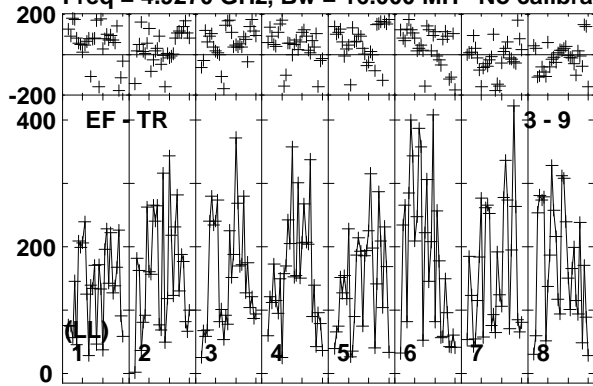

Lower frame: Micro Ampl Jy Top frame: Phas deg  
 Vector averaged cross-power spectrum Baseline: EF (03) - TR (09)  
 Timerange: 00/16:10:01 to 00/16:11:59

Plot file version 796 created 19-DEC-2018 17:59:05

AT2018\_RY007C.UVDATA.1

Freq = 4.9270 GHz, Bw = 16.000 MH No calibration applied and no bandpass applied

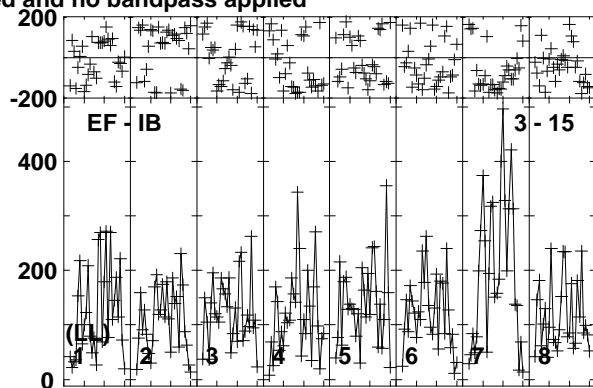
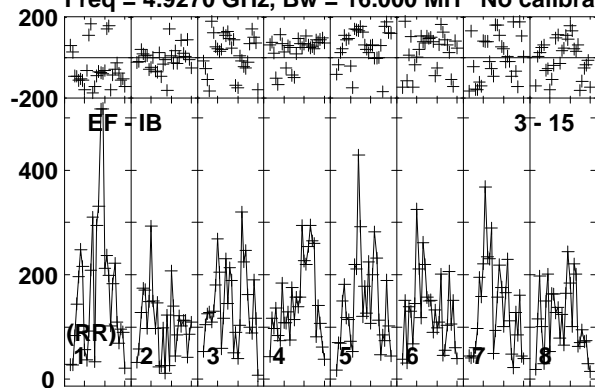

Lower frame: Micro Ampl Jy Top frame: Phas deg  
Vector averaged cross-power spectrum Baseline: EF (03) - IB (15)  
Timerange: 00/16:10:01 to 00/16:11:59

Plot file version 797 created 19-DEC-2018 17:59:05

VLA2 RY007C.UVDATA.1

Freq = 4.9270 GHz, Bw = 16.000 MH No calibration applied and no bandpass applied

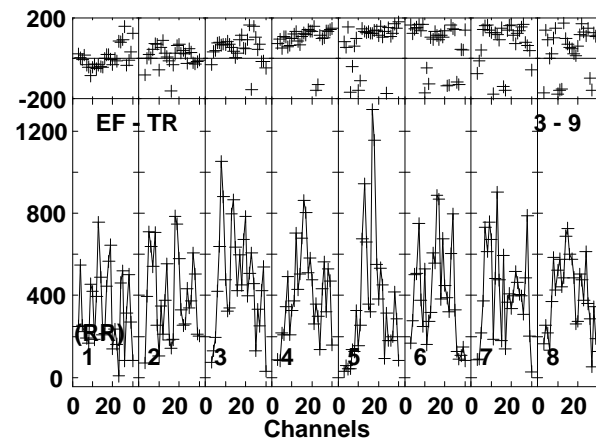
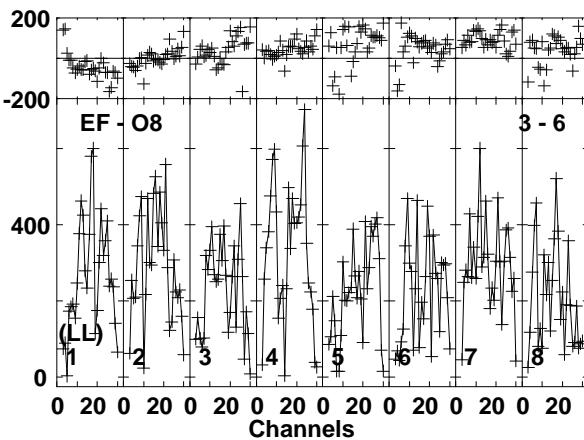
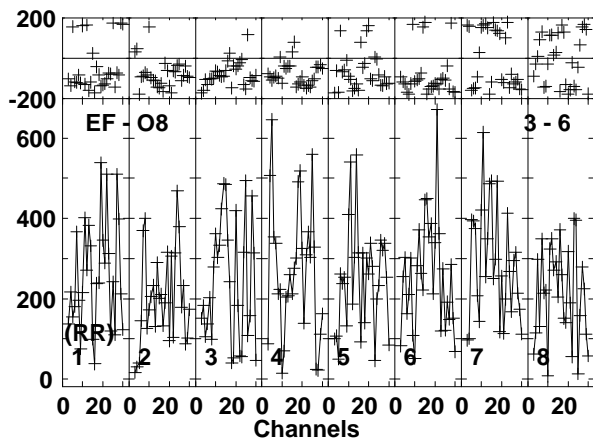
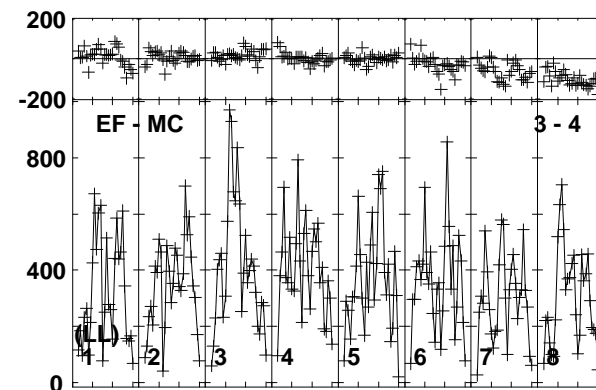
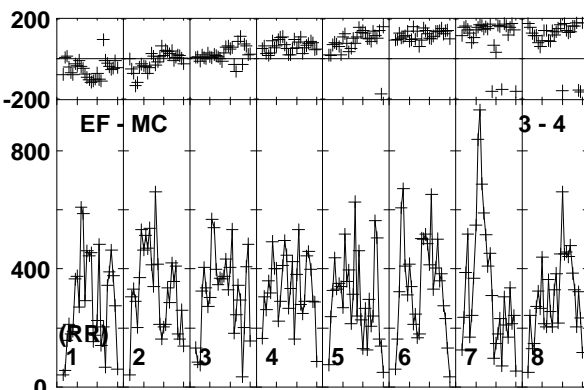
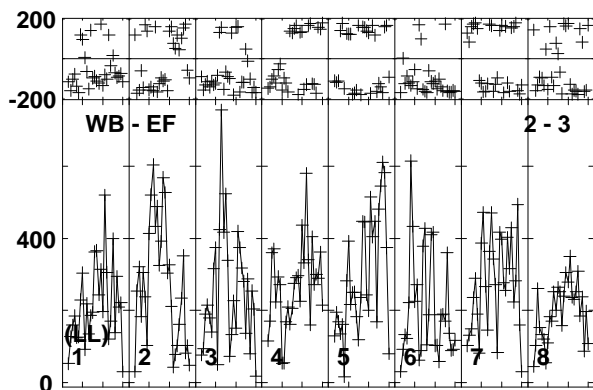
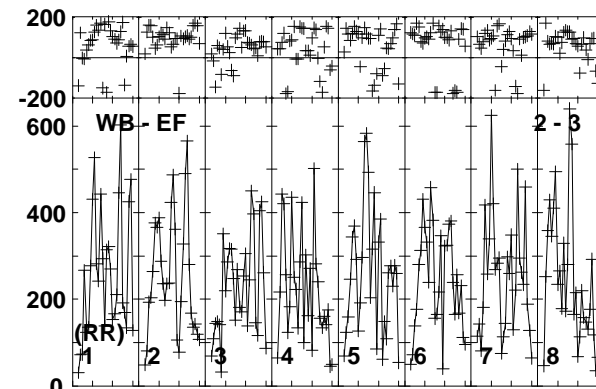
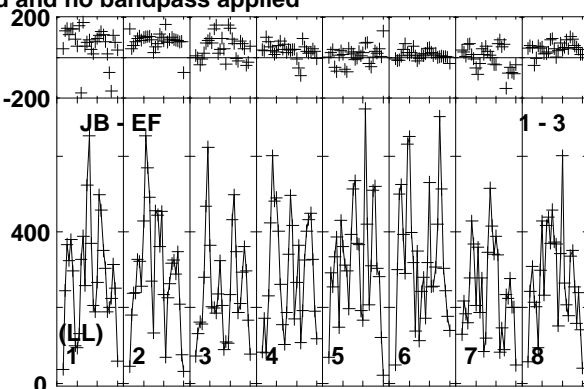
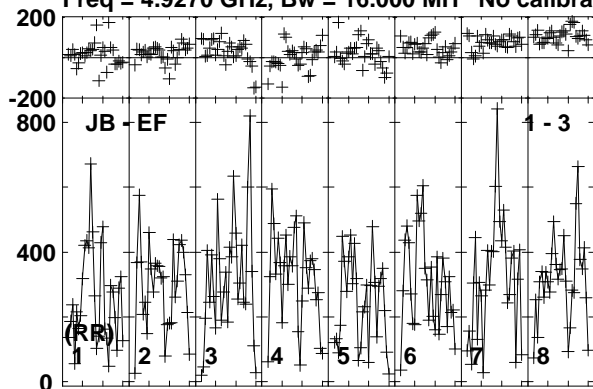

Lower frame: Micro Ampl Jy Top frame: Phas deg  
Vector averaged cross-power spectrum Baseline: JB (01) - EF (03)  
Timerange: 00/16:12:01 to 00/16:12:59

Plot file version 798 created 19-DEC-2018 17:59:05

VLA2 RY007C.UVDATA.1

Freq = 4.9270 GHz, Bw = 16.000 MH No calibration applied and no bandpass applied

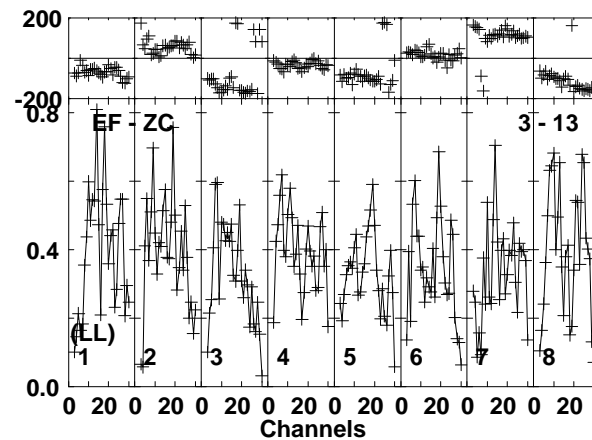
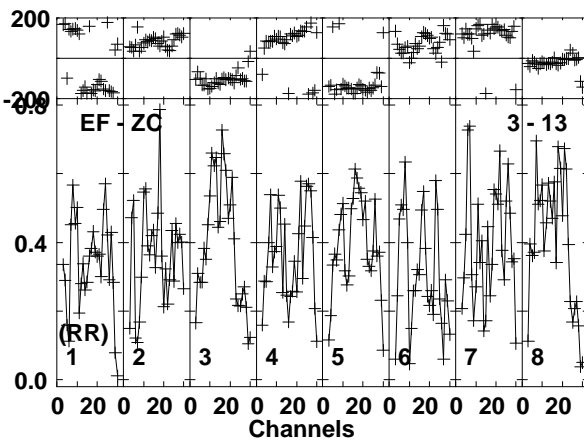
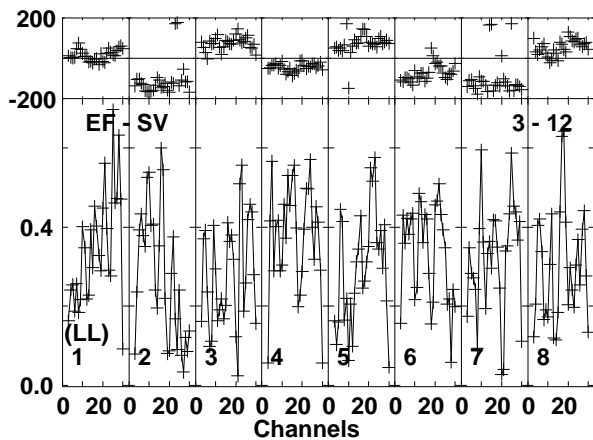
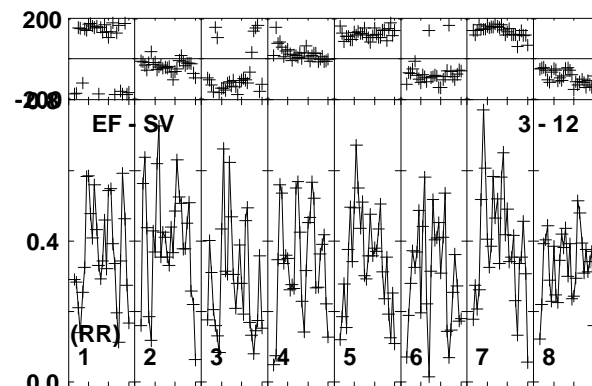
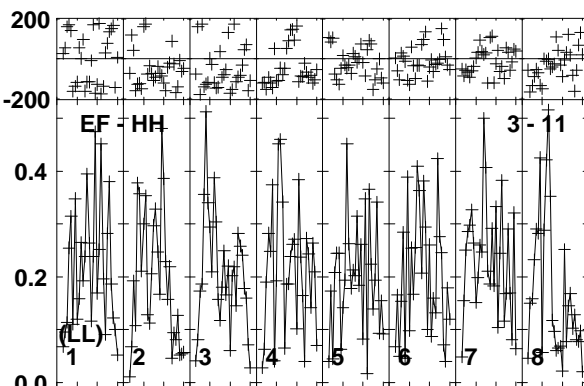
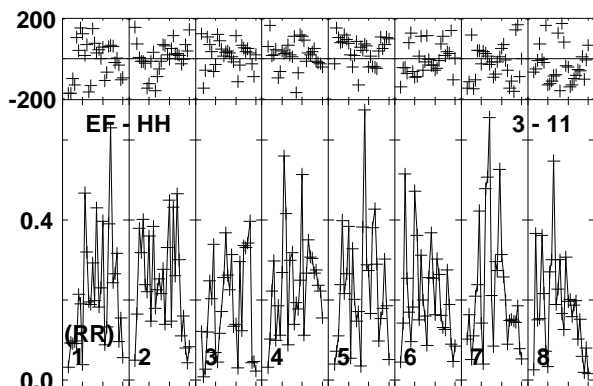
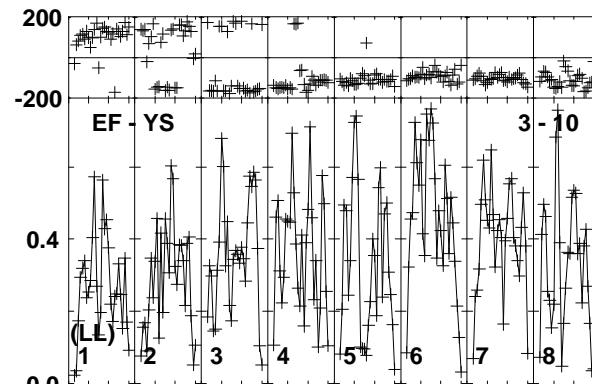
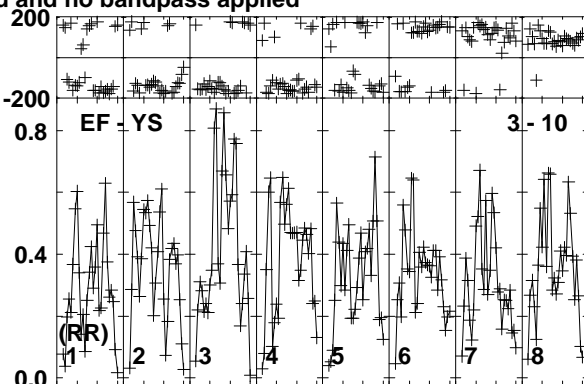
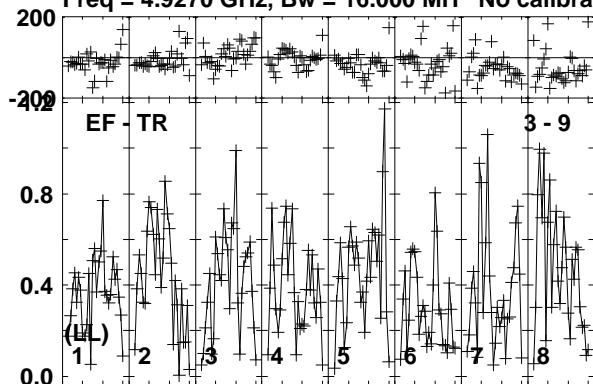

Lower frame: Milli Ampl Jy Top frame: Phas deg  
Vector averaged cross-power spectrum Baseline: EF (03) - TR (09)  
Timerange: 00:16:12:01 to 00:16:12:59

Plot file version 799 created 19-DEC-2018 17:59:05

VLA2 RY007C.UVDATA.1

Freq = 4.9270 GHz, Bw = 16.000 MH No calibration applied and no bandpass applied

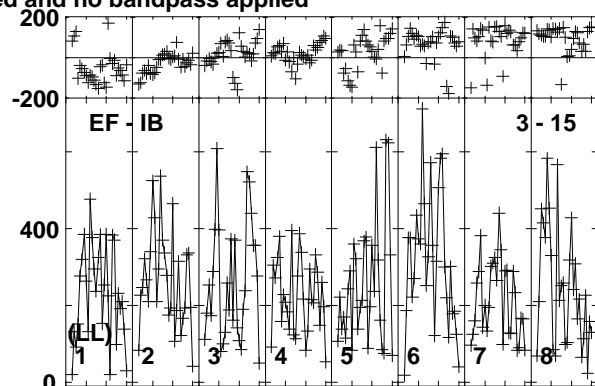
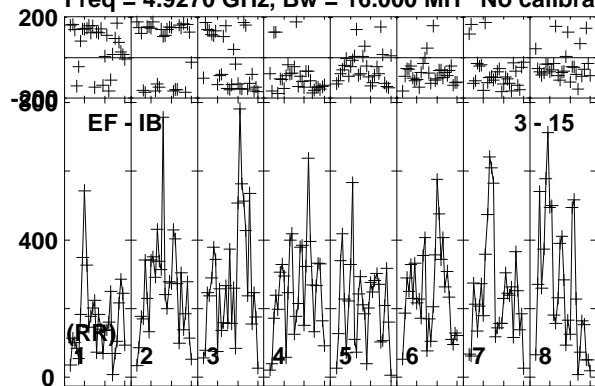

Lower frame: Micro Ampl Jy Top frame: Phas deg  
Vector averaged cross-power spectrum Baseline: EF (03) - IB (15)  
Timerange: 00/16:12:01 to 00/16:12:59

Plot file version 800 created 19-DEC-2018 17:59:05

J1619+2247 RY007C.UVDATA.1

Freq = 4.9270 GHz, Bw = 16.000 MH No calibration applied and no bandpass applied

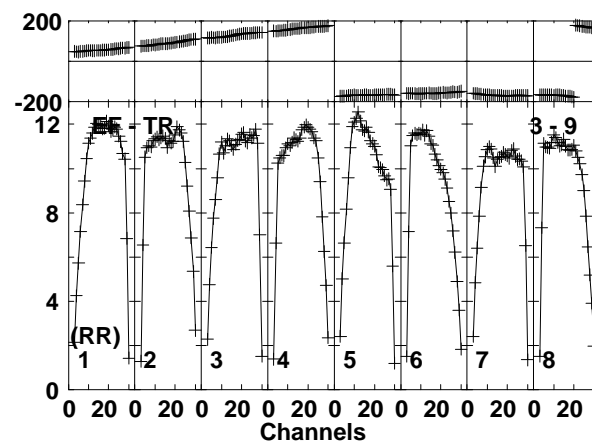
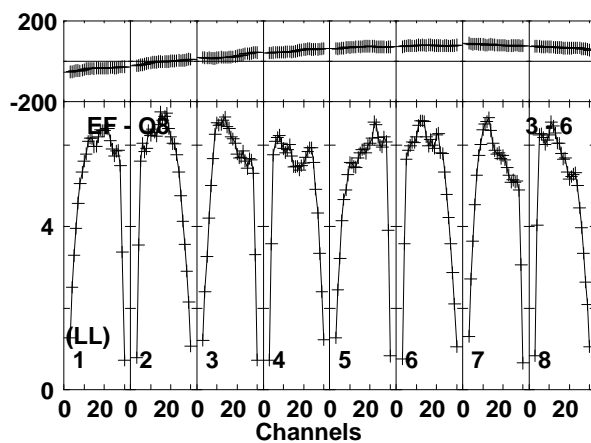
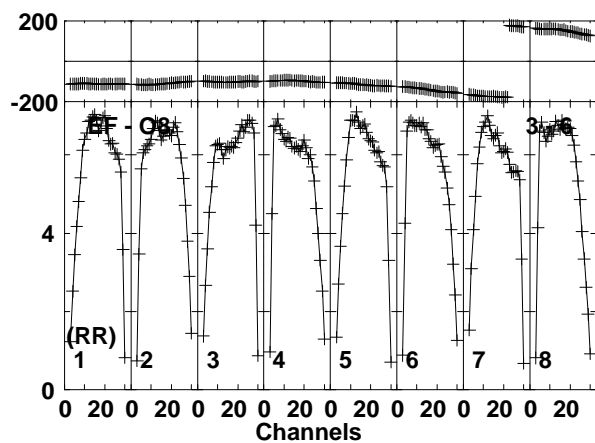
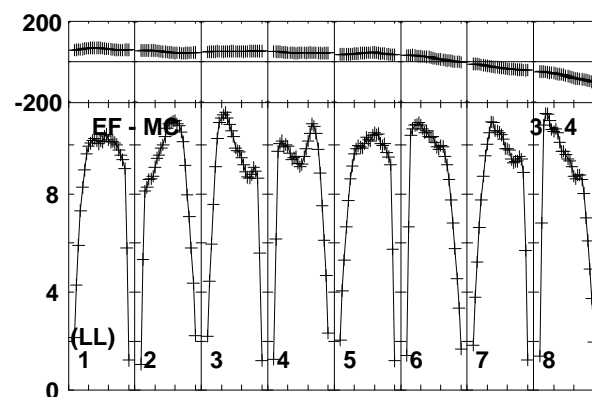
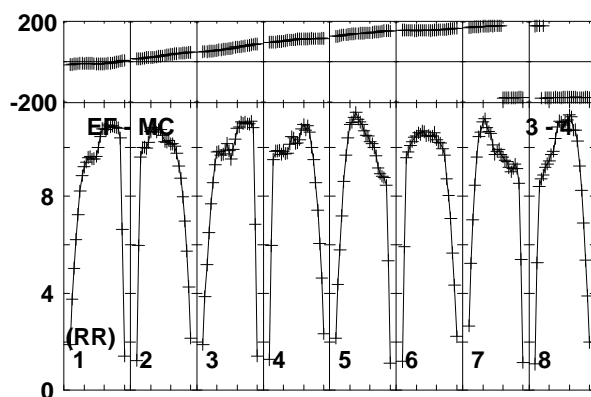
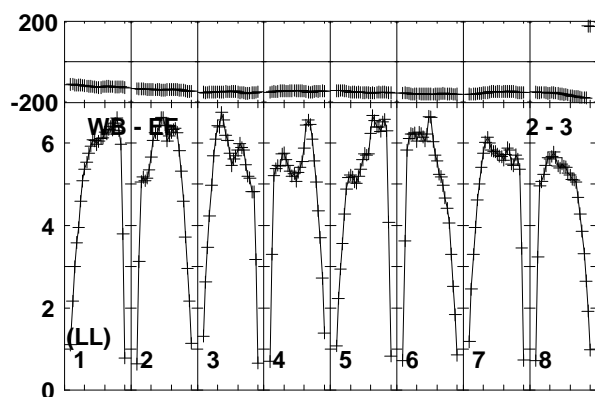
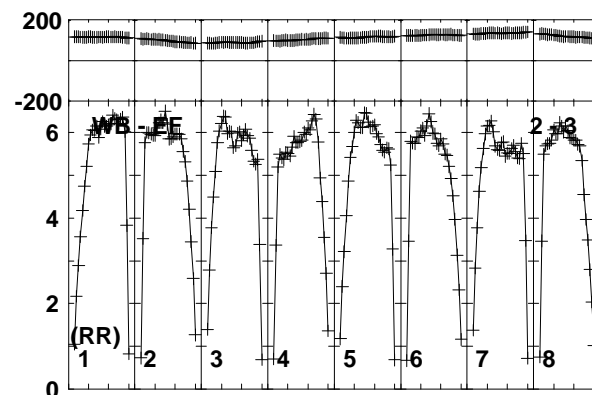
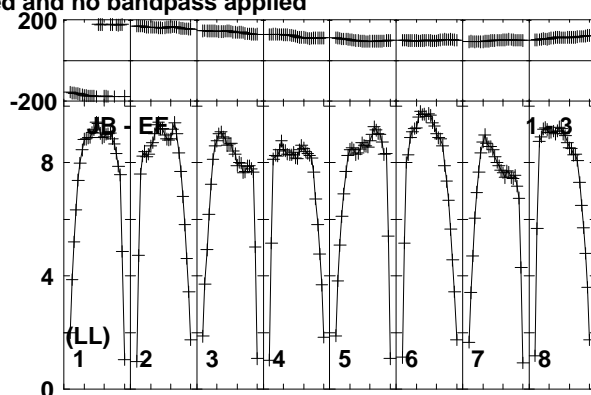
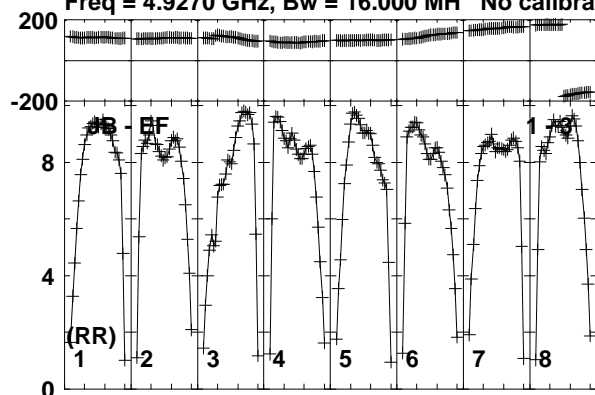

Lower frame: Milli Ampl Jy Top frame: Phas deg  
Vector averaged cross-power spectrum Baseline: JB (01) - EF (03)  
Timerange: 00/16:13:31 to 00/16:14:29

Plot file version 801 created 19-DEC-2018 17:59:06

J1619+2247 RY007C.UVDATA.1

Freq = 4.9270 GHz, Bw = 16.000 MH No calibration applied and no bandpass applied

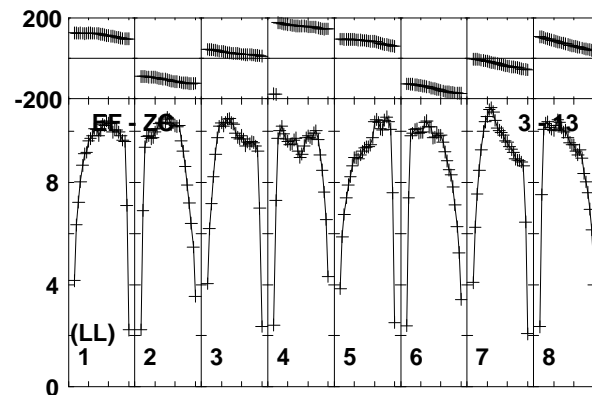
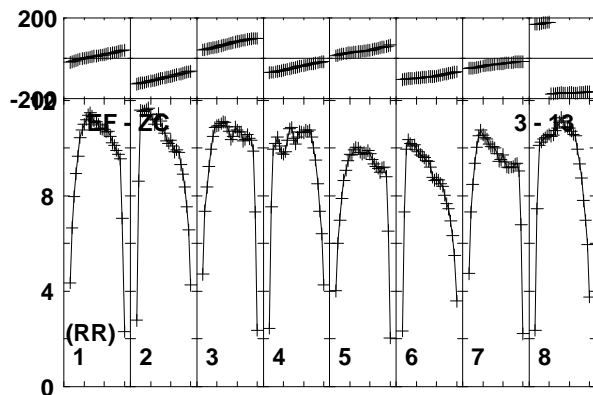
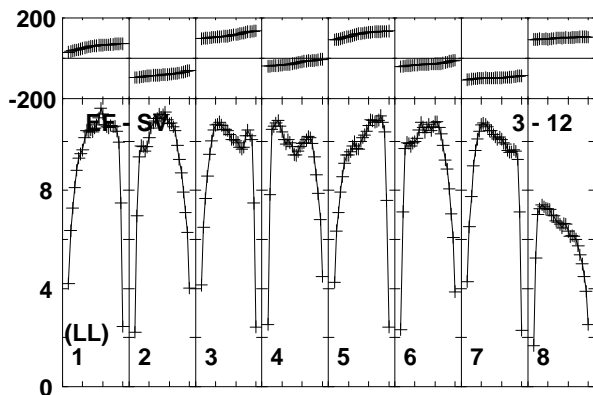
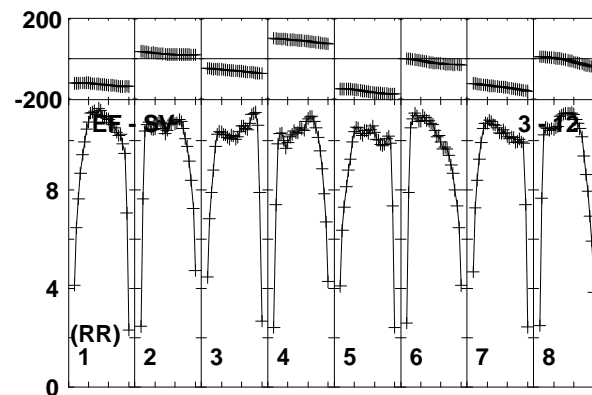
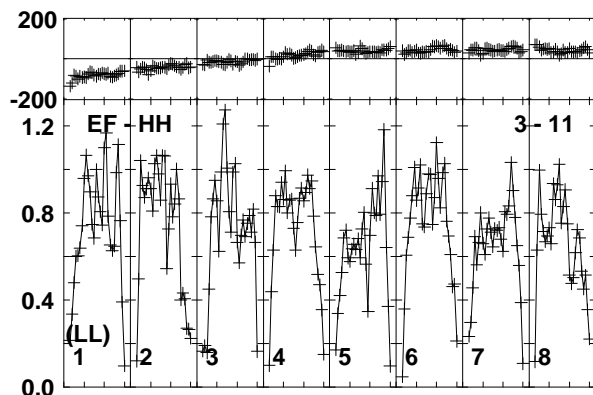
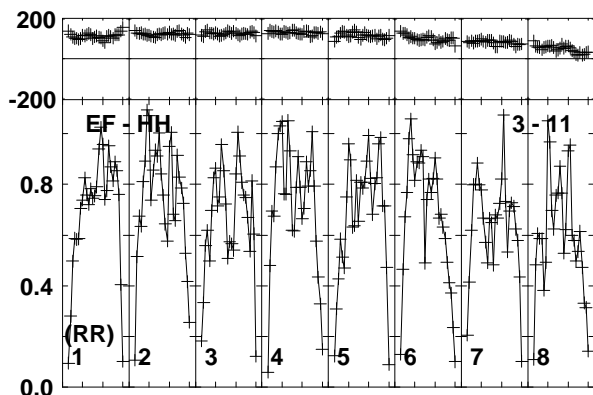
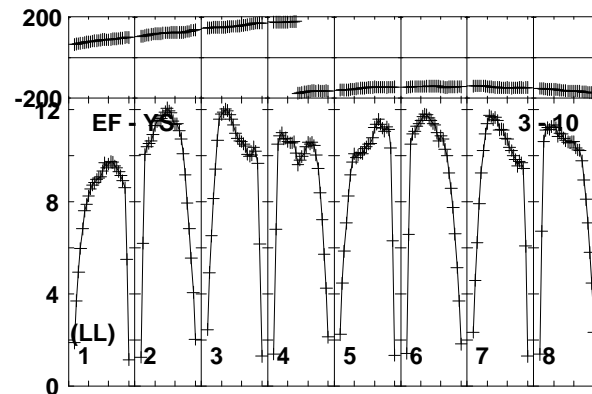
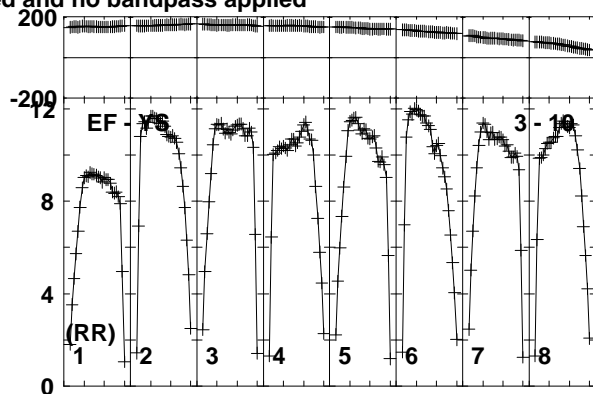
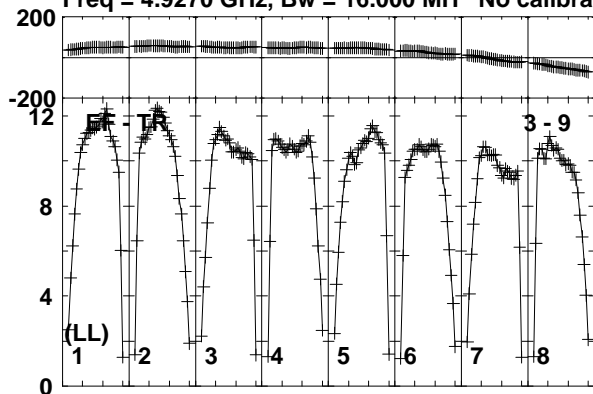

Lower frame: Milli Ampl Jy Top frame: Phas deg  
Vector averaged cross-power spectrum Baseline: EF (03) - TR (09)  
Timerange: 00/16:13:31 to 00/16:14:29

Plot file version 802 created 19-DEC-2018 17:59:06  
J1619+2247 RY007C.UVDATA.1

Freq = 4.9270 GHz, Bw = 16.000 MH No calibration applied and no bandpass applied

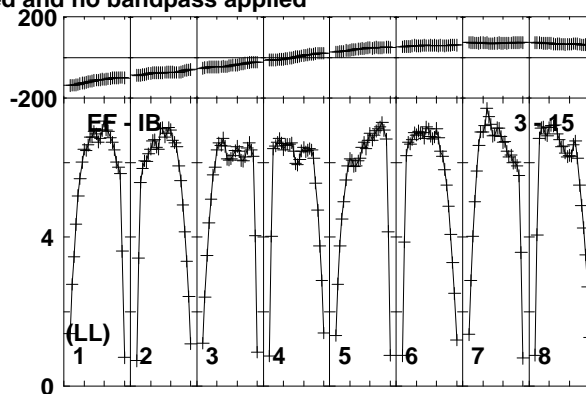
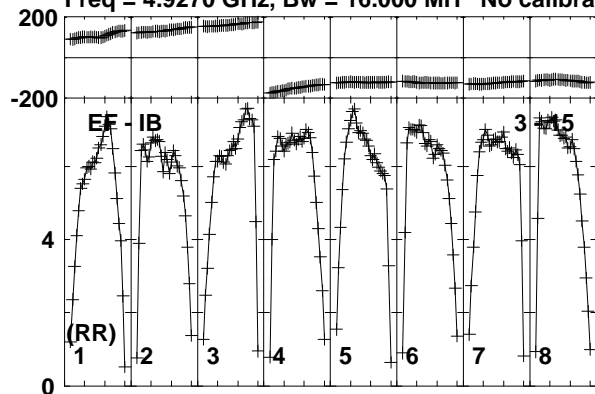

Lower frame: Milli Ampl Jy Top frame: Phas deg  
Vector averaged cross-power spectrum Baseline: EF (03) - IB (15)  
Timerange: 00/16:13:31 to 00/16:14:29



Plot file version 803 created 19-DEC-2018 17:59:06

AT2018\_RY007C.UVDATA.1

Freq = 4.9270 GHz, Bw = 16.000 MH No calibration applied and no bandpass applied

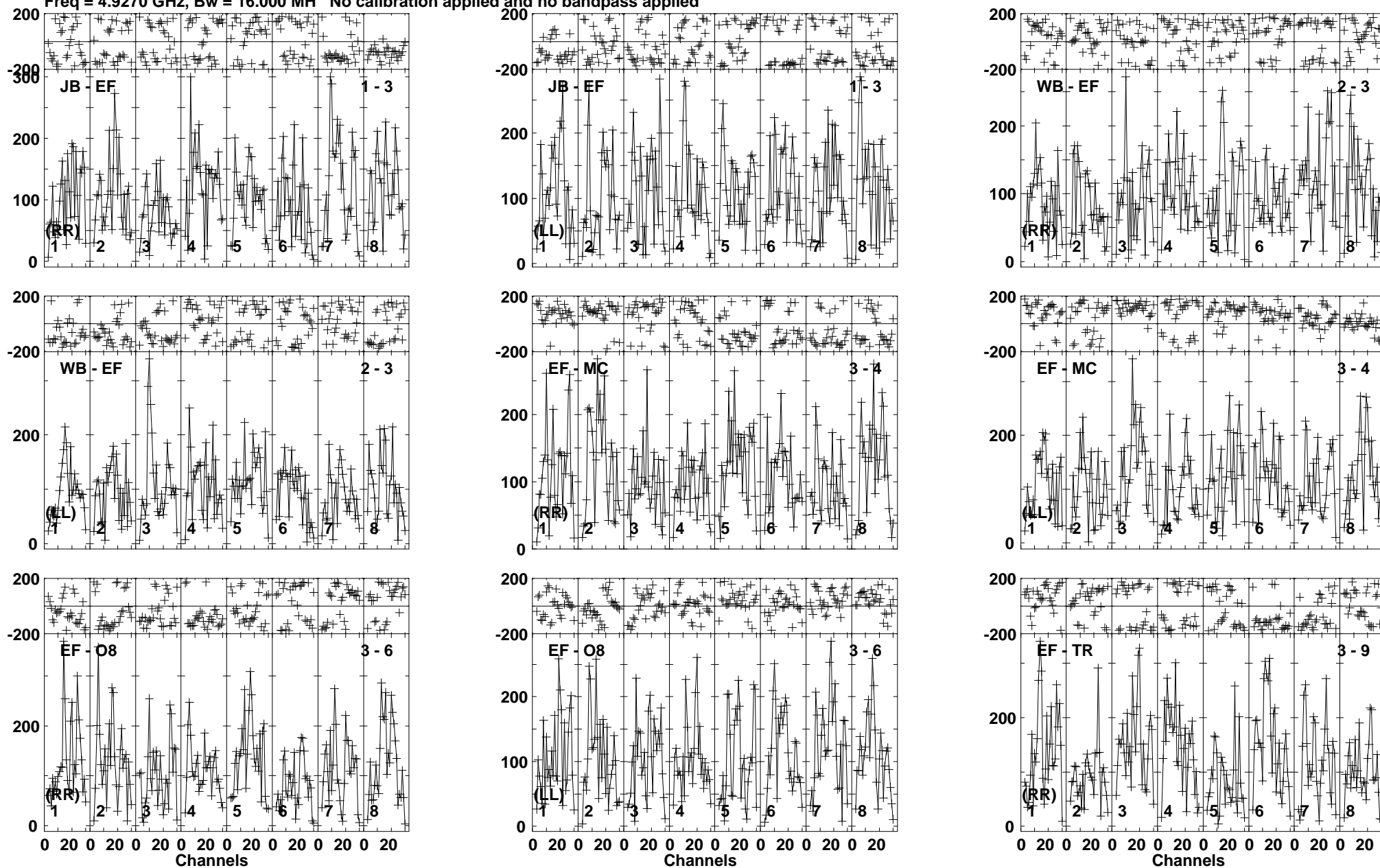

Lower frame: Micro Ampl Jy Top frame: Phas deg  
Vector averaged cross-power spectrum Baseline: JB (01) - EF (03)  
Timerange: 00/16:14:31 to 00/16:17:29

Plot file version 804 created 19-DEC-2018 17:59:06

AT2018\_RY007C.UVDATA.1

Freq = 4.9270 GHz, Bw = 16.000 MH No calibration applied and no bandpass applied

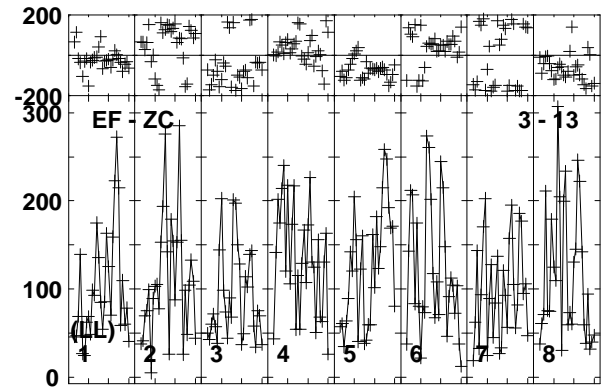
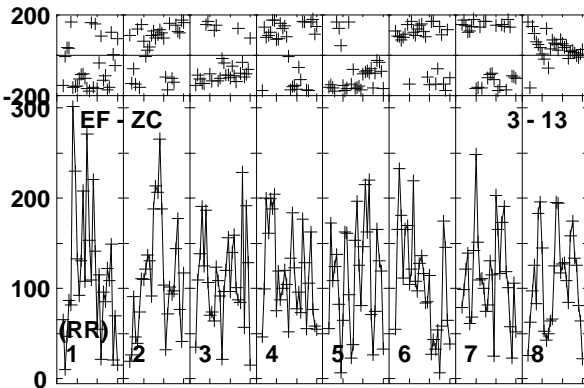
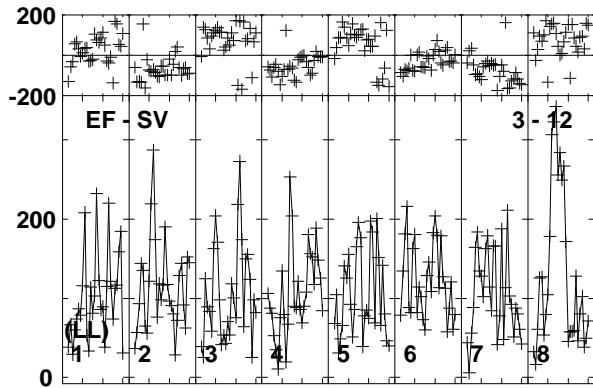
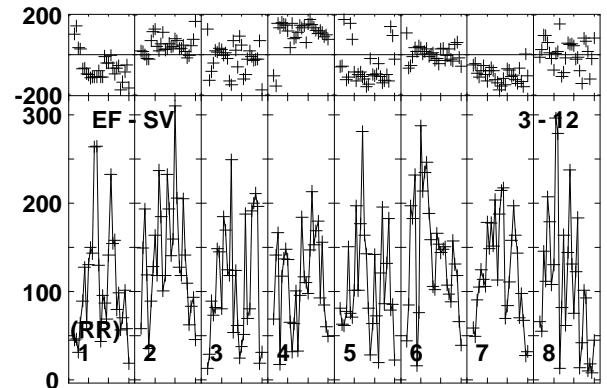
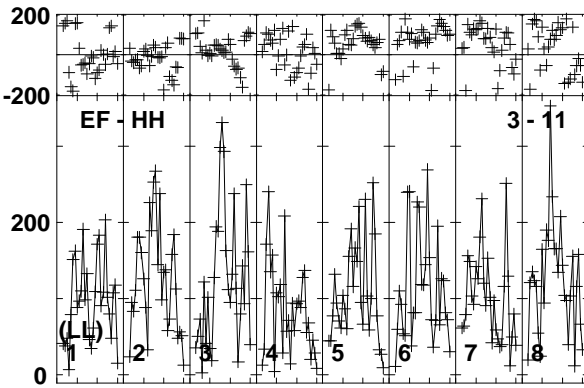
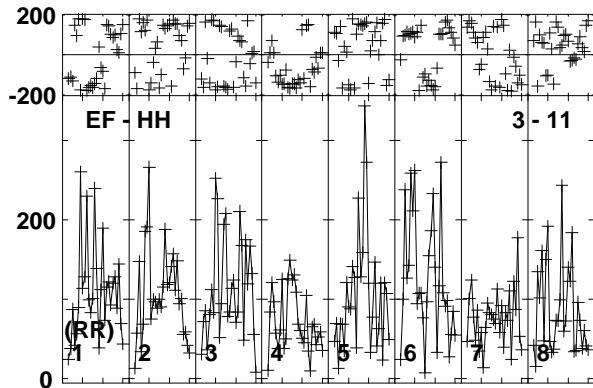
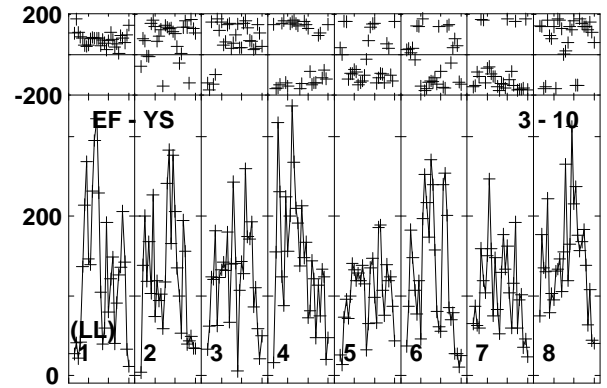
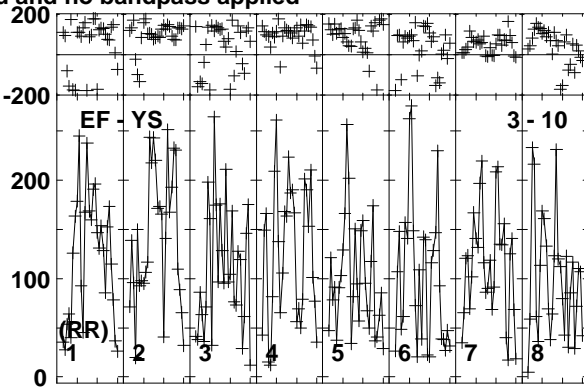
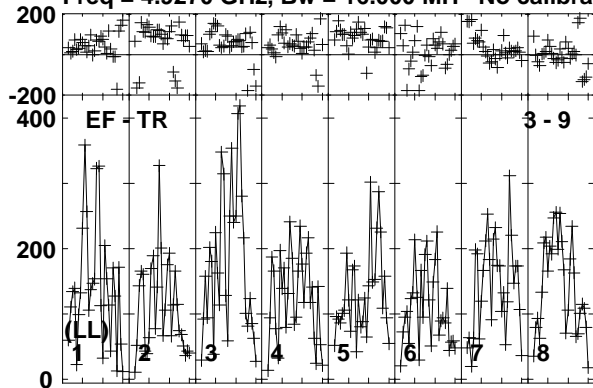

Lower frame: Micro Ampl Jy Top frame: Phas deg  
Vector averaged cross-power spectrum Baseline: EF (03) - TR (09)  
Timerange: 00/16:14:31 to 00/16:17:29

Plot file version 805 created 19-DEC-2018 17:59:06

AT2018\_RY007C.UVDATA.1

Freq = 4.9270 GHz, Bw = 16.000 MHz No calibration applied and no bandpass applied

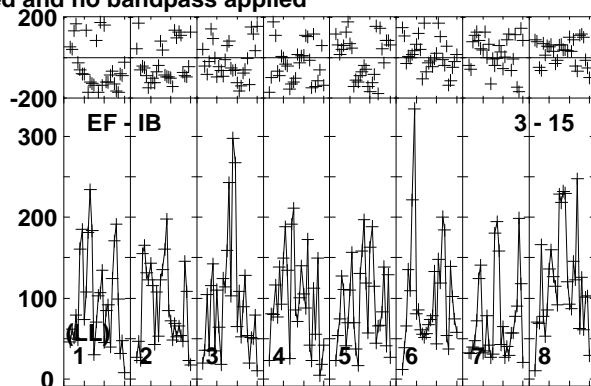
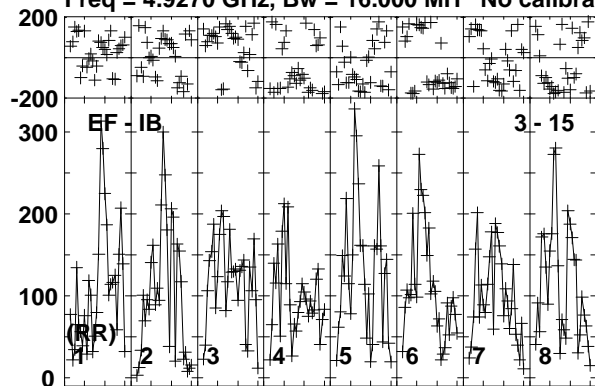

Lower frame: Micro Ampl Jy Top frame: Phas deg  
Vector averaged cross-power spectrum Baseline: EF (03) - IB (15)  
Timerange: 00/16:14:31 to 00/16:17:29

Plot file version 806 created 19-DEC-2018 17:59:06

J1619+2247 RY007C.UVDATA.1

Freq = 4.9270 GHz, Bw = 16.000 MH No calibration applied and no bandpass applied

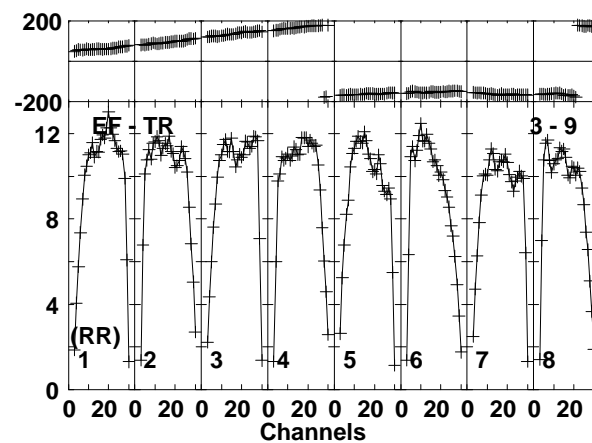
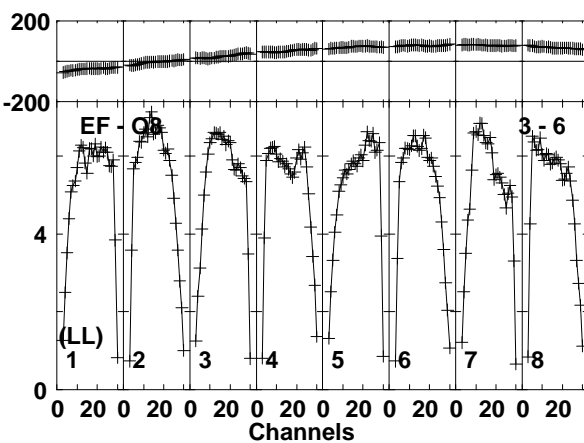
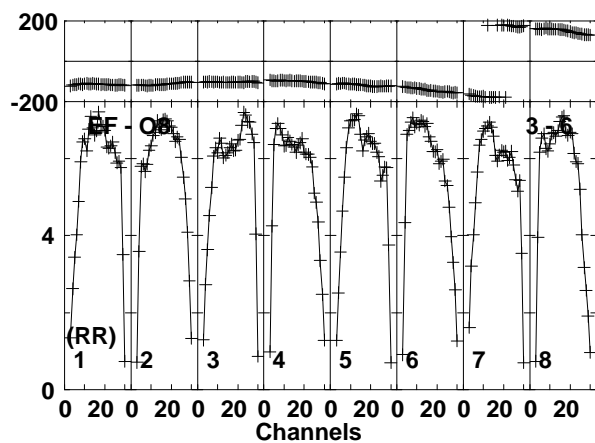
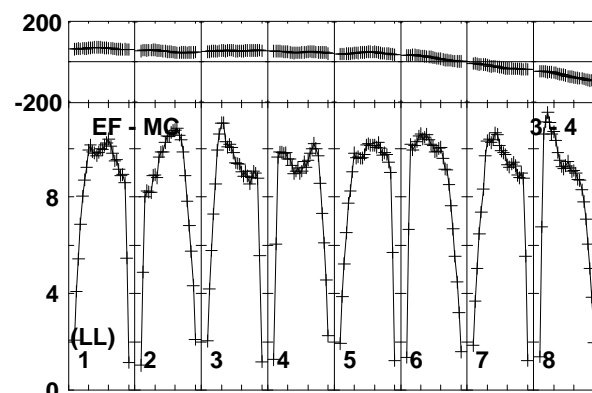
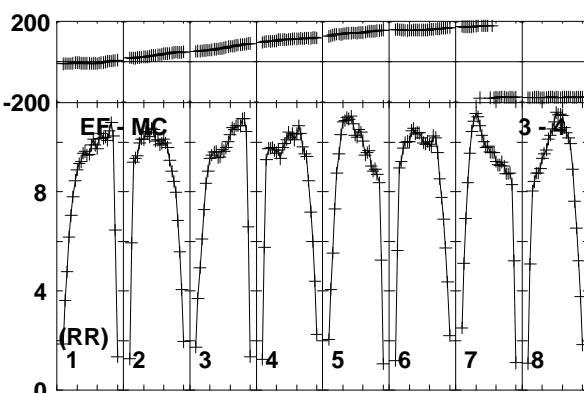
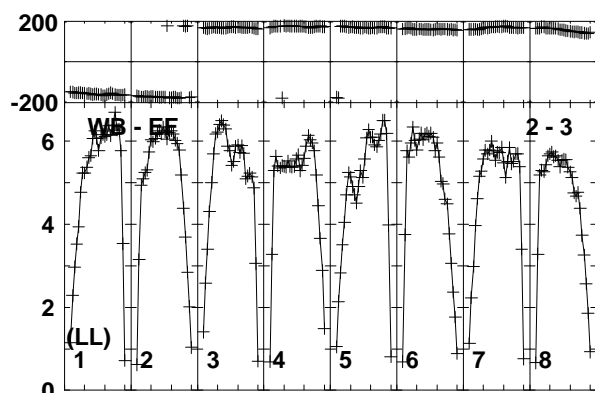
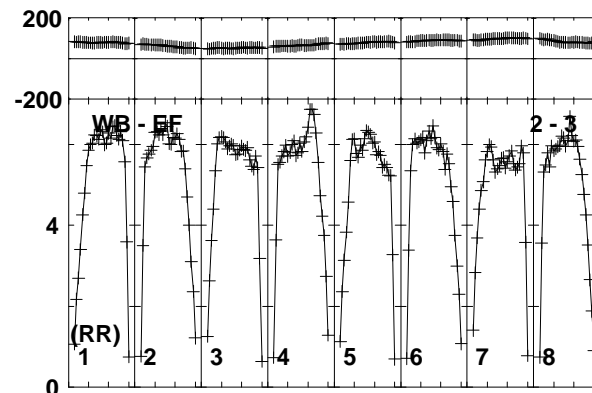
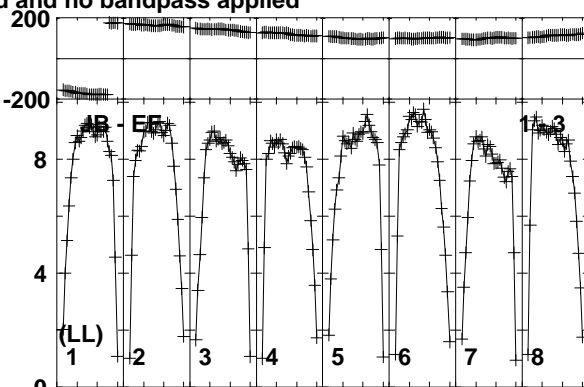
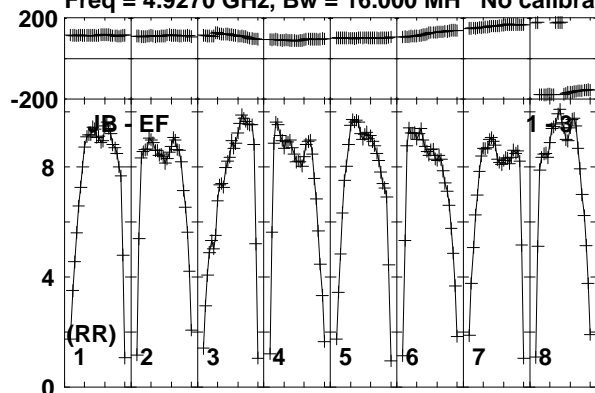

Lower frame: Milli Ampl Jy Top frame: Phas deg  
Vector averaged cross-power spectrum Baseline: JB (01) - EF (03)  
Timerange: 00/16:17:31 to 00/16:18:29

Plot file version 807 created 19-DEC-2018 17:59:06

J1619+2247 RY007C.UVDATA.1

Freq = 4.9270 GHz, Bw = 16.000 MH No calibration applied and no bandpass applied

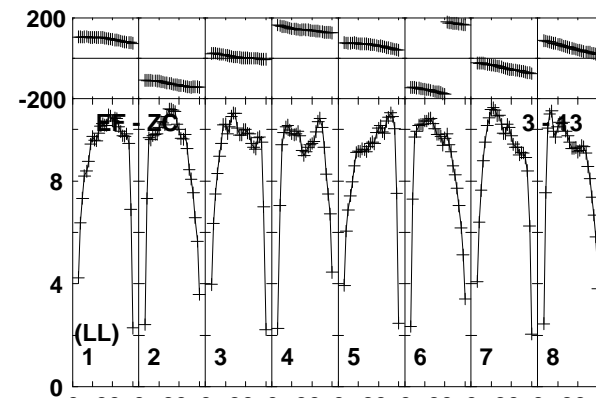
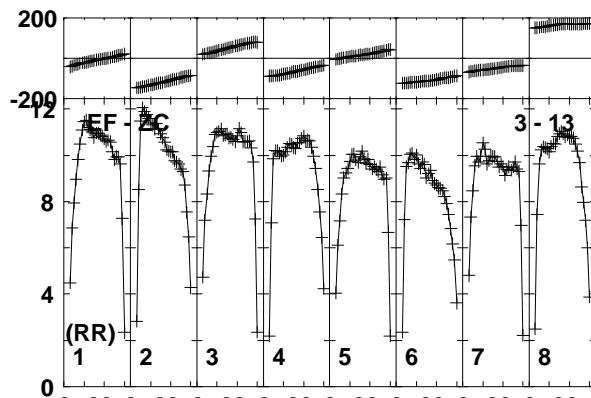
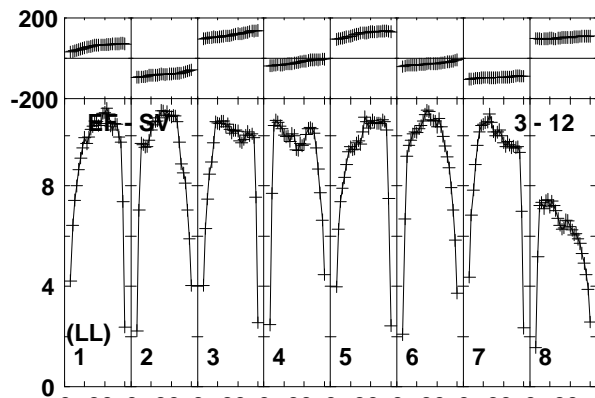
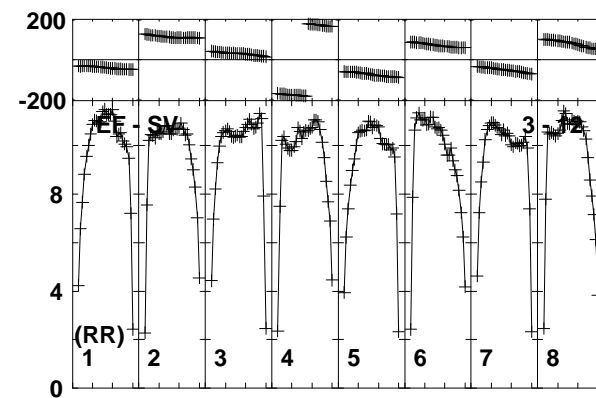
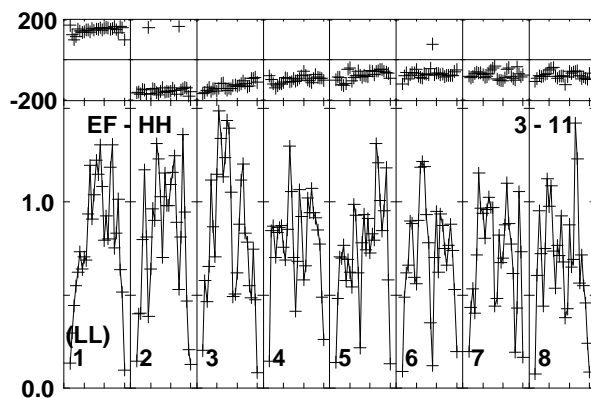
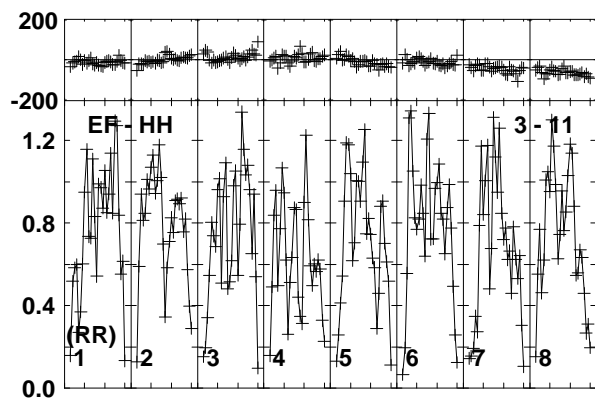
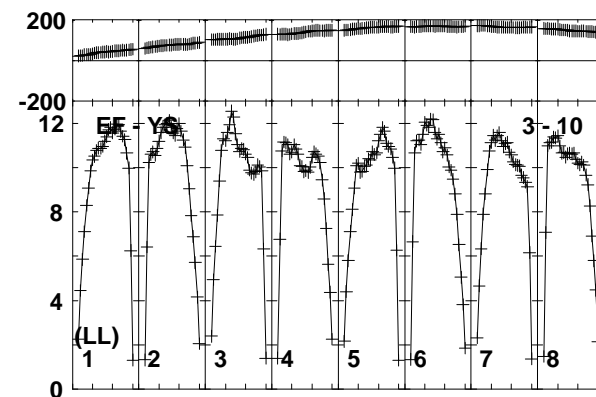
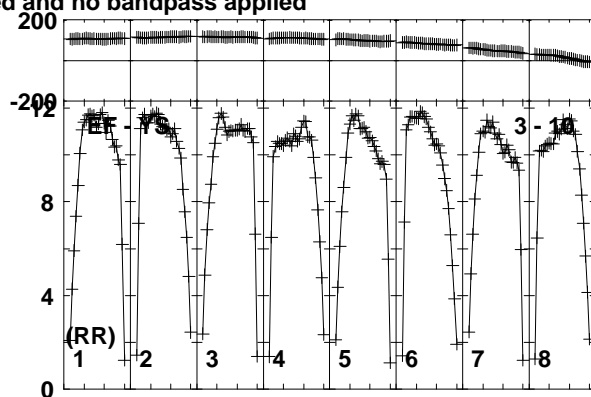
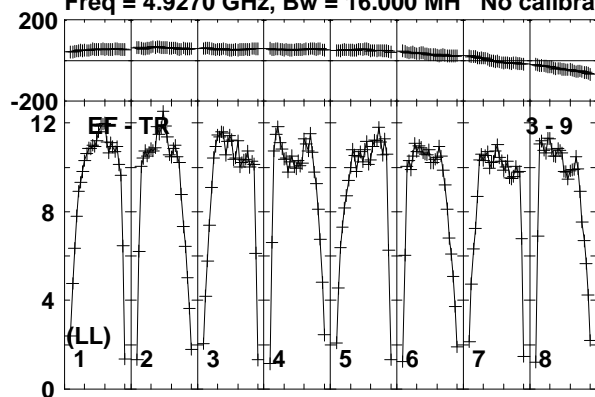

Lower frame: Milli Ampl Jy Top frame: Phas deg  
Vector averaged cross-power spectrum Baseline: EF (03) - TR (09)  
Timerange: 00/16:17:31 to 00/16:18:29

Plot file version 808 created 19-DEC-2018 17:59:06  
J1619+2247 RY007C.UVDATA.1

Freq = 4.9270 GHz, Bw = 16.000 MH No calibration applied and no bandpass applied

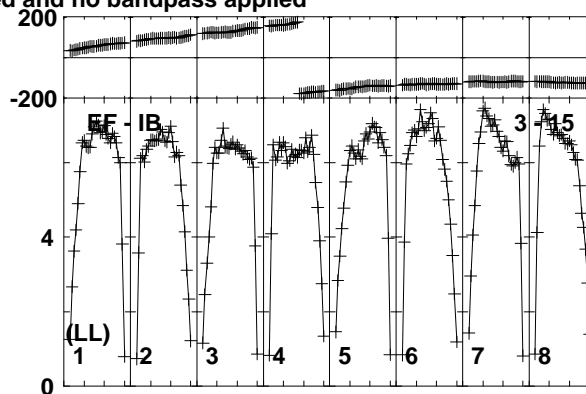
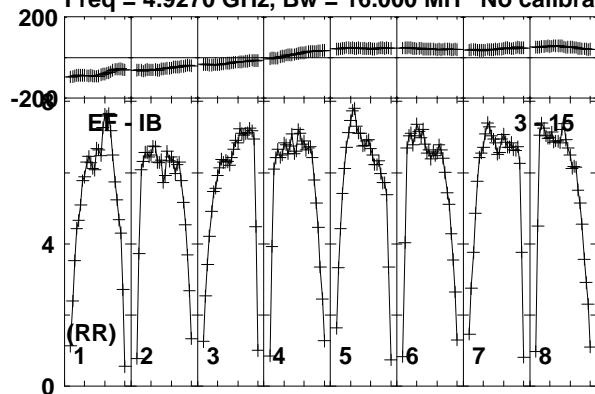

Lower frame: Milli Ampl Jy Top frame: Phas deg  
Vector averaged cross-power spectrum Baseline: EF (03) - IB (15)  
Timerange: 00/16:17:31 to 00/16:18:29

Plot file version 809 created 19-DEC-2018 17:59:06  
 AT2018\_RY007C.UVDATA.1

Freq = 4.9270 GHz, Bw = 16.000 MH No calibration applied and no bandpass applied

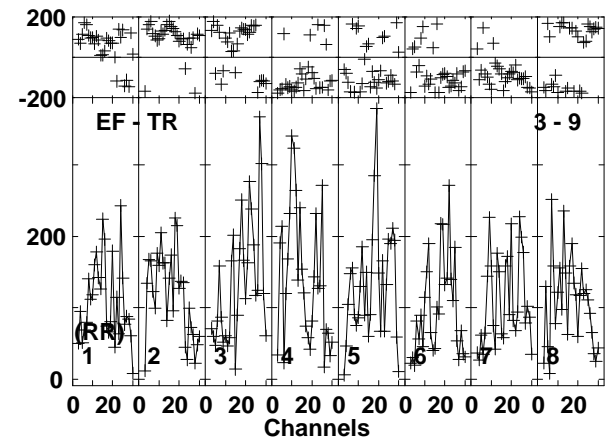
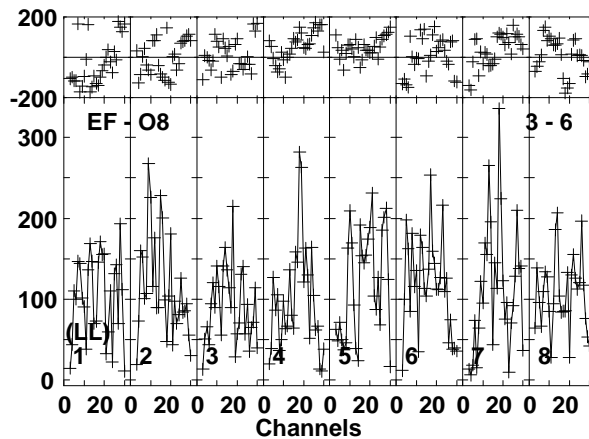
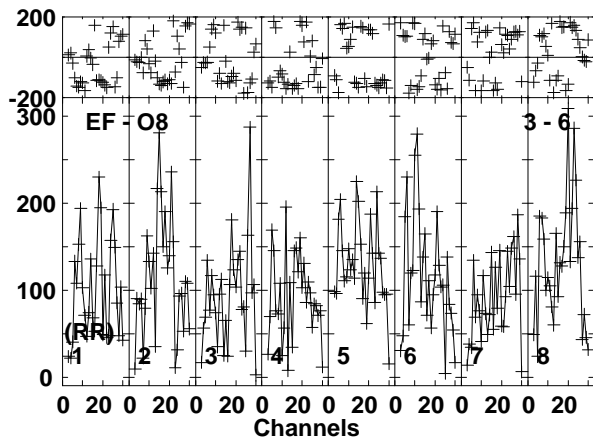
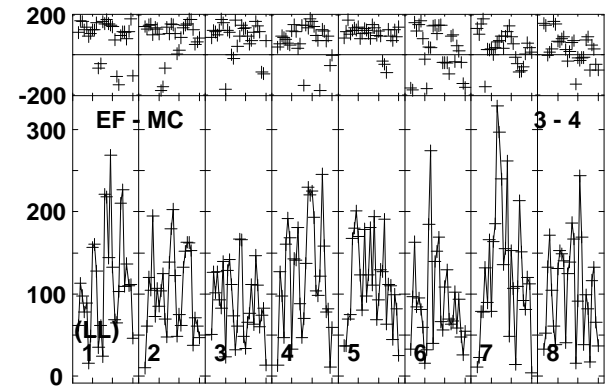
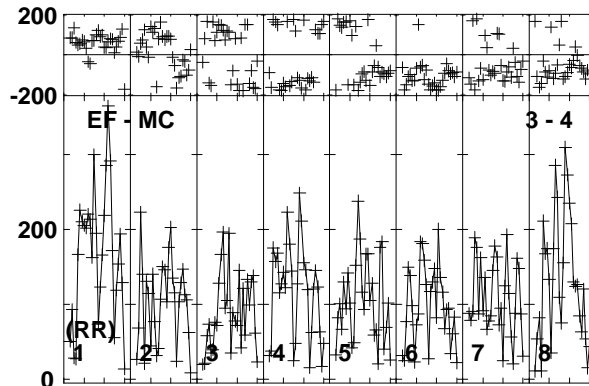
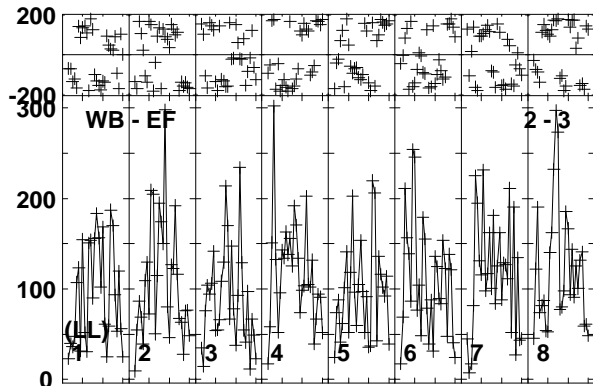
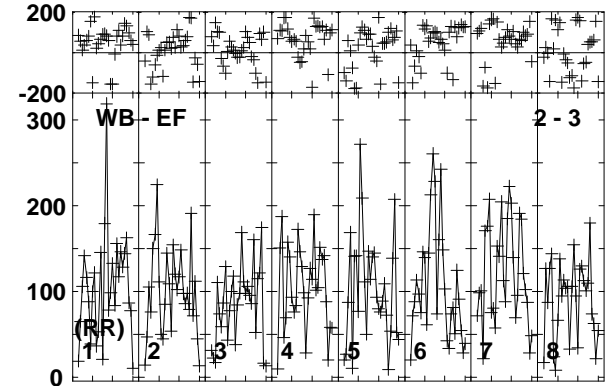
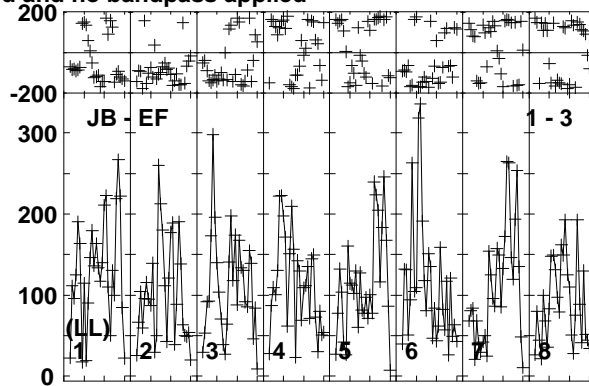
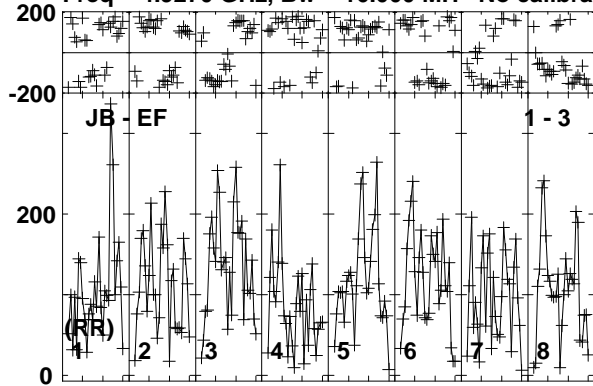

Lower frame: Micro Ampl Jy Top frame: Phas deg  
 Vector averaged cross-power spectrum Baseline: JB (01) - EF (03)  
 Timerange: 00/16:18:31 to 00/16:21:29

Plot file version 810 created 19-DEC-2018 17:59:06  
AT2018\_RY007C.UVDATA.1

Freq = 4.9270 GHz, Bw = 16.000 MH No calibration applied and no bandpass applied

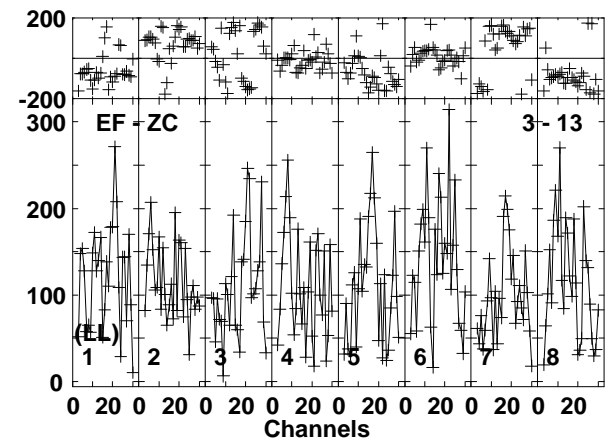
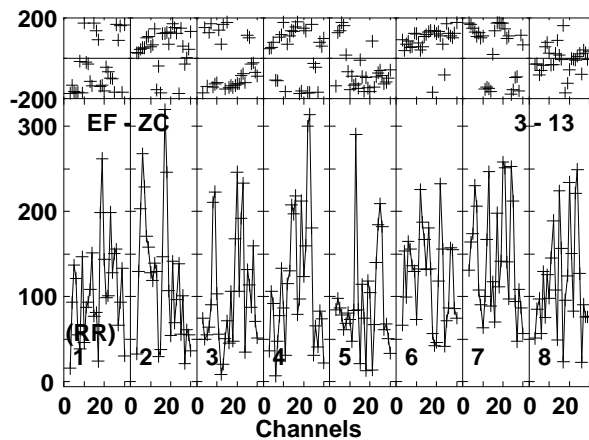
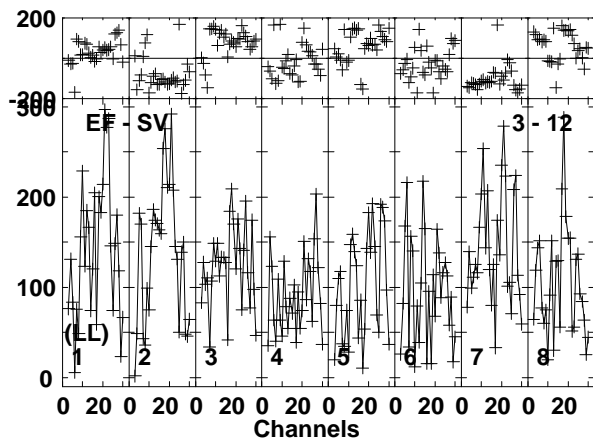
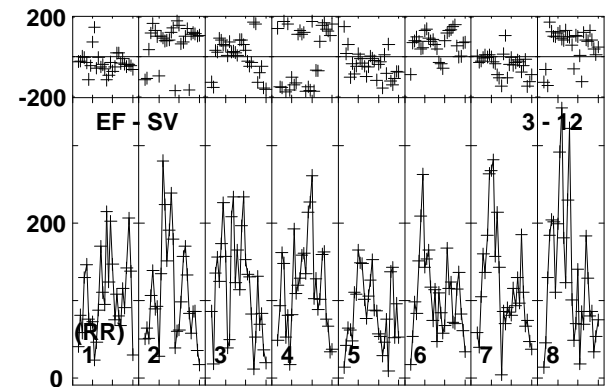
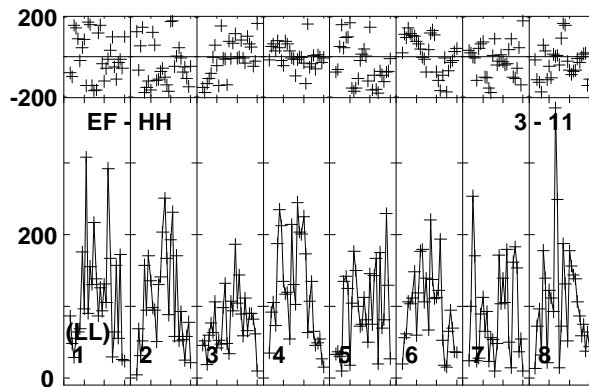
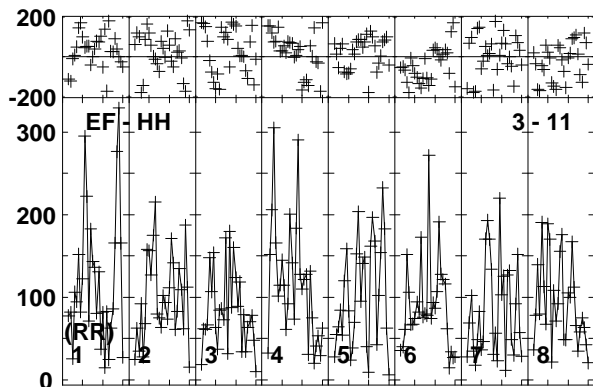
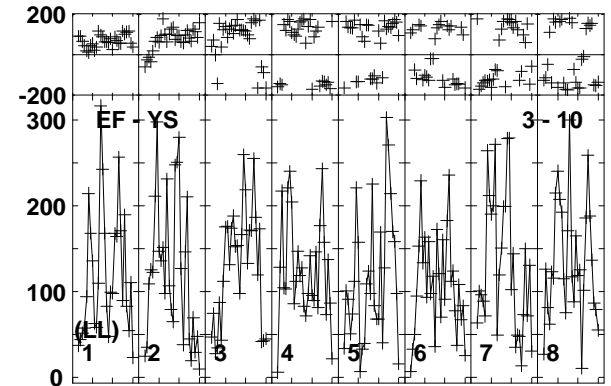
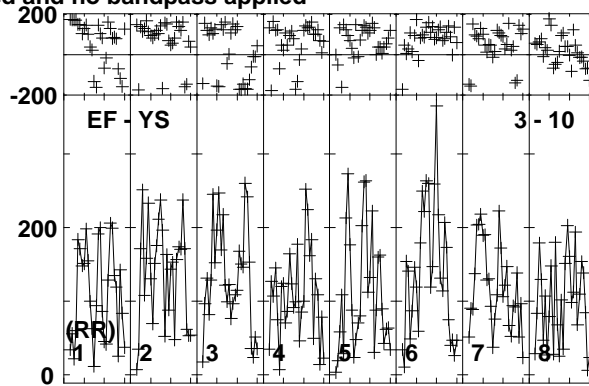
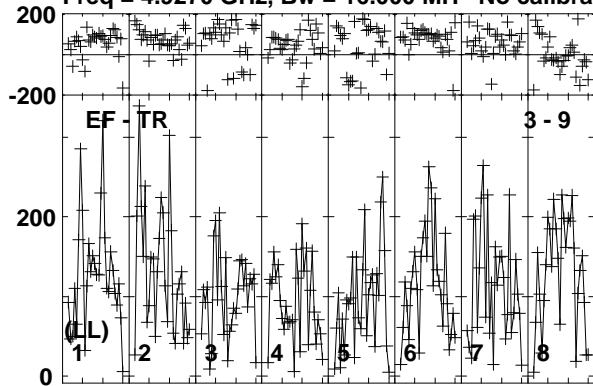

Lower frame: Micro Ampl Jy Top frame: Phas deg  
Vector averaged cross-power spectrum Baseline: EF (03) - TR (09)  
Timerange: 00/16:18:31 to 00/16:21:29



Plot file version 811 created 19-DEC-2018 17:59:06

AT2018\_RY007C.UVDATA.1

Freq = 4.9270 GHz, Bw = 16.000 MH No calibration applied and no bandpass applied

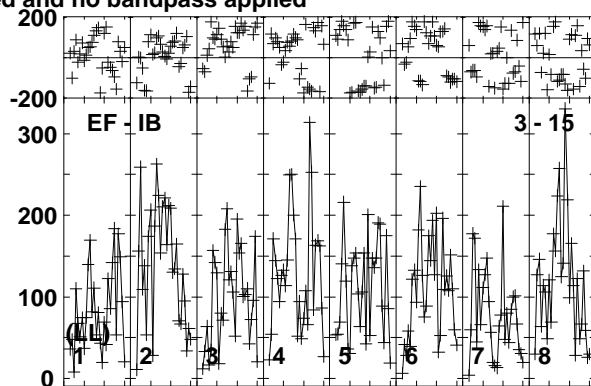
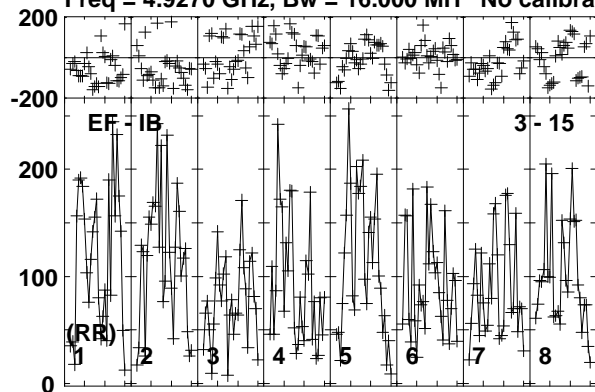

Lower frame: Micro Ampl Jy Top frame: Phas deg  
Vector averaged cross-power spectrum Baseline: EF (03) - IB (15)  
Timerange: 00/16:18:31 to 00/16:21:29

Plot file version 812 created 19-DEC-2018 17:59:06

J1619+2247 RY007C.UVDATA.1

Freq = 4.9270 GHz, Bw = 16.000 MH No calibration applied and no bandpass applied

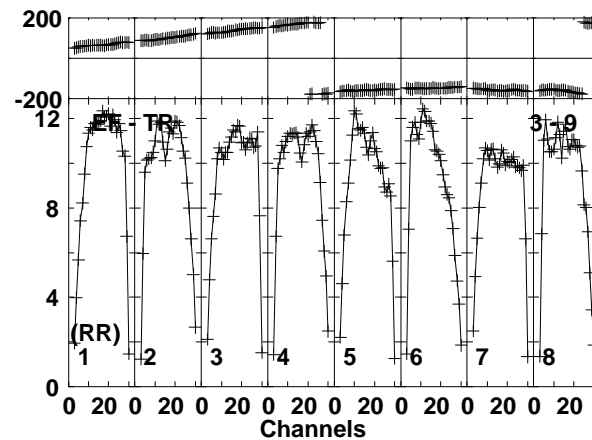
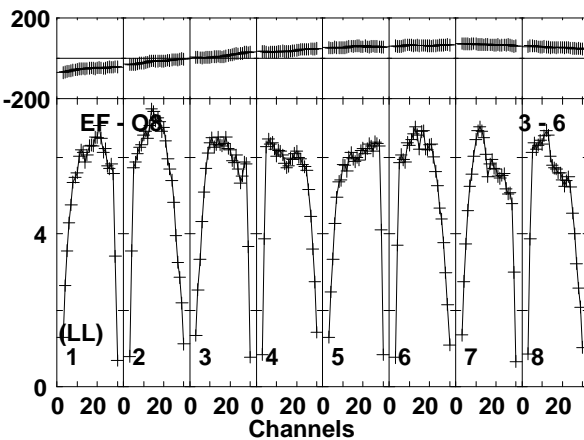
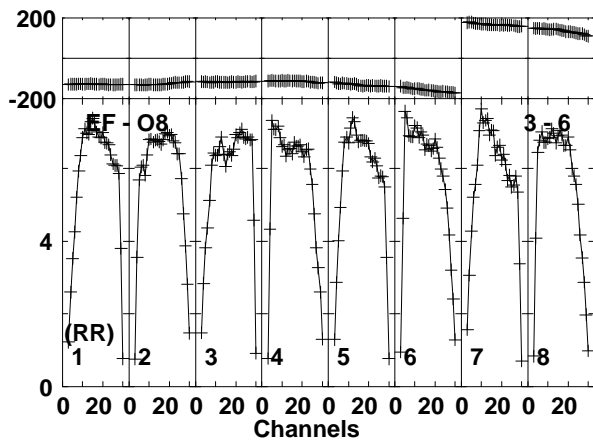
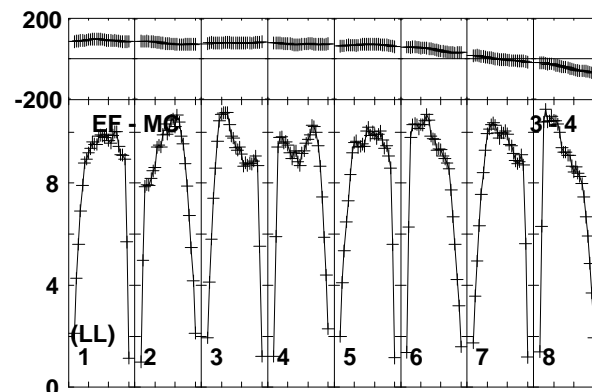
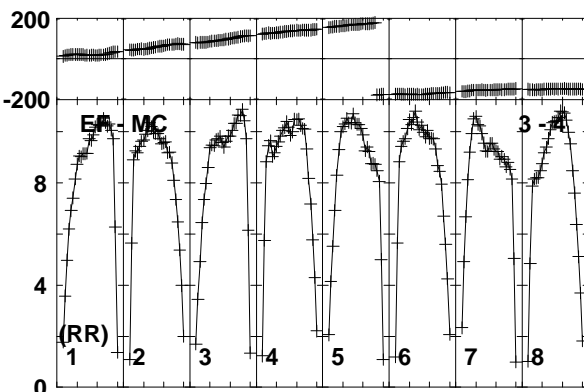
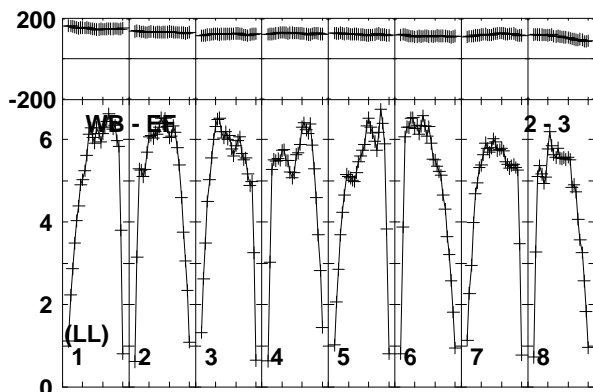
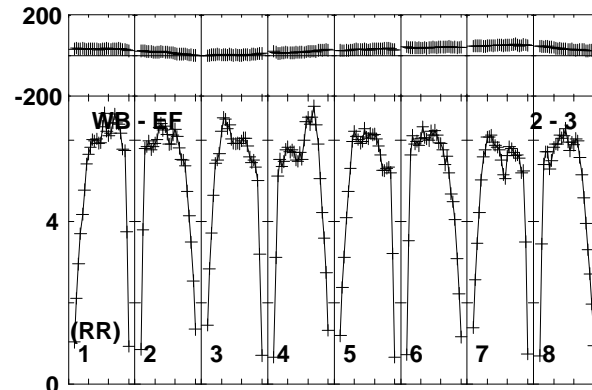
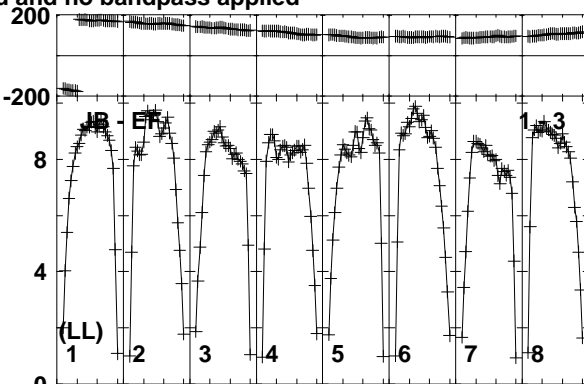
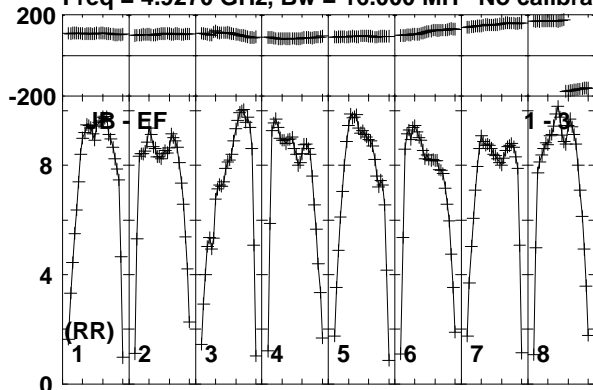

Lower frame: Milli Ampl Jy Top frame: Phas deg  
Vector averaged cross-power spectrum Baseline: JB (01) - EF (03)  
Timerange: 00/16:21:31 to 00/16:22:29

Plot file version 813 created 19-DEC-2018 17:59:06

J1619+2247 RY007C.UVDATA.1

Freq = 4.9270 GHz, Bw = 16.000 MH No calibration applied and no bandpass applied

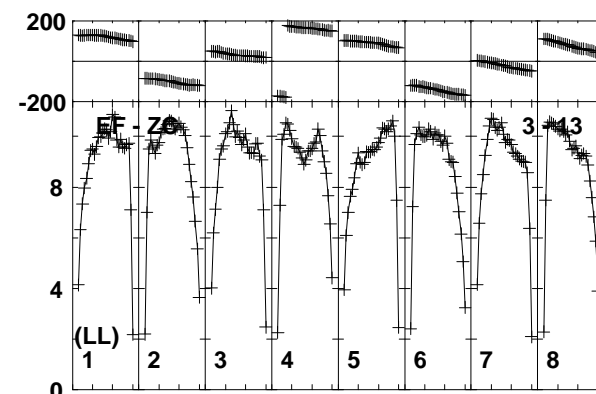
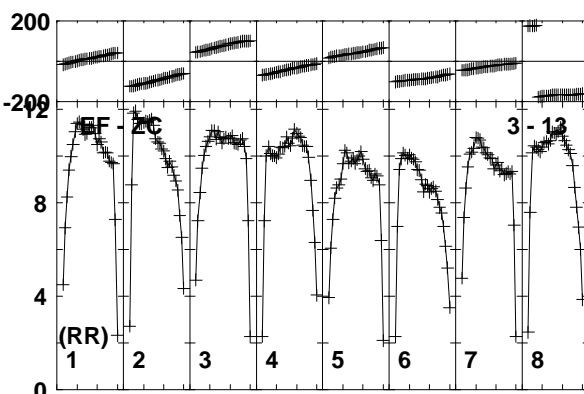
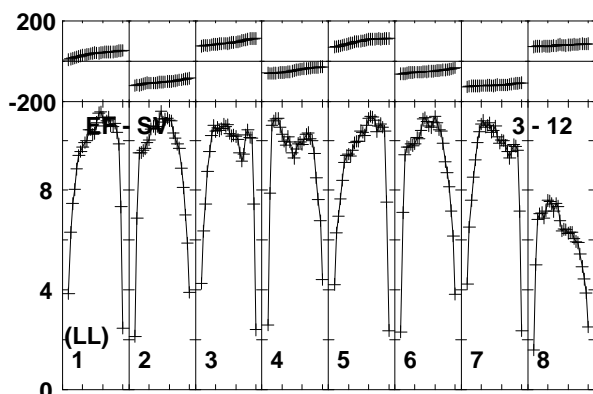
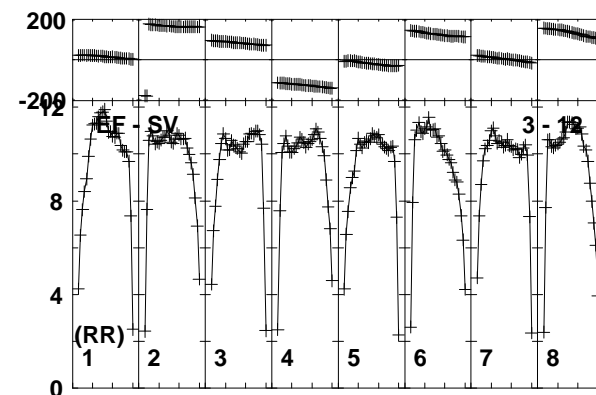
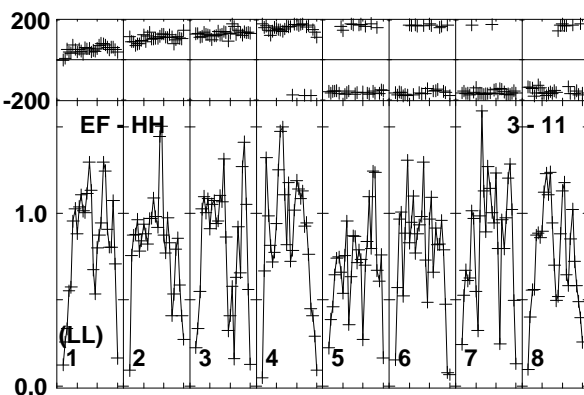
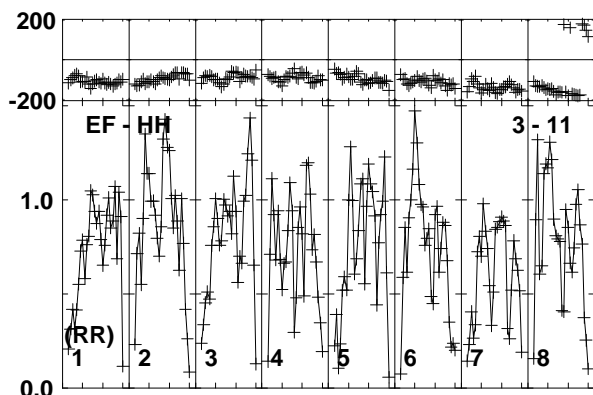
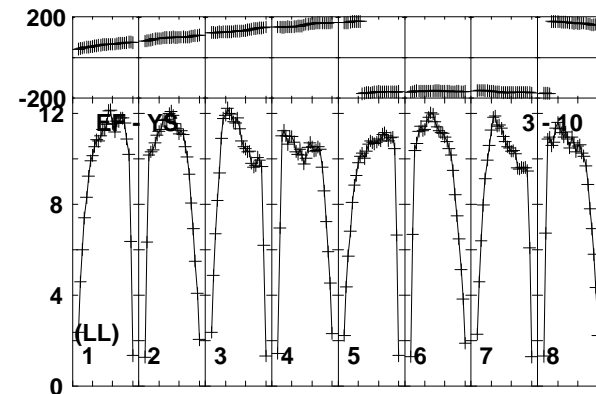
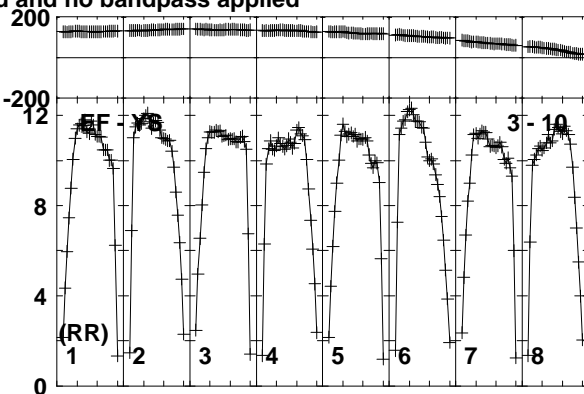
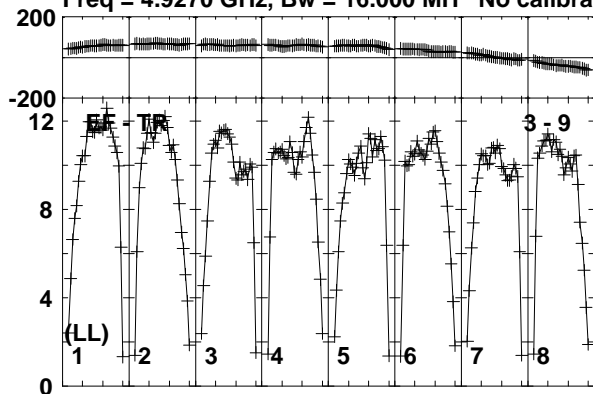

Lower frame: Milli Ampl Jy Top frame: Phas deg  
Vector averaged cross-power spectrum Baseline: EF (03) - TR (09)  
Timerange: 00/16:21:31 to 00/16:22:29

Plot file version 814 created 19-DEC-2018 17:59:06  
J1619+2247 RY007C.UVDATA.1

Freq = 4.9270 GHz, Bw = 16.000 MH No calibration applied and no bandpass applied

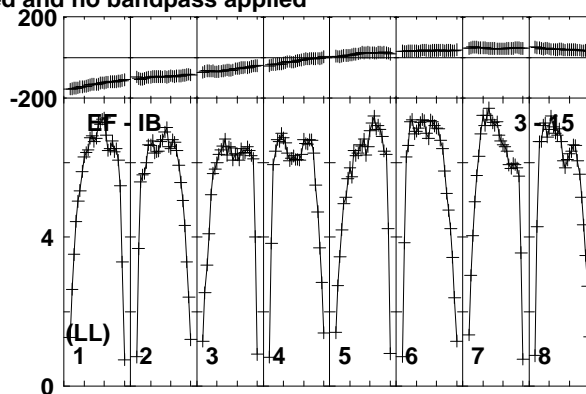
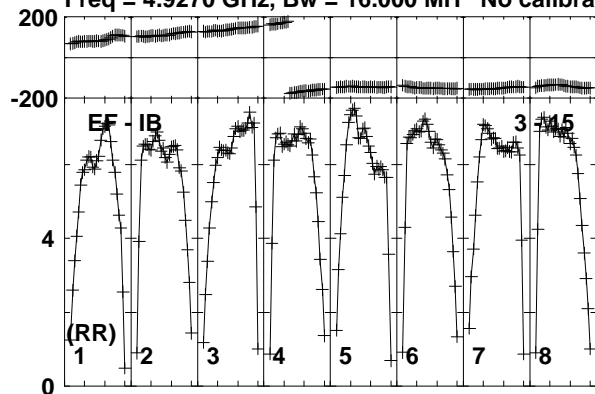

Lower frame: Milli Ampl Jy Top frame: Phas deg  
Vector averaged cross-power spectrum Baseline: EF (03) - IB (15)  
Timerange: 00/16:21:31 to 00/16:22:29

Plot file version 815 created 19-DEC-2018 17:59:06

VLA1 RY007C.UVDATA.1

Freq = 4.9270 GHz, Bw = 16.000 MH No calibration applied and no bandpass applied

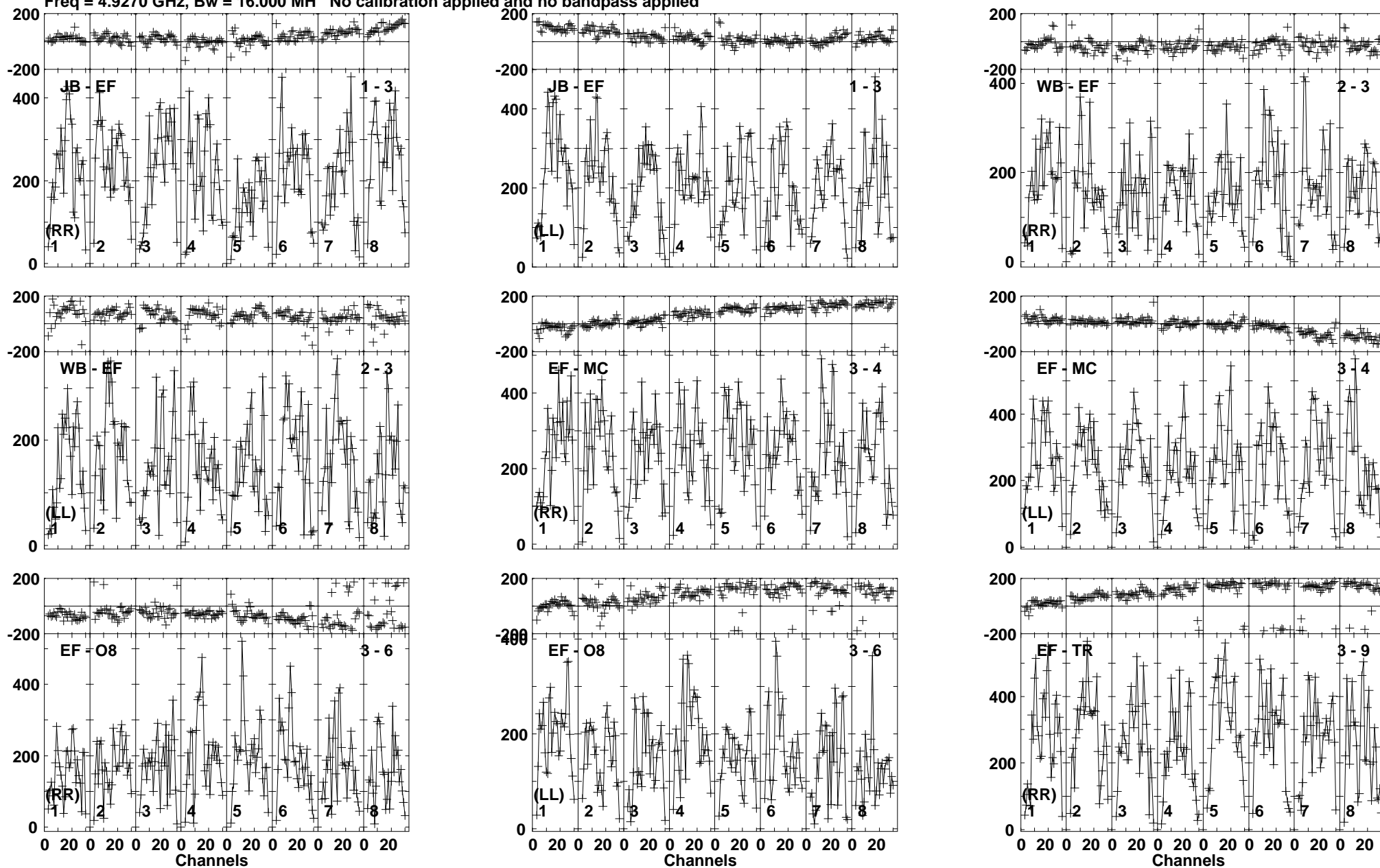

Lower frame: Micro Ampl Jy Top frame: Phas deg  
Vector averaged cross-power spectrum Baseline: JB (01) - EF (03)  
Timerange: 00/16:23:01 to 00/16:24:59

Plot file version 816 created 19-DEC-2018 17:59:06

VLA1 RY007C.UVDATA.1

Freq = 4.9270 GHz, Bw = 16.000 MH No calibration applied and no bandpass applied

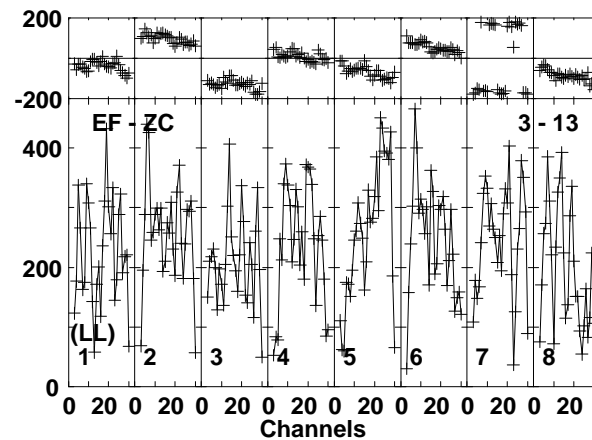
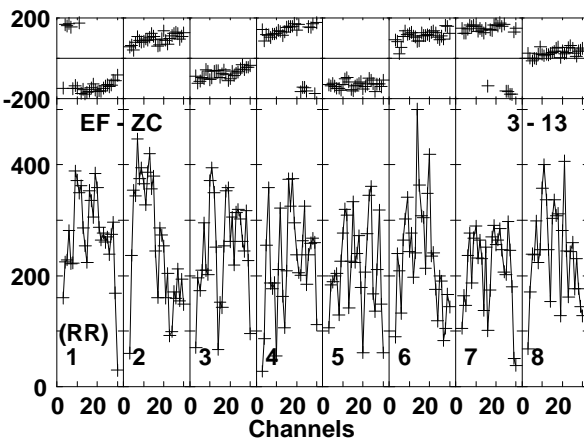
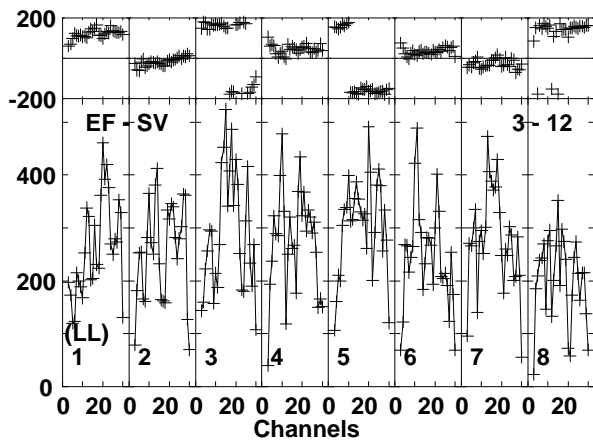
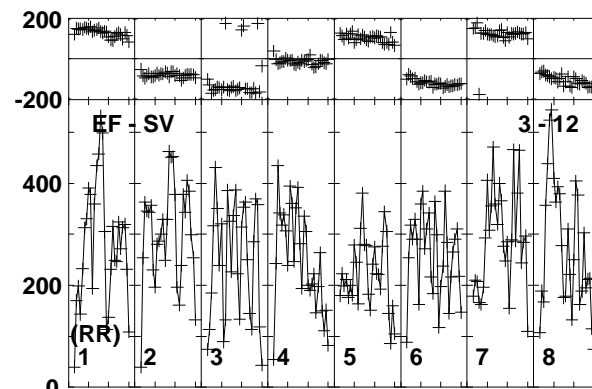
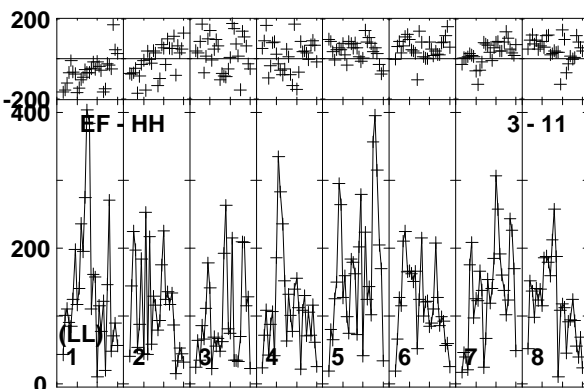
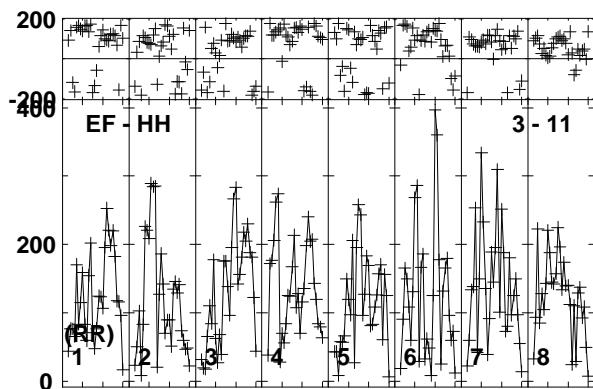
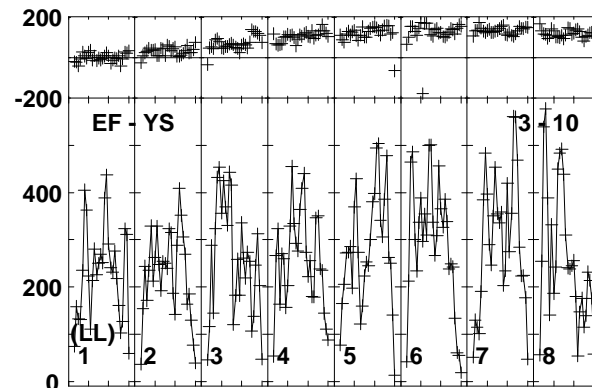
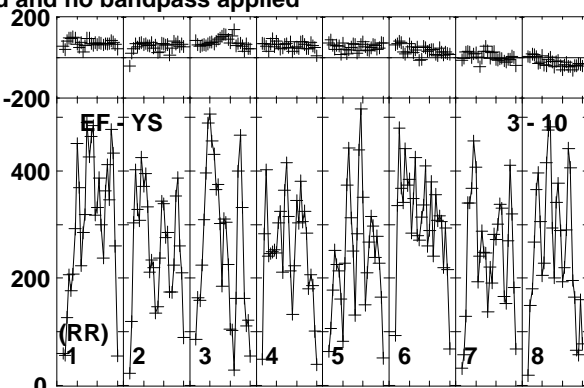
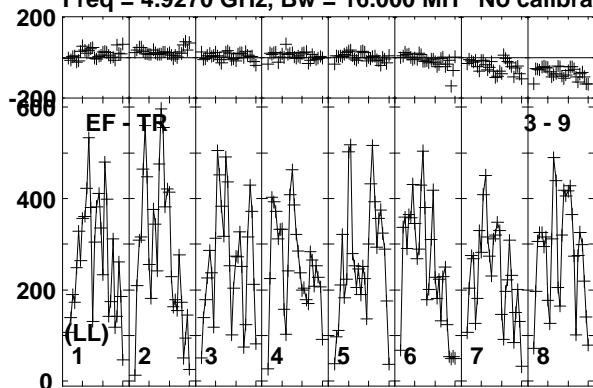

Lower frame: Micro Ampl Jy Top frame: Phas deg  
Vector averaged cross-power spectrum Baseline: EF (03) - TR (09)  
Timerange: 00/16:23:01 to 00/16:24:59

Plot file version 817 created 19-DEC-2018 17:59:06

VLA1 RY007C.UVDATA.1

Freq = 4.9270 GHz, Bw = 16.000 MH No calibration applied and no bandpass applied

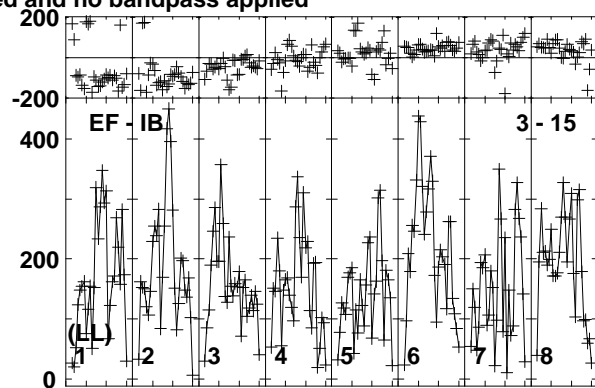
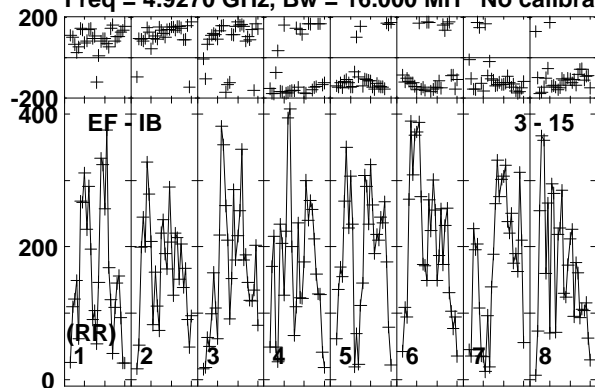

Lower frame: Micro Ampl Jy Top frame: Phas deg  
Vector averaged cross-power spectrum Baseline: EF (03) - IB (15)  
Timerange: 00/16:23:01 to 00/16:24:59

Plot file version 818 created 19-DEC-2018 17:59:06

J1619+2247 RY007C.UVDATA.1

Freq = 4.9270 GHz, Bw = 16.000 MH No calibration applied and no bandpass applied

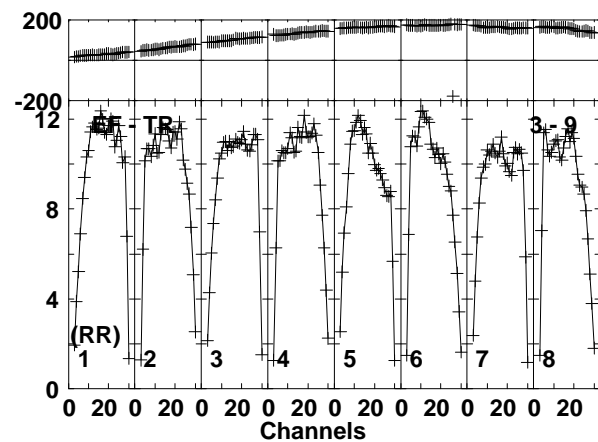
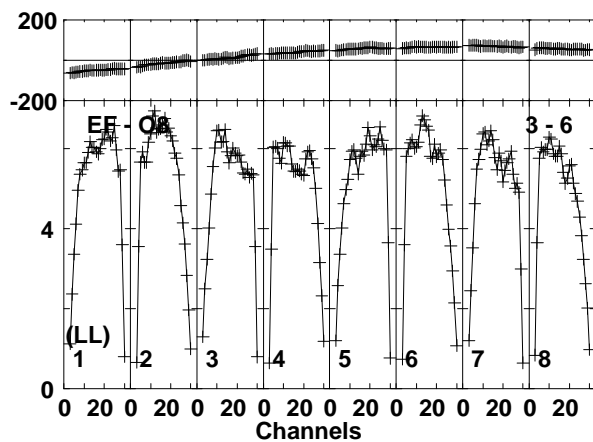
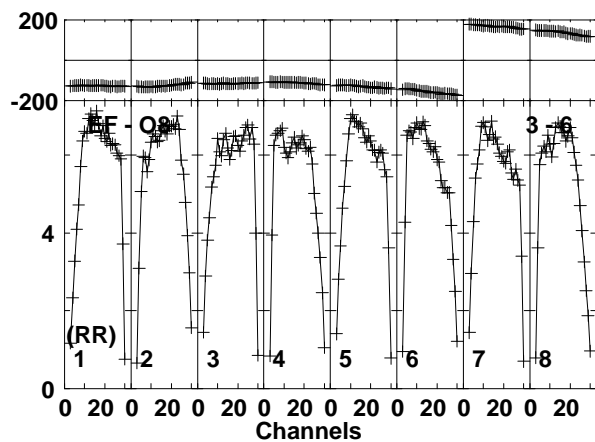
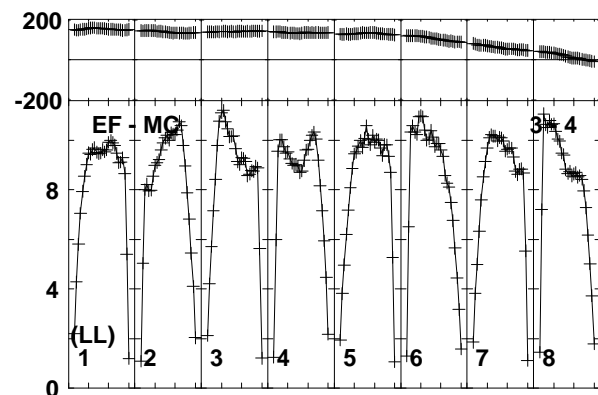
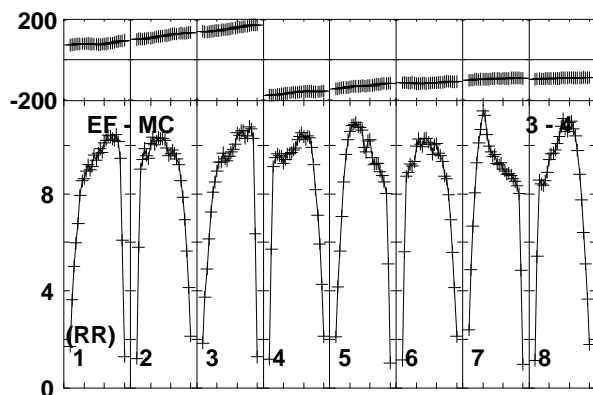
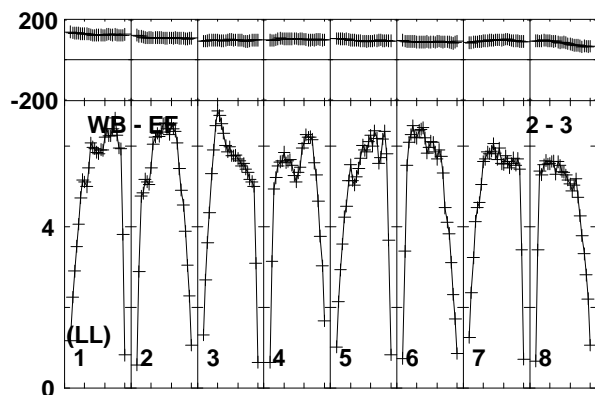
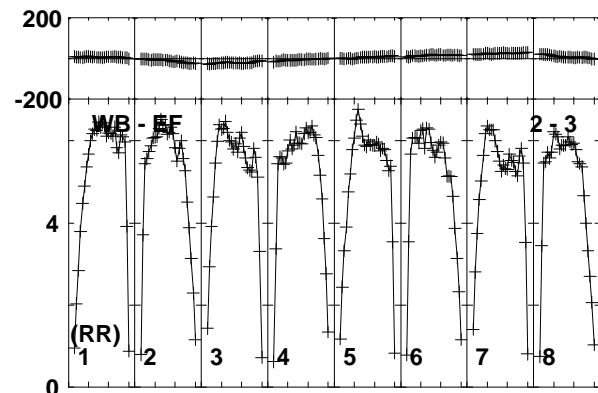
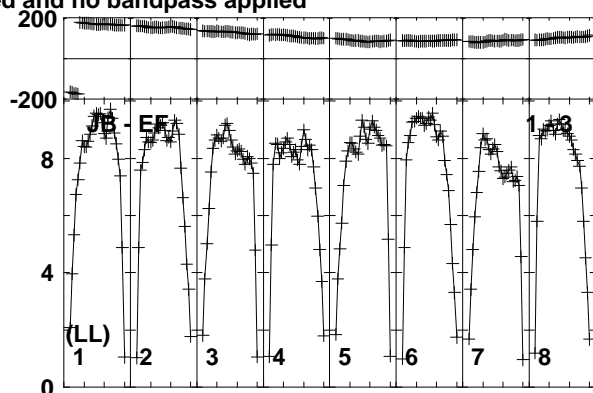
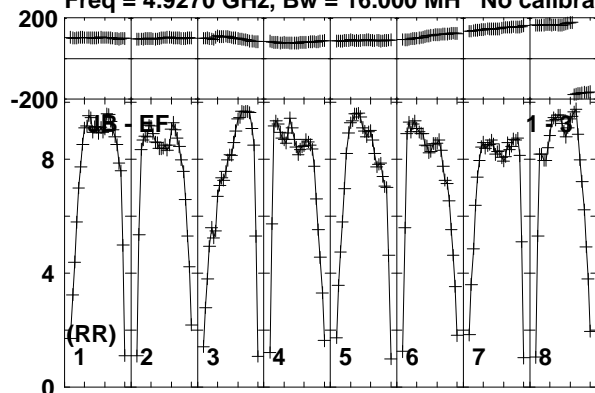

Lower frame: Milli Ampl Jy Top frame: Phas deg  
Vector averaged cross-power spectrum Baseline: JB (01) - EF (03)  
Timerange: 00/16:25:01 to 00/16:25:59



Plot file version 819 created 19-DEC-2018 17:59:06

J1619+2247 RY007C.UVDATA.1

Freq = 4.9270 GHz, Bw = 16.000 MH No calibration applied and no bandpass applied

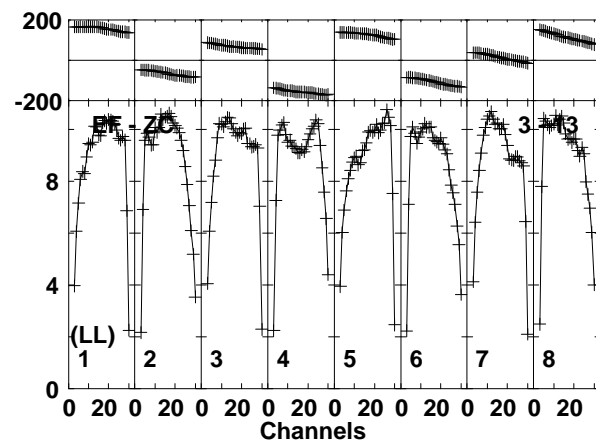
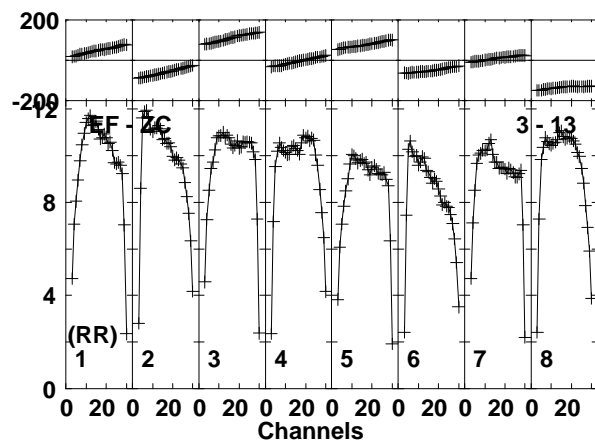
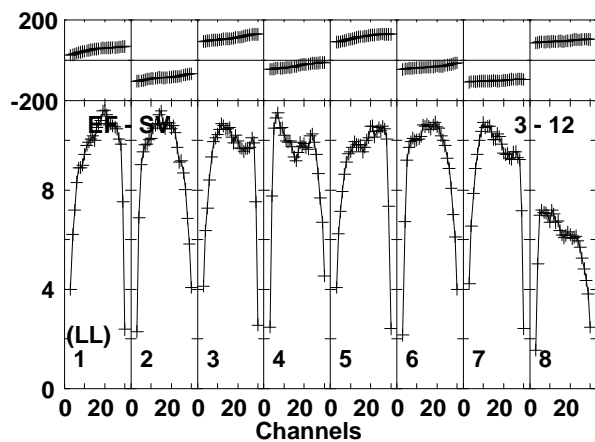
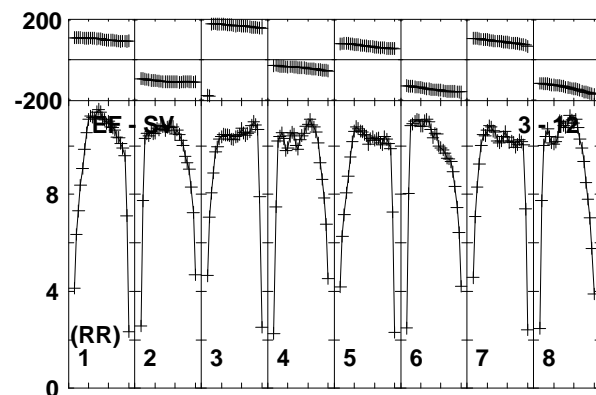
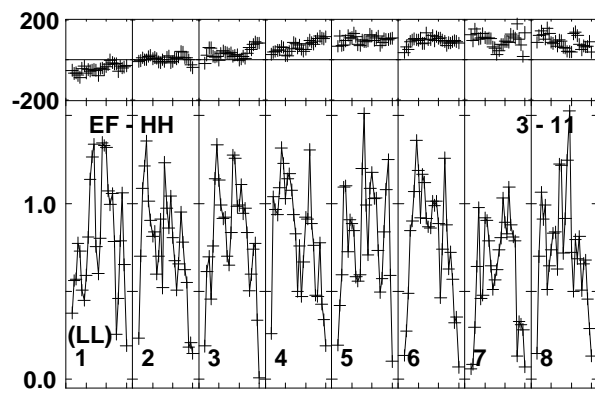
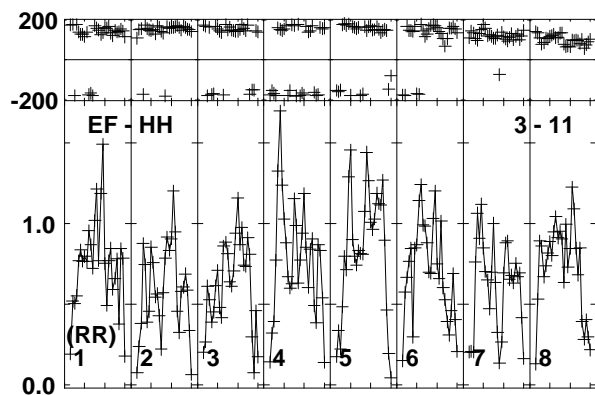
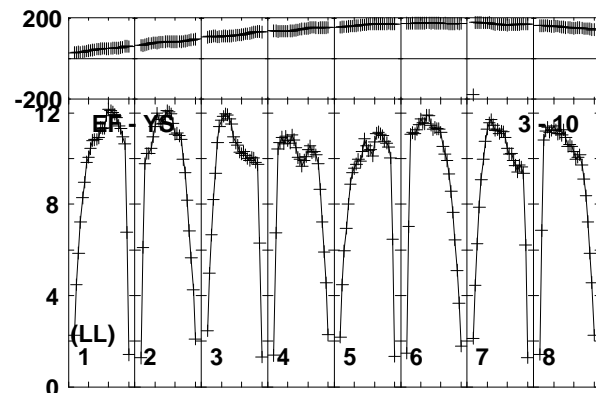
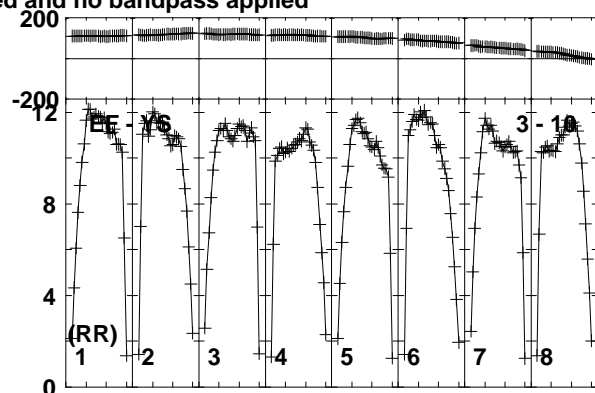
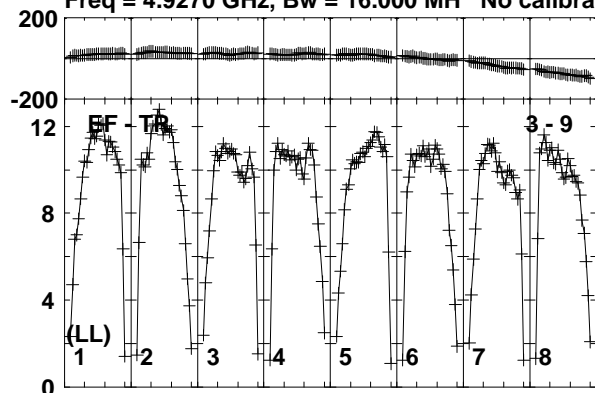

Lower frame: Milli Ampl Jy Top frame: Phas deg  
Vector averaged cross-power spectrum Baseline: EF (03) - TR (09)  
Timerange: 00/16:25:01 to 00/16:25:59

Plot file version 820 created 19-DEC-2018 17:59:06  
J1619+2247 RY007C.UVDATA.1

Freq = 4.9270 GHz, Bw = 16.000 MH No calibration applied and no bandpass applied

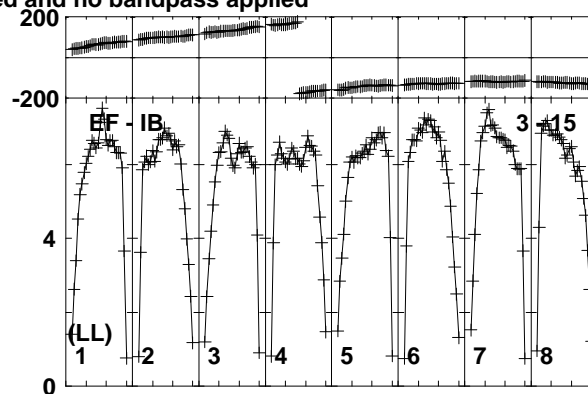
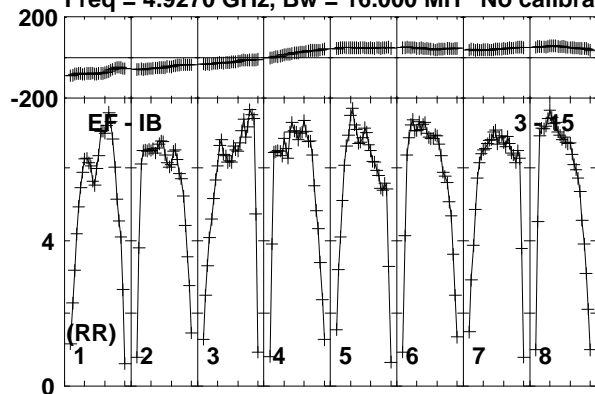

Lower frame: Milli Ampl Jy Top frame: Phas deg  
Vector averaged cross-power spectrum Baseline: EF (03) - IB (15)  
Timerange: 00/16:25:01 to 00/16:25:59

Plot file version 821 created 19-DEC-2018 17:59:06

AT2018\_RY007C.UVDATA.1

Freq = 4.9270 GHz, Bw = 16.000 MH No calibration applied and no bandpass applied

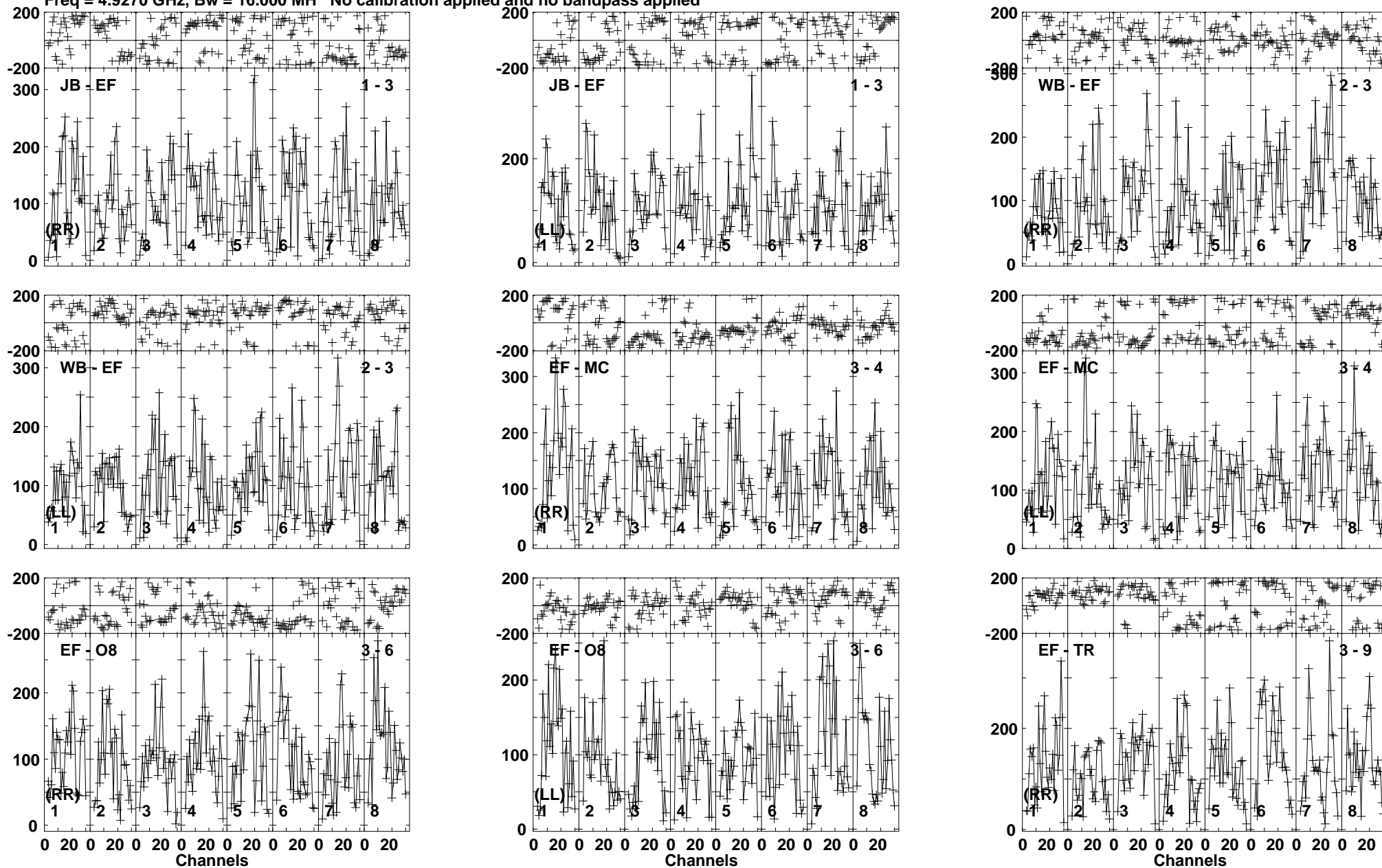

Lower frame: Micro Ampl Jy Top frame: Phas deg  
Vector averaged cross-power spectrum Baseline: JB (01) - EF (03)  
Timerange: 00/16:26:01 to 00/16:28:59

Plot file version 822 created 19-DEC-2018 17:59:07

AT2018\_RY007C.UVDATA.1

Freq = 4.9270 GHz, Bw = 16.000 MH No calibration applied and no bandpass applied

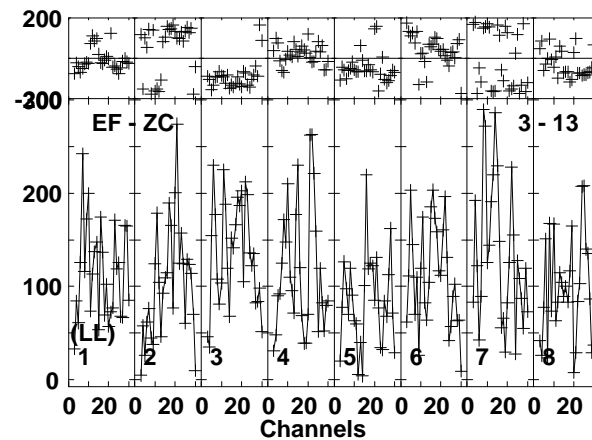
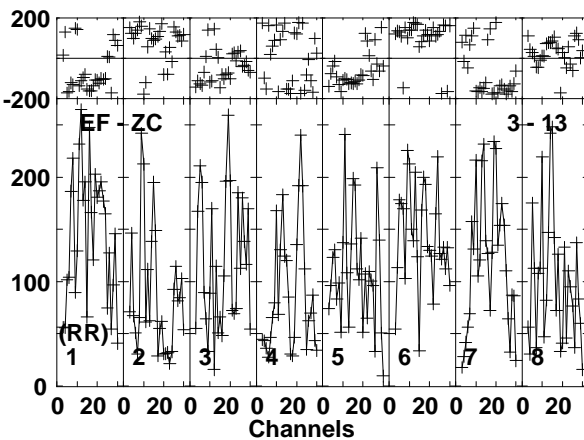
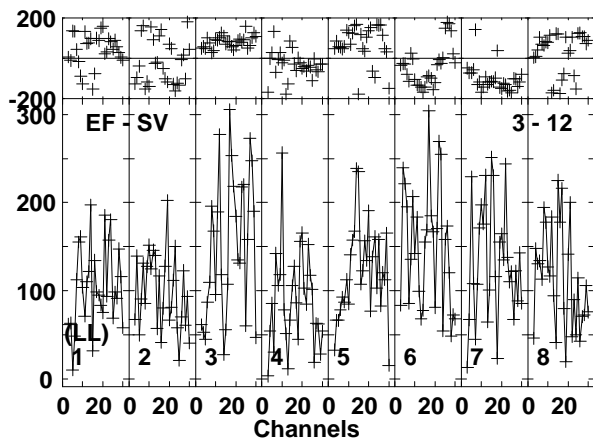
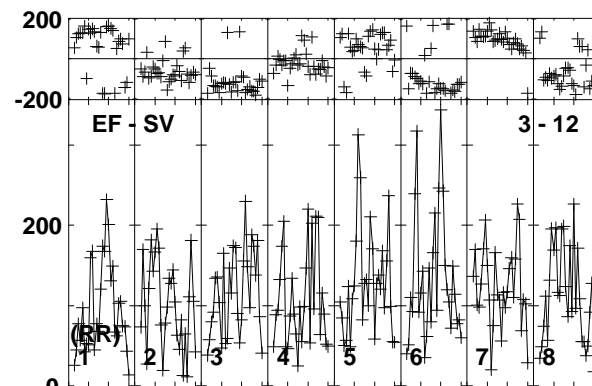
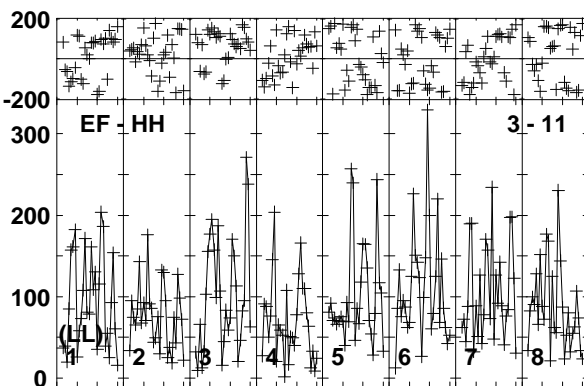
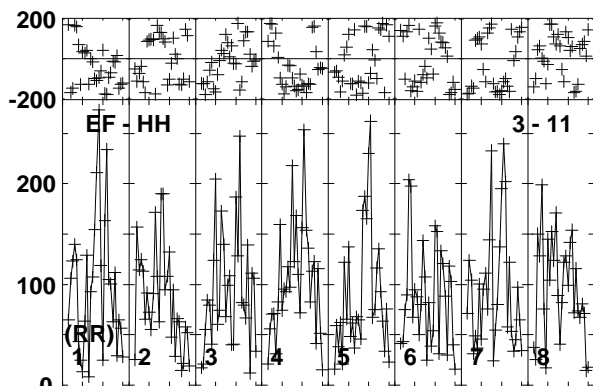
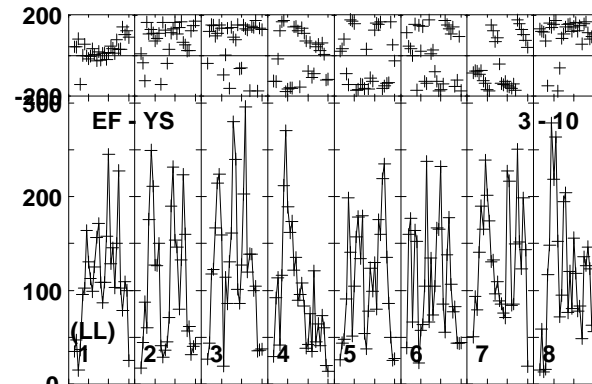
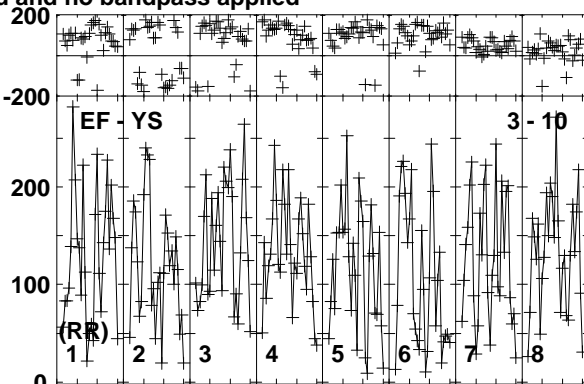
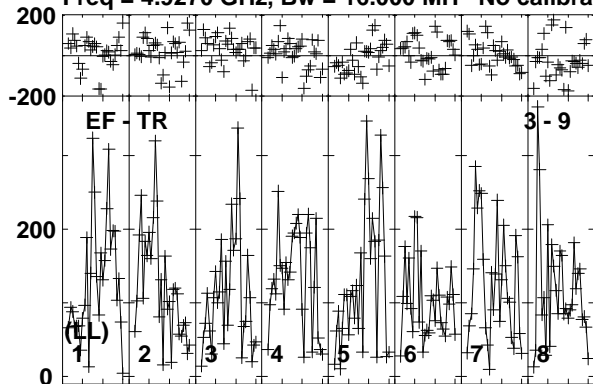

Lower frame: Micro Ampl Jy Top frame: Phas deg  
Vector averaged cross-power spectrum Baseline: EF (03) - TR (09)  
Timerange: 00/16:26:01 to 00/16:28:59

Plot file version 823 created 19-DEC-2018 17:59:07

AT2018\_RY007C.UVDATA.1

Freq = 4.9270 GHz, Bw = 16.000 MH No calibration applied and no bandpass applied

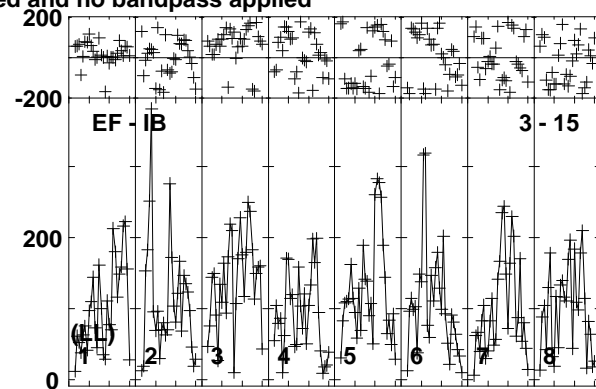
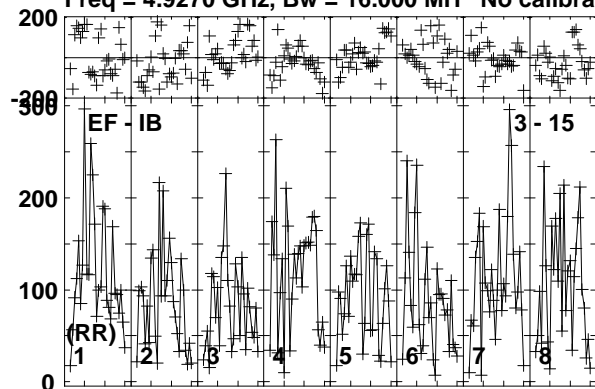

Lower frame: Micro Ampl Jy Top frame: Phas deg  
Vector averaged cross-power spectrum Baseline: EF (03) - IB (15)  
Timerange: 00/16:26:01 to 00/16:28:59

Plot file version 824 created 19-DEC-2018 17:59:07

J1619+2247 RY007C.UVDATA.1

Freq = 4.9270 GHz, Bw = 16.000 MH No calibration applied and no bandpass applied

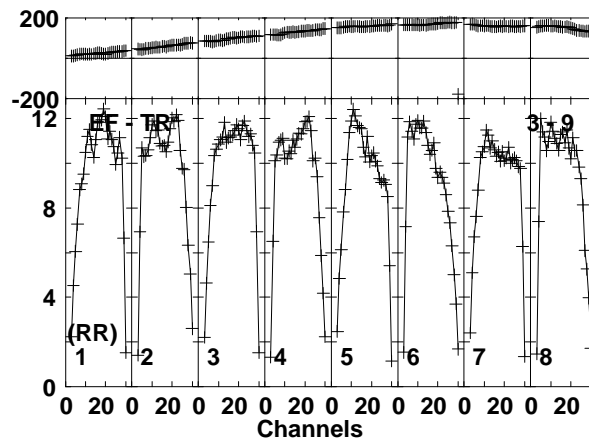
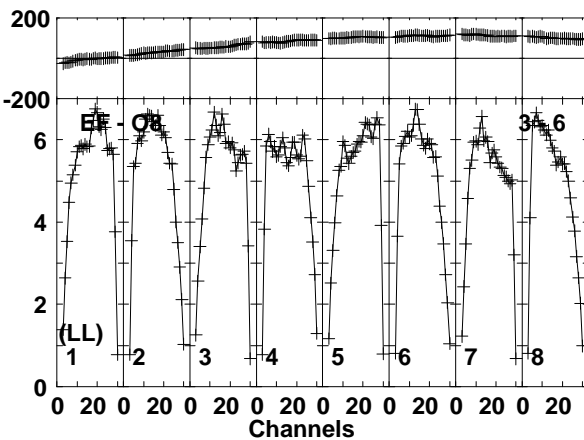
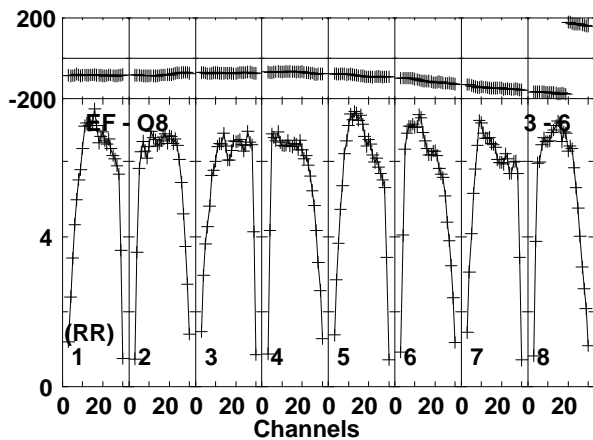
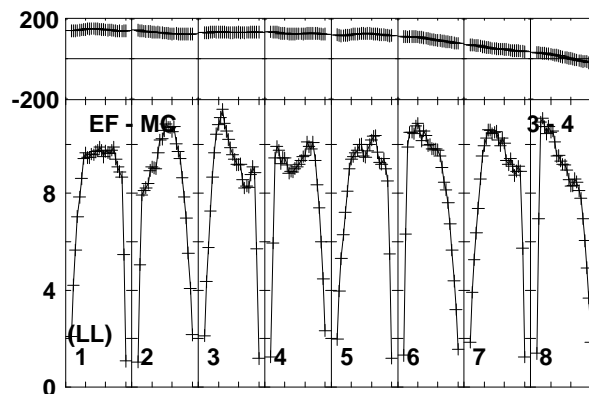
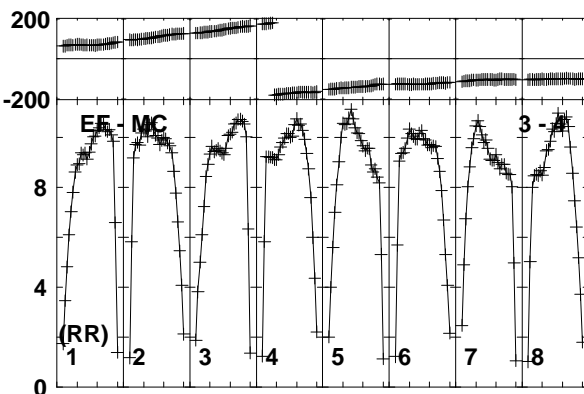
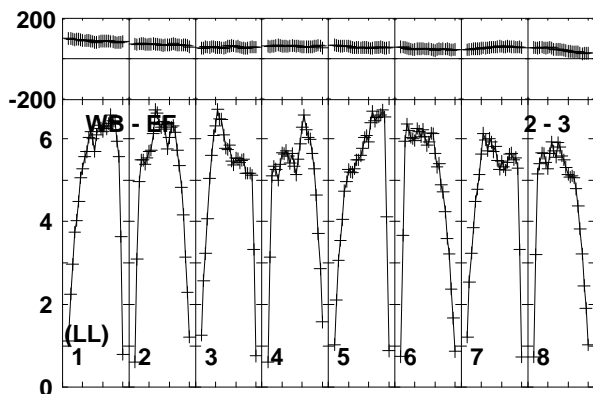
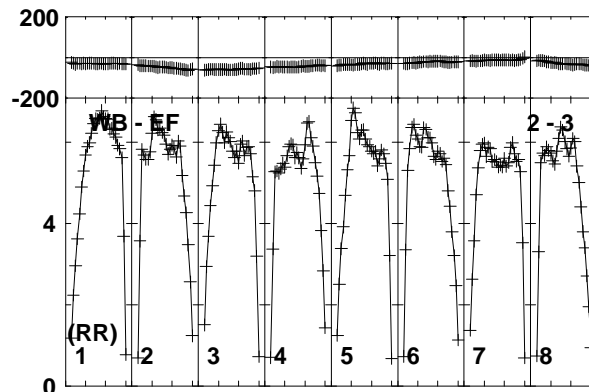
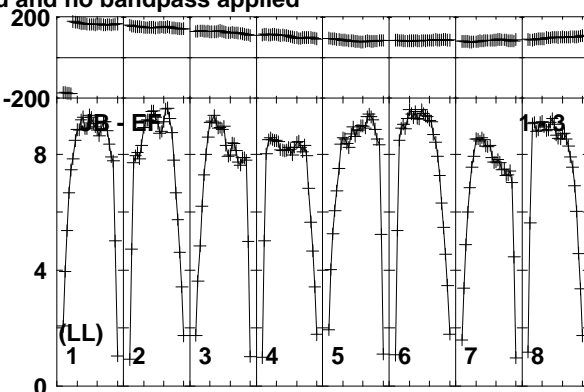
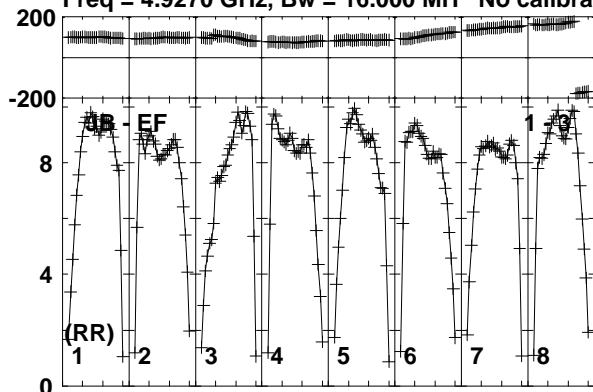

Lower frame: Milli Ampl Jy Top frame: Phas deg  
Vector averaged cross-power spectrum Baseline: JB (01) - EF (03)  
Timerange: 00/16:29:01 to 00/16:29:59

Plot file version 825 created 19-DEC-2018 17:59:07

J1619+2247 RY007C.UVDATA.1

Freq = 4.9270 GHz, Bw = 16.000 MH No calibration applied and no bandpass applied

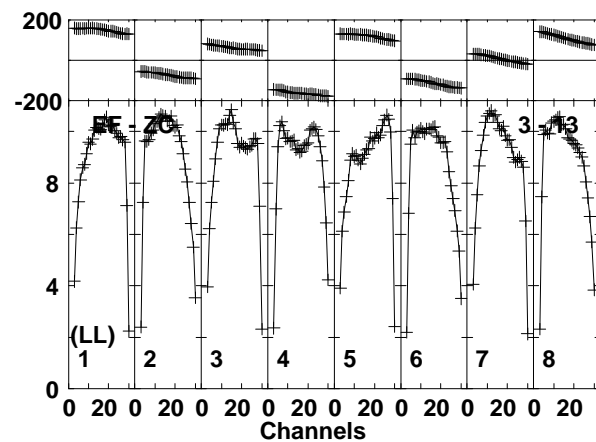
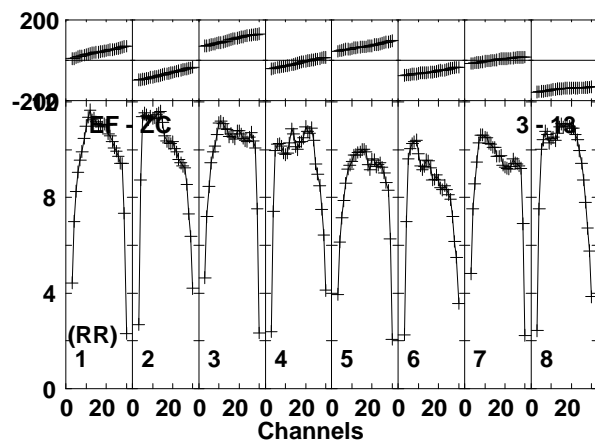
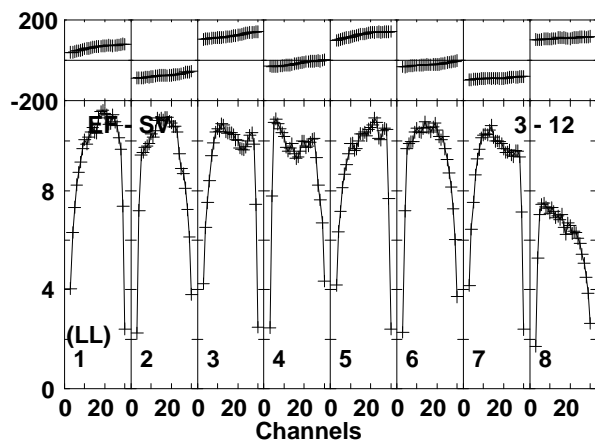
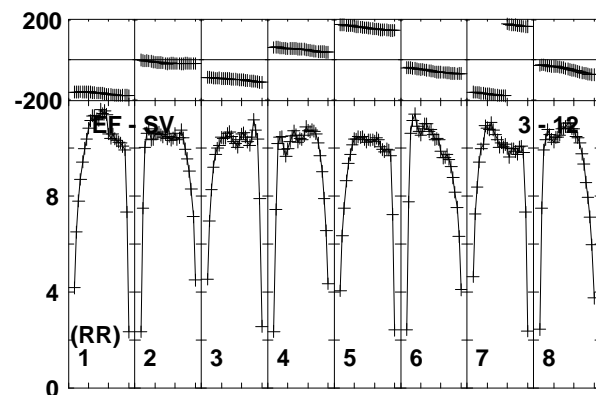
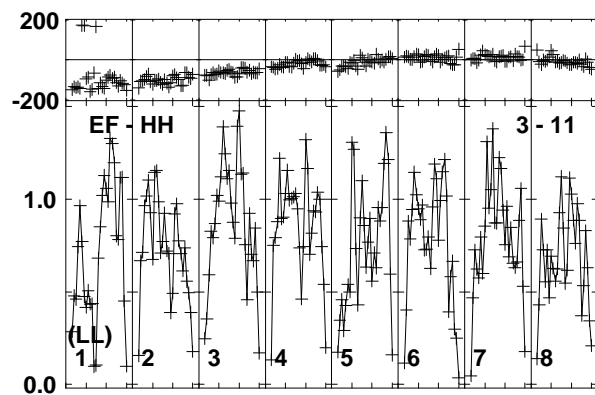
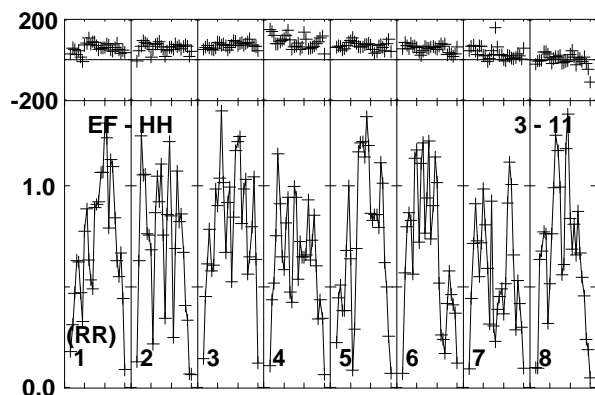
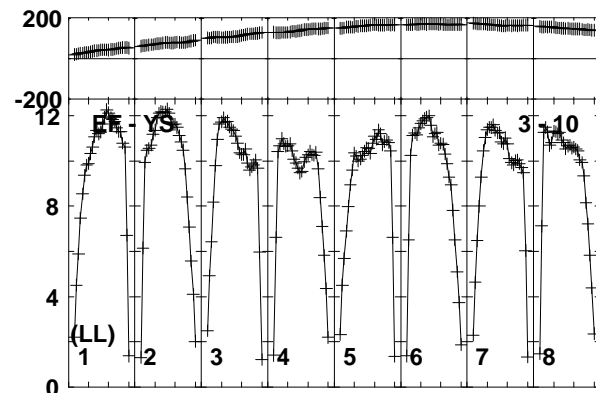
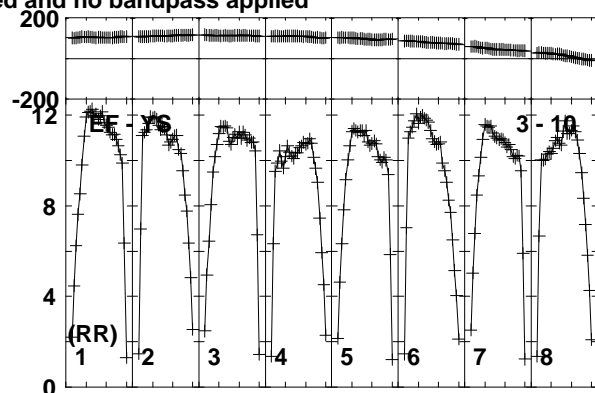
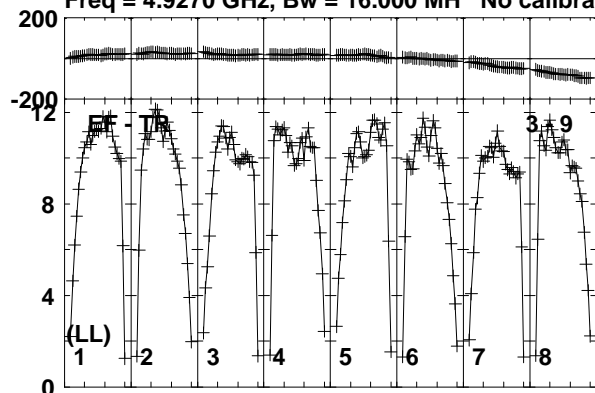

Lower frame: Milli Ampl Jy Top frame: Phas deg  
Vector averaged cross-power spectrum Baseline: EF (03) - TR (09)  
Timerange: 00/16:29:01 to 00/16:29:59

Plot file version 826 created 19-DEC-2018 17:59:07

J1619+2247 RY007C.UVDATA.1

Freq = 4.9270 GHz, Bw = 16.000 MH No calibration applied and no bandpass applied

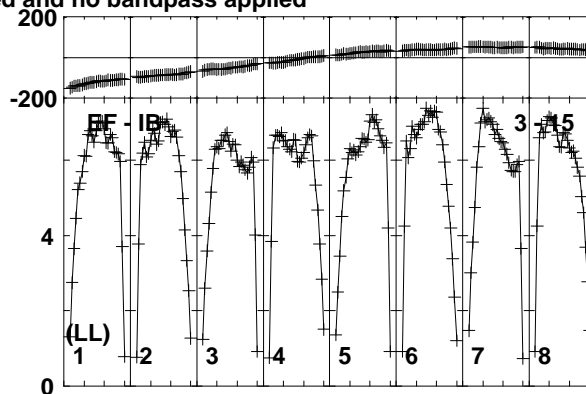
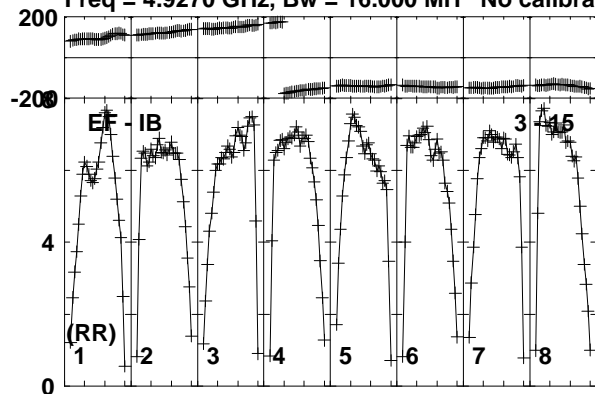

Lower frame: Milli Ampl Jy Top frame: Phas deg  
Vector averaged cross-power spectrum Baseline: EF (03) - IB (15)  
Timerange: 00/16:29:01 to 00/16:29:59



Plot file version 827 created 19-DEC-2018 17:59:07

AT2018\_RY007C.UVDATA.1

Freq = 4.9270 GHz, Bw = 16.000 MH No calibration applied and no bandpass applied

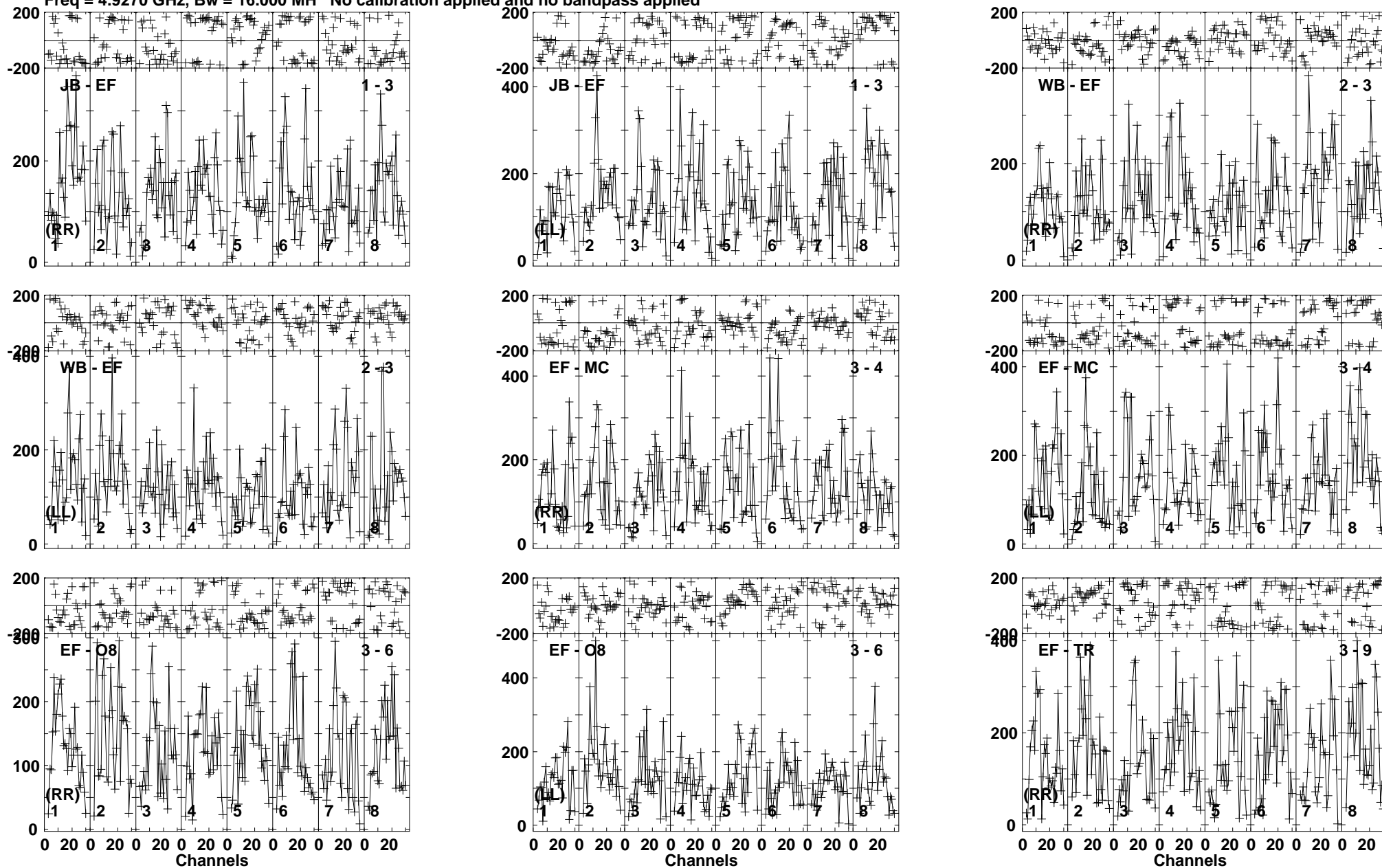

Lower frame: Micro Ampl Jy Top frame: Phas deg  
Vector averaged cross-power spectrum Baseline: JB (01) - EF (03)  
Timerange: 00/16:30:01 to 00/16:31:59

Plot file version 828 created 19-DEC-2018 17:59:07

AT2018\_RY007C.UVDATA.1

Freq = 4.9270 GHz, Bw = 16.000 MH No calibration applied and no bandpass applied

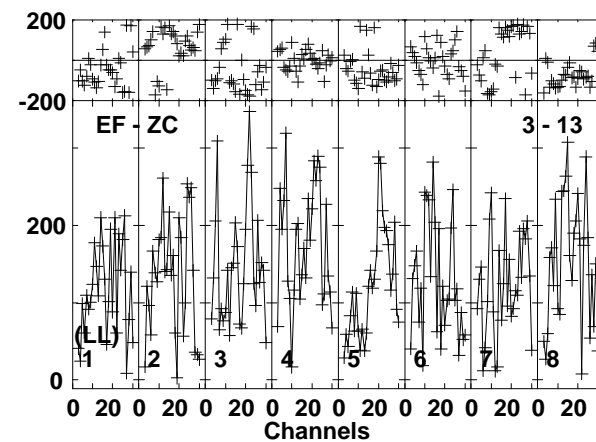
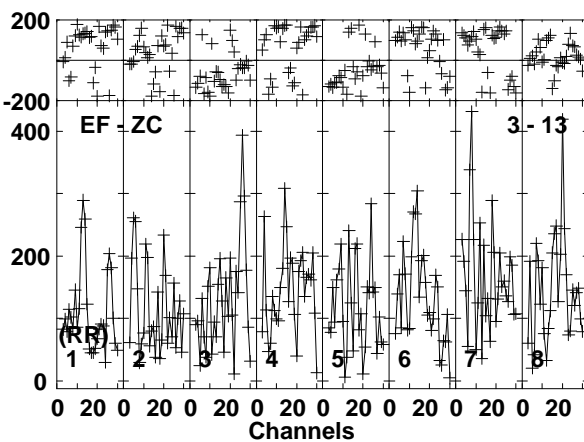
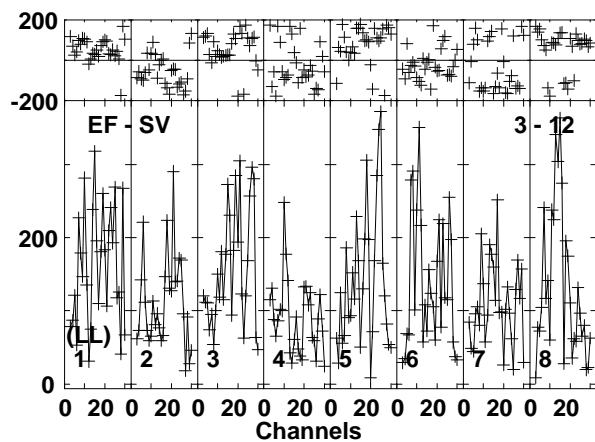
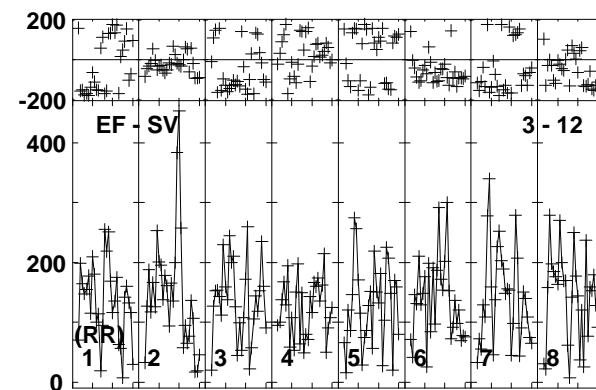
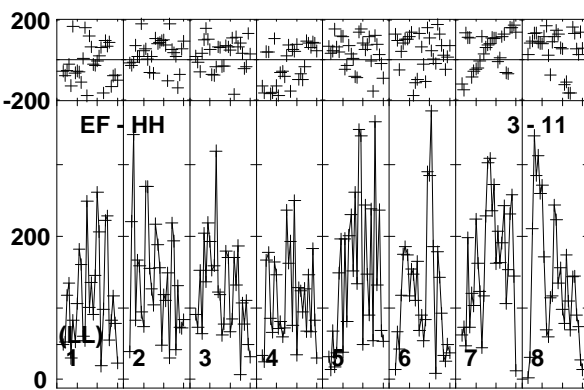
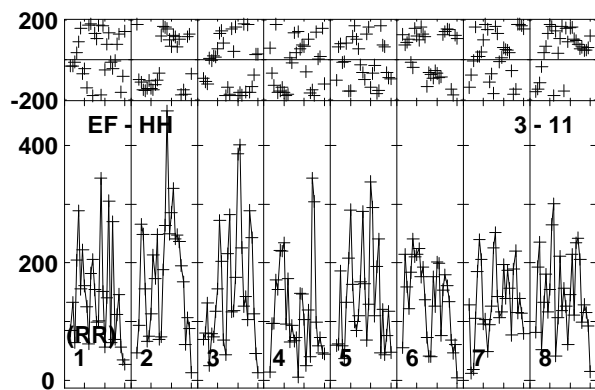
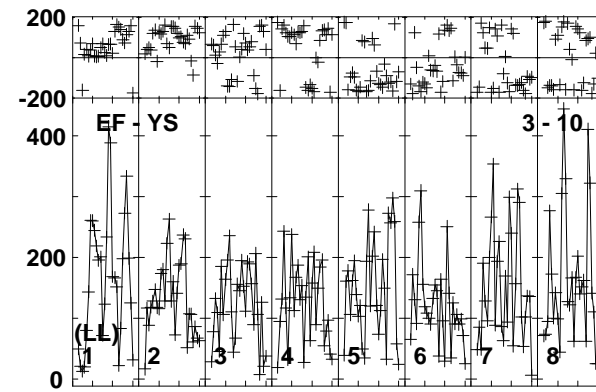
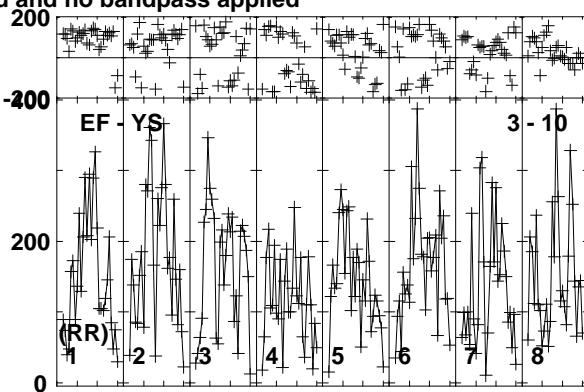
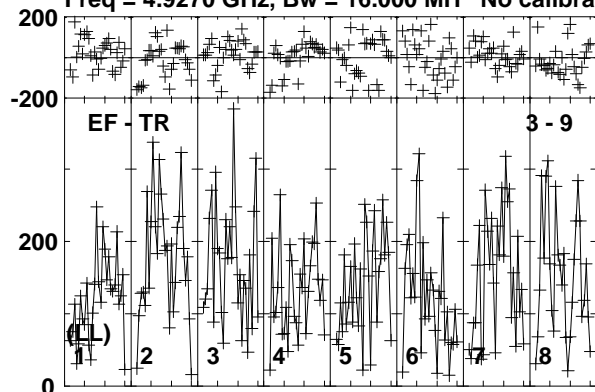

Lower frame: Micro Ampl Jy Top frame: Phas deg  
Vector averaged cross-power spectrum Baseline: EF (03) - TR (09)  
Timerange: 00/16:30:01 to 00/16:31:59

Plot file version 829 created 19-DEC-2018 17:59:07

AT2018\_RY007C.UVDATA.1

Freq = 4.9270 GHz, Bw = 16.000 MH No calibration applied and no bandpass applied

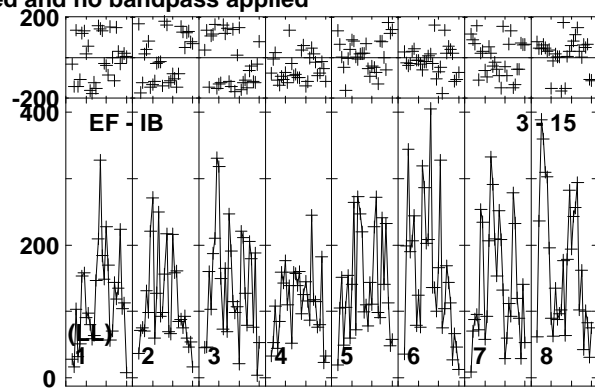
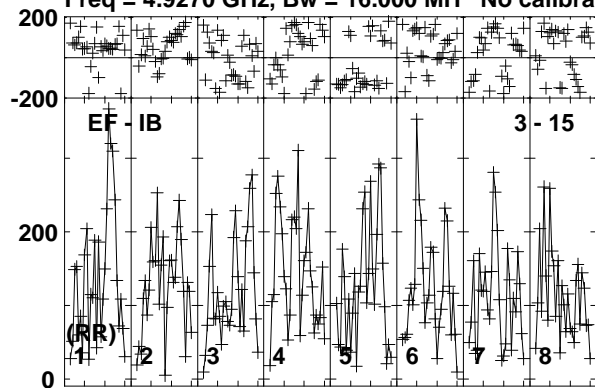

Lower frame: Micro Ampl Jy Top frame: Phas deg  
Vector averaged cross-power spectrum Baseline: EF (03) - IB (15)  
Timerange: 00/16:30:01 to 00/16:31:59

Plot file version 830 created 19-DEC-2018 17:59:07

VLA2 RY007C.UVDATA.1

Freq = 4.9270 GHz, Bw = 16.000 MH No calibration applied and no bandpass applied

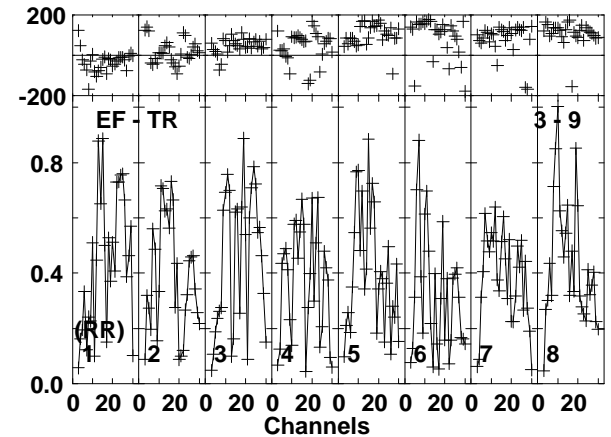
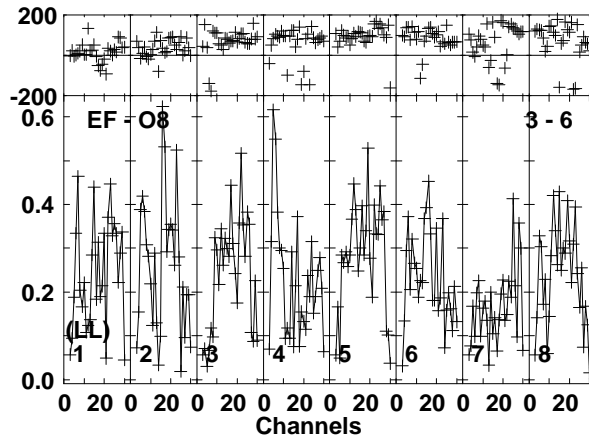
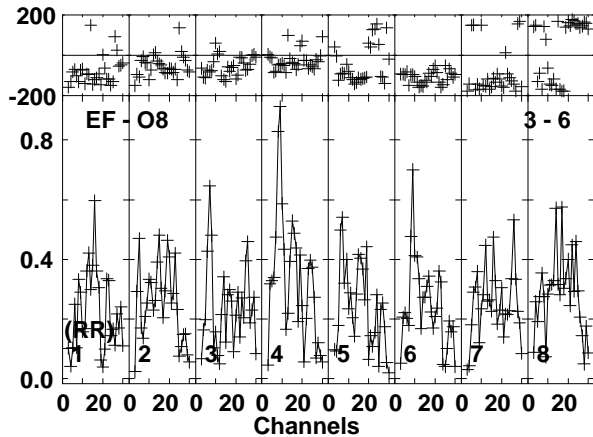
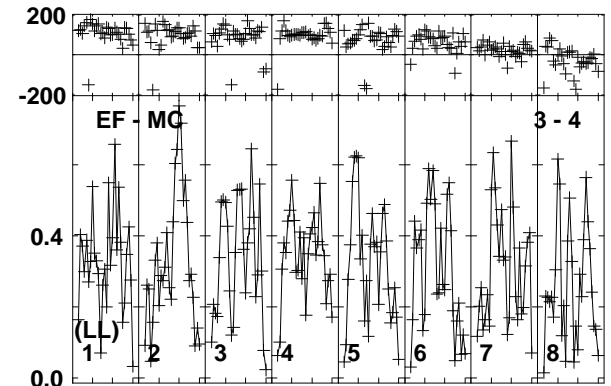
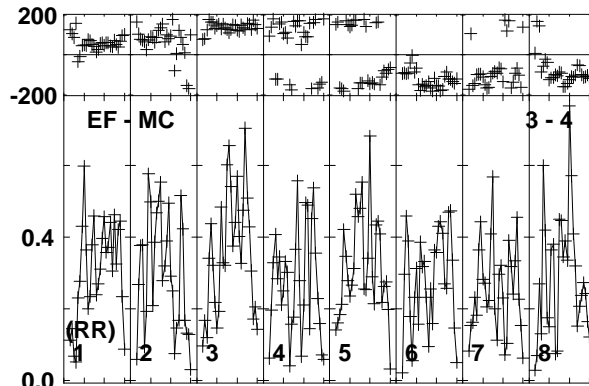
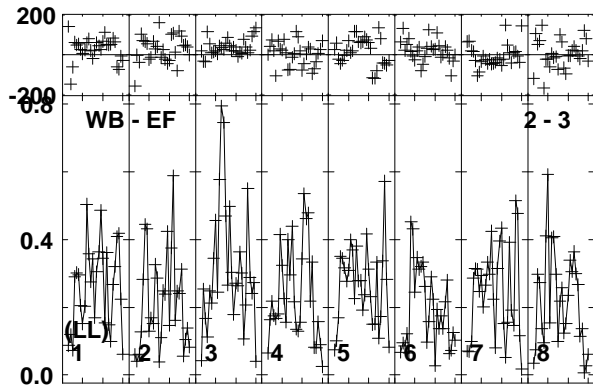
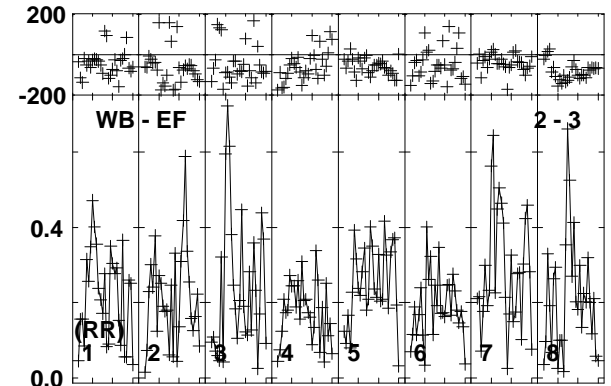
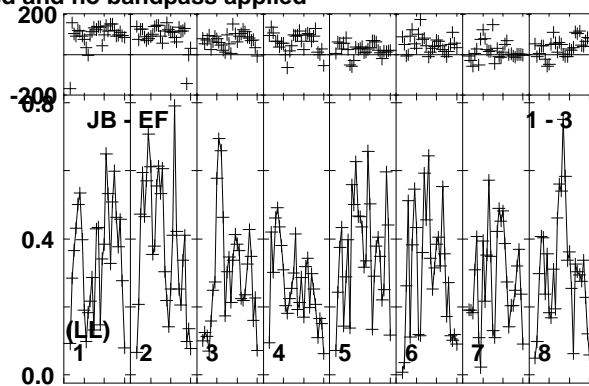
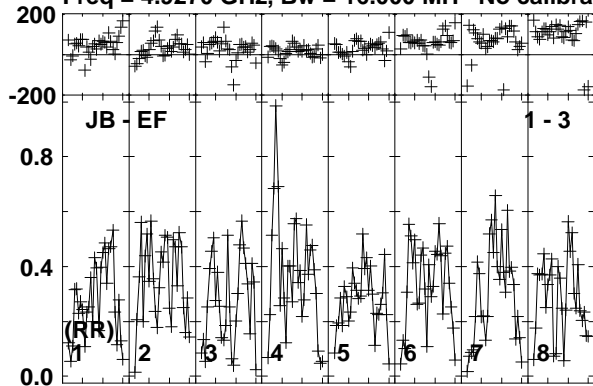

Lower frame: Milli Ampl Jy Top frame: Phas deg  
Vector averaged cross-power spectrum Baseline: JB (01) - EF (03)  
Timerange: 00/16:32:01 to 00/16:32:59

Plot file version 831 created 19-DEC-2018 17:59:07

VLA2 RY007C.UVDATA.1

Freq = 4.9270 GHz, Bw = 16.000 MH No calibration applied and no bandpass applied

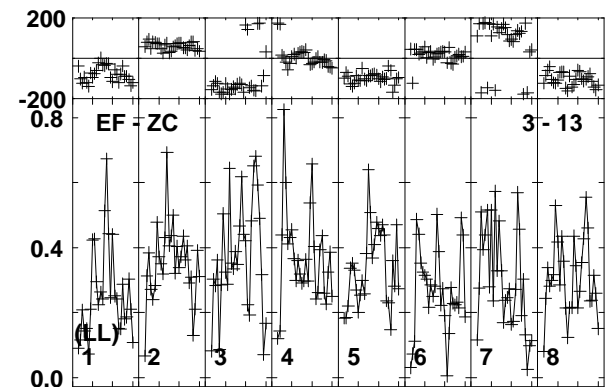
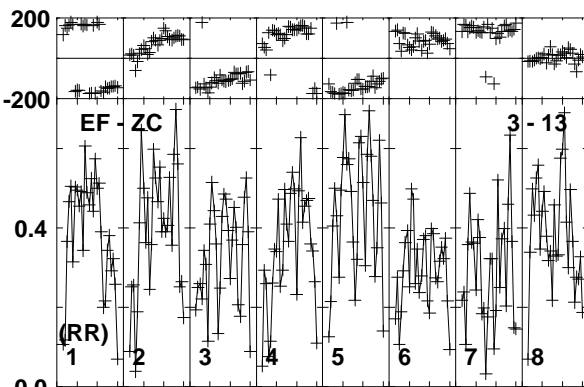
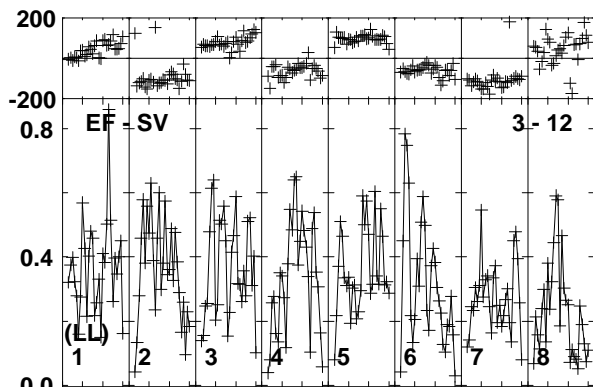
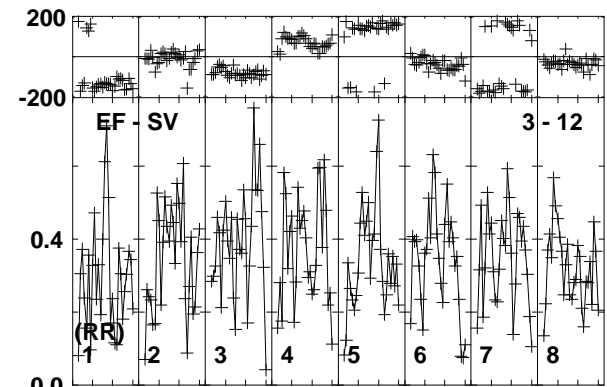
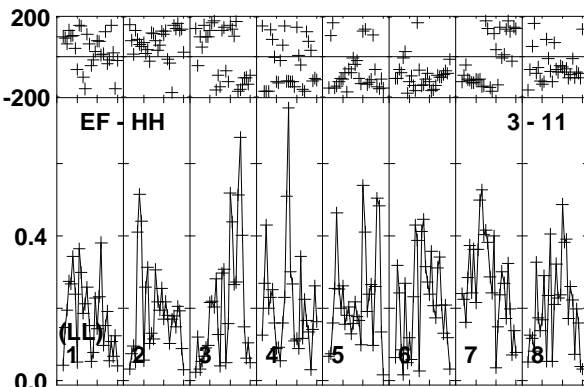
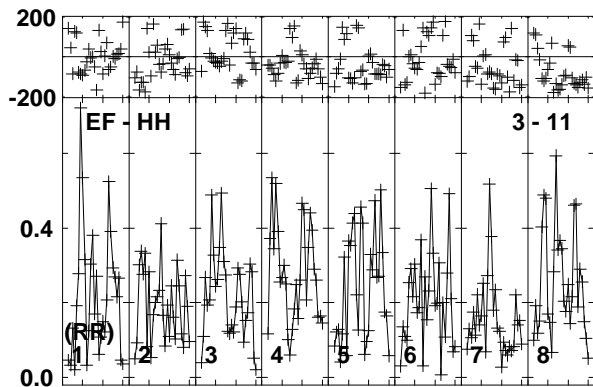
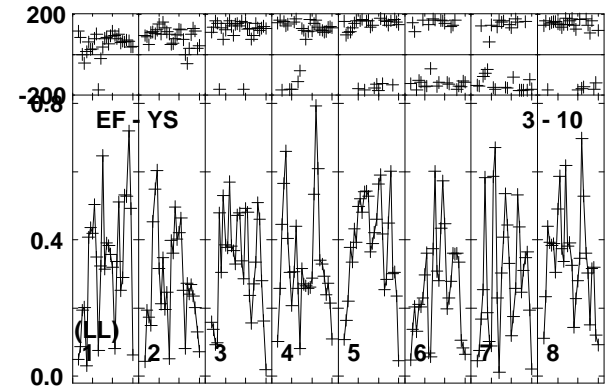
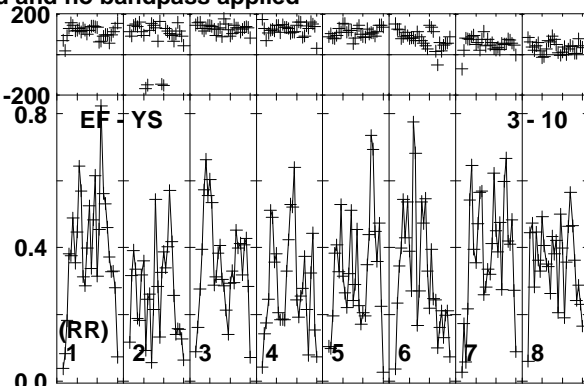
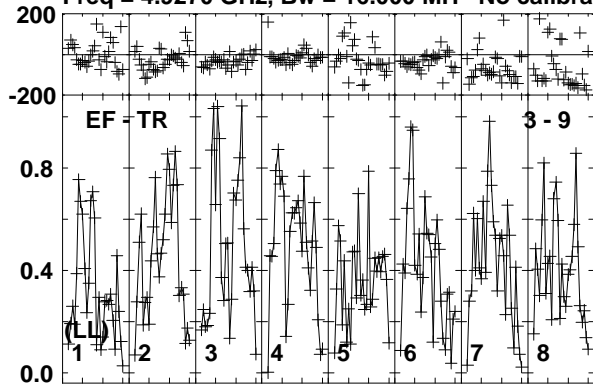

Lower frame: Milli Ampl Jy Top frame: Phas deg  
Vector averaged cross-power spectrum Baseline: EF (03) - TR (09)  
Timerange: 00/16:32:01 to 00/16:32:59

Plot file version 832 created 19-DEC-2018 17:59:07

VLA2 RY007C.UVDATA.1

Freq = 4.9270 GHz, Bw = 16.000 MH No calibration applied and no bandpass applied

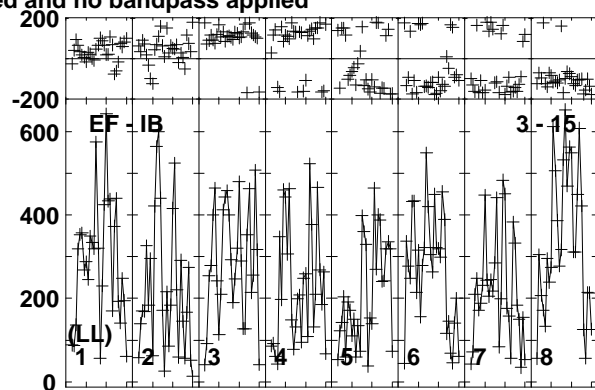
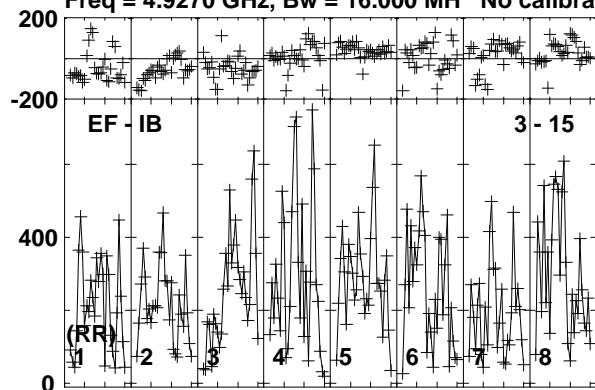

Lower frame: Micro Ampl Jy Top frame: Phas deg  
Vector averaged cross-power spectrum Baseline: EF (03) - IB (15)  
Timerange: 00/16:32:01 to 00/16:32:59

Plot file version 833 created 19-DEC-2018 17:59:07

J1619+2247 RY007C.UVDATA.1

Freq = 4.9270 GHz, Bw = 16.000 MH No calibration applied and no bandpass applied

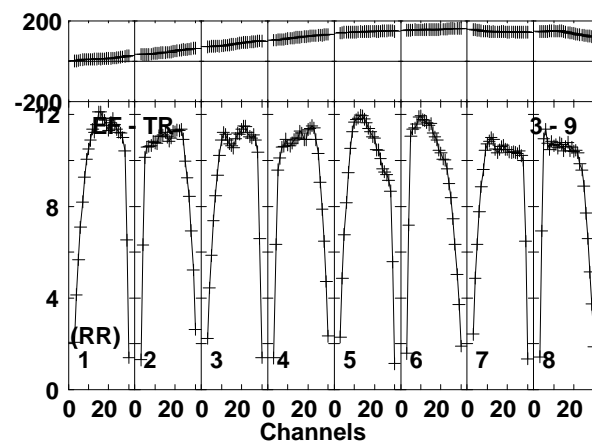
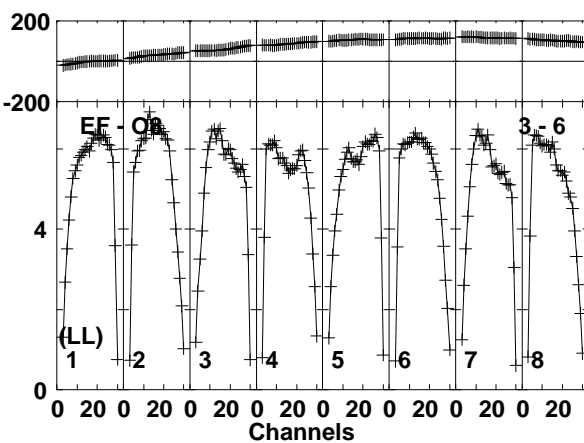
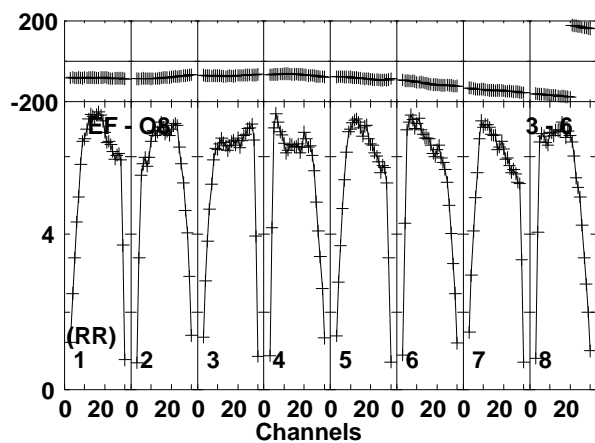
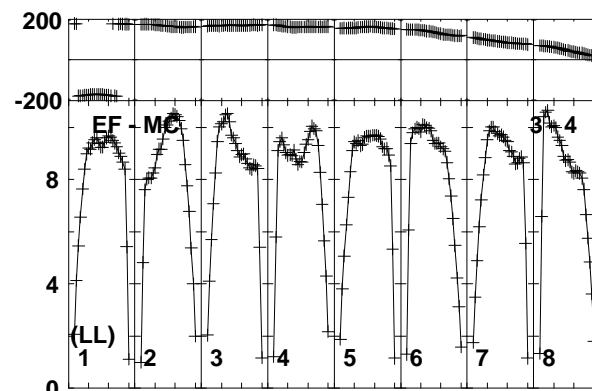
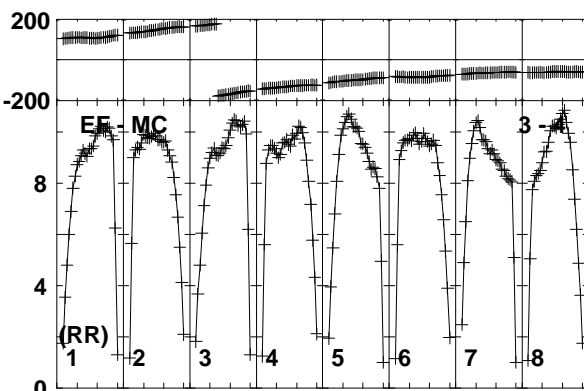
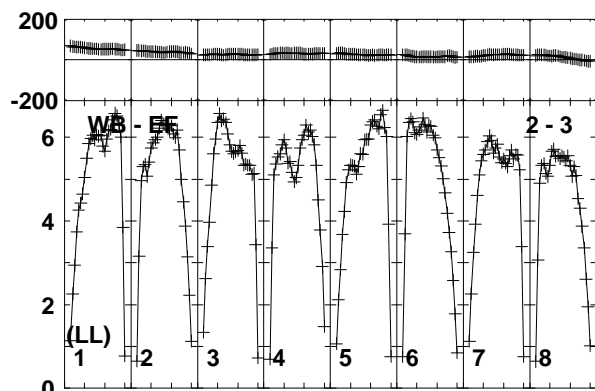
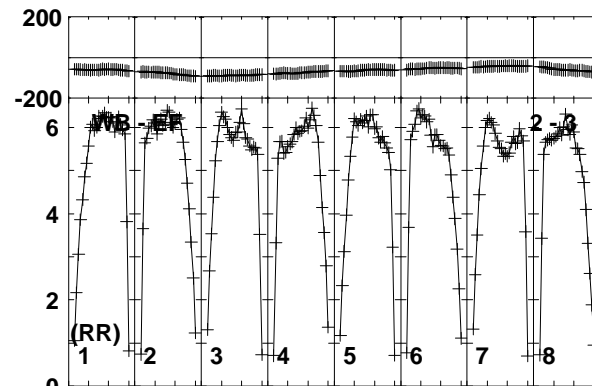
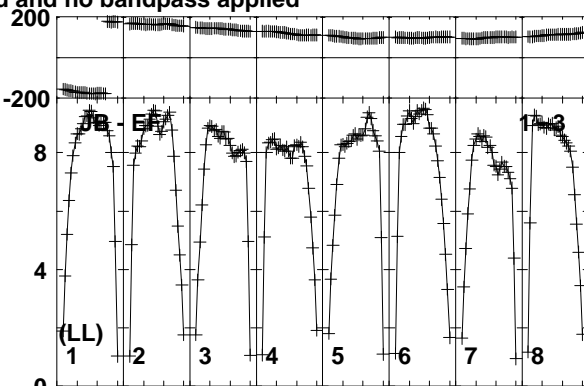
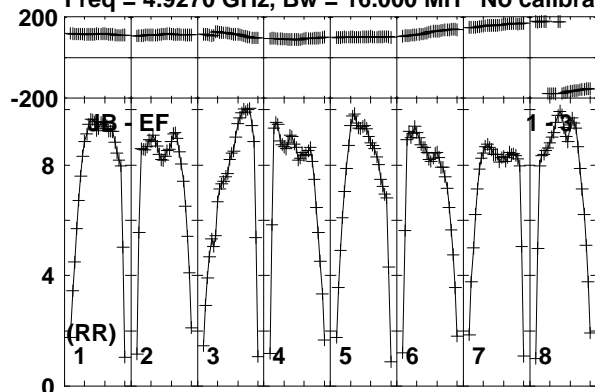

Lower frame: Milli Ampl Jy Top frame: Phas deg  
Vector averaged cross-power spectrum Baseline: JB (01) - EF (03)  
Timerange: 00/16:33:31 to 00/16:34:29

Plot file version 834 created 19-DEC-2018 17:59:07

J1619+2247 RY007C.UVDATA.1

Freq = 4.9270 GHz, Bw = 16.000 MH No calibration applied and no bandpass applied

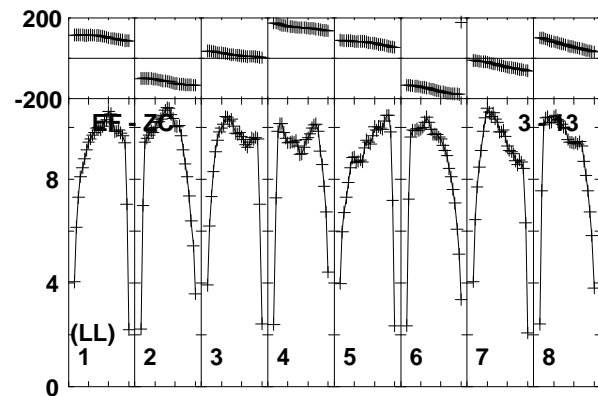
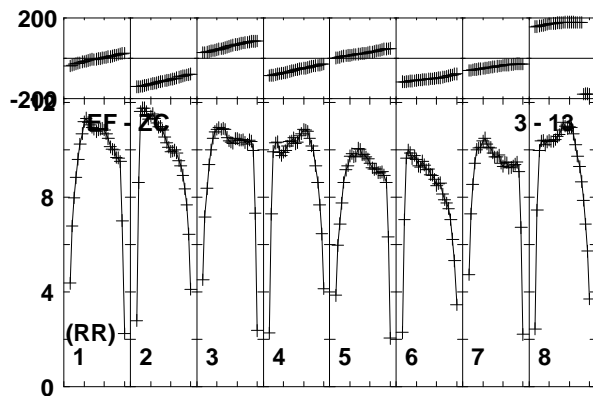
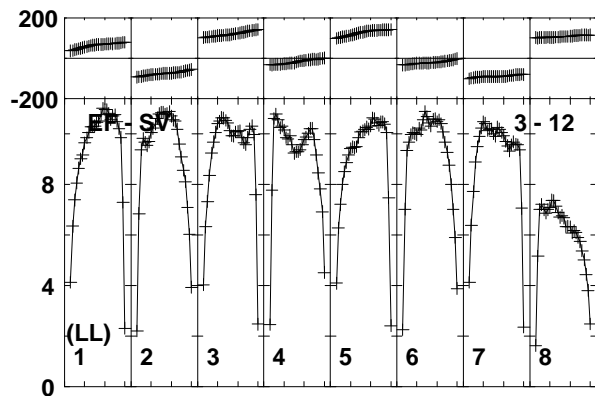
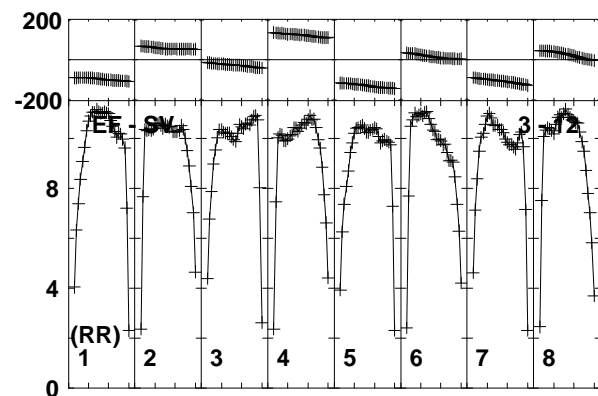
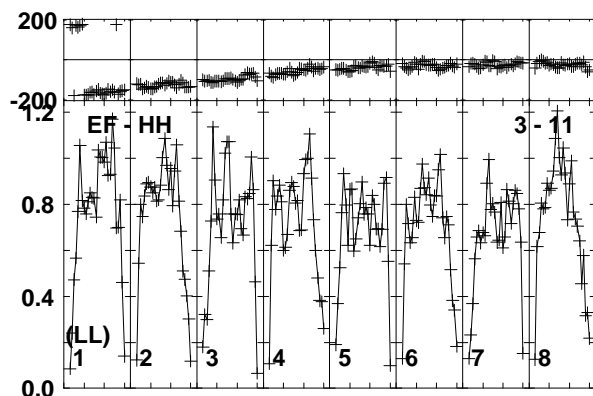
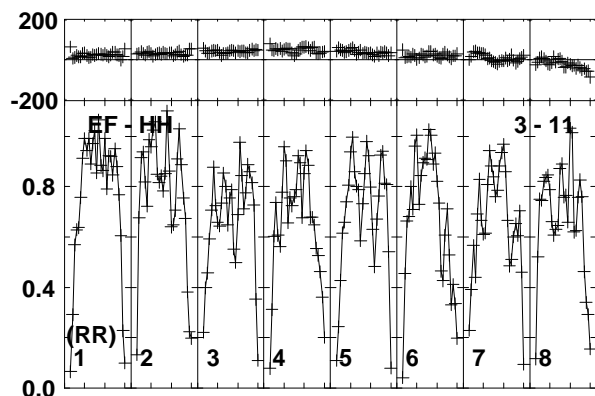
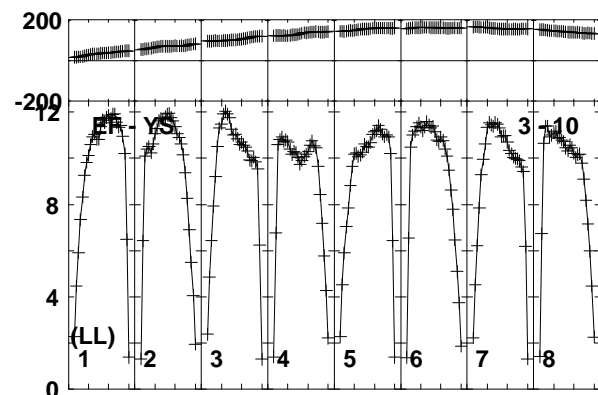
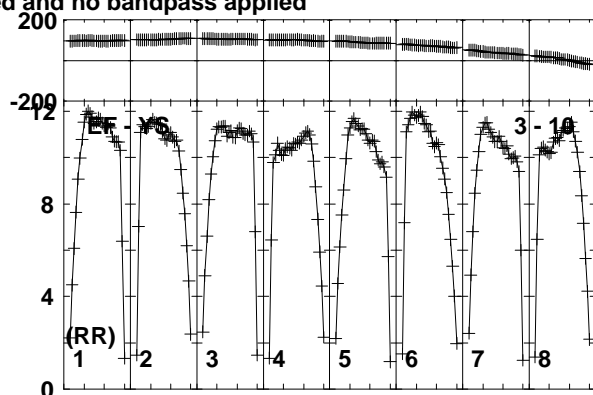
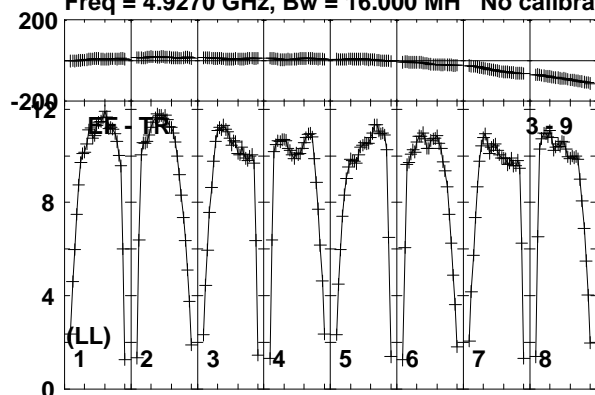

Lower frame: Milli Ampl Jy Top frame: Phas deg  
Vector averaged cross-power spectrum Baseline: EF (03) - TR (09)  
Timerange: 00/16:33:31 to 00/16:34:29



Plot file version 835 created 19-DEC-2018 17:59:07  
J1619+2247 RY007C.UVDATA.1

Freq = 4.9270 GHz, Bw = 16.000 MH No calibration applied and no bandpass applied

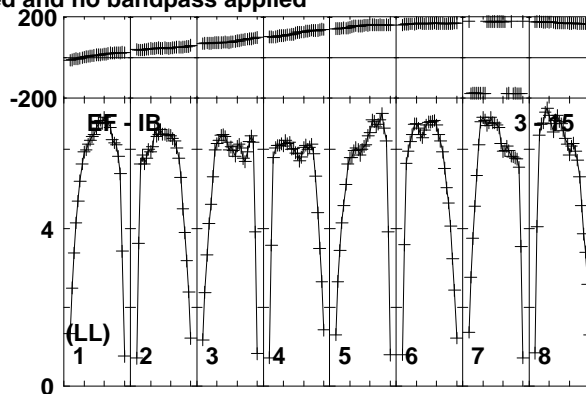
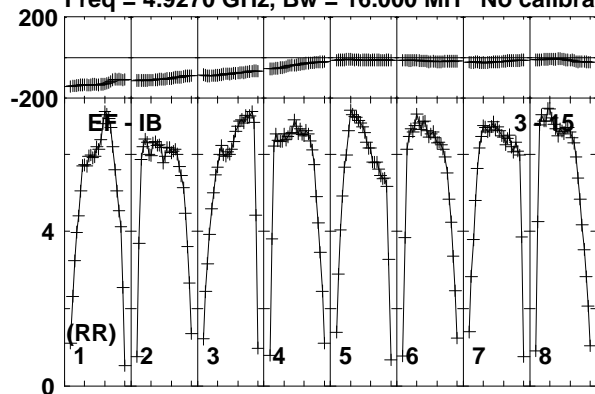

Lower frame: Milli Ampl Jy Top frame: Phas deg  
Vector averaged cross-power spectrum Baseline: EF (03) - IB (15)  
Timerange: 00/16:33:31 to 00/16:34:29

Plot file version 836 created 19-DEC-2018 17:59:07  
 AT2018\_RY007C.UVDATA.1

Freq = 4.9270 GHz, Bw = 16.000 MH No calibration applied and no bandpass applied

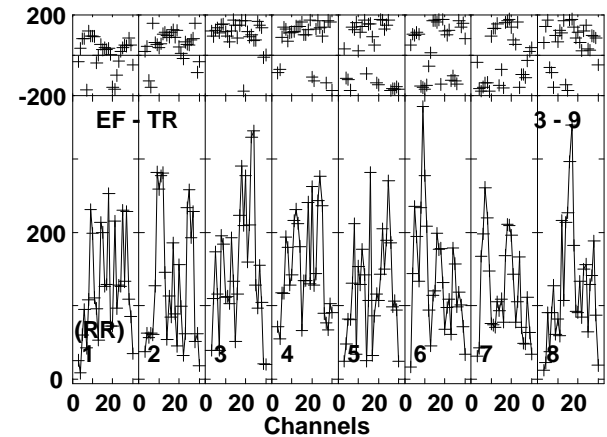
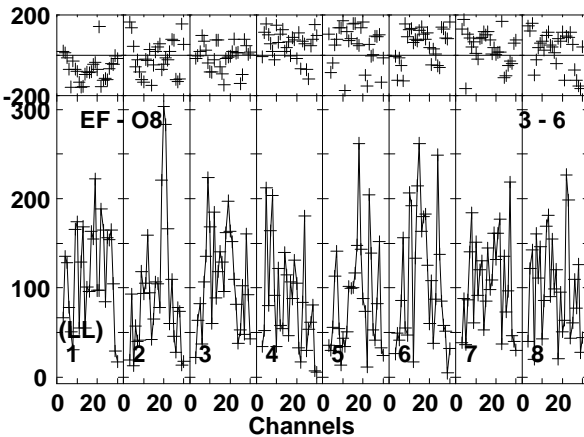
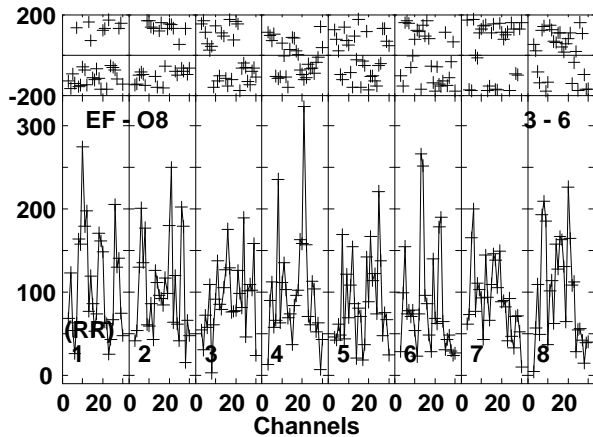
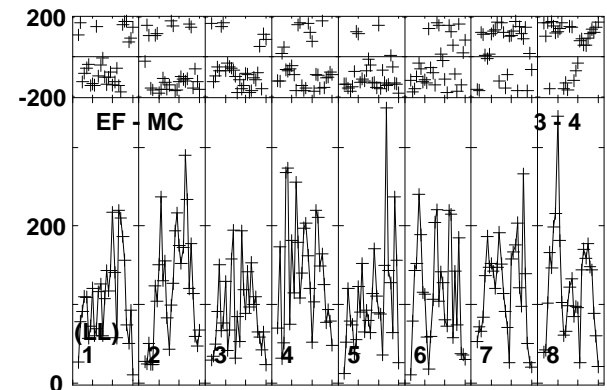
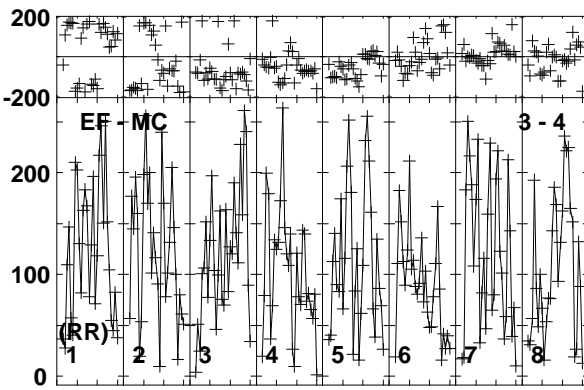
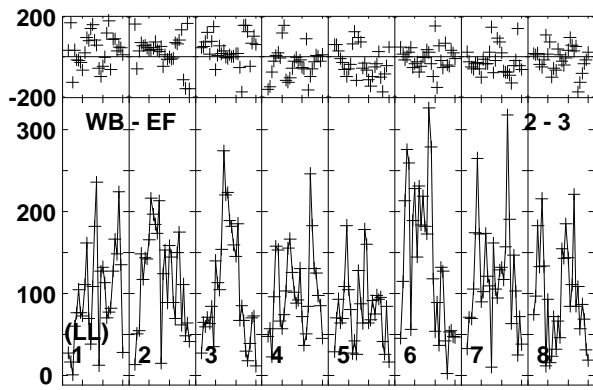
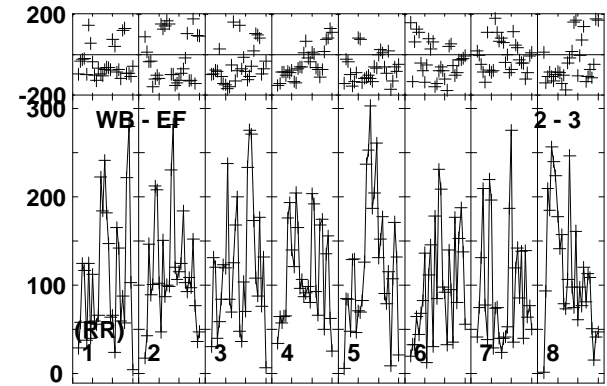
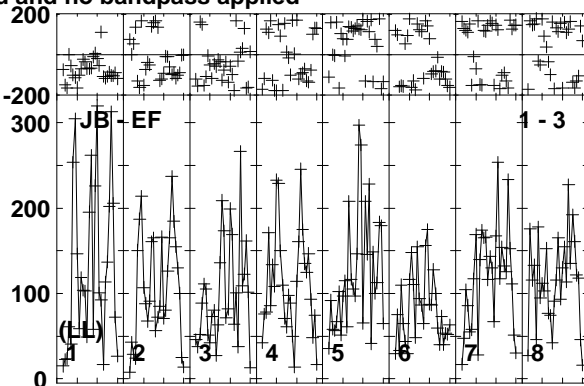
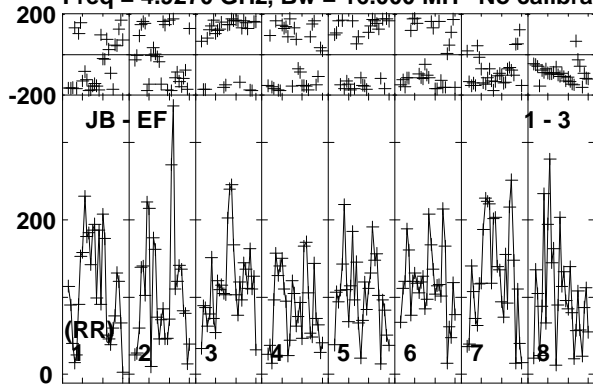

Lower frame: Micro Ampl Jy Top frame: Phas deg  
 Vector averaged cross-power spectrum Baseline: JB (01) - EF (03)  
 Timerange: 00/16:34:31 to 00/16:37:29

Plot file version 837 created 19-DEC-2018 17:59:07

AT2018\_RY007C.UVDATA.1

Freq = 4.9270 GHz, Bw = 16.000 MH No calibration applied and no bandpass applied

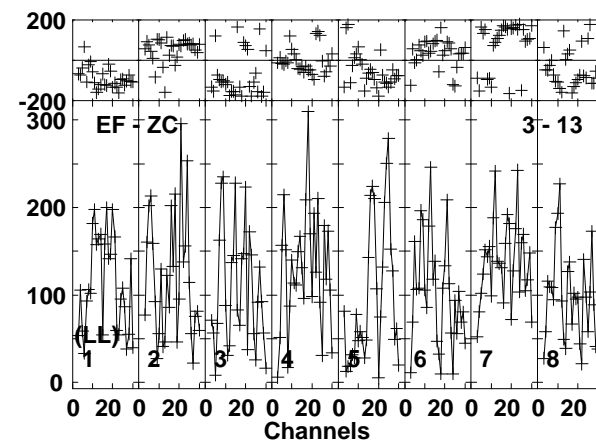
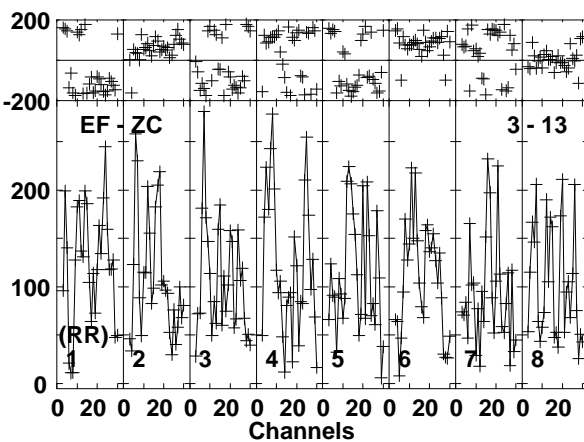
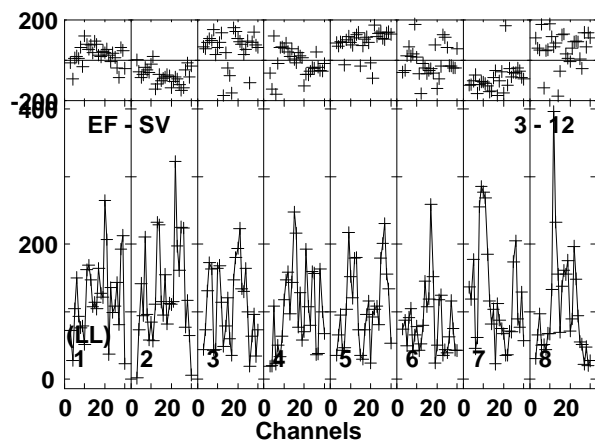
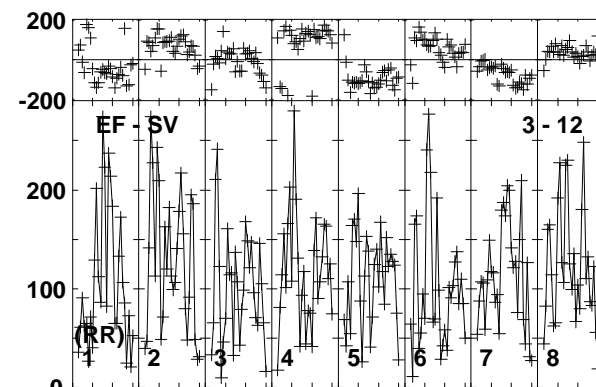
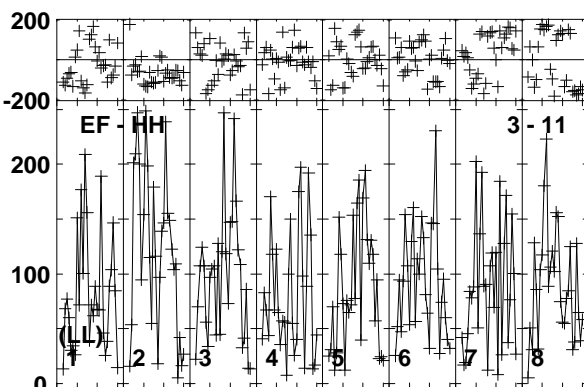
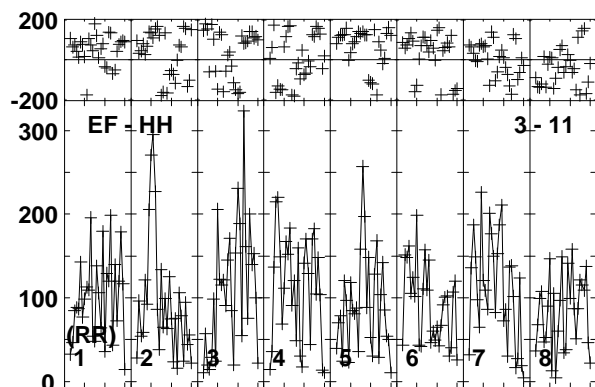
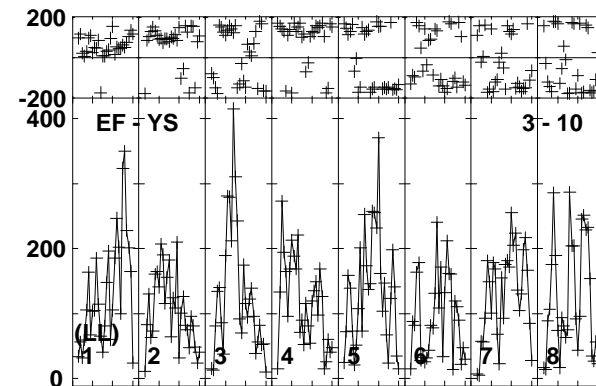
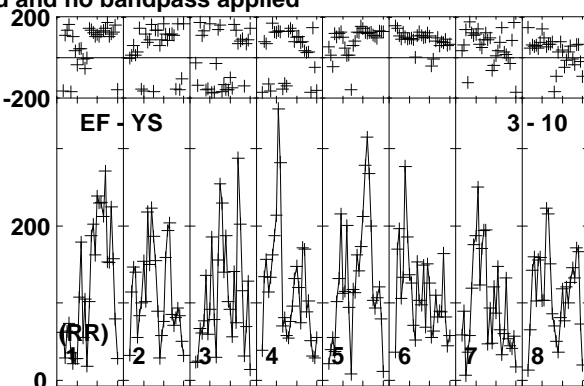
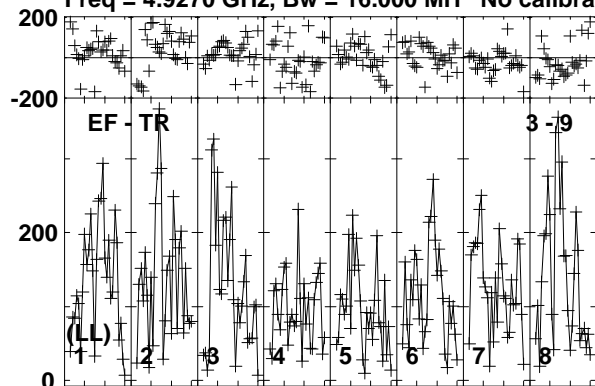

Lower frame: Micro Ampl Jy Top frame: Phas deg  
Vector averaged cross-power spectrum Baseline: EF (03) - TR (09)  
Timerange: 00/16:34:31 to 00/16:37:29

Plot file version 838 created 19-DEC-2018 17:59:07

AT2018\_RY007C.UVDATA.1

Freq = 4.9270 GHz, Bw = 16.000 MH No calibration applied and no bandpass applied

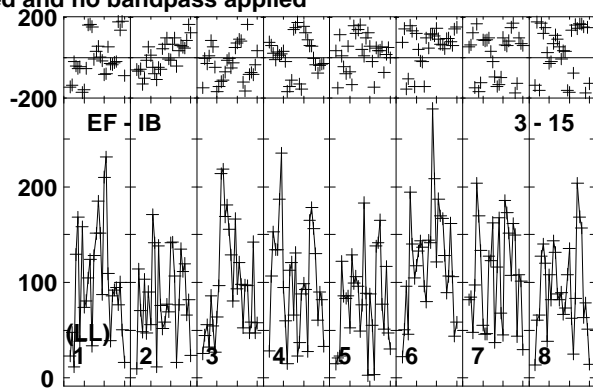
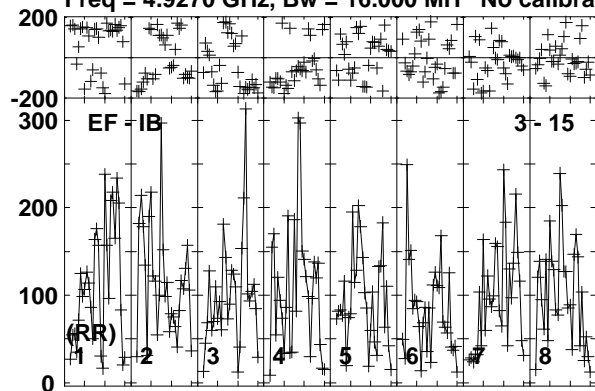

Lower frame: Micro Ampl Jy Top frame: Phas deg  
Vector averaged cross-power spectrum Baseline: EF (03) - IB (15)  
Timerange: 00/16:34:31 to 00/16:37:29

Plot file version 839 created 19-DEC-2018 17:59:07

J1619+2247 RY007C.UVDATA.1

Freq = 4.9270 GHz, Bw = 16.000 MH No calibration applied and no bandpass applied

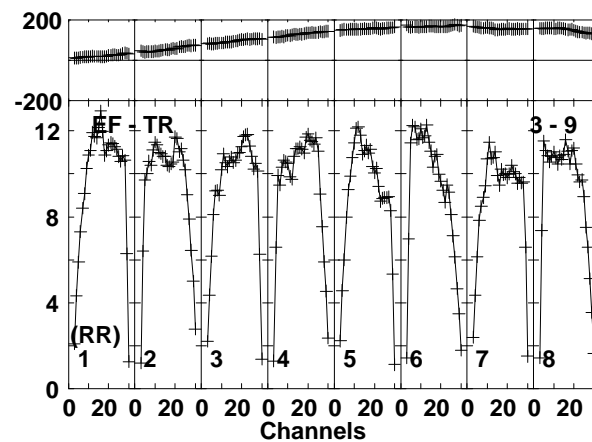
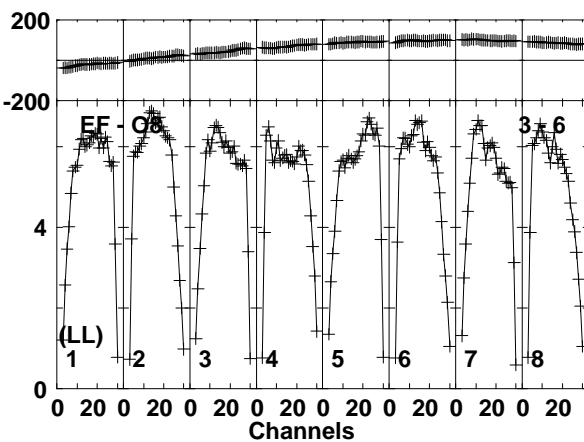
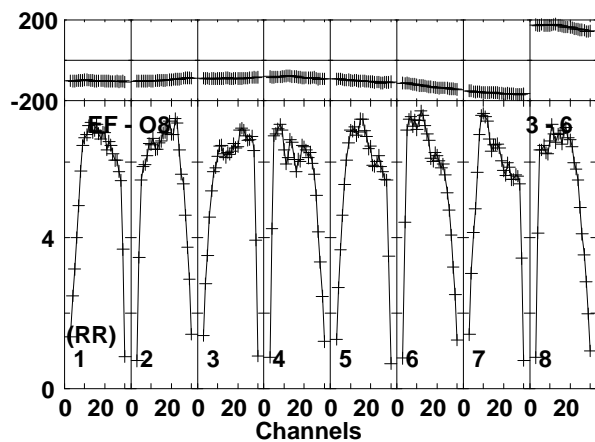
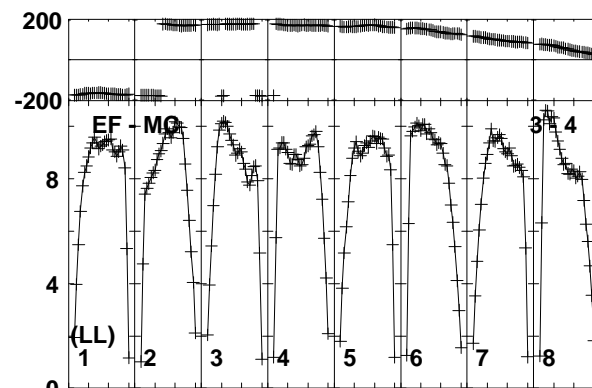
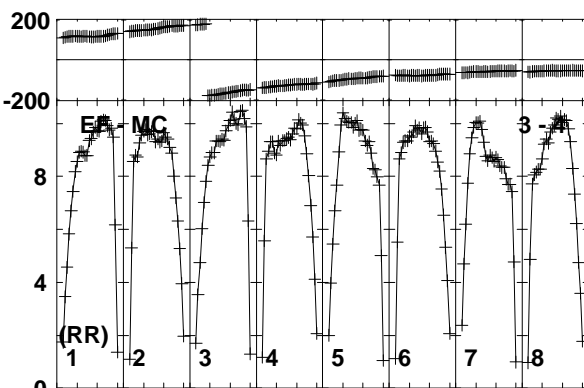
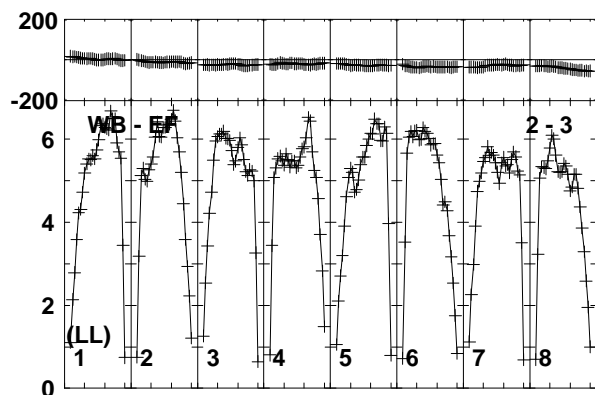
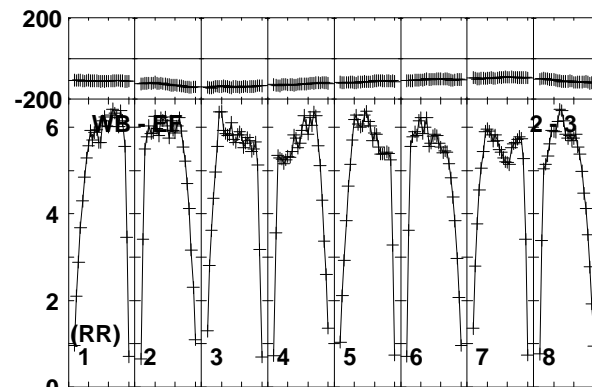
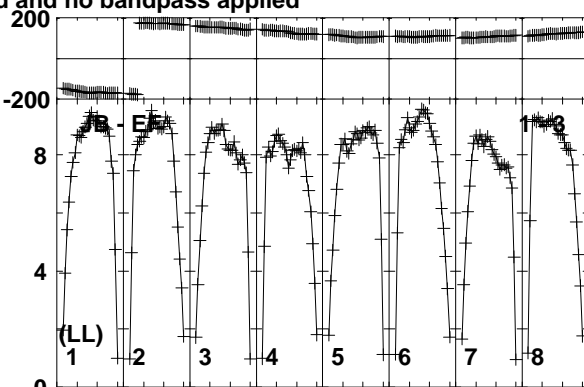
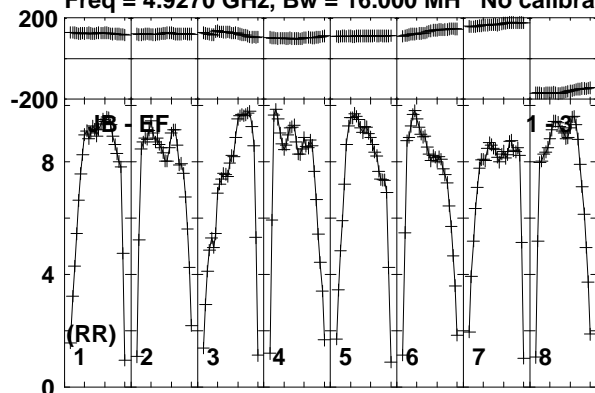

Lower frame: Milli Ampl Jy Top frame: Phas deg  
Vector averaged cross-power spectrum Baseline: JB (01) - EF (03)  
Timerange: 00/16:37:31 to 00/16:38:29

Plot file version 840 created 19-DEC-2018 17:59:07

J1619+2247 RY007C.UVDATA.1

Freq = 4.9270 GHz, Bw = 16.000 MH No calibration applied and no bandpass applied

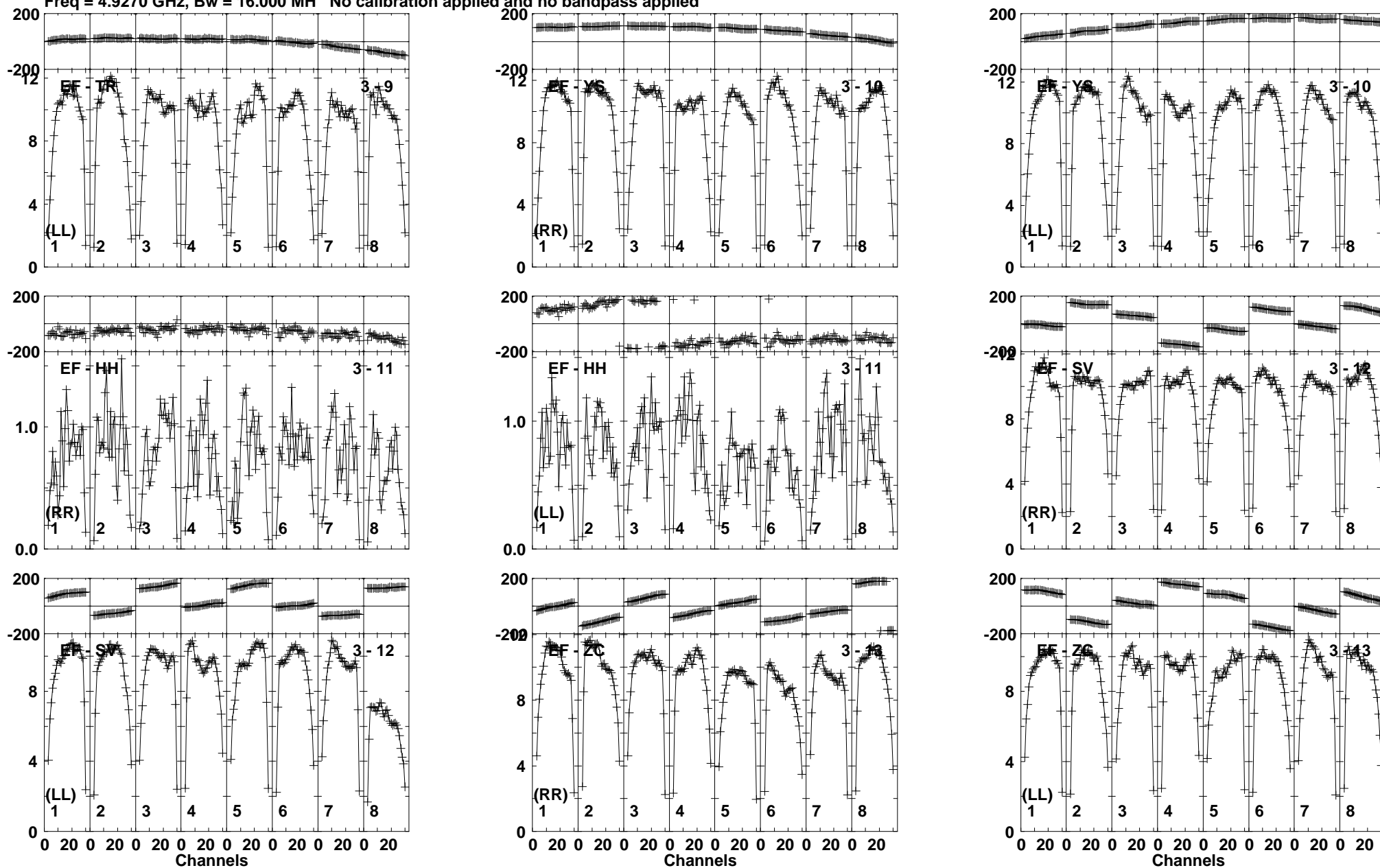

Lower frame: Milli Ampl Jy Top frame: Phas deg  
Vector averaged cross-power spectrum Baseline: EF (03) - TR (09)  
Timerange: 00/16:37:31 to 00/16:38:29

Plot file version 841 created 19-DEC-2018 17:59:07

J1619+2247 RY007C.UVDATA.1

Freq = 4.9270 GHz, Bw = 16.000 MH No calibration applied and no bandpass applied

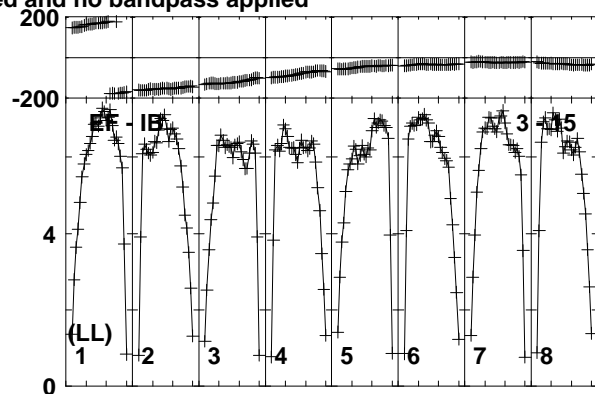
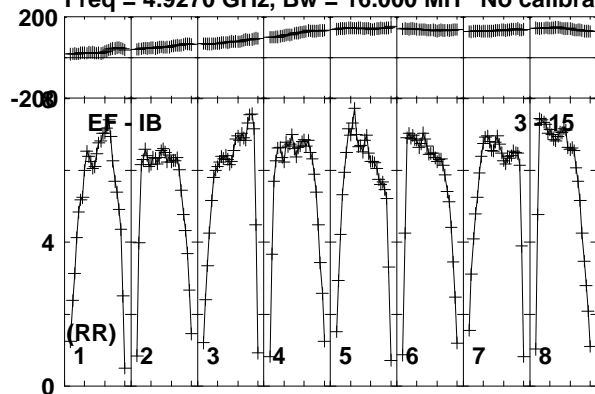

Lower frame: Milli Ampl Jy Top frame: Phas deg  
Vector averaged cross-power spectrum Baseline: EF (03) - IB (15)  
Timerange: 00/16:37:31 to 00/16:38:29

Plot file version 842 created 19-DEC-2018 17:59:07

AT2018\_RY007C.UVDATA.1

Freq = 4.9270 GHz, Bw = 16.000 MH No calibration applied and no bandpass applied

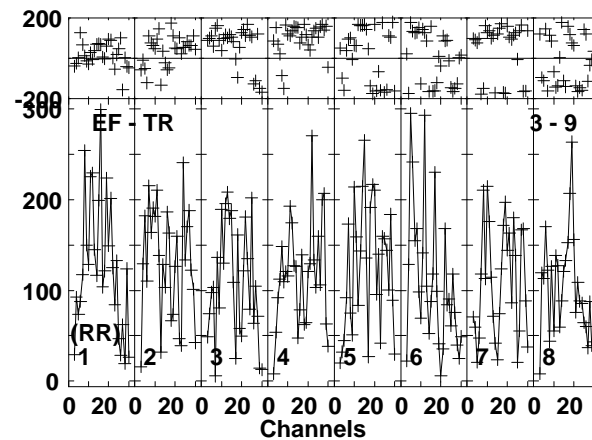
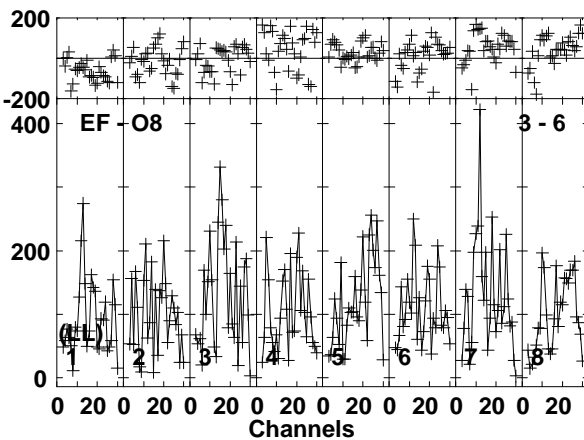
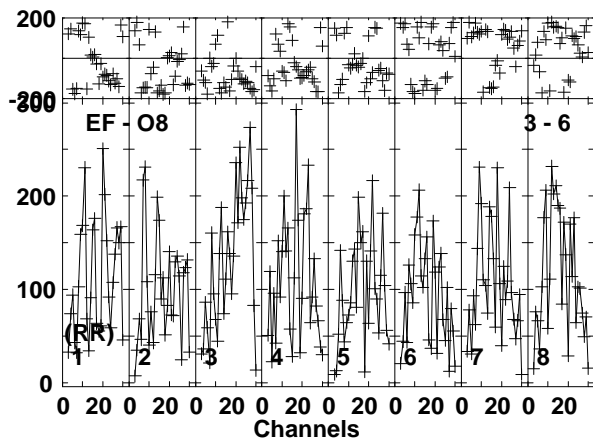
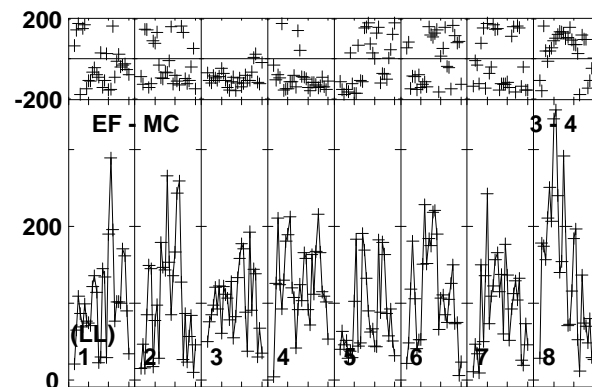
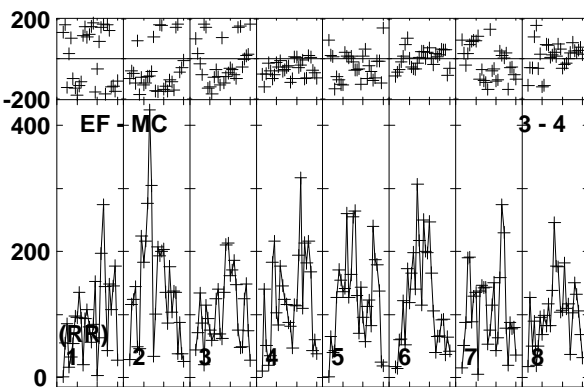
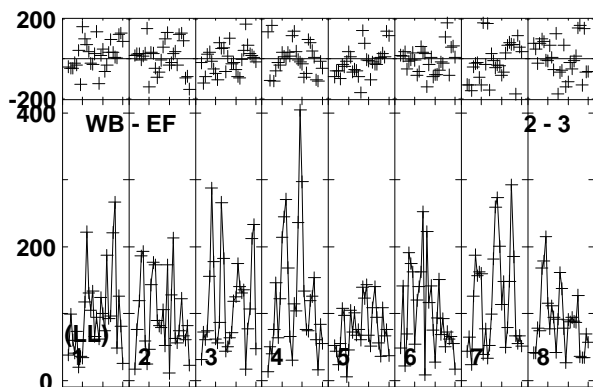
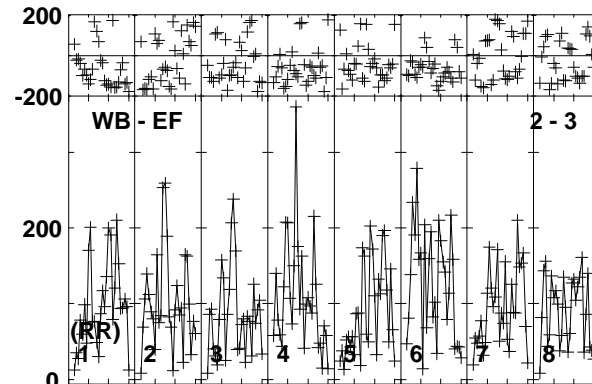
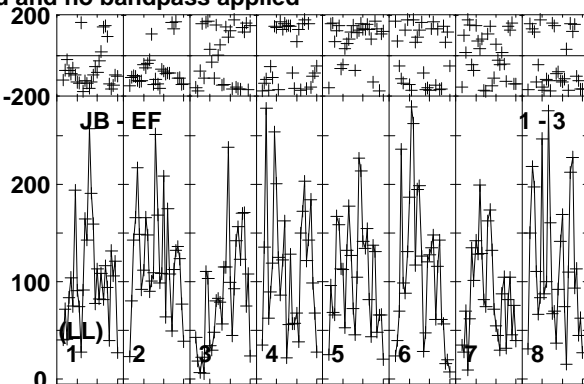
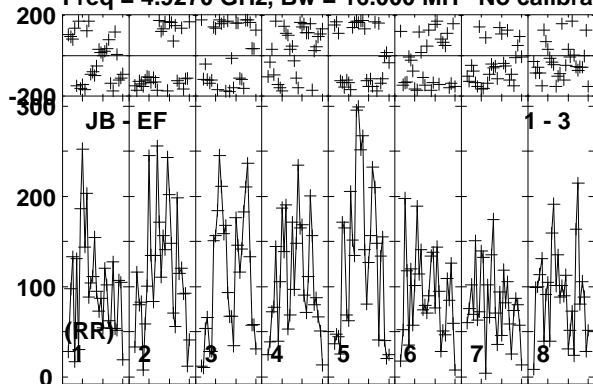

Lower frame: Micro Ampl Jy Top frame: Phas deg  
Vector averaged cross-power spectrum Baseline: JB (01) - EF (03)  
Timerange: 00/16:38:31 to 00/16:41:29



Plot file version 843 created 19-DEC-2018 17:59:08

AT2018\_RY007C.UVDATA.1

Freq = 4.9270 GHz, Bw = 16.000 MH No calibration applied and no bandpass applied

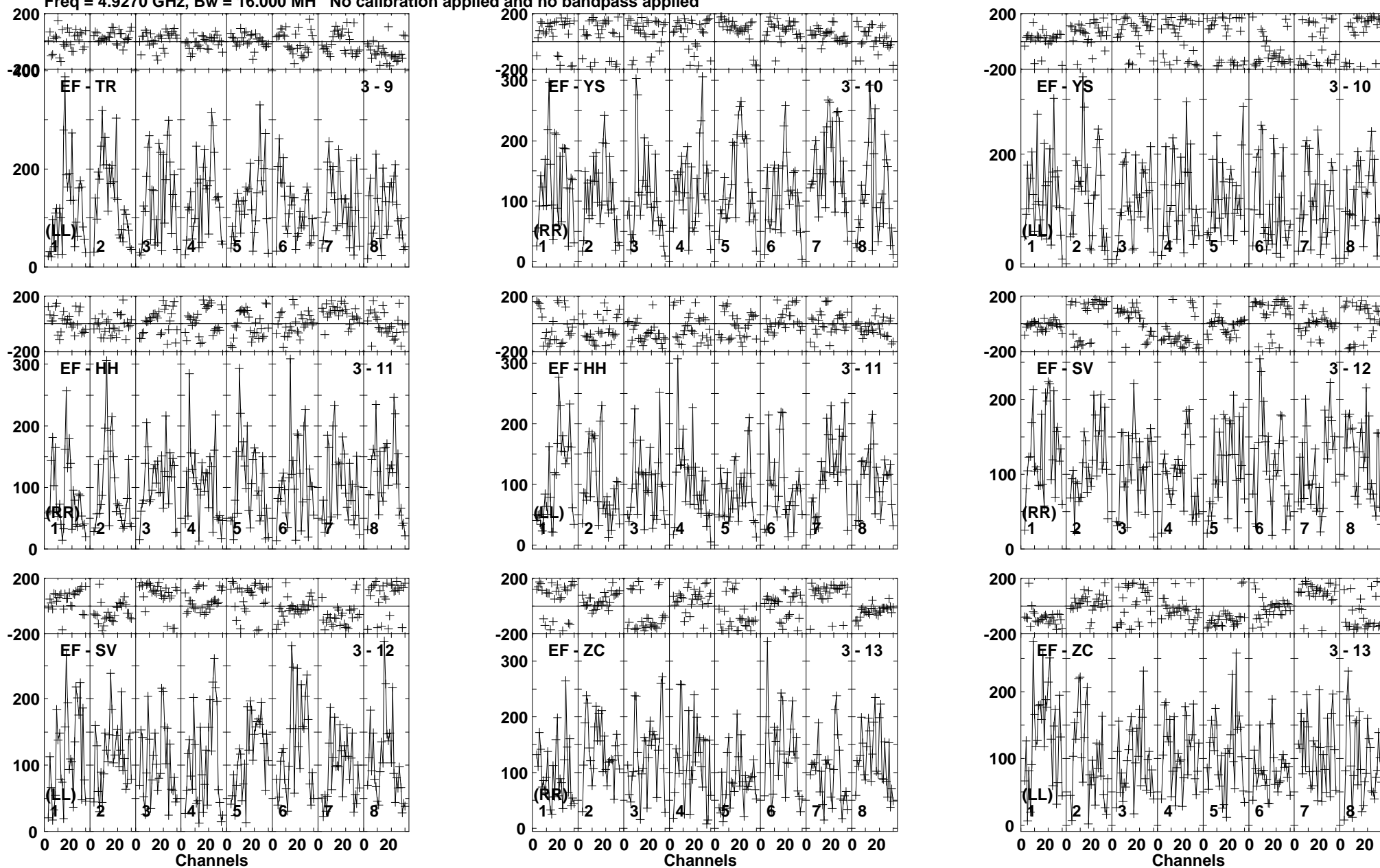

Lower frame: Micro Ampl Jy Top frame: Phas deg  
Vector averaged cross-power spectrum Baseline: EF (03) - TR (09)  
Timerange: 00/16:38:31 to 00/16:41:29

Plot file version 844 created 19-DEC-2018 17:59:08

AT2018\_RY007C.UVDATA.1

Freq = 4.9270 GHz, Bw = 16.000 MH No calibration applied and no bandpass applied

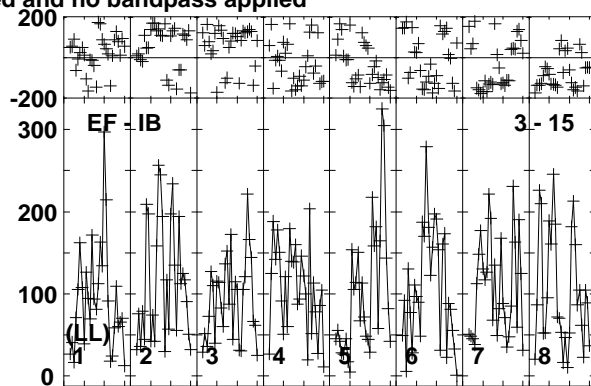
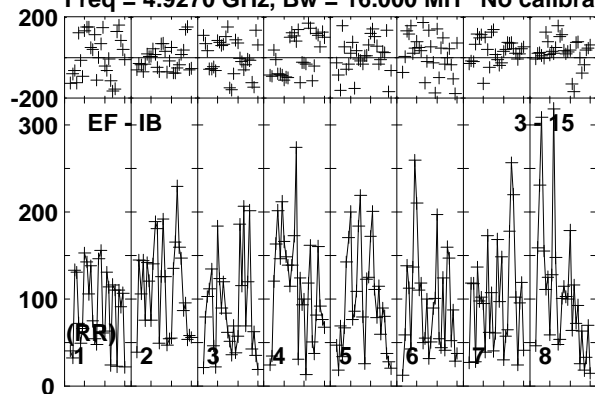

Lower frame: Micro Ampl Jy Top frame: Phas deg  
Vector averaged cross-power spectrum Baseline: EF (03) - IB (15)  
Timerange: 00/16:38:31 to 00/16:41:29

Plot file version 845 created 19-DEC-2018 17:59:08

J1619+2247 RY007C.UVDATA.1

Freq = 4.9270 GHz, Bw = 16.000 MH No calibration applied and no bandpass applied

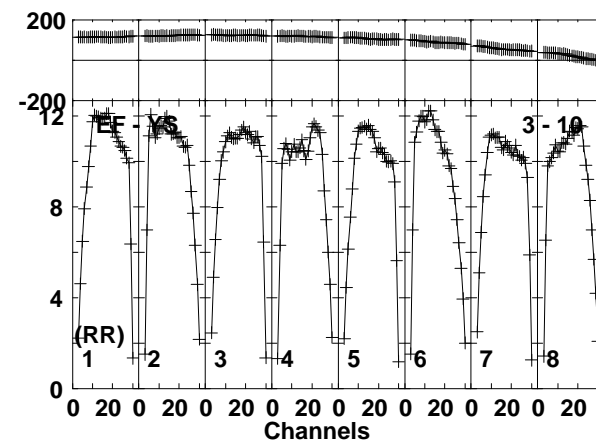
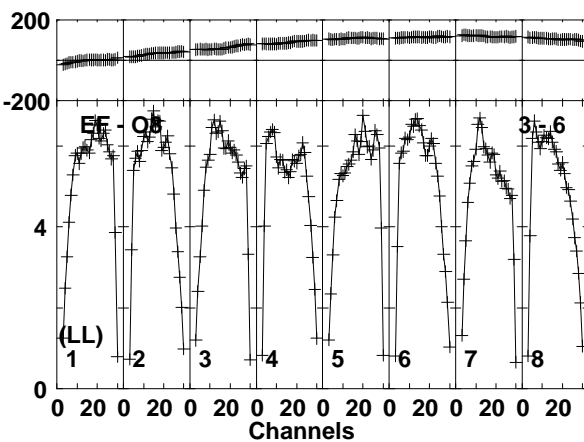
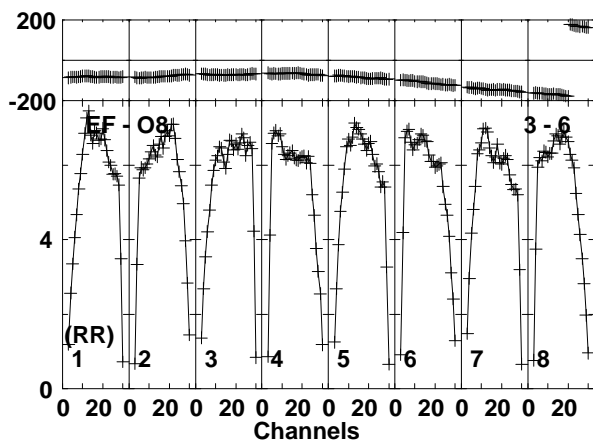
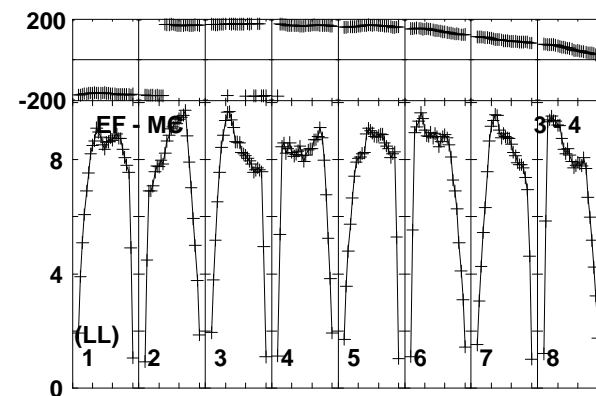
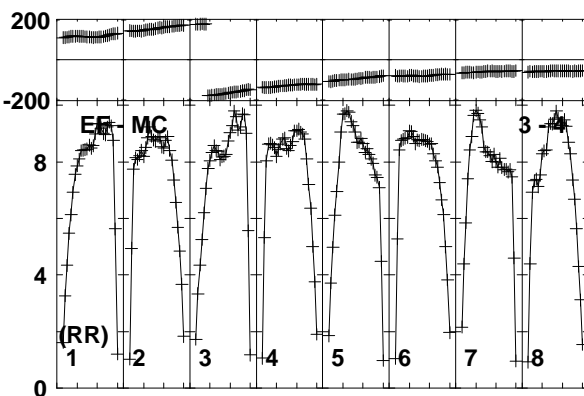
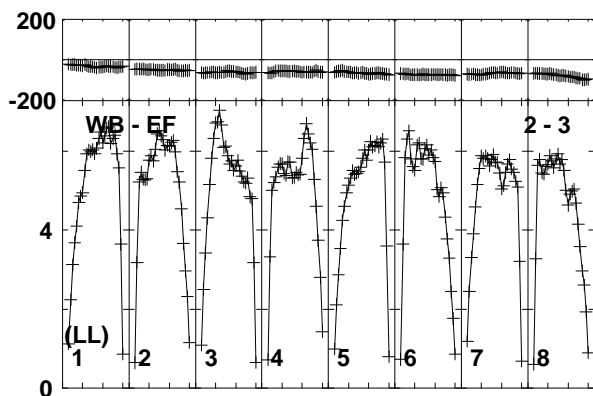
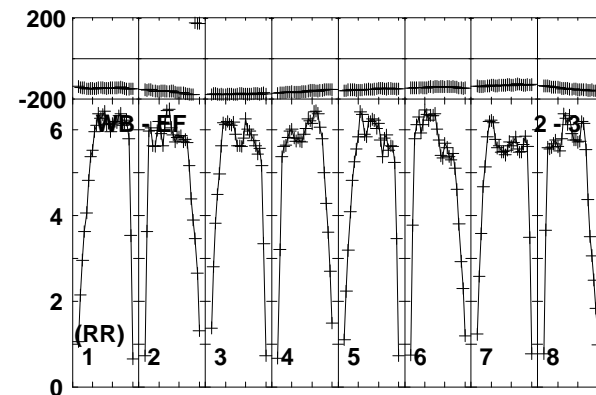
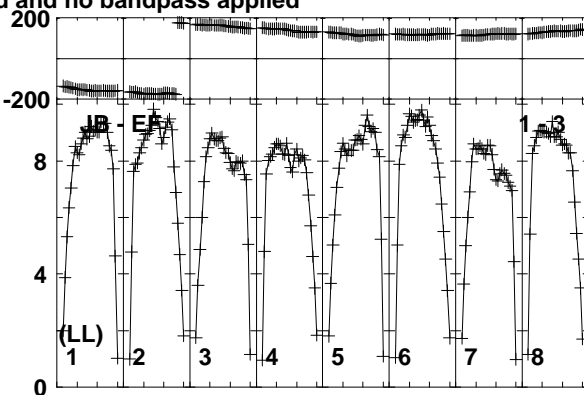
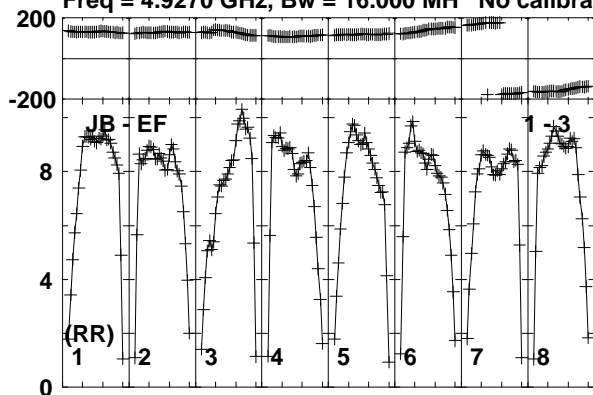

Lower frame: Milli Ampl Jy Top frame: Phas deg  
Vector averaged cross-power spectrum Baseline: JB (01) - EF (03)  
Timerange: 00:16:41:31 to 00:16:42:29

Plot file version 846 created 19-DEC-2018 17:59:08

J1619+2247 RY007C.UVDATA.1

Freq = 4.9270 GHz, Bw = 16.000 MH No calibration applied and no bandpass applied

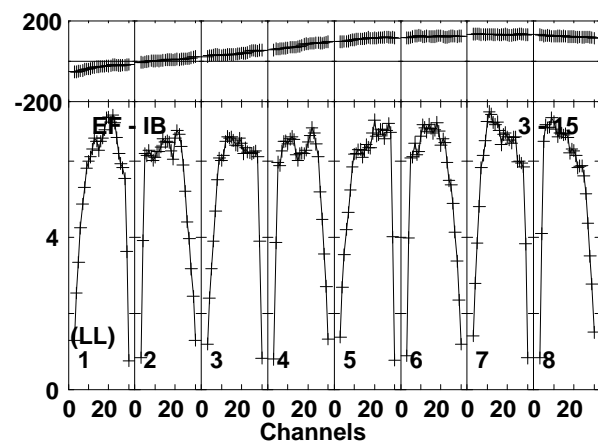
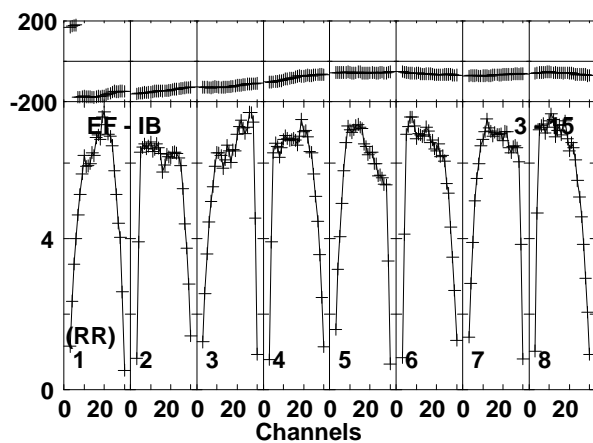
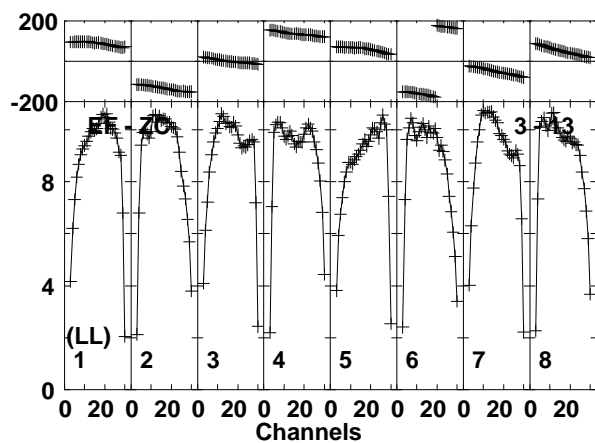
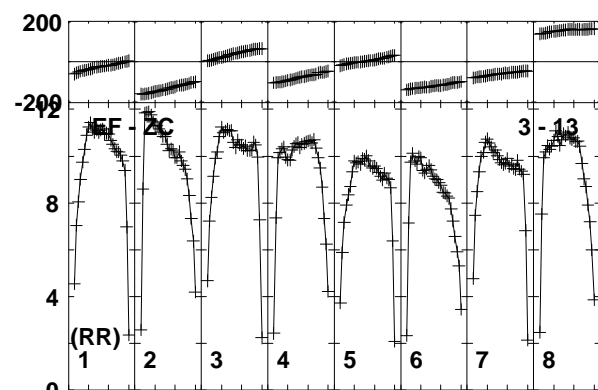
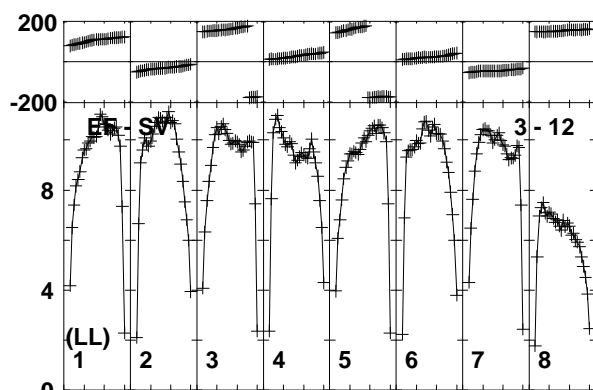
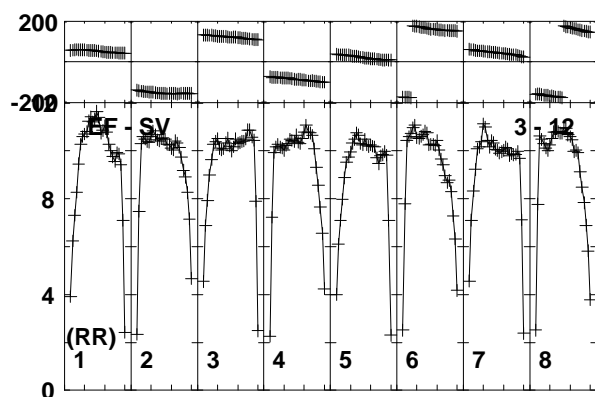
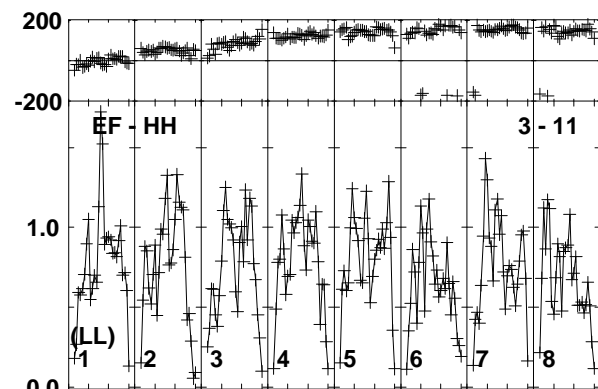
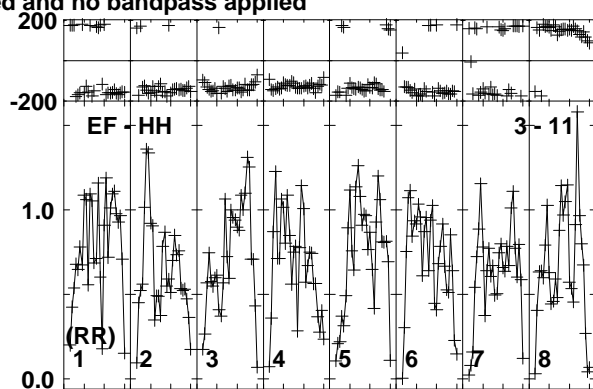
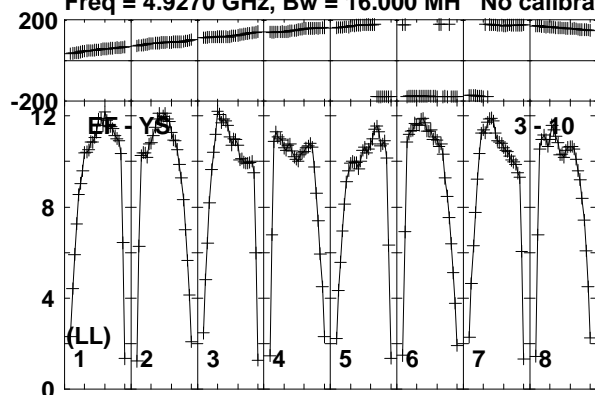

Lower frame: Milli Ampl Jy Top frame: Phas deg  
Vector averaged cross-power spectrum Baseline: EF (03) - YS (10)  
Timerange: 00/16:41:31 to 00/16:42:29

Plot file version 847 created 19-DEC-2018 17:59:08

VLA1 RY007C.UVDATA.1

Freq = 4.9270 GHz, Bw = 16.000 MH No calibration applied and no bandpass applied

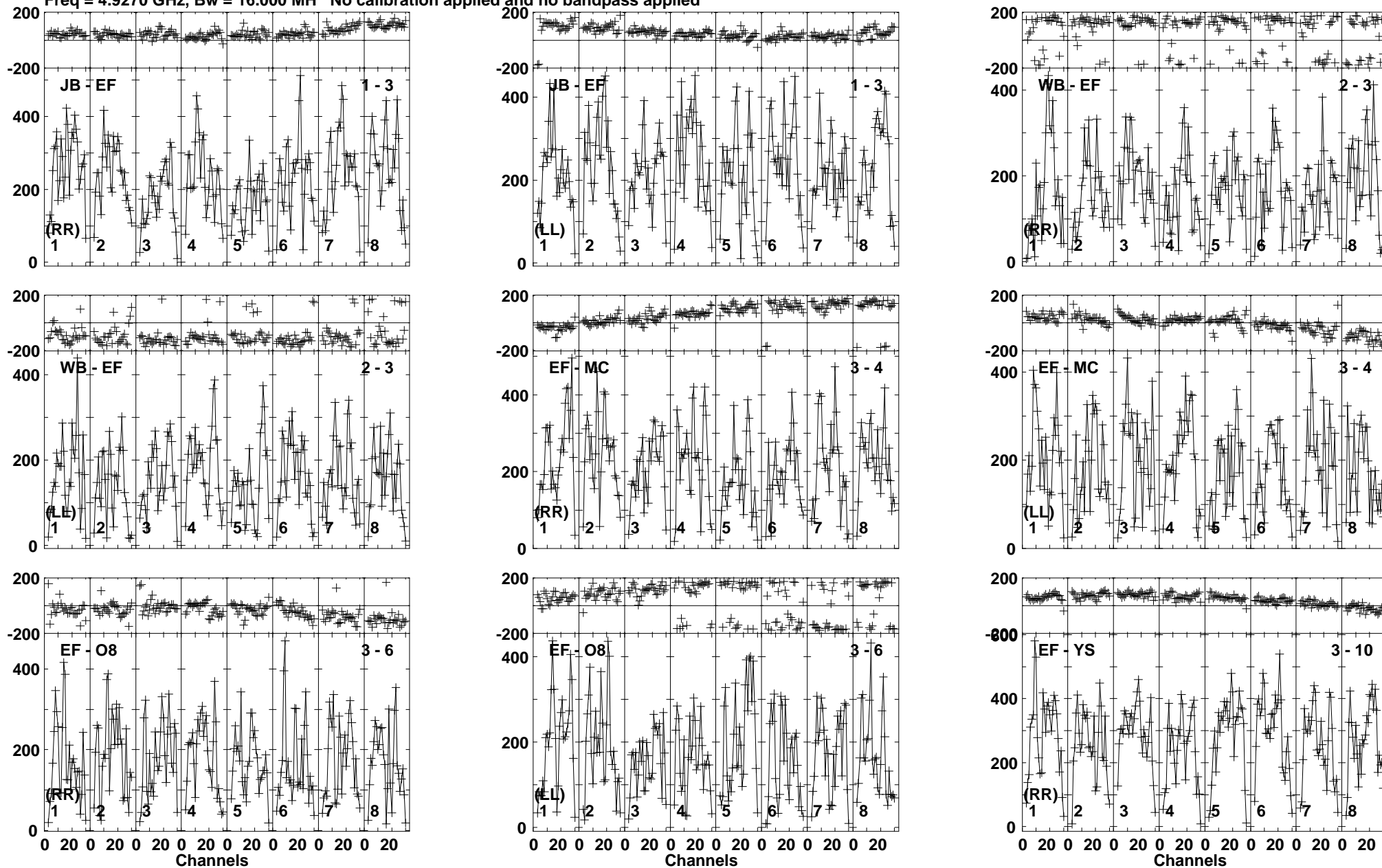

Lower frame: Micro Ampl Jy Top frame: Phas deg  
Vector averaged cross-power spectrum Baseline: JB (01) - EF (03)  
Timerange: 00/16:43:01 to 00/16:44:59

Plot file version 848 created 19-DEC-2018 17:59:08

VLA1 RY007C.UVDATA.1

Freq = 4.9270 GHz, Bw = 16.000 MH No calibration applied and no bandpass applied

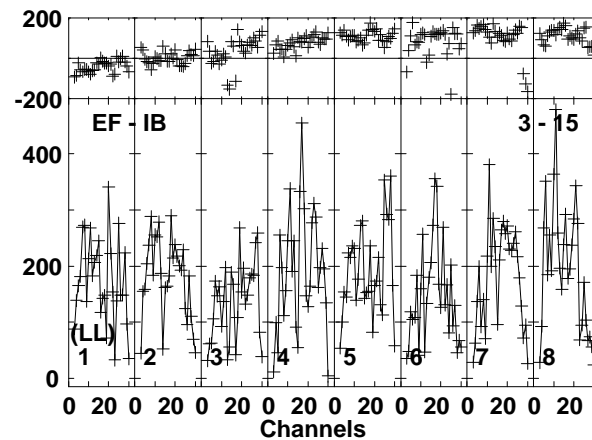
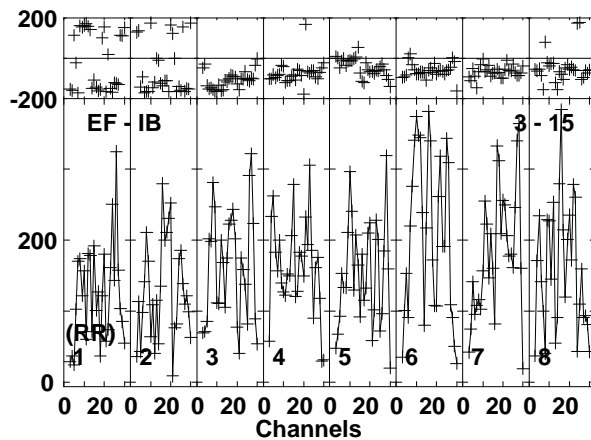
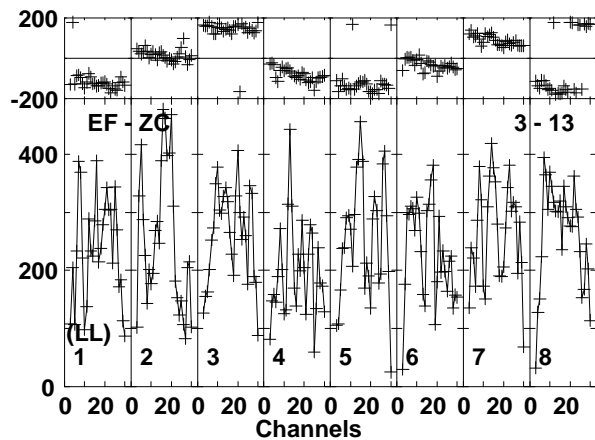
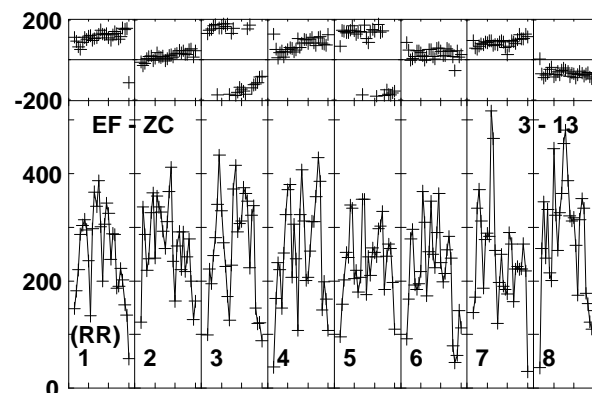
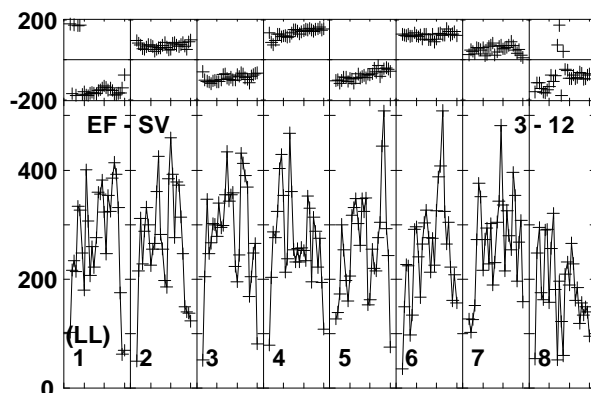
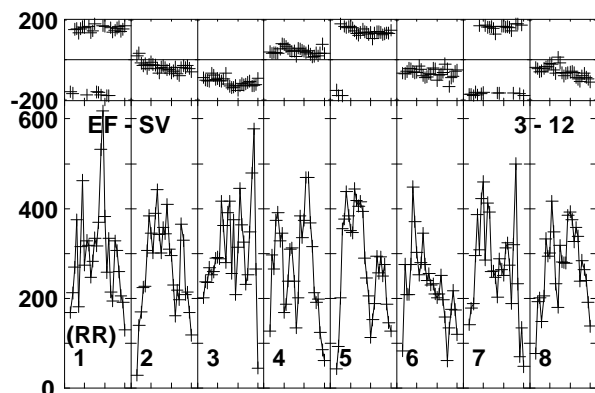
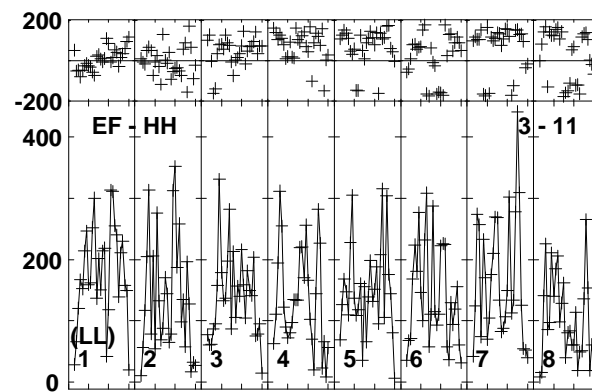
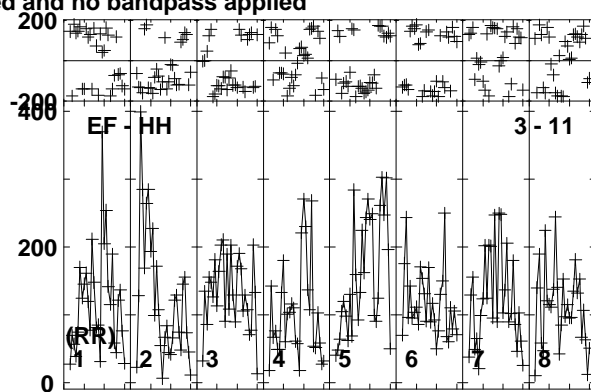
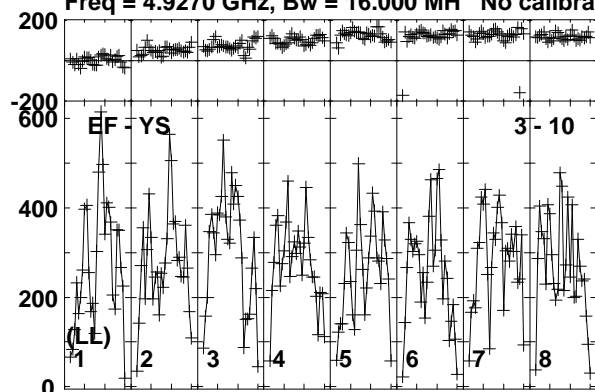

Lower frame: Micro Ampl Jy Top frame: Phas deg  
Vector averaged cross-power spectrum Baseline: EF (03) - YS (10)  
Timerange: 00/16:43:01 to 00/16:44:59

Plot file version 849 created 19-DEC-2018 17:59:08

J1619+2247 RY007C.UVDATA.1

Freq = 4.9270 GHz, Bw = 16.000 MH No calibration applied and no bandpass applied

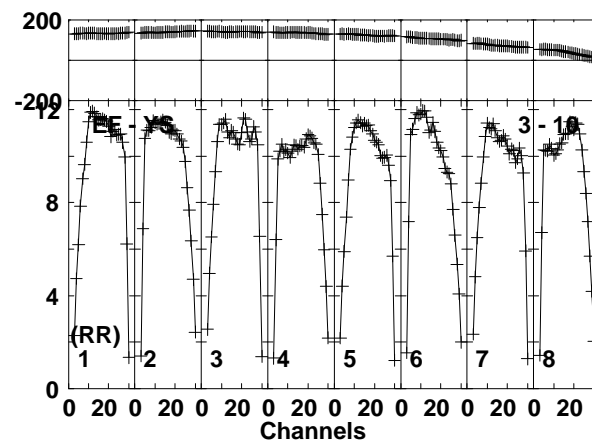
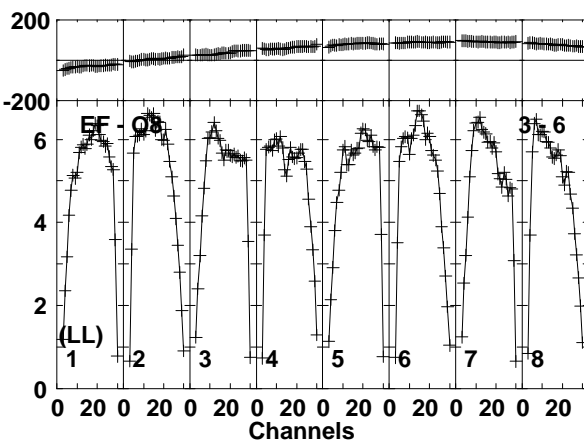
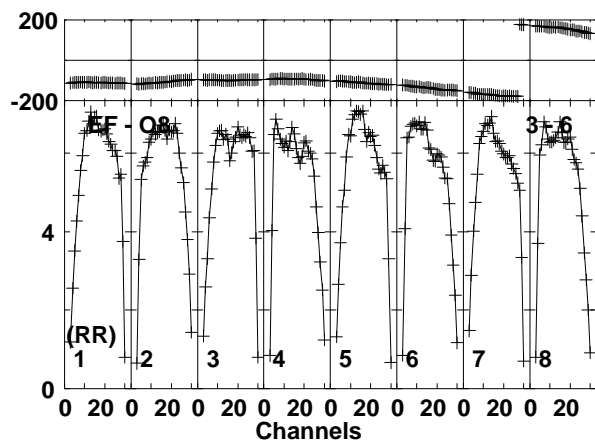
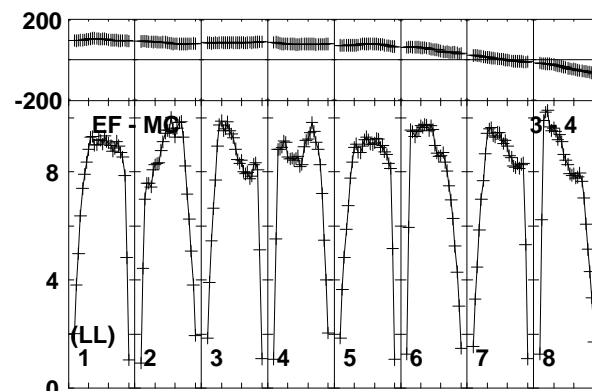
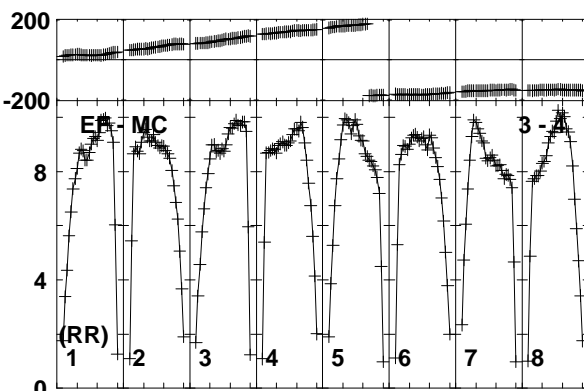
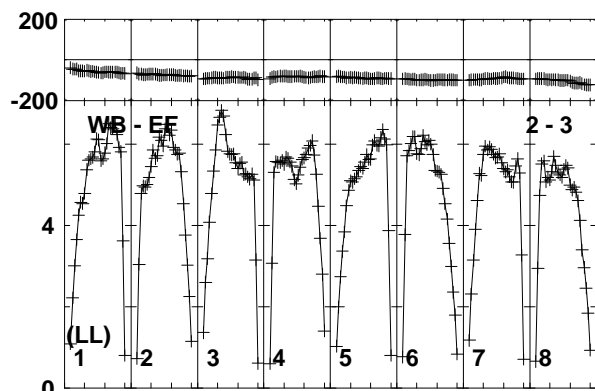
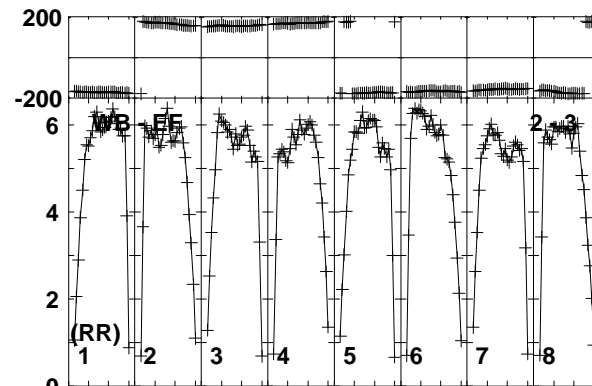
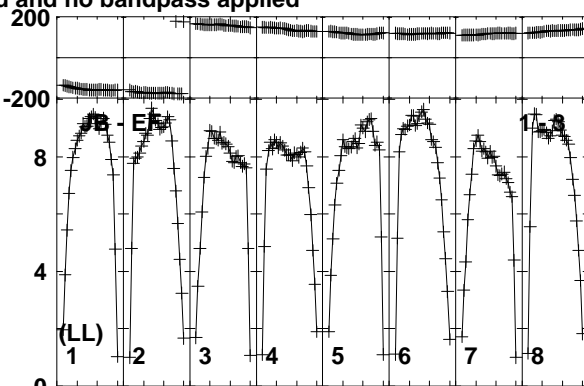
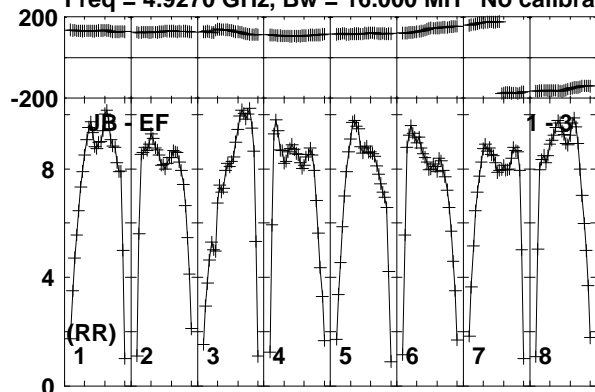

Lower frame: Milli Ampl Jy Top frame: Phas deg  
Vector averaged cross-power spectrum Baseline: JB (01) - EF (03)  
Timerange: 00/16:45:01 to 00/16:45:59

Plot file version 850 created 19-DEC-2018 17:59:08

J1619+2247 RY007C.UVDATA.1

Freq = 4.9270 GHz, Bw = 16.000 MH No calibration applied and no bandpass applied

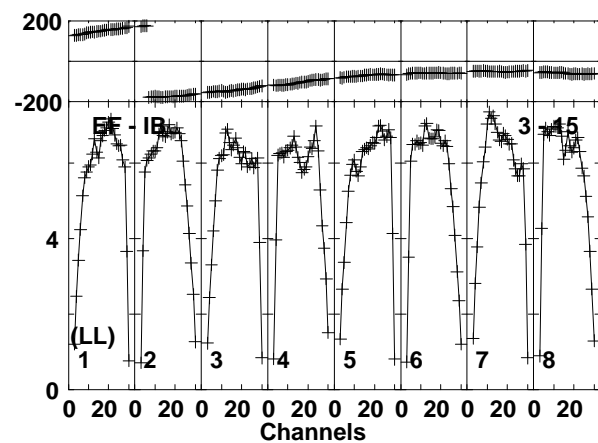
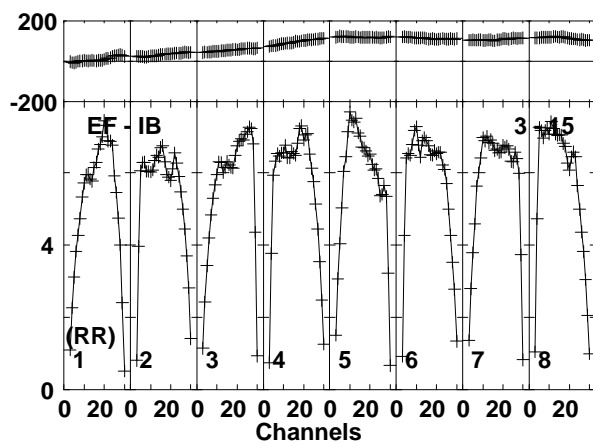
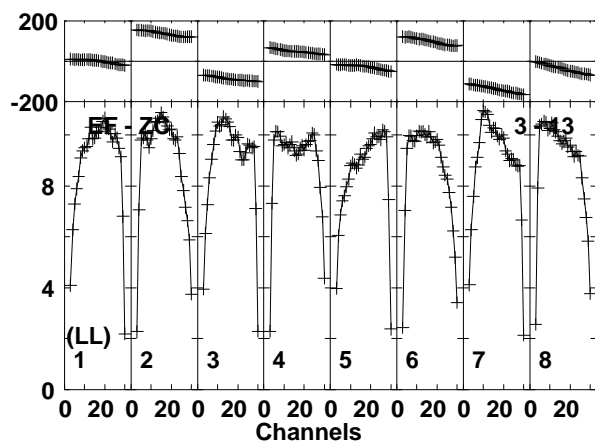
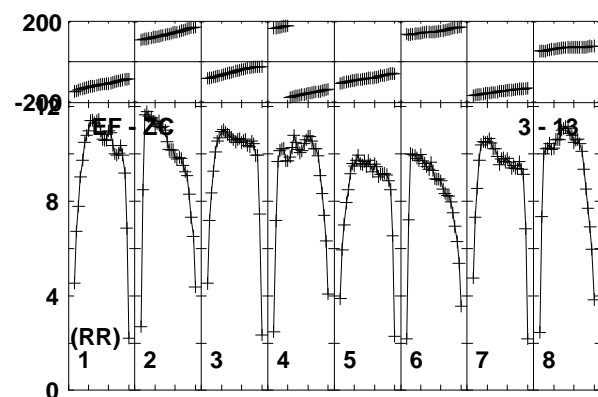
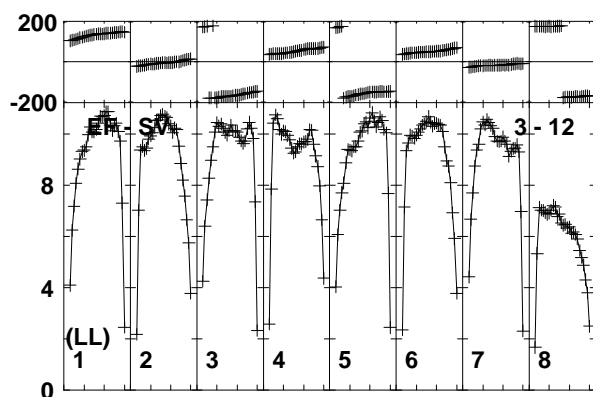
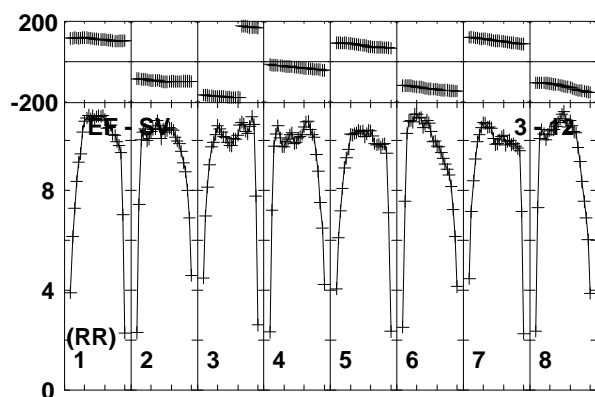
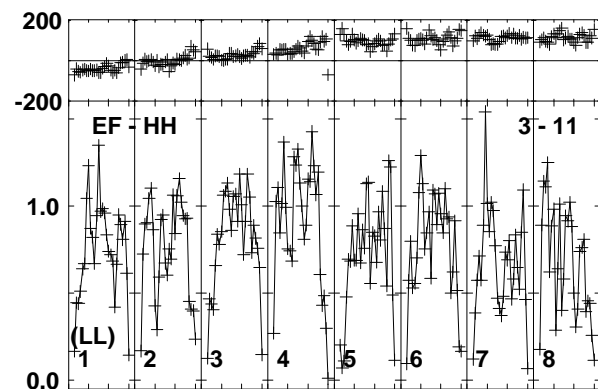
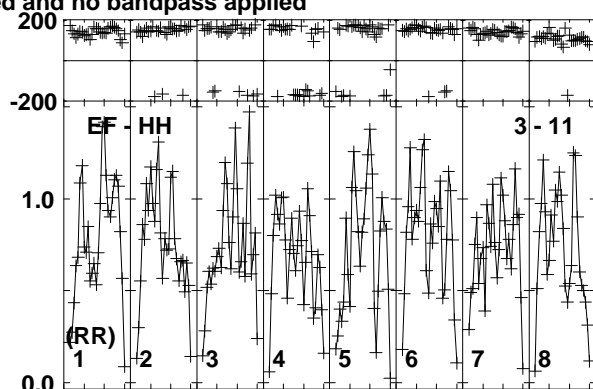
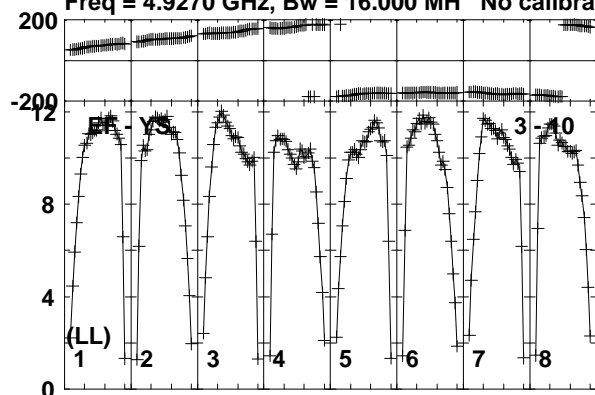

Lower frame: Milli Ampl Jy Top frame: Phas deg  
Vector averaged cross-power spectrum Baseline: EF (03) - YS (10)  
Timerange: 00/16:45:01 to 00/16:45:59



Plot file version 851 created 19-DEC-2018 17:59:08

AT2018\_RY007C.UVDATA.1

Freq = 4.9270 GHz, Bw = 16.000 MH No calibration applied and no bandpass applied

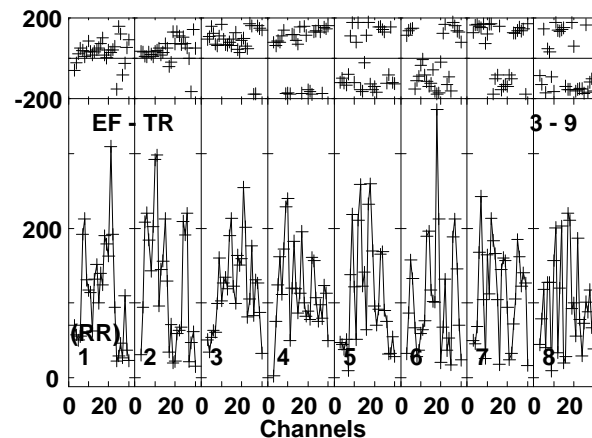
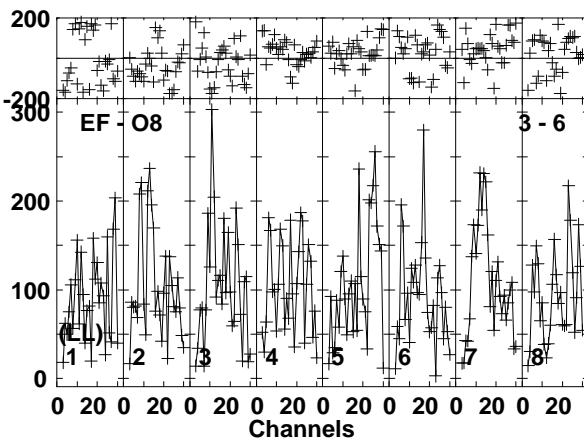
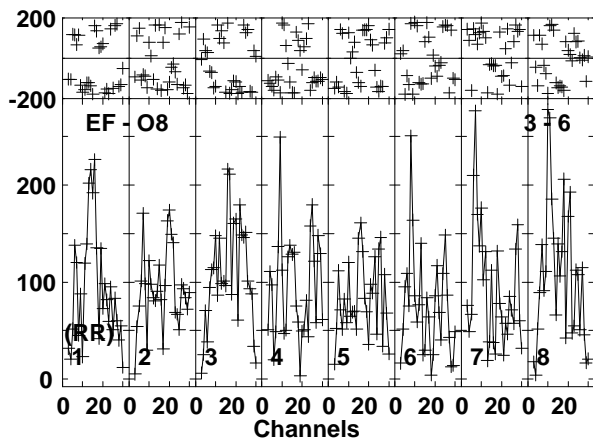
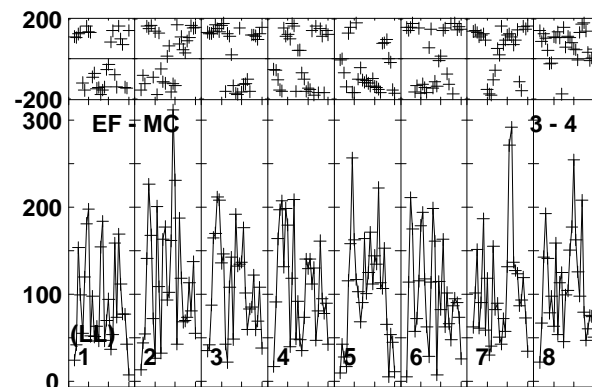
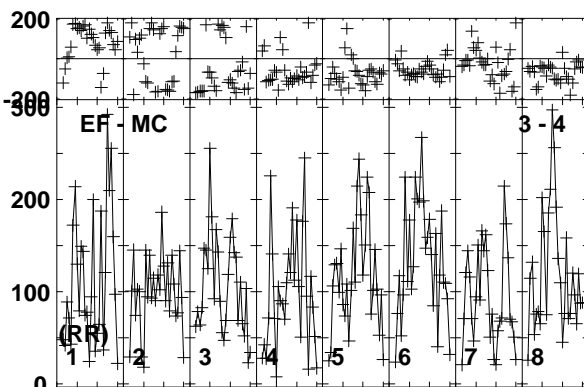
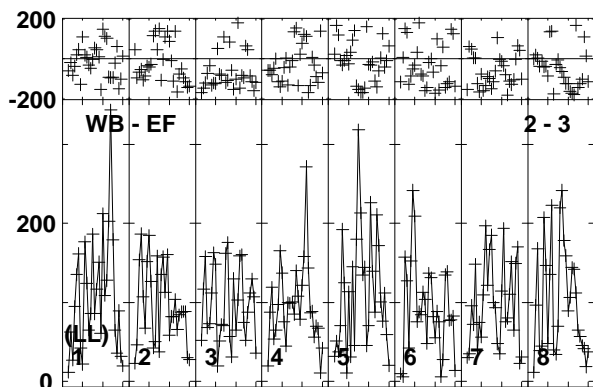
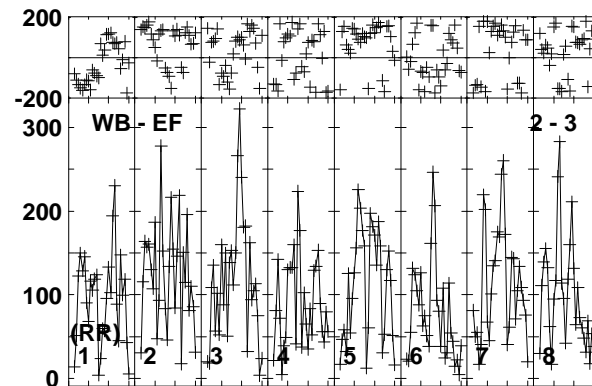
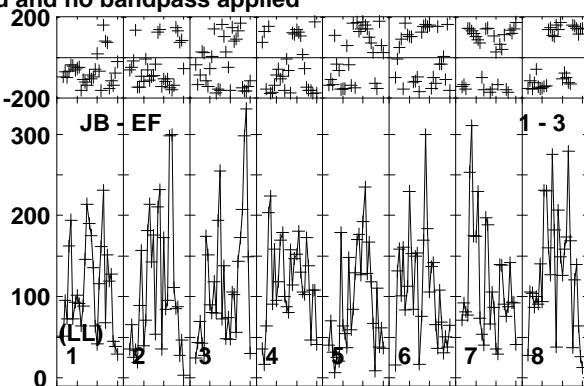
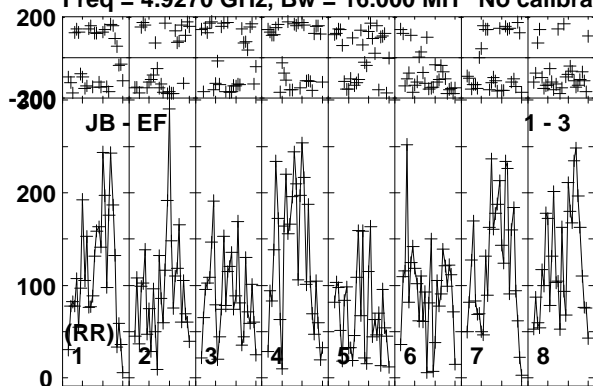

Lower frame: Micro Ampl Jy Top frame: Phas deg  
Vector averaged cross-power spectrum Baseline: JB (01) - EF (03)  
Timerange: 00:16:46:01 to 00:16:48:59

Plot file version 852 created 19-DEC-2018 17:59:08

AT2018\_RY007C.UVDATA.1

Freq = 4.9270 GHz, Bw = 16.000 MH No calibration applied and no bandpass applied

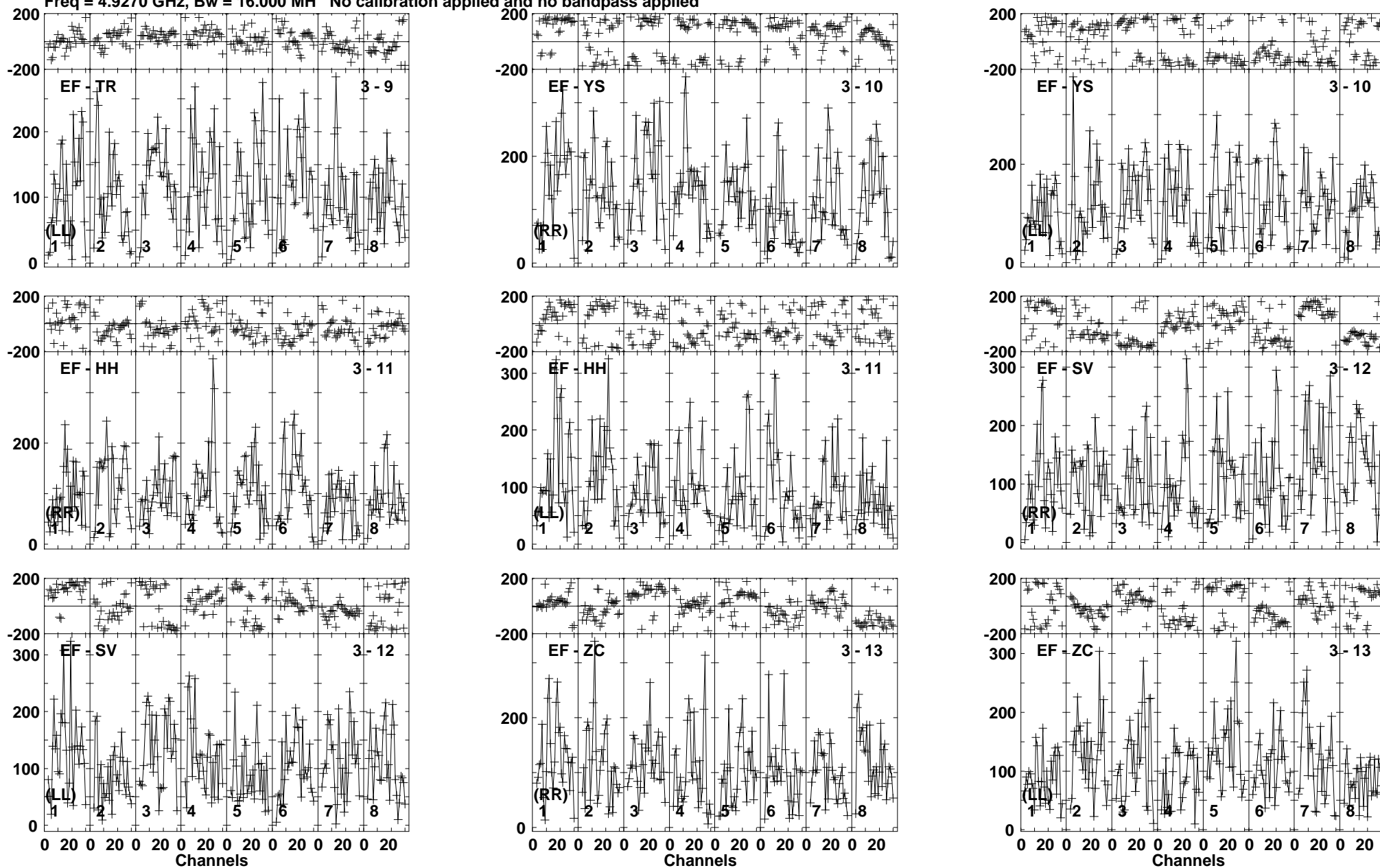

Lower frame: Micro Ampl Jy Top frame: Phas deg  
Vector averaged cross-power spectrum Baseline: EF (03) - TR (09)  
Timerange: 00/16:46:01 to 00/16:48:59

Plot file version 853 created 19-DEC-2018 17:59:08

AT2018\_RY007C.UVDATA.1

Freq = 4.9270 GHz, Bw = 16.000 MH No calibration applied and no bandpass applied

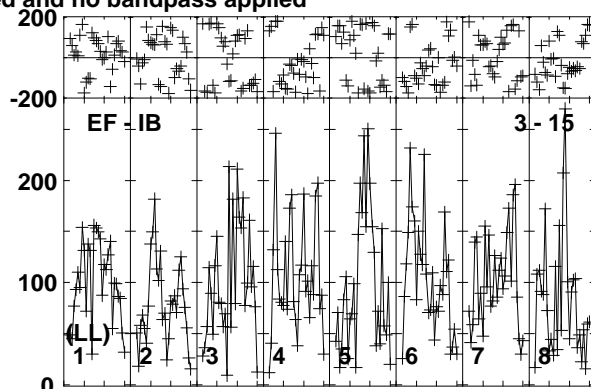
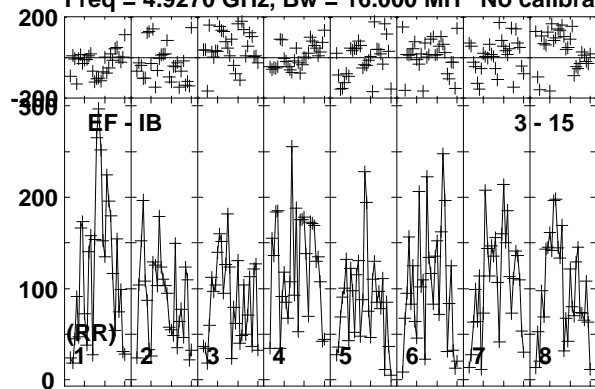

Lower frame: Micro Ampl Jy Top frame: Phas deg  
Vector averaged cross-power spectrum Baseline: EF (03) - IB (15)  
Timerange: 00/16:46:01 to 00/16:48:59

Plot file version 854 created 19-DEC-2018 17:59:08

J1619+2247 RY007C.UVDATA.1

Freq = 4.9270 GHz, Bw = 16.000 MH No calibration applied and no bandpass applied

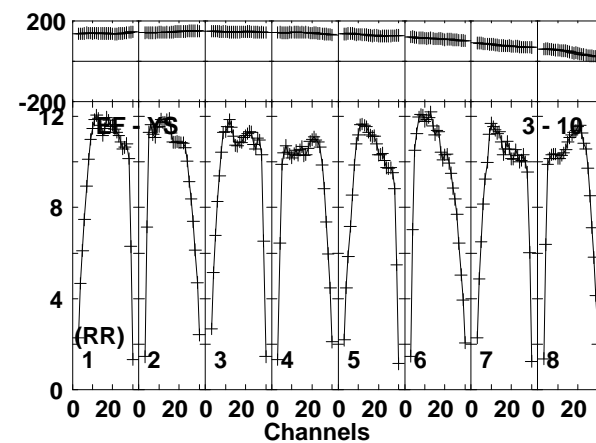
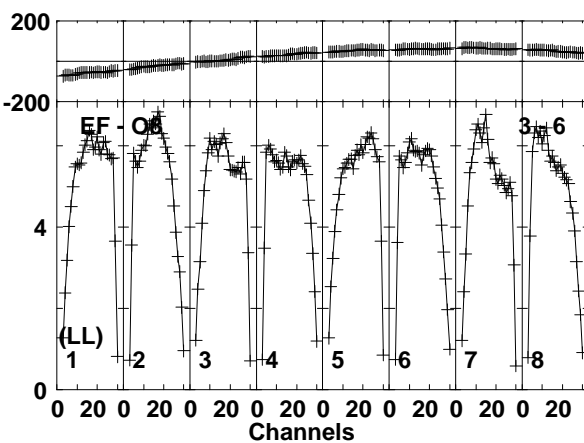
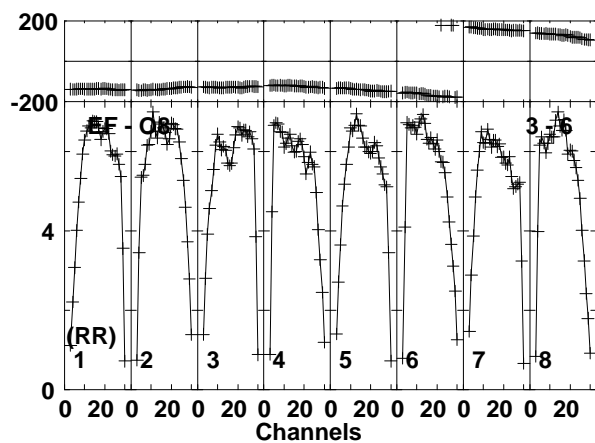
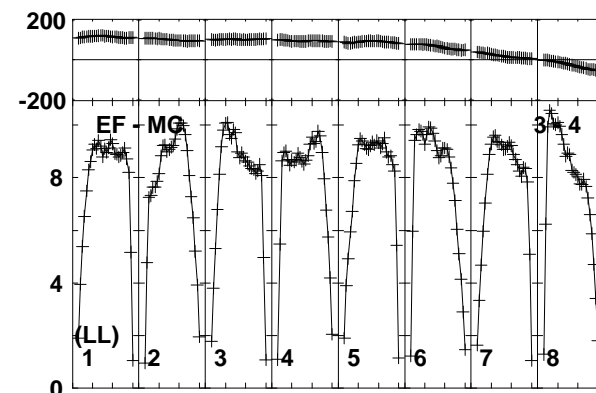
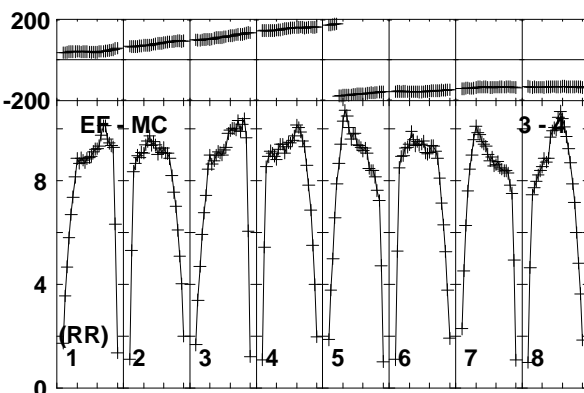
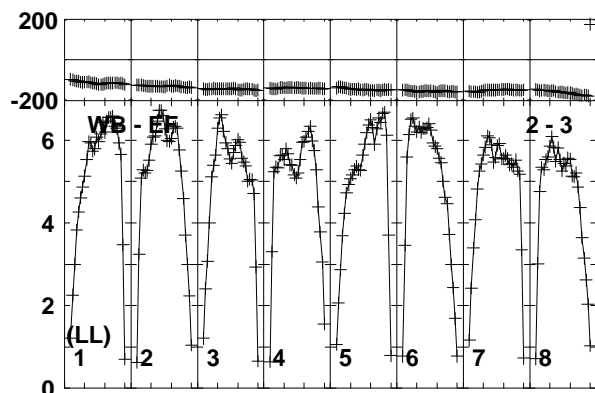
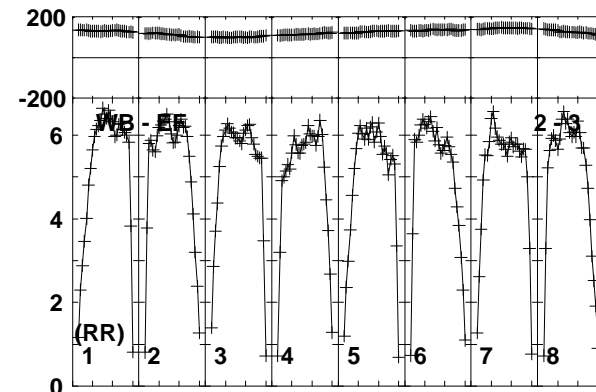
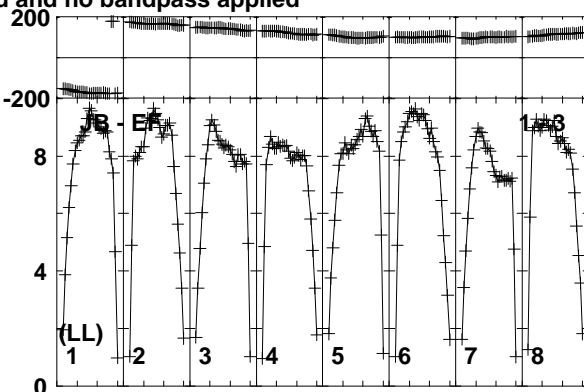
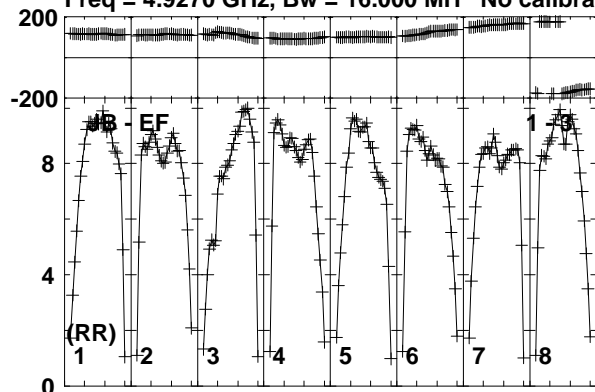

Lower frame: Milli Ampl Jy Top frame: Phas deg  
Vector averaged cross-power spectrum Baseline: JB (01) - EF (03)  
Timerange: 00/16:49:01 to 00/16:49:59

Plot file version 855 created 19-DEC-2018 17:59:08

J1619+2247 RY007C.UVDATA.1

Freq = 4.9270 GHz, Bw = 16.000 MH No calibration applied and no bandpass applied

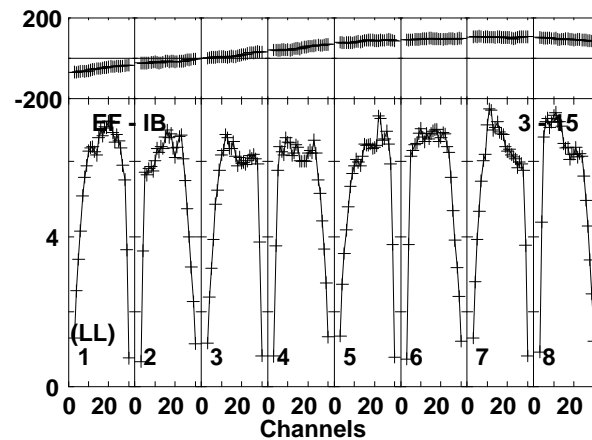
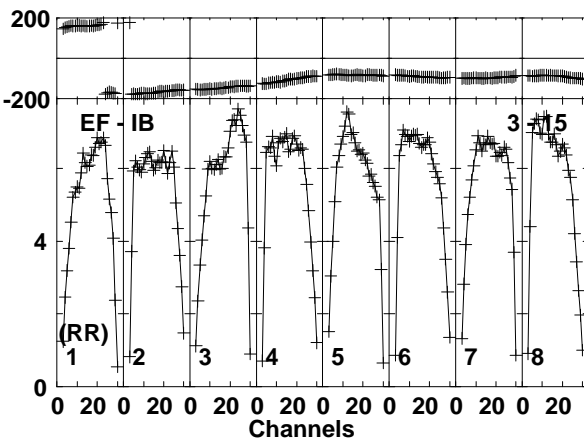
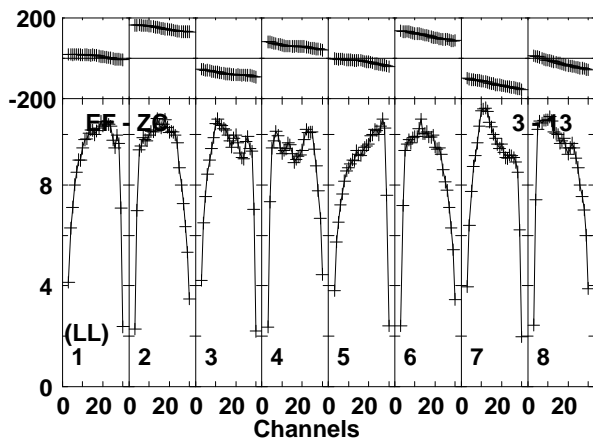
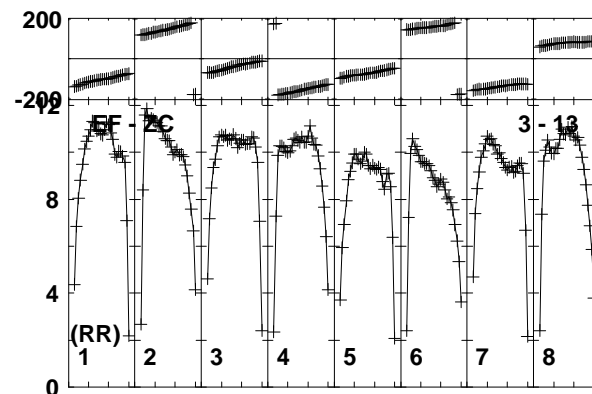
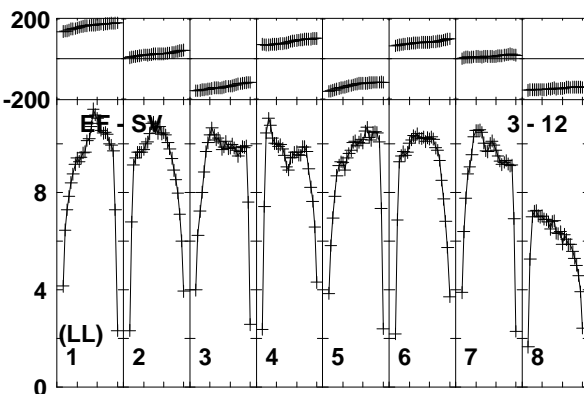
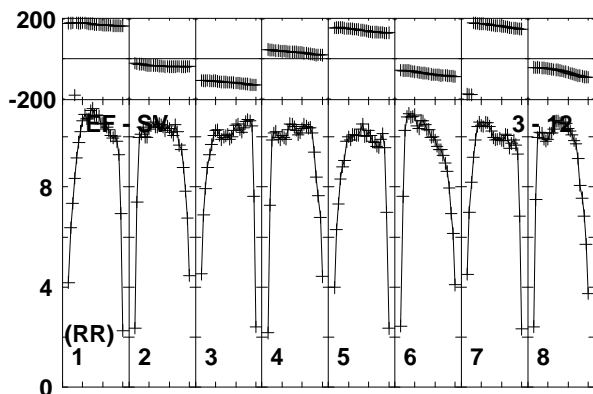
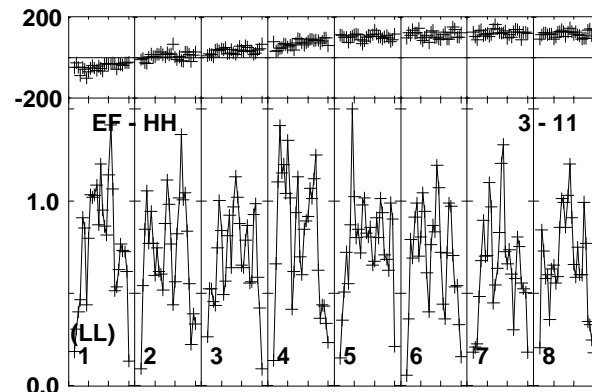
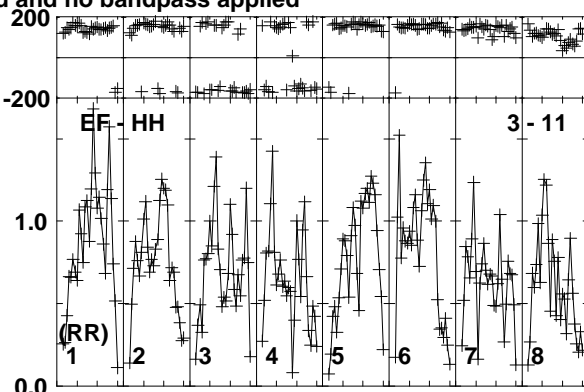
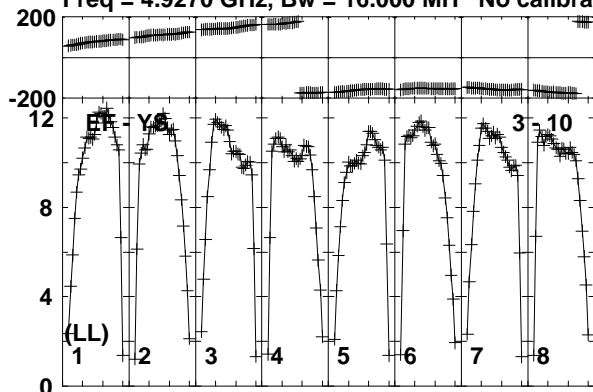

Lower frame: Milli Ampl Jy Top frame: Phas deg  
Vector averaged cross-power spectrum Baseline: EF (03) - YS (10)  
Timerange: 00/16:49:01 to 00/16:49:59

Plot file version 856 created 19-DEC-2018 17:59:08  
AT2018\_RY007C.UVDATA.1

Freq = 4.9270 GHz, Bw = 16.000 MH No calibration applied and no bandpass applied

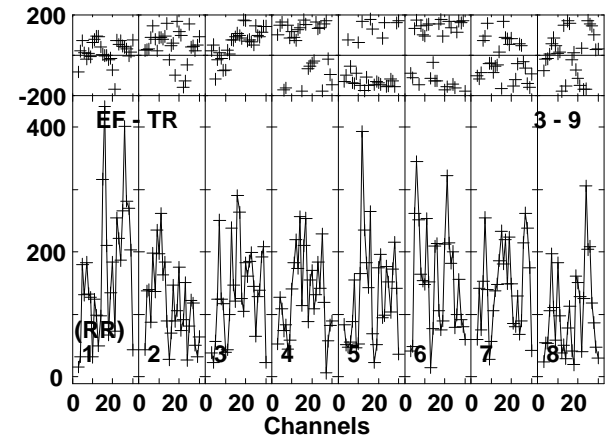
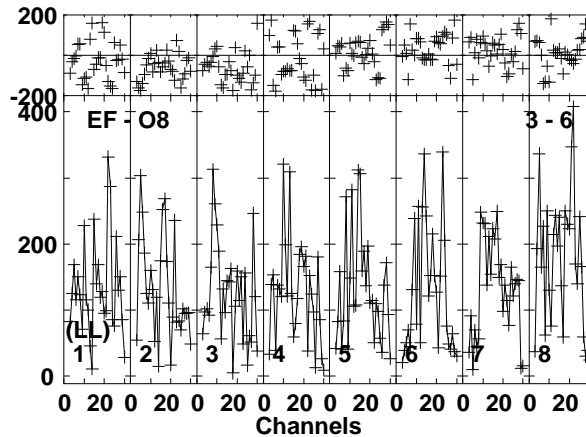
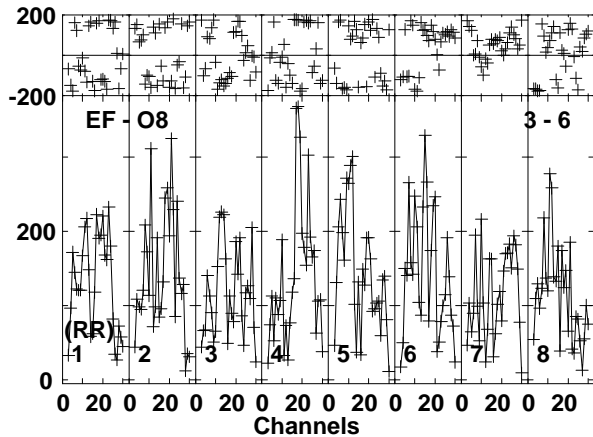
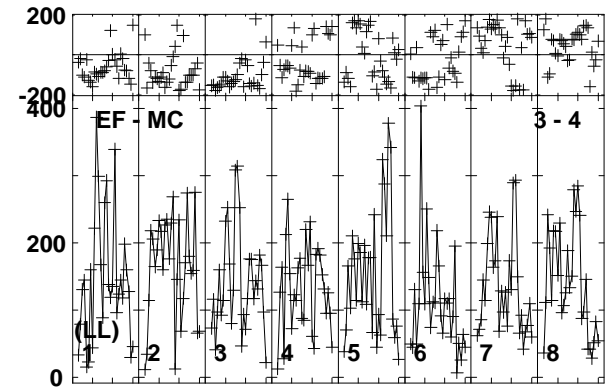
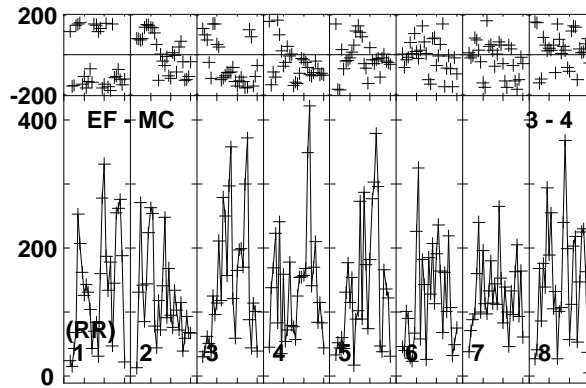
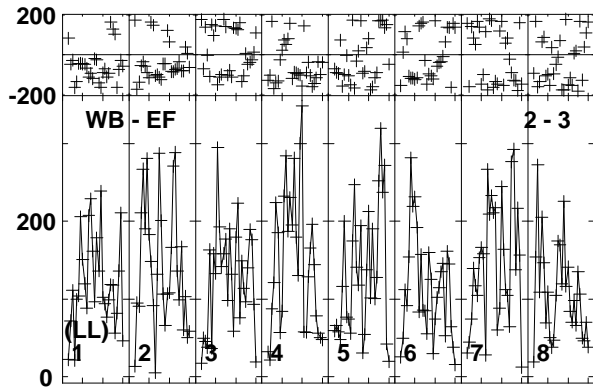
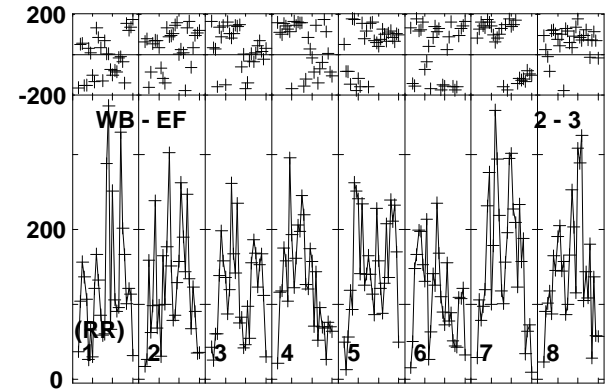
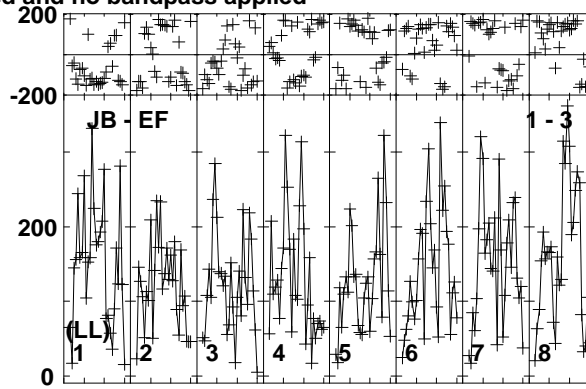
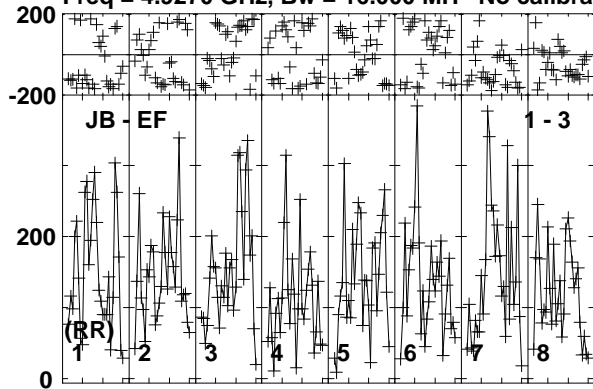

Lower frame: Micro Ampl Jy Top frame: Phas deg  
Vector averaged cross-power spectrum Baseline: JB (01) - EF (03)  
Timerange: 00/16:50:01 to 00/16:51:59

Plot file version 857 created 19-DEC-2018 17:59:08

AT2018\_RY007C.UVDATA.1

Freq = 4.9270 GHz, Bw = 16.000 MH No calibration applied and no bandpass applied

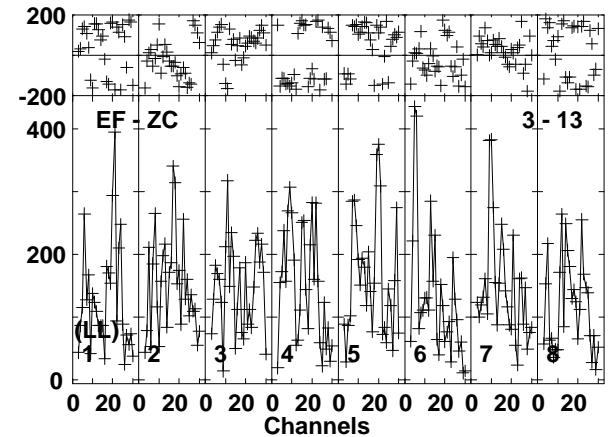
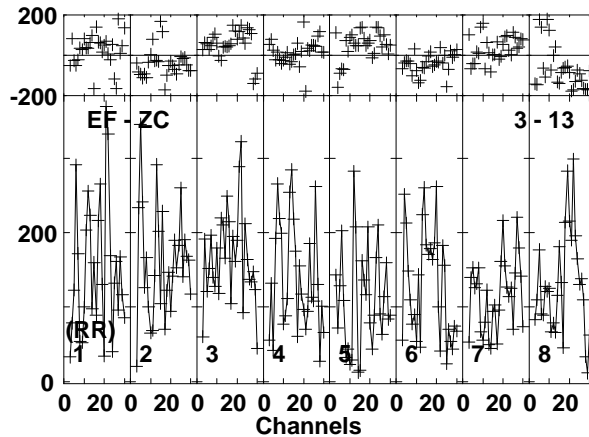
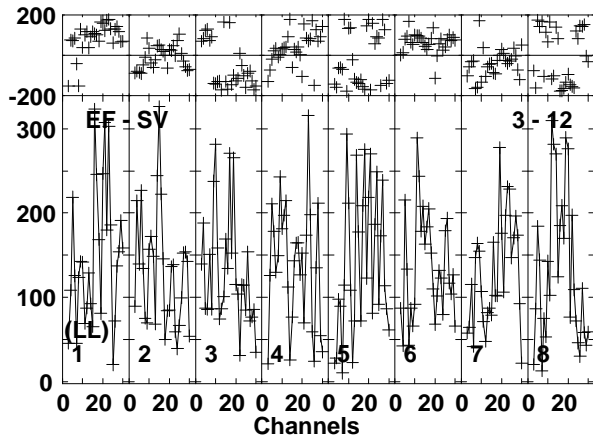
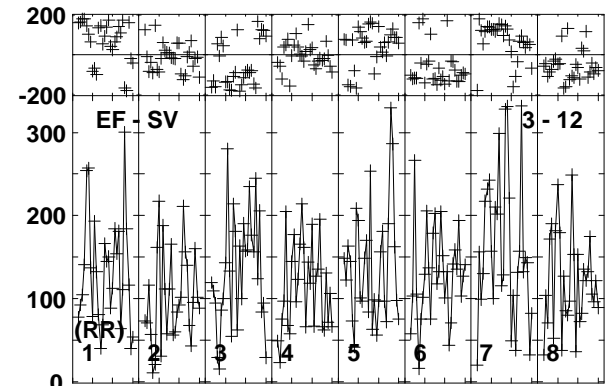
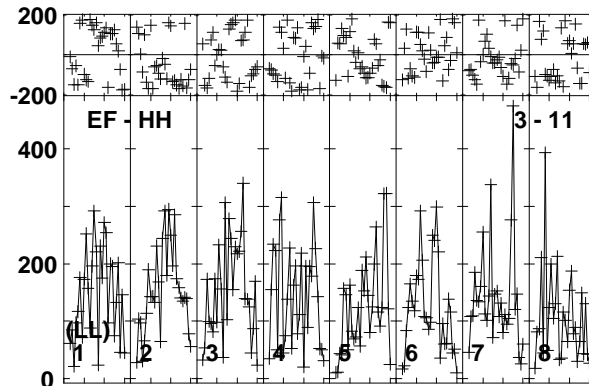
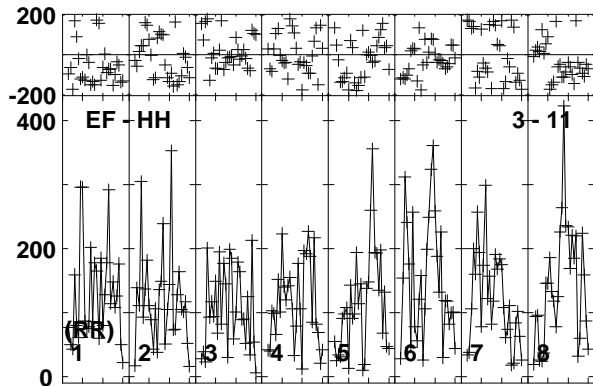
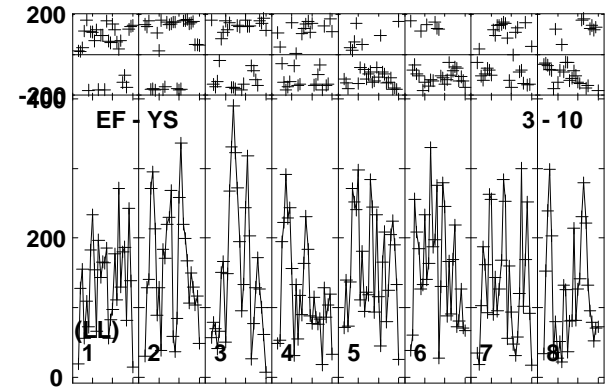
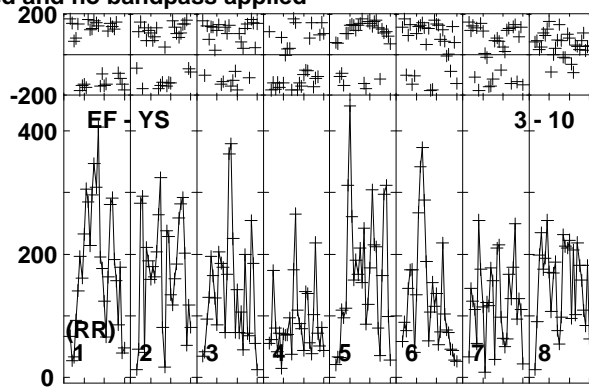
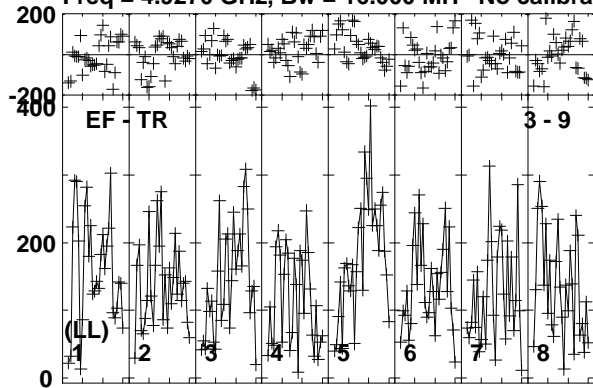

Lower frame: Micro Ampl Jy Top frame: Phas deg  
Vector averaged cross-power spectrum Baseline: EF (03) - TR (09)  
Timerange: 00/16:50:01 to 00/16:51:59

Plot file version 858 created 19-DEC-2018 17:59:08

AT2018\_RY007C.UVDATA.1

Freq = 4.9270 GHz, Bw = 16.000 MH No calibration applied and no bandpass applied

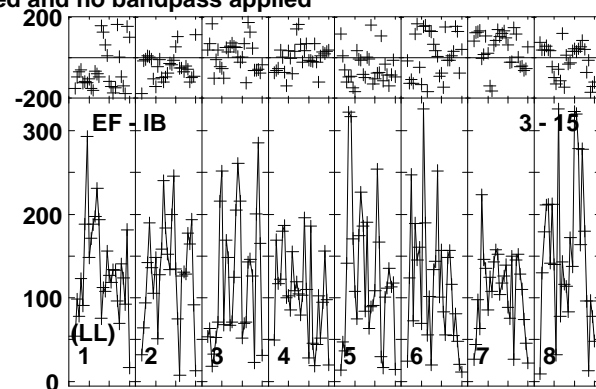
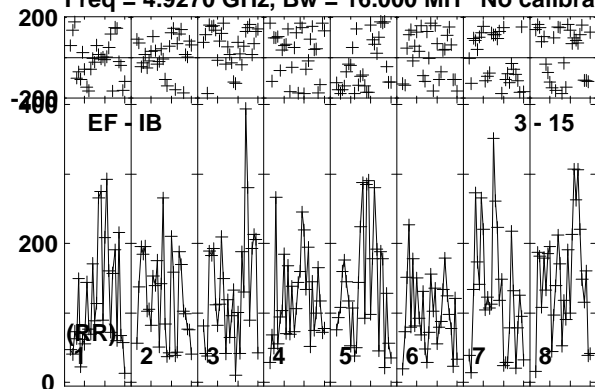

Lower frame: Micro Ampl Jy Top frame: Phas deg  
Vector averaged cross-power spectrum Baseline: EF (03) - IB (15)  
Timerange: 00/16:50:01 to 00/16:51:59



Plot file version 859 created 19-DEC-2018 17:59:08

VLA2 RY007C.UVDATA.1

Freq = 4.9270 GHz, Bw = 16.000 MH No calibration applied and no bandpass applied

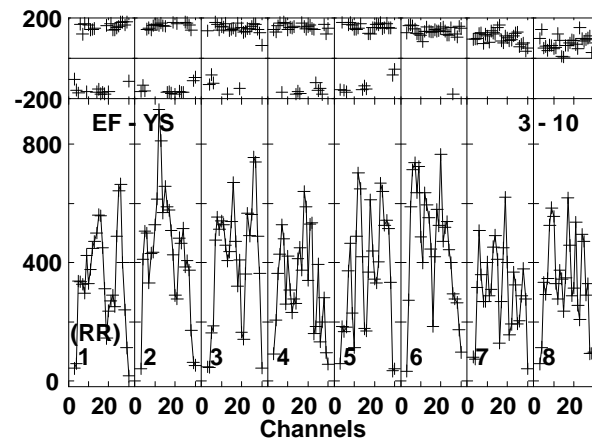
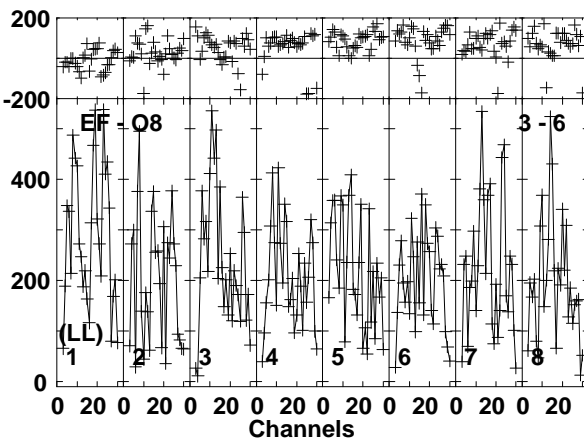
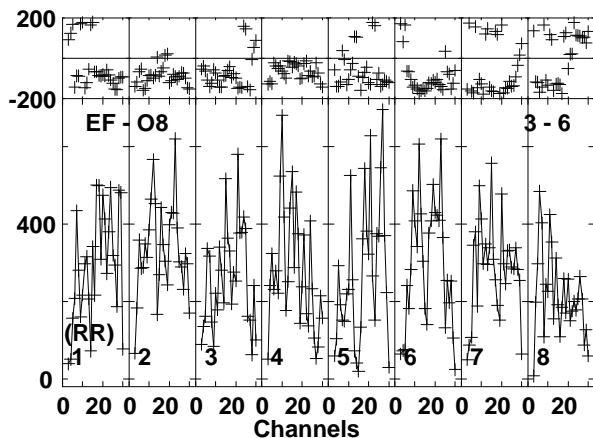
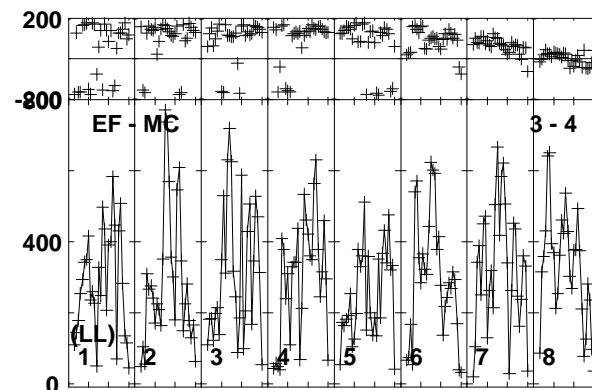
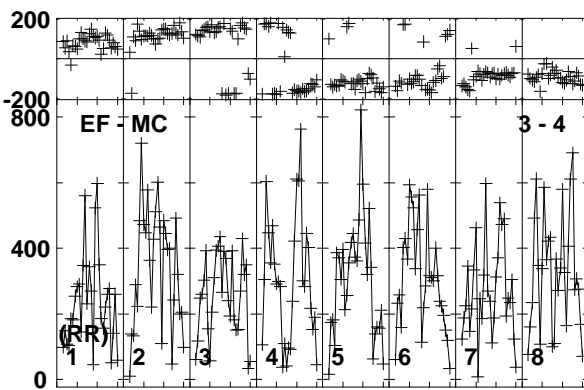
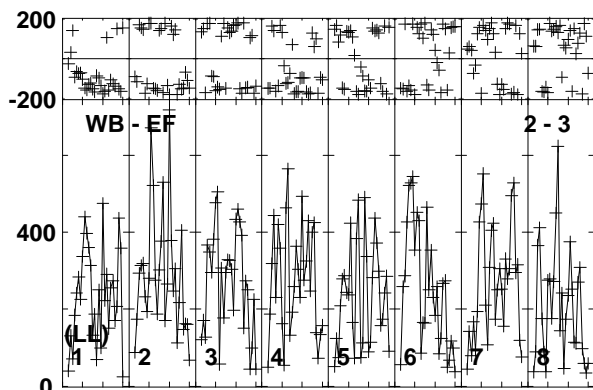
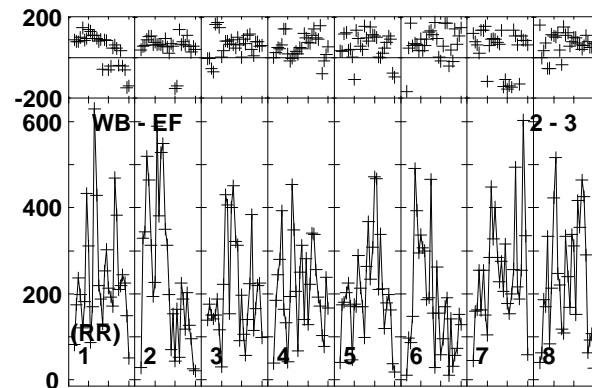
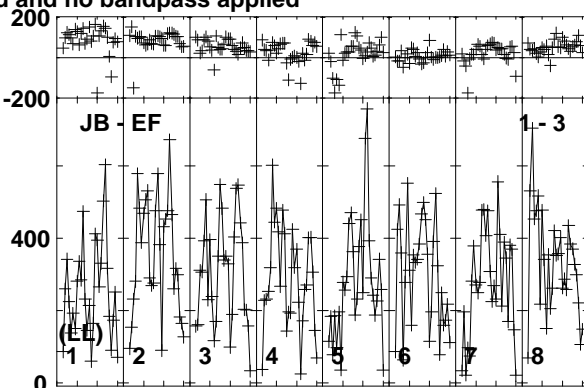
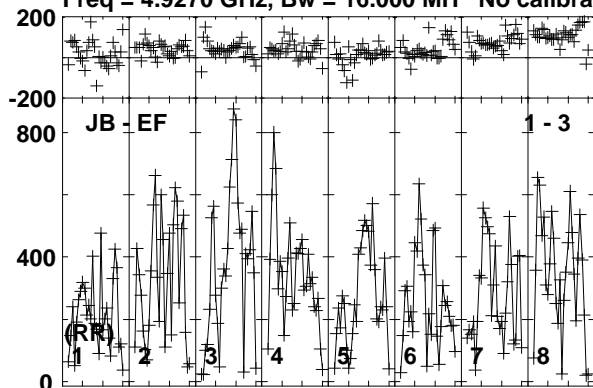

Lower frame: Micro Ampl Jy Top frame: Phas deg  
Vector averaged cross-power spectrum Baseline: JB (01) - EF (03)  
Timerange: 00/16:52:01 to 00/16:52:59

Plot file version 860 created 19-DEC-2018 17:59:08

VLA2 RY007C.UVDATA.1

Freq = 4.9270 GHz, Bw = 16.000 MH No calibration applied and no bandpass applied

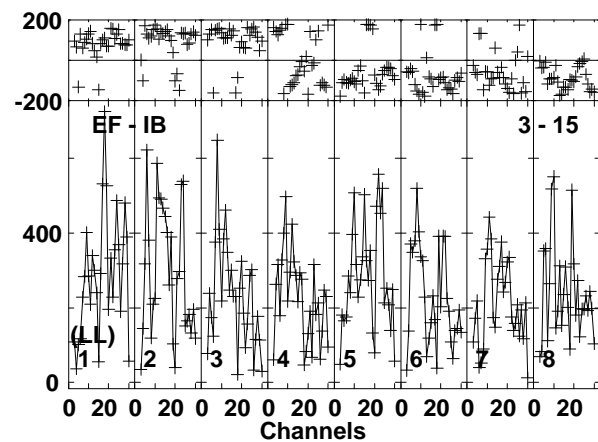
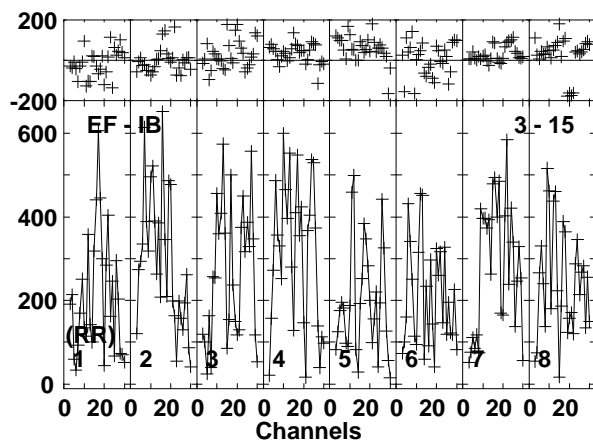
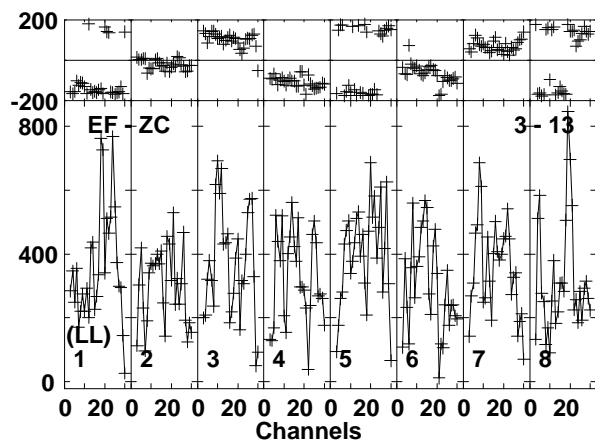
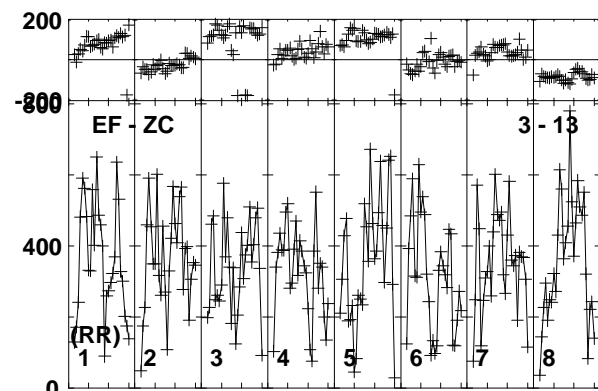
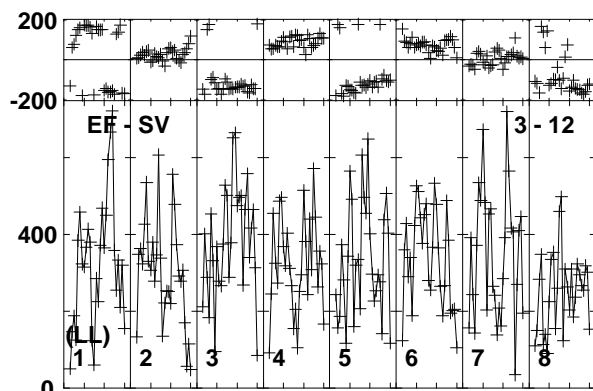
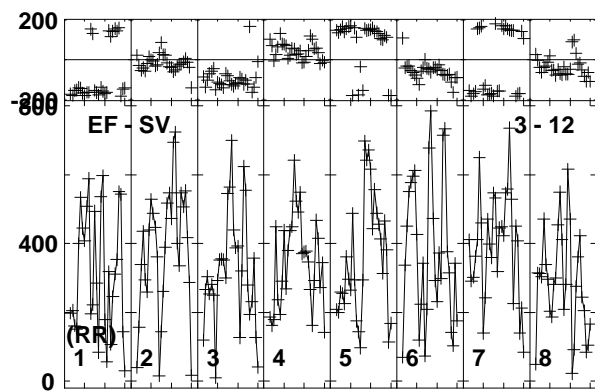
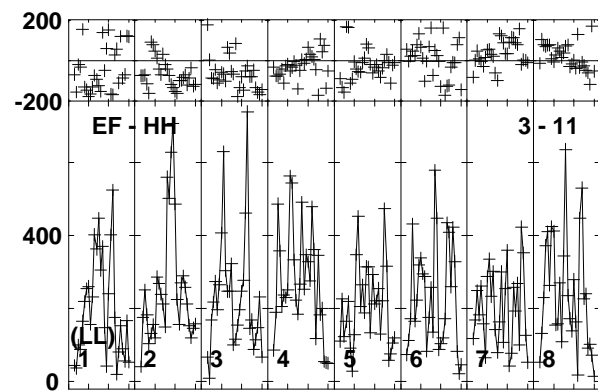
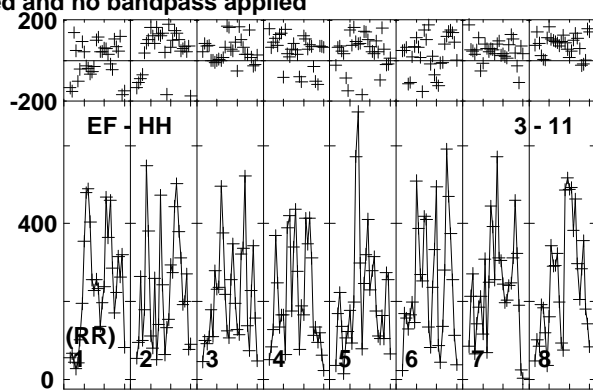
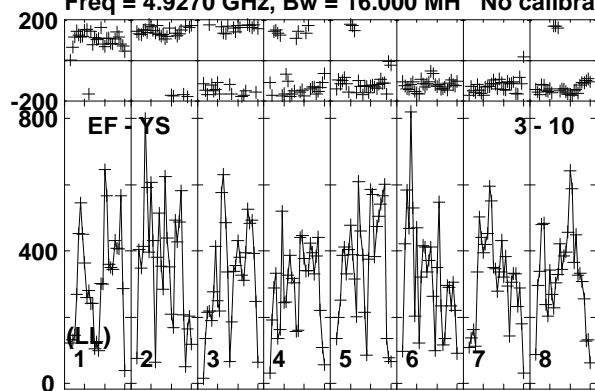

Lower frame: Micro Ampl Jy Top frame: Phas deg  
Vector averaged cross-power spectrum Baseline: EF (03) - YS (10)  
Timerange: 00/16:52:01 to 00/16:52:59

Plot file version 861 created 19-DEC-2018 17:59:08

J1619+2247 RY007C.UVDATA.1

Freq = 4.9270 GHz, Bw = 16.000 MH No calibration applied and no bandpass applied

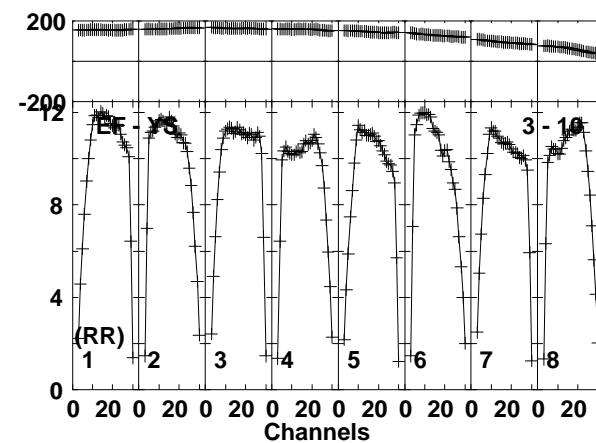
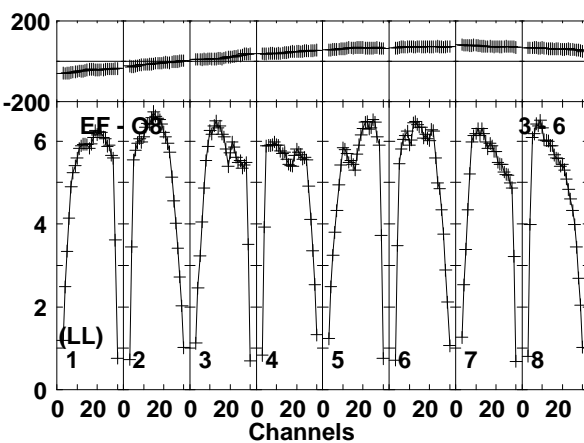
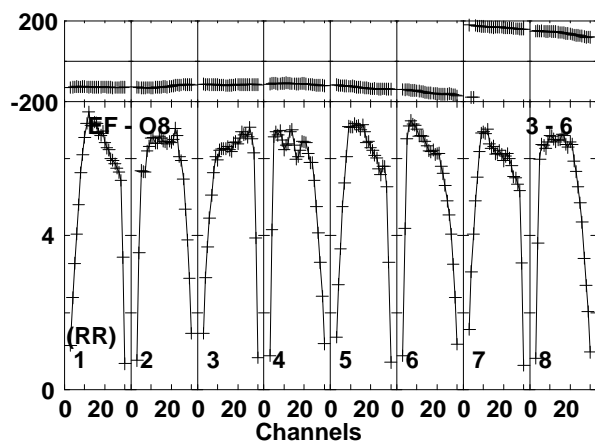
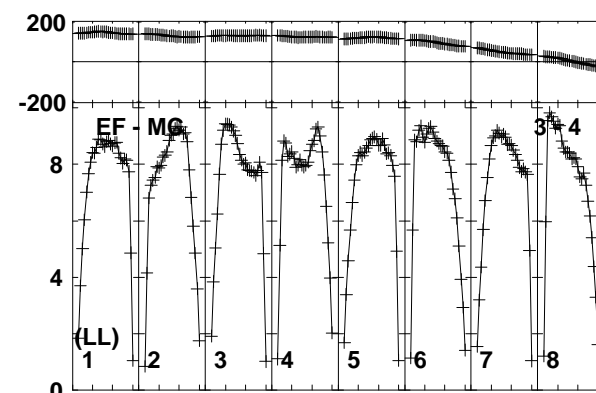
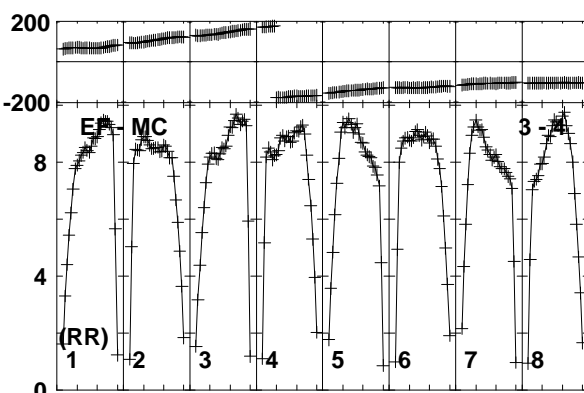
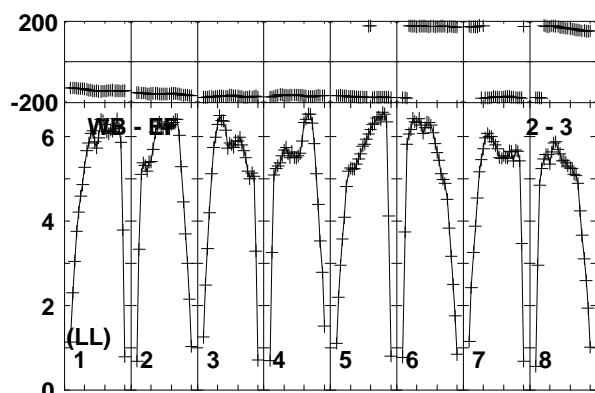
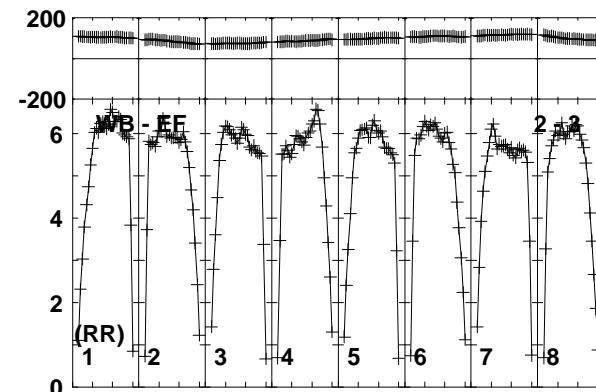
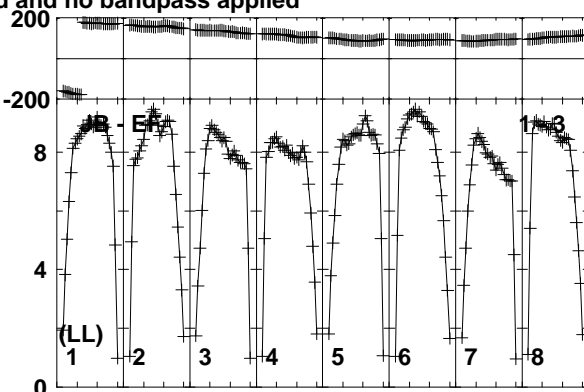
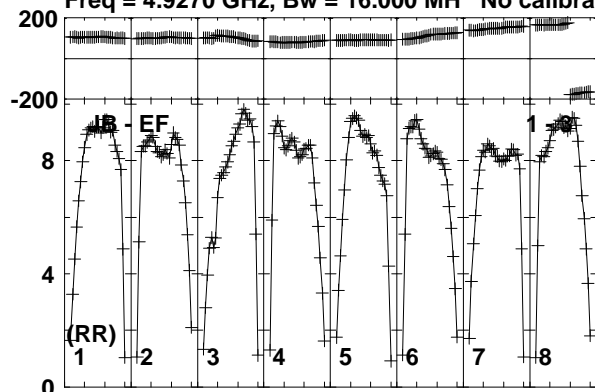

Lower frame: Milli Ampl Jy Top frame: Phas deg  
Vector averaged cross-power spectrum Baseline: JB (01) - EF (03)  
Timerange: 00/16:53:31 to 00/16:54:29

Plot file version 862 created 19-DEC-2018 17:59:09

J1619+2247 RY007C.UVDATA.1

Freq = 4.9270 GHz, Bw = 16.000 MH No calibration applied and no bandpass applied

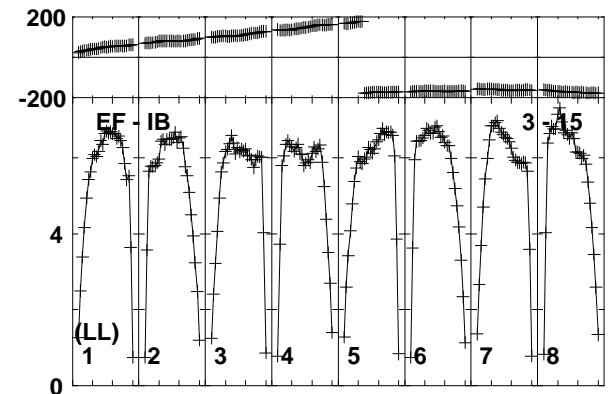
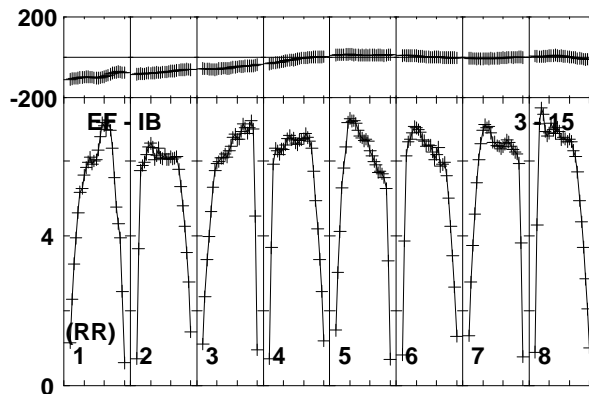
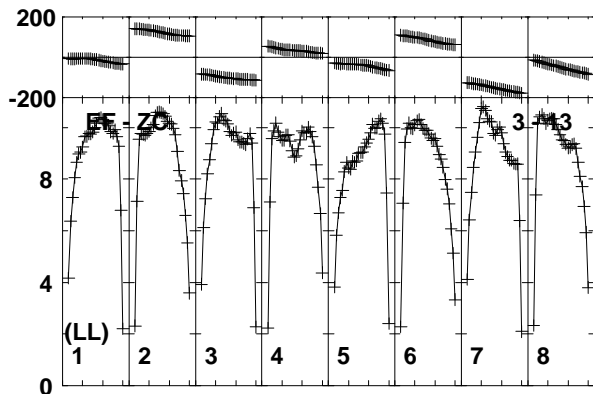
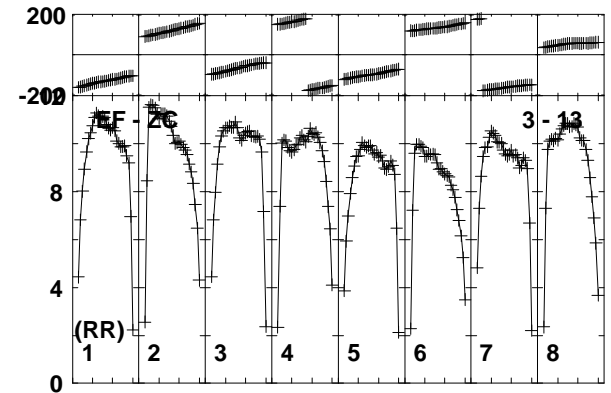
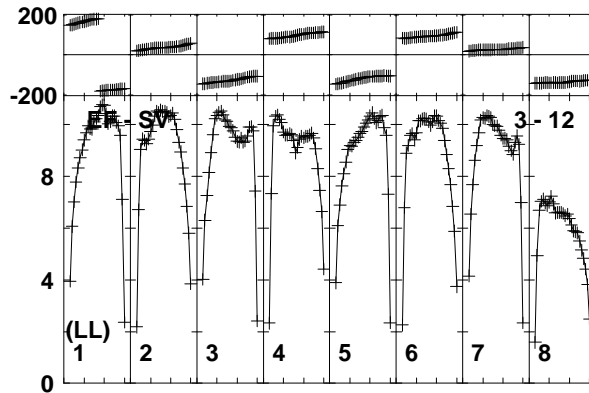
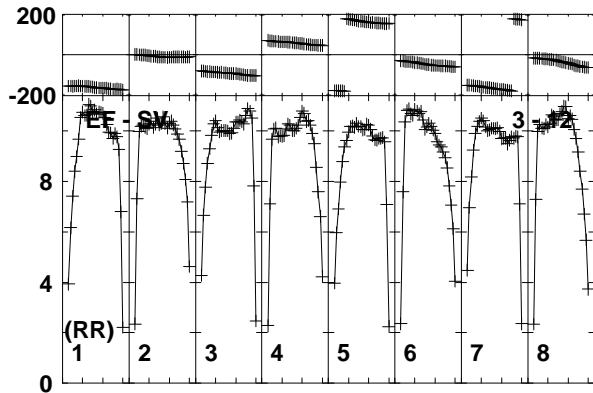
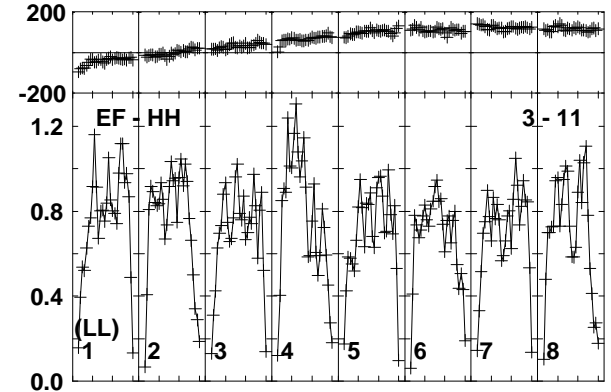
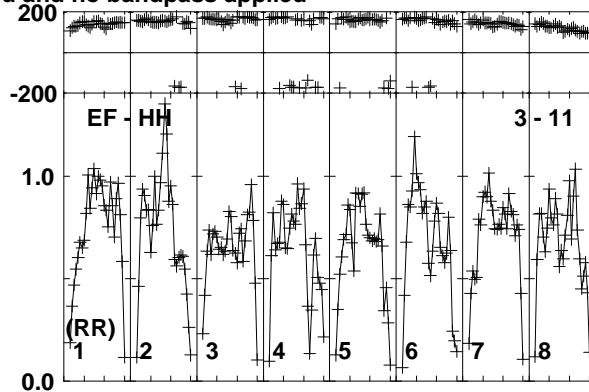
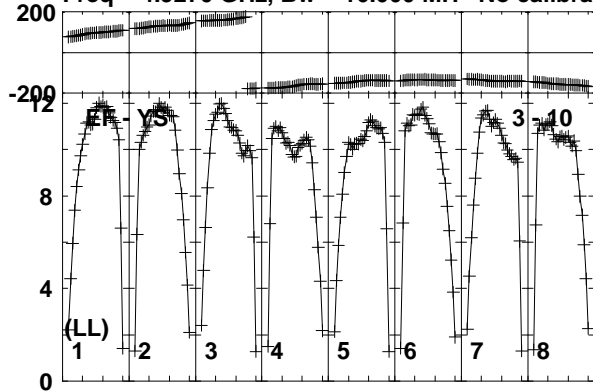

Lower frame: Milli Ampl Jy Top frame: Phas deg  
Vector averaged cross-power spectrum Baseline: EF (03) - YS (10)  
Timerange: 00/16:53:31 to 00/16:54:29

Plot file version 863 created 19-DEC-2018 17:59:09

AT2018\_RY007C.UVDATA.1

Freq = 4.9270 GHz, Bw = 16.000 MH No calibration applied and no bandpass applied

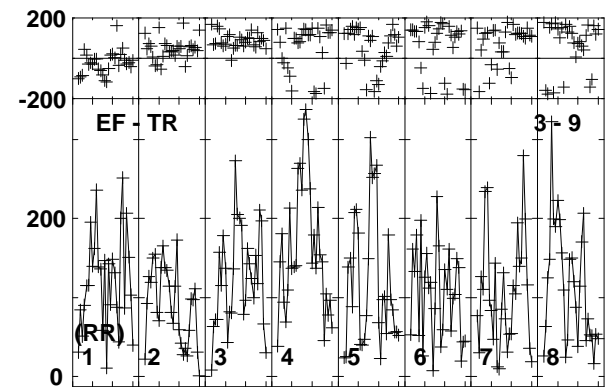
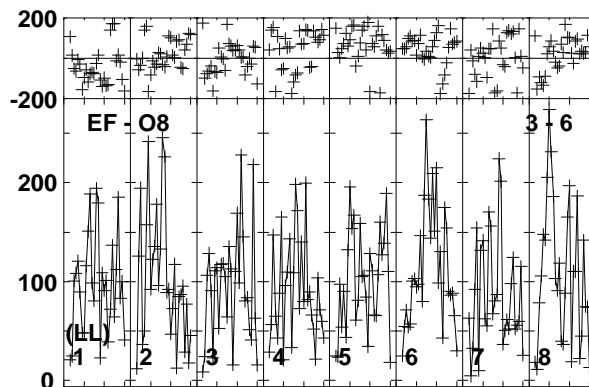
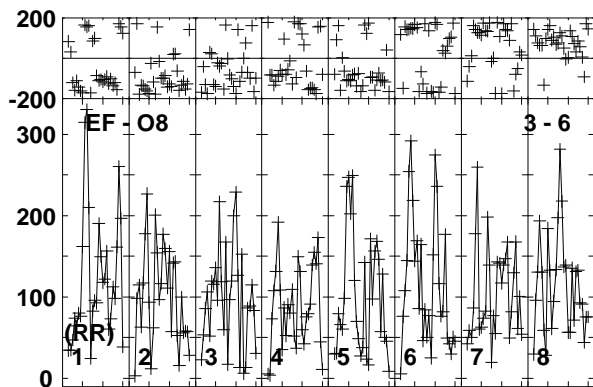
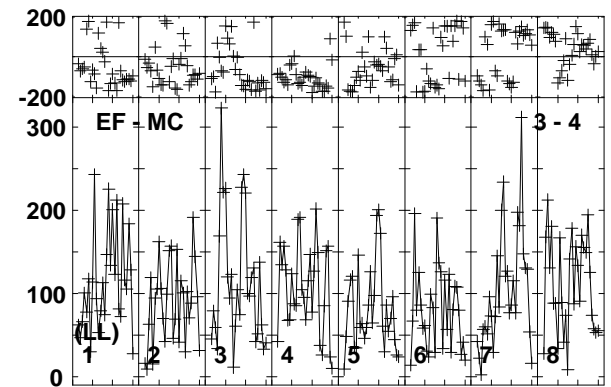
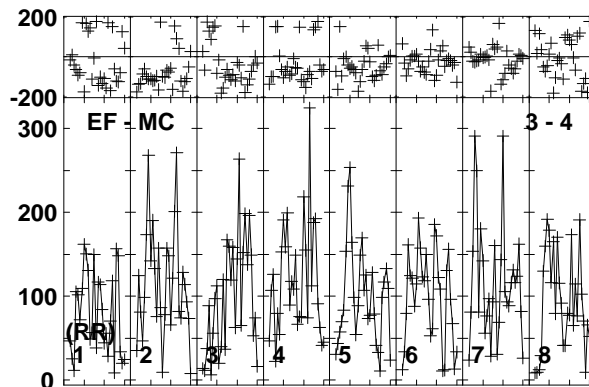
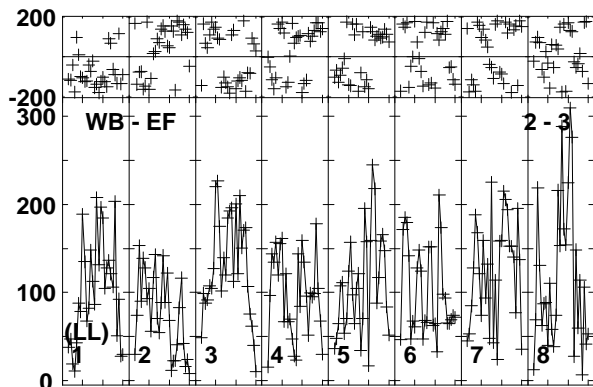
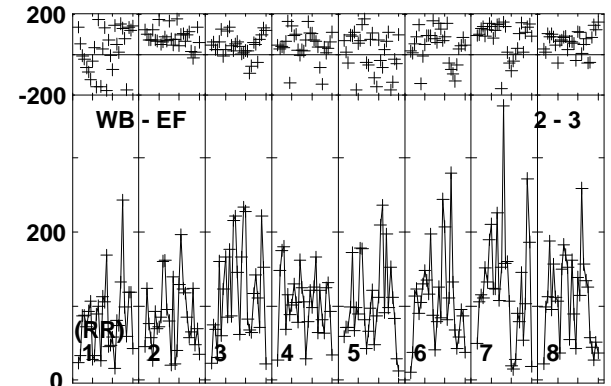
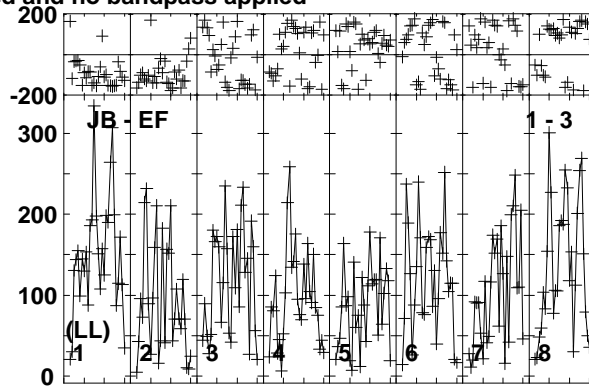
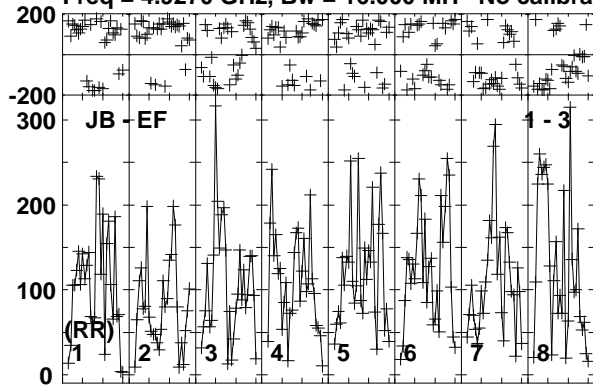

Lower frame: Micro Ampl Jy Top frame: Phas deg  
Vector averaged cross-power spectrum Baseline: JB (01) - EF (03)  
Timerange: 00/16:54:31 to 00/16:57:29

Plot file version 864 created 19-DEC-2018 17:59:09  
 AT2018\_RY007C.UVDATA.1

Freq = 4.9270 GHz, Bw = 16.000 MH No calibration applied and no bandpass applied

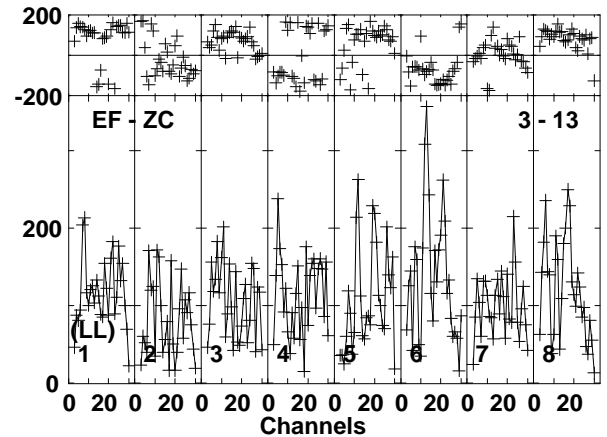
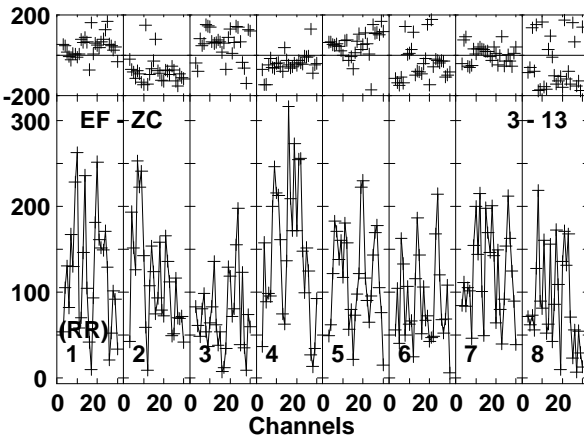
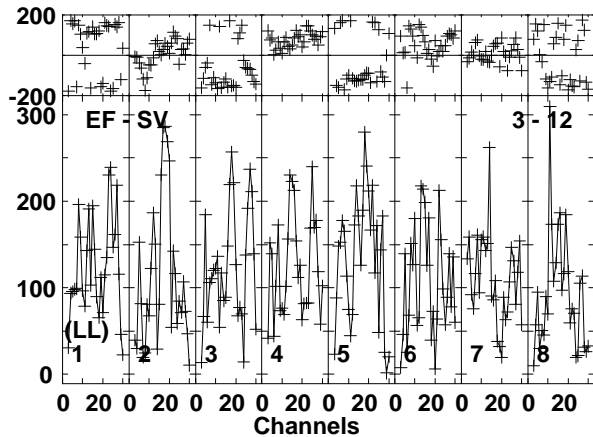
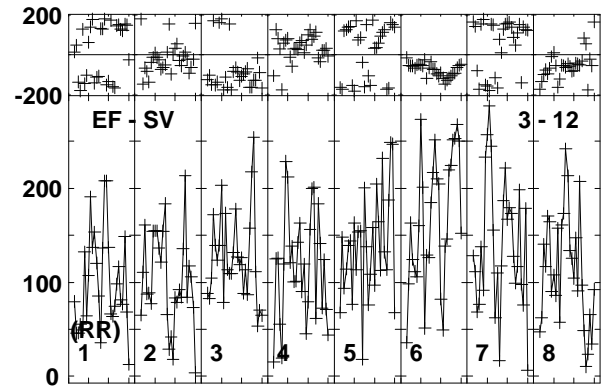
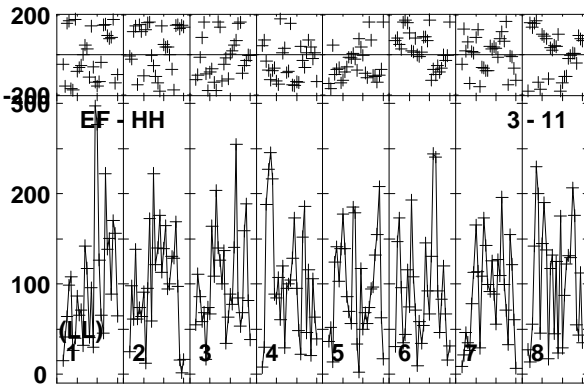
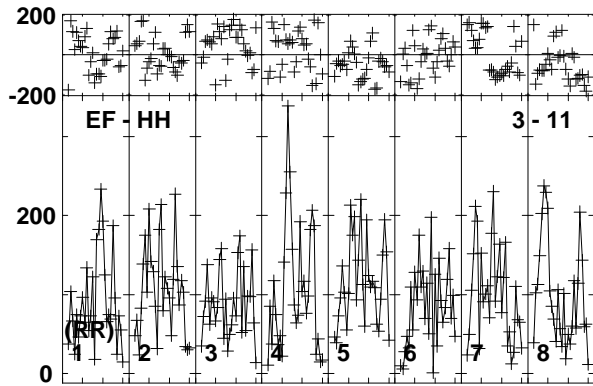
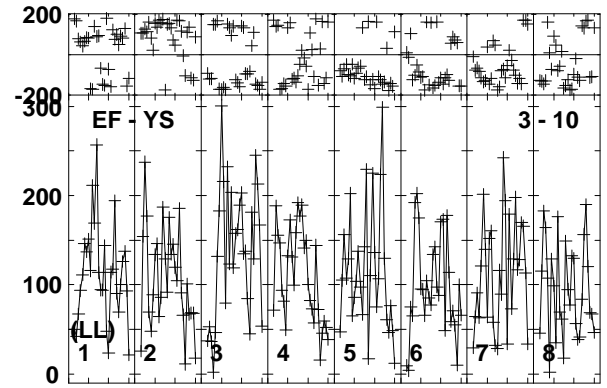
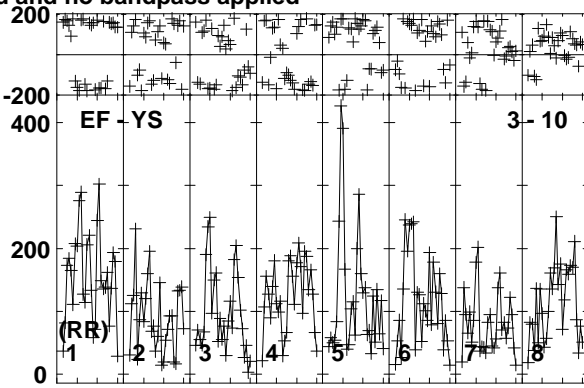
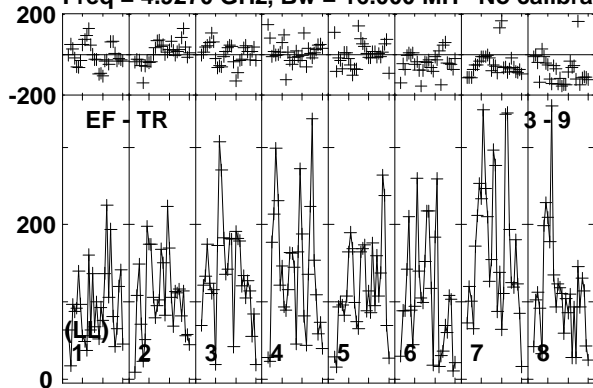

Lower frame: Micro Ampl Jy Top frame: Phas deg  
 Vector averaged cross-power spectrum Baseline: EF (03) - TR (09)  
 Timerange: 00/16:54:31 to 00/16:57:29

Plot file version 865 created 19-DEC-2018 17:59:09

AT2018\_RY007C.UVDATA.1

Freq = 4.9270 GHz, Bw = 16.000 MH No calibration applied and no bandpass applied

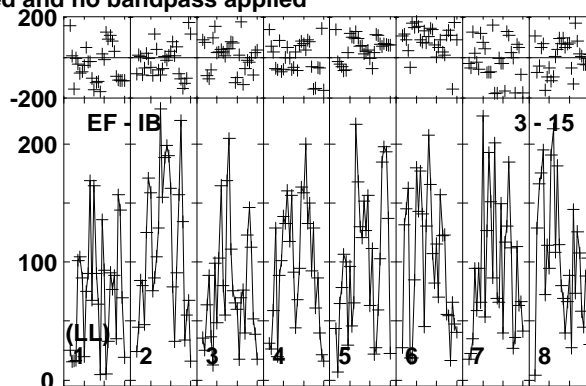
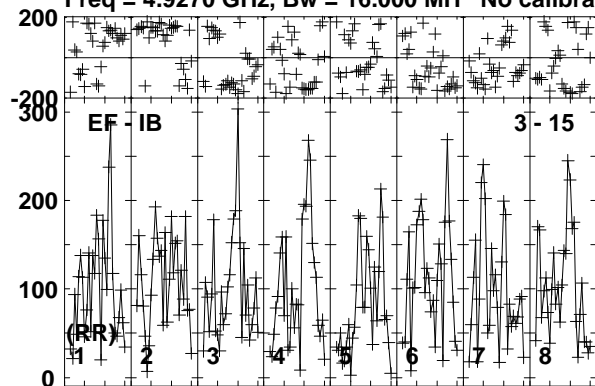

Lower frame: Micro Ampl Jy Top frame: Phas deg  
Vector averaged cross-power spectrum Baseline: EF (03) - IB (15)  
Timerange: 00/16:54:31 to 00/16:57:29

Plot file version 866 created 19-DEC-2018 17:59:09

J1619+2247 RY007C.UVDATA.1

Freq = 4.9270 GHz, Bw = 16.000 MH No calibration applied and no bandpass applied

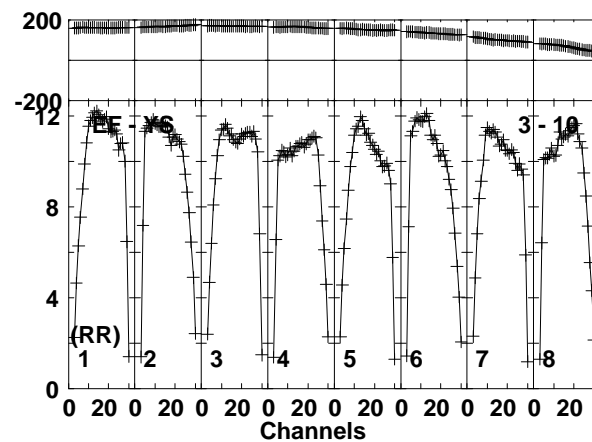
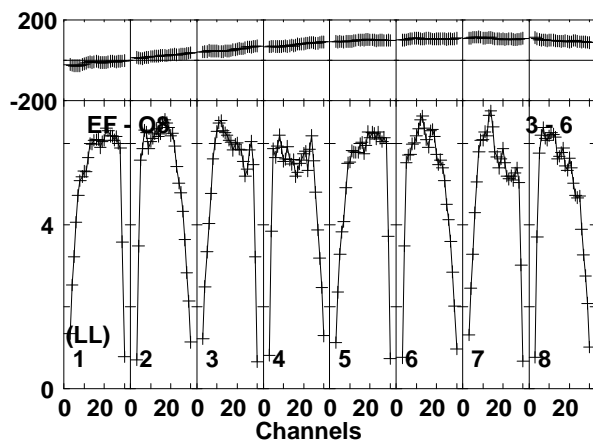
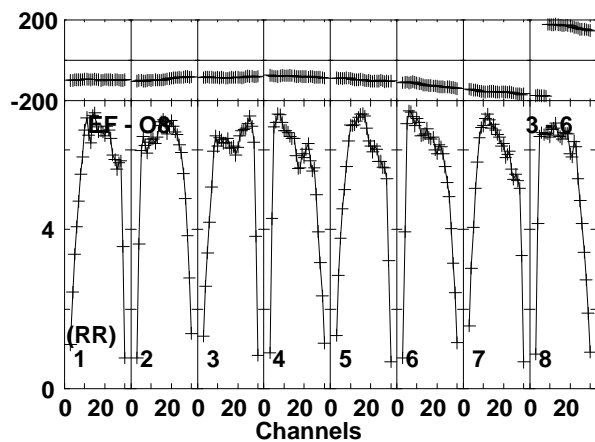
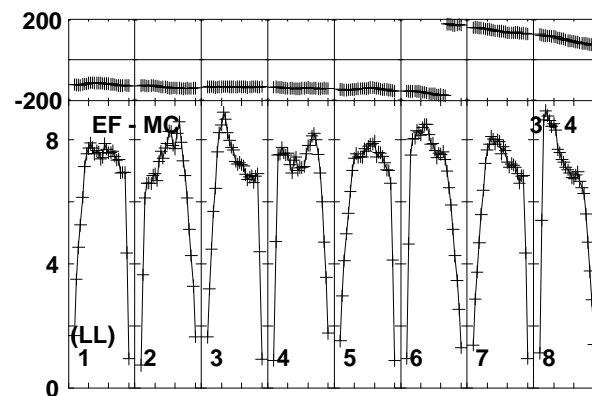
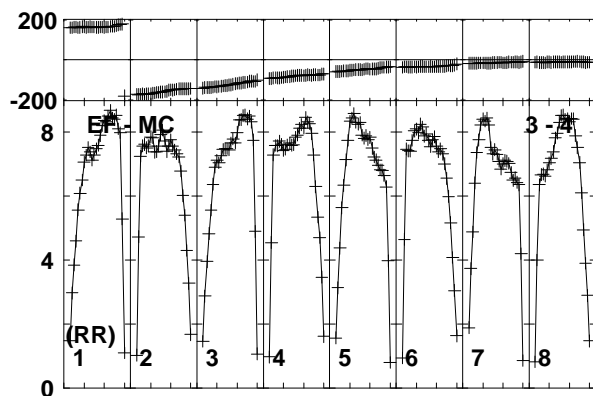
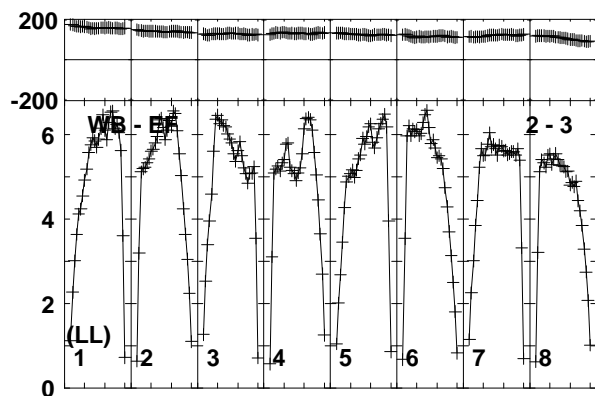
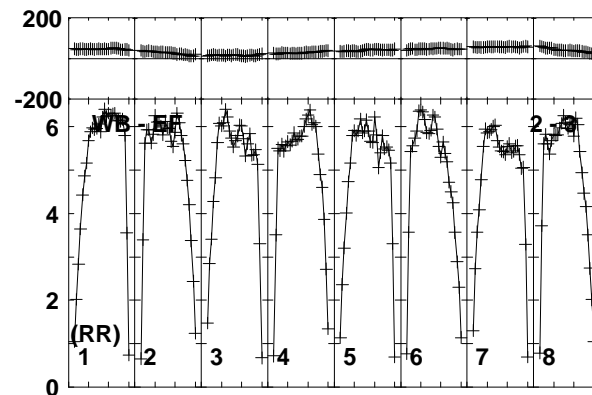
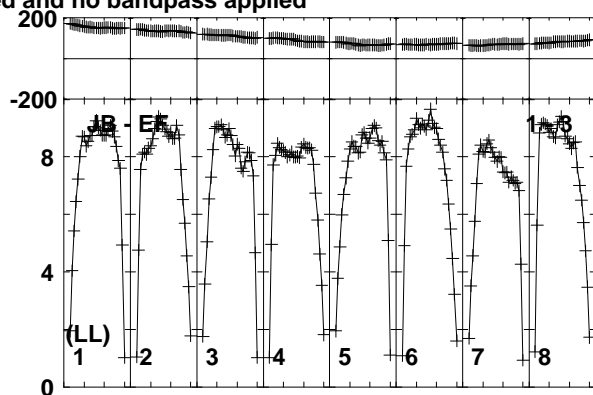
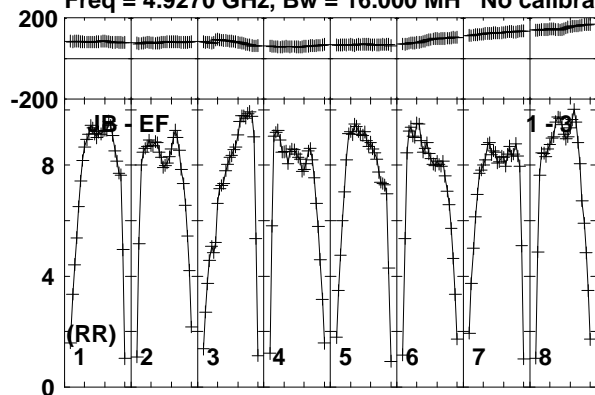

Lower frame: Milli Ampl Jy Top frame: Phas deg  
Vector averaged cross-power spectrum Baseline: JB (01) - EF (03)  
Timerange: 00/16:57:31 to 00/16:58:29



Plot file version 867 created 19-DEC-2018 17:59:09

J1619+2247 RY007C.UVDATA.1

Freq = 4.9270 GHz, Bw = 16.000 MH No calibration applied and no bandpass applied

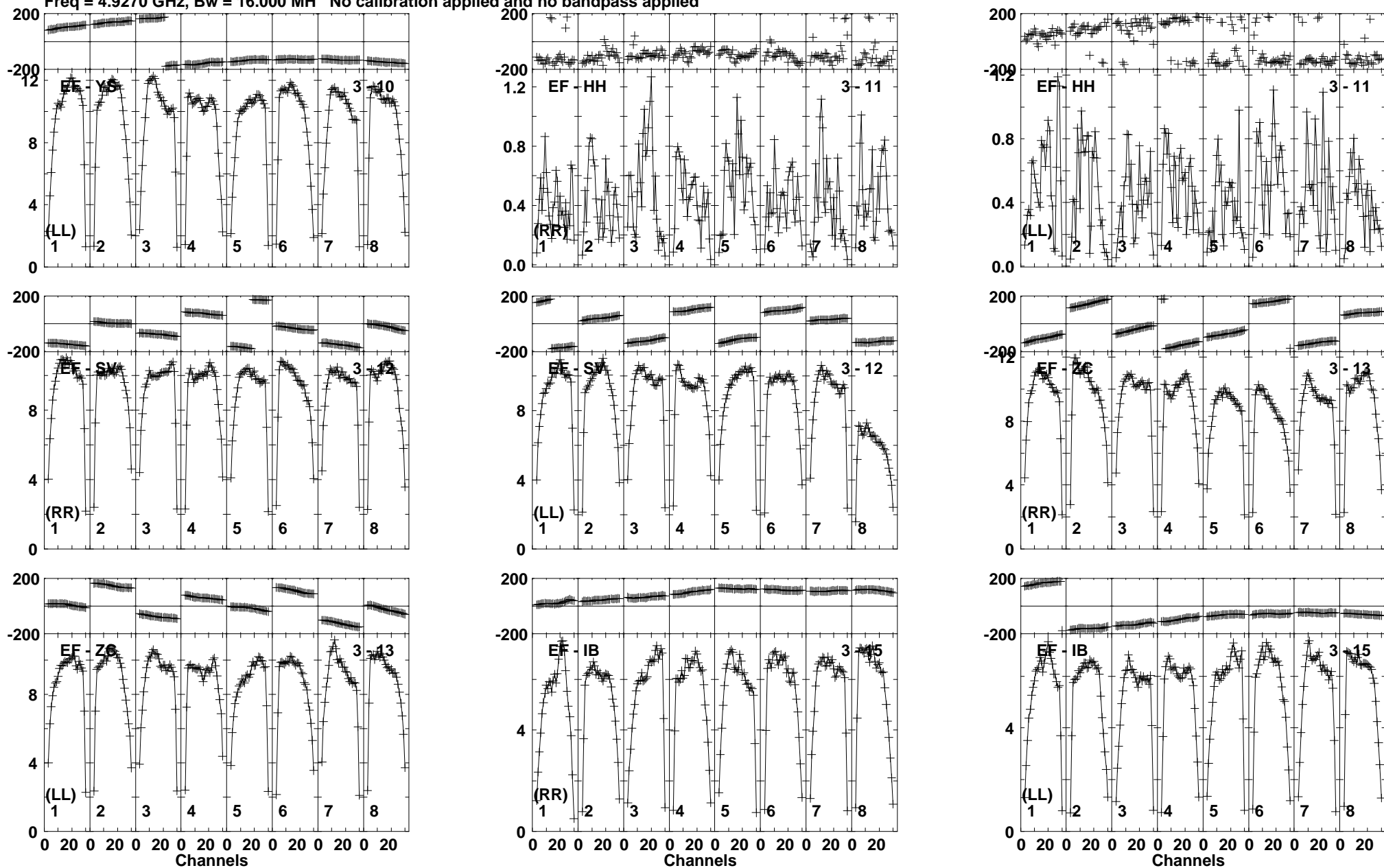

Lower frame: Milli Ampl Jy Top frame: Phas deg  
Vector averaged cross-power spectrum Baseline: EF (03) - YS (10)  
Timerange: 00/16:57:31 to 00/16:58:29

Plot file version 868 created 19-DEC-2018 17:59:09  
AT2018\_RY007C.UVDATA.1

Freq = 4.9270 GHz, Bw = 16.000 MH No calibration applied and no bandpass applied

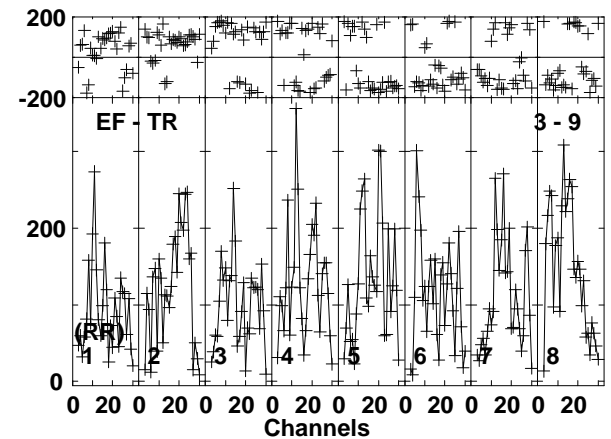
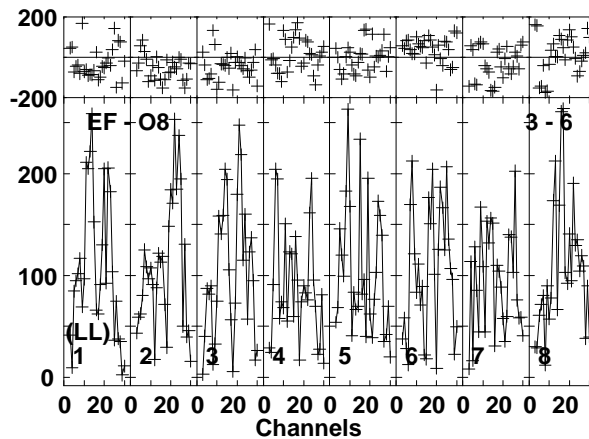
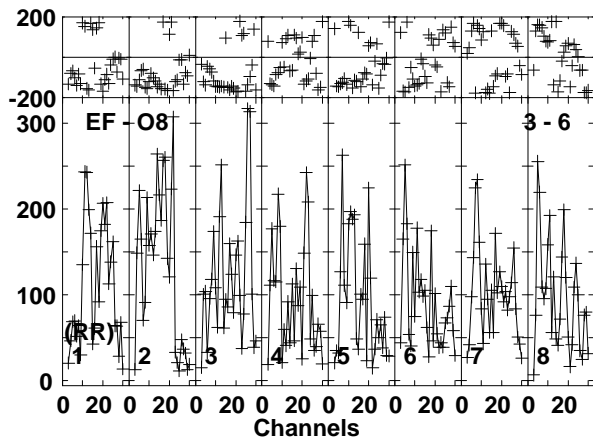
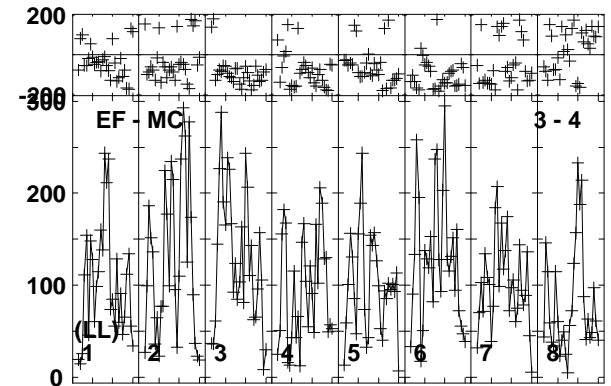
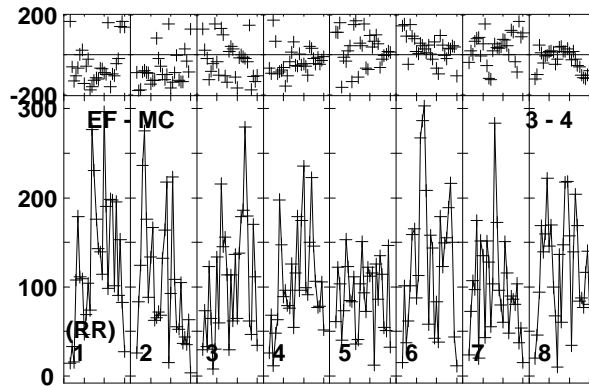
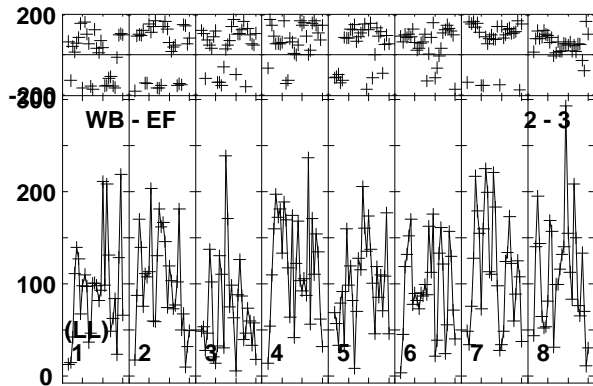
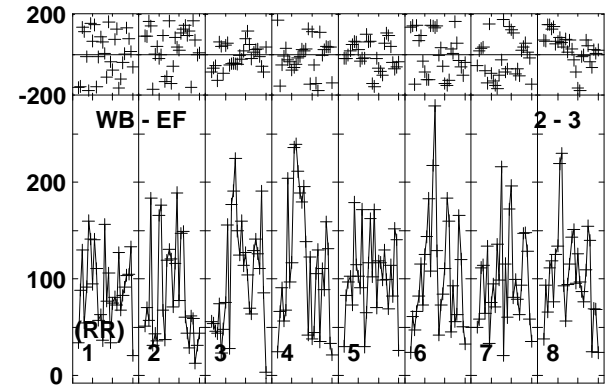
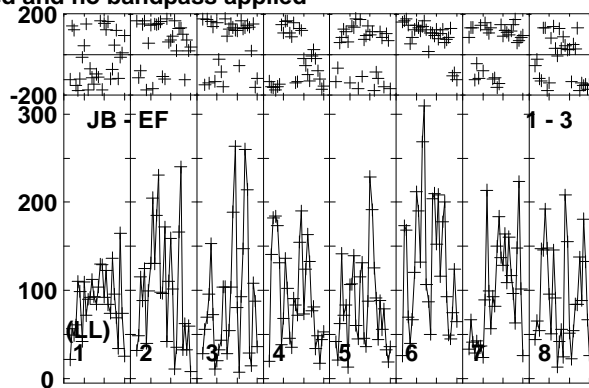
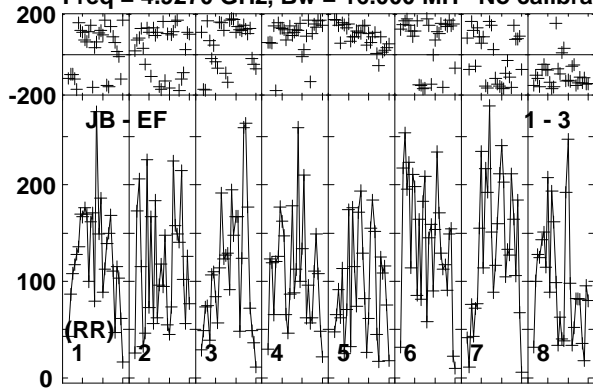

Lower frame: Micro Ampl Jy Top frame: Phas deg  
Vector averaged cross-power spectrum Baseline: JB (01) - EF (03)  
Timerange: 00/16:58:31 to 00/17:01:29

Plot file version 869 created 19-DEC-2018 17:59:09  
AT2018\_RY007C.UVDATA.1

Freq = 4.9270 GHz, Bw = 16.000 MH No calibration applied and no bandpass applied

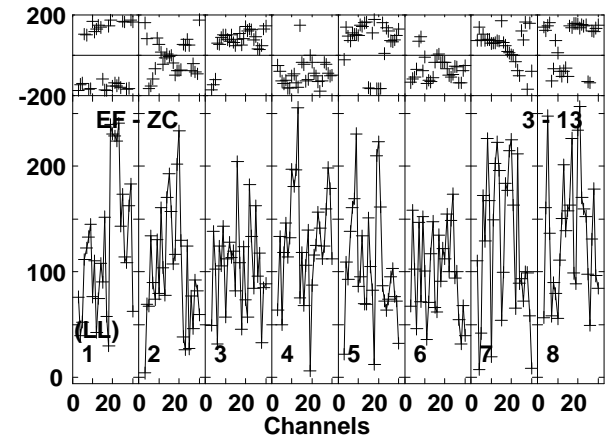
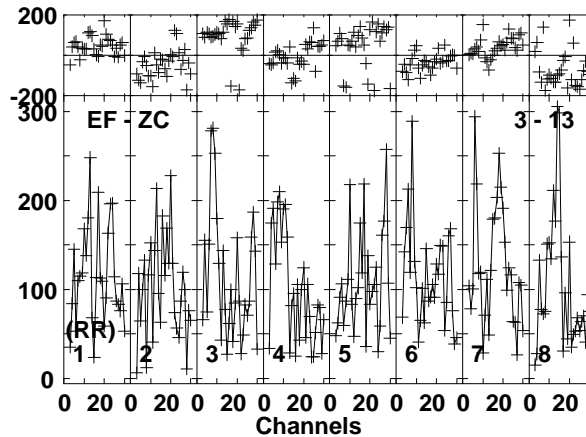
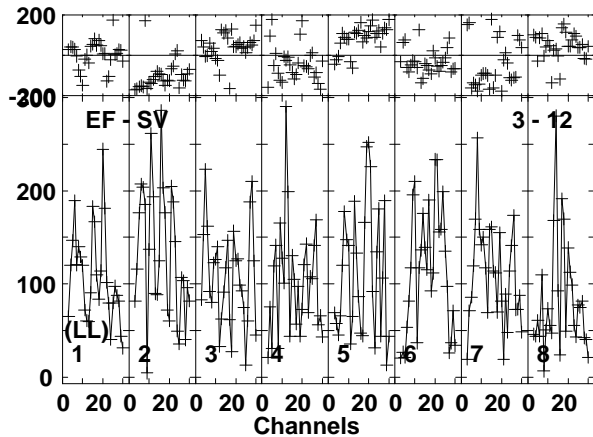
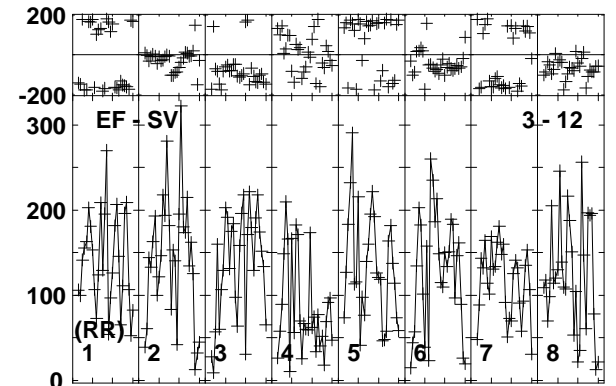
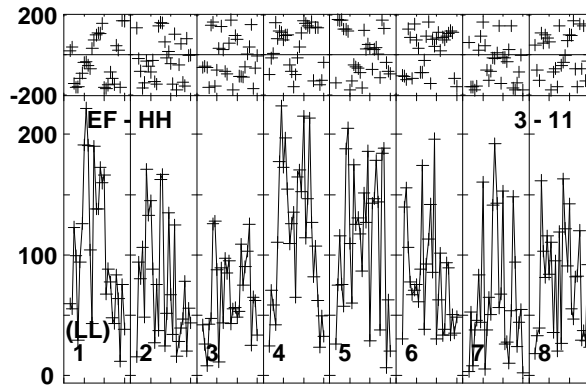
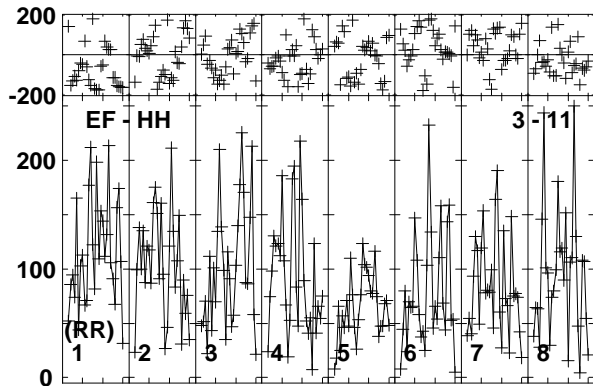
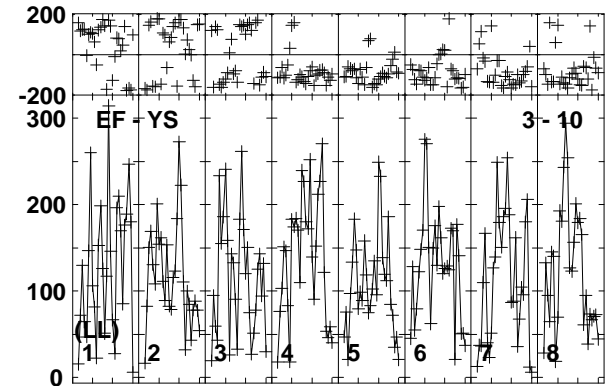
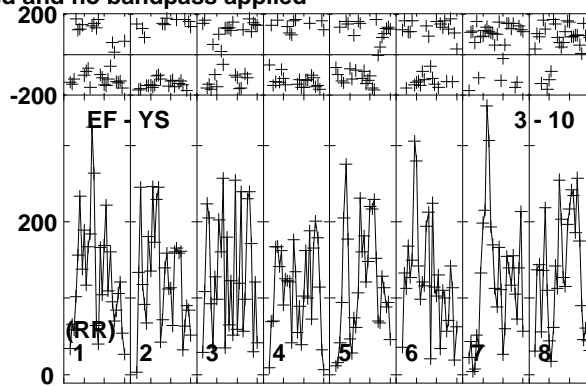
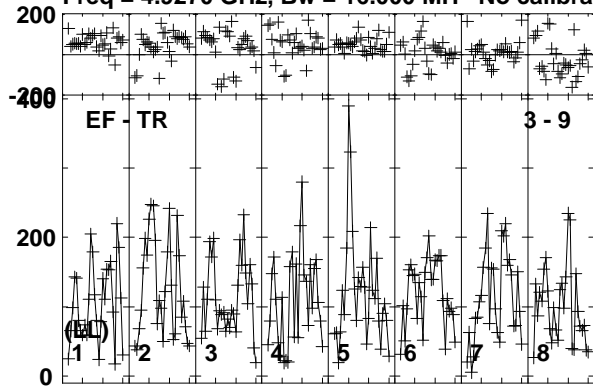

Lower frame: Micro Ampl Jy Top frame: Phas deg  
Vector averaged cross-power spectrum Baseline: EF (03) - TR (09)  
Timerange: 00/16:58:31 to 00/17:01:29

Plot file version 870 created 19-DEC-2018 17:59:09

AT2018\_RY007C.UVDATA.1

Freq = 4.9270 GHz, Bw = 16.000 MH No calibration applied and no bandpass applied

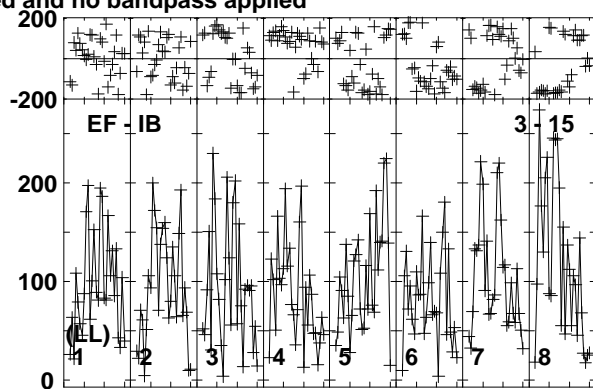
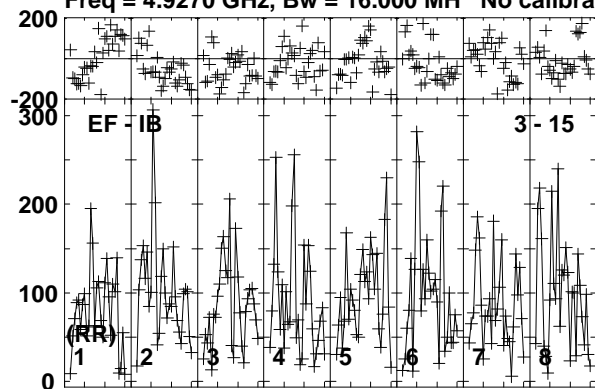

Lower frame: Micro Ampl Jy Top frame: Phas deg  
Vector averaged cross-power spectrum Baseline: EF (03) - IB (15)  
Timerange: 00/16:58:31 to 00/17:01:29

Plot file version 871 created 19-DEC-2018 17:59:09

J1619+2247 RY007C.UVDATA.1

Freq = 4.9270 GHz, Bw = 16.000 MH No calibration applied and no bandpass applied

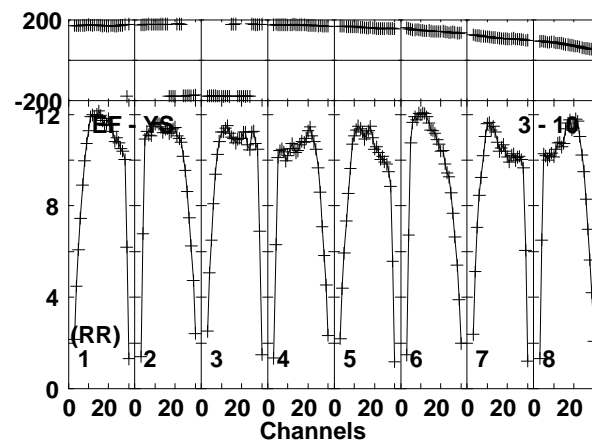
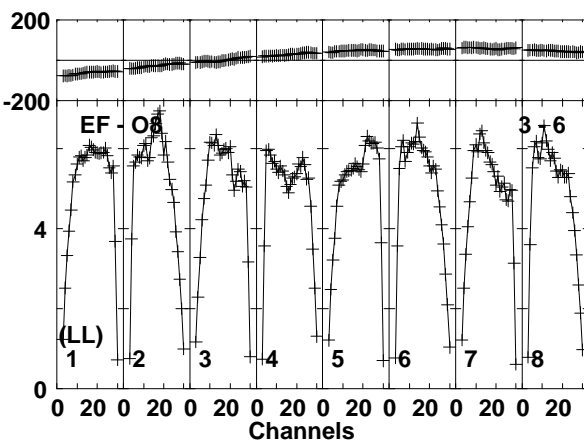
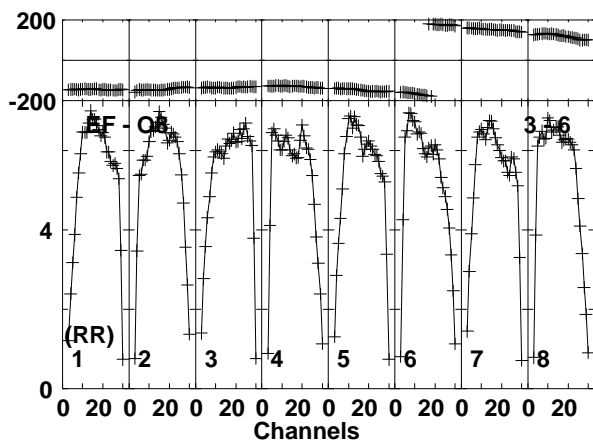
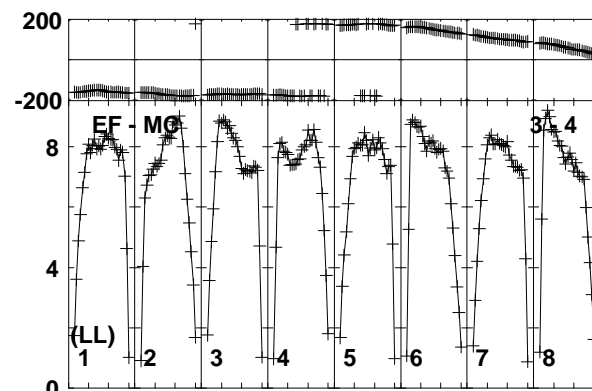
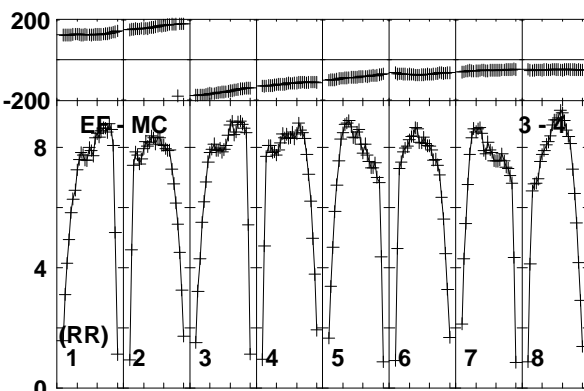
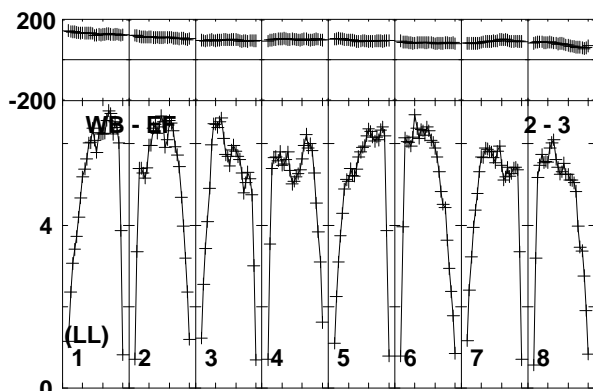
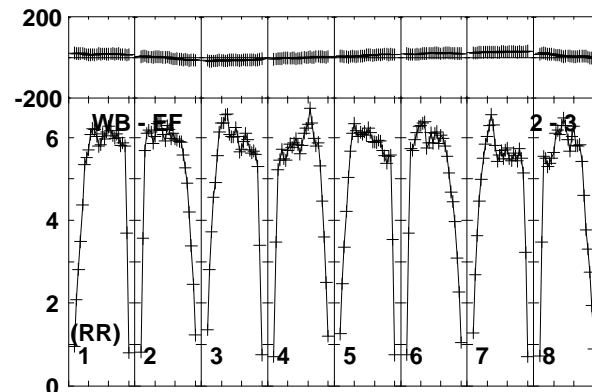
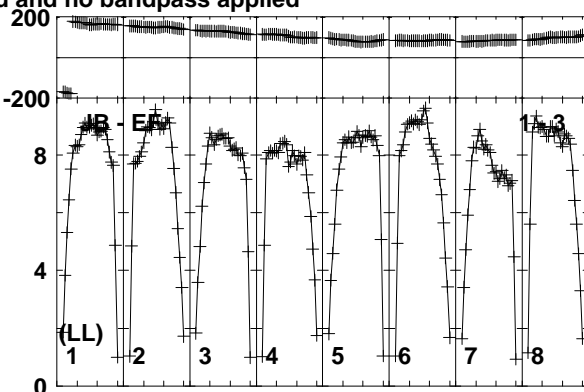
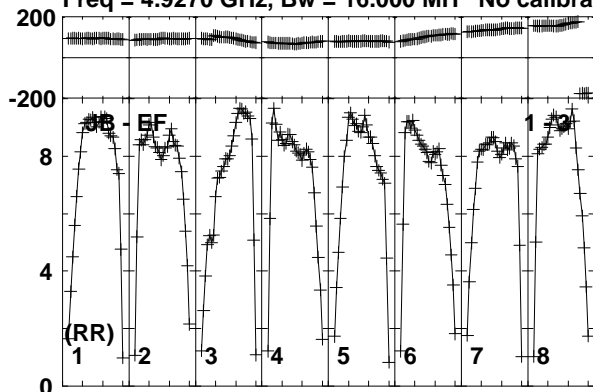

Lower frame: Milli Ampl Jy Top frame: Phas deg  
Vector averaged cross-power spectrum Baseline: JB (01) - EF (03)  
Timerange: 00/17:01:31 to 00/17:02:29

Plot file version 872 created 19-DEC-2018 17:59:09

J1619+2247 RY007C.UVDATA.1

Freq = 4.9270 GHz, Bw = 16.000 MH No calibration applied and no bandpass applied

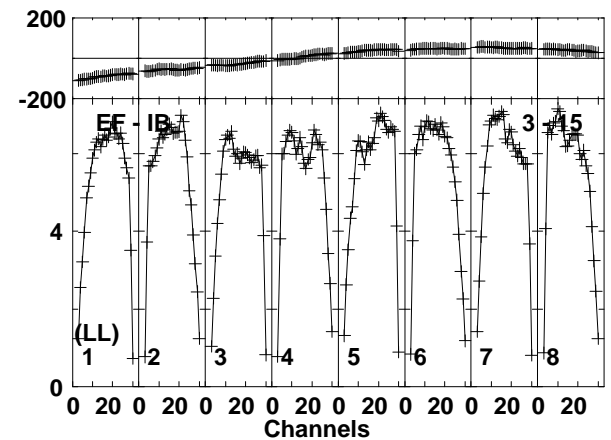
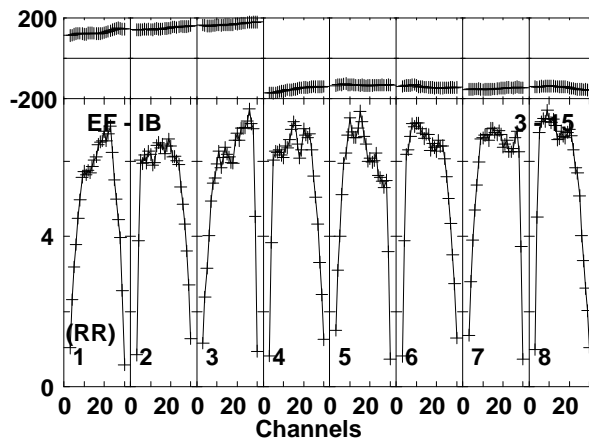
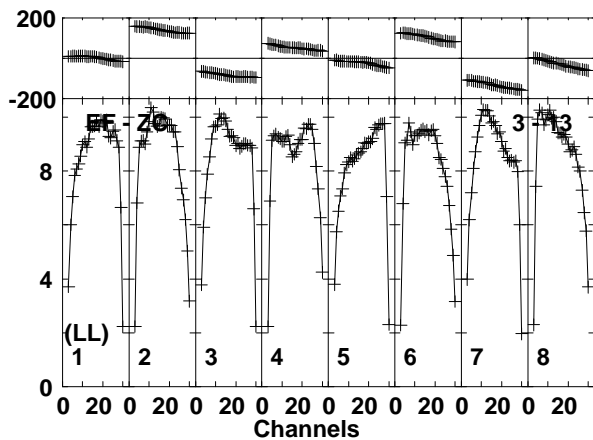
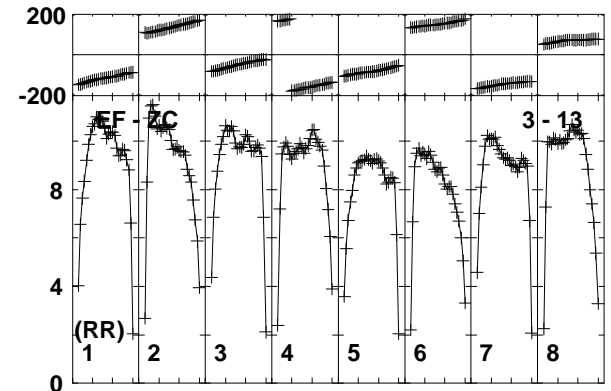
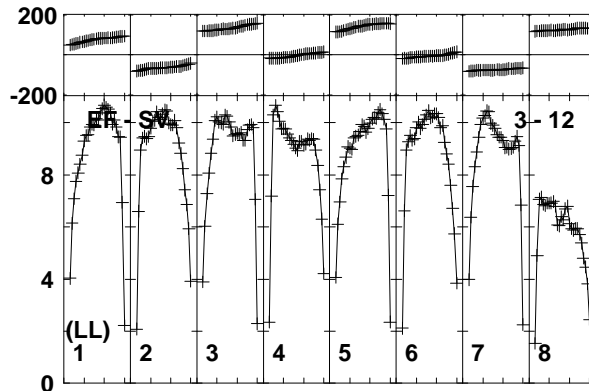
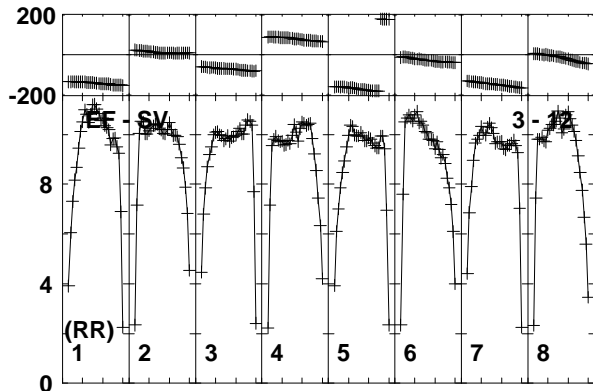
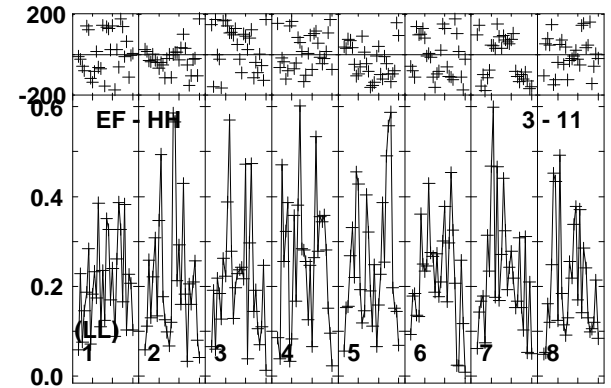
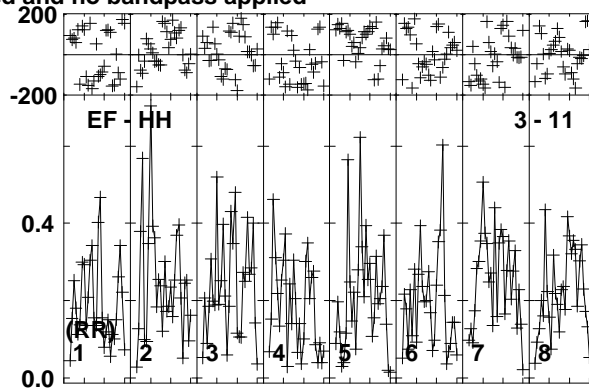
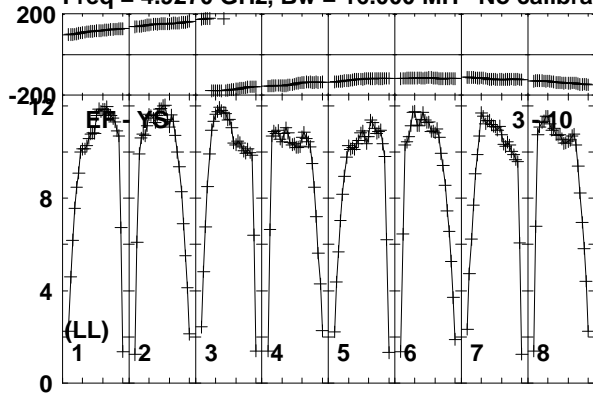

Lower frame: Milli Ampl Jy Top frame: Phas deg  
Vector averaged cross-power spectrum Baseline: EF (03) - YS (10)  
Timerange: 00:17:01:31 to 00:17:02:29

Plot file version 873 created 19-DEC-2018 17:59:09

VLA1 RY007C.UVDATA.1

Freq = 4.9270 GHz, Bw = 16.000 MH No calibration applied and no bandpass applied

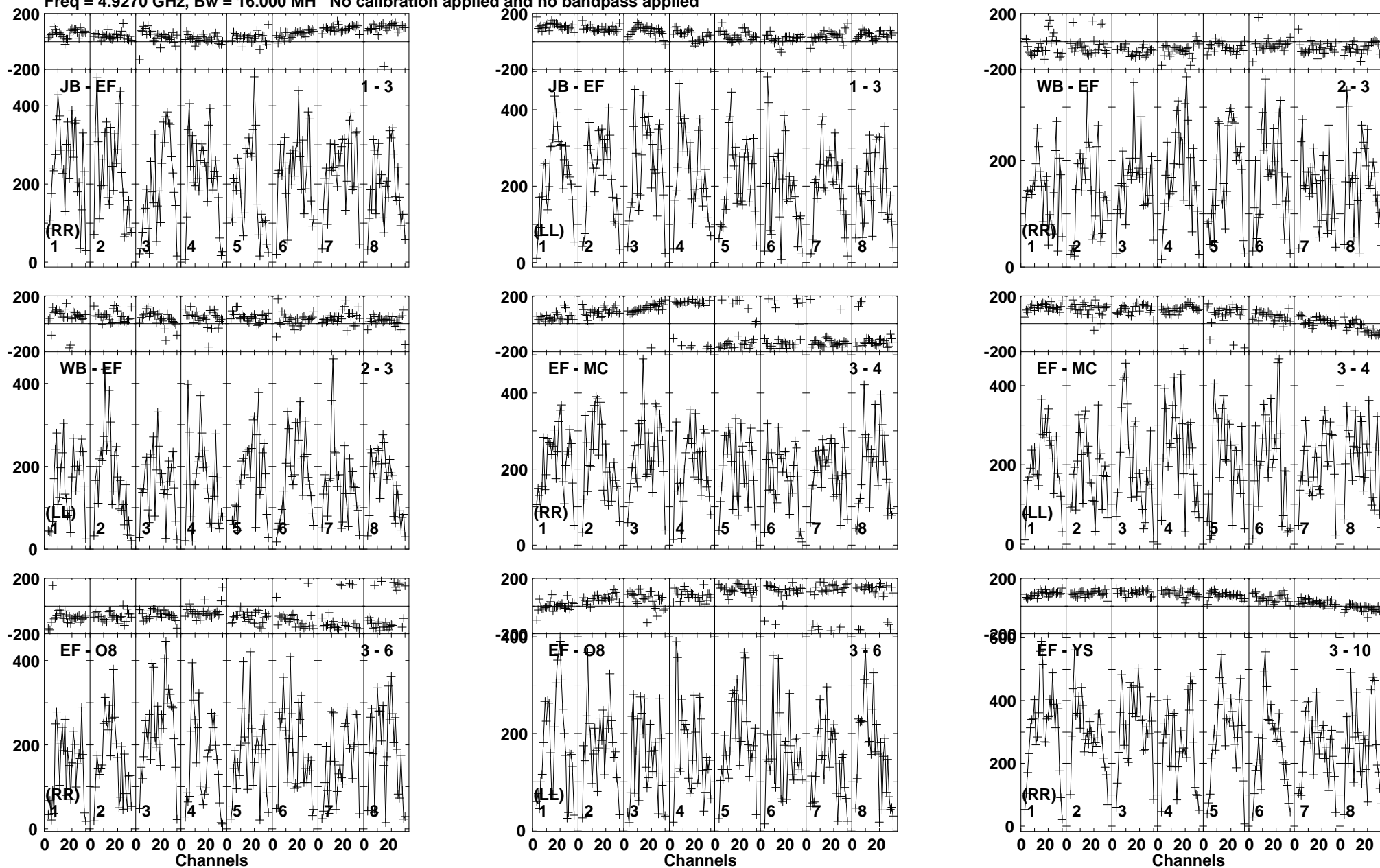

Lower frame: Micro Ampl Jy Top frame: Phas deg  
Vector averaged cross-power spectrum Baseline: JB (01) - EF (03)  
Timerange: 00/17:03:01 to 00/17:04:59

Plot file version 874 created 19-DEC-2018 17:59:09

VLA1 RY007C.UVDATA.1

Freq = 4.9270 GHz, Bw = 16.000 MH No calibration applied and no bandpass applied

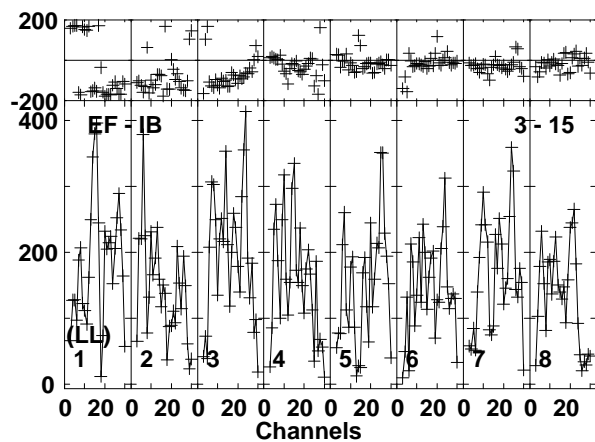
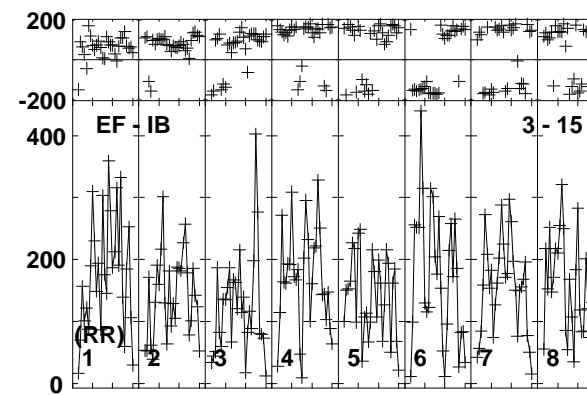
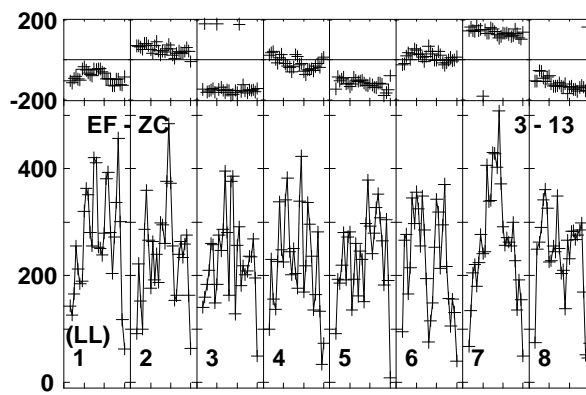
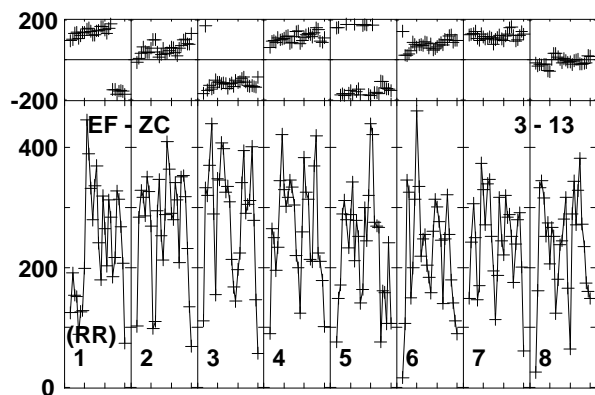
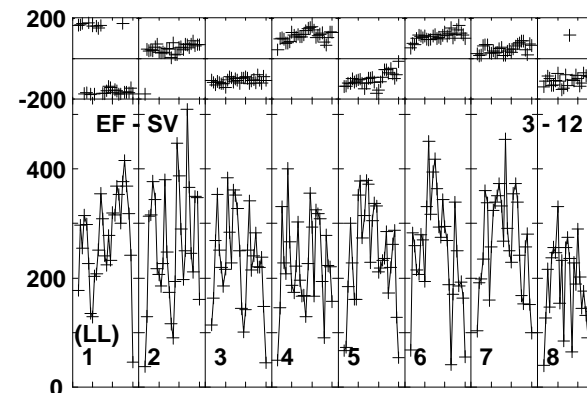
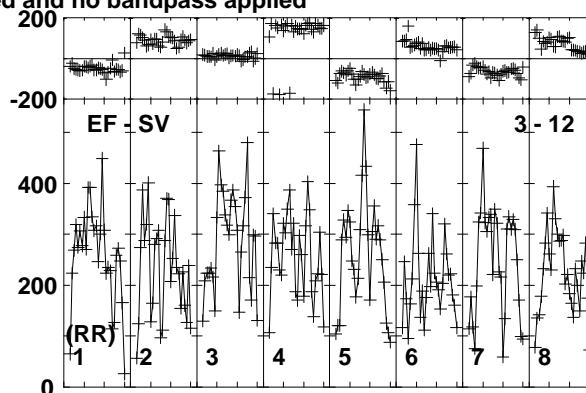
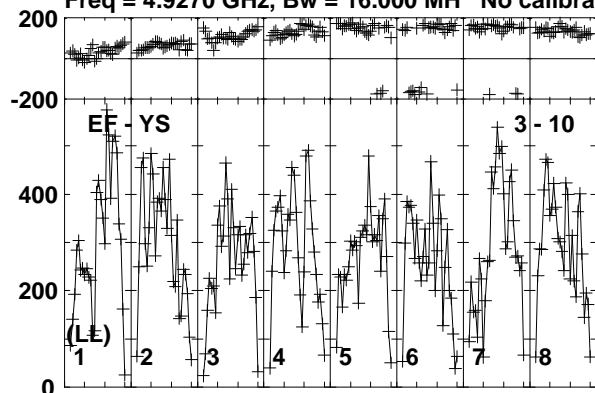

Lower frame: Micro Ampl Jy Top frame: Phas deg  
Vector averaged cross-power spectrum Baseline: EF (03) - YS (10)  
Timerange: 00/17:03:01 to 00/17:04:59



Plot file version 875 created 19-DEC-2018 17:59:09

J1619+2247 RY007C.UVDATA.1

Freq = 4.9270 GHz, Bw = 16.000 MH No calibration applied and no bandpass applied

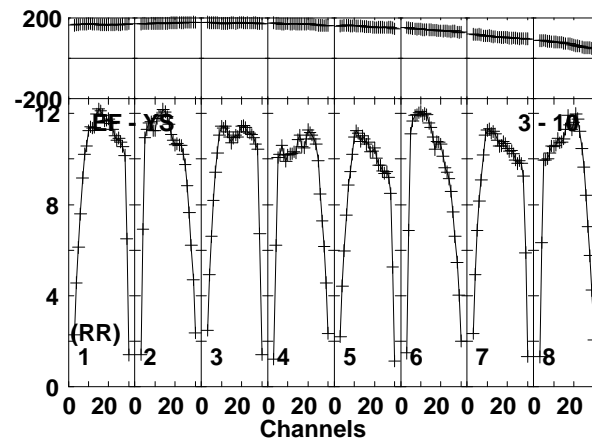
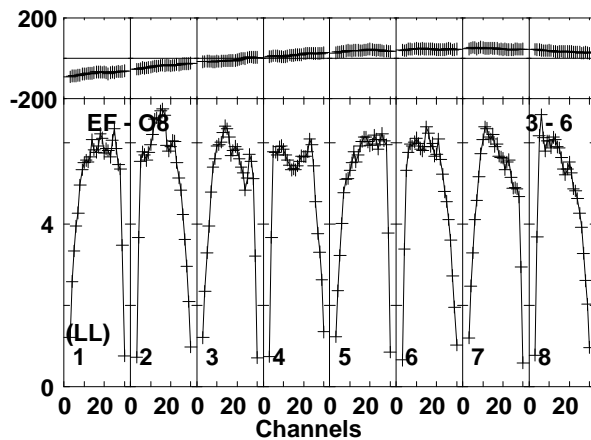
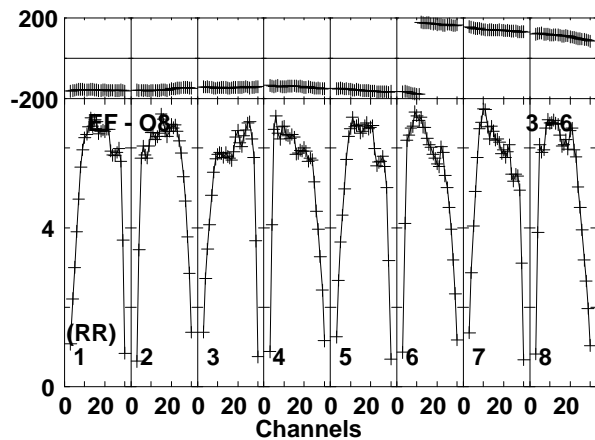
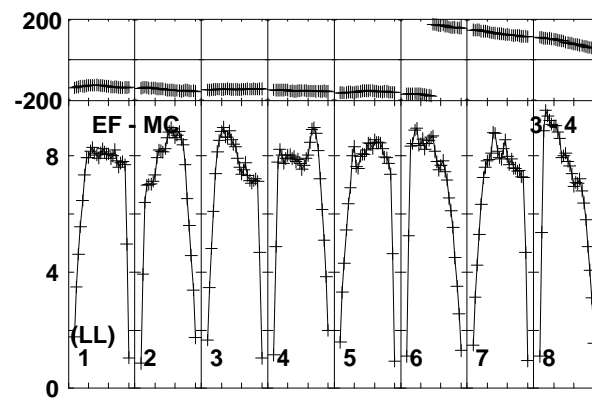
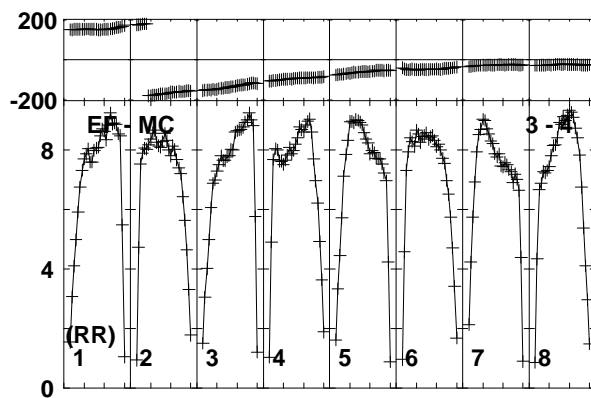
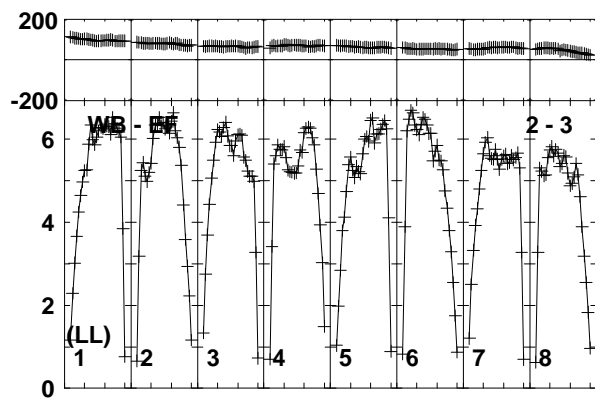
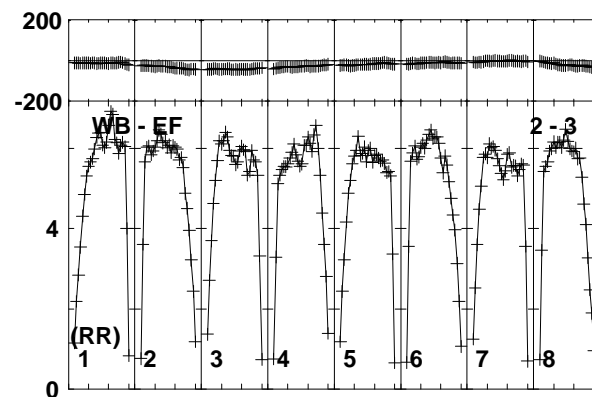
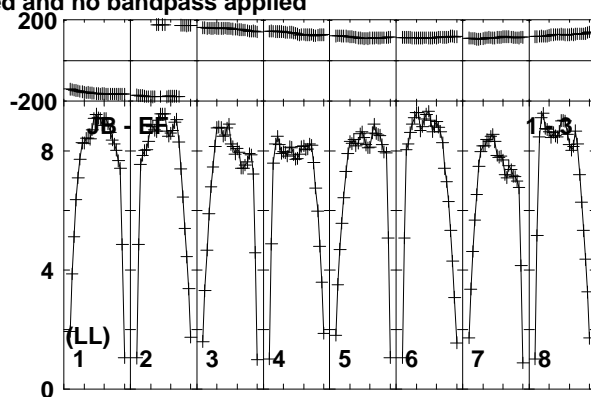
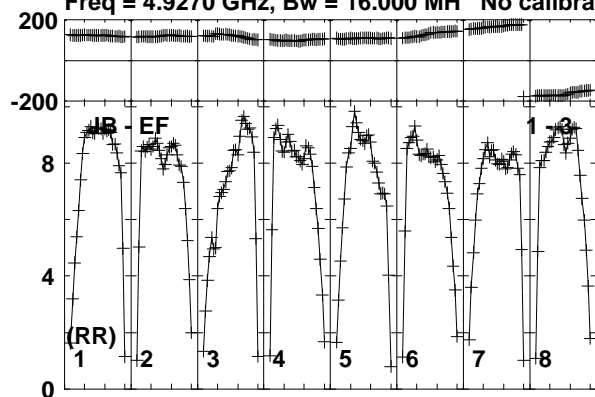

Lower frame: Milli Ampl Jy Top frame: Phas deg  
Vector averaged cross-power spectrum Baseline: JB (01) - EF (03)  
Timerange: 00/17:05:01 to 00/17:05:59

Plot file version 876 created 19-DEC-2018 17:59:09

J1619+2247 RY007C.UVDATA.1

Freq = 4.9270 GHz, Bw = 16.000 MH No calibration applied and no bandpass applied

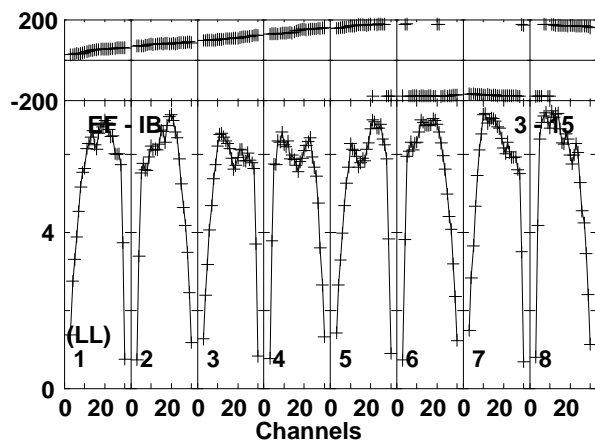
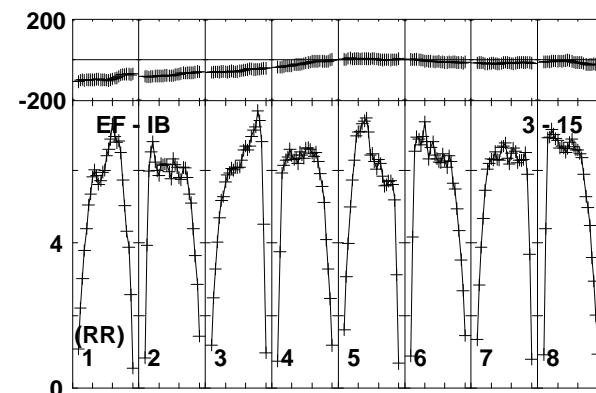
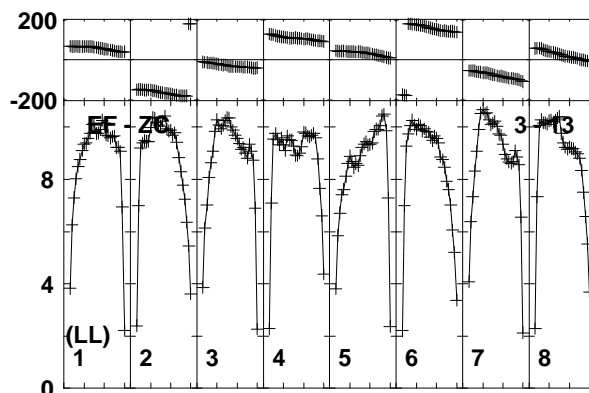
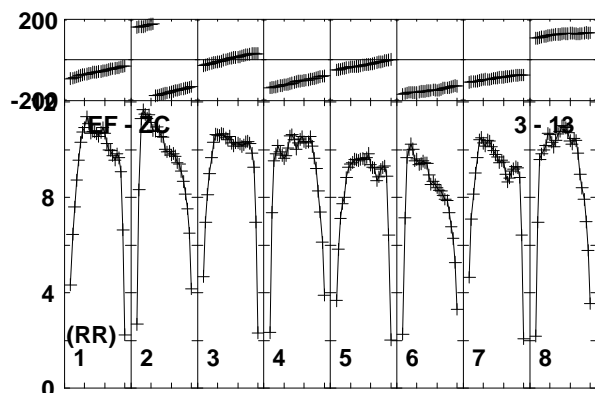
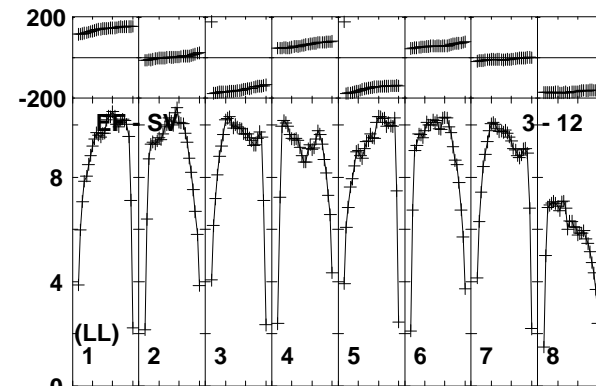
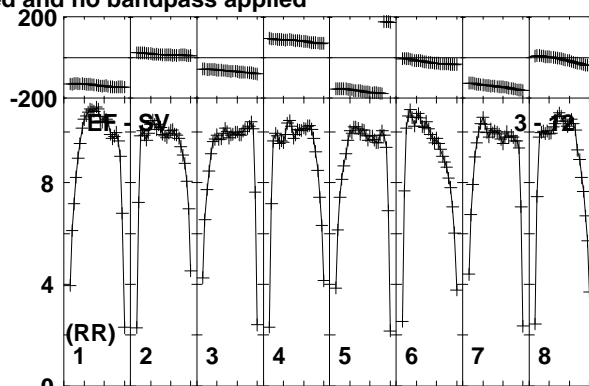
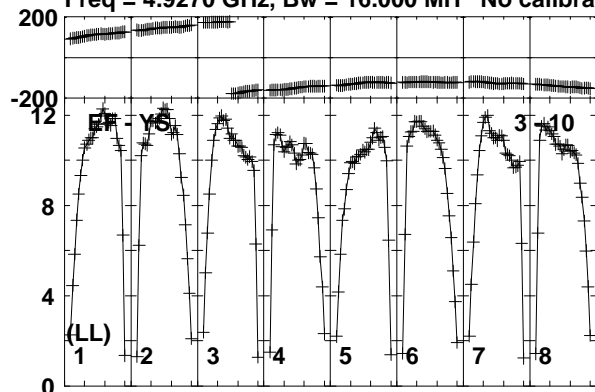

Lower frame: Milli Ampl Jy Top frame: Phas deg  
Vector averaged cross-power spectrum Baseline: EF (03) - YS (10)  
Timerange: 00/17:05:01 to 00/17:05:59

Plot file version 877 created 19-DEC-2018 17:59:09  
AT2018\_RY007C.UVDATA.1

Freq = 4.9270 GHz, Bw = 16.000 MH No calibration applied and no bandpass applied

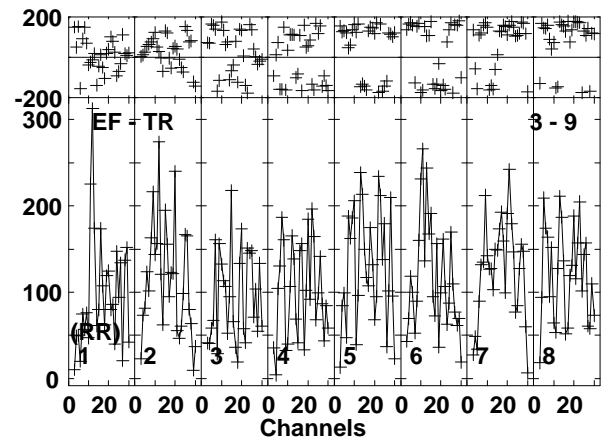
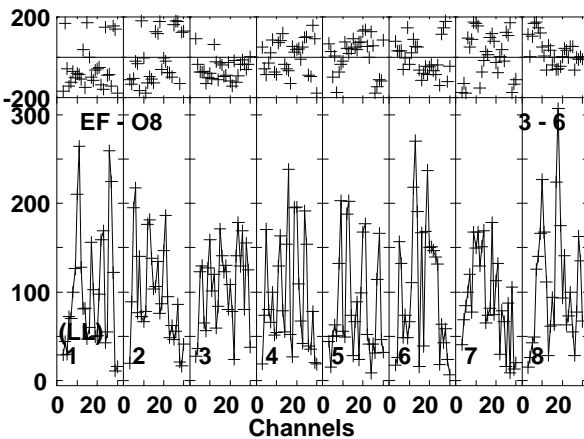
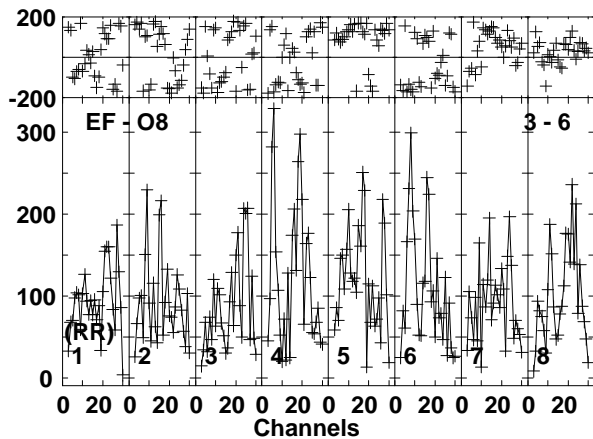
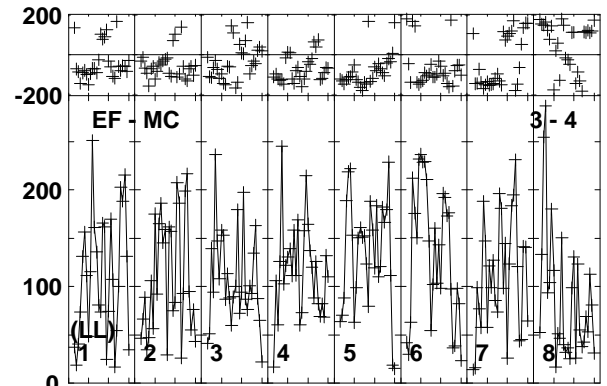
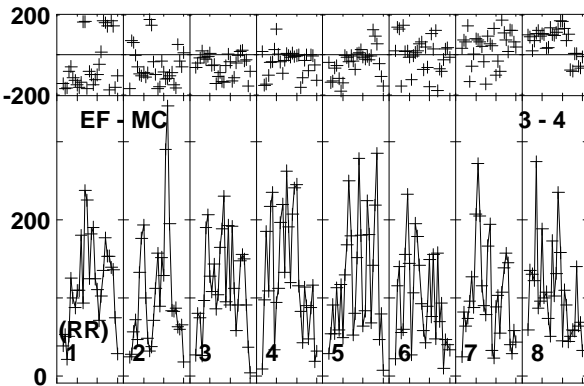
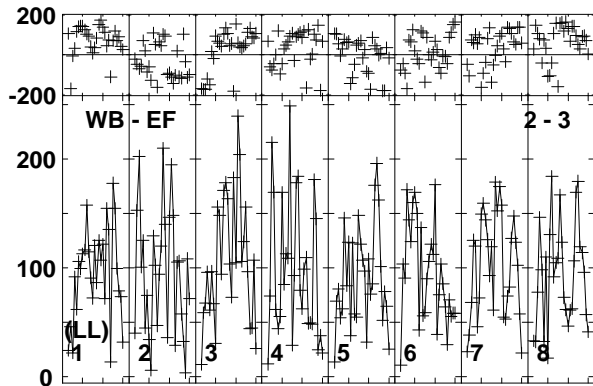
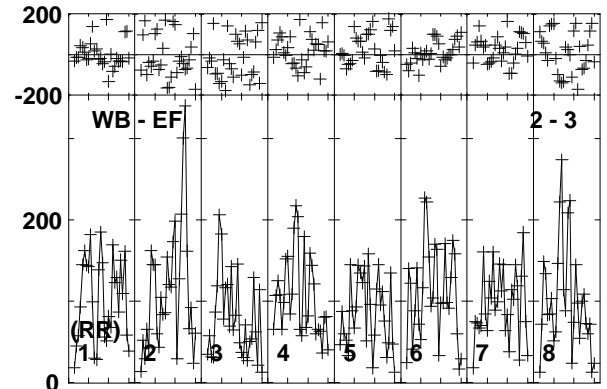
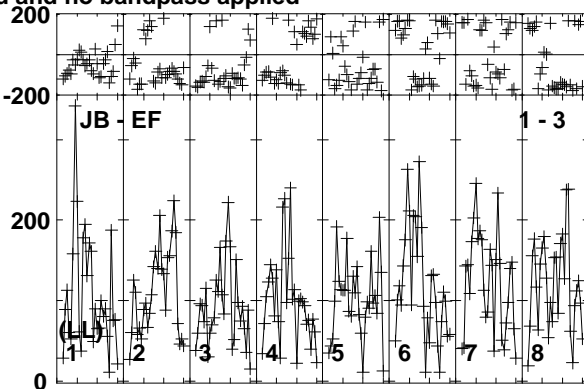
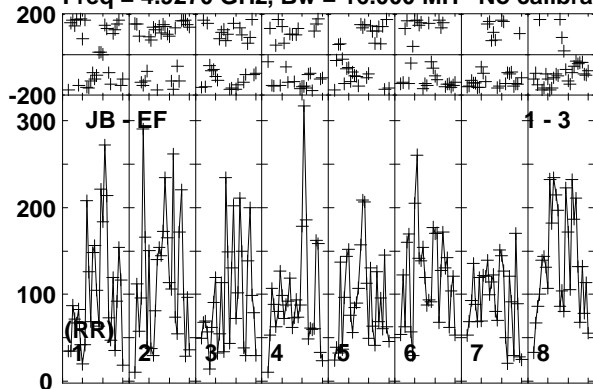

Lower frame: Micro Ampl Jy Top frame: Phas deg  
Vector averaged cross-power spectrum Baseline: JB (01) - EF (03)  
Timerange: 00/17:06:01 to 00/17:08:59

Plot file version 878 created 19-DEC-2018 17:59:09

AT2018\_RY007C.UVDATA.1

Freq = 4.9270 GHz, Bw = 16.000 MH No calibration applied and no bandpass applied

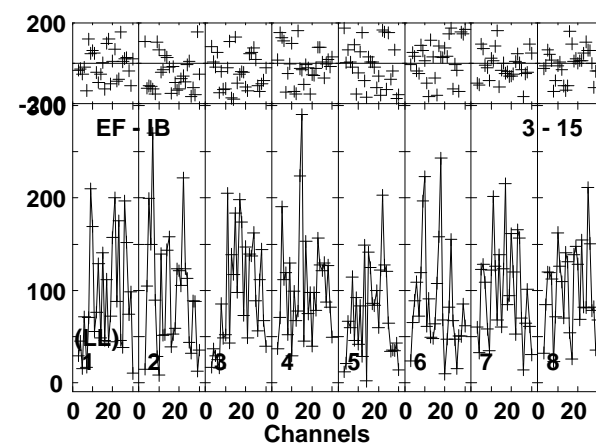
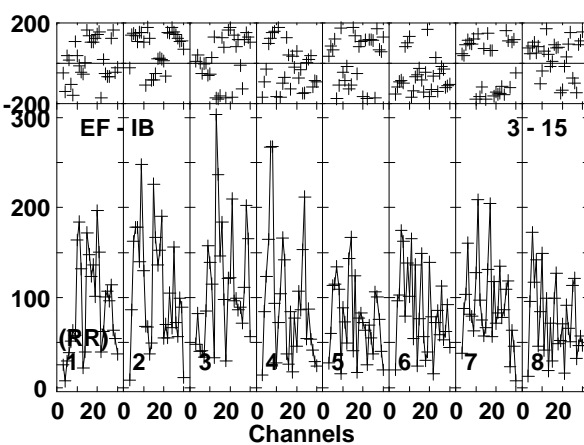
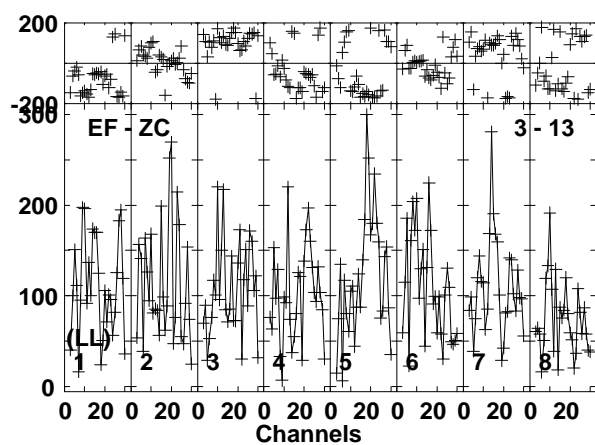
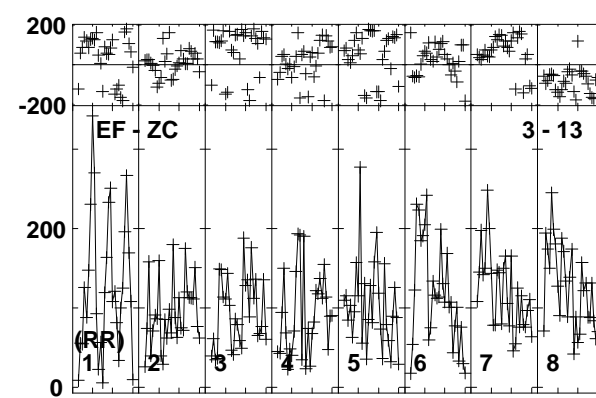
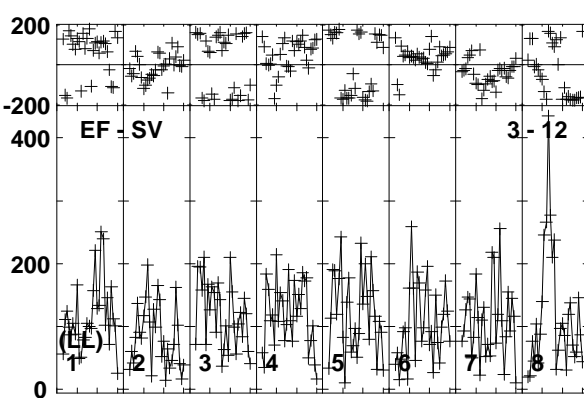
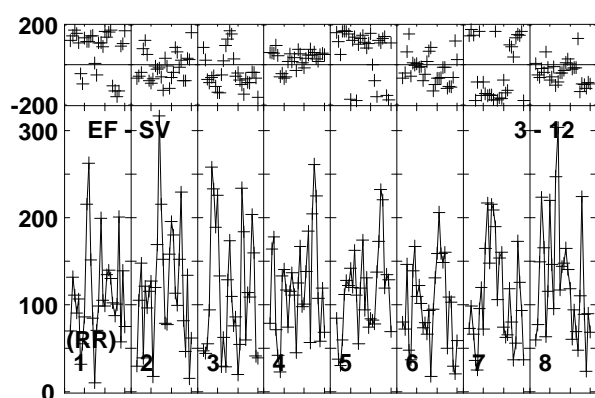
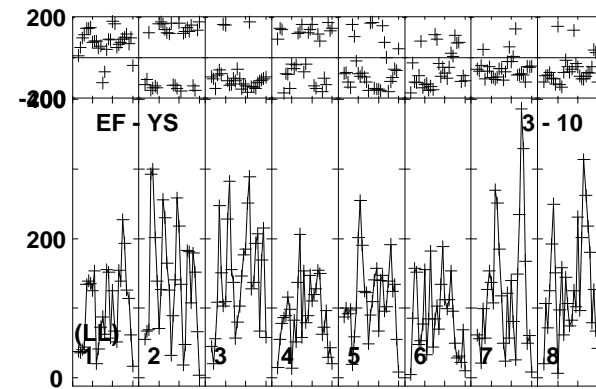
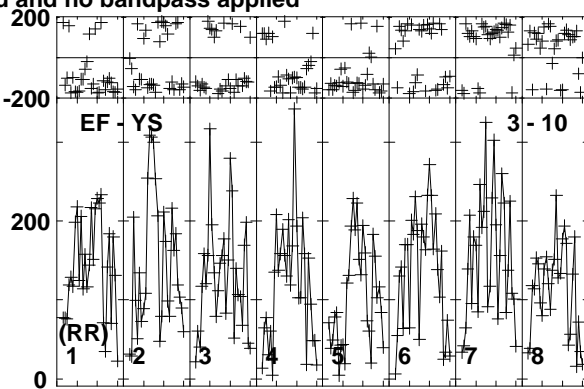
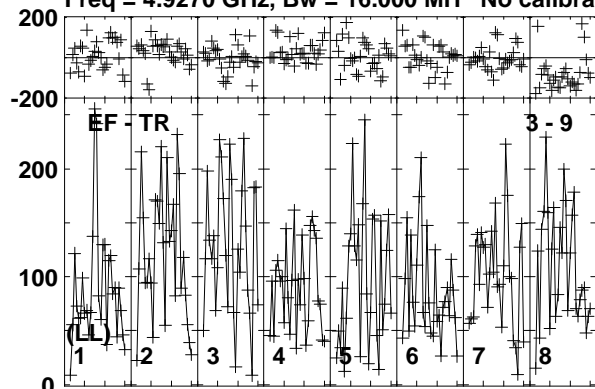

Lower frame: Micro Ampl Jy Top frame: Phas deg  
Vector averaged cross-power spectrum Baseline: EF (03) - TR (09)  
Timerange: 00/17:06:01 to 00/17:08:59

Plot file version 879 created 19-DEC-2018 17:59:10

J1619+2247 RY007C.UVDATA.1

Freq = 4.9270 GHz, Bw = 16.000 MH No calibration applied and no bandpass applied

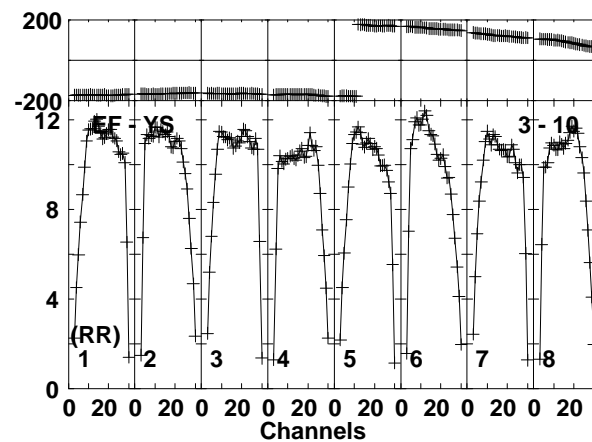
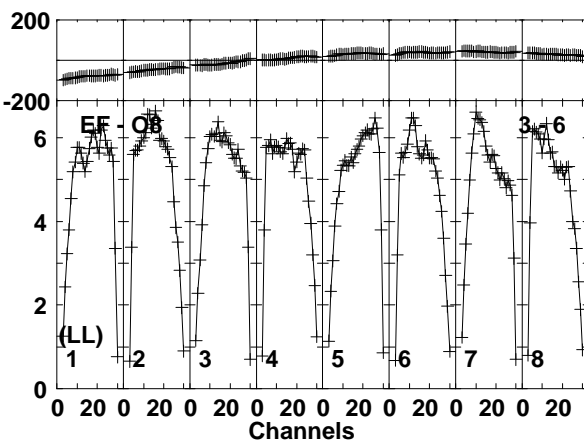
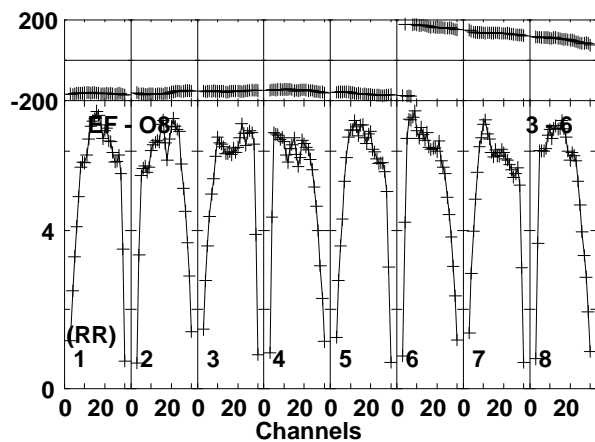
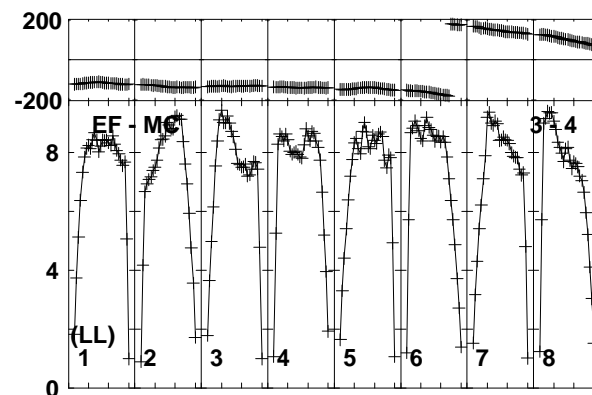
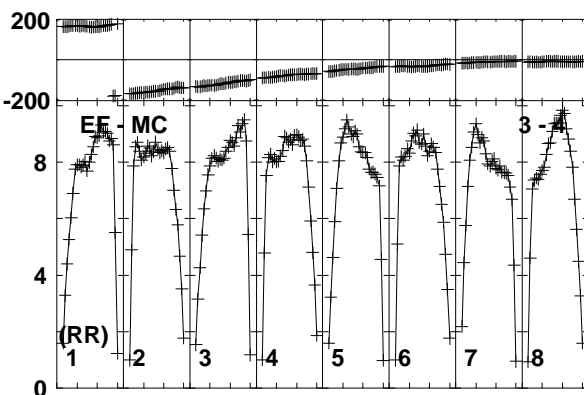
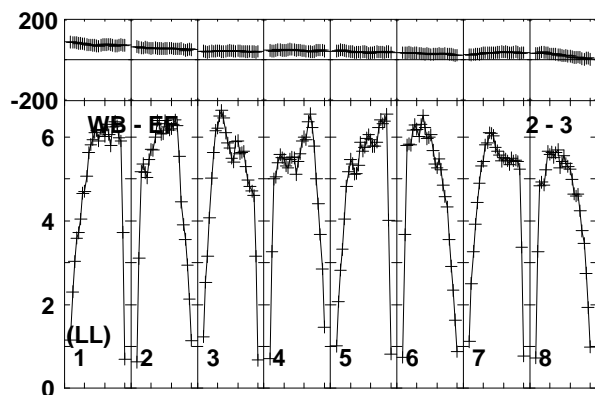
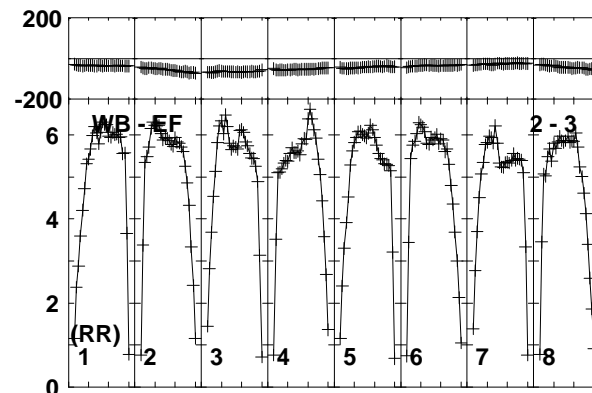
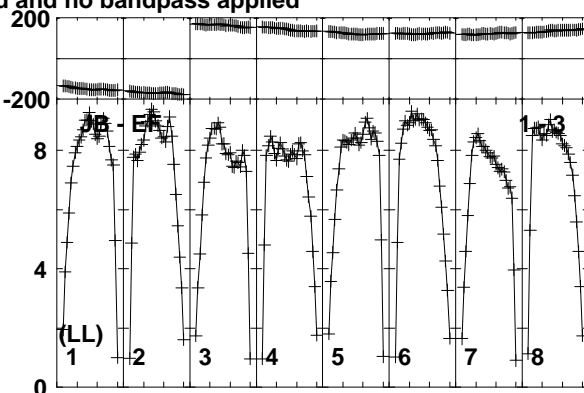
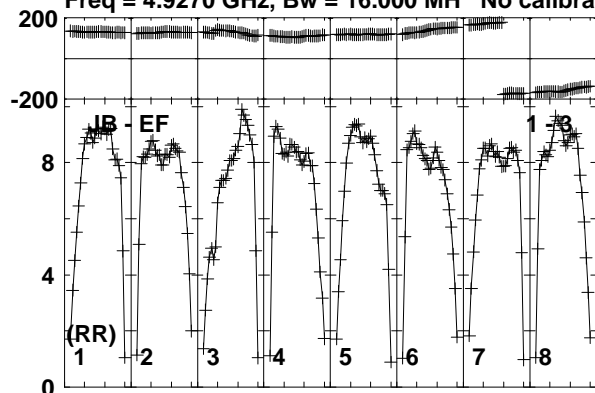

Lower frame: Milli Ampl Jy Top frame: Phas deg  
Vector averaged cross-power spectrum Baseline: JB (01) - EF (03)  
Timerange: 00/17:09:01 to 00/17:09:59

Plot file version 880 created 19-DEC-2018 17:59:10

J1619+2247 RY007C.UVDATA.1

Freq = 4.9270 GHz, Bw = 16.000 MH No calibration applied and no bandpass applied

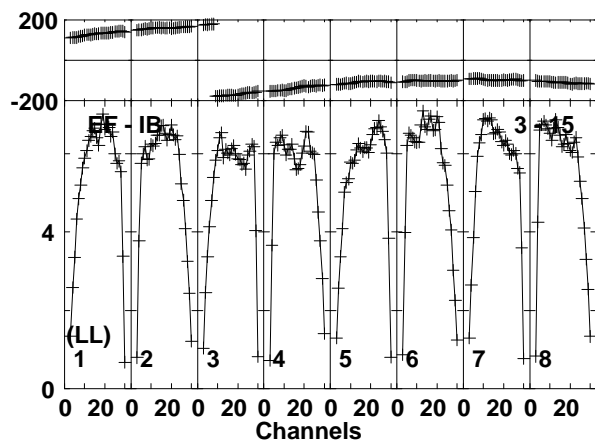
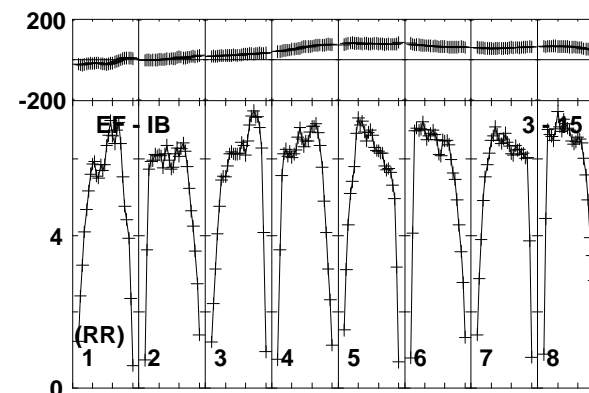
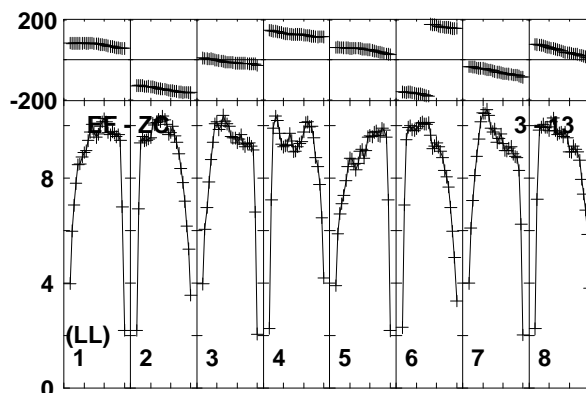
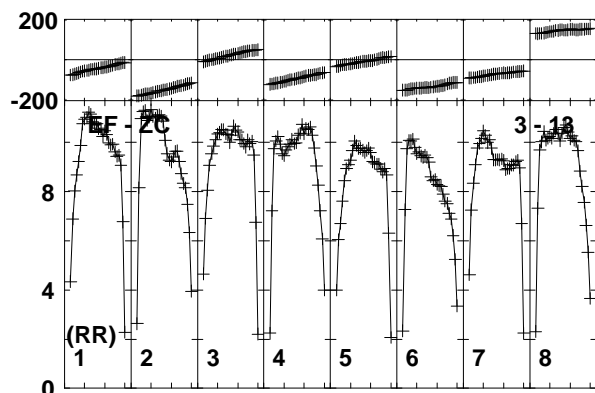
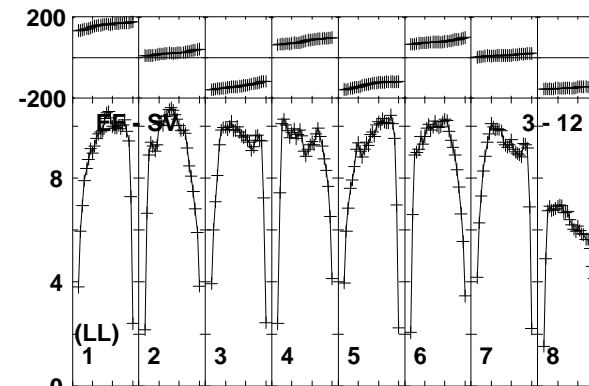
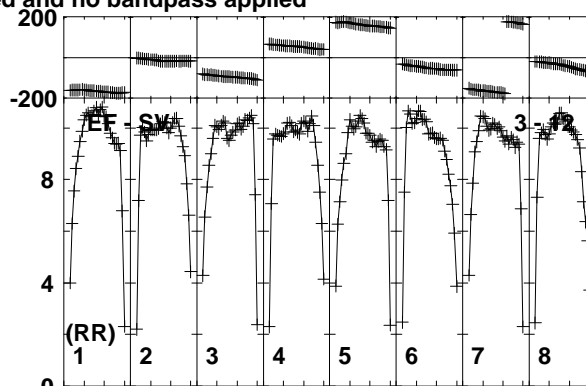
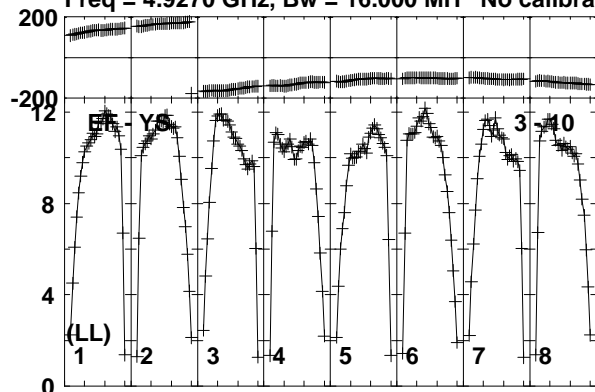

Lower frame: Milli Ampl Jy Top frame: Phas deg  
Vector averaged cross-power spectrum Baseline: EF (03) - YS (10)  
Timerange: 00/17:09:01 to 00/17:09:59

Plot file version 881 created 19-DEC-2018 17:59:10  
AT2018\_RY007C.UVDATA.1

Freq = 4.9270 GHz, Bw = 16.000 MH No calibration applied and no bandpass applied

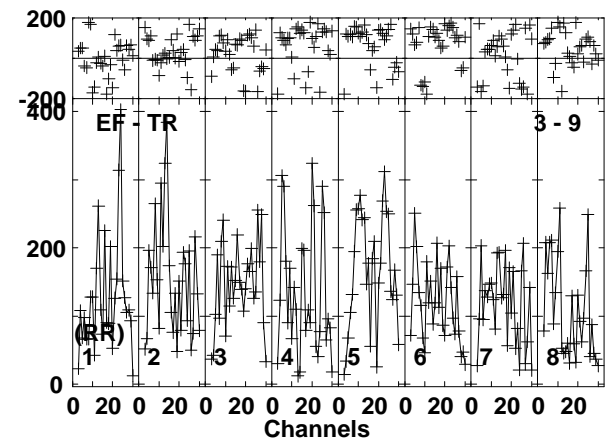
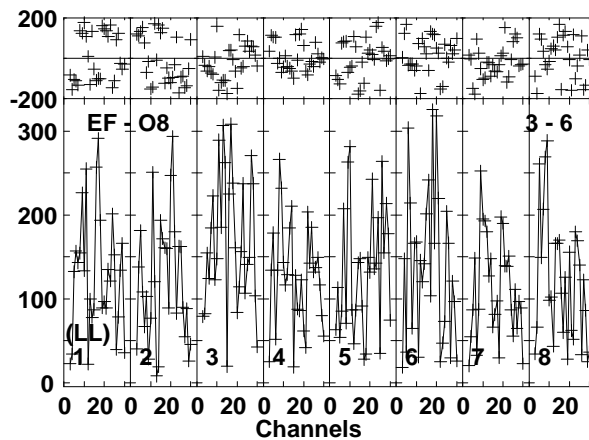
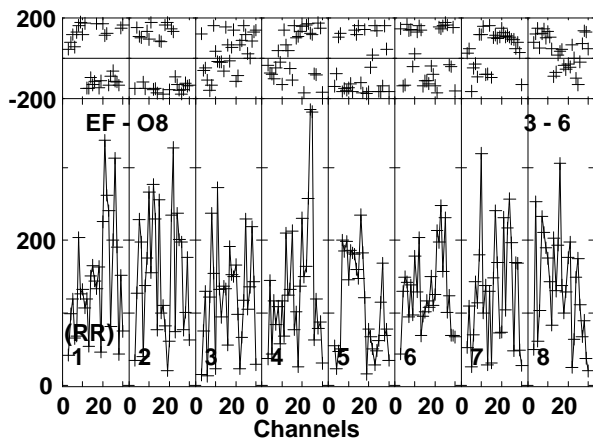
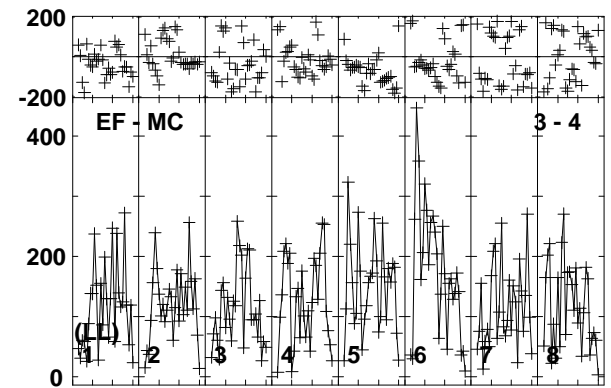
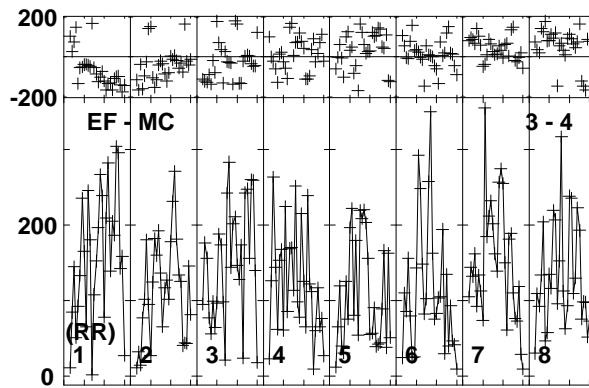
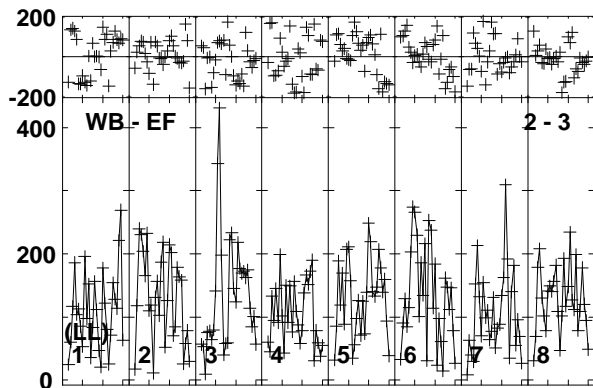
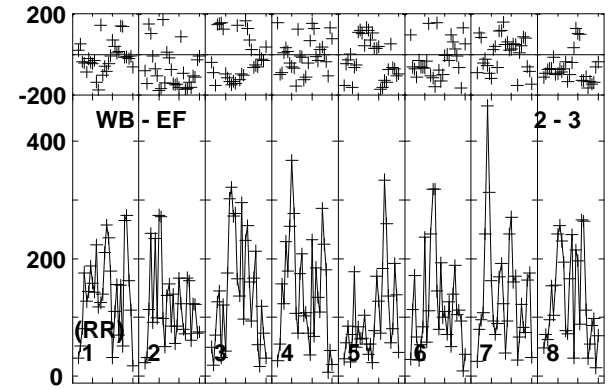
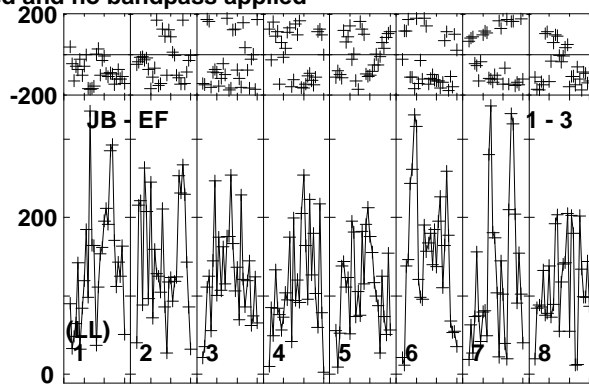
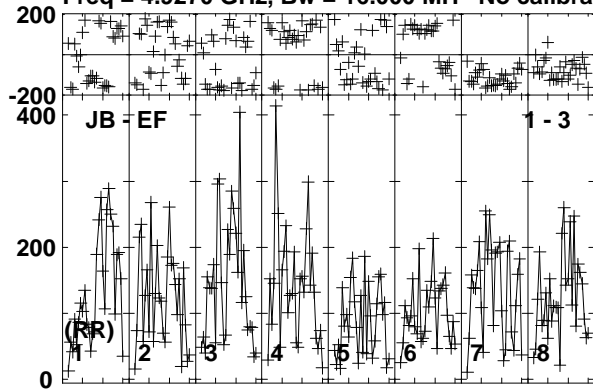

Lower frame: Micro Ampl Jy Top frame: Phas deg  
Vector averaged cross-power spectrum Baseline: JB (01) - EF (03)  
Timerange: 00/17:10:01 to 00/17:11:59

Plot file version 882 created 19-DEC-2018 17:59:10

AT2018\_RY007C.UVDATA.1

Freq = 4.9270 GHz, Bw = 16.000 MH No calibration applied and no bandpass applied

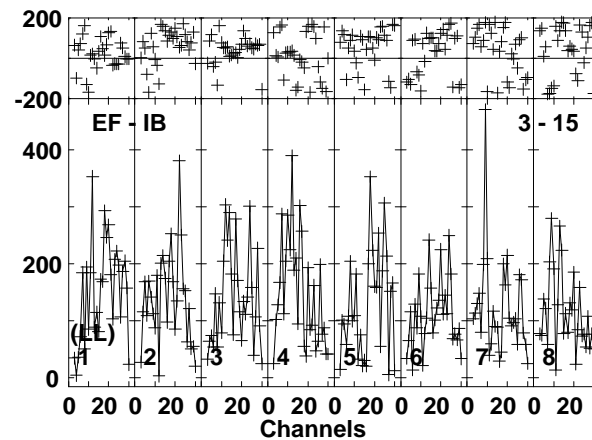
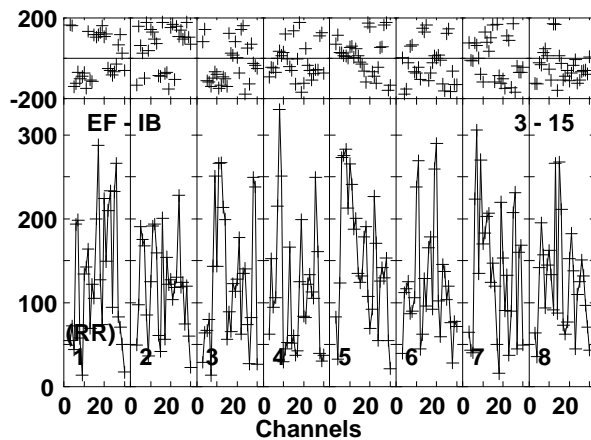
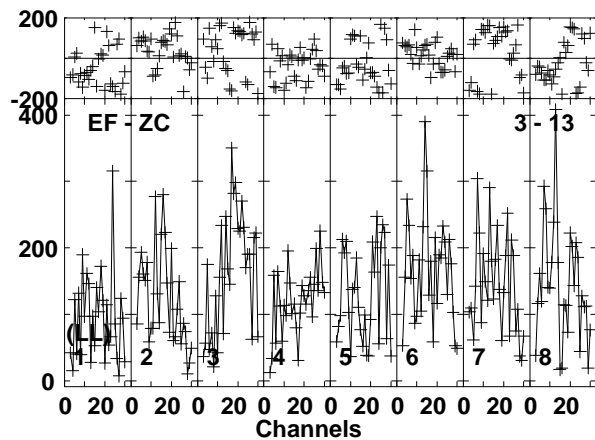
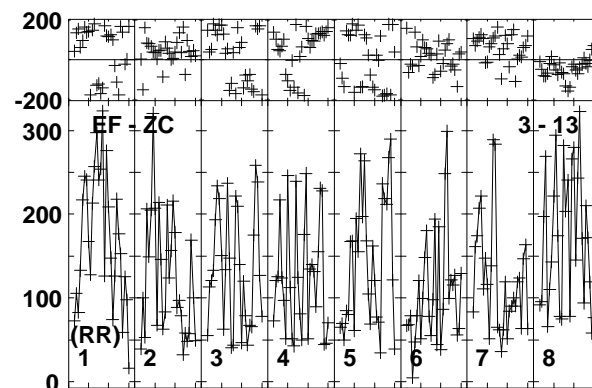
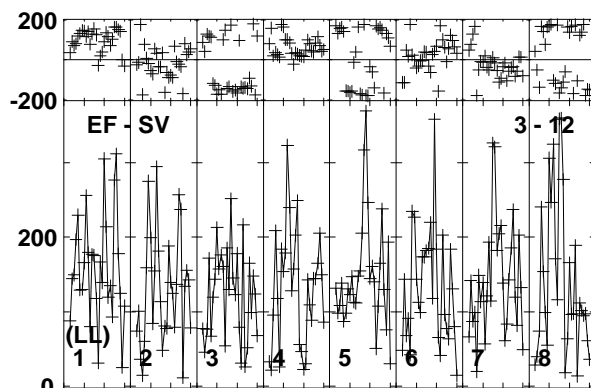
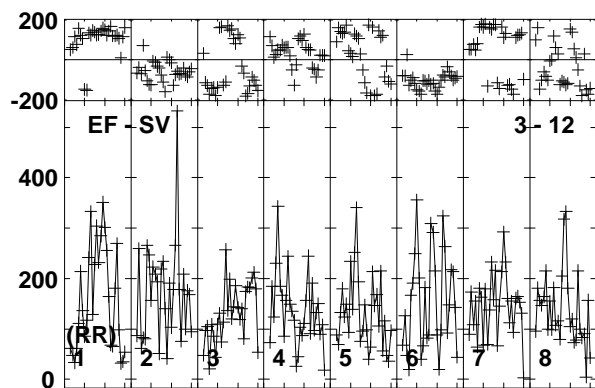
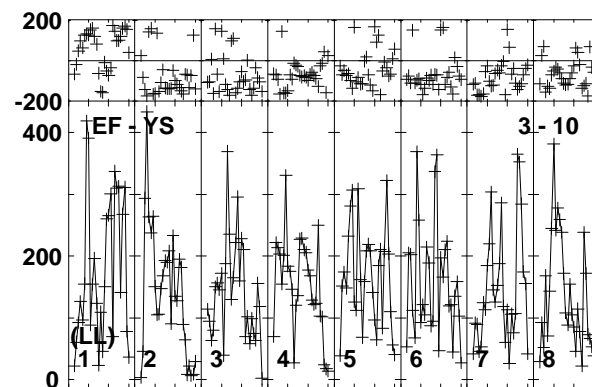
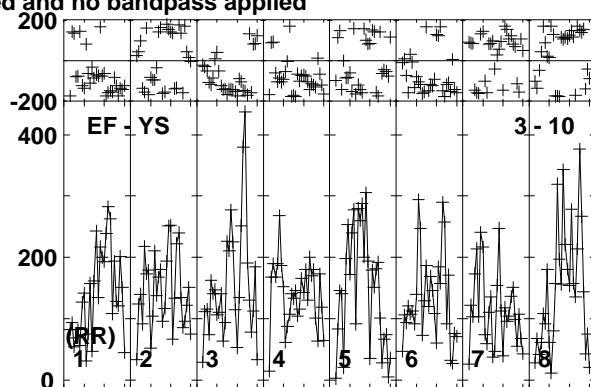
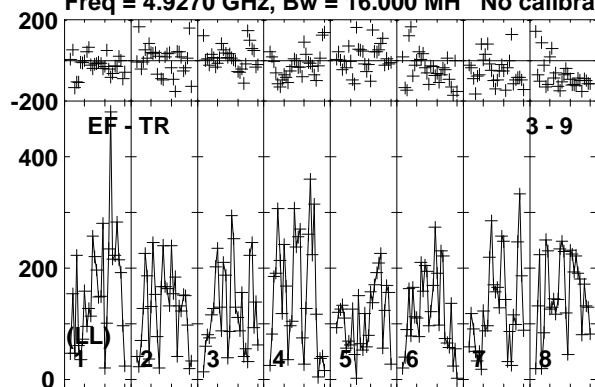

Lower frame: Micro Ampl Jy Top frame: Phas deg  
Vector averaged cross-power spectrum Baseline: EF (03) - TR (09)  
Timerange: 00/17:10:01 to 00/17:11:59



Plot file version 883 created 19-DEC-2018 17:59:10

VLA2 RY007C.UVDATA.1

Freq = 4.9270 GHz, Bw = 16.000 MH No calibration applied and no bandpass applied

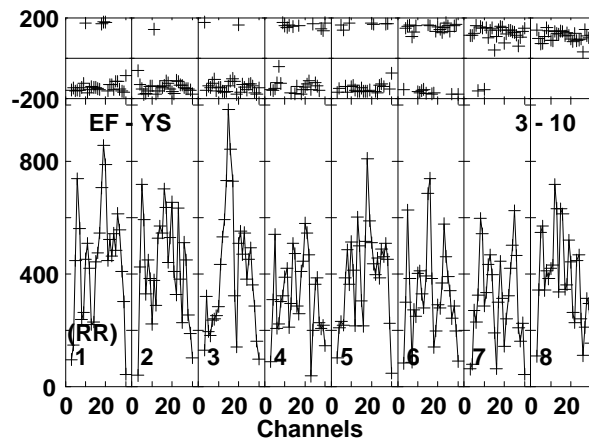
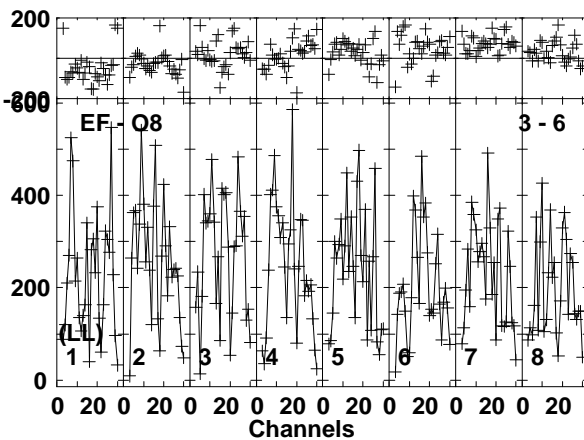
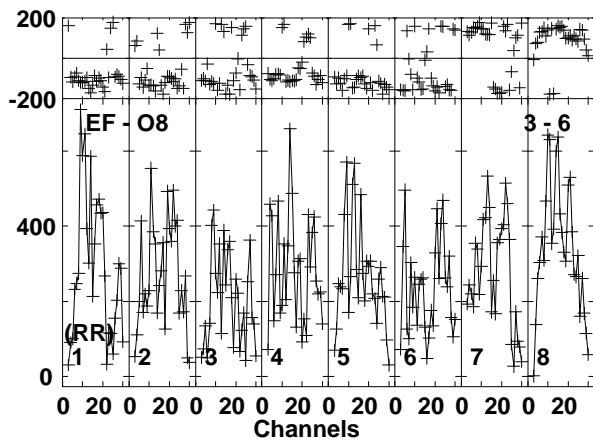
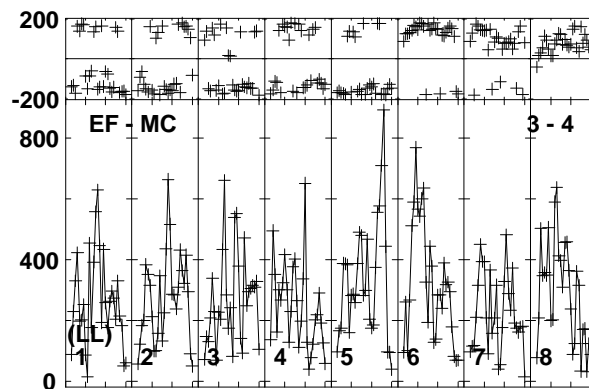
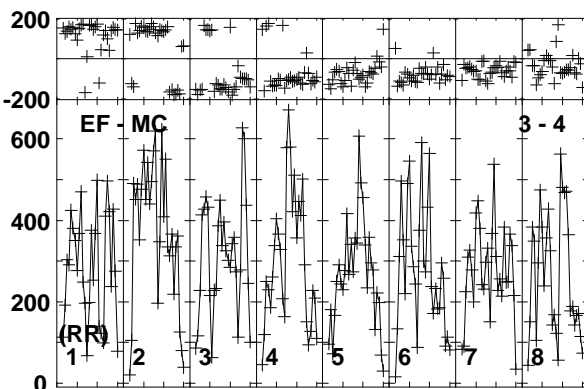
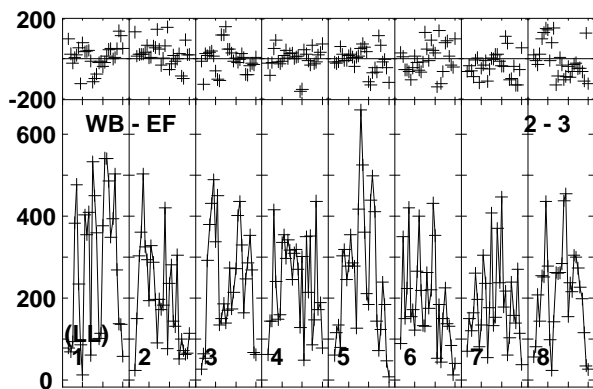
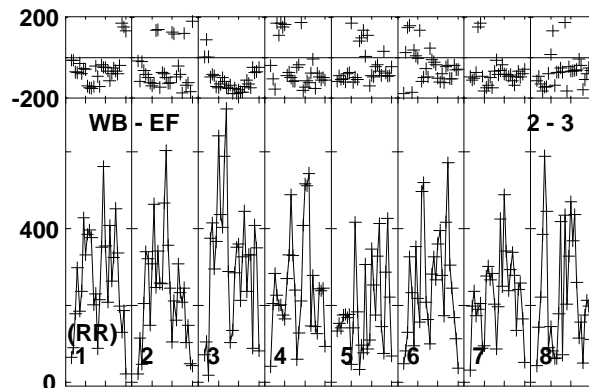
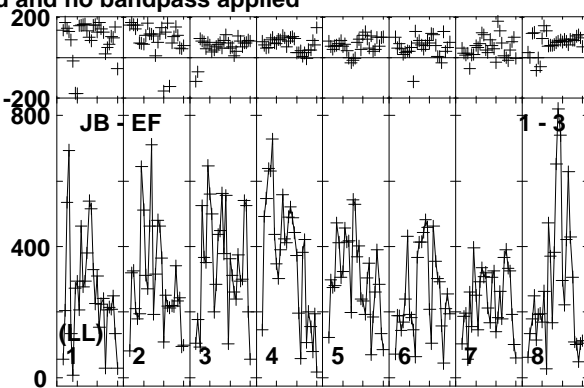
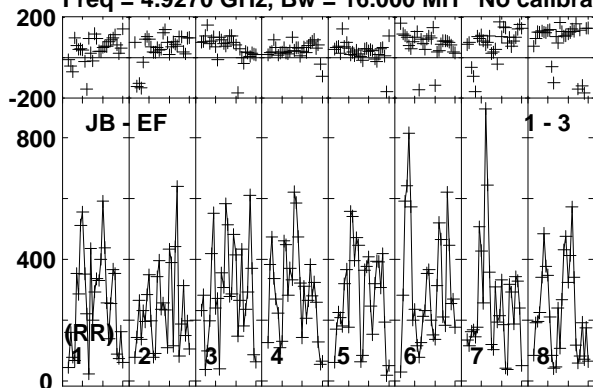

Lower frame: Micro Ampl Jy Top frame: Phas deg  
Vector averaged cross-power spectrum Baseline: JB (01) - EF (03)  
Timerange: 00/17:12:01 to 00/17:12:59

Plot file version 884 created 19-DEC-2018 17:59:10

VLA2\_RY007C.UVDATA.1

Freq = 4.9270 GHz, Bw = 16.000 MH No calibration applied and no bandpass applied

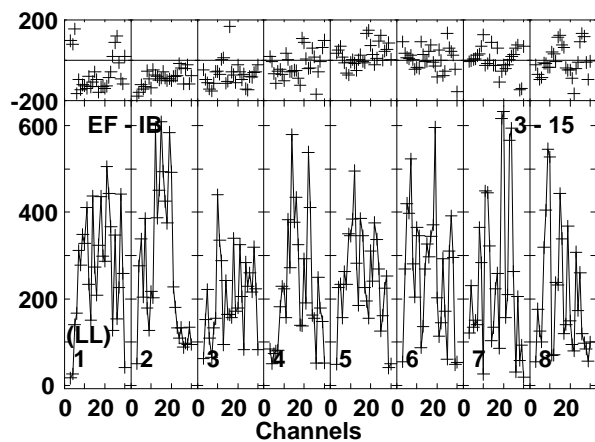
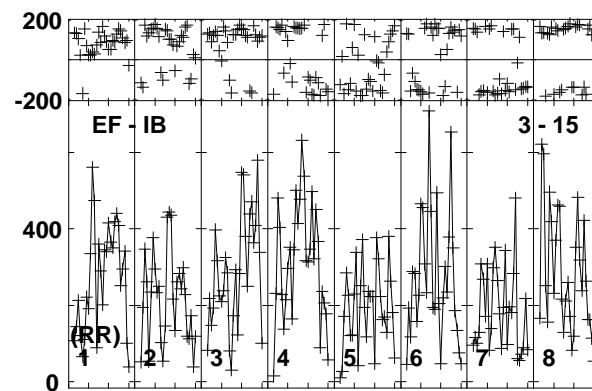
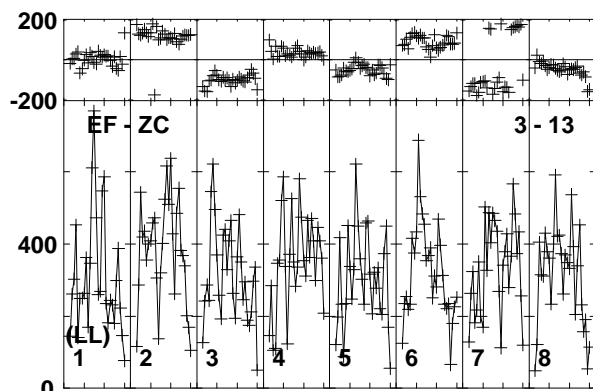
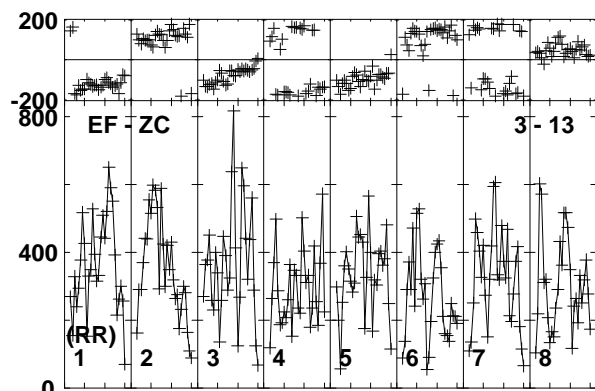
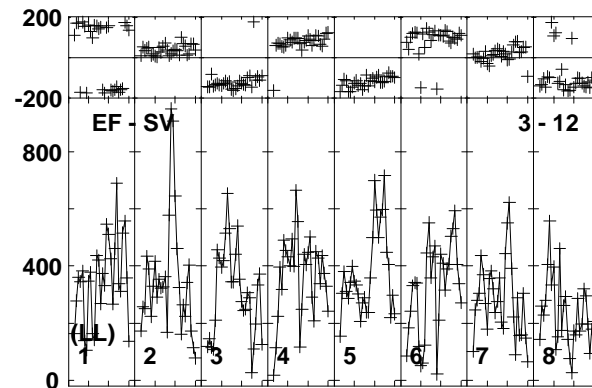
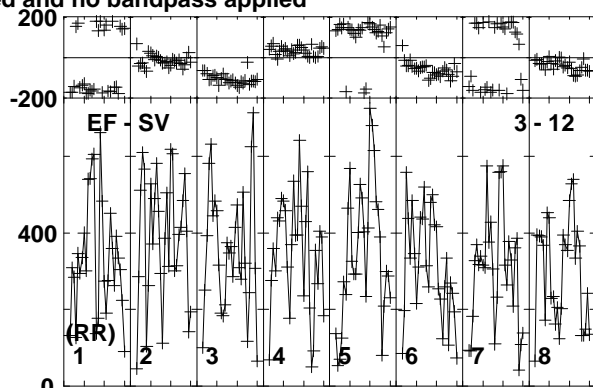
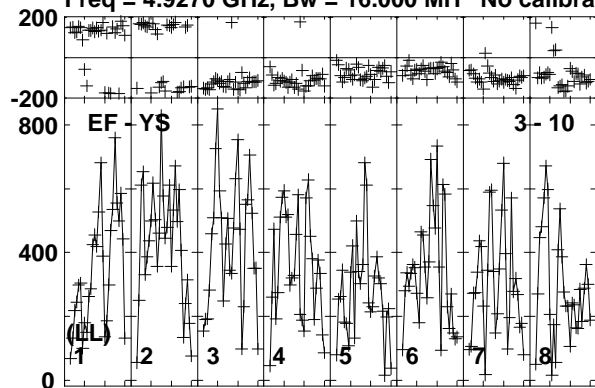

Lower frame: Micro Ampl Jy Top frame: Phas deg  
Vector averaged cross-power spectrum Baseline: EF (03) - YS (10)  
Timerange: 00/17:12:01 to 00/17:12:59

Plot file version 885 created 19-DEC-2018 17:59:10

J1619+2247 RY007C.UVDATA.1

Freq = 4.9270 GHz, Bw = 16.000 MH No calibration applied and no bandpass applied

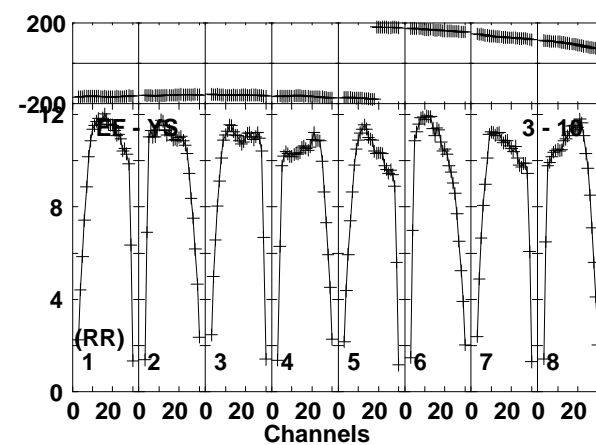
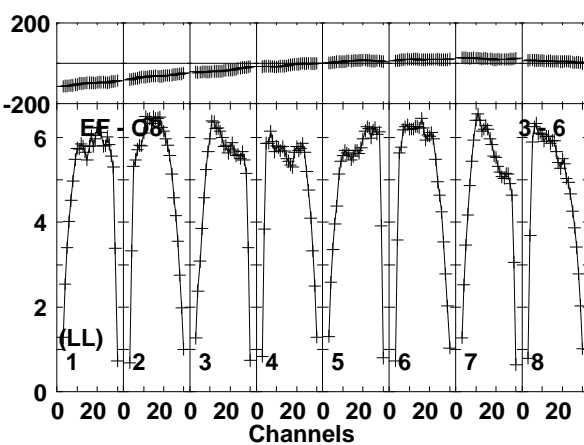
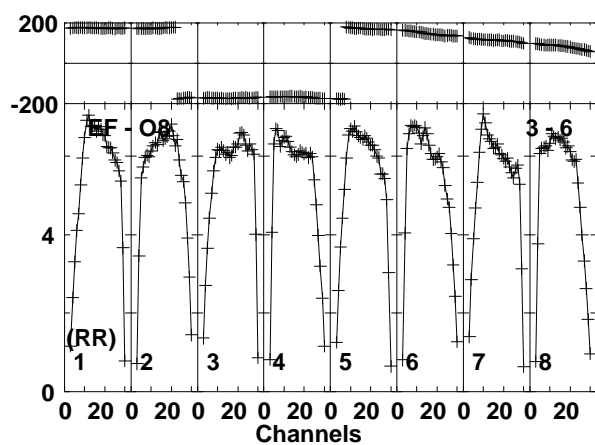
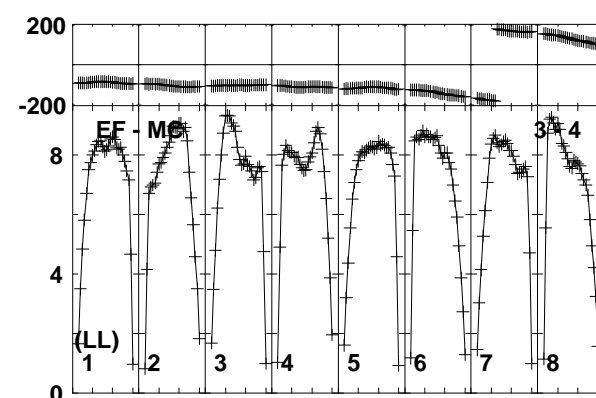
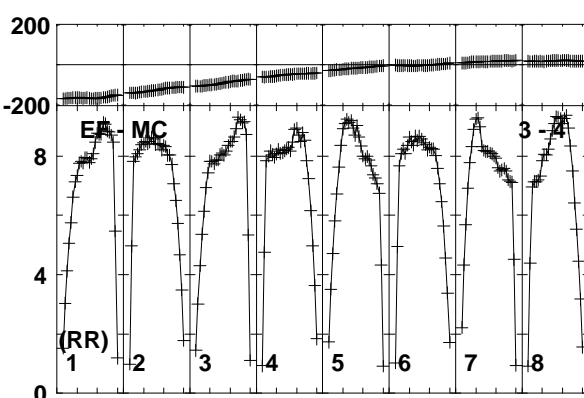
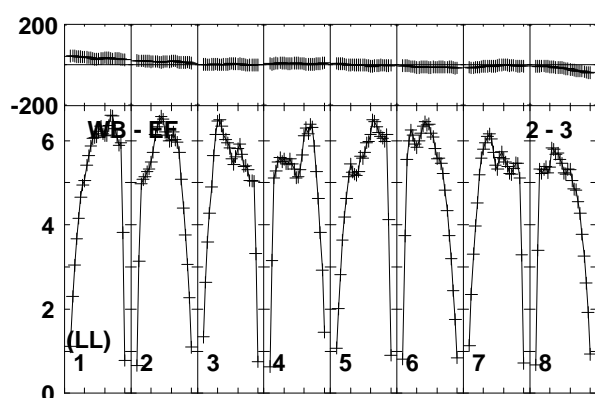
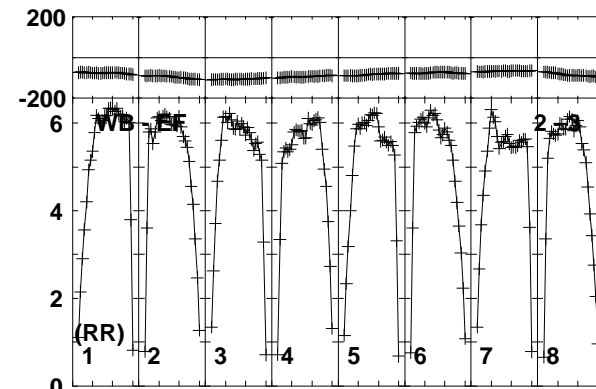
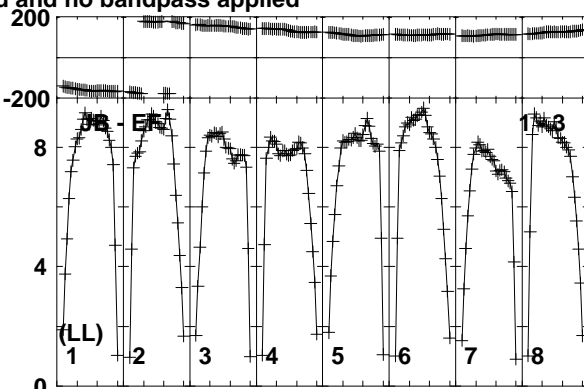
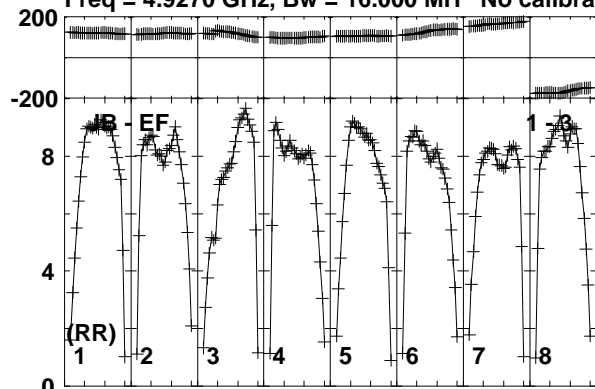

Lower frame: Milli Ampl Jy Top frame: Phas deg  
Vector averaged cross-power spectrum Baseline: JB (01) - EF (03)  
Timerange: 00/17:13:31 to 00/17:14:29

Plot file version 886 created 19-DEC-2018 17:59:10

J1619+2247 RY007C.UVDATA.1

Freq = 4.9270 GHz, Bw = 16.000 MH No calibration applied and no bandpass applied

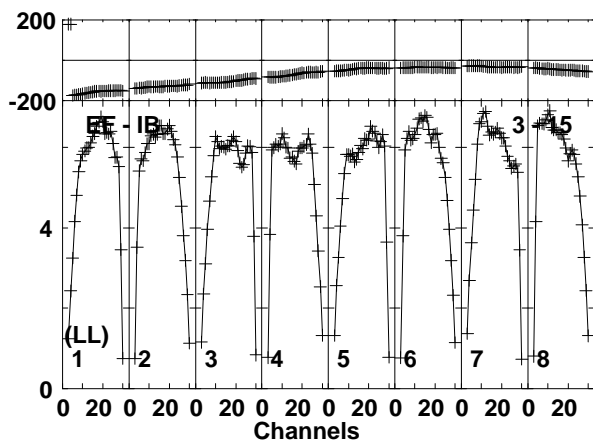
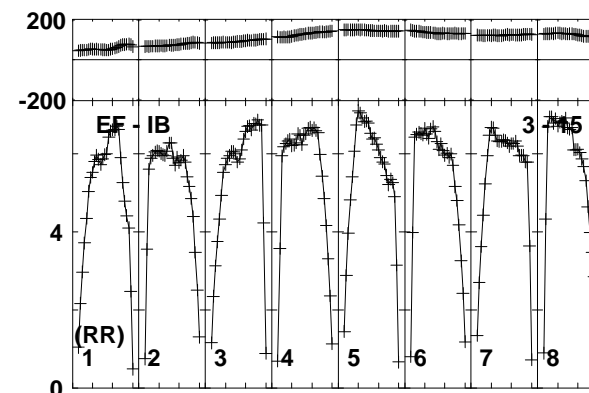
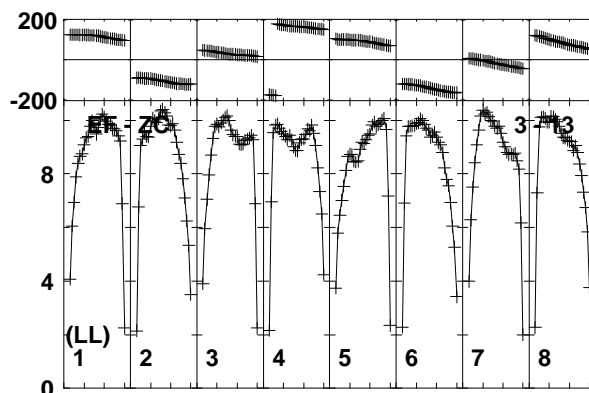
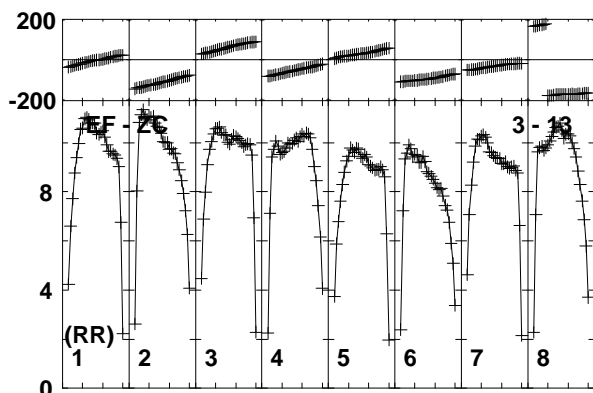
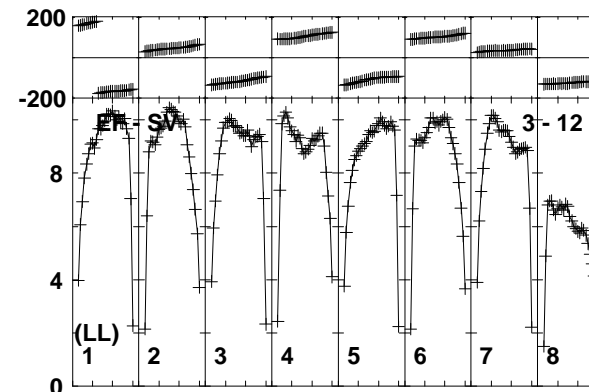
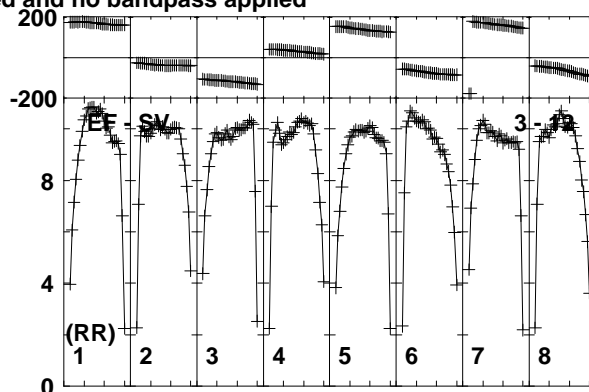
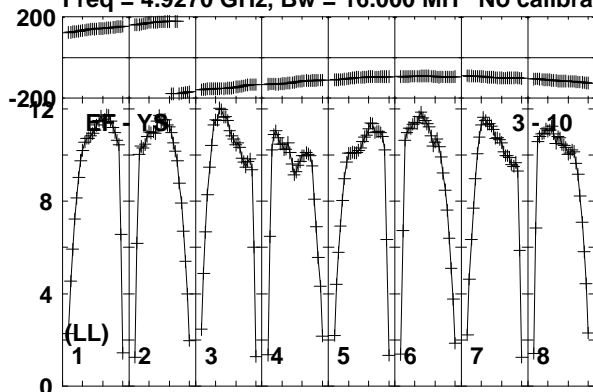

Lower frame: Milli Ampl Jy Top frame: Phas deg  
Vector averaged cross-power spectrum Baseline: EF (03) - YS (10)  
Timerange: 00/17:13:31 to 00/17:14:29

Plot file version 887 created 19-DEC-2018 17:59:10

AT2018\_RY007C.UVDATA.1

Freq = 4.9270 GHz, Bw = 16.000 MH No calibration applied and no bandpass applied

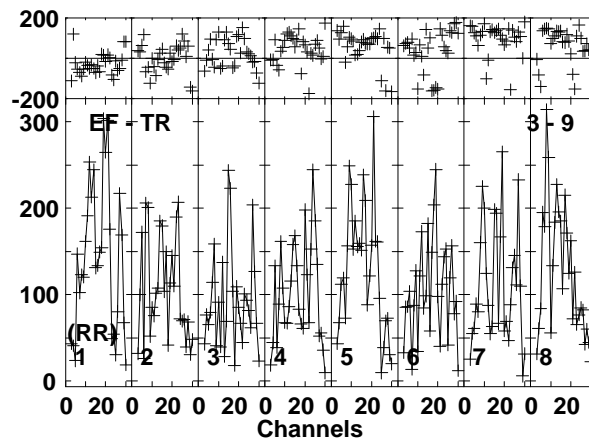
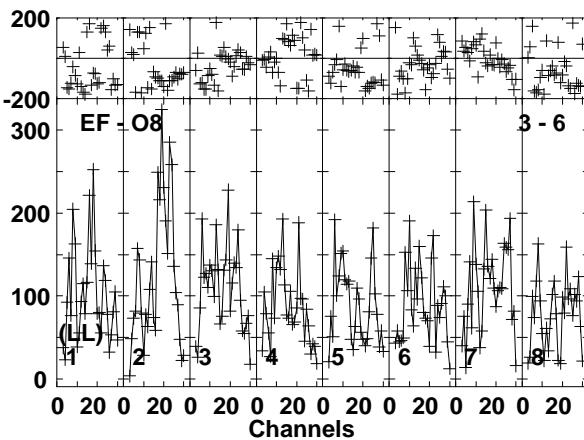
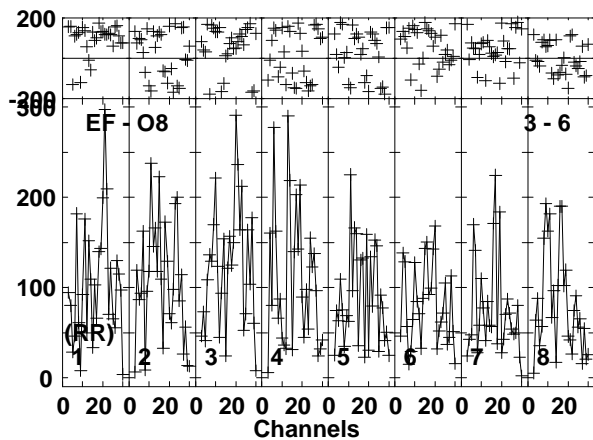
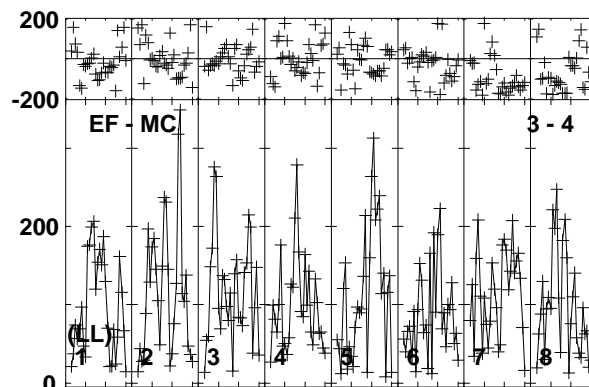
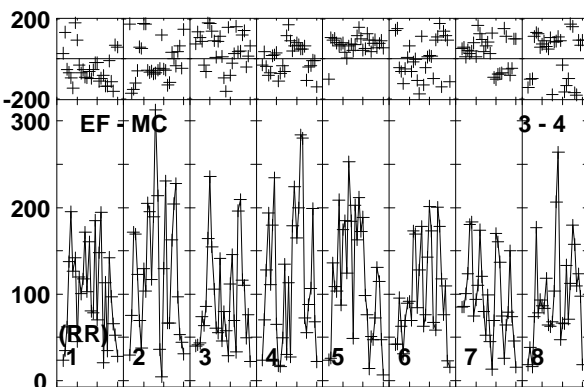
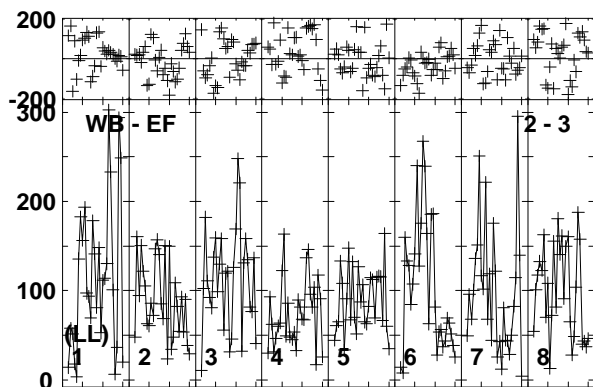
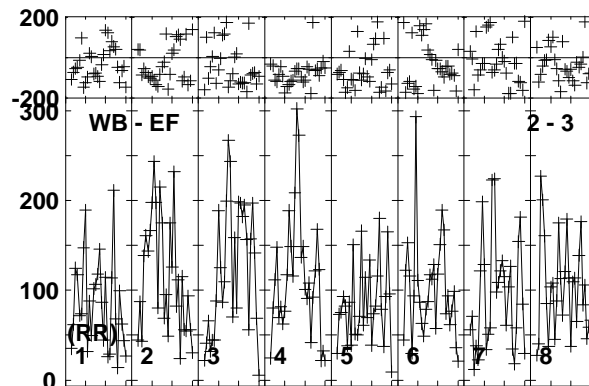
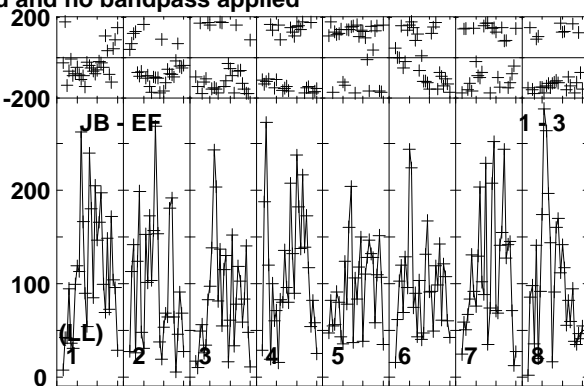
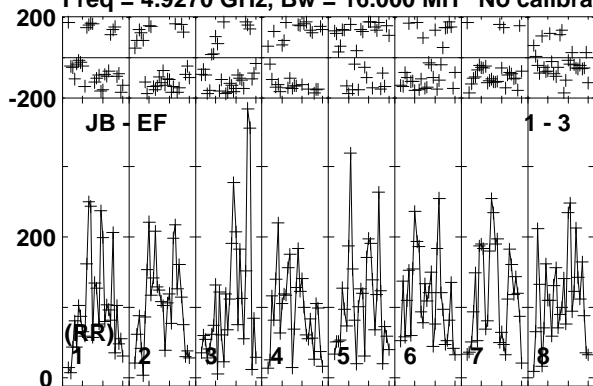

Lower frame: Micro Ampl Jy Top frame: Phas deg  
Vector averaged cross-power spectrum Baseline: JB (01) - EF (03)  
Timerange: 00/17:14:31 to 00/17:17:29

Plot file version 888 created 19-DEC-2018 17:59:10

AT2018\_RY007C.UVDATA.1

Freq = 4.9270 GHz, Bw = 16.000 MH No calibration applied and no bandpass applied

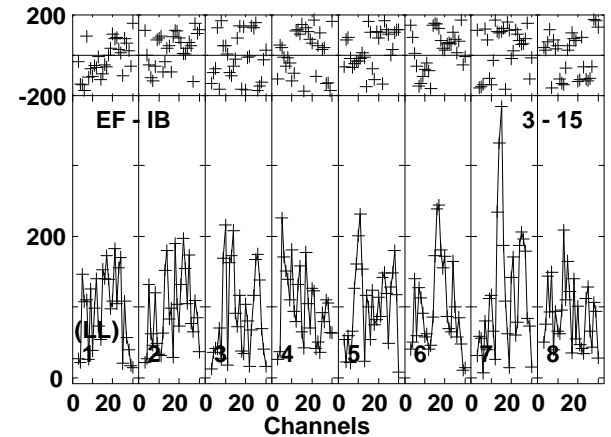
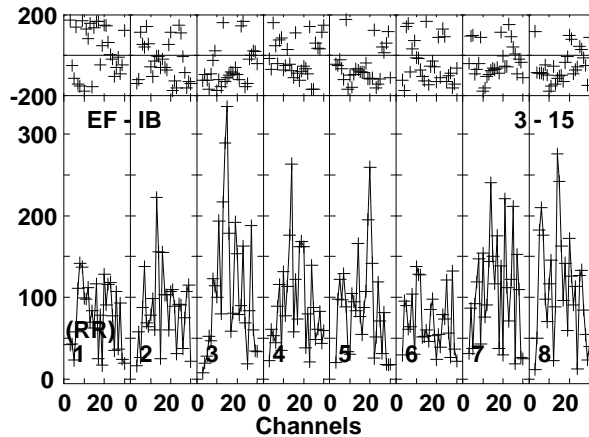
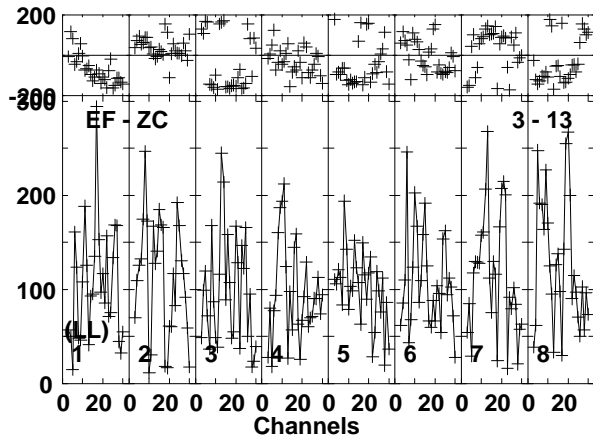
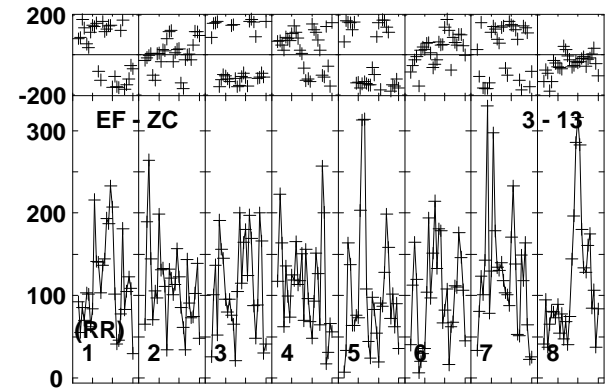
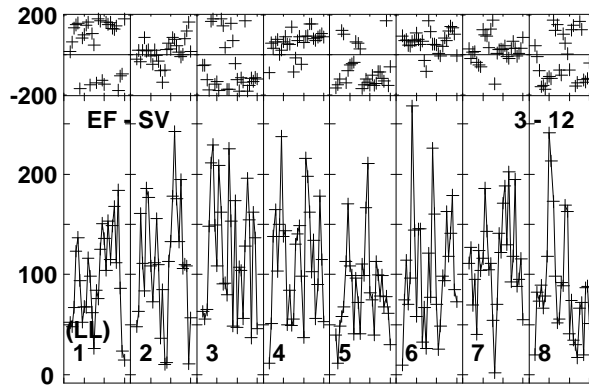
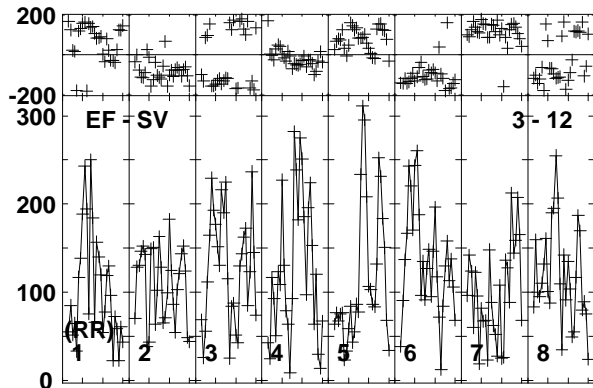
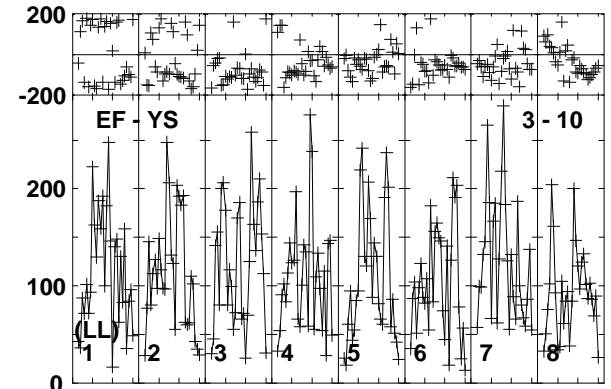
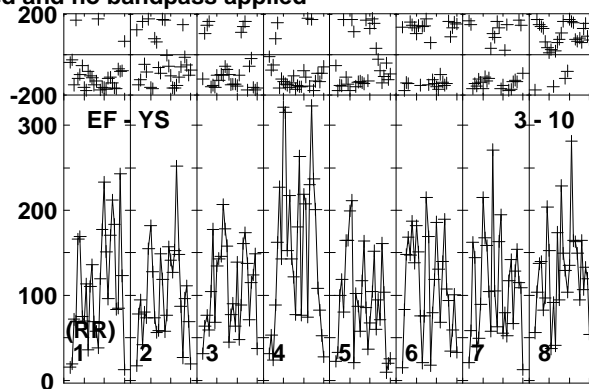
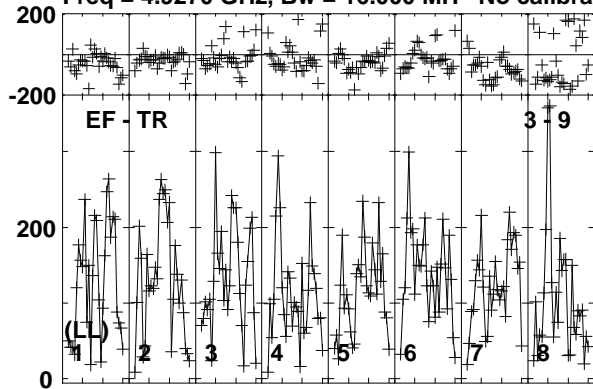

Lower frame: Micro Ampl Jy Top frame: Phas deg  
Vector averaged cross-power spectrum Baseline: EF (03) - TR (09)  
Timerange: 00/17:14:31 to 00/17:17:29

Plot file version 889 created 19-DEC-2018 17:59:10

J1619+2247 RY007C.UVDATA.1

Freq = 4.9270 GHz, Bw = 16.000 MH No calibration applied and no bandpass applied

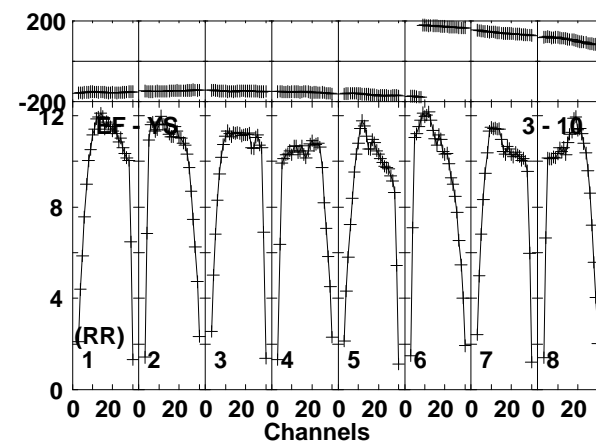
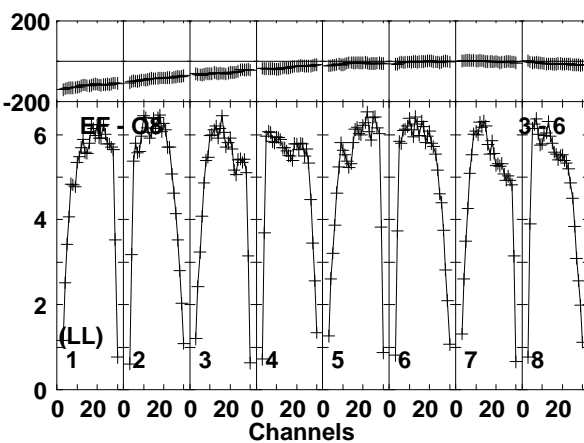
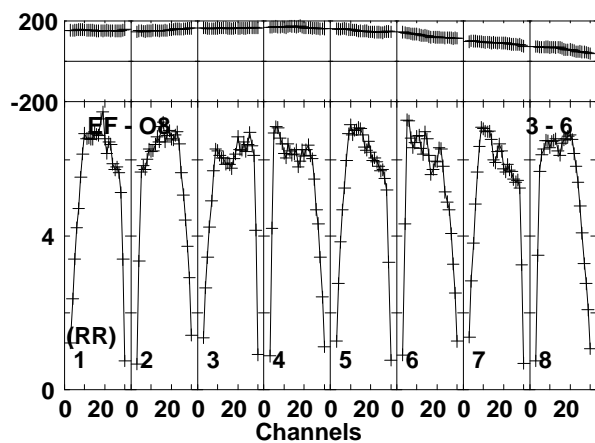
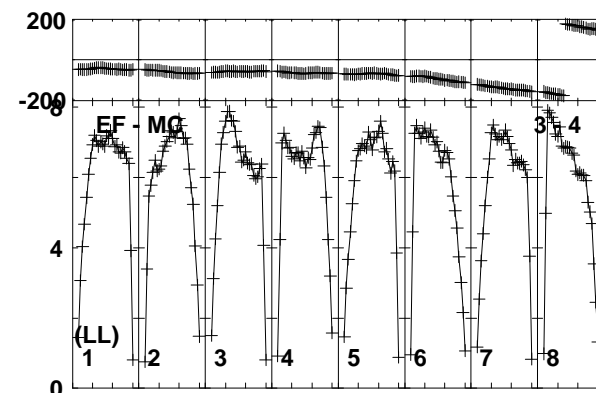
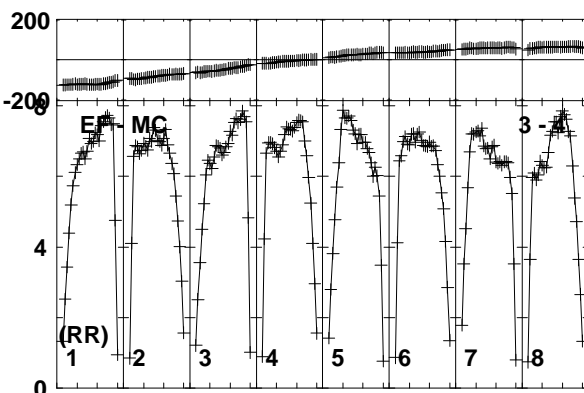
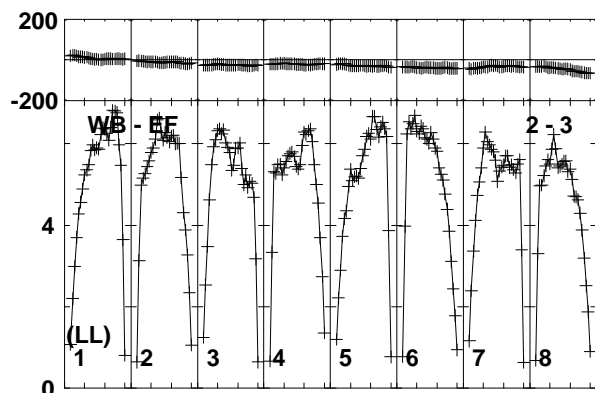
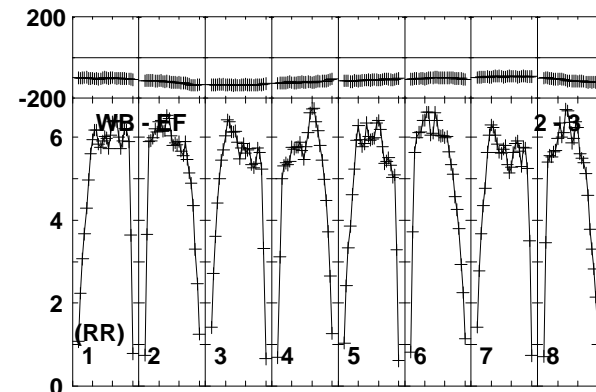
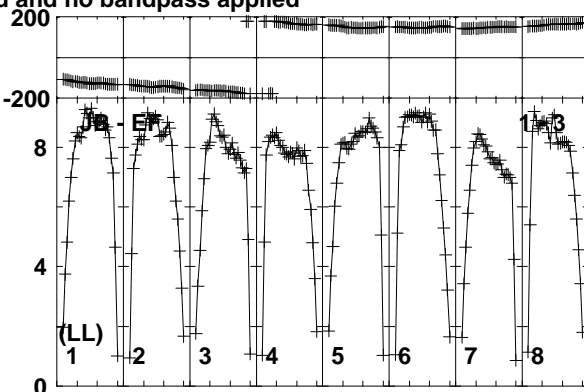
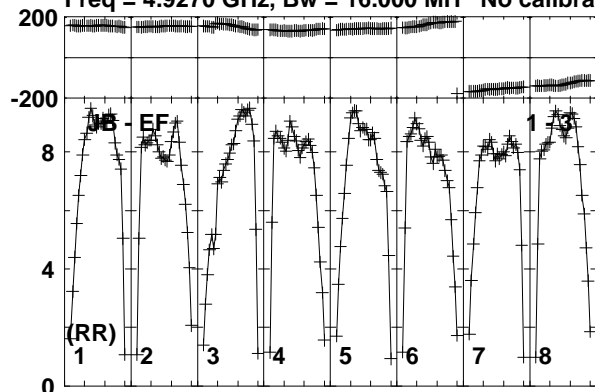

Lower frame: Milli Ampl Jy Top frame: Phas deg  
Vector averaged cross-power spectrum Baseline: JB (01) - EF (03)  
Timerange: 00/17:17:31 to 00/17:18:29

Plot file version 890 created 19-DEC-2018 17:59:10

J1619+2247 RY007C.UVDATA.1

Freq = 4.9270 GHz, Bw = 16.000 MH No calibration applied and no bandpass applied

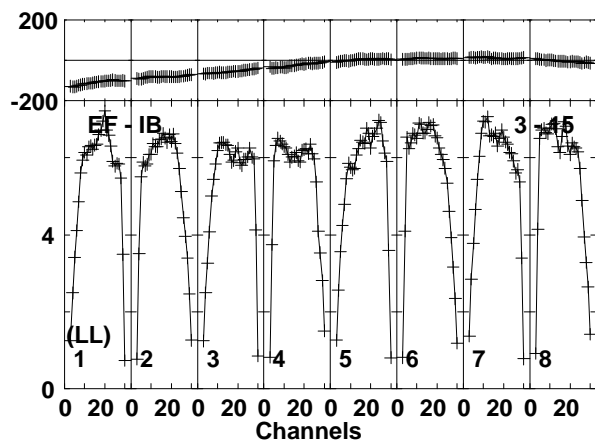
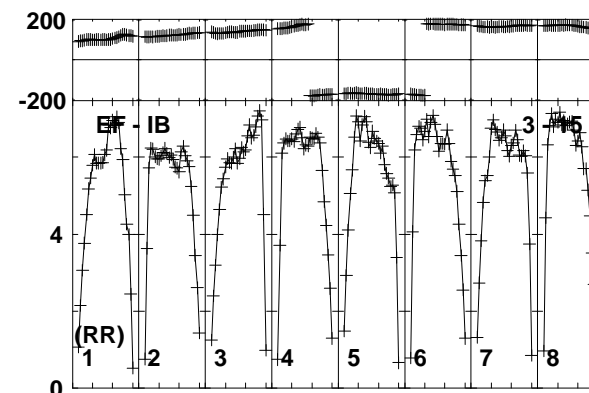
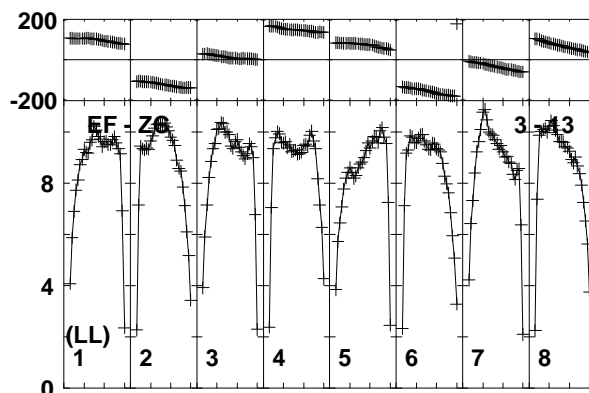
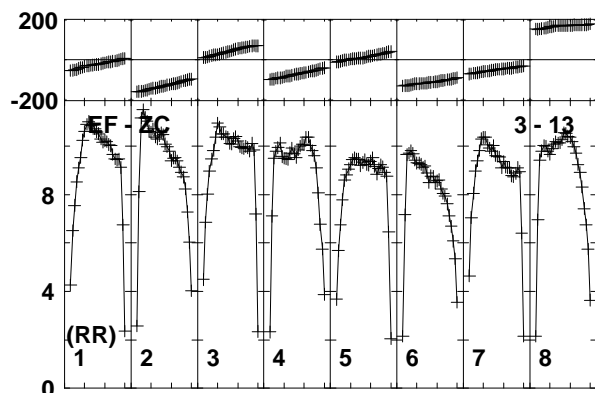
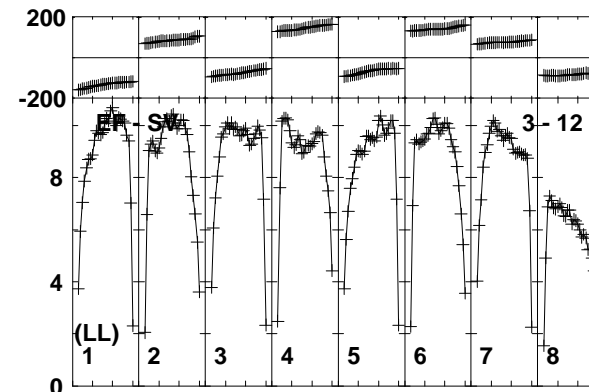
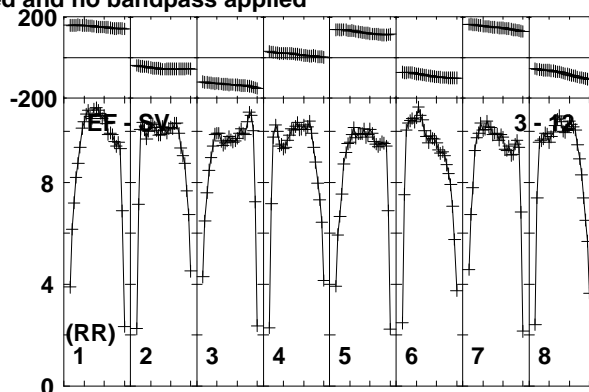
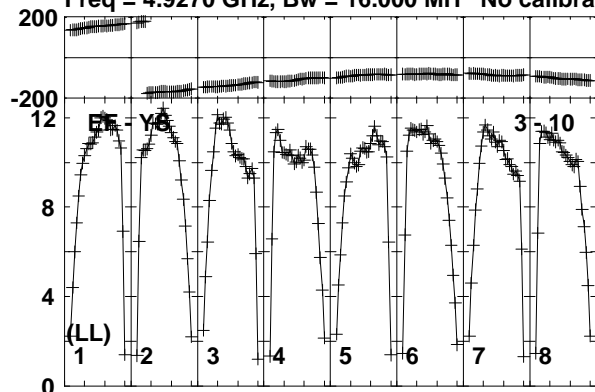

Lower frame: Milli Ampl Jy Top frame: Phas deg  
Vector averaged cross-power spectrum Baseline: EF (03) - YS (10)  
Timerange: 00/17:17:31 to 00/17:18:29



Plot file version 891 created 19-DEC-2018 17:59:10

AT2018\_RY007C.UVDATA.1

Freq = 4.9270 GHz, Bw = 16.000 MH No calibration applied and no bandpass applied

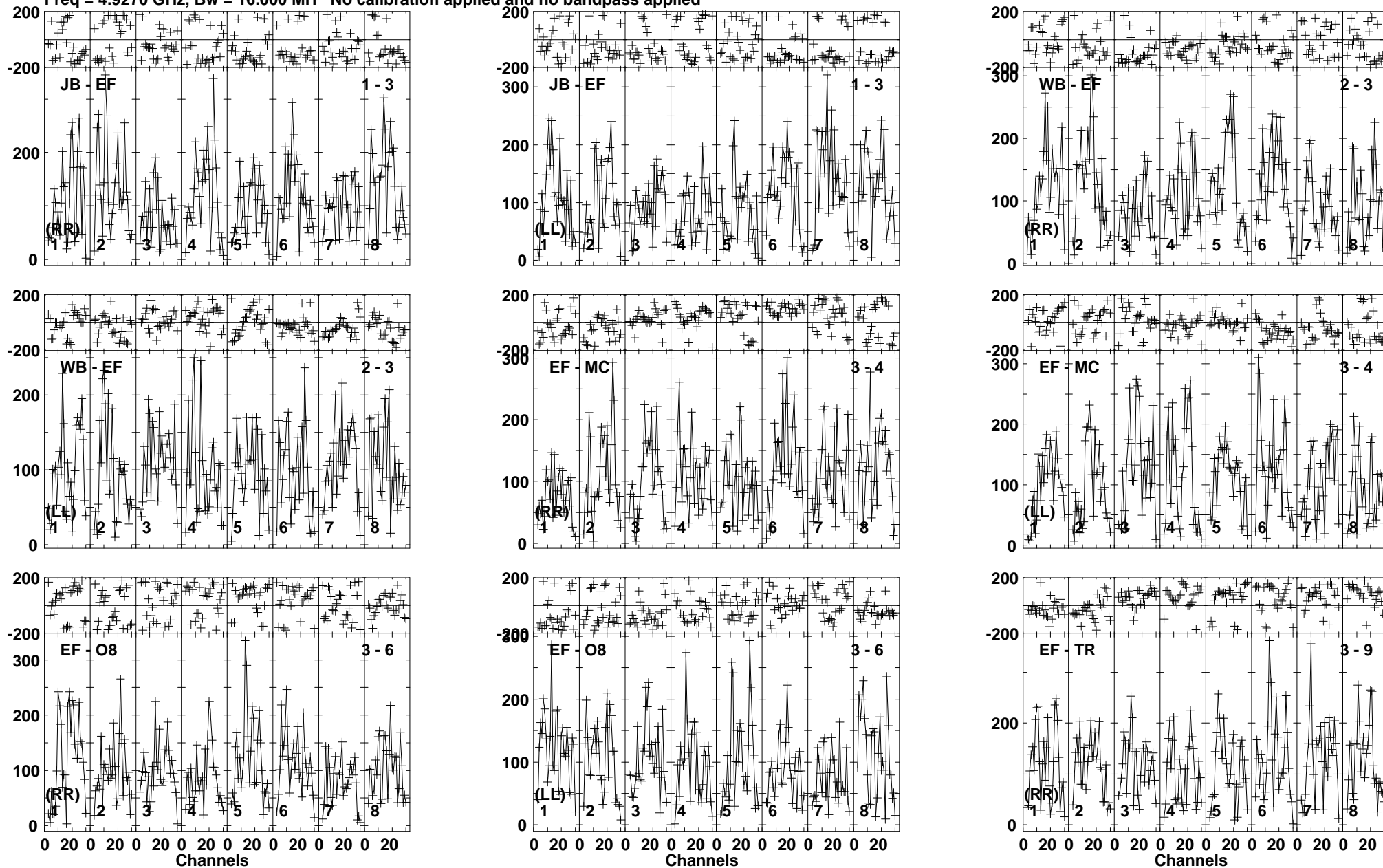

Lower frame: Micro Ampl Jy Top frame: Phas deg  
Vector averaged cross-power spectrum Baseline: JB (01) - EF (03)  
Timerange: 00/17:18:31 to 00/17:21:29

Plot file version 892 created 19-DEC-2018 17:59:10

AT2018\_RY007C.UVDATA.1

Freq = 4.9270 GHz, Bw = 16.000 MH No calibration applied and no bandpass applied

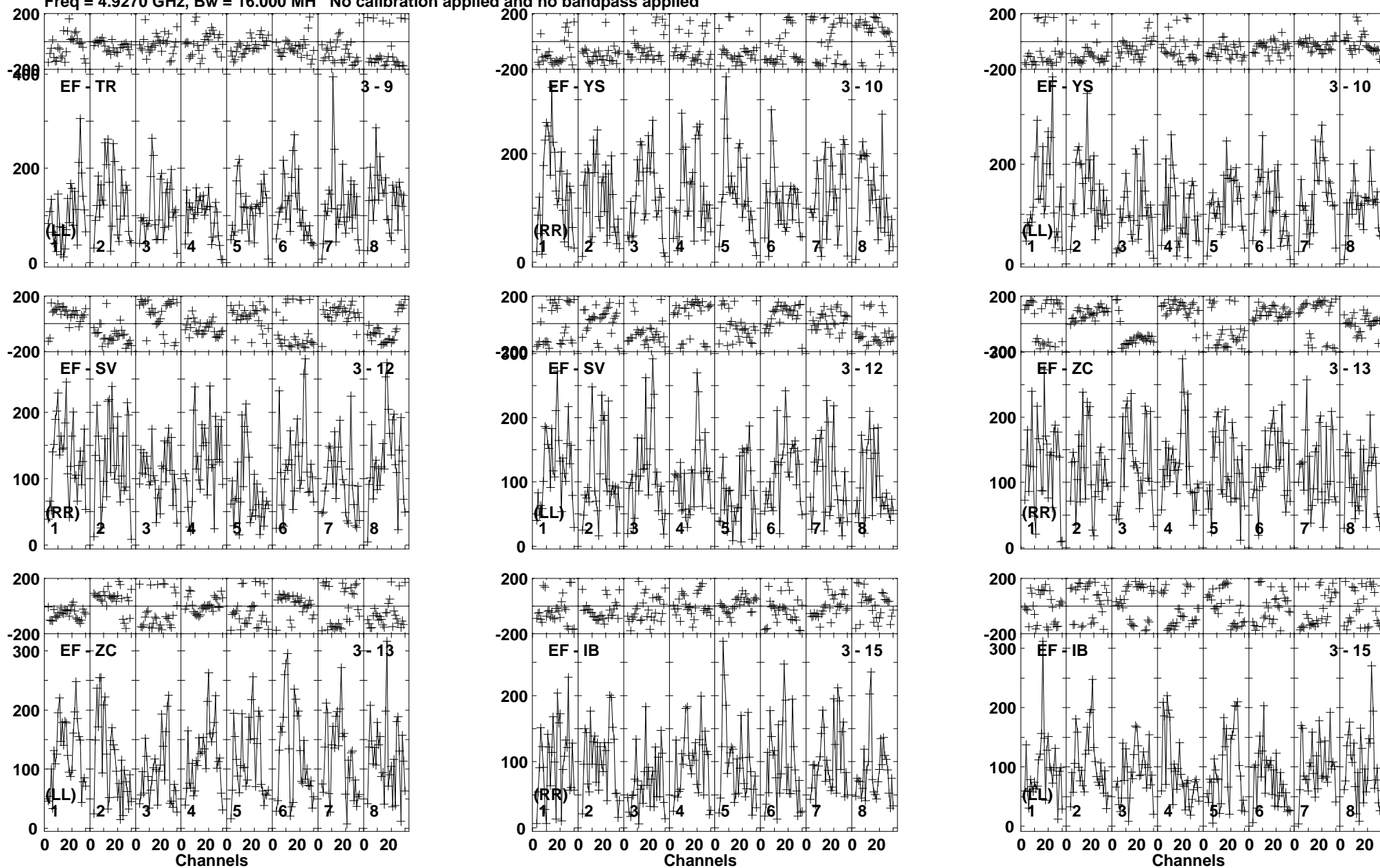

Lower frame: Micro Ampl Jy Top frame: Phas deg  
Vector averaged cross-power spectrum Baseline: EF (03) - TR (09)  
Timerange: 00/17:18:31 to 00/17:21:29

Plot file version 893 created 19-DEC-2018 17:59:10

AT2018\_RY007C.UVDATA.1

Freq = 4.9270 GHz, Bw = 16.000 MH No calibration applied and no bandpass applied

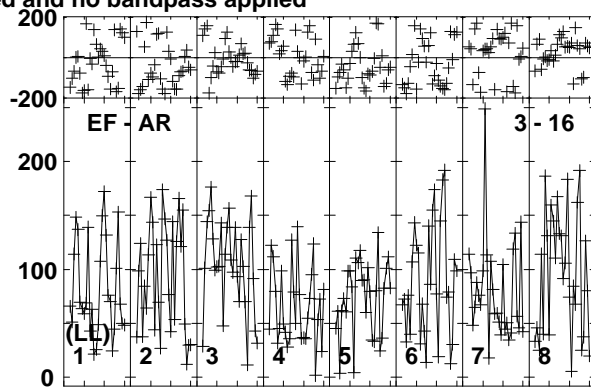
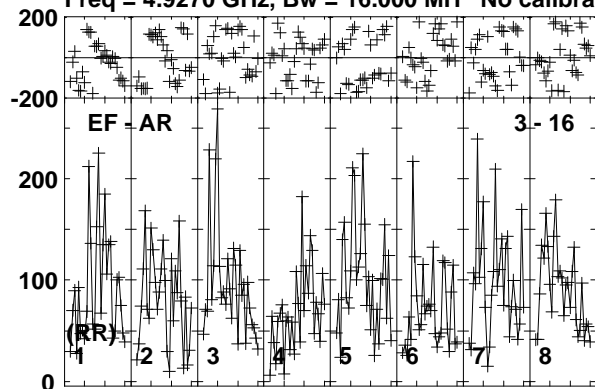

Lower frame: Micro Ampl Jy Top frame: Phas deg  
Vector averaged cross-power spectrum Baseline: EF (03) - AR (16)  
Timerange: 00/17:18:31 to 00/17:21:29

Plot file version 894 created 19-DEC-2018 17:59:10

J1619+2247 RY007C.UVDATA.1

Freq = 4.9270 GHz, Bw = 16.000 MH No calibration applied and no bandpass applied

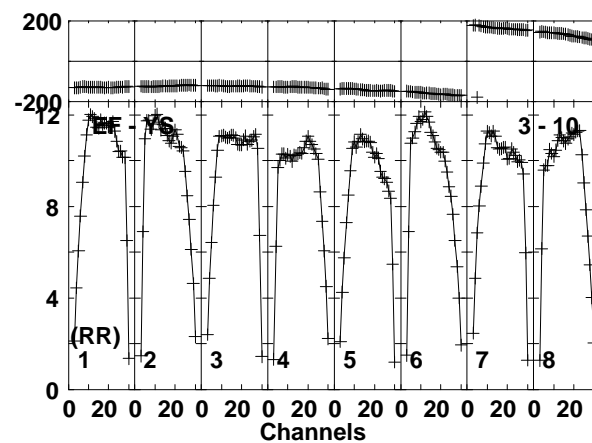
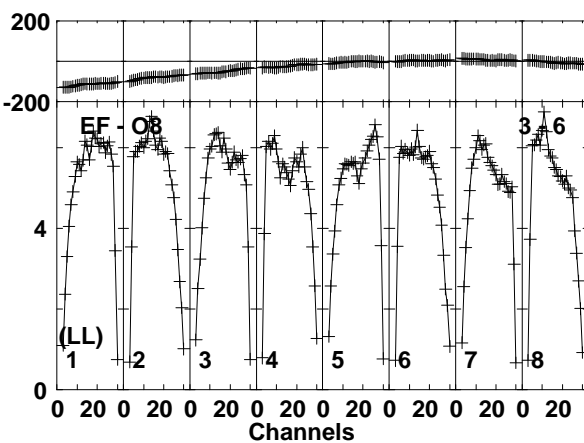
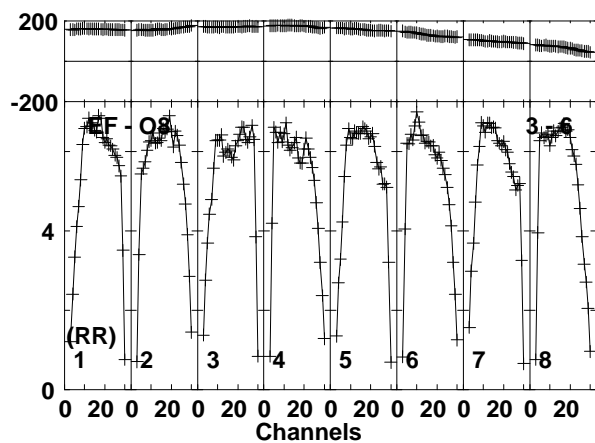
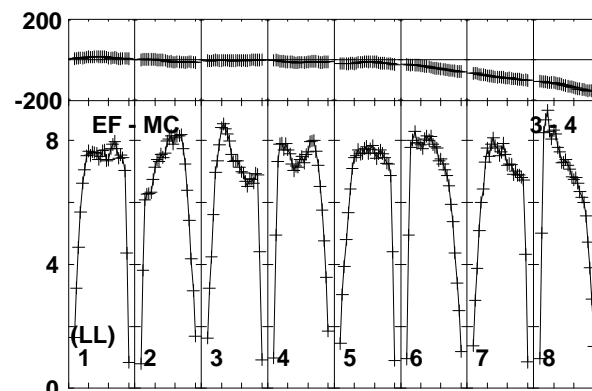
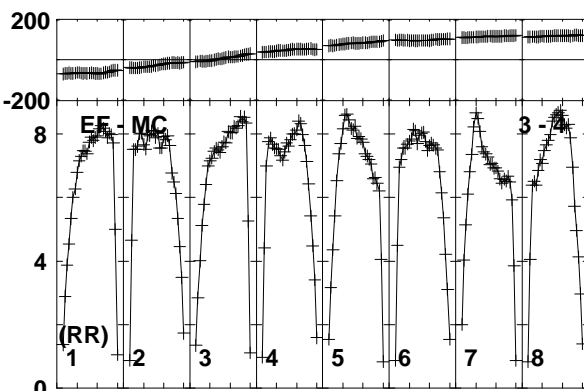
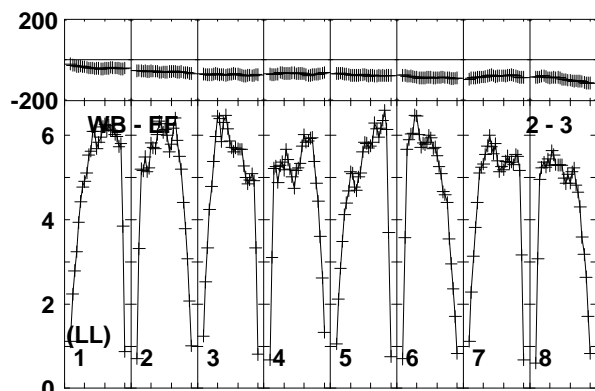
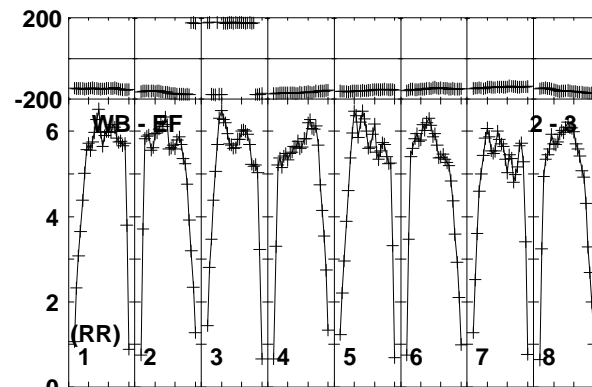
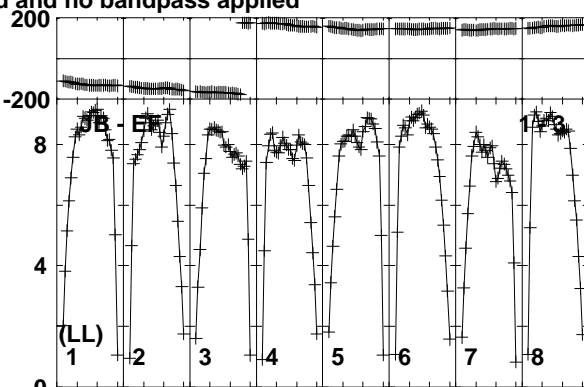
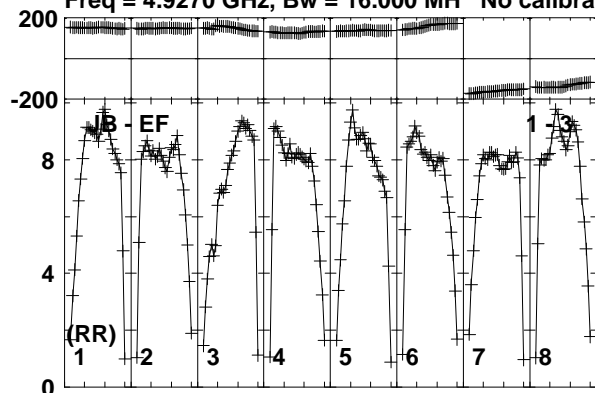

Lower frame: Milli Ampl Jy Top frame: Phas deg  
Vector averaged cross-power spectrum Baseline: JB (01) - EF (03)  
Timerange: 00/17:21:31 to 00/17:22:29

Plot file version 895 created 19-DEC-2018 17:59:10

J1619+2247 RY007C.UVDATA.1

Freq = 4.9270 GHz, Bw = 16.000 MH No calibration applied and no bandpass applied

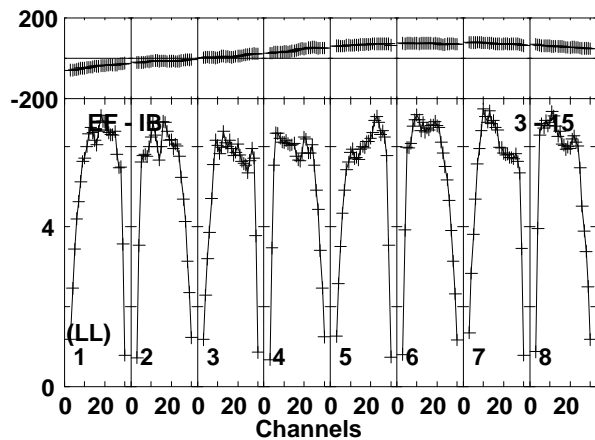
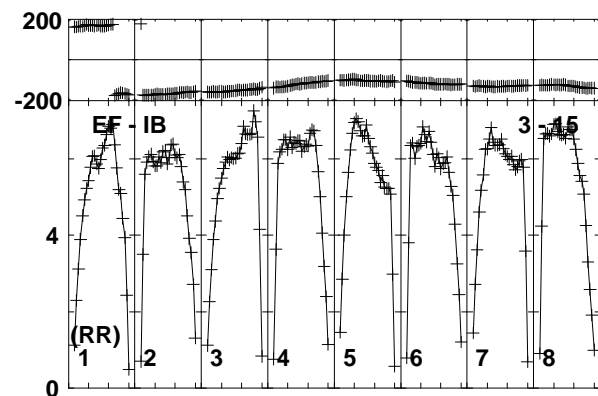
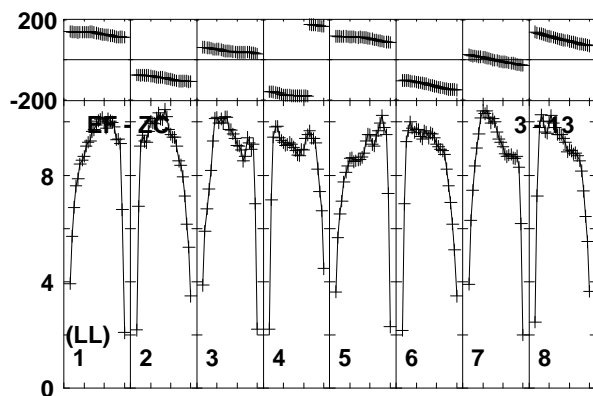
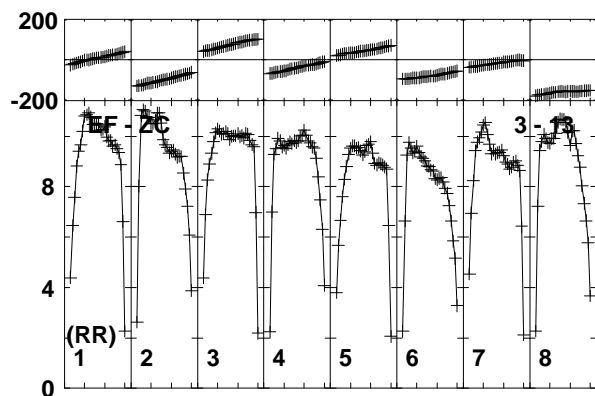
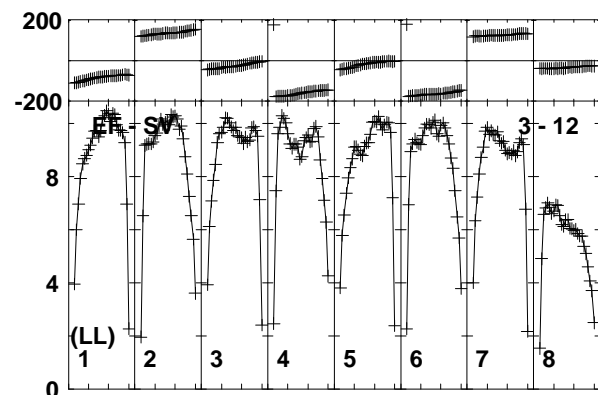
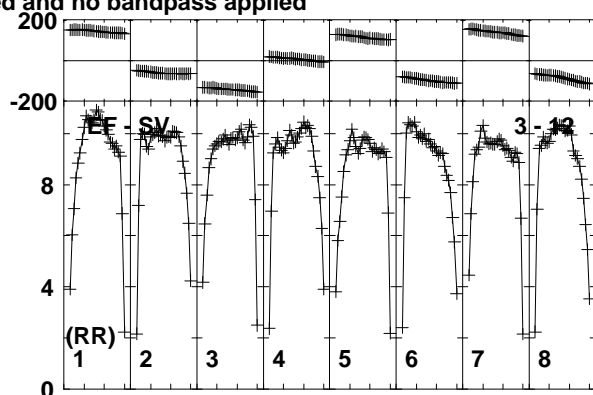
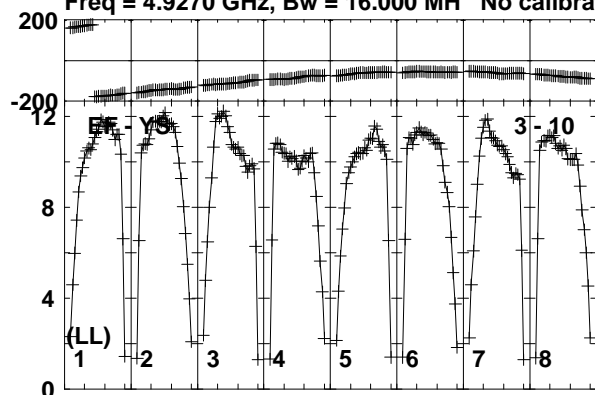

Lower frame: Milli Ampl Jy Top frame: Phas deg  
Vector averaged cross-power spectrum Baseline: EF (03) - YS (10)  
Timerange: 00/17:21:31 to 00/17:22:29

Plot file version 896 created 19-DEC-2018 17:59:10

VLA1 RY007C.UVDATA.1

Freq = 4.9270 GHz, Bw = 16.000 MH No calibration applied and no bandpass applied

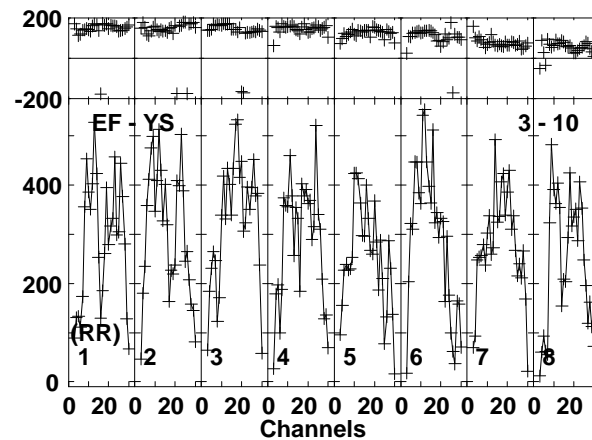
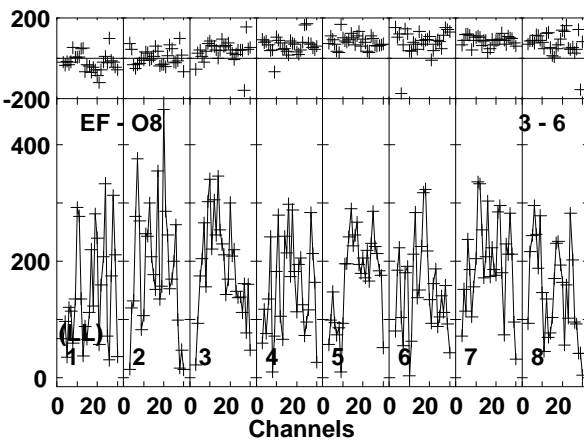
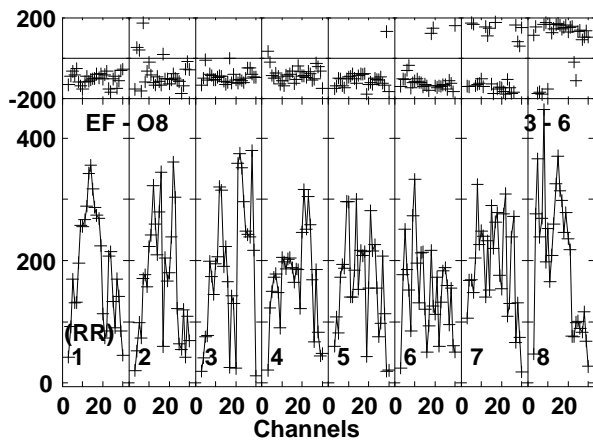
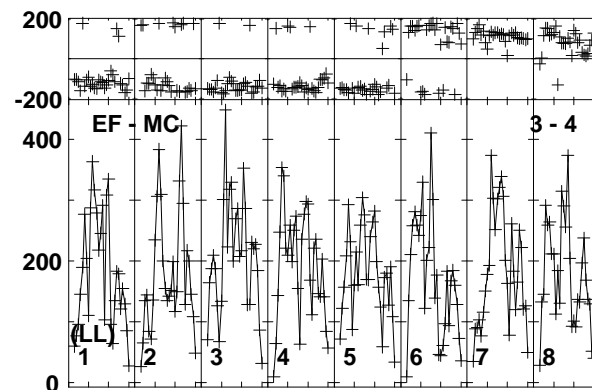
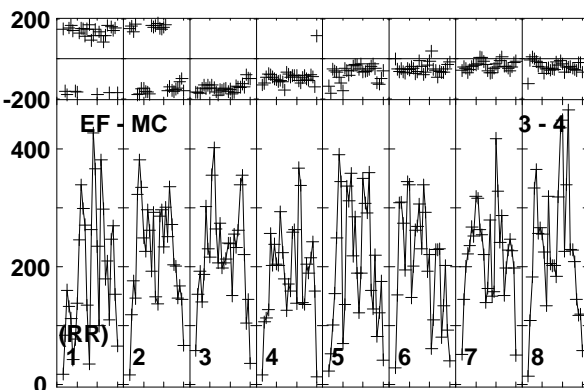
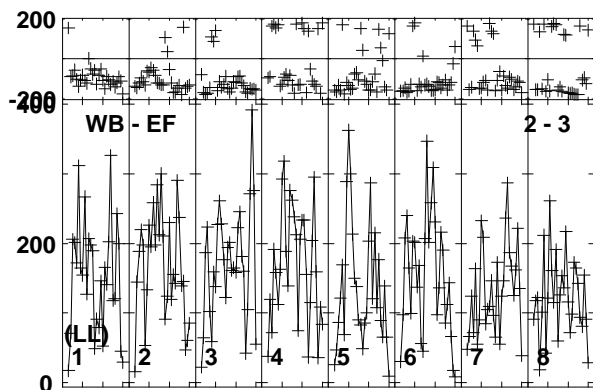
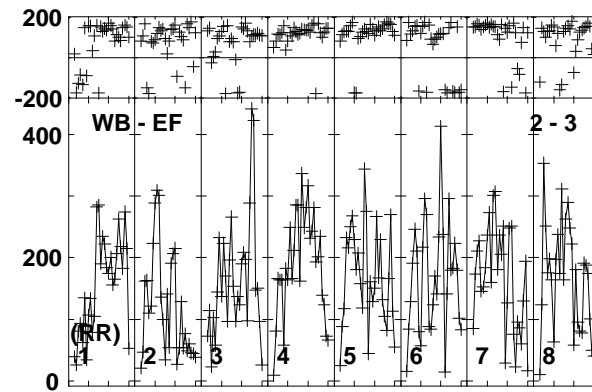
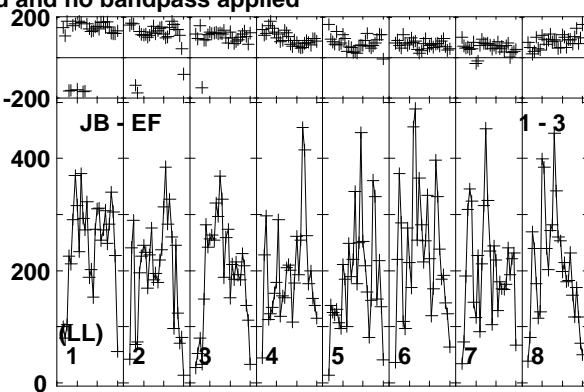
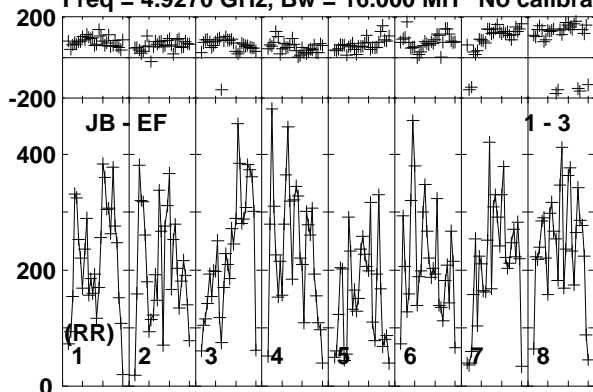

Lower frame: Micro Ampl Jy Top frame: Phas deg  
Vector averaged cross-power spectrum Baseline: JB (01) - EF (03)  
Timerange: 00/17:23:01 to 00/17:24:59

Plot file version 897 created 19-DEC-2018 17:59:11

VLA1 RY007C.UVDATA.1

Freq = 4.9270 GHz, Bw = 16.000 MH No calibration applied and no bandpass applied

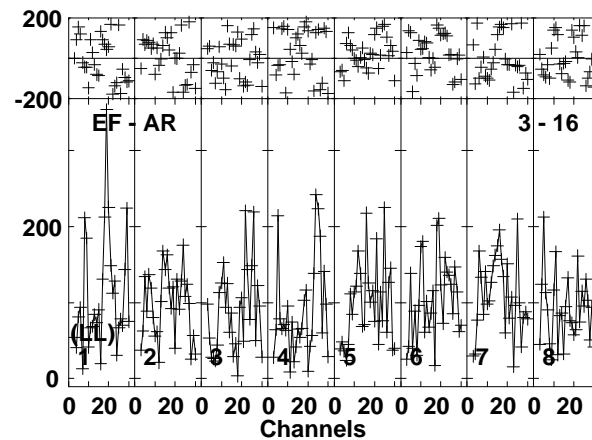
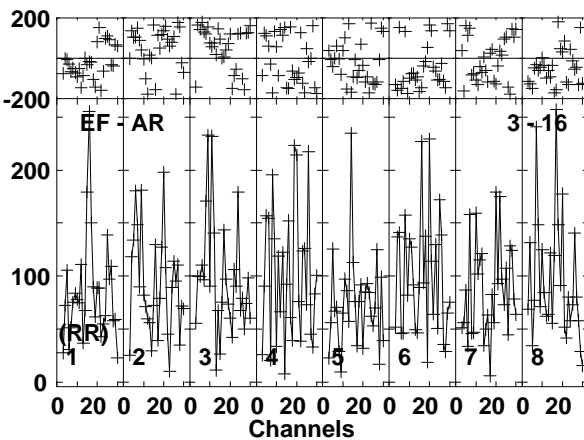
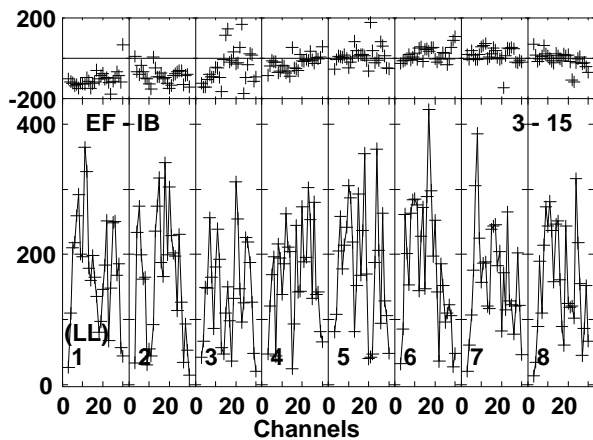
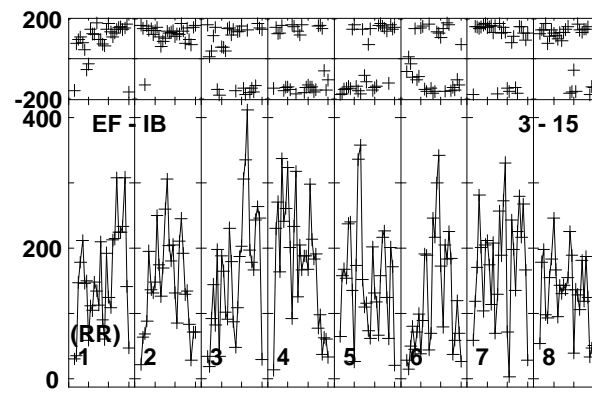
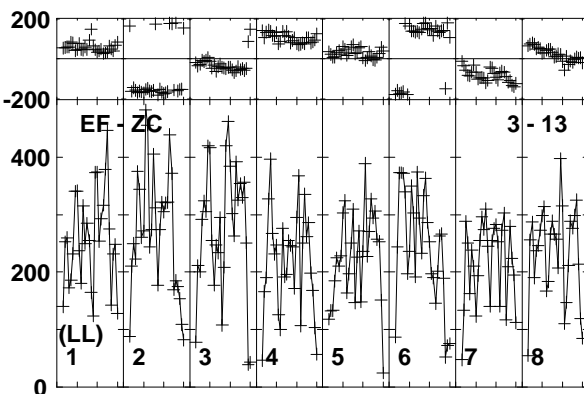
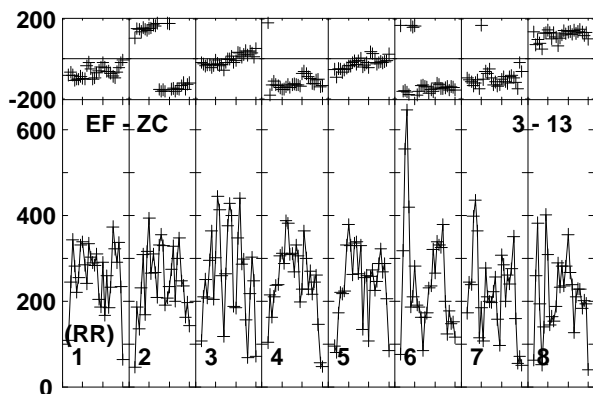
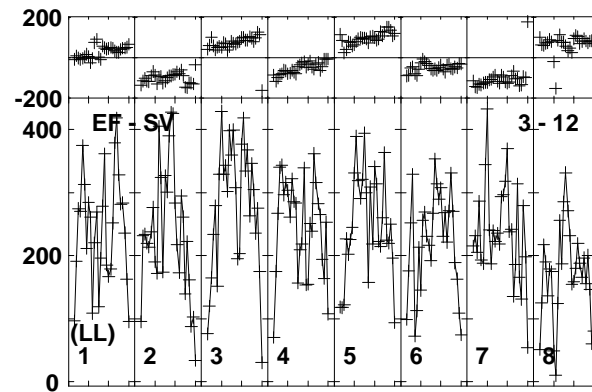
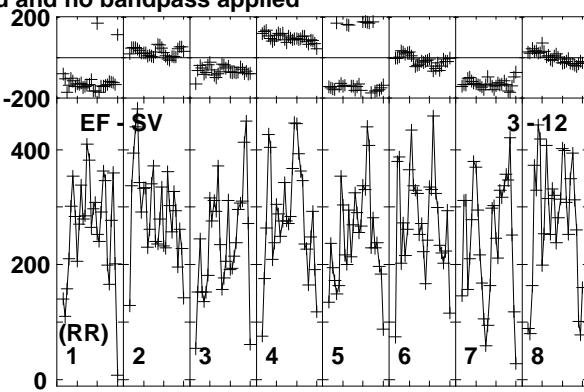
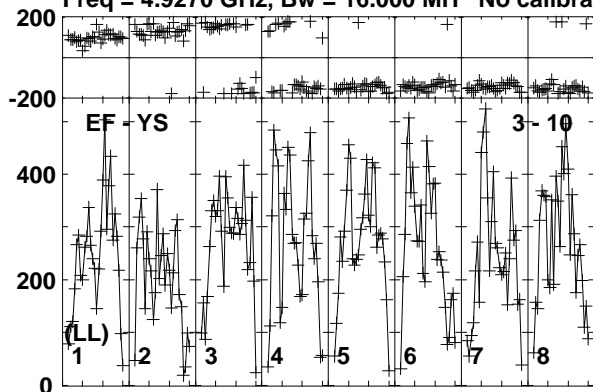

Lower frame: Micro Ampl Jy Top frame: Phas deg  
Vector averaged cross-power spectrum Baseline: EF (03) - YS (10)  
Timerange: 00/17:23:01 to 00/17:24:59

Plot file version 898 created 19-DEC-2018 17:59:11

J1619+2247 RY007C.UVDATA.1

Freq = 4.9270 GHz, Bw = 16.000 MH No calibration applied and no bandpass applied

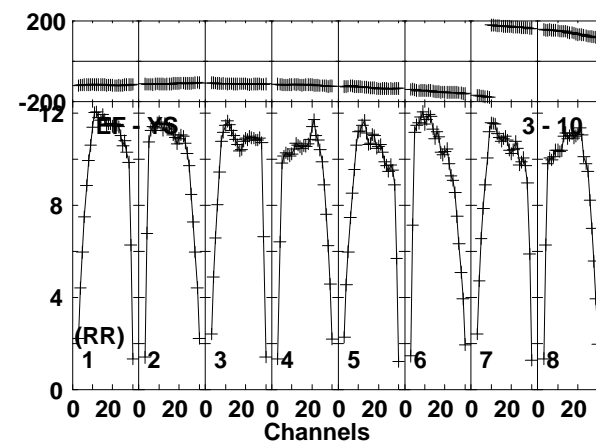
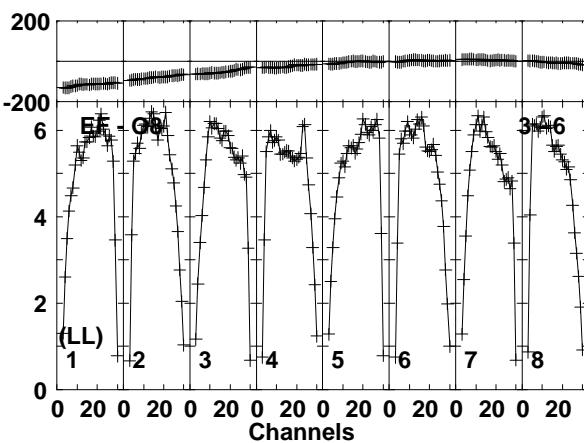
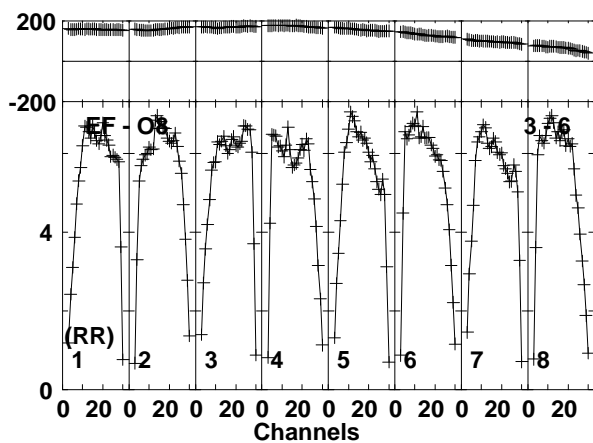
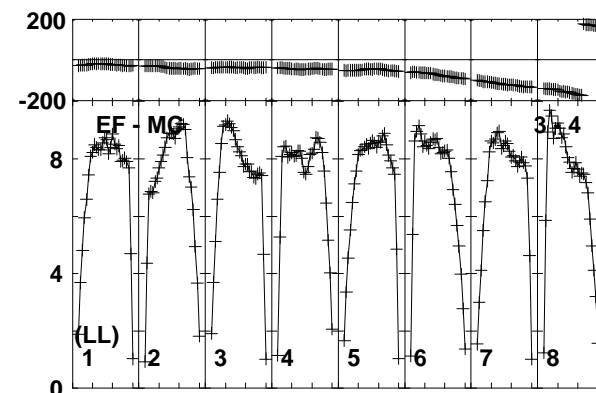
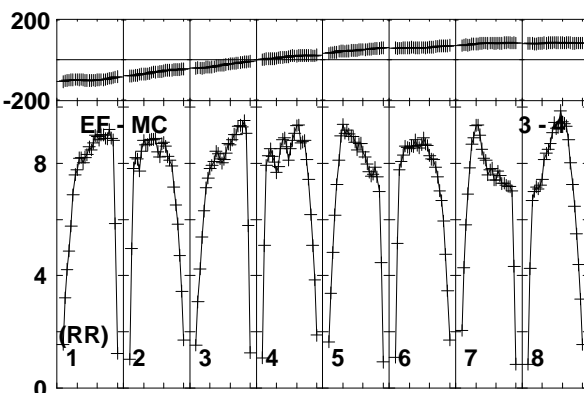
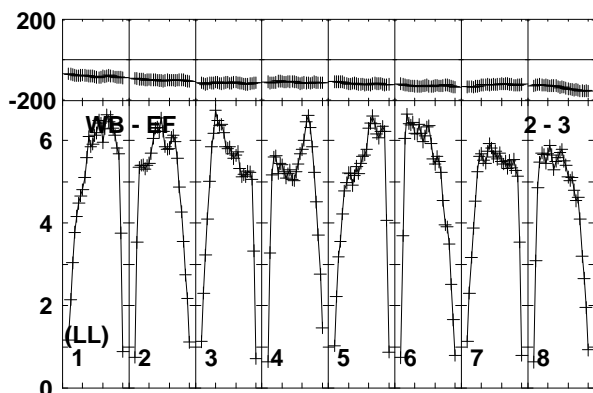
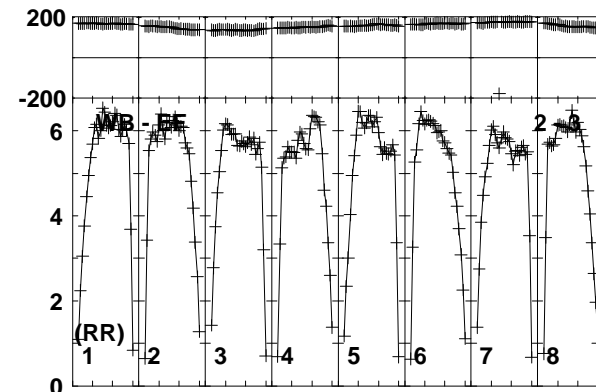
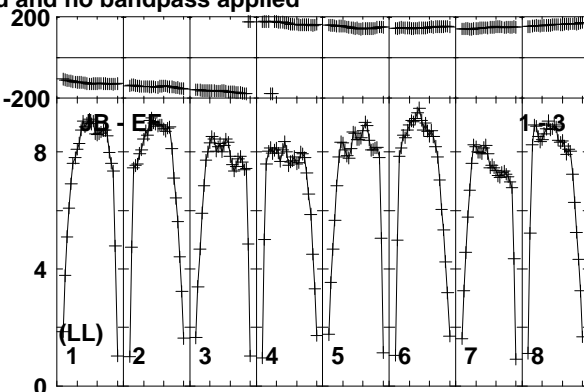
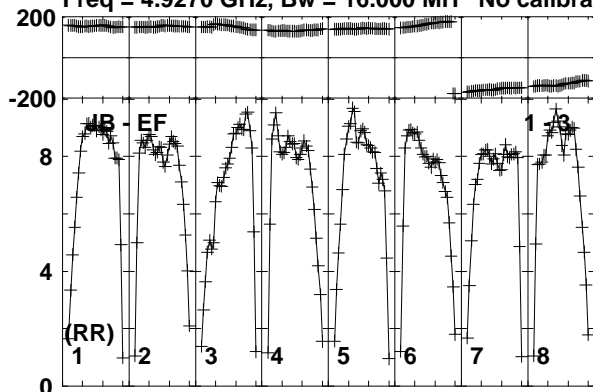

Lower frame: Milli Ampl Jy Top frame: Phas deg  
Vector averaged cross-power spectrum Baseline: JB (01) - EF (03)  
Timerange: 00/17:25:01 to 00/17:25:59



Plot file version 899 created 19-DEC-2018 17:59:11

J1619+2247 RY007C.UVDATA.1

Freq = 4.9270 GHz, Bw = 16.000 MH No calibration applied and no bandpass applied

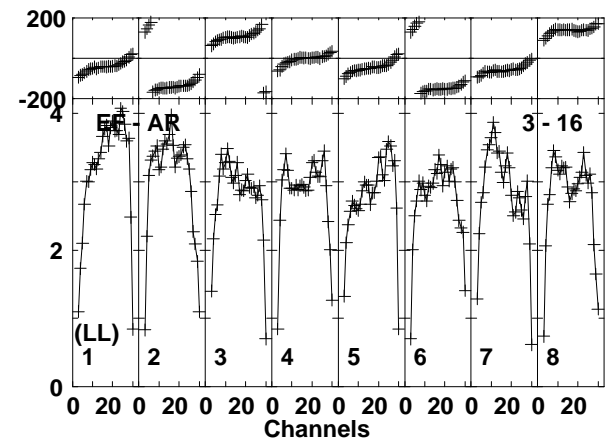
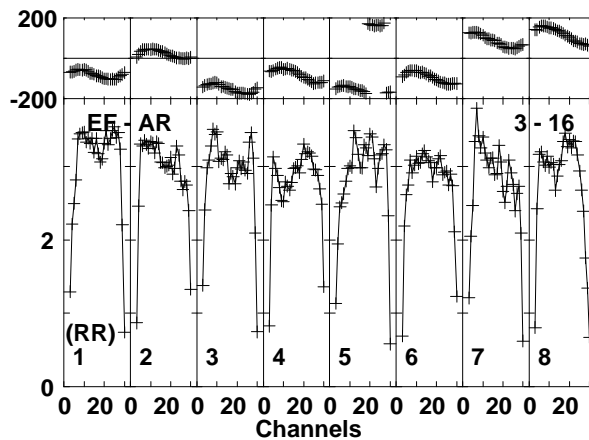
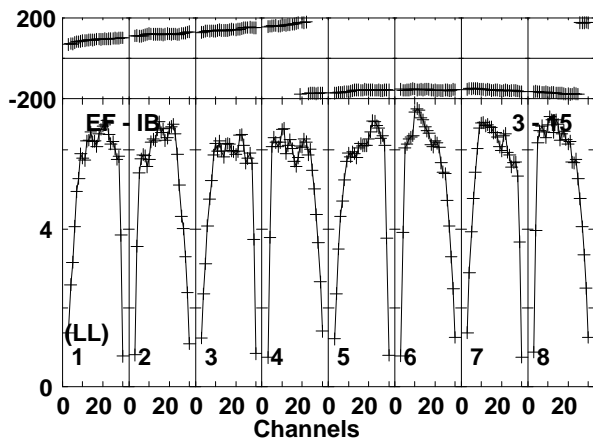
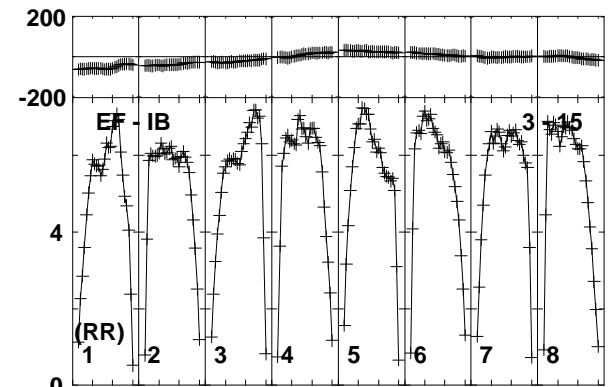
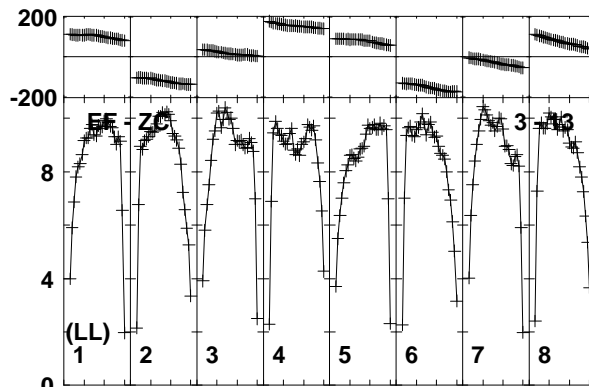
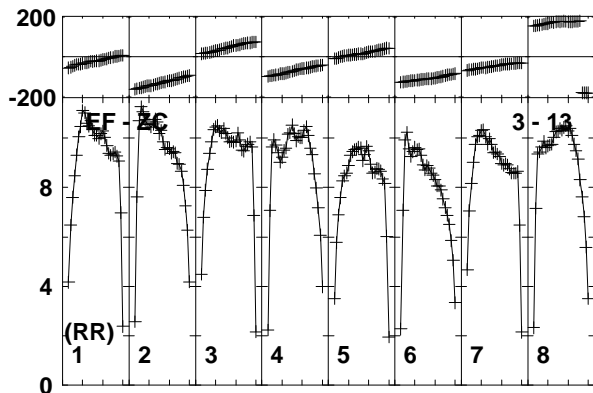
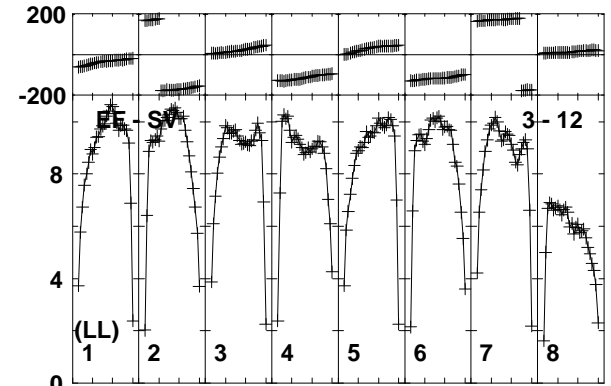
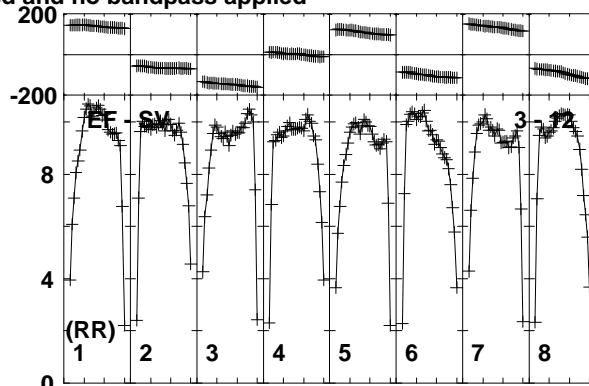
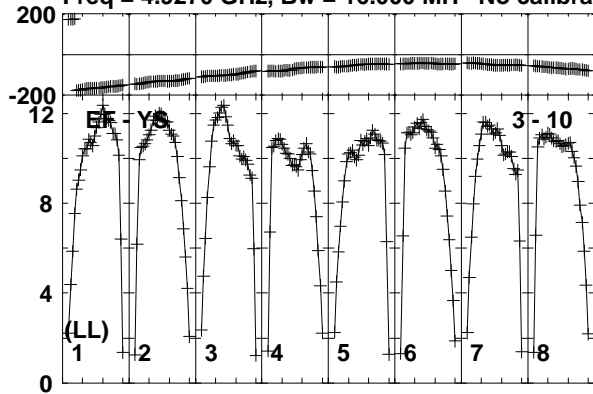

Lower frame: Milli Ampl Jy Top frame: Phas deg  
Vector averaged cross-power spectrum Baseline: EF (03) - YS (10)  
Timerange: 00/17:25:01 to 00/17:25:59

Plot file version 900 created 19-DEC-2018 17:59:11

AT2018\_RY007C.UVDATA.1

Freq = 4.9270 GHz, Bw = 16.000 MH No calibration applied and no bandpass applied

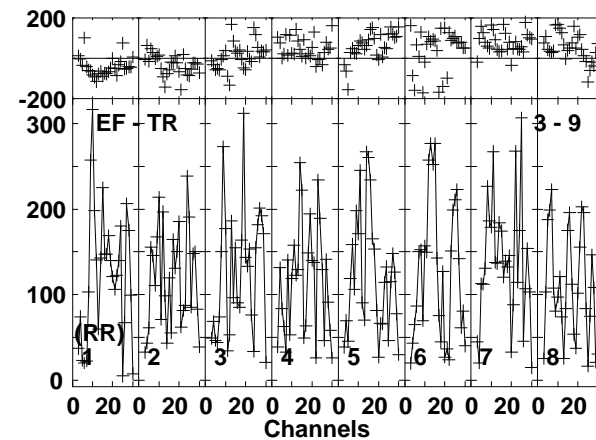
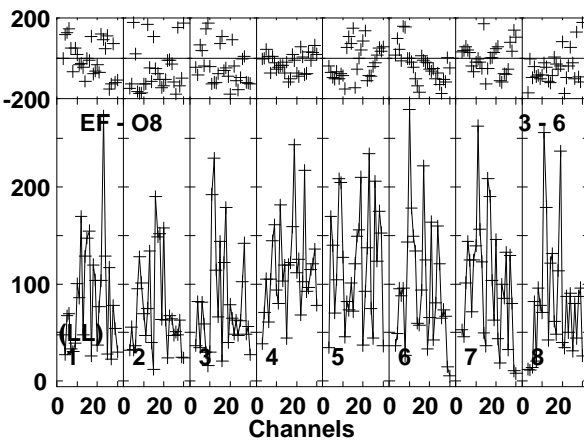
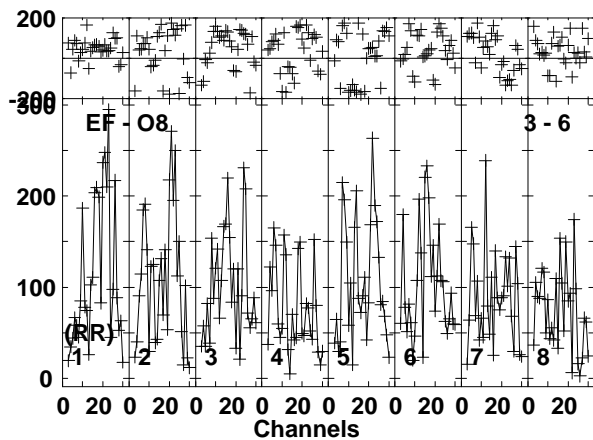
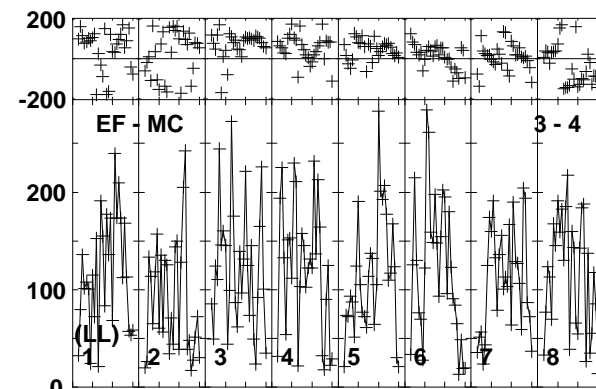
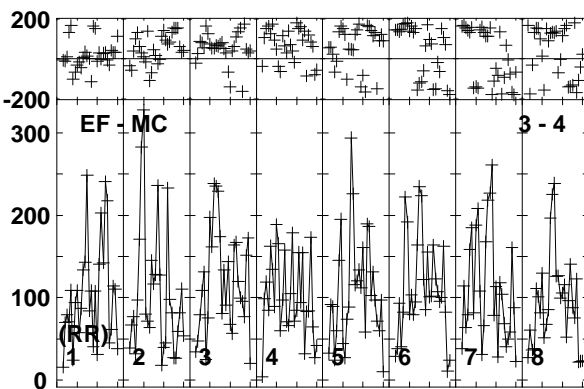
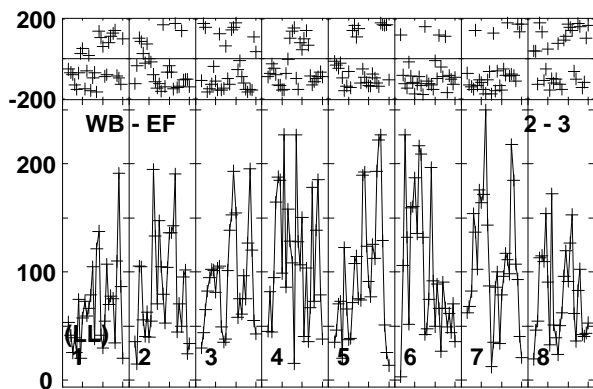
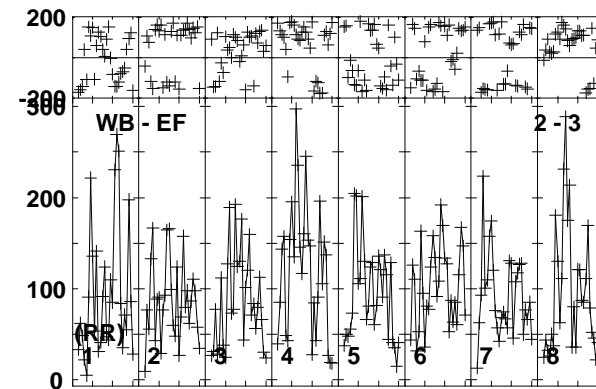
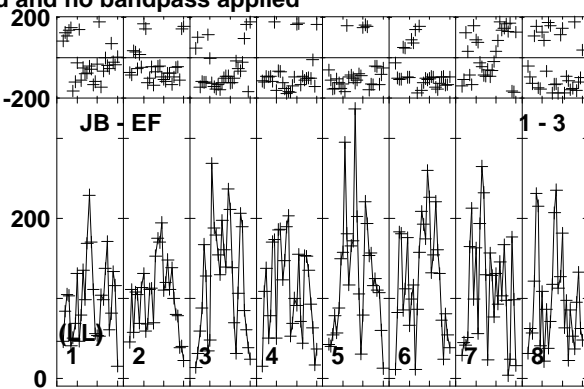
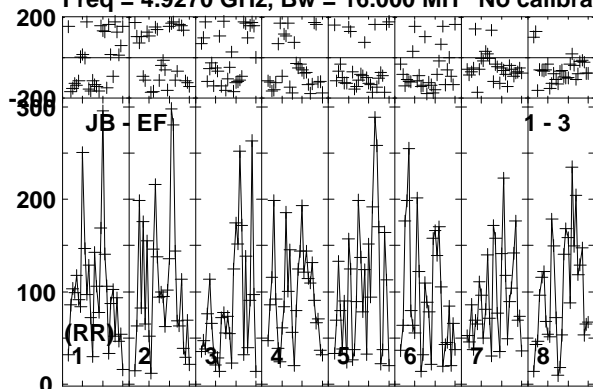

Lower frame: Micro Ampl Jy Top frame: Phas deg  
Vector averaged cross-power spectrum Baseline: JB (01) - EF (03)  
Timerange: 00/17:26:01 to 00/17:28:59

Plot file version 901 created 19-DEC-2018 17:59:11

AT2018\_RY007C.UVDATA.1

Freq = 4.9270 GHz, Bw = 16.000 MH No calibration applied and no bandpass applied

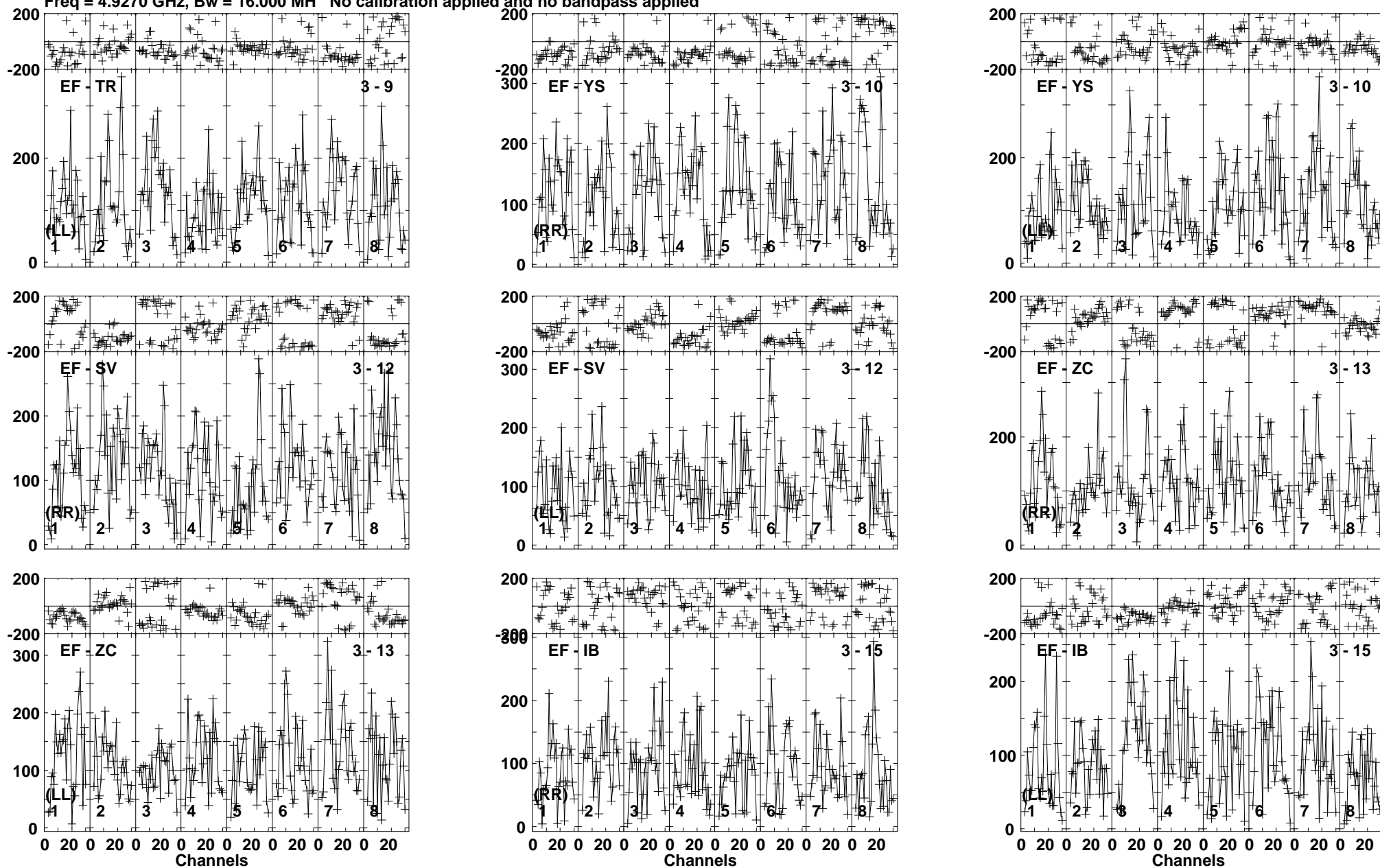

Lower frame: Micro Ampl Jy Top frame: Phas deg  
Vector averaged cross-power spectrum Baseline: EF (03) - TR (09)  
Timerange: 00/17:26:01 to 00/17:28:59

Plot file version 902 created 19-DEC-2018 17:59:11

AT2018\_RY007C.UVDATA.1

Freq = 4.9270 GHz, Bw = 16.000 MH No calibration applied and no bandpass applied

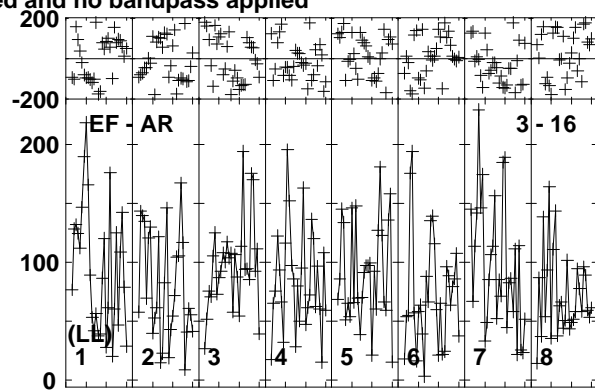
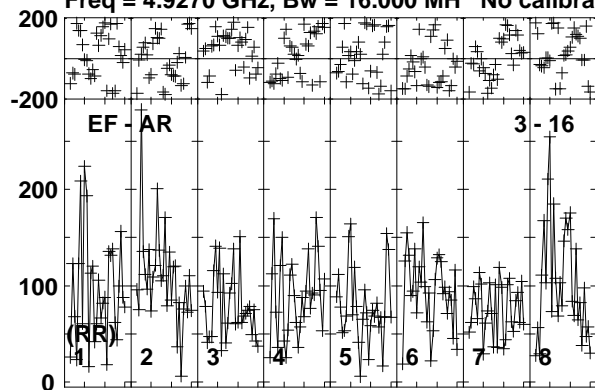

Lower frame: Micro Ampl Jy Top frame: Phas deg  
Vector averaged cross-power spectrum Baseline: EF (03) - AR (16)  
Timerange: 00/17:26:01 to 00/17:28:59

Plot file version 903 created 19-DEC-2018 17:59:11

J1619+2247 RY007C.UVDATA.1

Freq = 4.9270 GHz, Bw = 16.000 MH No calibration applied and no bandpass applied

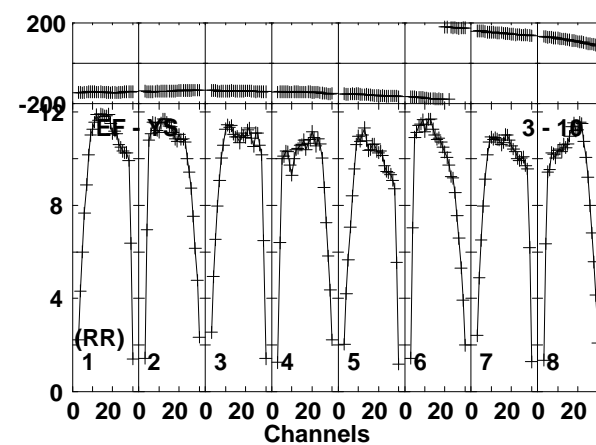
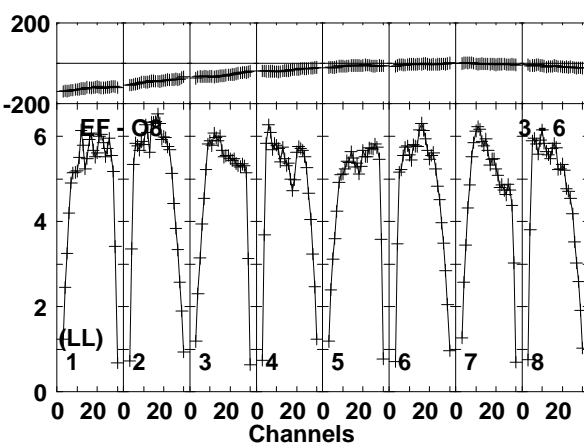
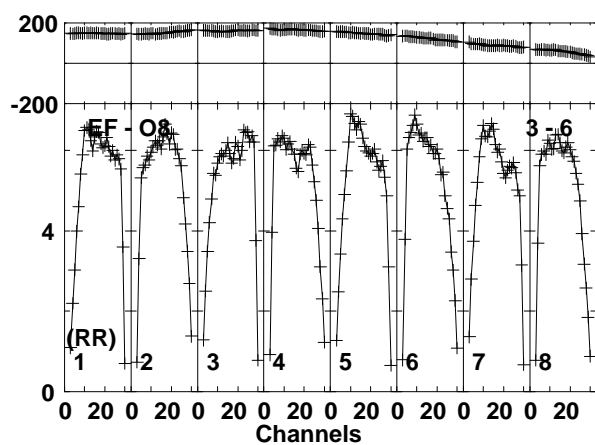
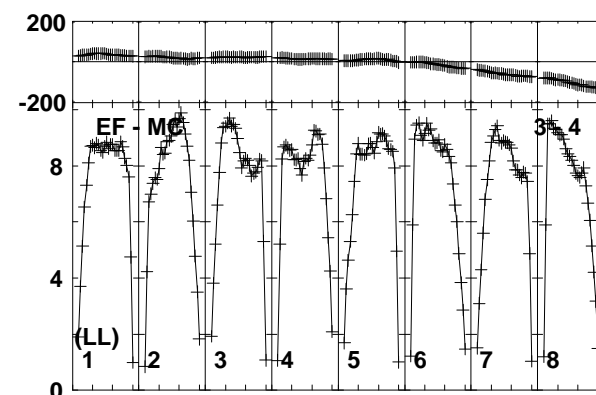
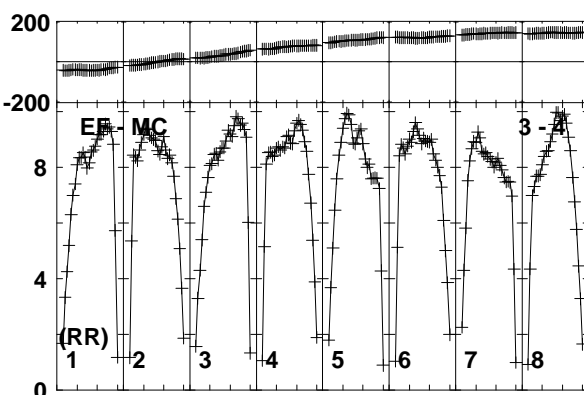
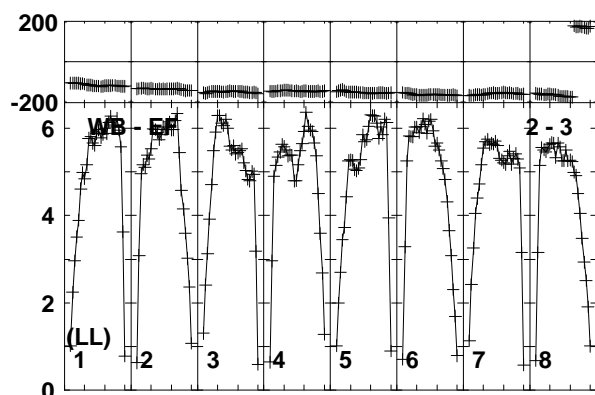
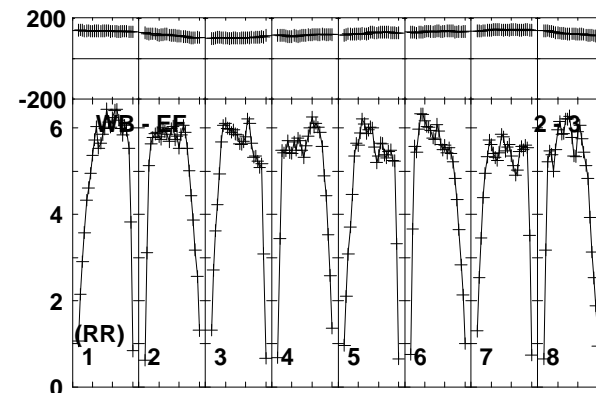
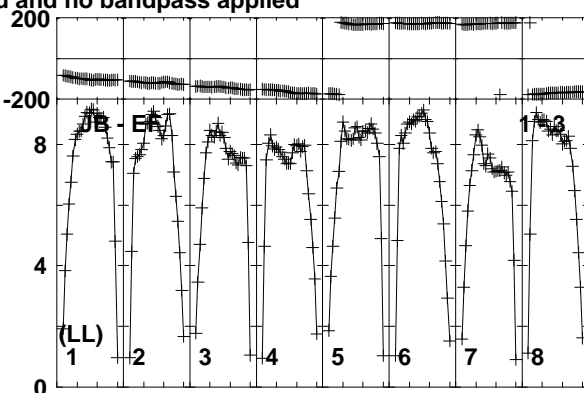
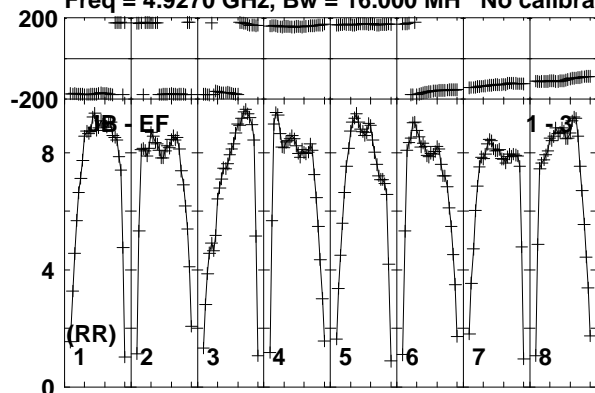

Lower frame: Milli Ampl Jy Top frame: Phas deg  
Vector averaged cross-power spectrum Baseline: JB (01) - EF (03)  
Timerange: 00/17:29:01 to 00/17:29:59

Plot file version 904 created 19-DEC-2018 17:59:11

J1619+2247 RY007C.UVDATA.1

Freq = 4.9270 GHz, Bw = 16.000 MH No calibration applied and no bandpass applied

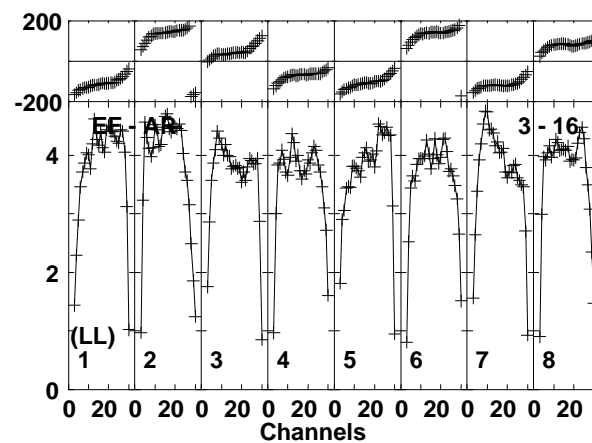
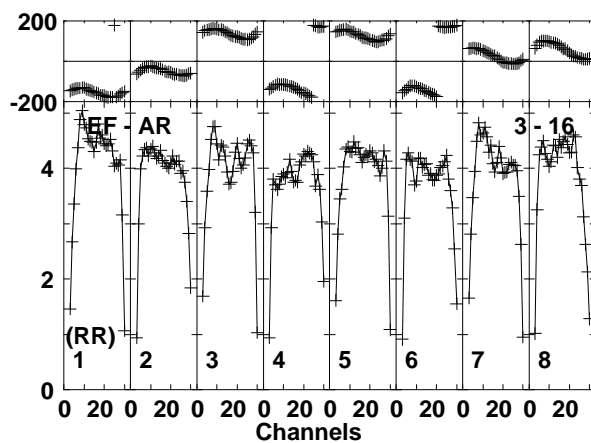
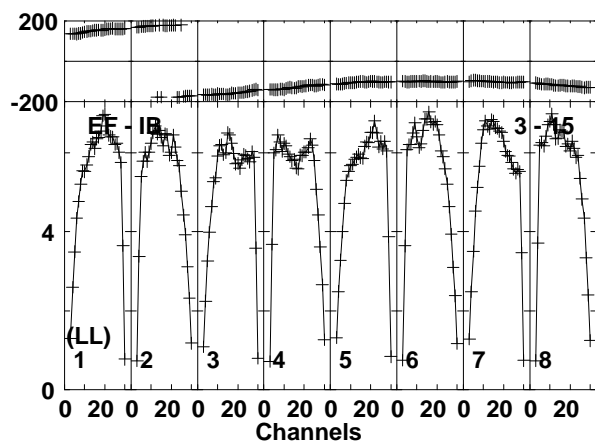
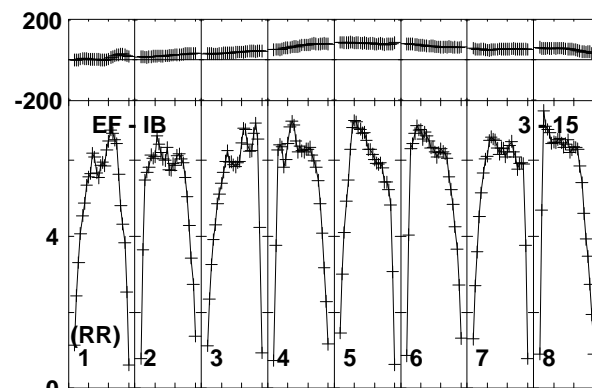
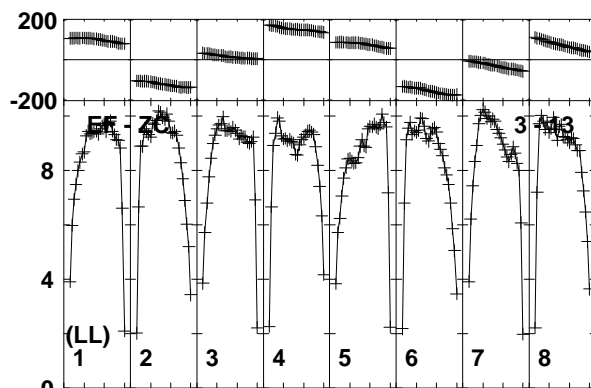
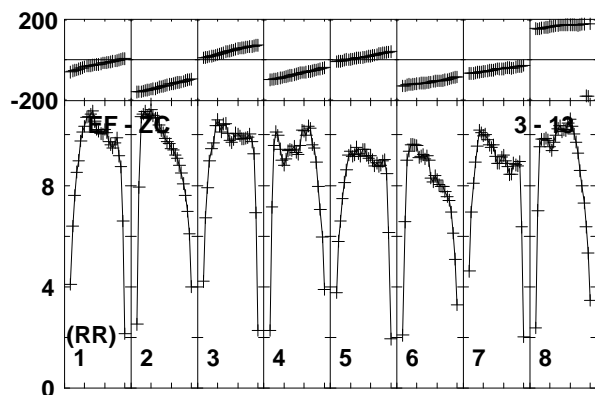
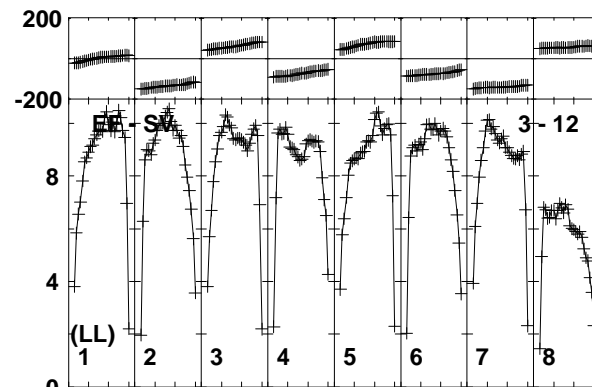
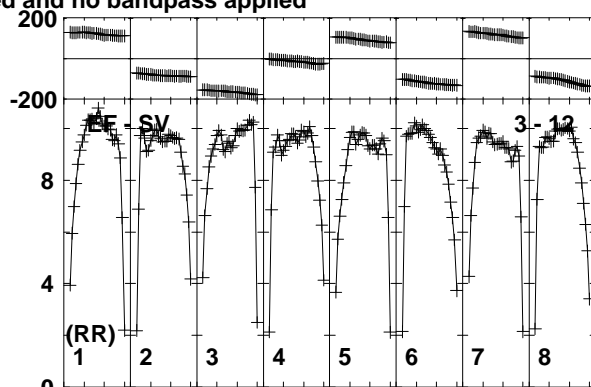
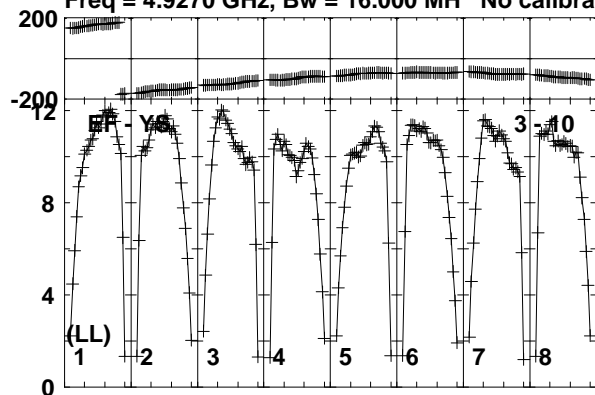

Lower frame: Milli Ampl Jy Top frame: Phas deg  
Vector averaged cross-power spectrum Baseline: EF (03) - YS (10)  
Timerange: 00/17:29:01 to 00/17:29:59

Plot file version 905 created 19-DEC-2018 17:59:11

AT2018\_RY007C.UVDATA.1

Freq = 4.9270 GHz, Bw = 16.000 MH No calibration applied and no bandpass applied

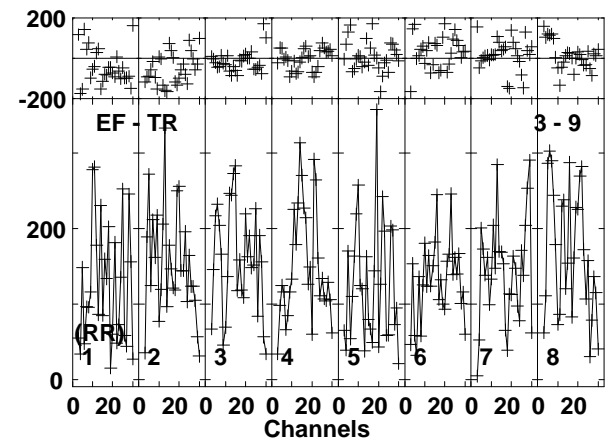
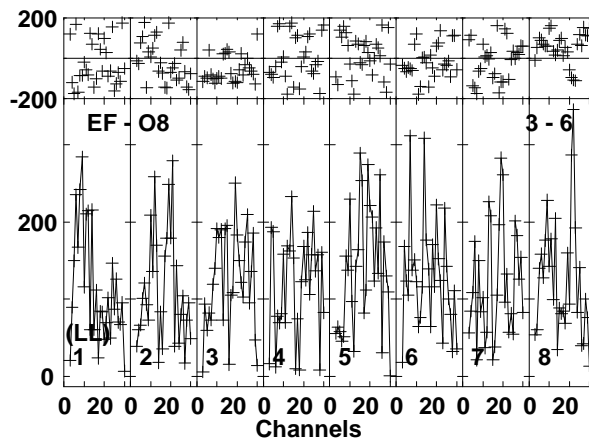
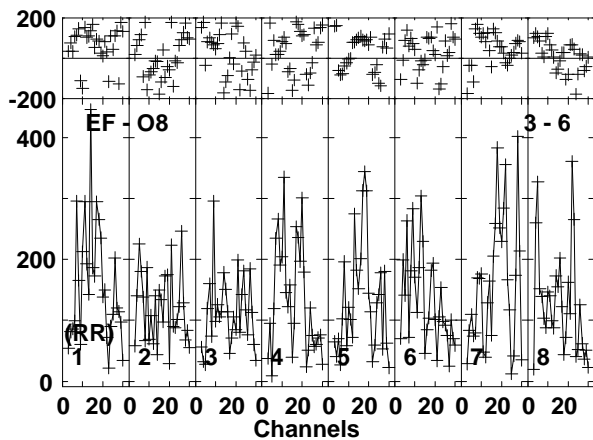
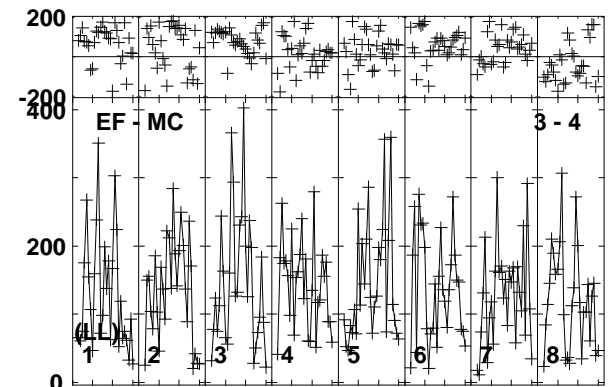
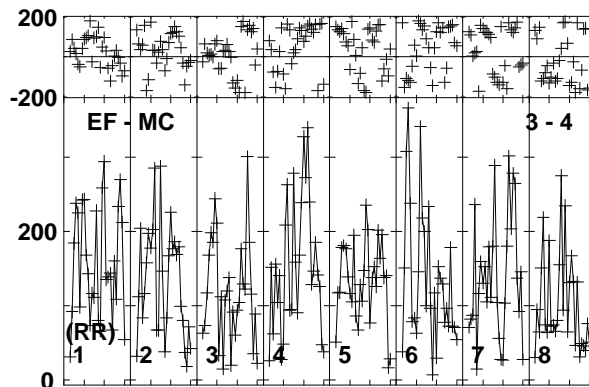
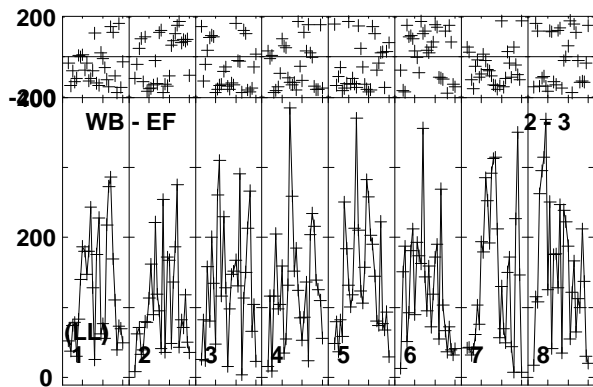
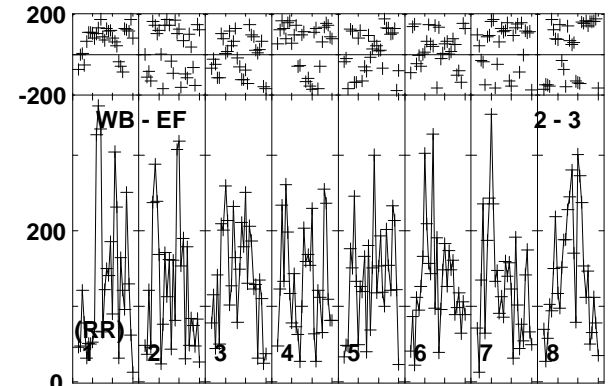
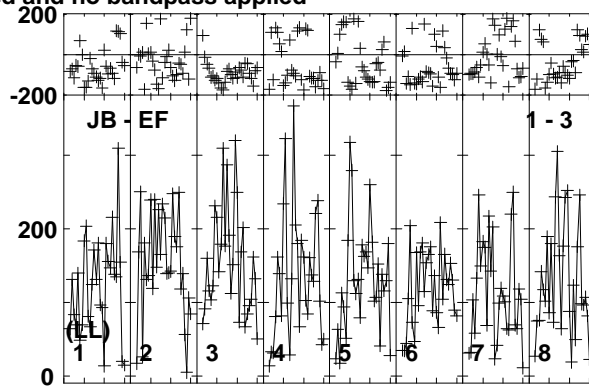
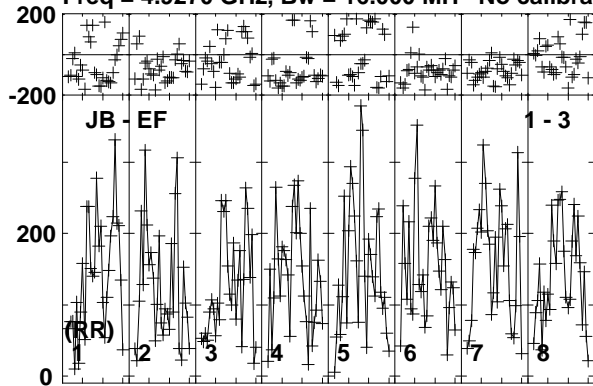

Lower frame: Micro Ampl Jy Top frame: Phas deg  
Vector averaged cross-power spectrum Baseline: JB (01) - EF (03)  
Timerange: 00/17:30:01 to 00/17:31:59

Plot file version 906 created 19-DEC-2018 17:59:11

AT2018\_RY007C.UVDATA.1

Freq = 4.9270 GHz, Bw = 16.000 MH No calibration applied and no bandpass applied

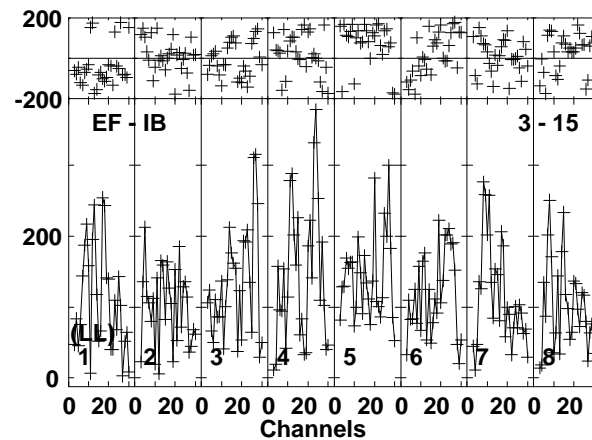
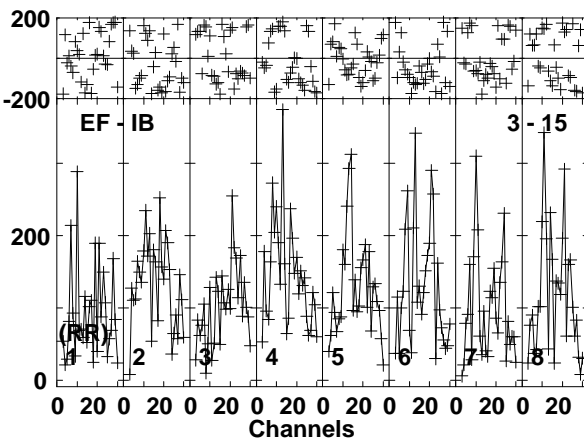
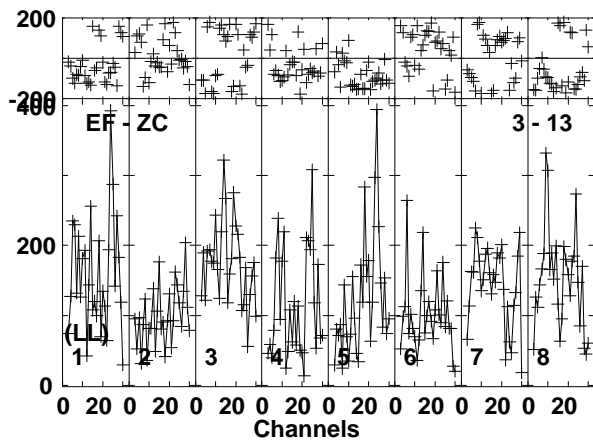
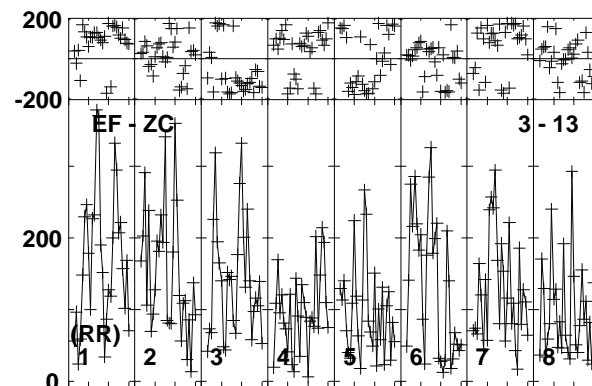
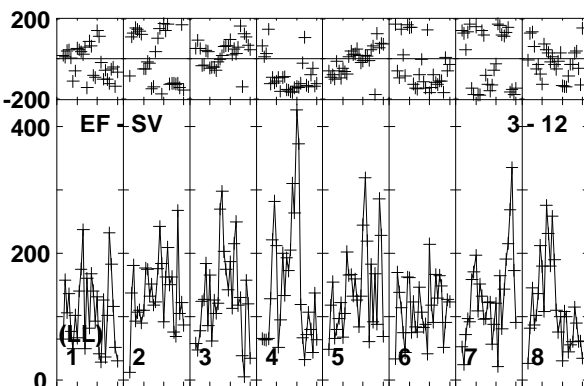
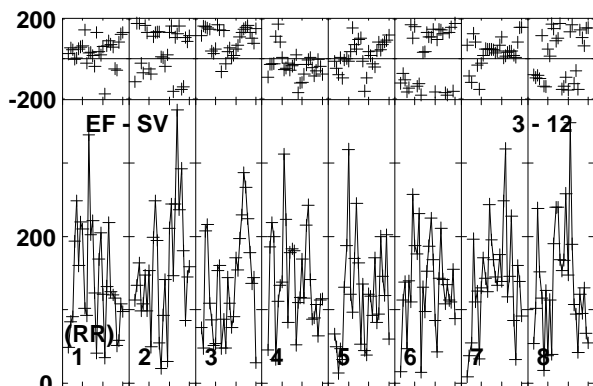
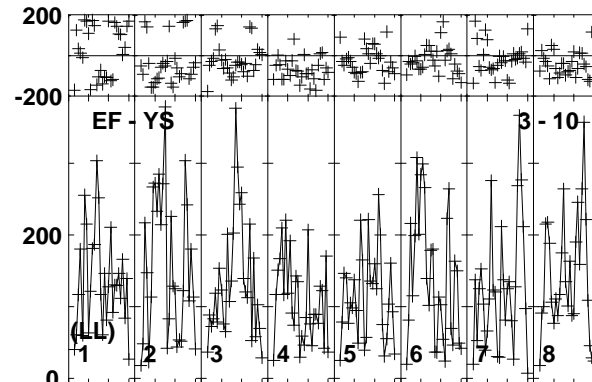
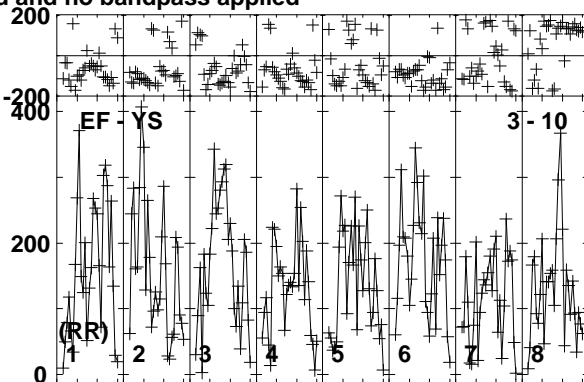
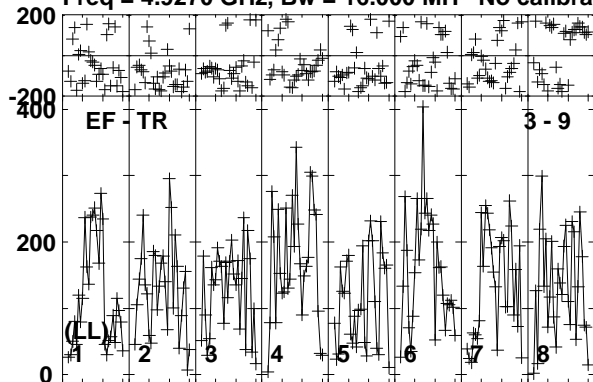

Lower frame: Micro Ampl Jy Top frame: Phas deg  
Vector averaged cross-power spectrum Baseline: EF (03) - TR (09)  
Timerange: 00/17:30:01 to 00/17:31:59



Plot file version 907 created 19-DEC-2018 17:59:11

AT2018\_RY007C.UVDATA.1

Freq = 4.9270 GHz, Bw = 16.000 MH No calibration applied and no bandpass applied

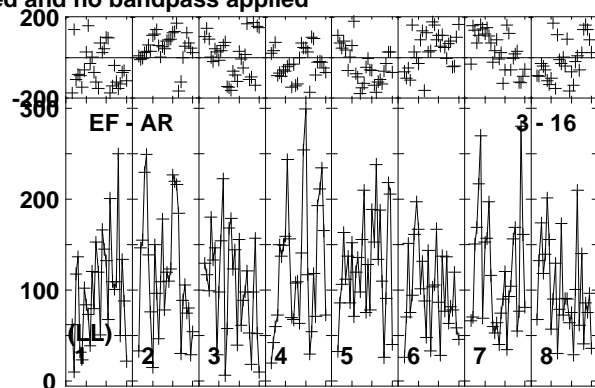
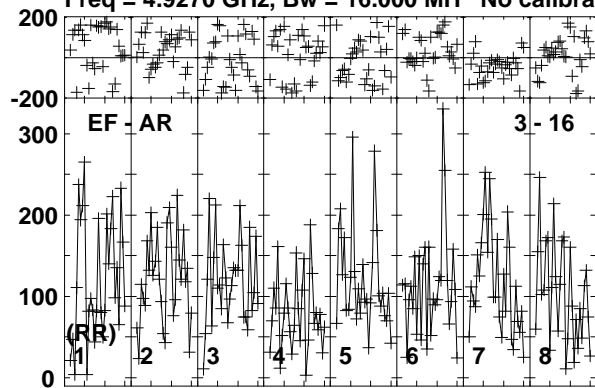

Lower frame: Micro Ampl Jy Top frame: Phas deg  
Vector averaged cross-power spectrum Baseline: EF (03) - AR (16)  
Timerange: 00/17:30:01 to 00/17:31:59

Plot file version 908 created 19-DEC-2018 17:59:11

VLA2 RY007C.UVDATA.1

Freq = 4.9270 GHz, Bw = 16.000 MH No calibration applied and no bandpass applied

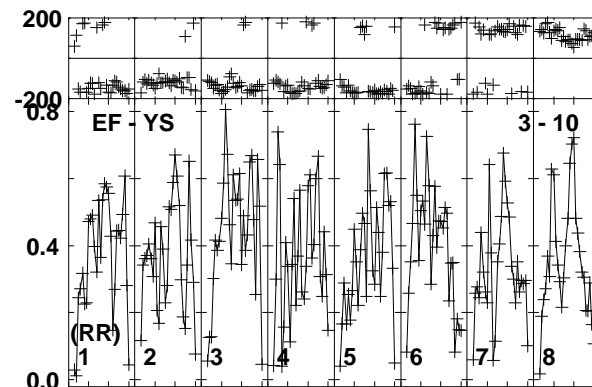
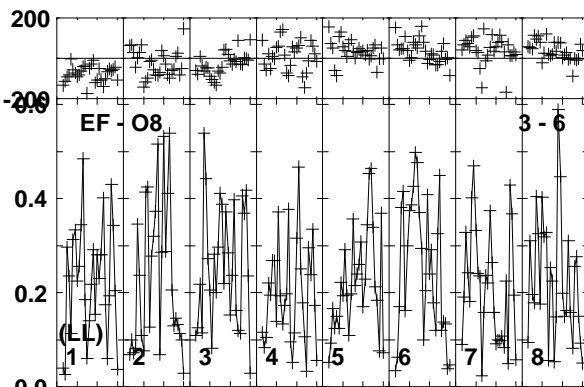
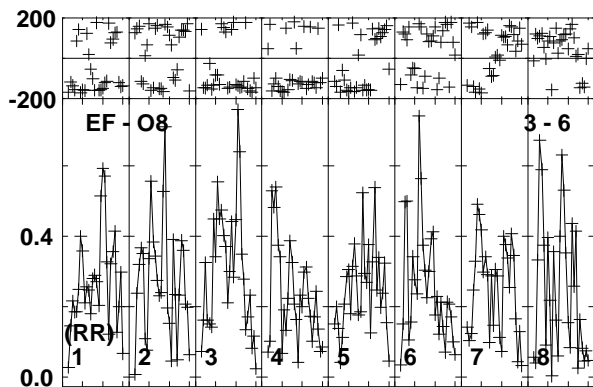
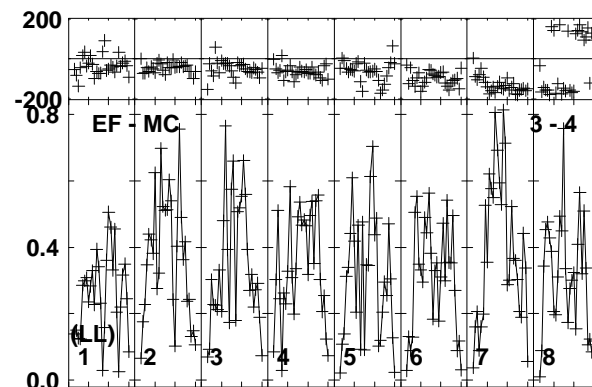
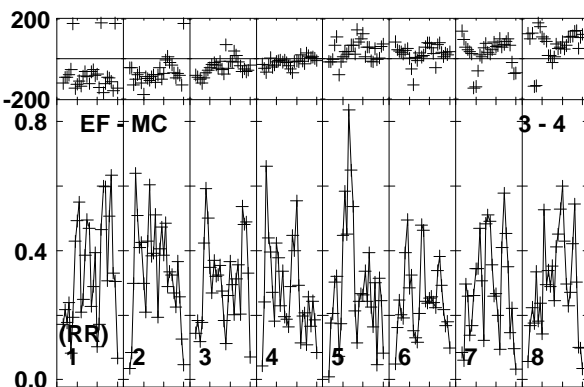
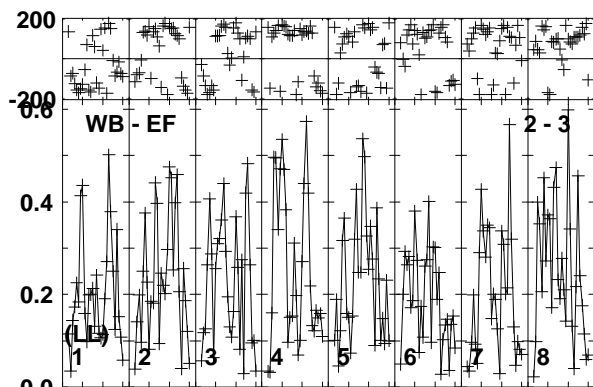
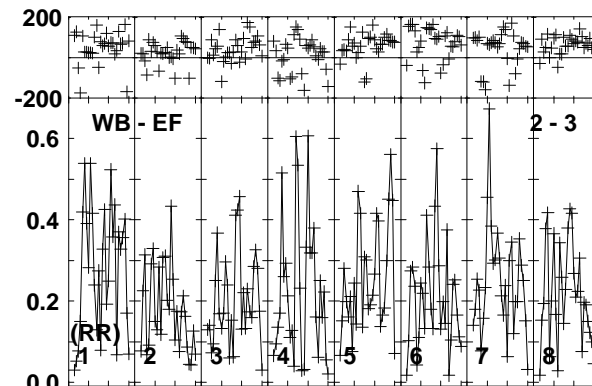
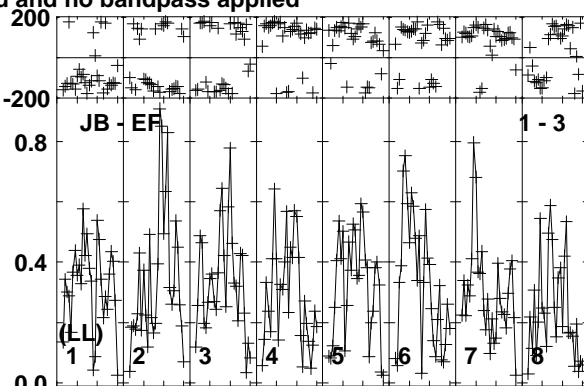
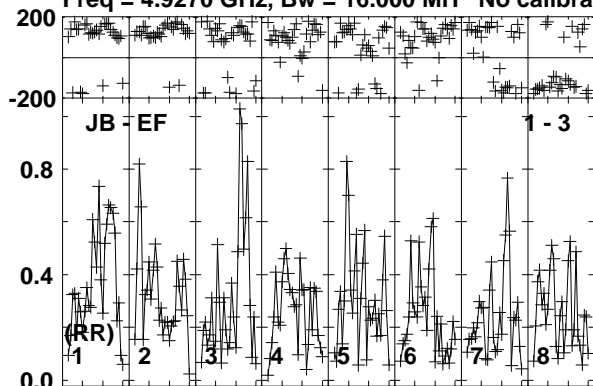

Lower frame: Milli Ampl Jy Top frame: Phas deg  
Vector averaged cross-power spectrum Baseline: JB (01) - EF (03)  
Timerange: 00/17:32:01 to 00/17:32:59

Plot file version 909 created 19-DEC-2018 17:59:11

VLA2 RY007C.UVDATA.1

Freq = 4.9270 GHz, Bw = 16.000 MH No calibration applied and no bandpass applied

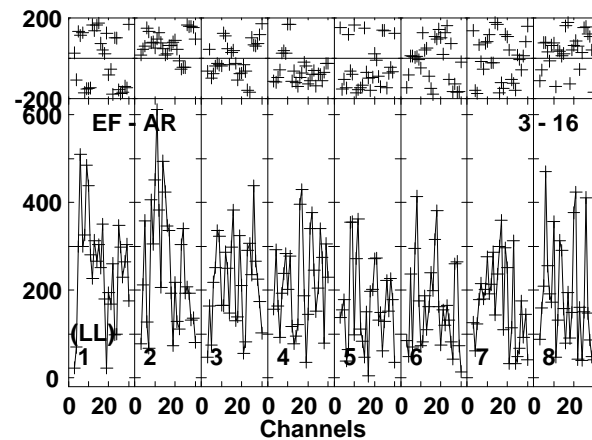
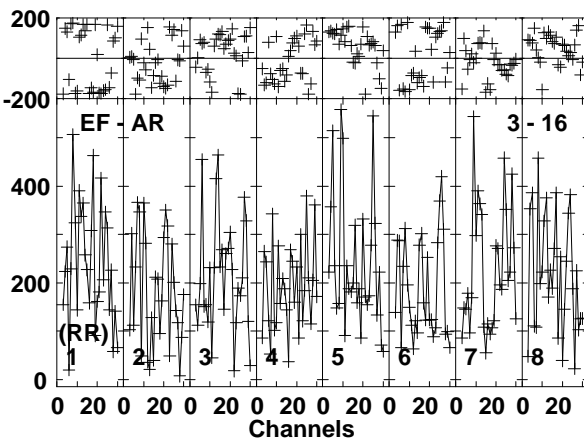
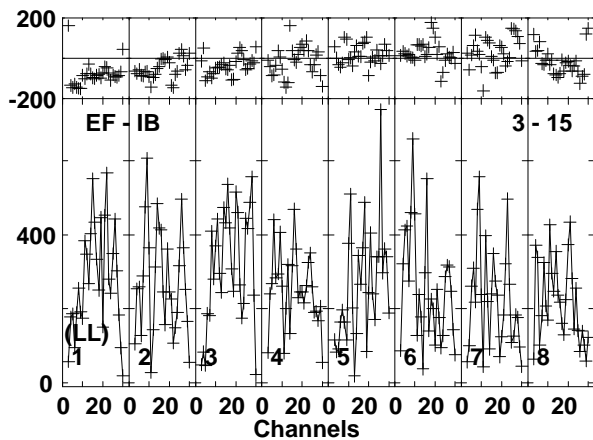
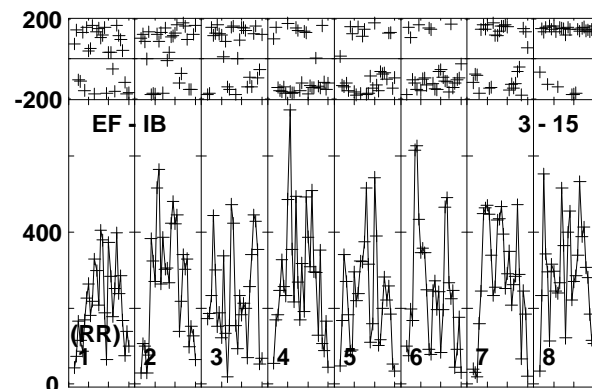
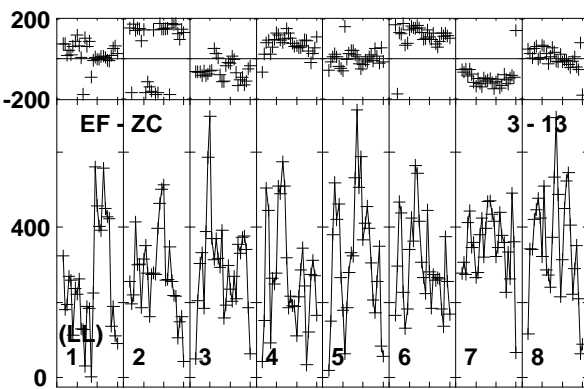
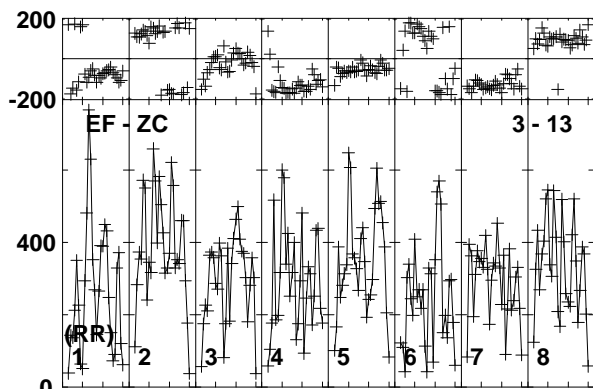
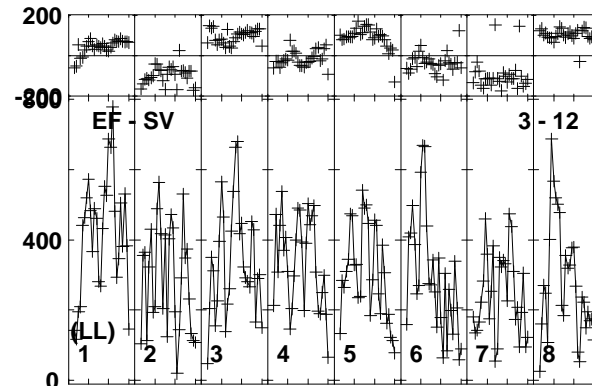
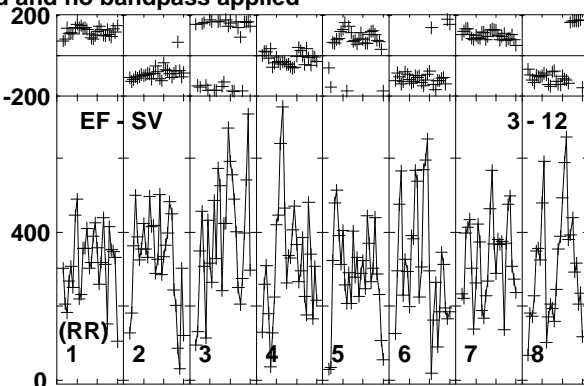
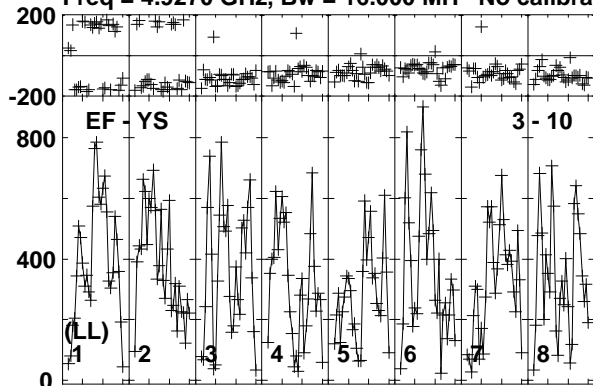

Lower frame: Micro Ampl Jy Top frame: Phas deg  
Vector averaged cross-power spectrum Baseline: EF (03) - YS (10)  
Timerange: 00/17:32:01 to 00/17:32:59

Plot file version 910 created 19-DEC-2018 17:59:11

J1619+2247 RY007C.UVDATA.1

Freq = 4.9270 GHz, Bw = 16.000 MH No calibration applied and no bandpass applied

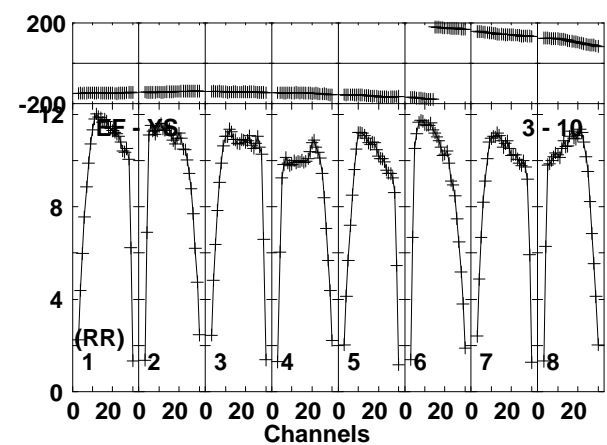
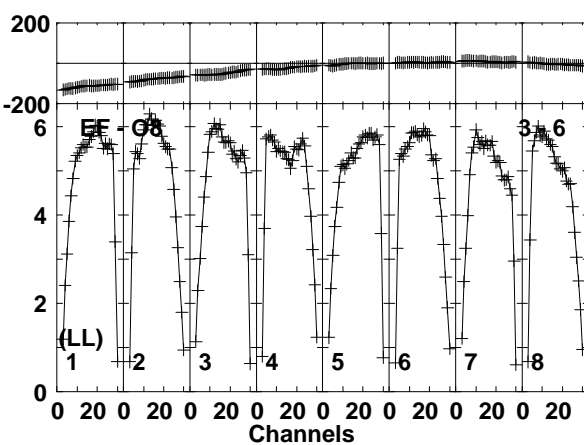
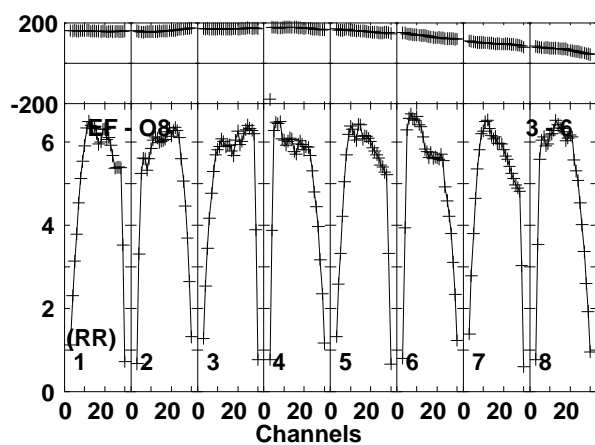
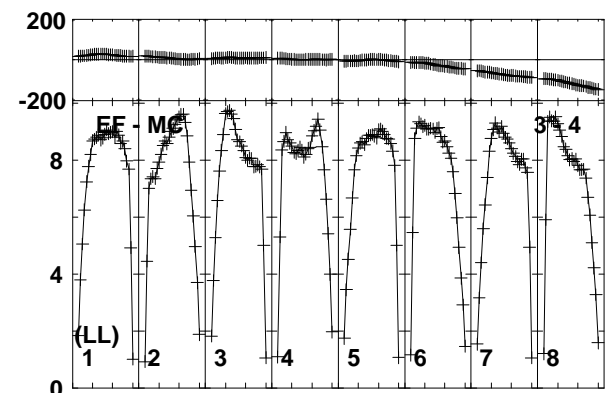
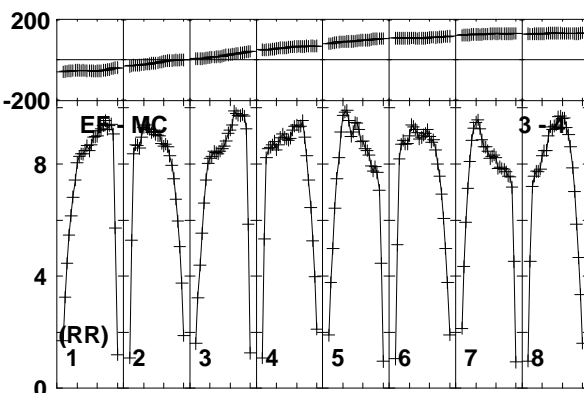
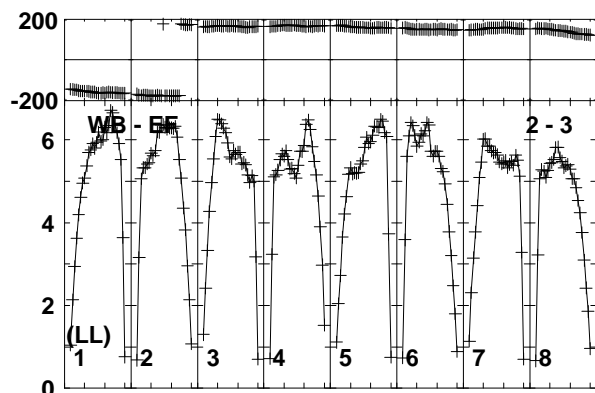
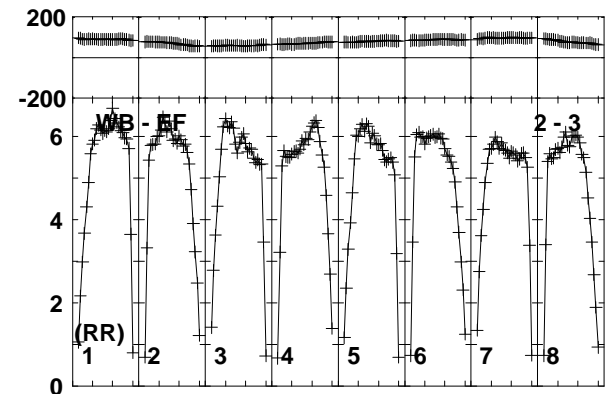
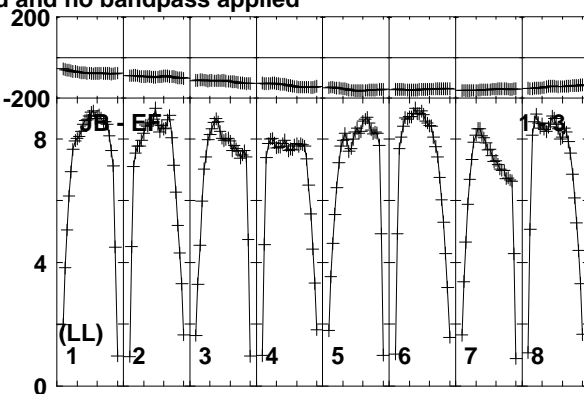
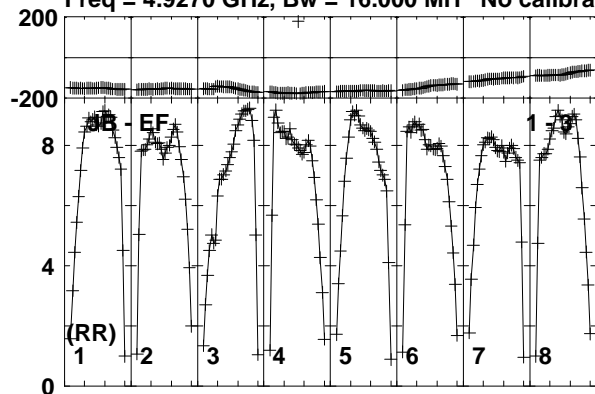

Lower frame: Milli Ampl Jy Top frame: Phas deg  
Vector averaged cross-power spectrum Baseline: JB (01) - EF (03)  
Timerange: 00/17:33:31 to 00/17:34:29

Plot file version 911 created 19-DEC-2018 17:59:11

J1619+2247 RY007C.UVDATA.1

Freq = 4.9270 GHz, Bw = 16.000 MH No calibration applied and no bandpass applied

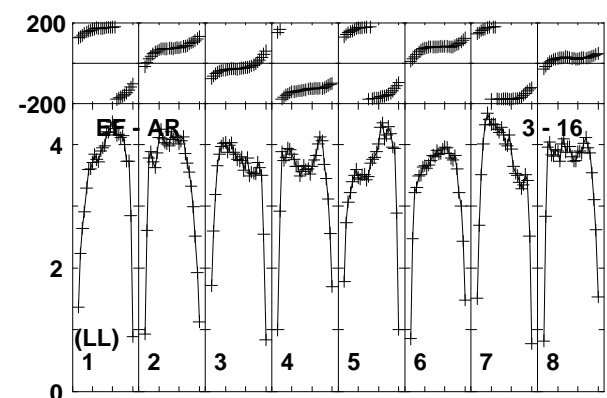
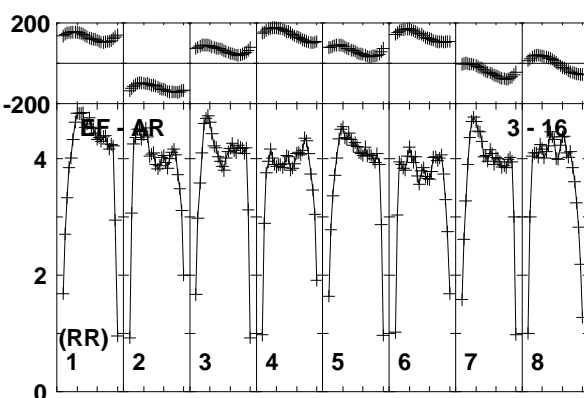
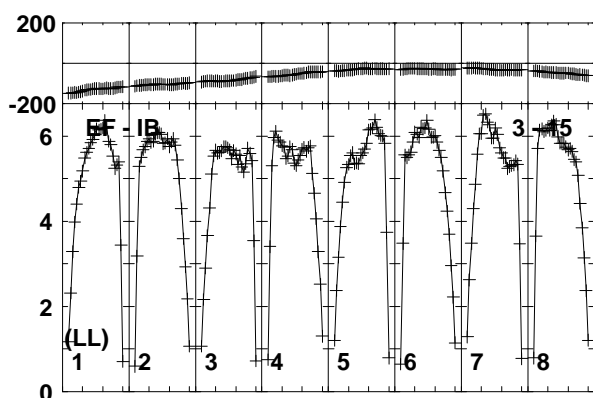
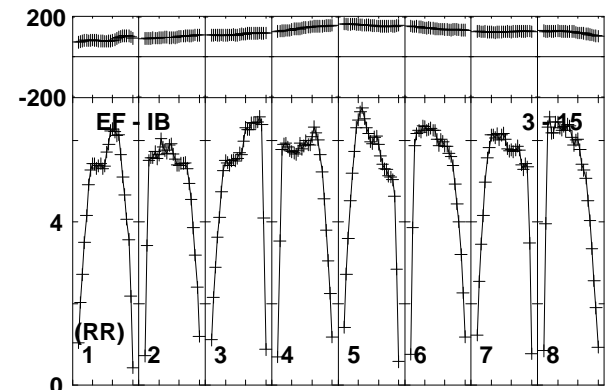
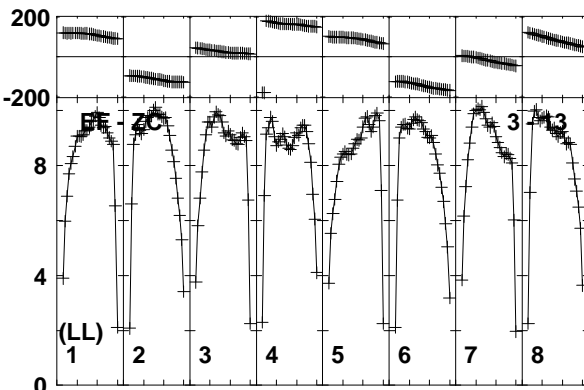
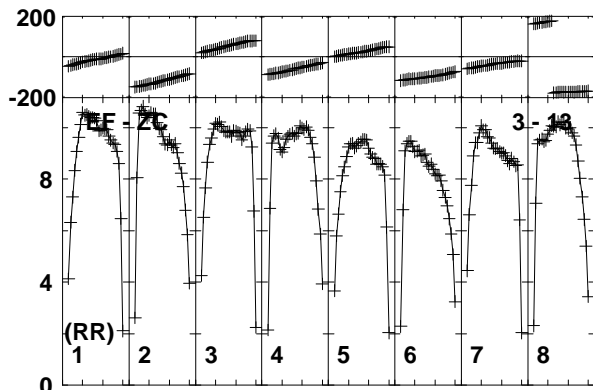
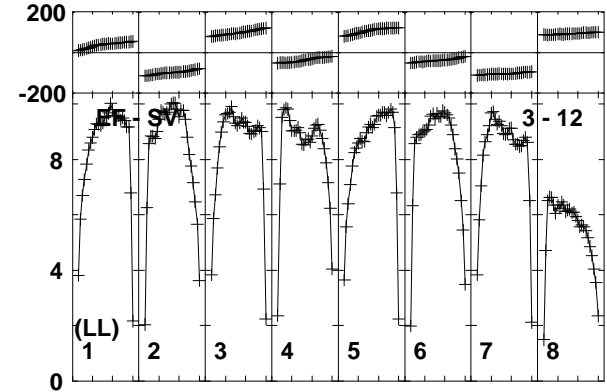
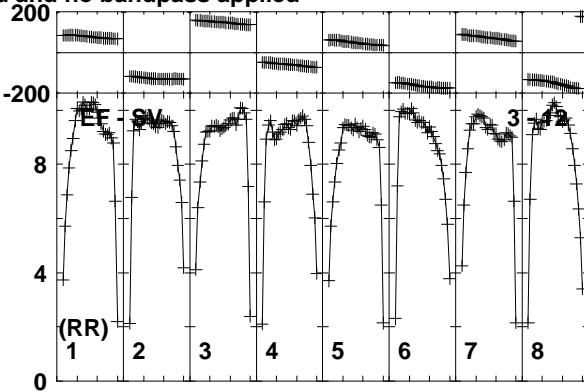
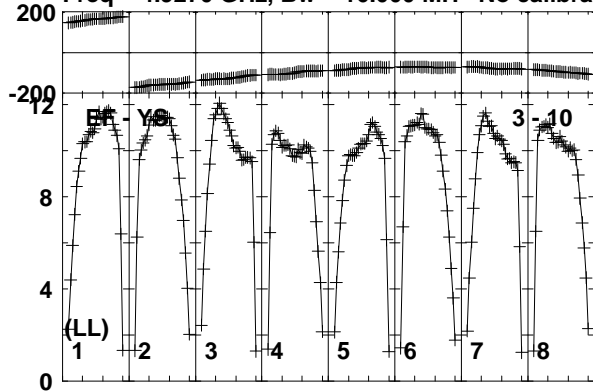

Lower frame: Milli Ampl Jy Top frame: Phas deg  
Vector averaged cross-power spectrum Baseline: EF (03) - YS (10)  
Timerange: 00/17:33:31 to 00/17:34:29

Plot file version 912 created 19-DEC-2018 17:59:11

AT2018\_RY007C.UVDATA.1

Freq = 4.9270 GHz, Bw = 16.000 MH No calibration applied and no bandpass applied

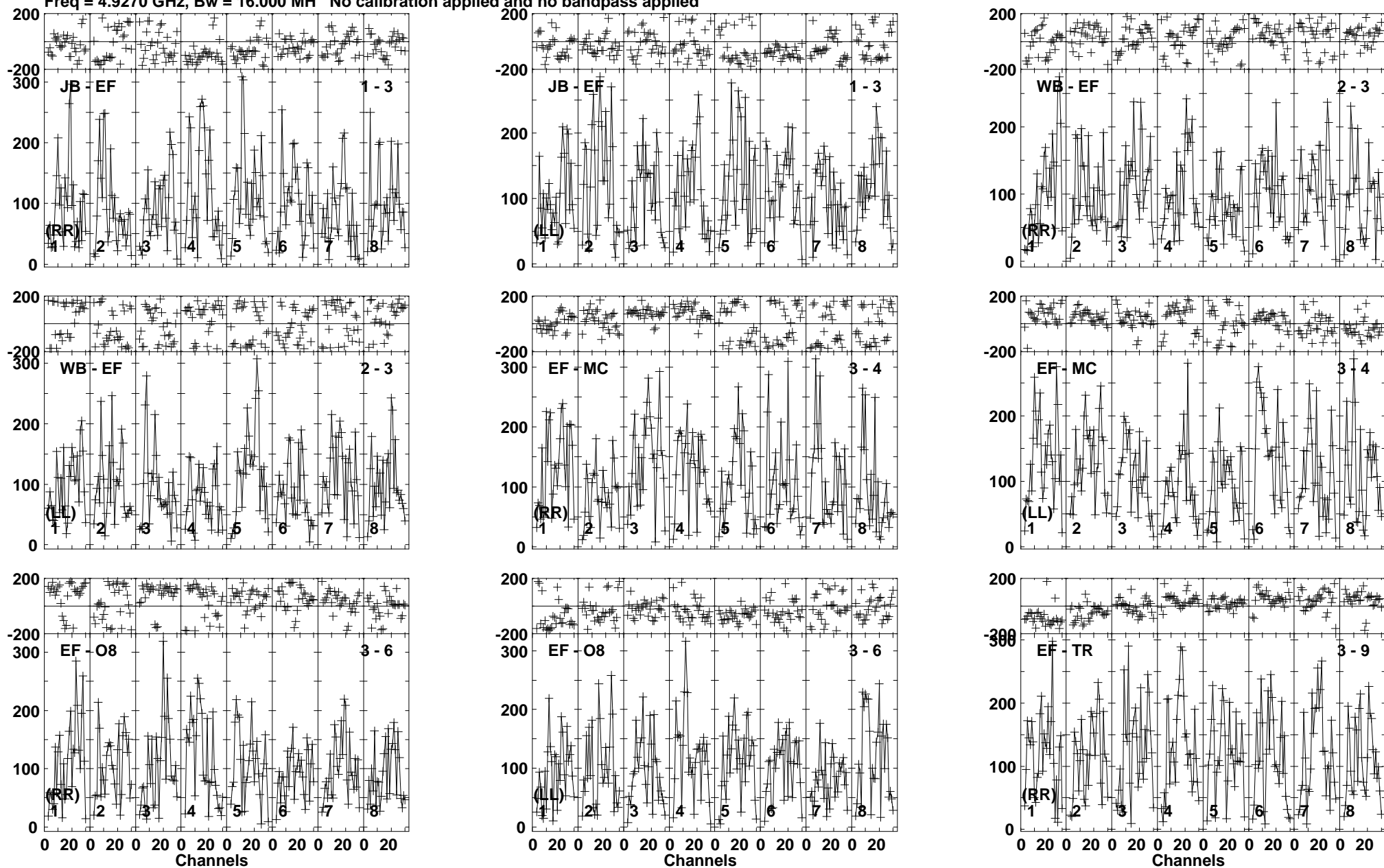

Lower frame: Micro Ampl Jy Top frame: Phas deg  
Vector averaged cross-power spectrum Baseline: JB (01) - EF (03)  
Timerange: 00/17:34:31 to 00/17:37:29

Plot file version 913 created 19-DEC-2018 17:59:11

AT2018\_RY007C.UVDATA.1

Freq = 4.9270 GHz, Bw = 16.000 MH No calibration applied and no bandpass applied

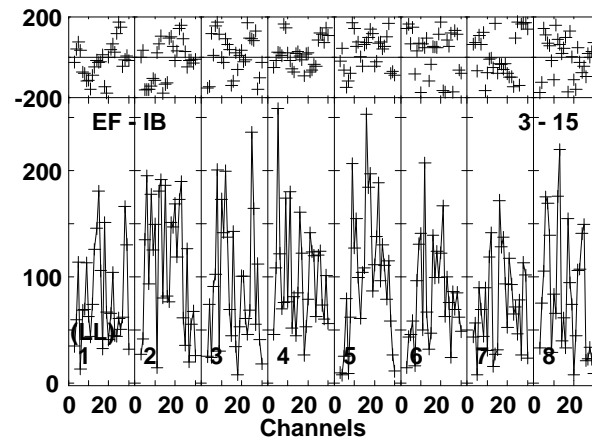
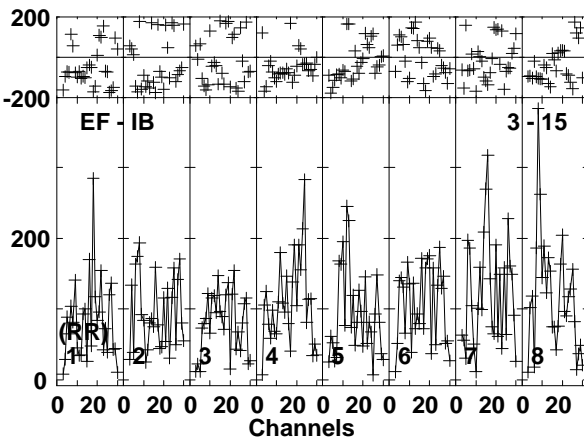
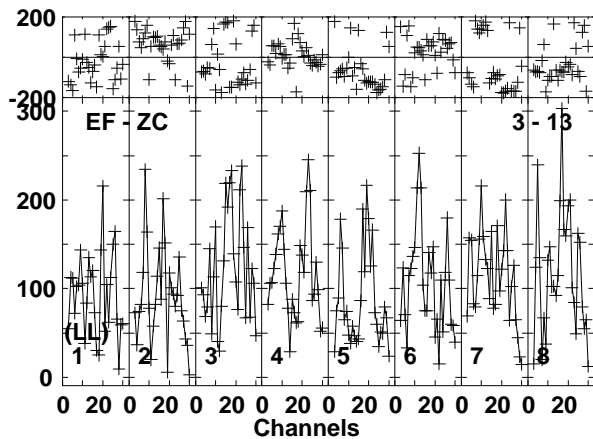
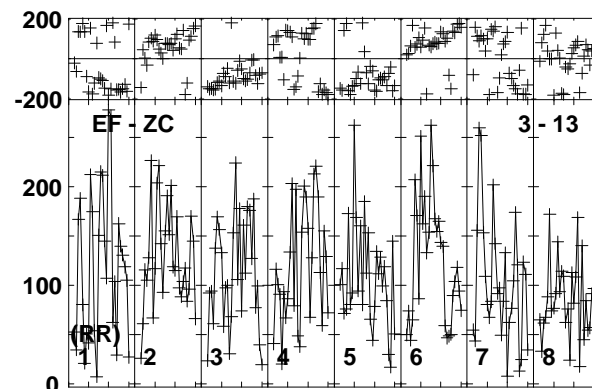
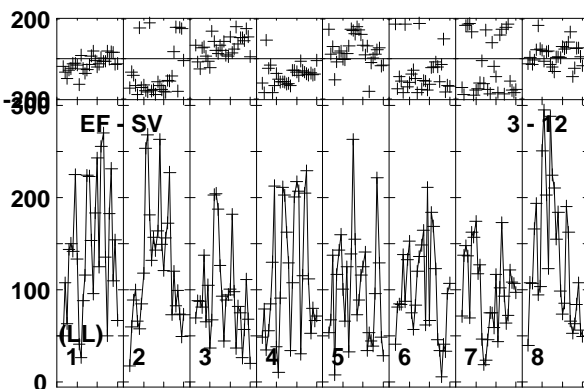
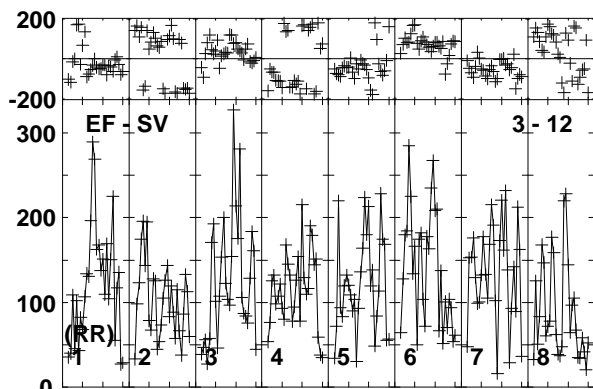
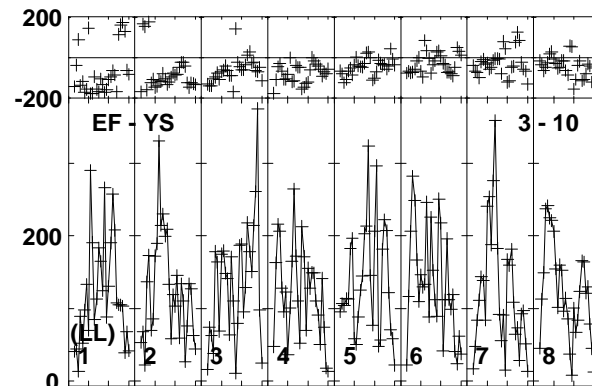
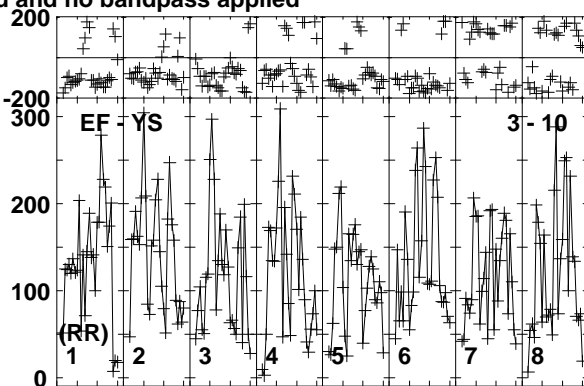
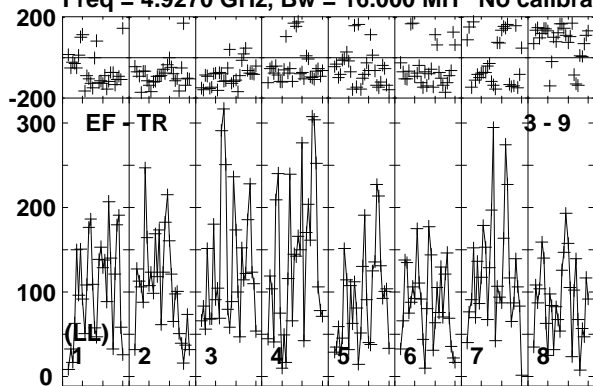

Lower frame: Micro Ampl Jy Top frame: Phas deg  
Vector averaged cross-power spectrum Baseline: EF (03) - TR (09)  
Timerange: 00/17:34:31 to 00/17:37:29

Plot file version 914 created 19-DEC-2018 17:59:12

AT2018\_RY007C.UVDATA.1

Freq = 4.9270 GHz, Bw = 16.000 MH No calibration applied and no bandpass applied

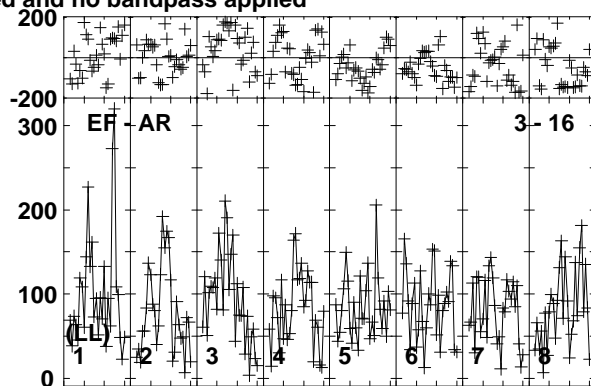
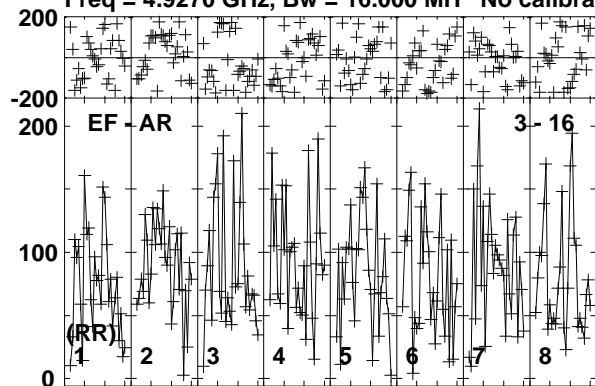

Lower frame: Micro Ampl Jy Top frame: Phas deg  
Vector averaged cross-power spectrum Baseline: EF (03) - AR (16)  
Timerange: 00/17:34:31 to 00/17:37:29



Plot file version 915 created 19-DEC-2018 17:59:12

J1619+2247 RY007C.UVDATA.1

Freq = 4.9270 GHz, Bw = 16.000 MH No calibration applied and no bandpass applied

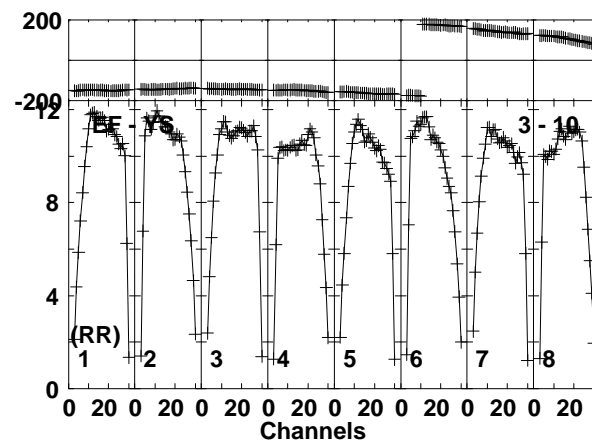
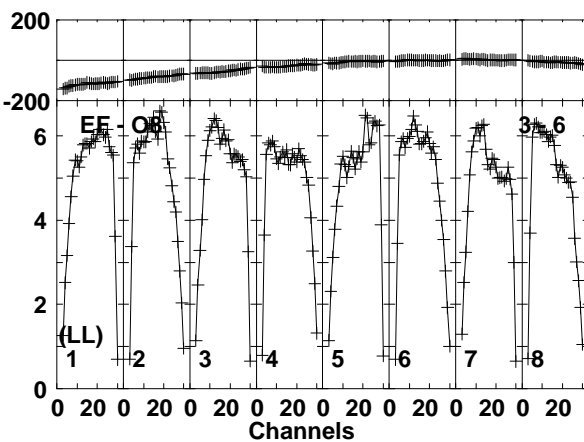
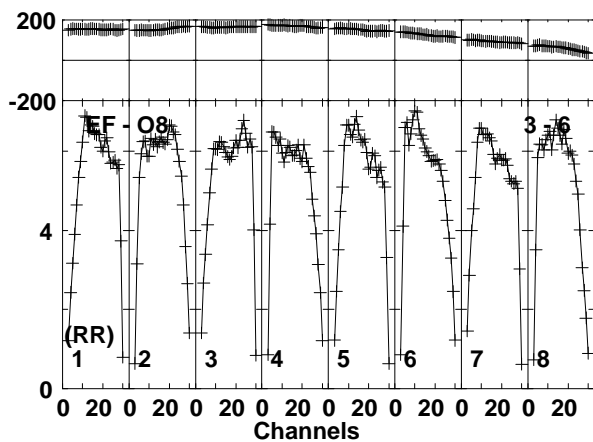
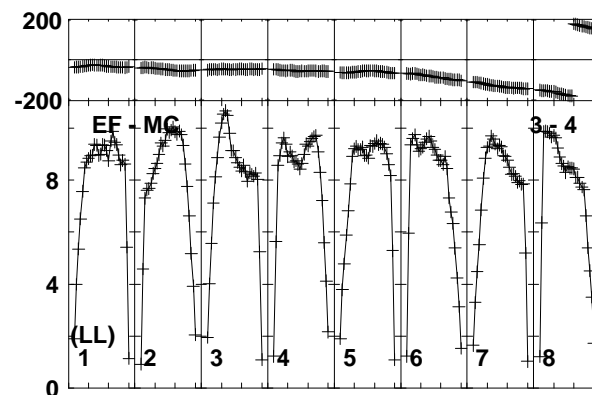
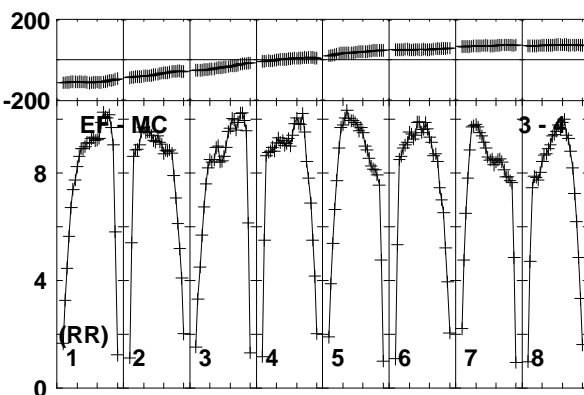
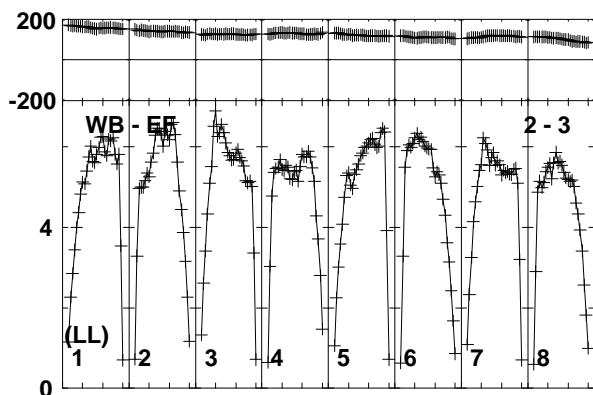
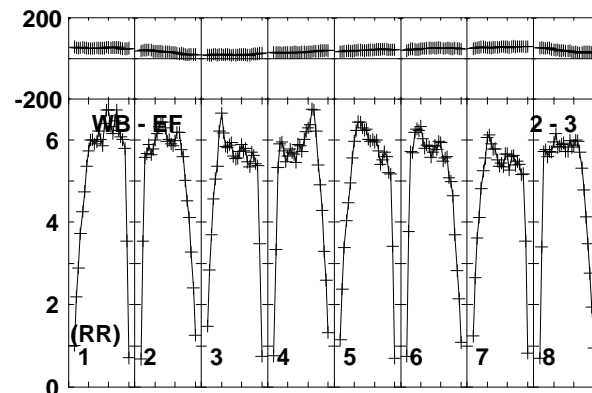
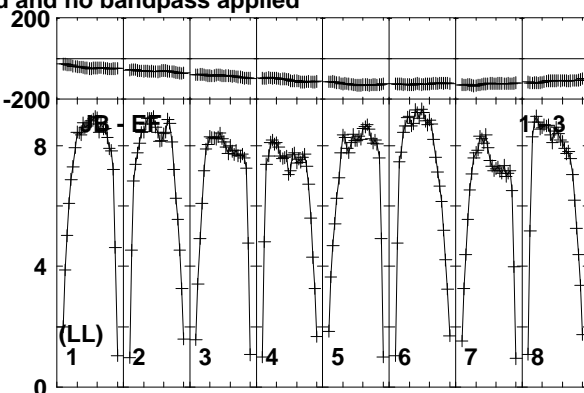
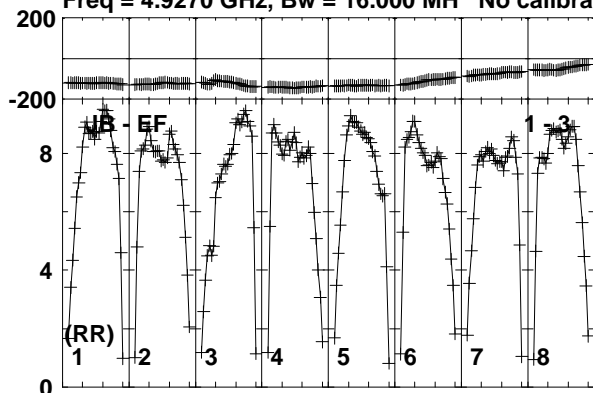

Lower frame: Milli Ampl Jy Top frame: Phas deg  
Vector averaged cross-power spectrum Baseline: JB (01) - EF (03)  
Timerange: 00:17:37:31 to 00:17:38:29

Plot file version 916 created 19-DEC-2018 17:59:12

J1619+2247 RY007C.UVDATA.1

Freq = 4.9270 GHz, Bw = 16.000 MH No calibration applied and no bandpass applied

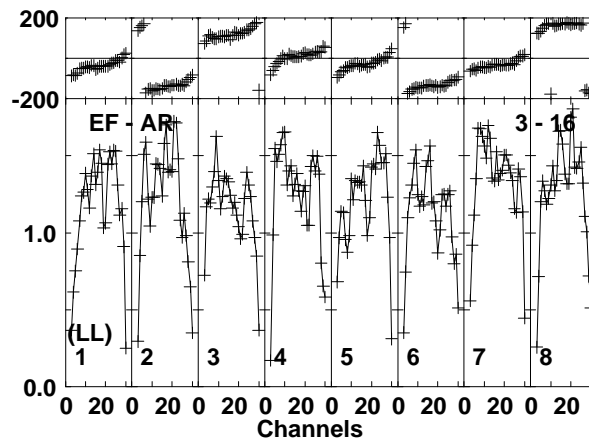
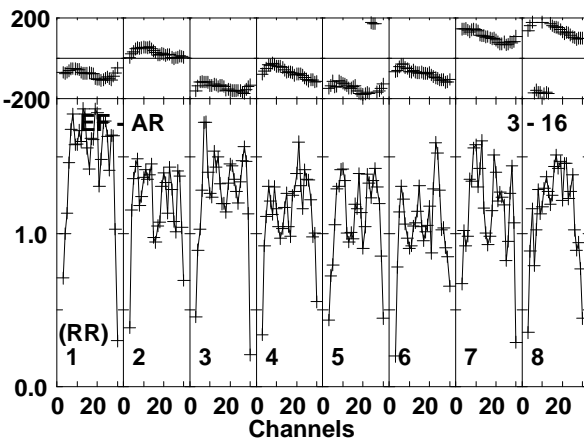
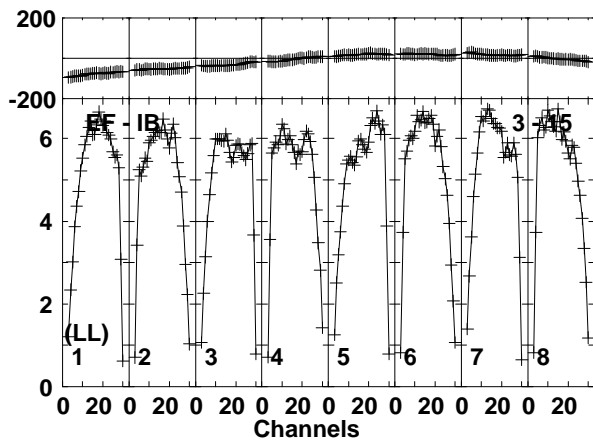
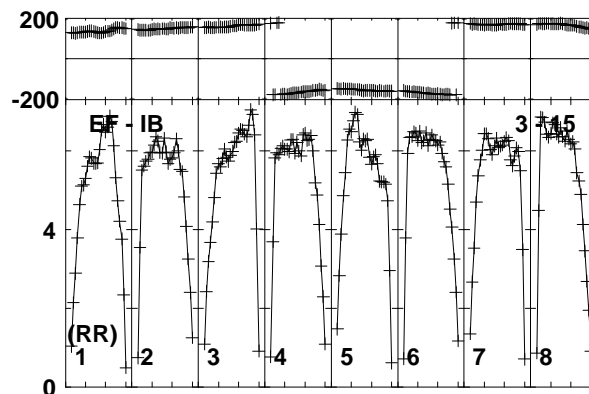
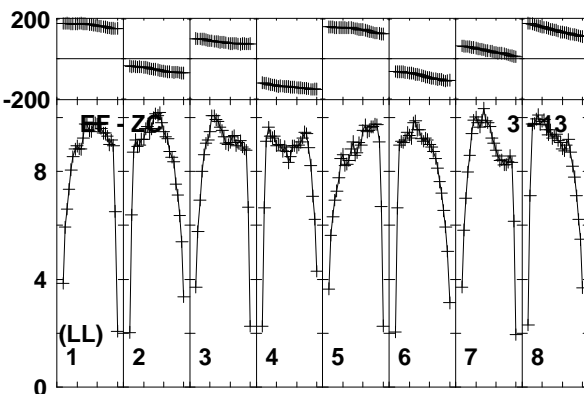
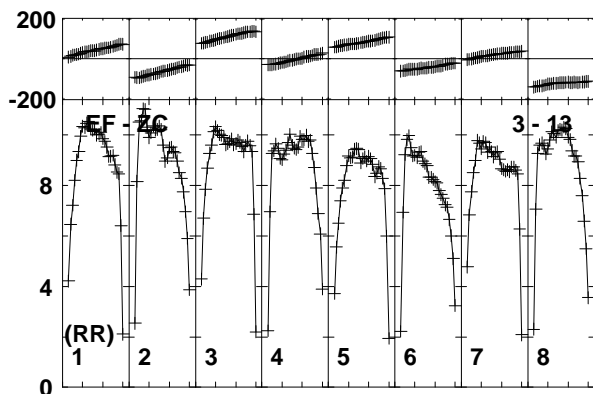
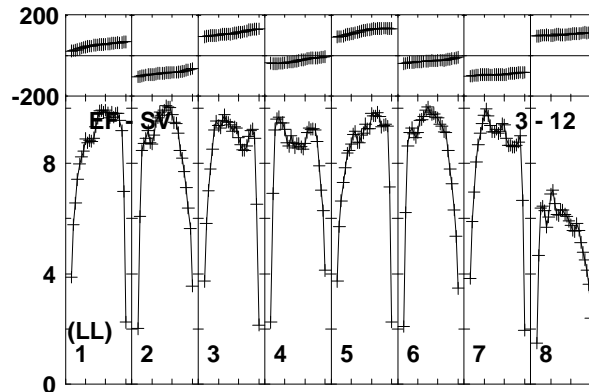
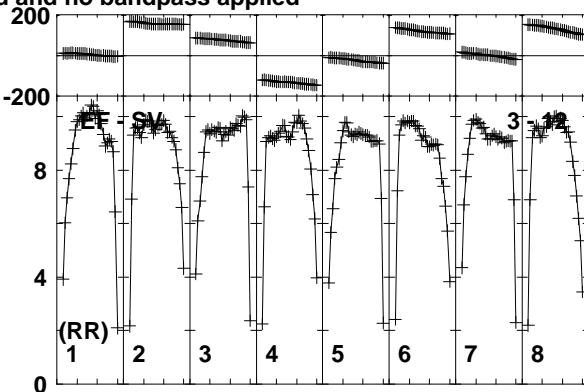
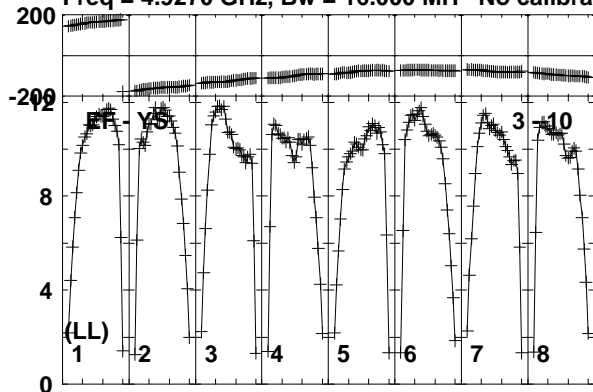

Lower frame: Milli Ampl Jy Top frame: Phas deg  
Vector averaged cross-power spectrum Baseline: EF (03) - YS (10)  
Timerange: 00/17:37:31 to 00/17:38:29

Plot file version 917 created 19-DEC-2018 17:59:12

AT2018\_RY007C.UVDATA.1

Freq = 4.9270 GHz, Bw = 16.000 MH No calibration applied and no bandpass applied

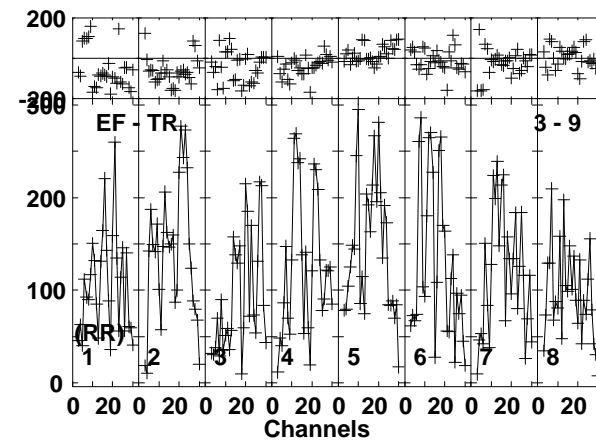
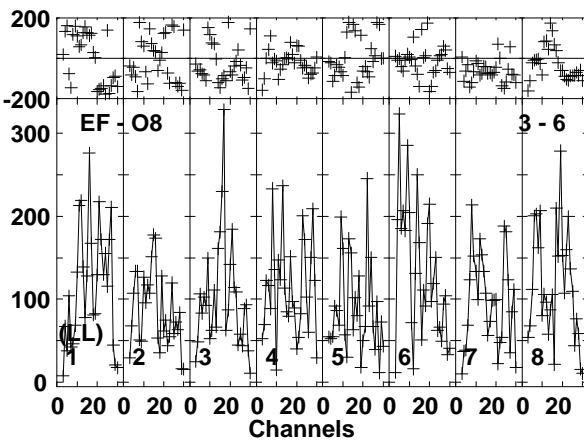
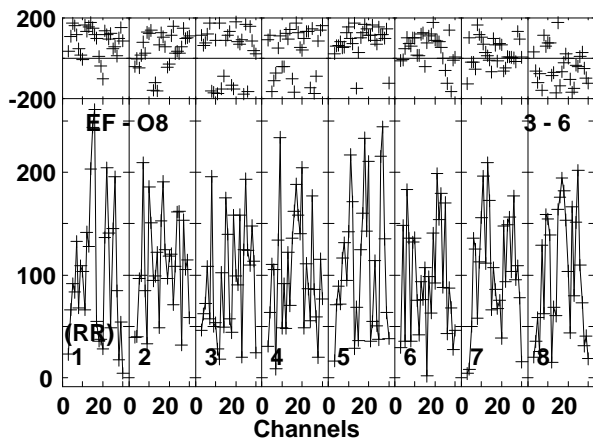
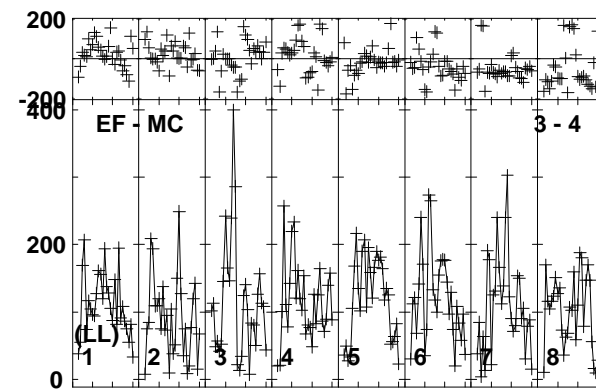
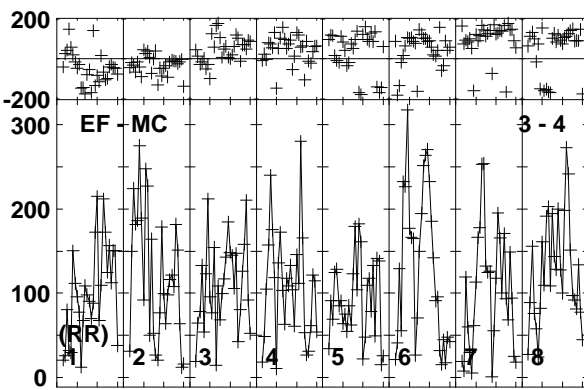
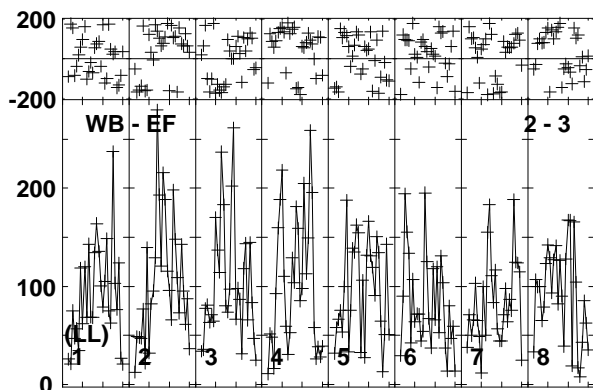
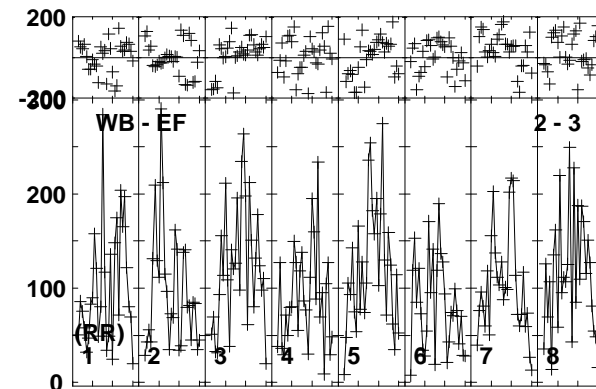
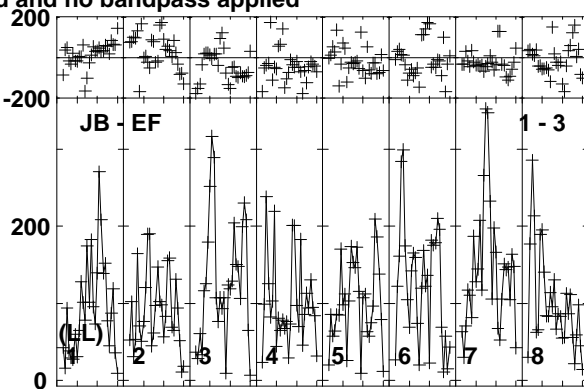
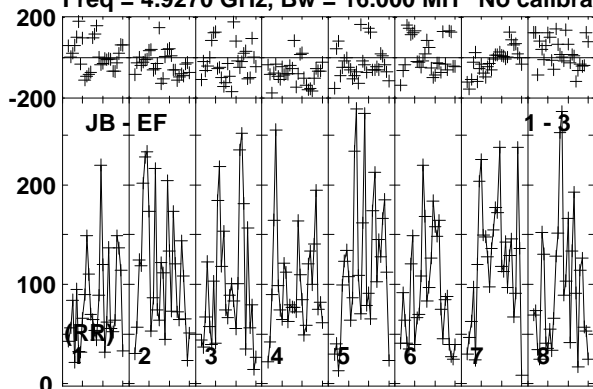

Lower frame: Micro Ampl Jy Top frame: Phas deg  
Vector averaged cross-power spectrum Baseline: JB (01) - EF (03)  
Timerange: 00/17:38:31 to 00/17:41:29

Plot file version 918 created 19-DEC-2018 17:59:12

AT2018\_RY007C.UVDATA.1

Freq = 4.9270 GHz, Bw = 16.000 MH No calibration applied and no bandpass applied

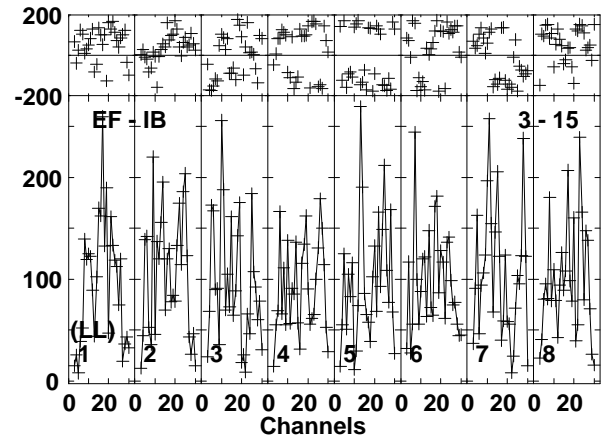
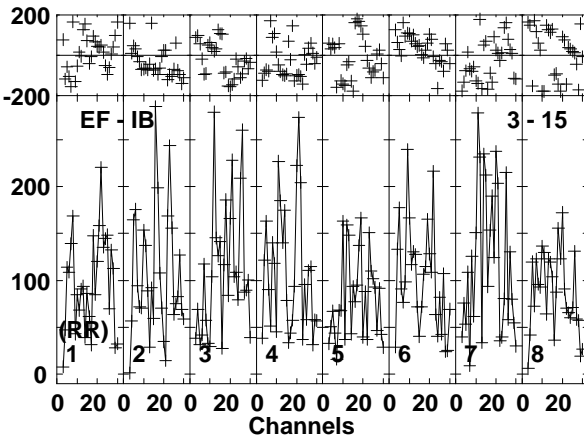
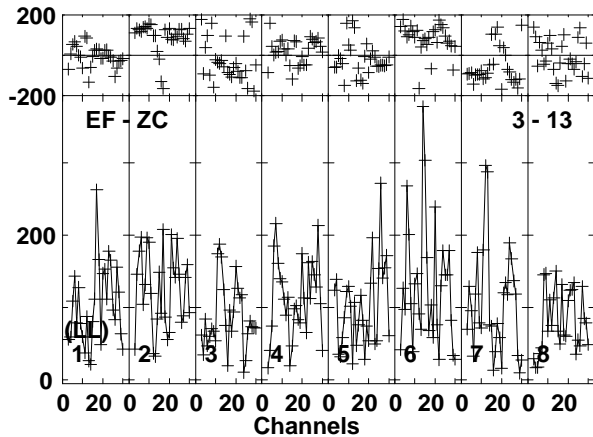
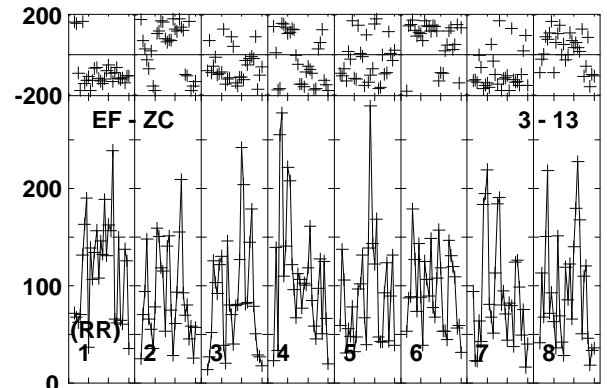
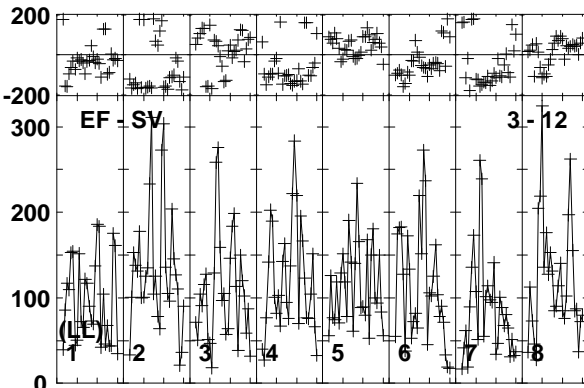
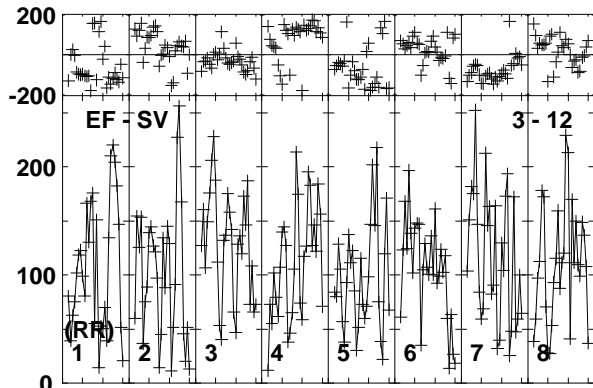
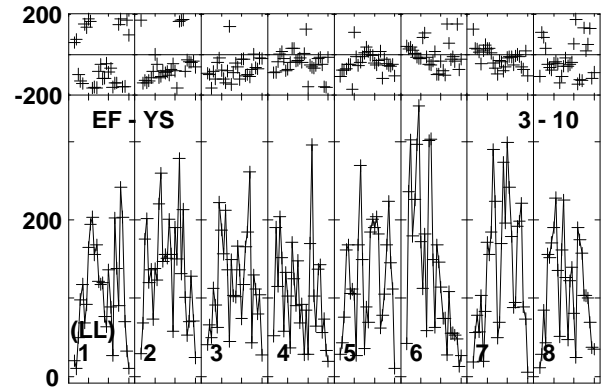
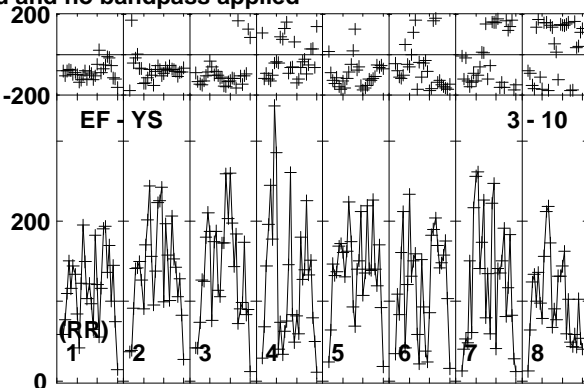
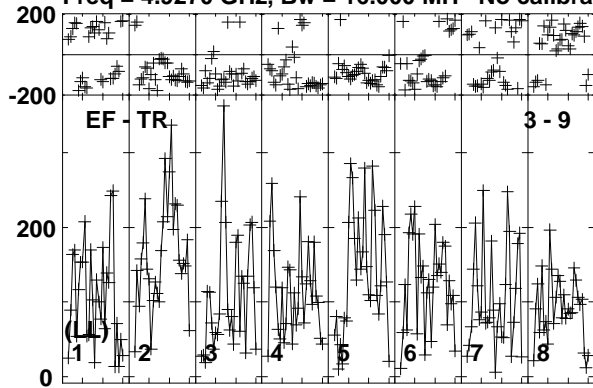

Lower frame: Micro Ampl Jy Top frame: Phas deg  
Vector averaged cross-power spectrum Baseline: EF (03) - TR (09)  
Timerange: 00/17:38:31 to 00/17:41:29

Plot file version 919 created 19-DEC-2018 17:59:12

AT2018\_RY007C.UVDATA.1

Freq = 4.9270 GHz, Bw = 16.000 MH No calibration applied and no bandpass applied

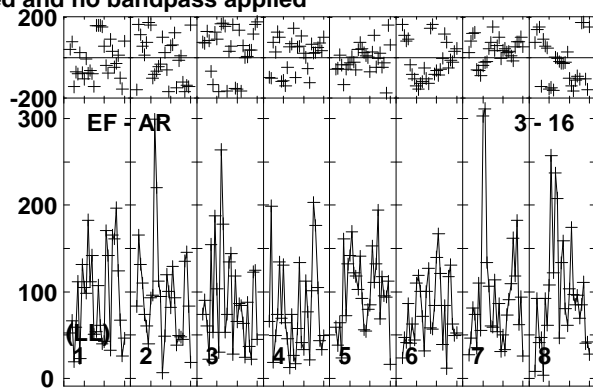
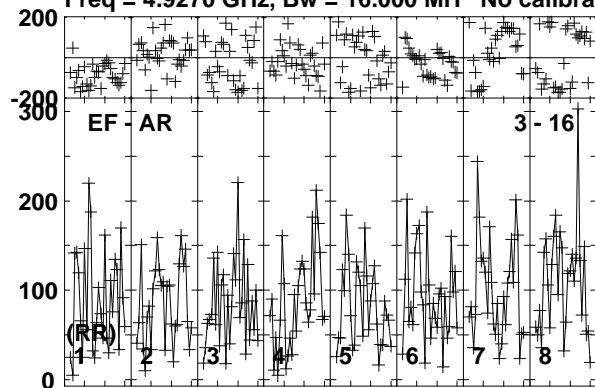

Lower frame: Micro Ampl Jy Top frame: Phas deg  
Vector averaged cross-power spectrum Baseline: EF (03) - AR (16)  
Timerange: 00/17:38:31 to 00/17:41:29

Plot file version 920 created 19-DEC-2018 17:59:12

J1619+2247 RY007C.UVDATA.1

Freq = 4.9270 GHz, Bw = 16.000 MH No calibration applied and no bandpass applied

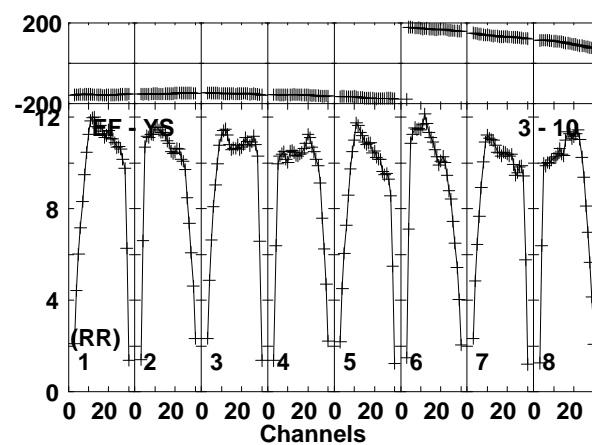
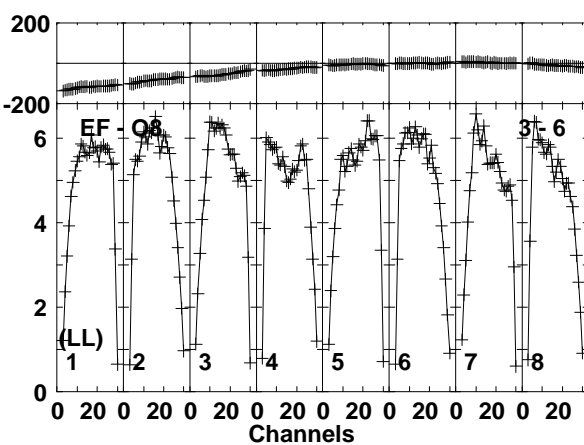
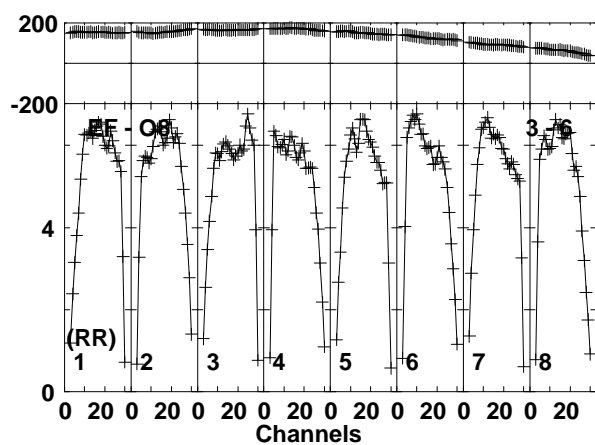
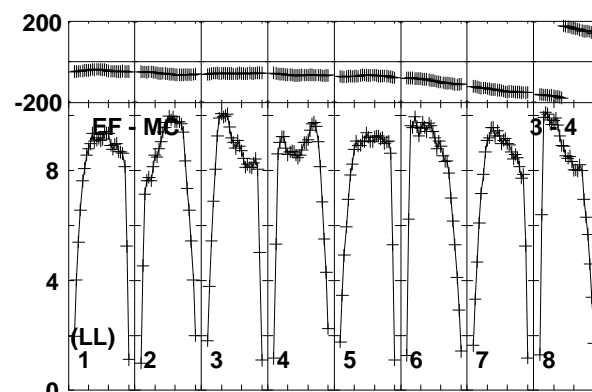
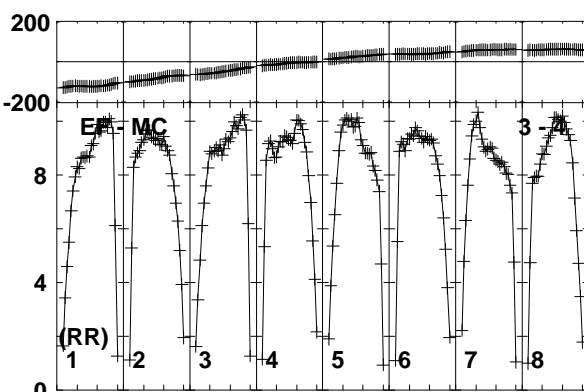
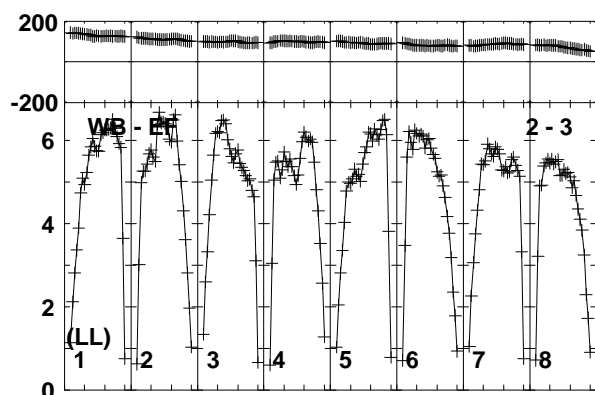
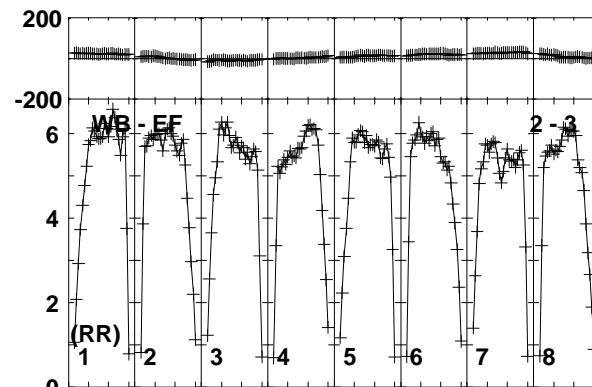
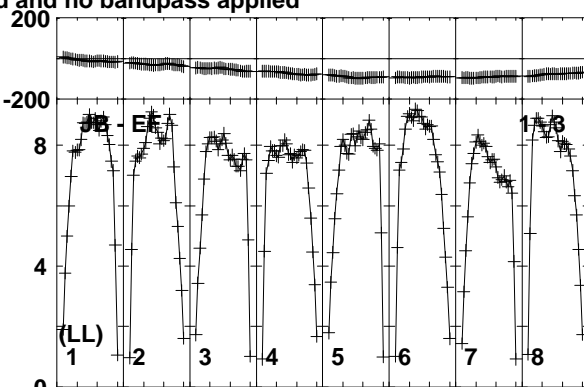
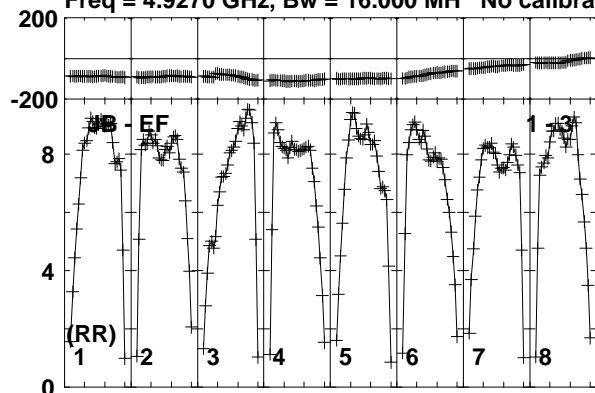

Lower frame: Milli Ampl Jy Top frame: Phas deg  
Vector averaged cross-power spectrum Baseline: JB (01) - EF (03)  
Timerange: 00/17:41:31 to 00/17:42:29

Plot file version 921 created 19-DEC-2018 17:59:12

J1619+2247 RY007C.UVDATA.1

Freq = 4.9270 GHz, Bw = 16.000 MH No calibration applied and no bandpass applied

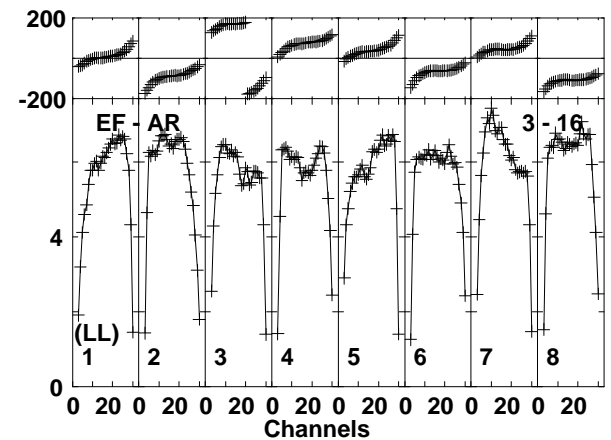
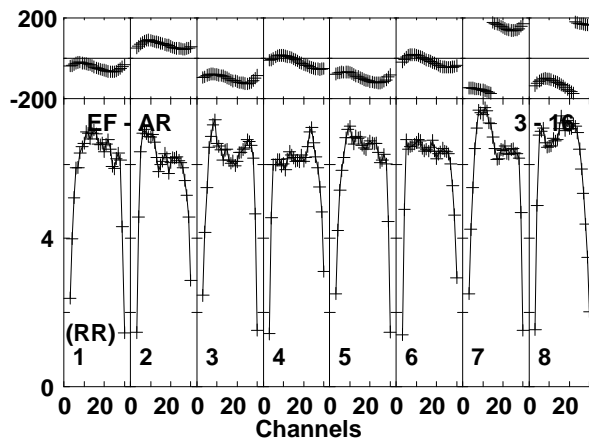
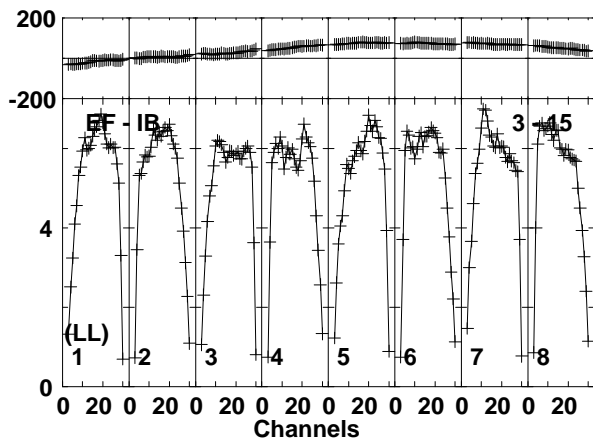
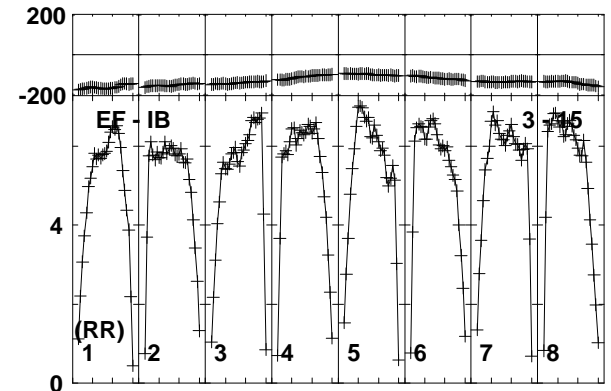
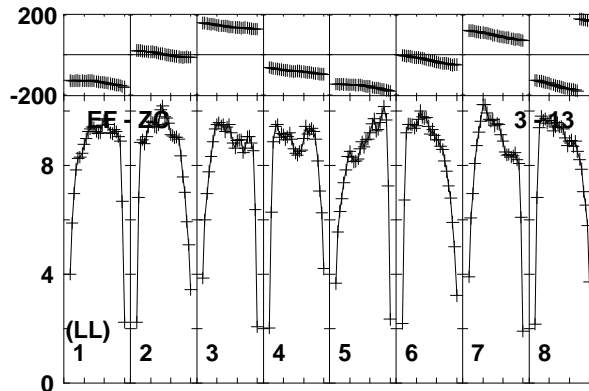
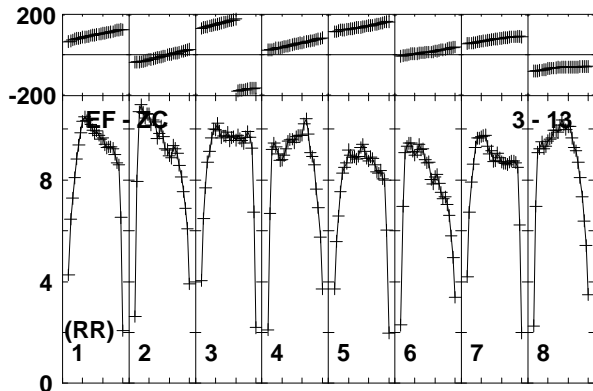
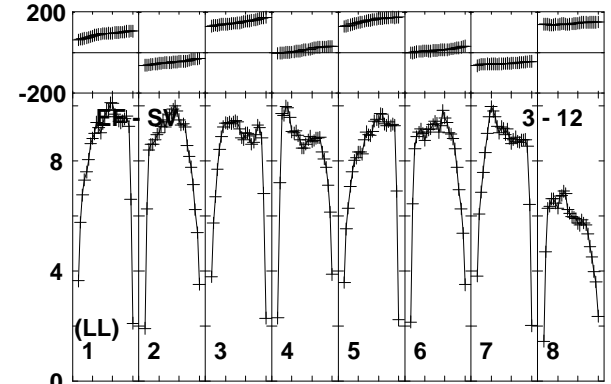
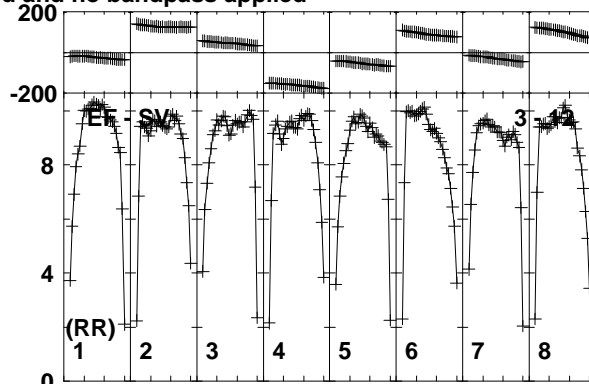
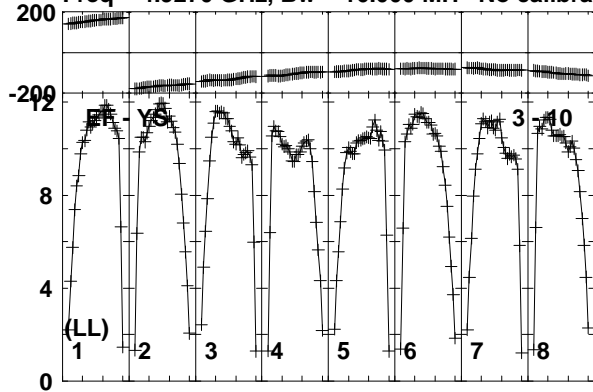

Lower frame: Milli Ampl Jy Top frame: Phas deg  
Vector averaged cross-power spectrum Baseline: EF (03) - YS (10)  
Timerange: 00/17:41:31 to 00/17:42:29

Plot file version 922 created 19-DEC-2018 17:59:12

VLA1 RY007C.UVDATA.1

Freq = 4.9270 GHz, Bw = 16.000 MH No calibration applied and no bandpass applied

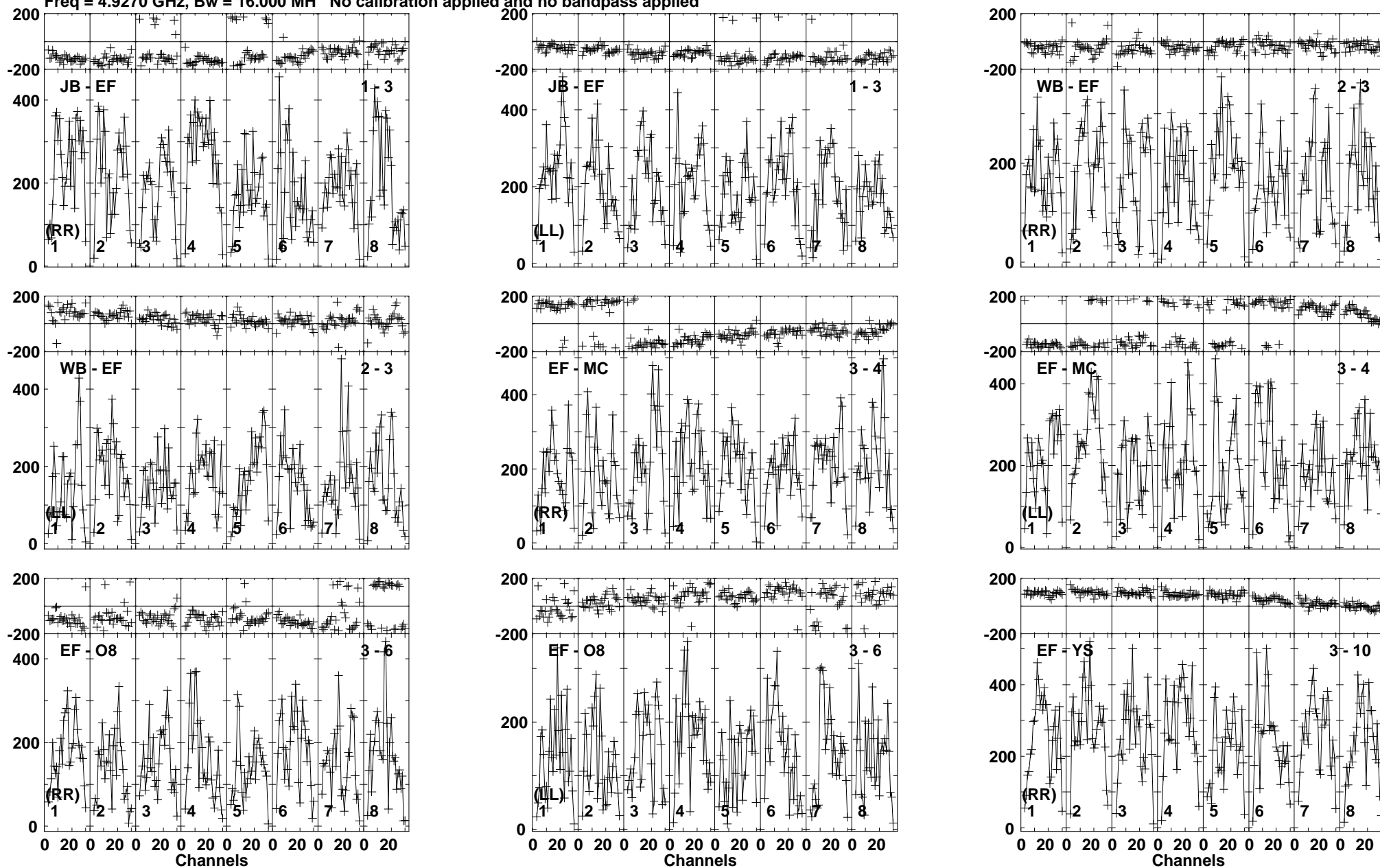

Lower frame: Micro Ampl Jy Top frame: Phas deg  
Vector averaged cross-power spectrum Baseline: JB (01) - EF (03)  
Timerange: 00/17:43:01 to 00/17:44:59



Plot file version 923 created 19-DEC-2018 17:59:12

VLA1 RY007C.UVDATA.1

Freq = 4.9270 GHz, Bw = 16.000 MH No calibration applied and no bandpass applied

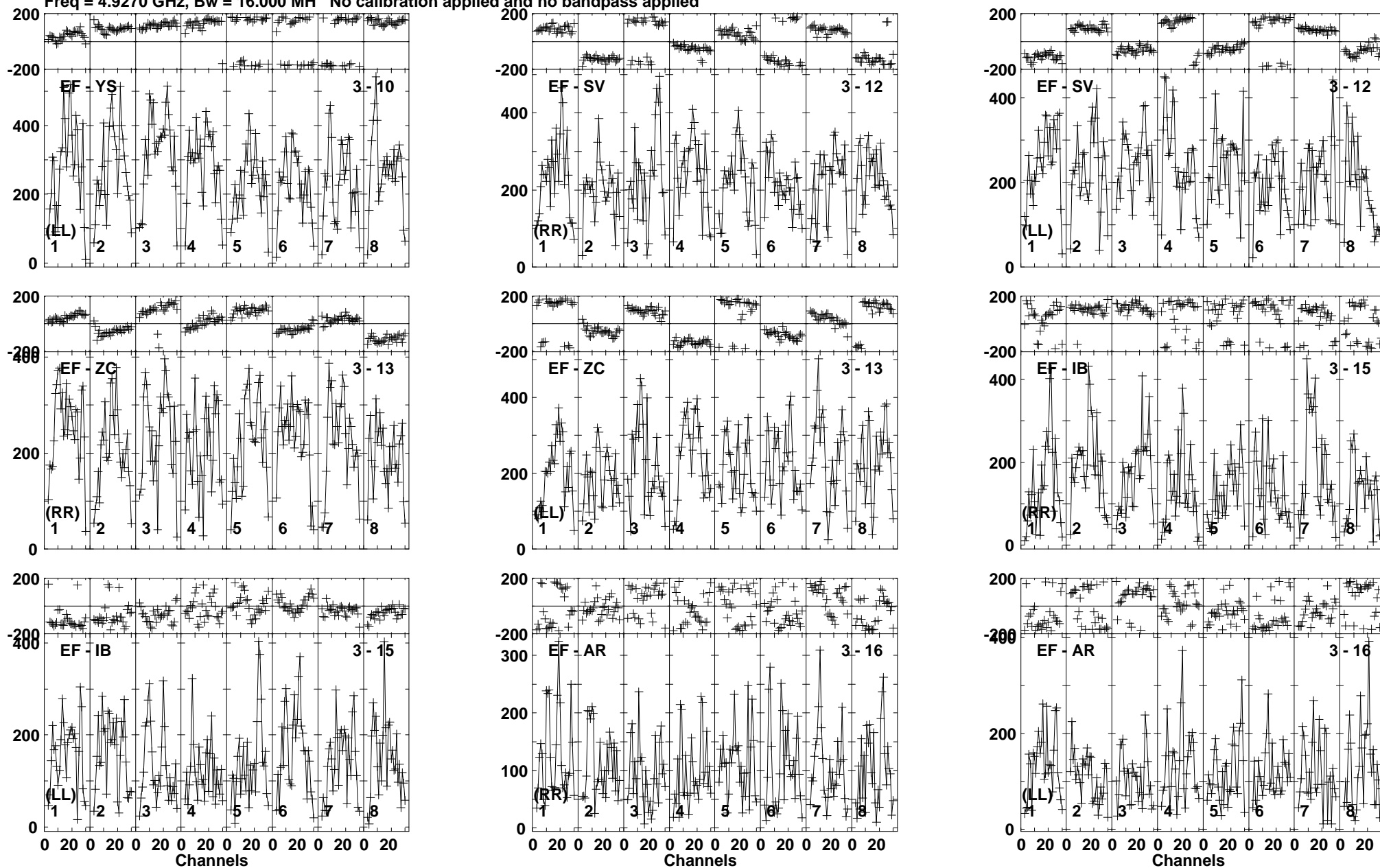

Lower frame: Micro Ampl Jy Top frame: Phas deg  
Vector averaged cross-power spectrum Baseline: EF (03) - YS (10)  
Timerange: 00:17:43:01 to 00:17:44:59

Plot file version 924 created 19-DEC-2018 17:59:12

J1619+2247 RY007C.UVDATA.1

Freq = 4.9270 GHz, Bw = 16.000 MH No calibration applied and no bandpass applied

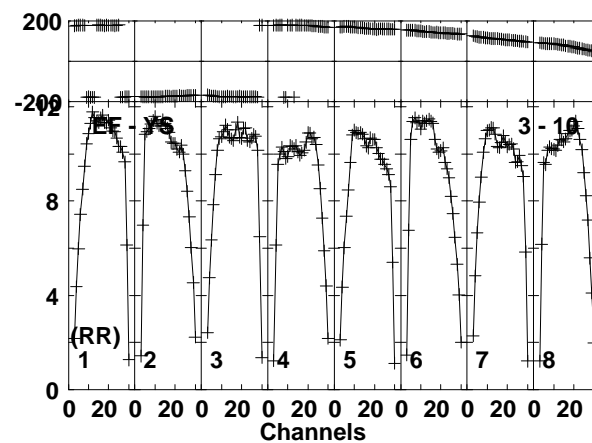
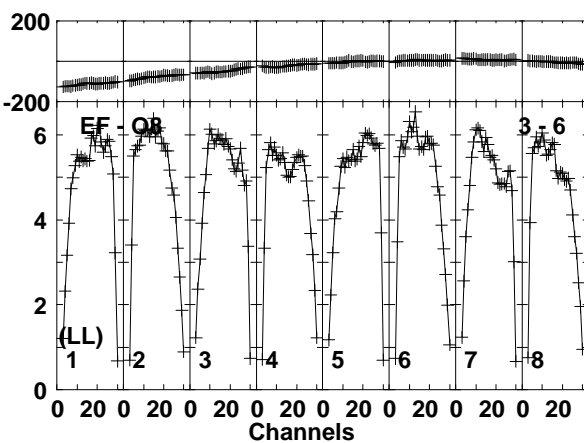
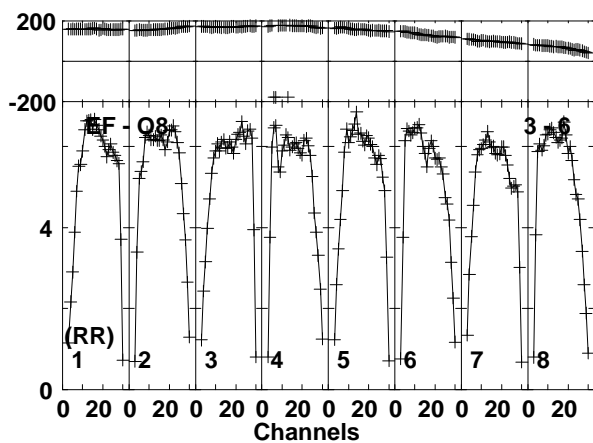
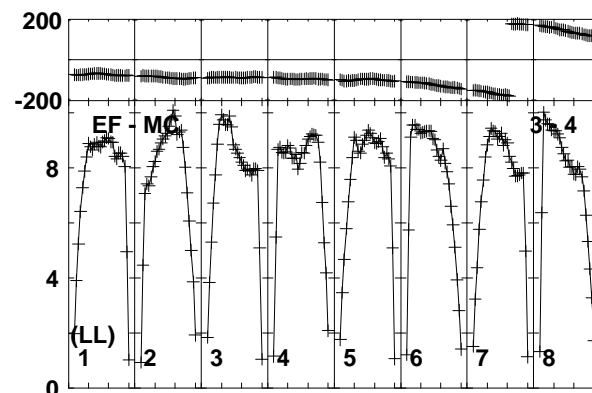
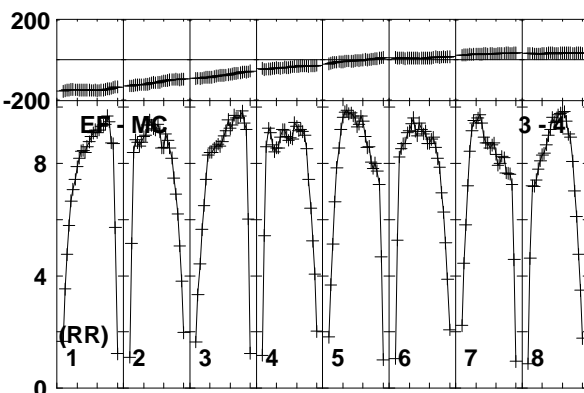
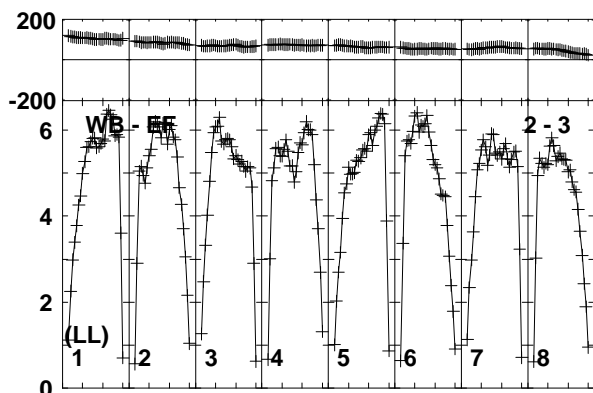
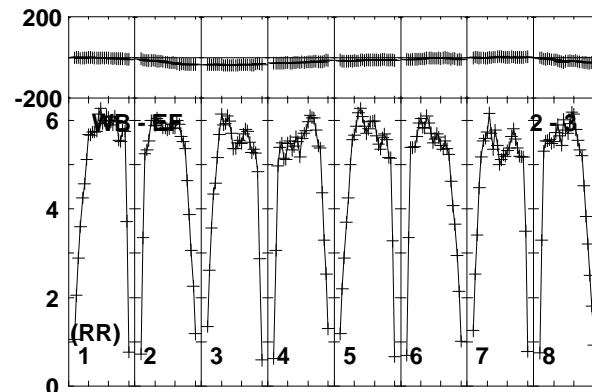
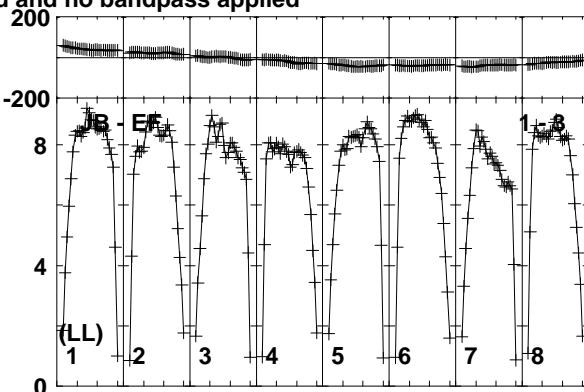
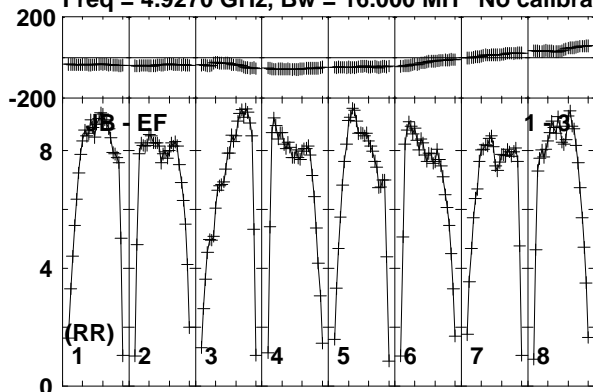

Lower frame: Milli Ampl Jy Top frame: Phas deg  
Vector averaged cross-power spectrum Baseline: JB (01) - EF (03)  
Timerange: 00:17:45:01 to 00:17:45:59

Plot file version 925 created 19-DEC-2018 17:59:12

J1619+2247 RY007C.UVDATA.1

Freq = 4.9270 GHz, Bw = 16.000 MH No calibration applied and no bandpass applied

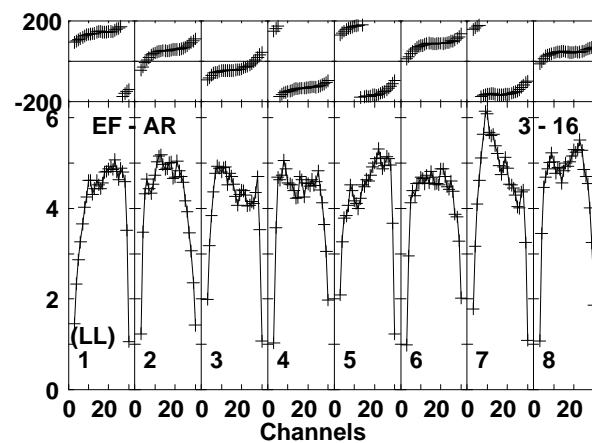
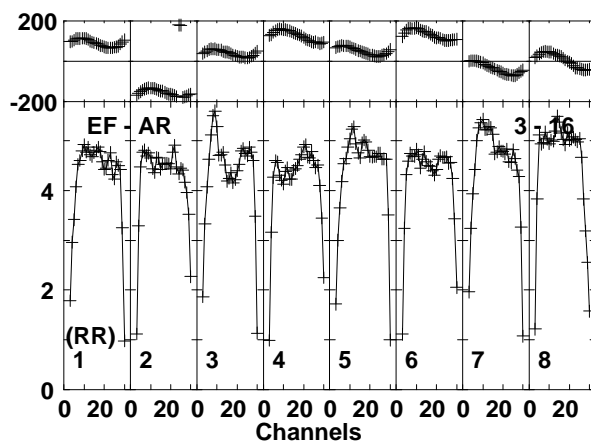
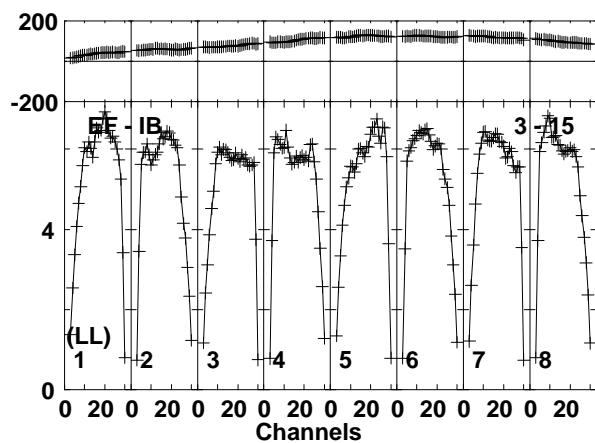
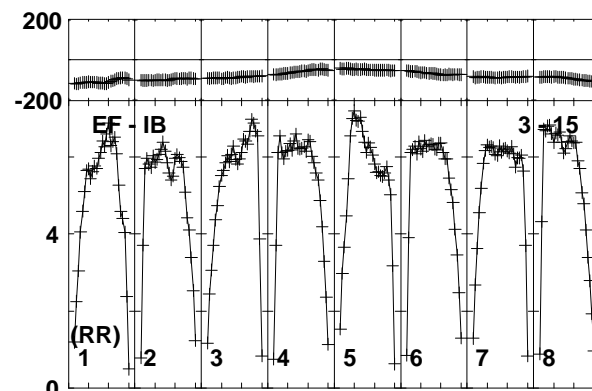
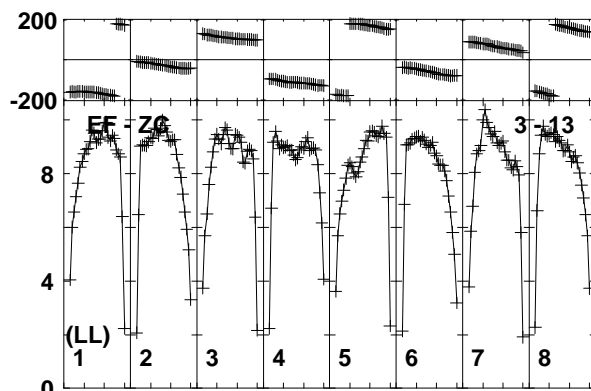
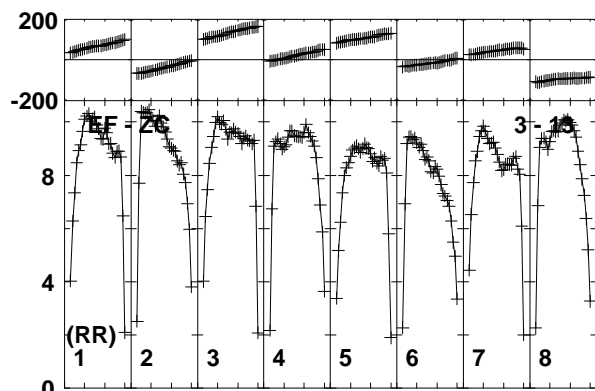
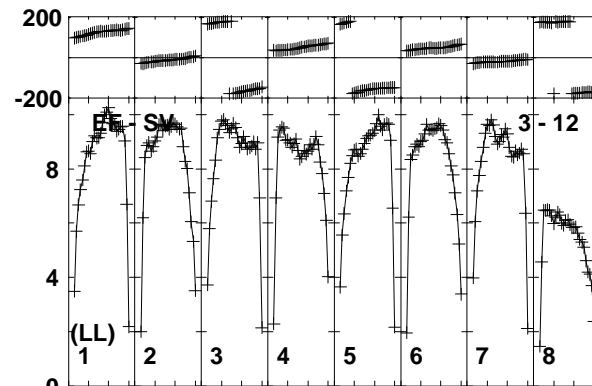
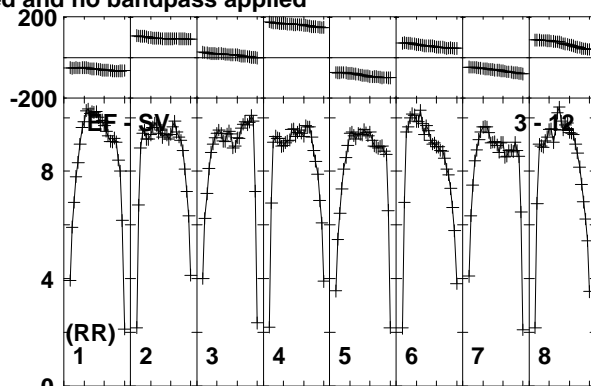
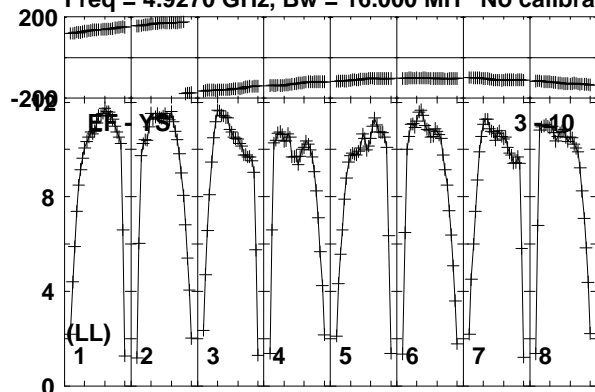

Lower frame: Milli Ampl Jy Top frame: Phas deg  
Vector averaged cross-power spectrum Baseline: EF (03) - YS (10)  
Timerange: 00/17:45:01 to 00/17:45:59

Plot file version 926 created 19-DEC-2018 17:59:12  
 AT2018\_RY007C.UVDATA.1

Freq = 4.9270 GHz, Bw = 16.000 MH No calibration applied and no bandpass applied

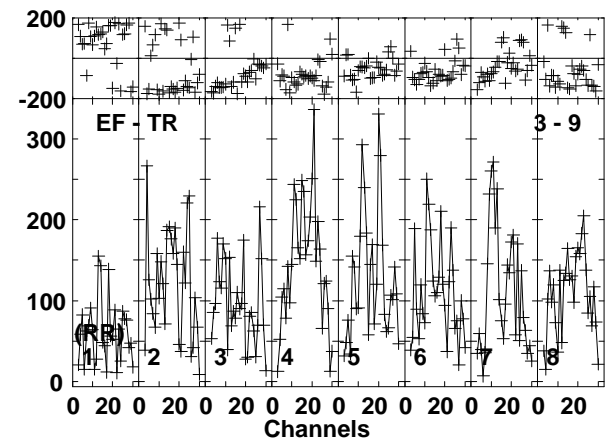
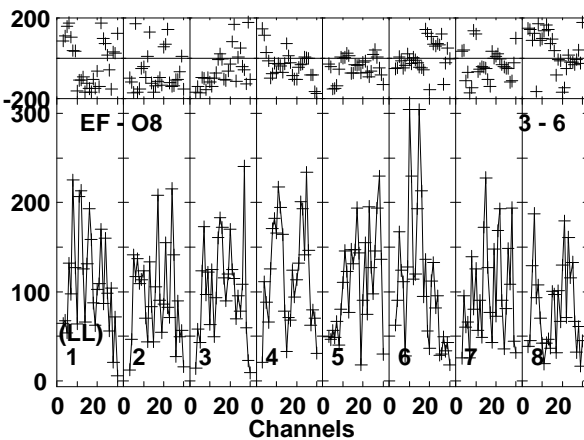
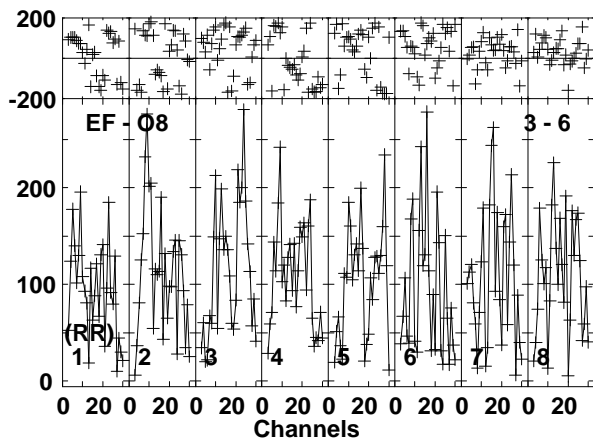
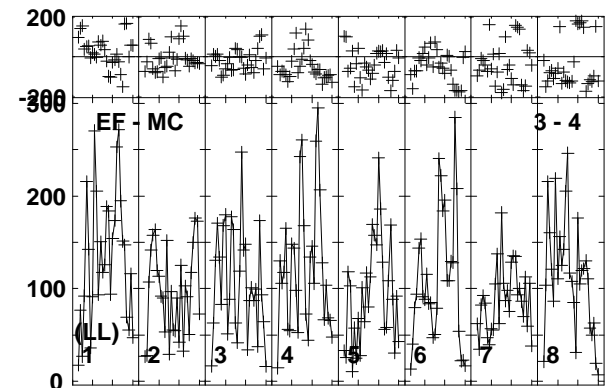
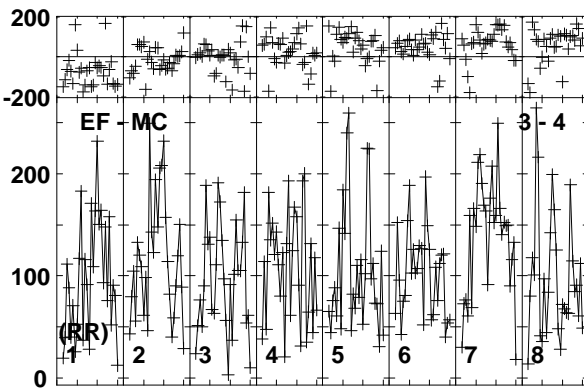
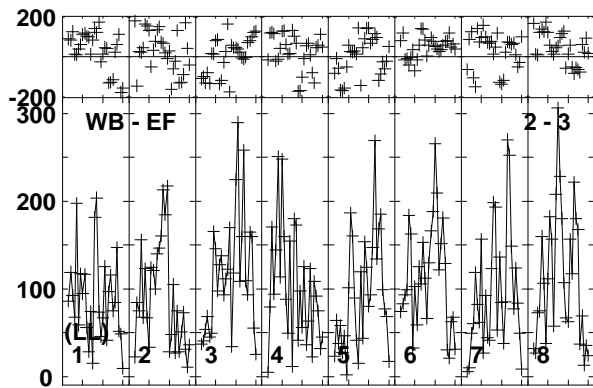
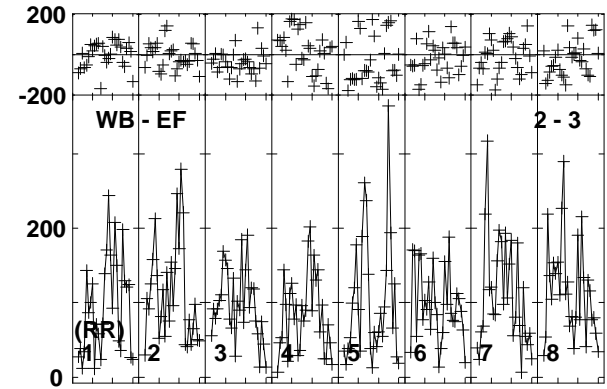
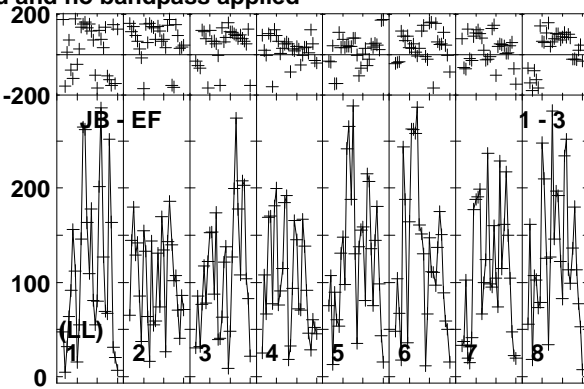
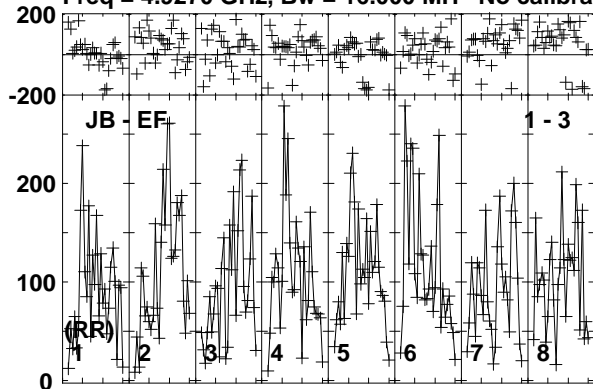

Lower frame: Micro Ampl Jy Top frame: Phas deg  
 Vector averaged cross-power spectrum Baseline: JB (01) - EF (03)  
 Timerange: 00/17:46:01 to 00/17:48:59

Plot file version 927 created 19-DEC-2018 17:59:12

AT2018\_RY007C.UVDATA.1

Freq = 4.9270 GHz, Bw = 16.000 MH No calibration applied and no bandpass applied

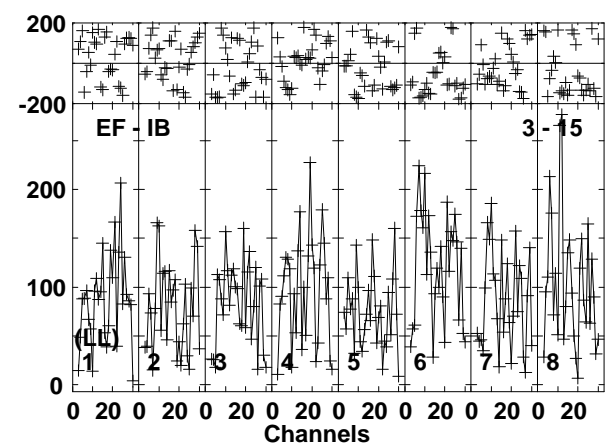
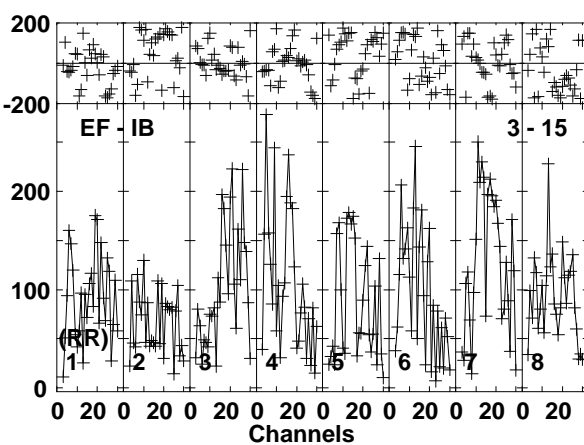
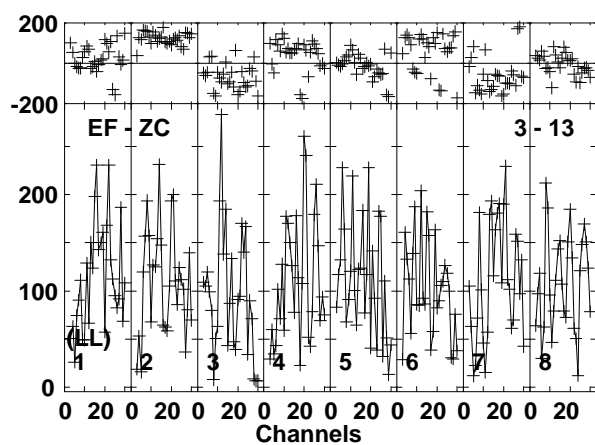
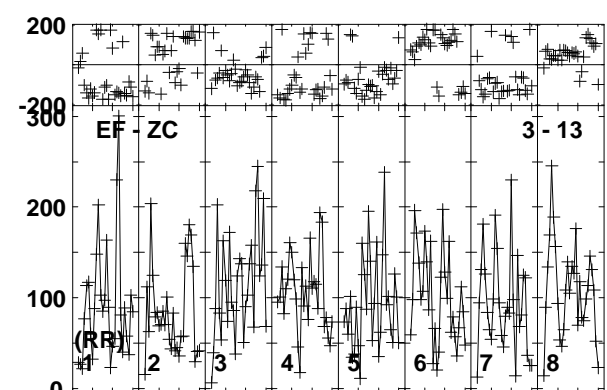
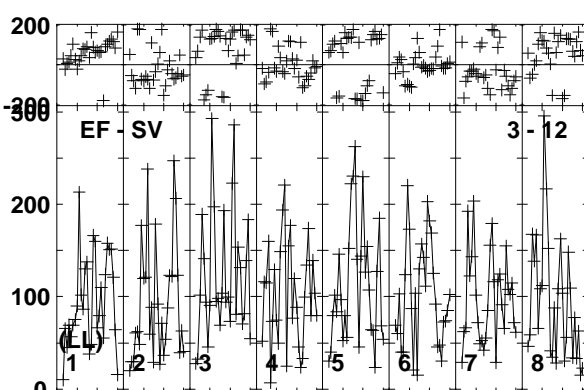
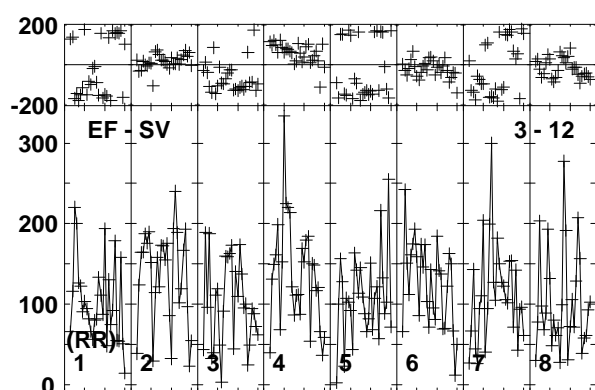
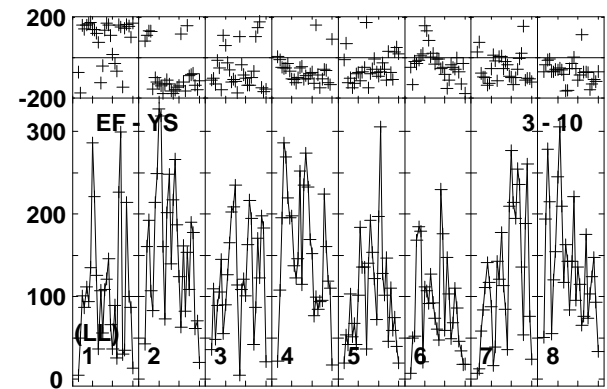
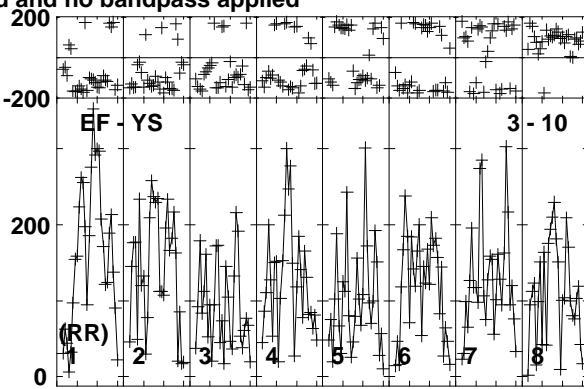
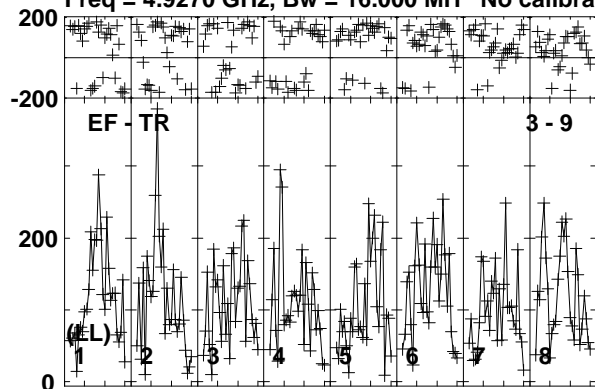

Lower frame: Micro Ampl Jy Top frame: Phas deg  
Vector averaged cross-power spectrum Baseline: EF (03) - TR (09)  
Timerange: 00:17:46:01 to 00:17:48:59

Plot file version 928 created 19-DEC-2018 17:59:12

AT2018\_RY007C.UVDATA.1

Freq = 4.9270 GHz, Bw = 16.000 MH No calibration applied and no bandpass applied

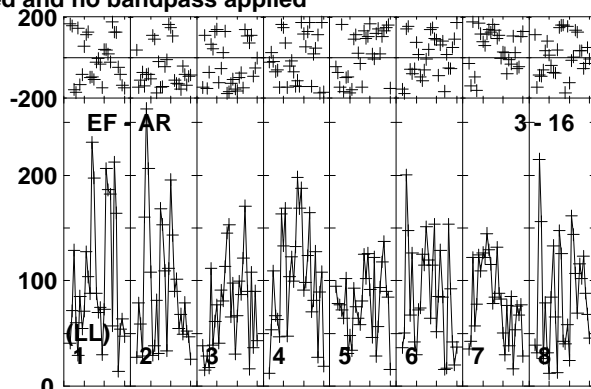
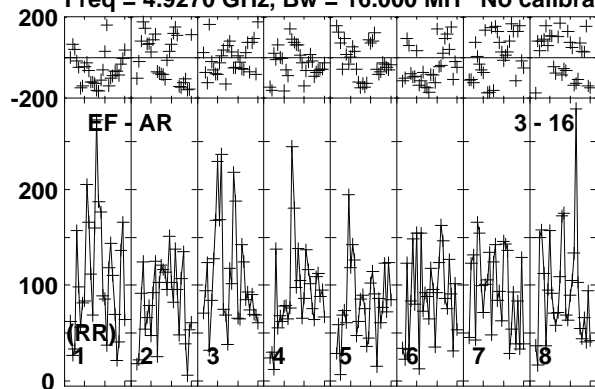

Lower frame: Micro Ampl Jy Top frame: Phas deg  
Vector averaged cross-power spectrum Baseline: EF (03) - AR (16)  
Timerange: 00/17:46:01 to 00/17:48:59

Plot file version 929 created 19-DEC-2018 17:59:12

J1619+2247 RY007C.UVDATA.1

Freq = 4.9270 GHz, Bw = 16.000 MH No calibration applied and no bandpass applied

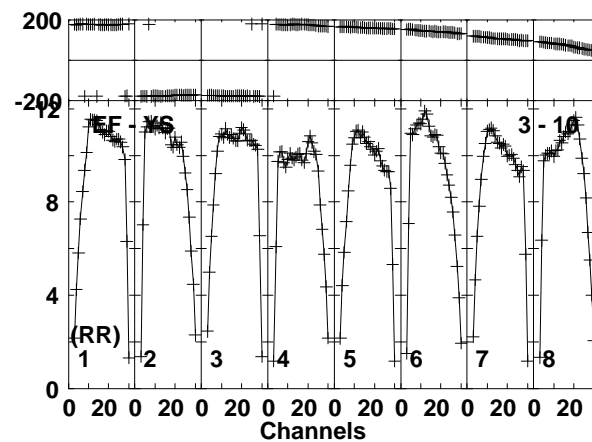
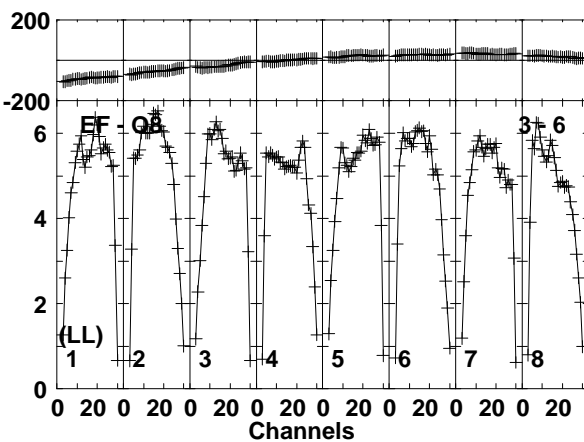
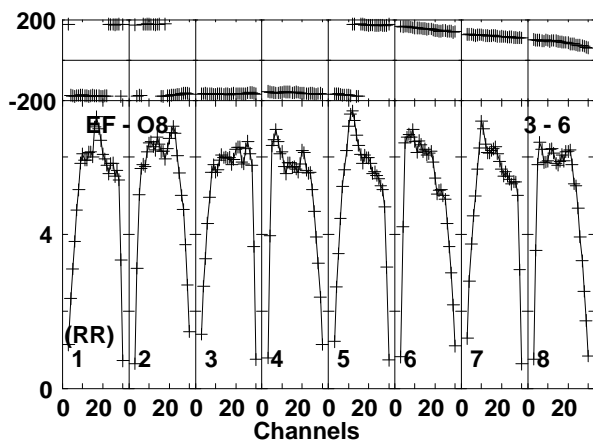
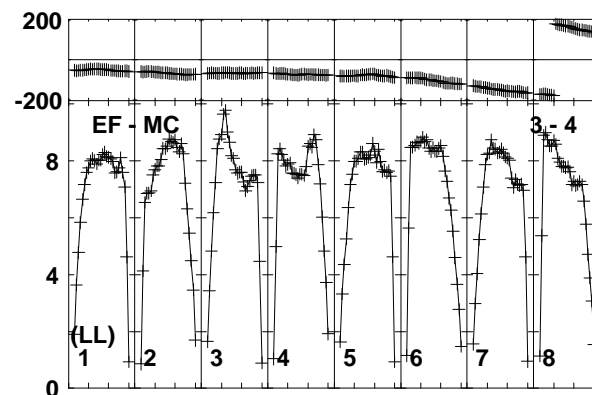
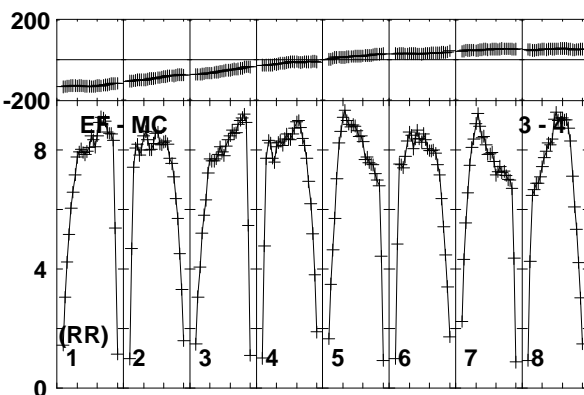
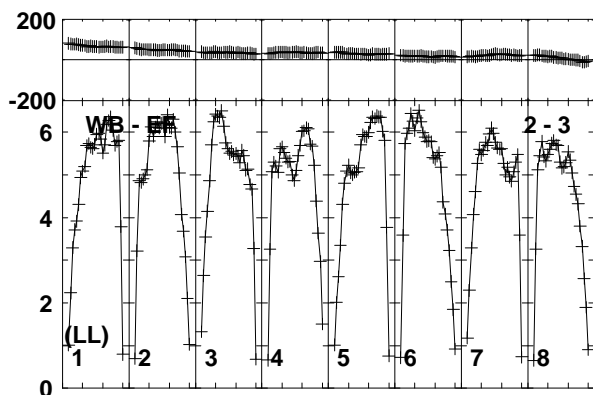
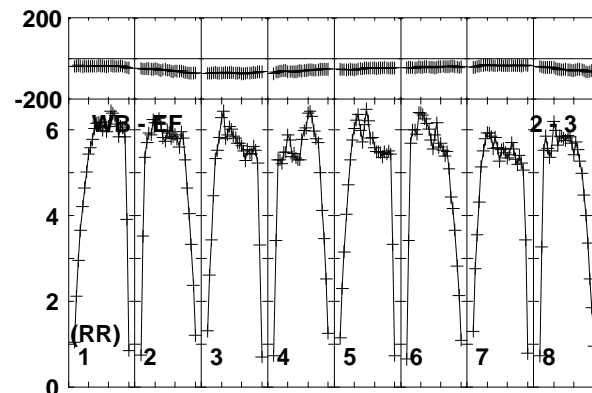
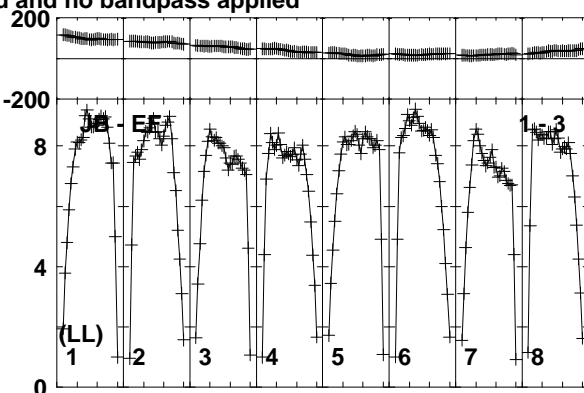
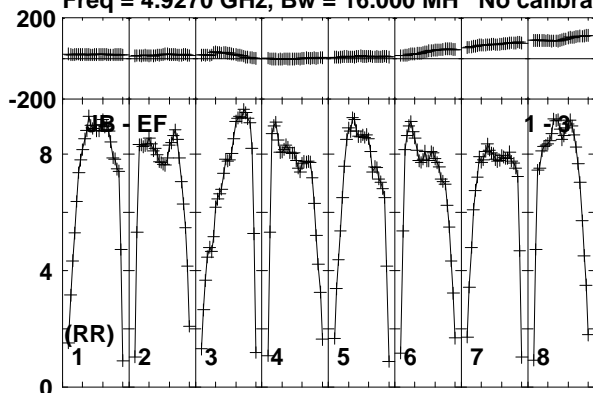

Lower frame: Milli Ampl Jy Top frame: Phas deg  
Vector averaged cross-power spectrum Baseline: JB (01) - EF (03)  
Timerange: 00:17:49:01 to 00:17:49:59

Plot file version 930 created 19-DEC-2018 17:59:12

J1619+2247 RY007C.UVDATA.1

Freq = 4.9270 GHz, Bw = 16.000 MH No calibration applied and no bandpass applied

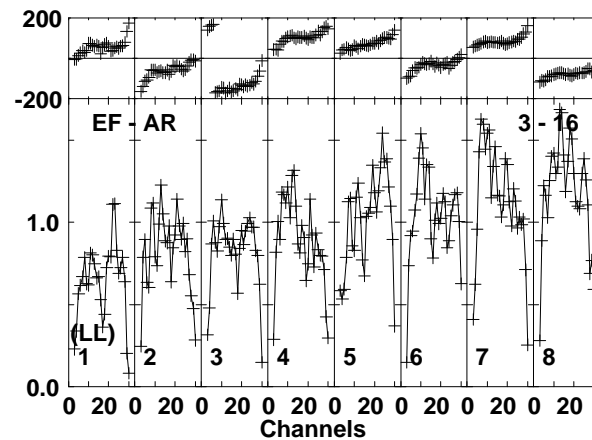
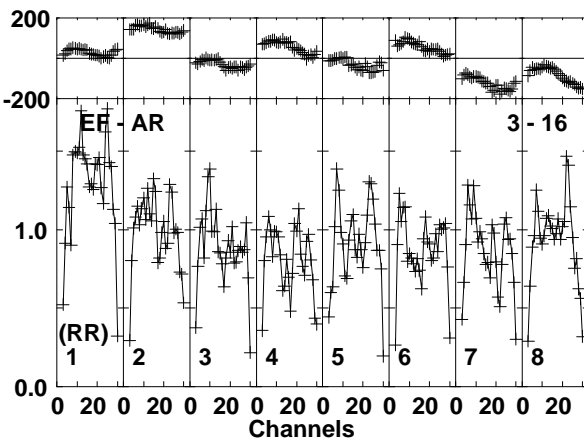
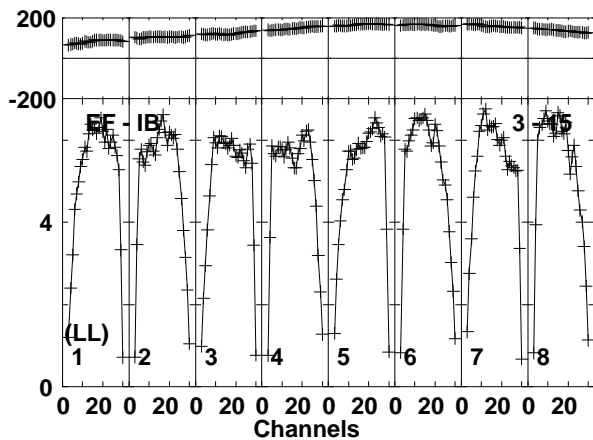
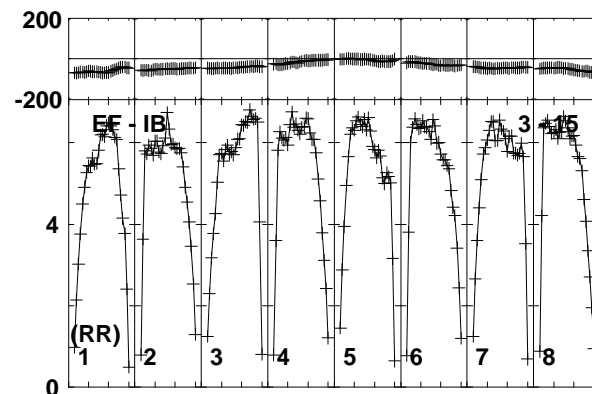
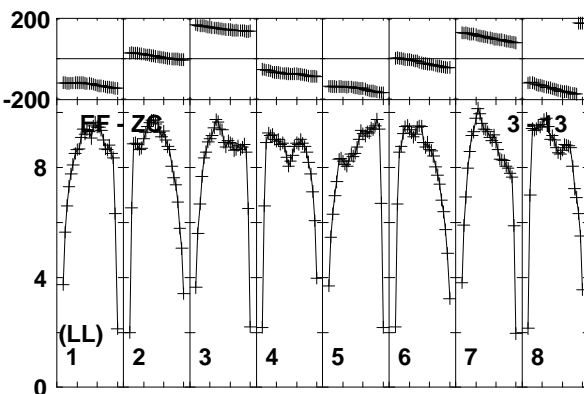
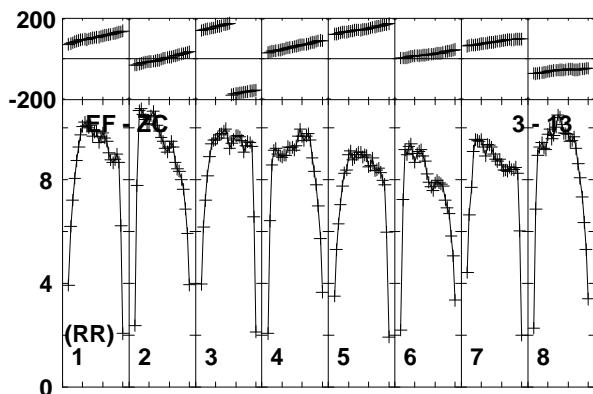
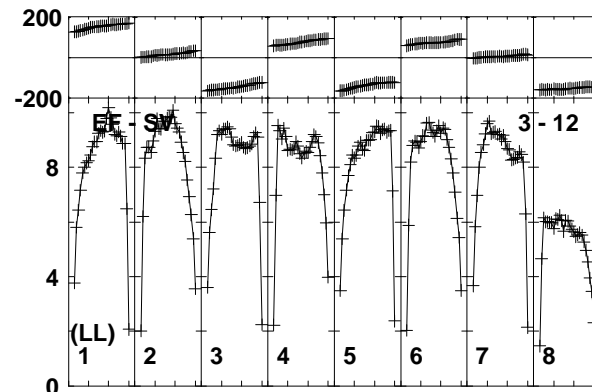
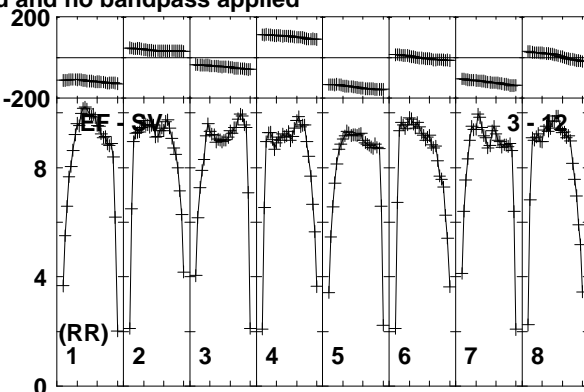
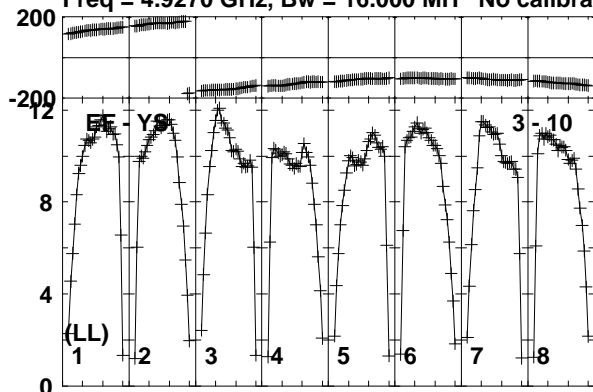

Lower frame: Milli Ampl Jy Top frame: Phas deg  
Vector averaged cross-power spectrum Baseline: EF (03) - YS (10)  
Timerange: 00/17:49:01 to 00/17:49:59



Plot file version 931 created 19-DEC-2018 17:59:12

AT2018\_RY007C.UVDATA.1

Freq = 4.9270 GHz, Bw = 16.000 MH No calibration applied and no bandpass applied

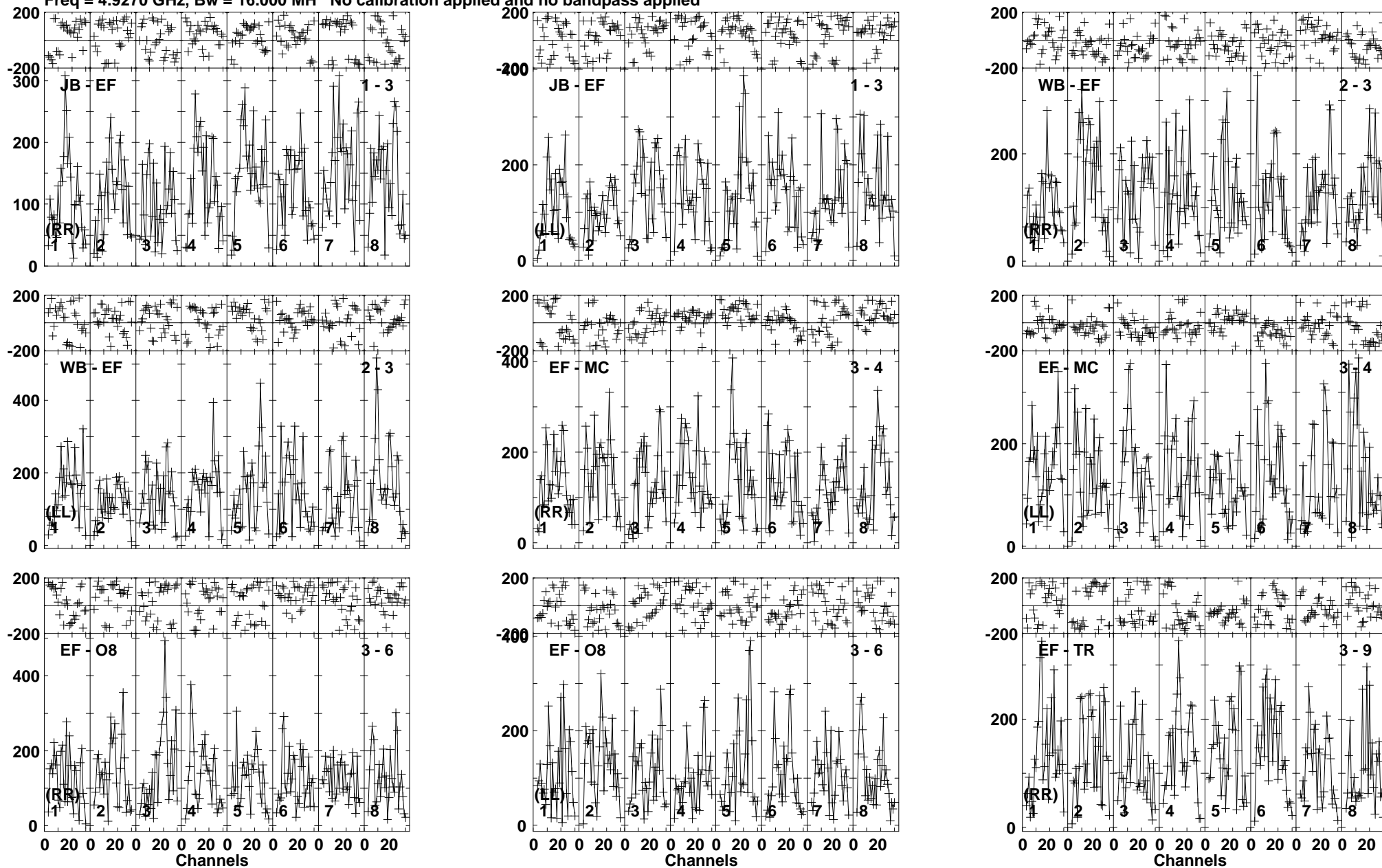

Lower frame: Micro Ampl Jy Top frame: Phas deg  
Vector averaged cross-power spectrum Baseline: JB (01) - EF (03)  
Timerange: 00/17:50:01 to 00/17:51:59

Plot file version 932 created 19-DEC-2018 17:59:12

AT2018\_RY007C.UVDATA.1

Freq = 4.9270 GHz, Bw = 16.000 MH No calibration applied and no bandpass applied

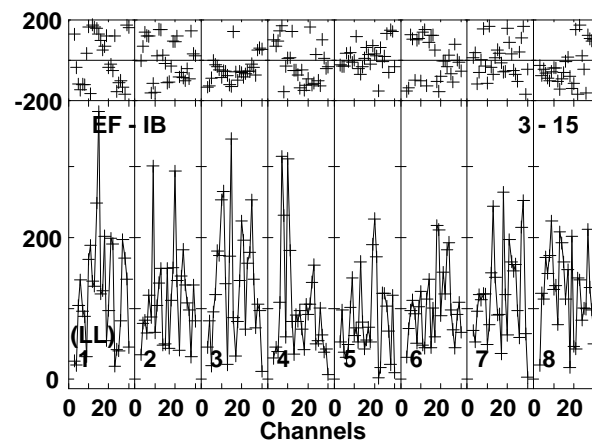
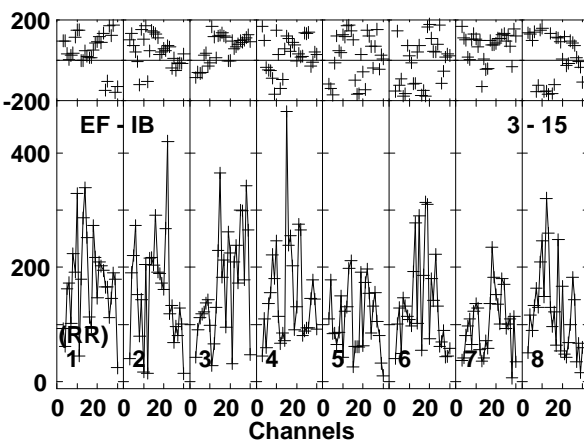
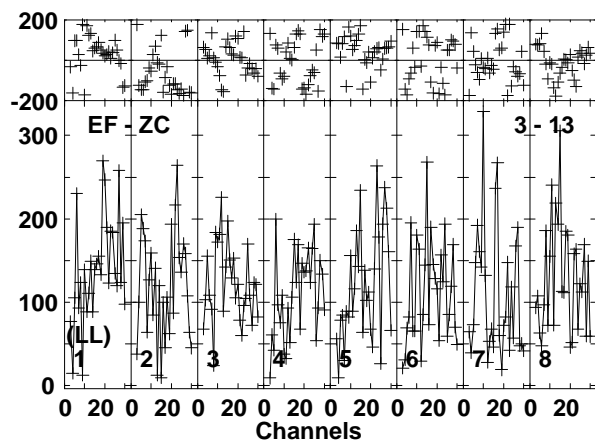
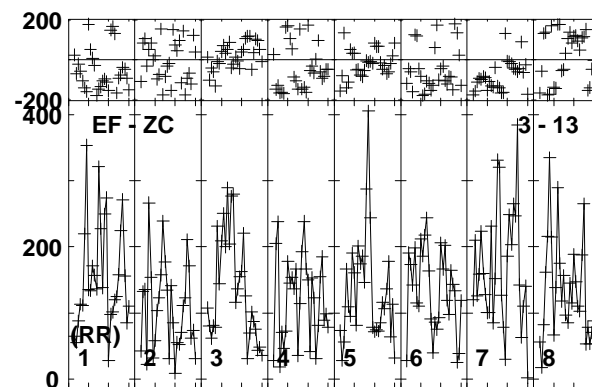
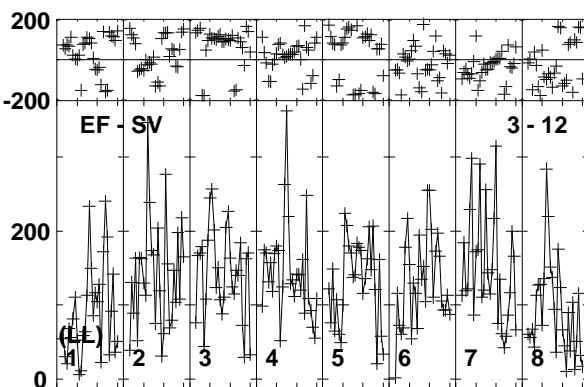
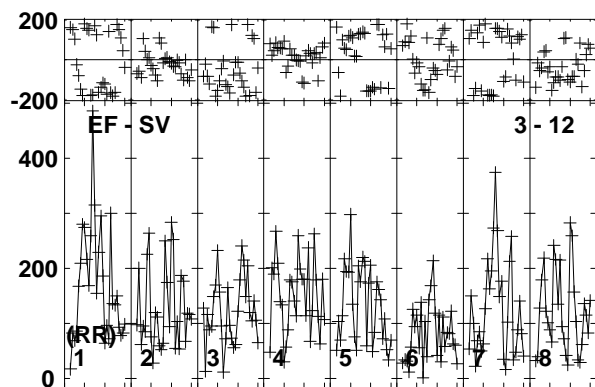
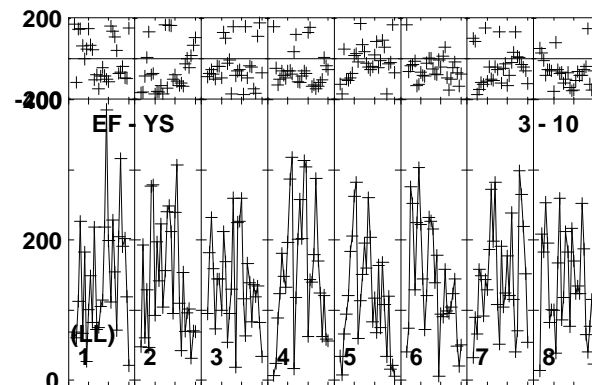
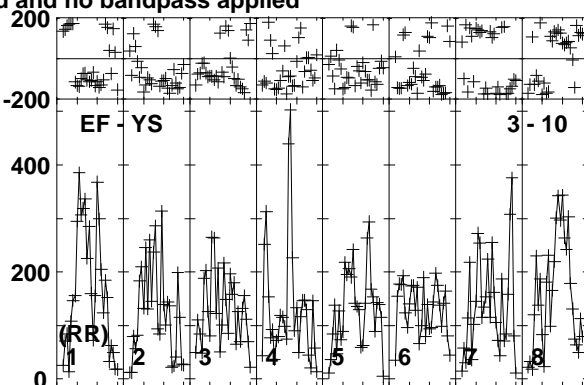
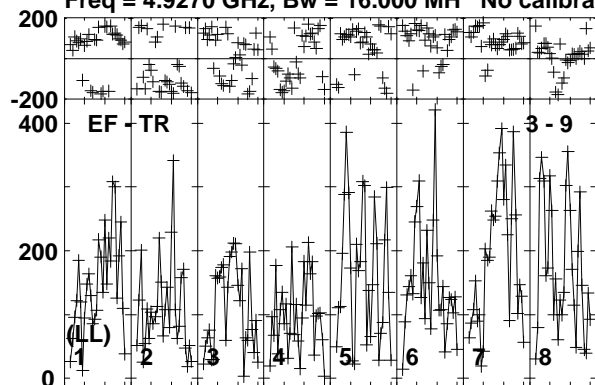

Lower frame: Micro Ampl Jy Top frame: Phas deg  
Vector averaged cross-power spectrum Baseline: EF (03) - TR (09)  
Timerange: 00:17:50:01 to 00:17:51:59

Plot file version 933 created 19-DEC-2018 17:59:12

AT2018\_RY007C.UVDATA.1

Freq = 4.9270 GHz, Bw = 16.000 MH No calibration applied and no bandpass applied

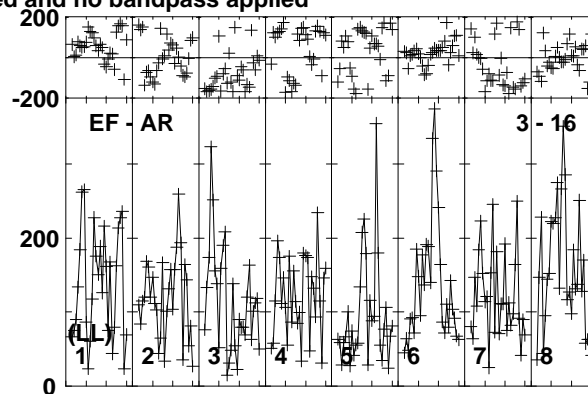
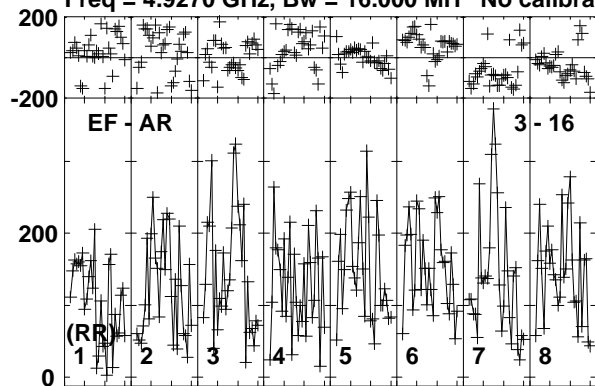

Lower frame: Micro Ampl Jy Top frame: Phas deg  
Vector averaged cross-power spectrum Baseline: EF (03) - AR (16)  
Timerange: 00/17:50:01 to 00/17:51:59

Plot file version 934 created 19-DEC-2018 17:59:13

VLA2 RY007C.UVDATA.1

Freq = 4.9270 GHz, Bw = 16.000 MH No calibration applied and no bandpass applied

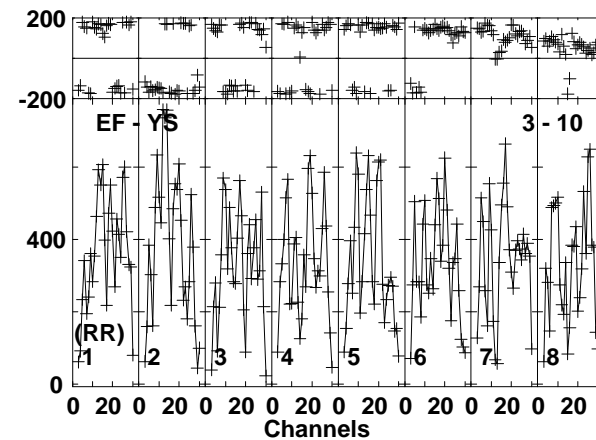
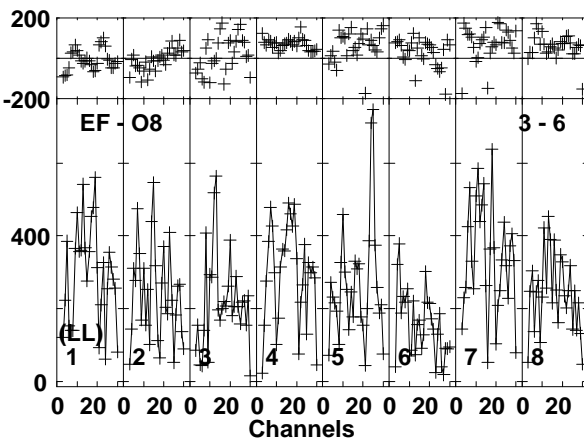
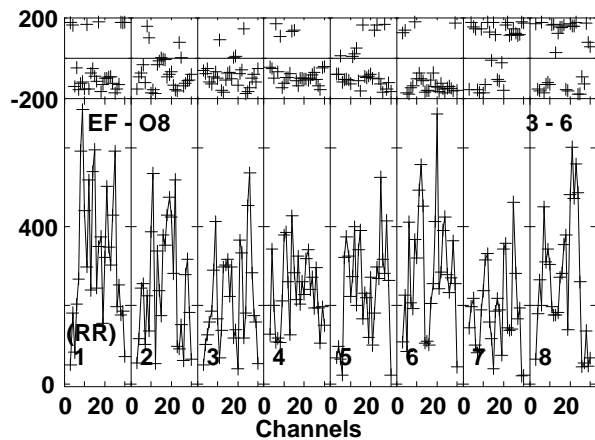
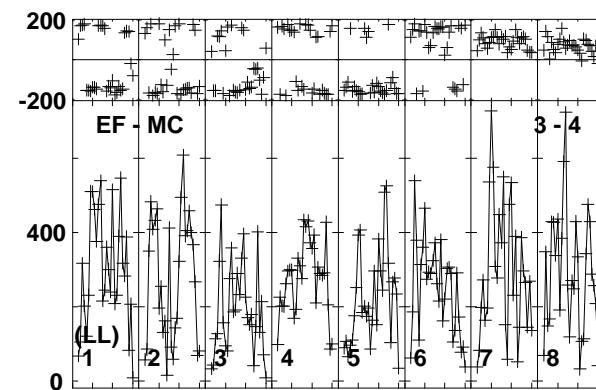
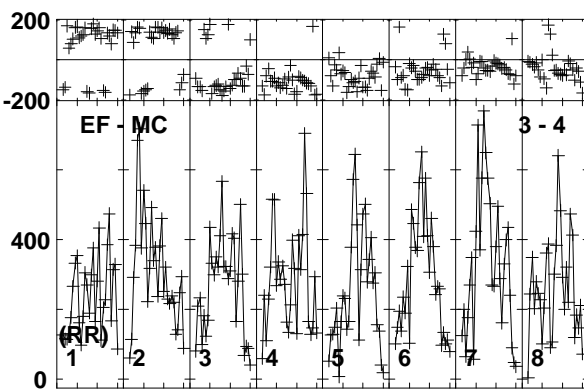
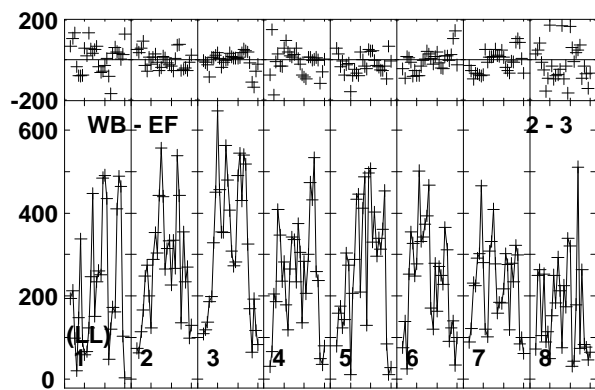
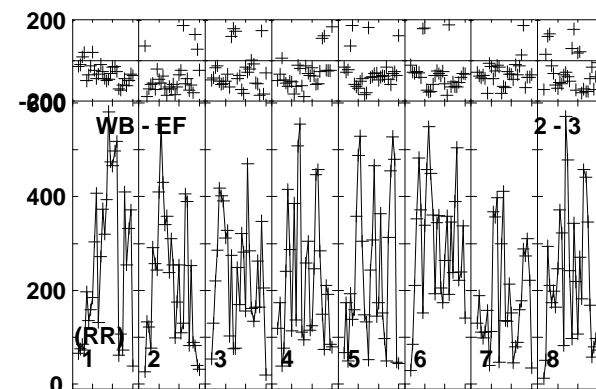
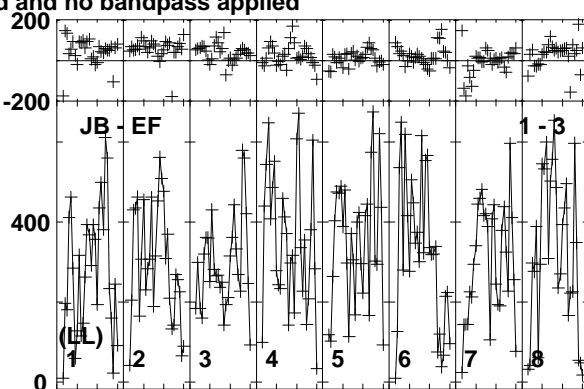
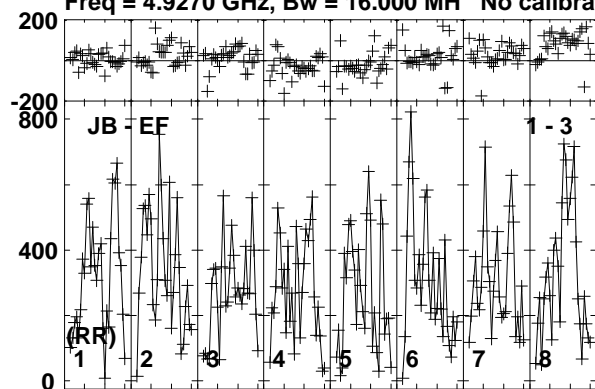

Lower frame: Micro Ampl Jy Top frame: Phas deg  
Vector averaged cross-power spectrum Baseline: JB (01) - EF (03)  
Timerange: 00/17:52:01 to 00/17:52:59

Plot file version 935 created 19-DEC-2018 17:59:13  
 VLA2\_RY007C.UVDATA.1  
 Freq = 4.9270 GHz, Bw = 16.000 MH No calibration applied and no bandpass applied

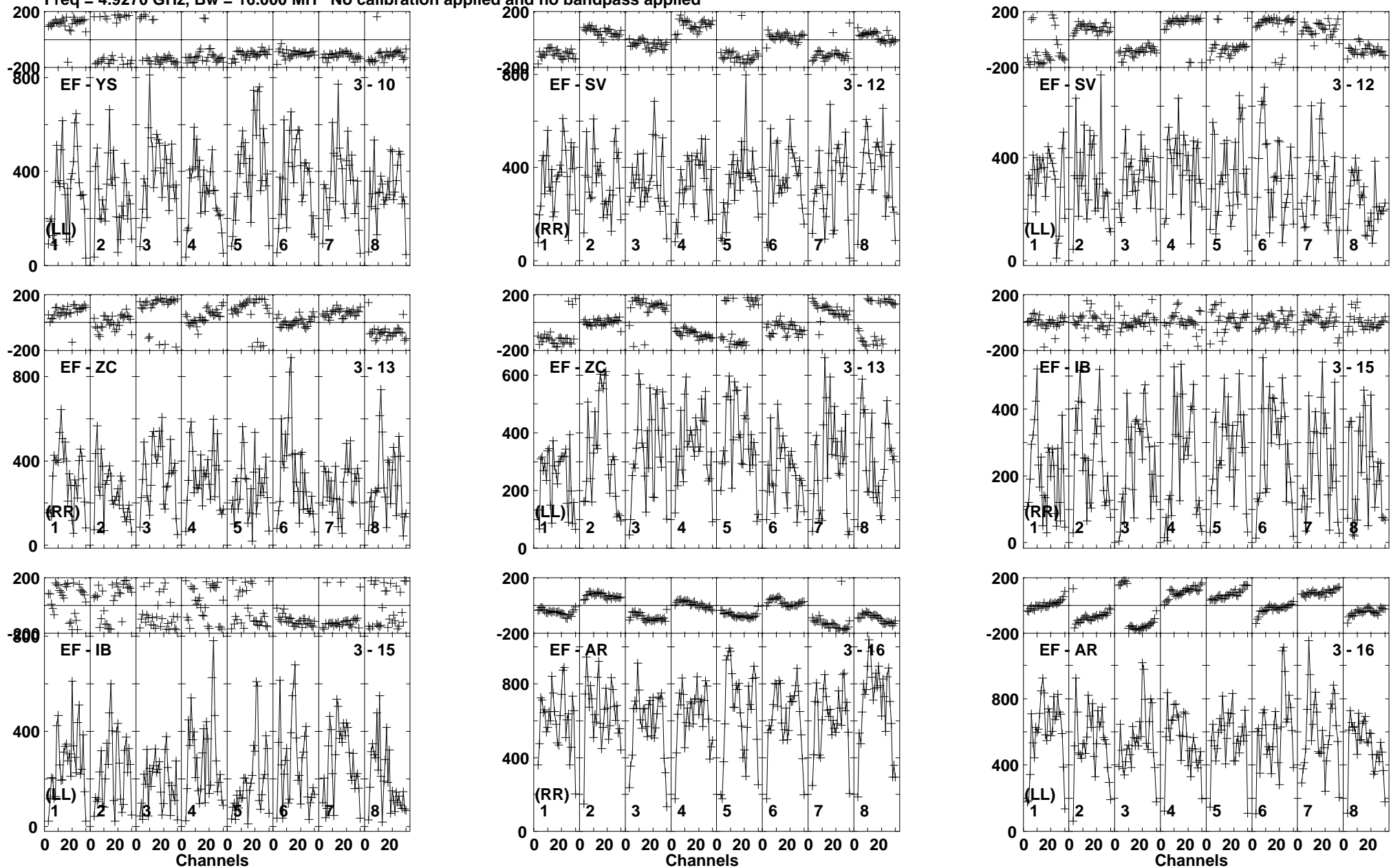

Lower frame: Micro Ampl Jy Top frame: Phas deg  
 Vector averaged cross-power spectrum Baseline: EF (03) - YS (10)  
 Timerange: 00/17:52:01 to 00/17:52:59

Plot file version 936 created 19-DEC-2018 17:59:13

J1619+2247 RY007C.UVDATA.1

Freq = 4.9270 GHz, Bw = 16.000 MH No calibration applied and no bandpass applied

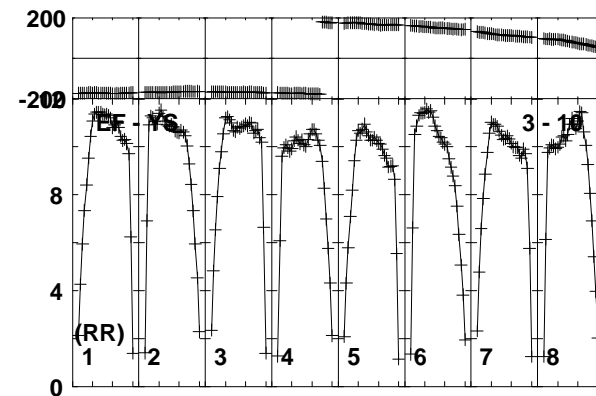
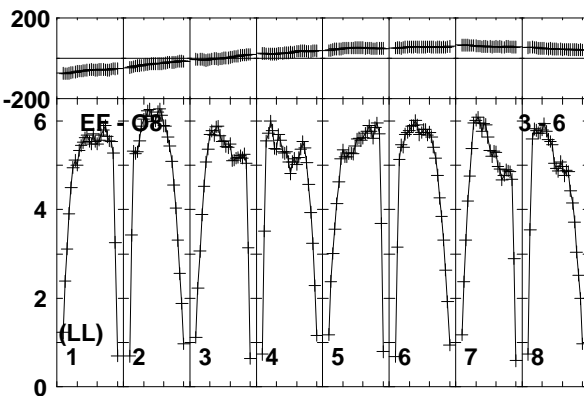
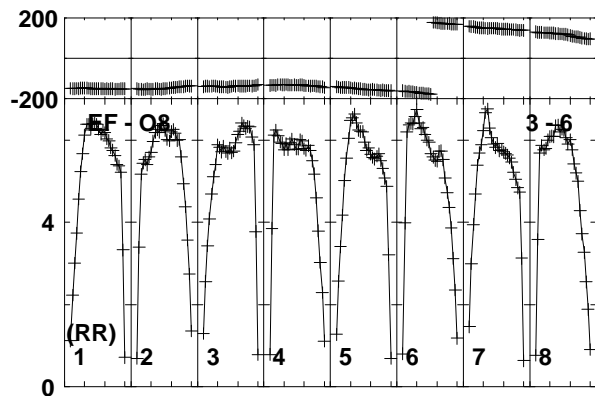
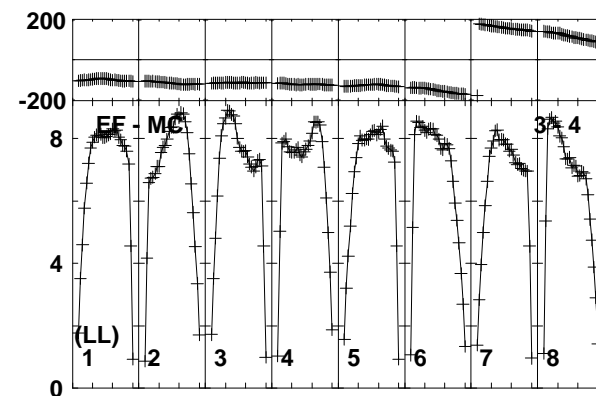
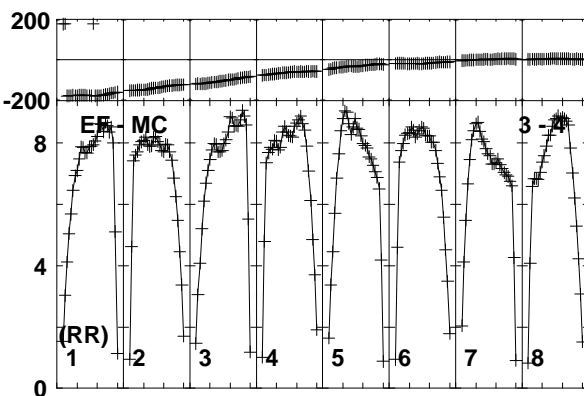
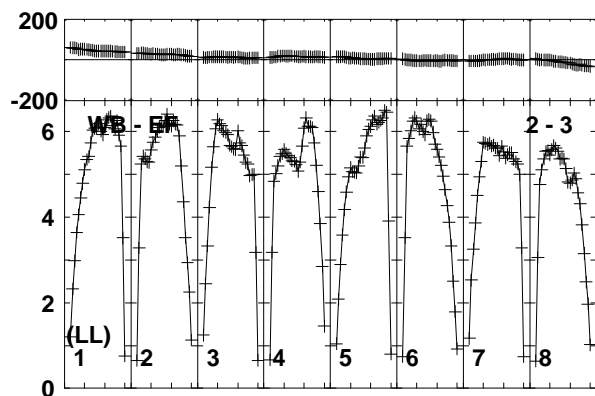
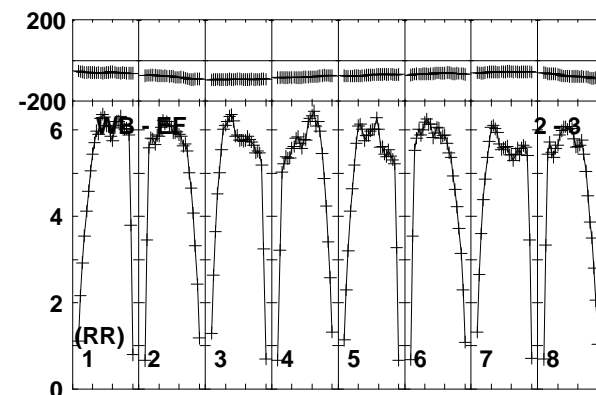
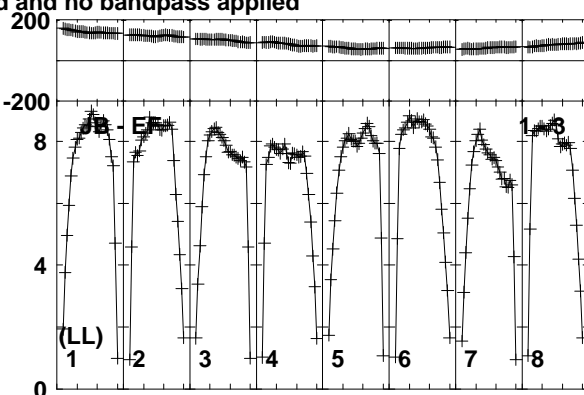
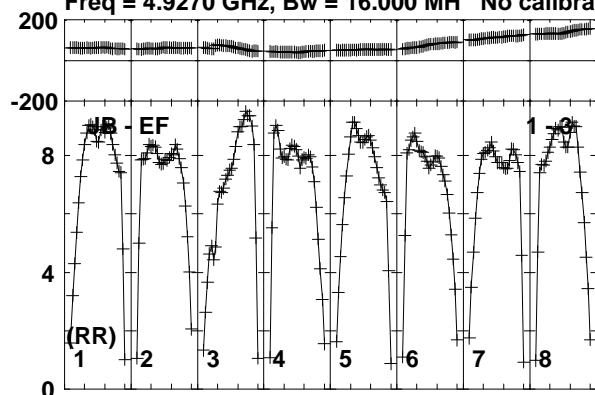

Lower frame: Milli Ampl Jy Top frame: Phas deg  
Vector averaged cross-power spectrum Baseline: JB (01) - EF (03)  
Timerange: 00/17:53:31 to 00/17:54:29

Plot file version 937 created 19-DEC-2018 17:59:13

J1619+2247 RY007C.UVDATA.1

Freq = 4.9270 GHz, Bw = 16.000 MH No calibration applied and no bandpass applied

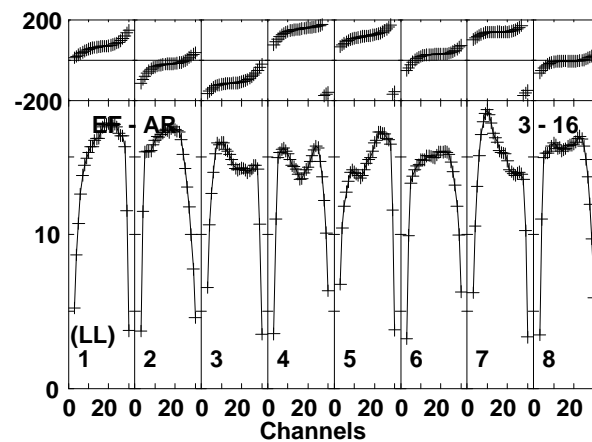
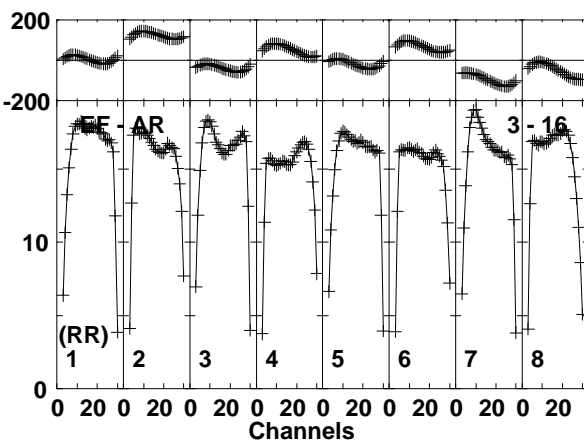
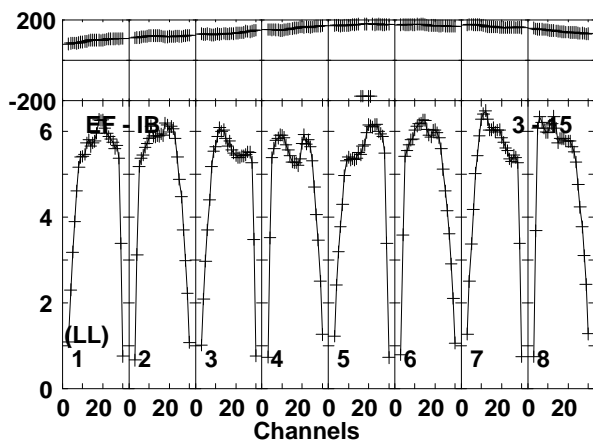
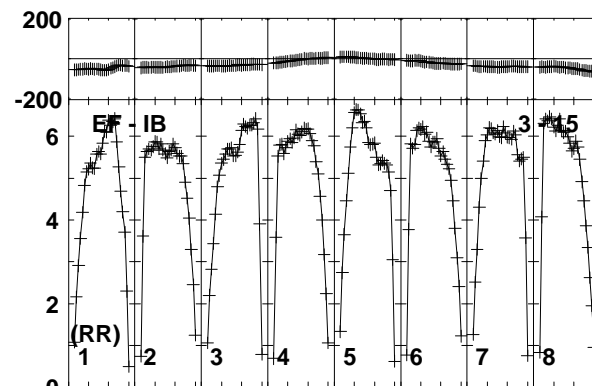
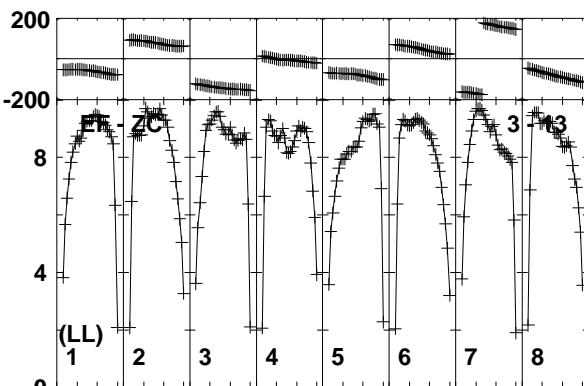
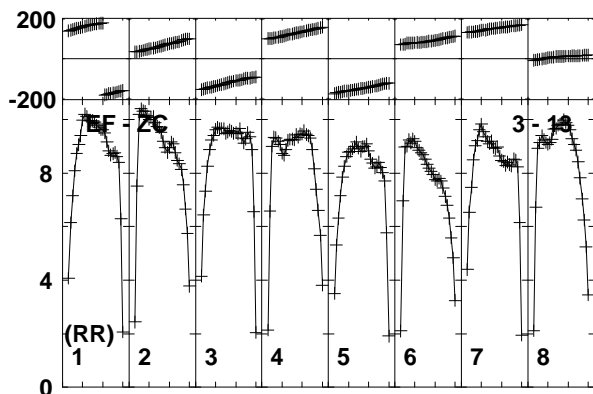
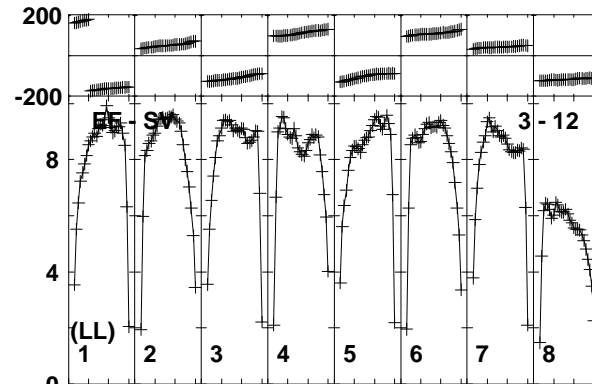
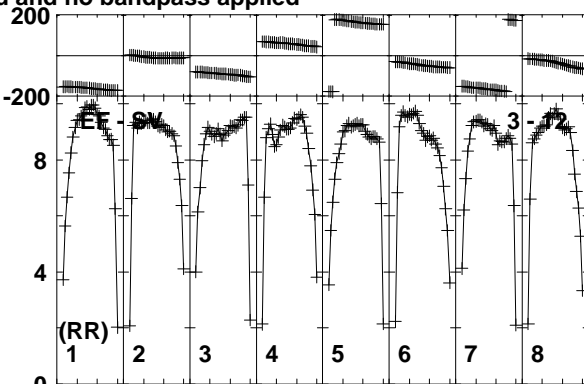
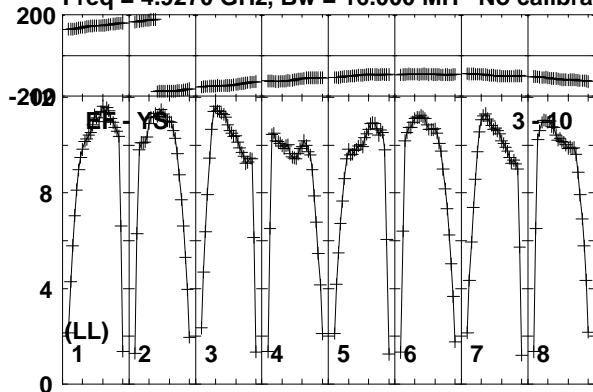

Lower frame: Milli Ampl Jy Top frame: Phas deg  
Vector averaged cross-power spectrum Baseline: EF (03) - YS (10)  
Timerange: 00/17:53:31 to 00/17:54:29

Plot file version 938 created 19-DEC-2018 17:59:13

AT2018\_RY007C.UVDATA.1

Freq = 4.9270 GHz, Bw = 16.000 MH No calibration applied and no bandpass applied

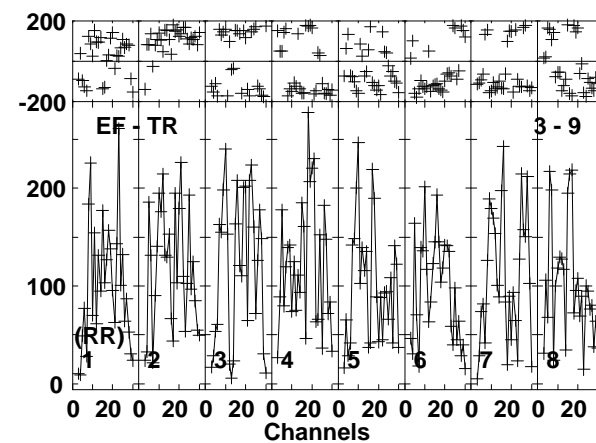
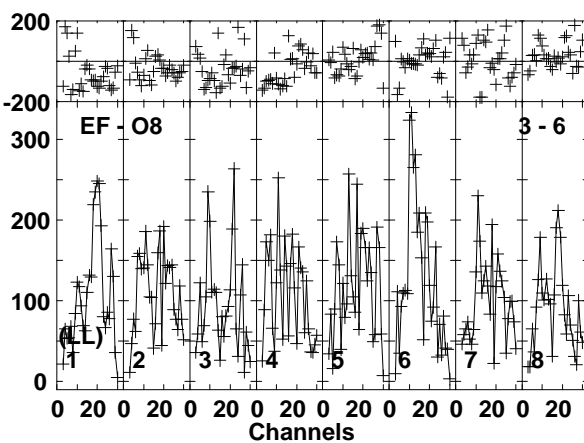
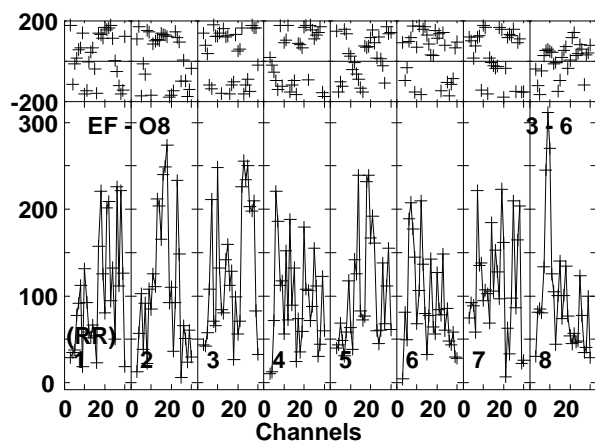
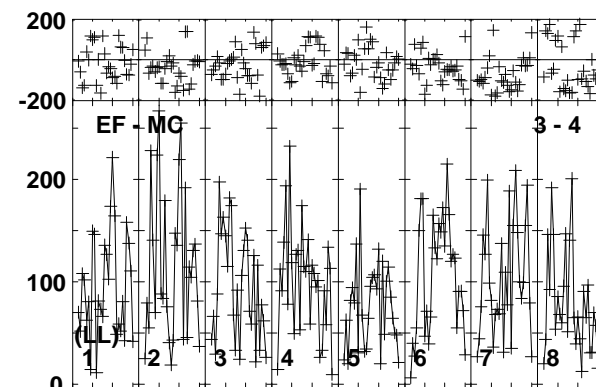
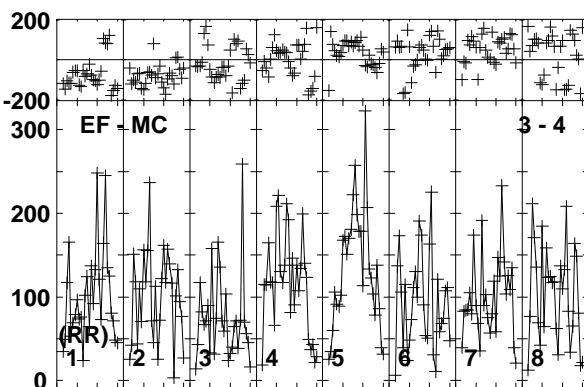
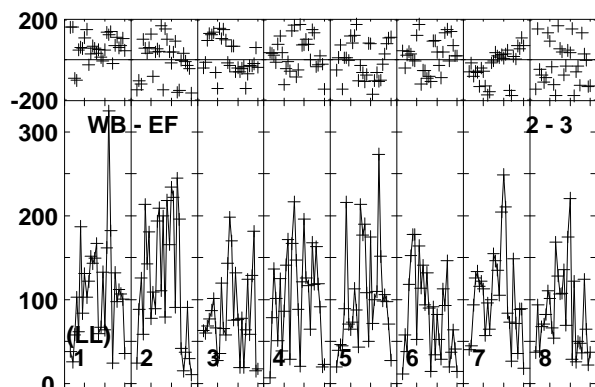
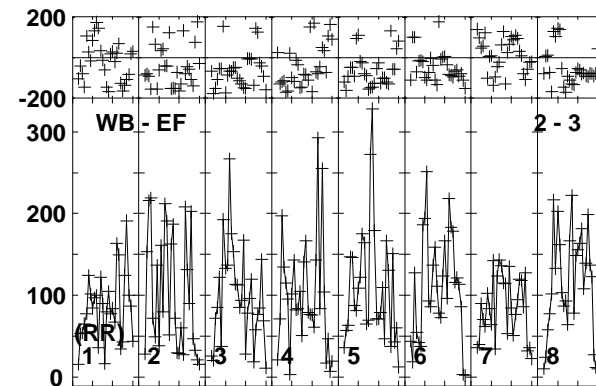
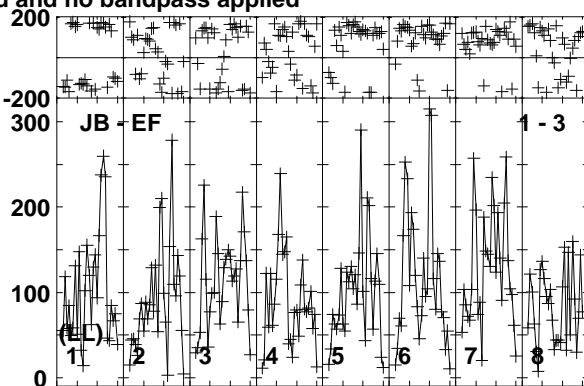
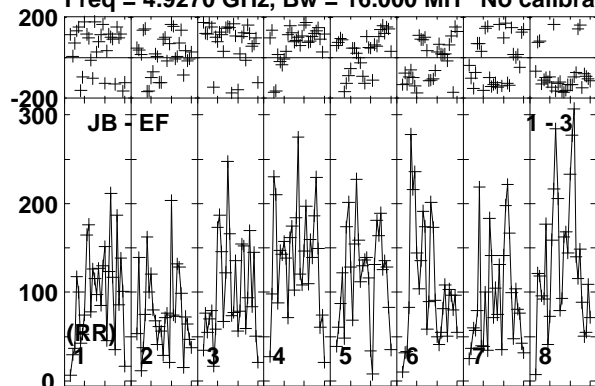

Lower frame: Micro Ampl Jy Top frame: Phas deg  
Vector averaged cross-power spectrum Baseline: JB (01) - EF (03)  
Timerange: 00/17:54:31 to 00/17:57:29



Plot file version 939 created 19-DEC-2018 17:59:13  
 AT2018\_RY007C.UVDATA.1

Freq = 4.9270 GHz, Bw = 16.000 MH No calibration applied and no bandpass applied

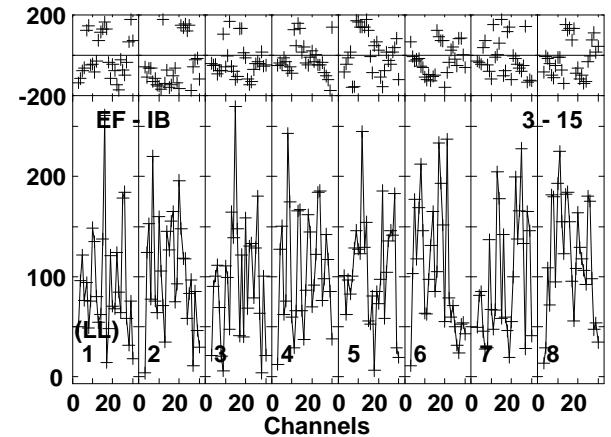
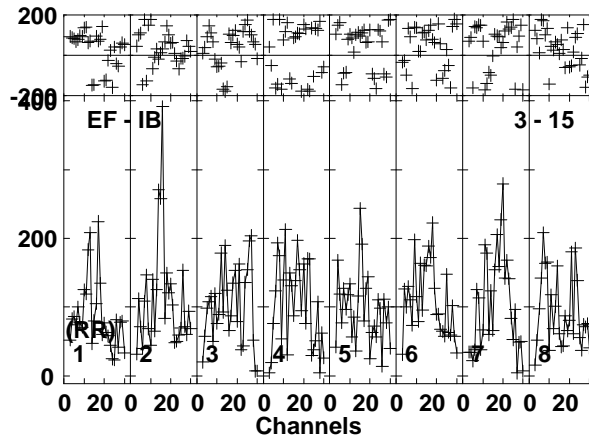
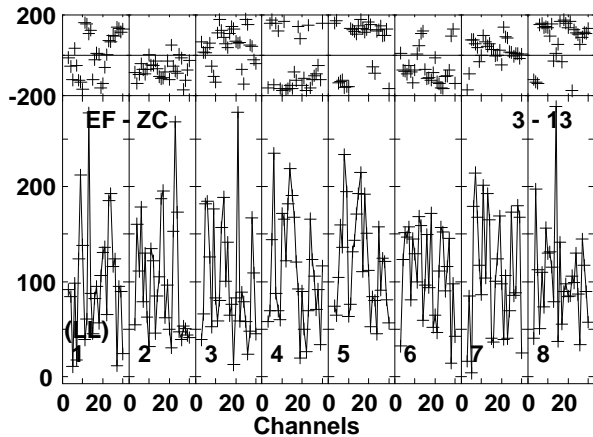
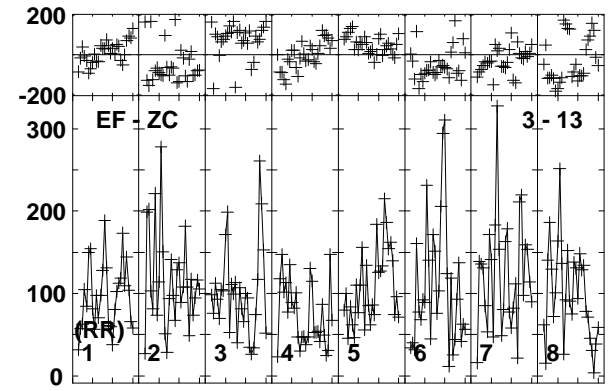
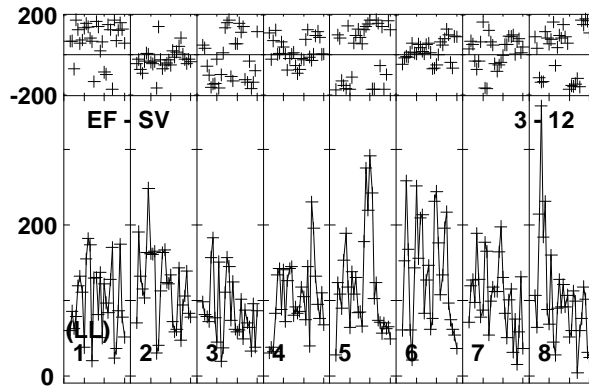
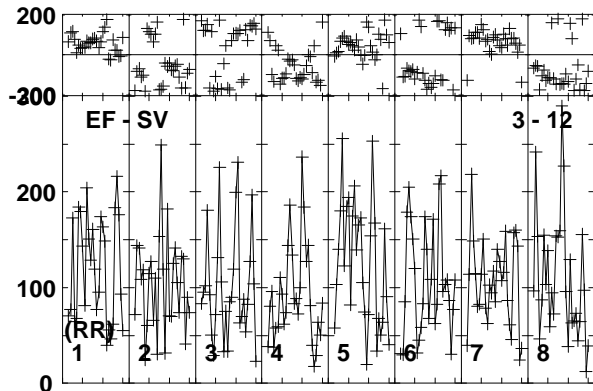
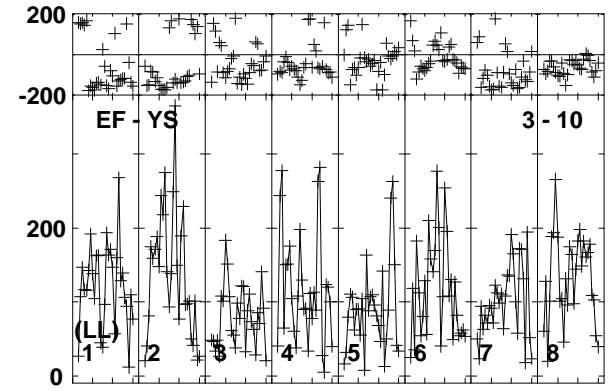
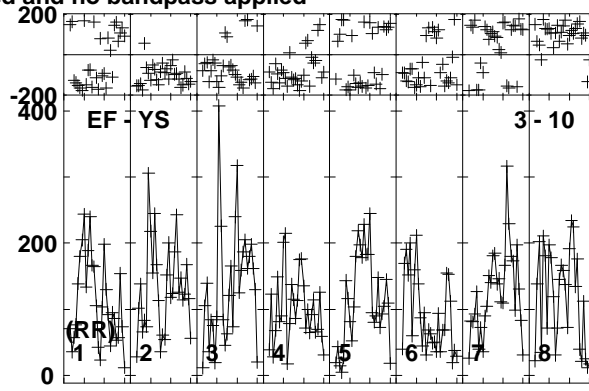
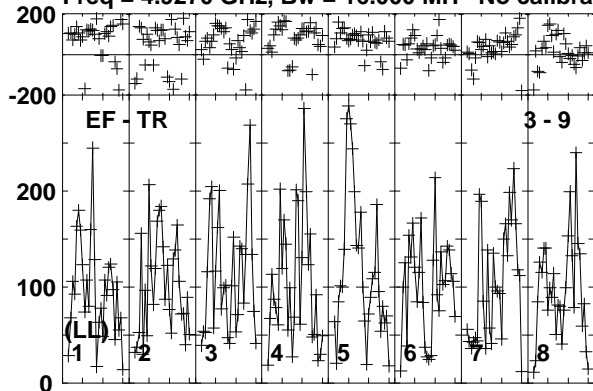

Lower frame: Micro Ampl Jy Top frame: Phas deg  
 Vector averaged cross-power spectrum Baseline: EF (03) - TR (09)  
 Timerange: 00/17:54:31 to 00/17:57:29

Plot file version 940 created 19-DEC-2018 17:59:13

AT2018\_RY007C.UVDATA.1

Freq = 4.9270 GHz, Bw = 16.000 MH No calibration applied and no bandpass applied

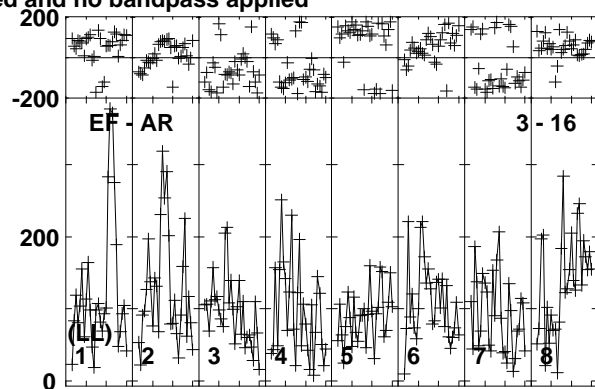
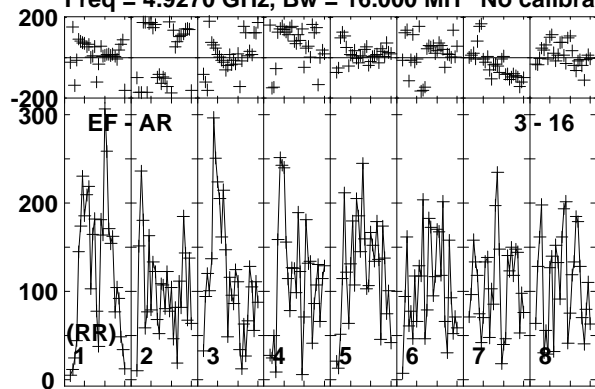

Lower frame: Micro Ampl Jy Top frame: Phas deg  
Vector averaged cross-power spectrum Baseline: EF (03) - AR (16)  
Timerange: 00/17:54:31 to 00/17:57:29

Plot file version 941 created 19-DEC-2018 17:59:13

J1619+2247 RY007C.UVDATA.1

Freq = 4.9270 GHz, Bw = 16.000 MH No calibration applied and no bandpass applied

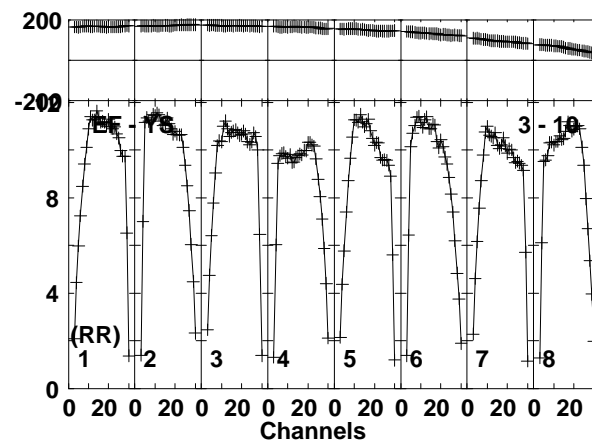
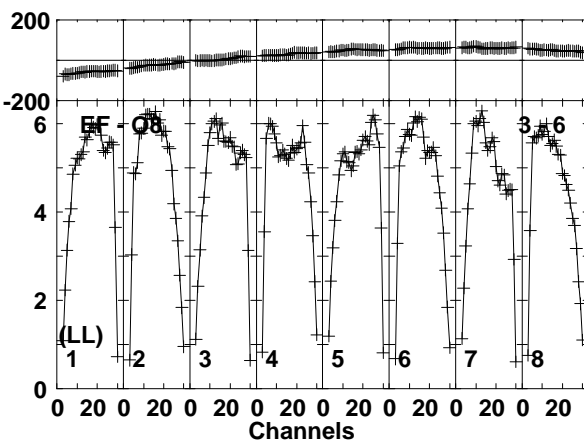
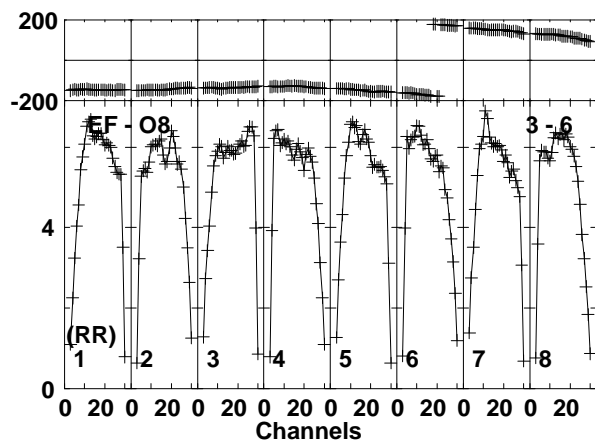
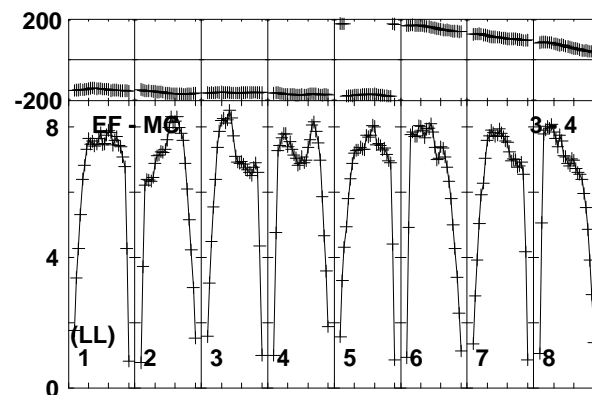
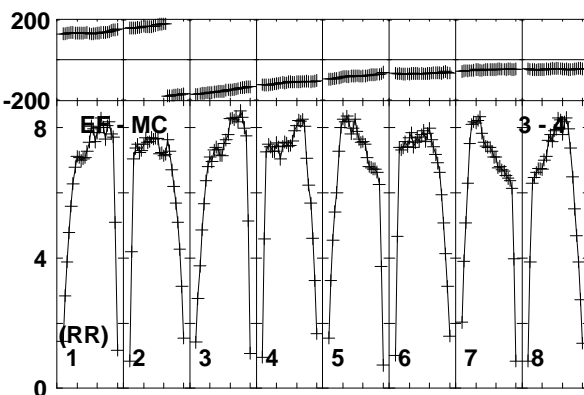
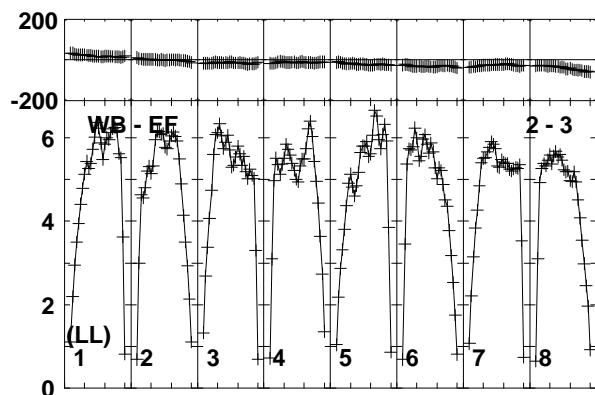
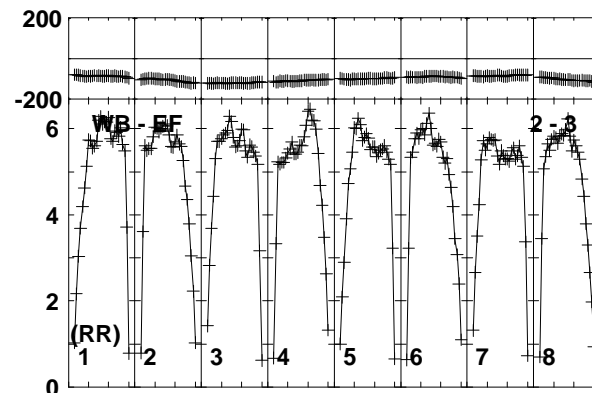
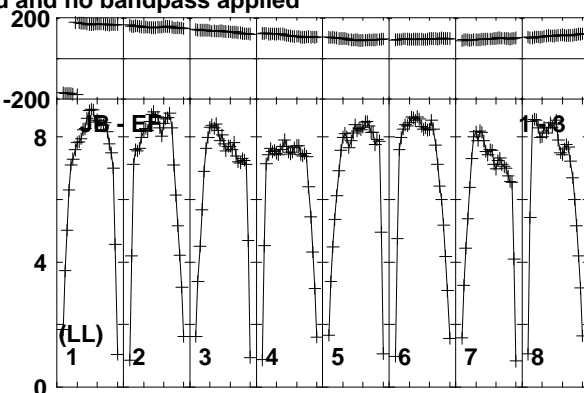
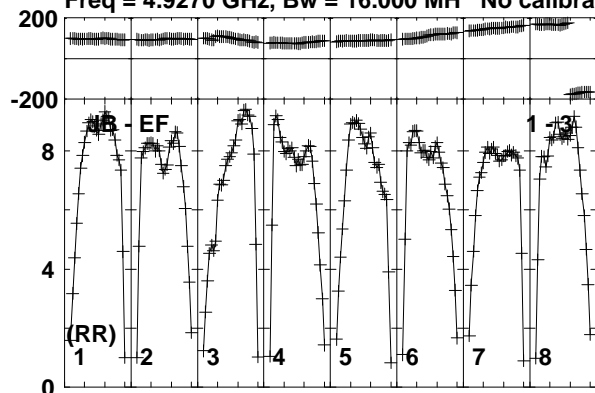

Lower frame: Milli Ampl Jy Top frame: Phas deg  
Vector averaged cross-power spectrum Baseline: JB (01) - EF (03)  
Timerange: 00:17:57:31 to 00:17:58:29

Plot file version 942 created 19-DEC-2018 17:59:13

J1619+2247 RY007C.UVDATA.1

Freq = 4.9270 GHz, Bw = 16.000 MH No calibration applied and no bandpass applied

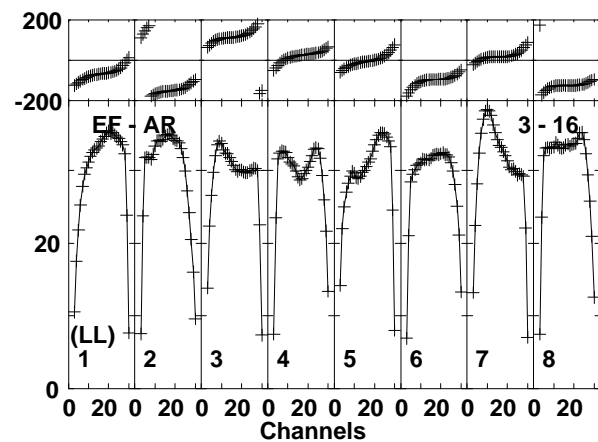
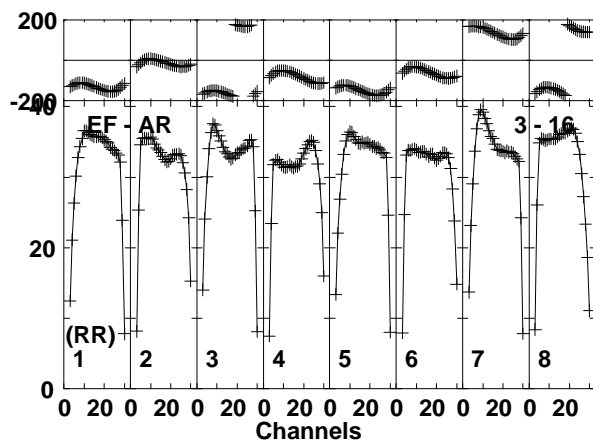
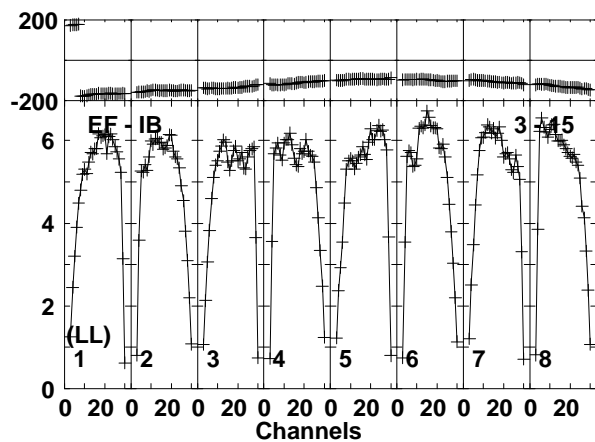
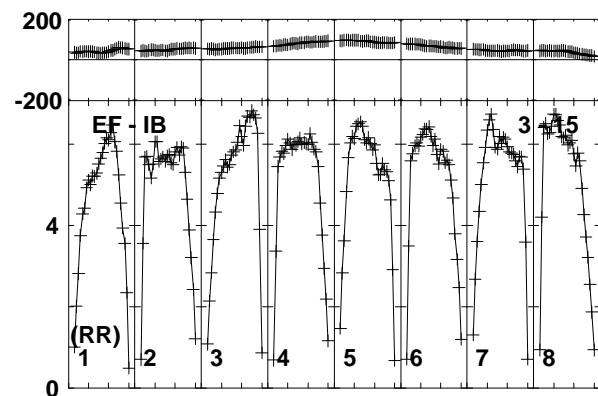
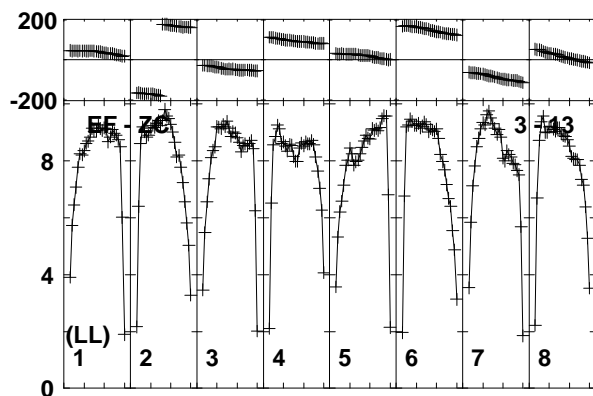
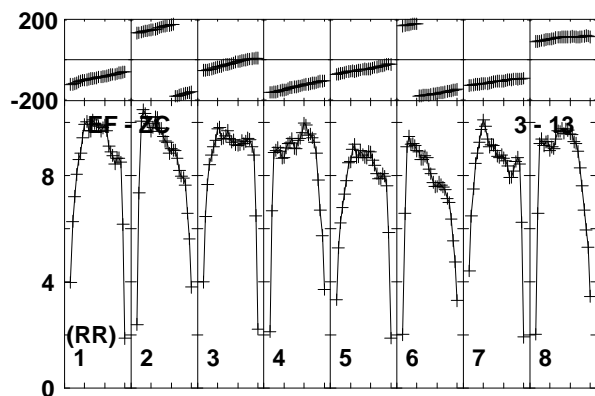
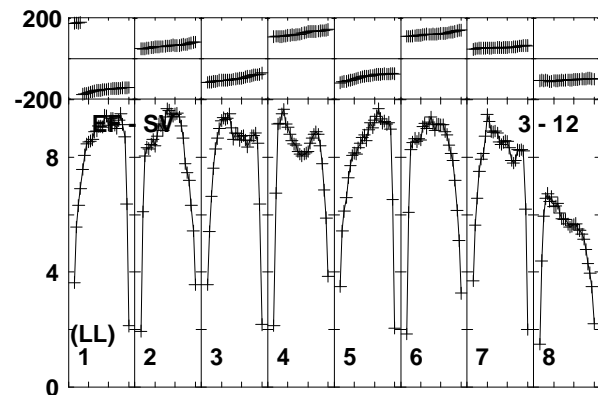
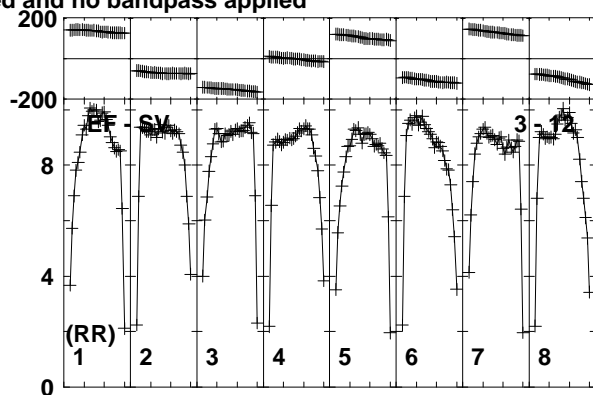
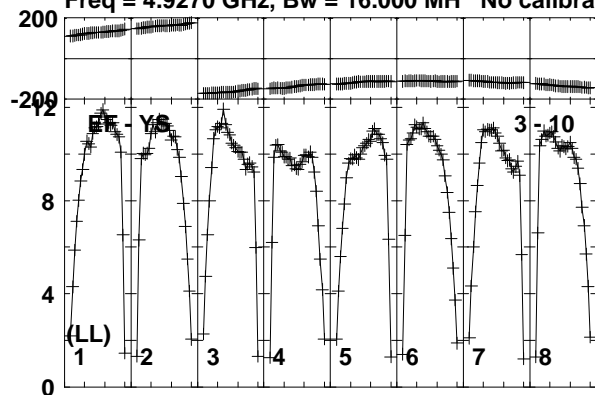

Lower frame: Milli Ampl Jy Top frame: Phas deg  
Vector averaged cross-power spectrum Baseline: EF (03) - YS (10)  
Timerange: 00/17:57:31 to 00/17:58:29

Plot file version 943 created 19-DEC-2018 17:59:13

AT2018\_RY007C.UVDATA.1

Freq = 4.9270 GHz, Bw = 16.000 MH No calibration applied and no bandpass applied

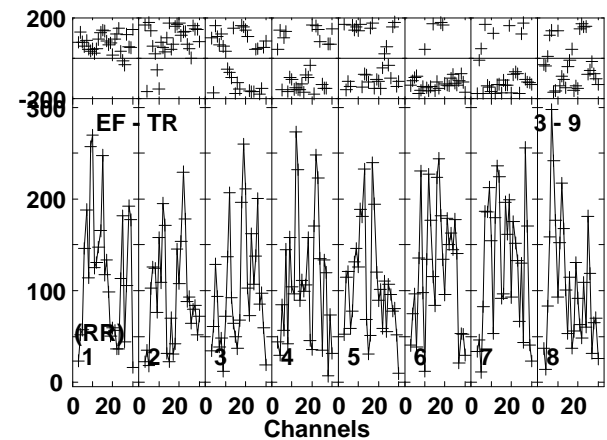
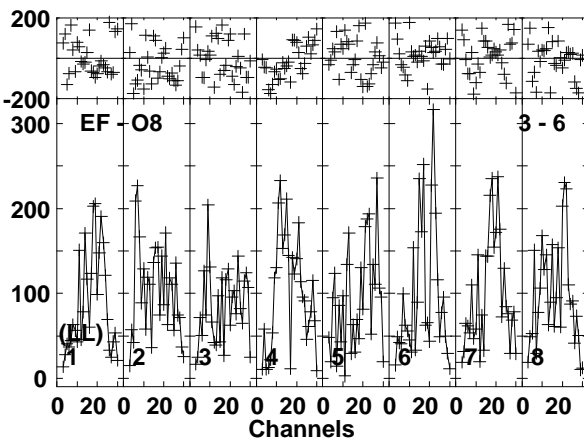
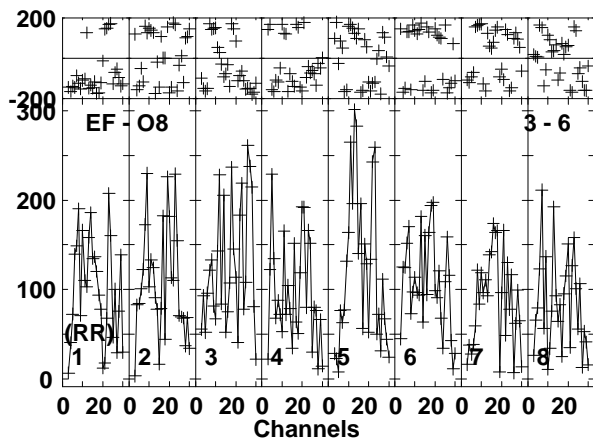
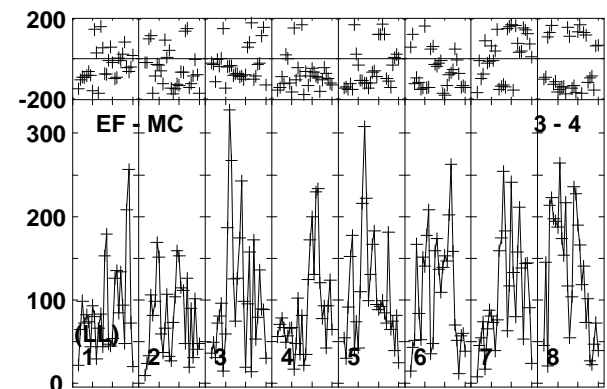
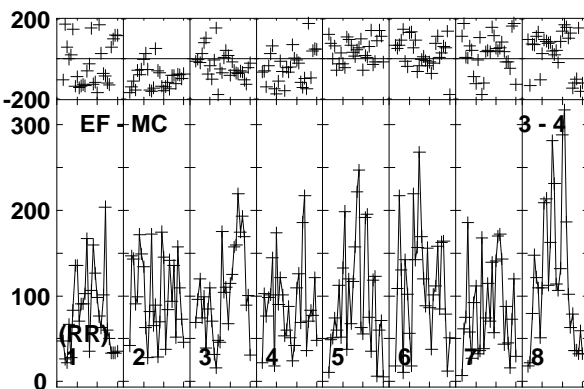
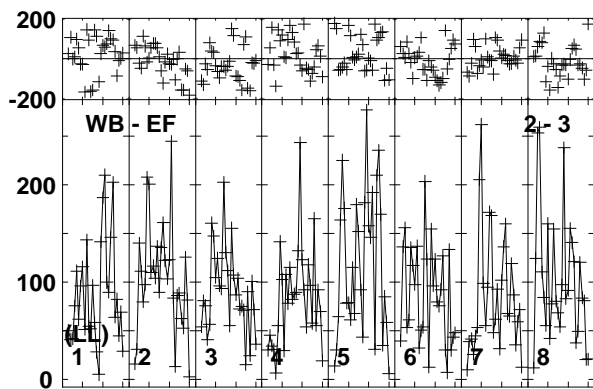
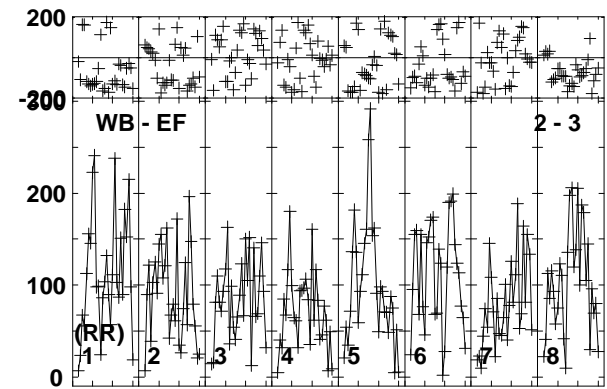
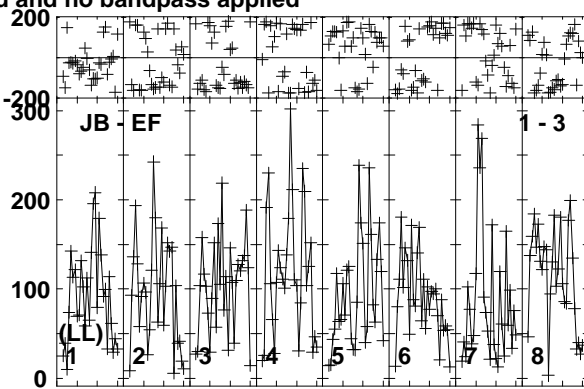
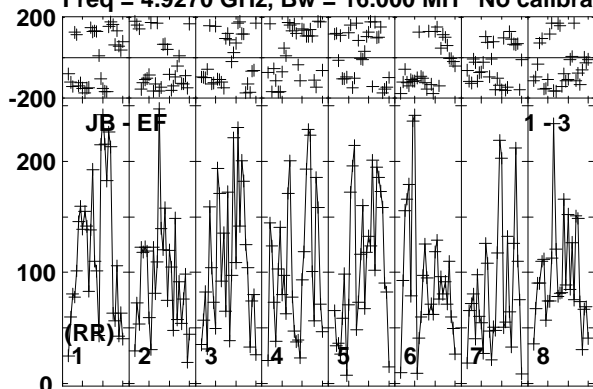

Lower frame: Micro Ampl Jy Top frame: Phas deg  
Vector averaged cross-power spectrum Baseline: JB (01) - EF (03)  
Timerange: 00/17:58:31 to 00/18:01:29

Plot file version 944 created 19-DEC-2018 17:59:13

AT2018\_RY007C.UVDATA.1

Freq = 4.9270 GHz, Bw = 16.000 MH No calibration applied and no bandpass applied

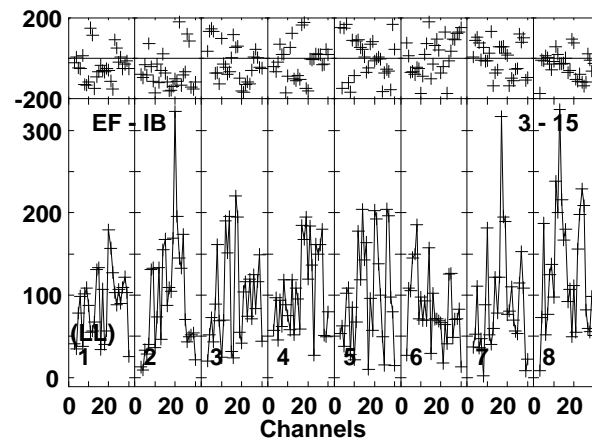
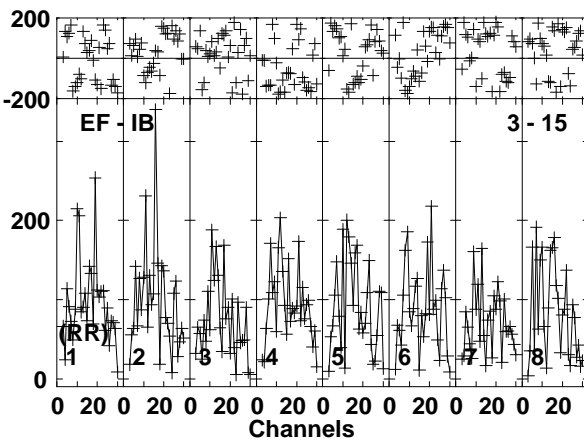
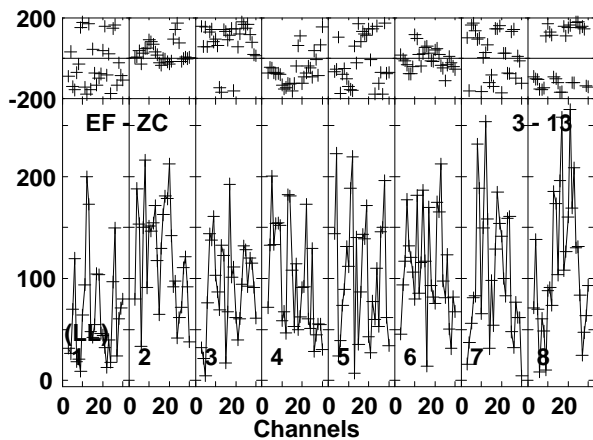
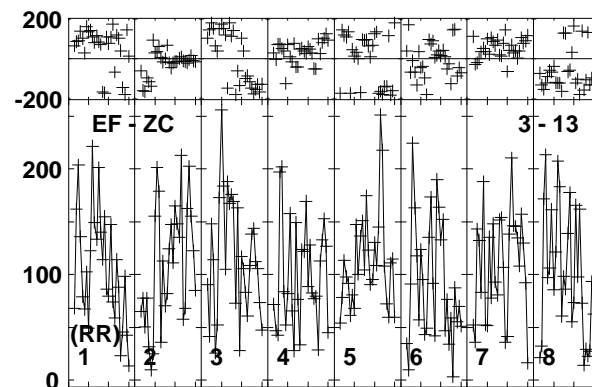
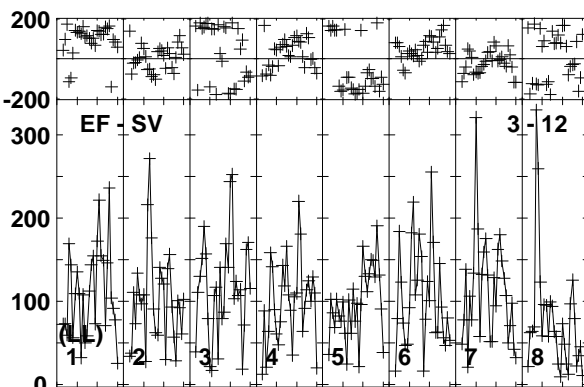
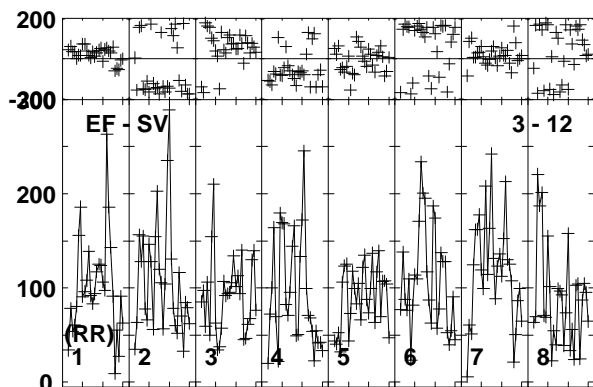
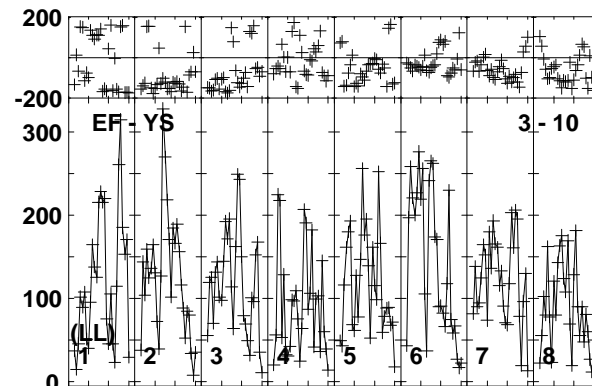
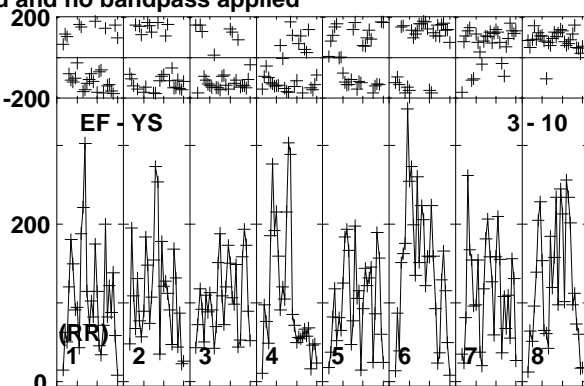
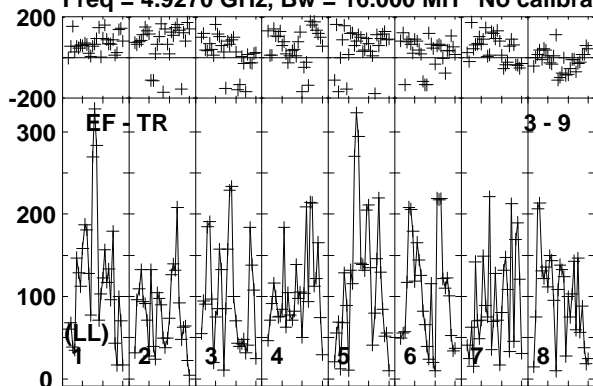

Lower frame: Micro Ampl Jy Top frame: Phas deg  
Vector averaged cross-power spectrum Baseline: EF (03) - TR (09)  
Timerange: 00/17:58:31 to 00/18:01:29

Plot file version 945 created 19-DEC-2018 17:59:13

AT2018\_RY007C.UVDATA.1

Freq = 4.9270 GHz, Bw = 16.000 MH No calibration applied and no bandpass applied

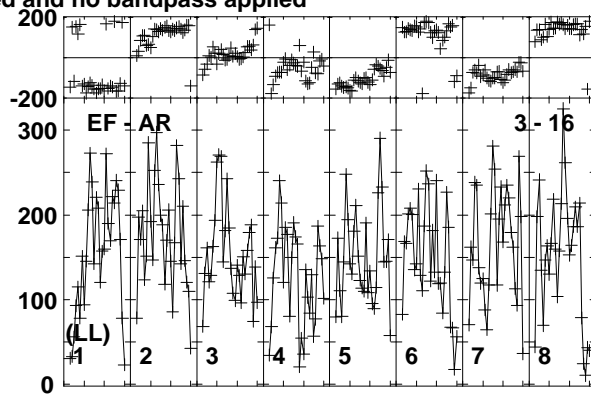
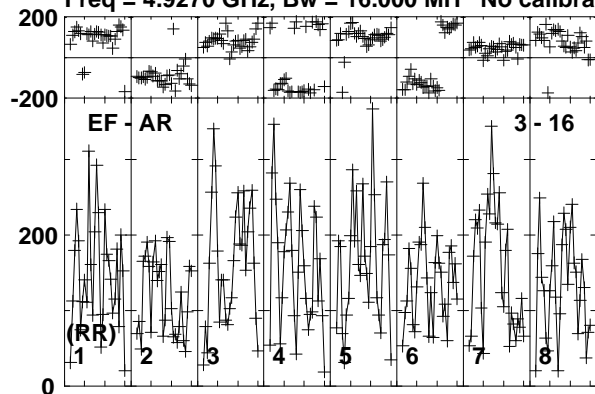

Lower frame: Micro Ampl Jy Top frame: Phas deg  
Vector averaged cross-power spectrum Baseline: EF (03) - AR (16)  
Timerange: 00/17:58:31 to 00/18:01:29

Plot file version 946 created 19-DEC-2018 17:59:13

J1619+2247 RY007C.UVDATA.1

Freq = 4.9270 GHz, Bw = 16.000 MH No calibration applied and no bandpass applied

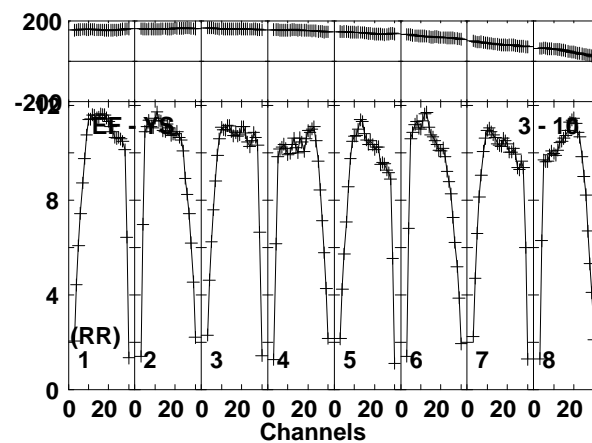
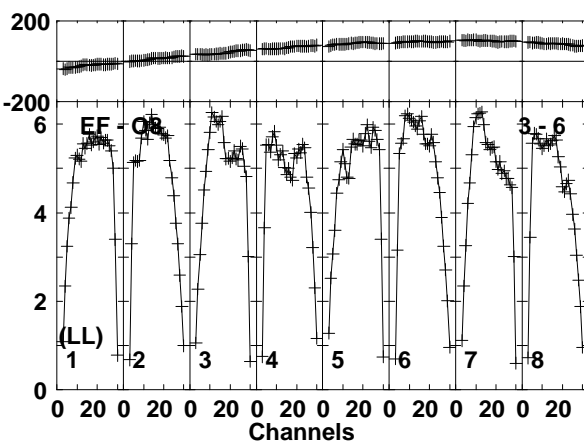
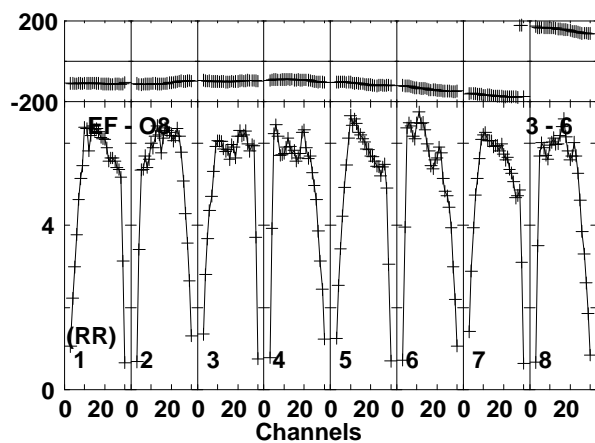
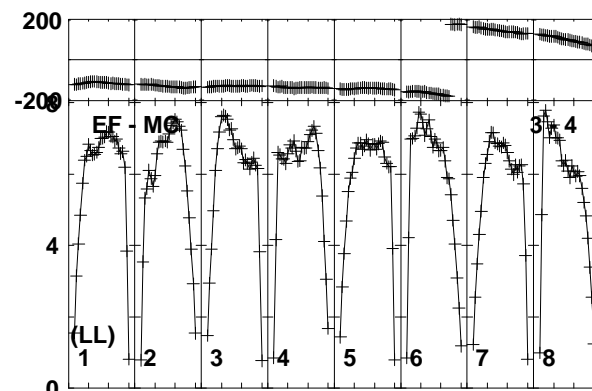
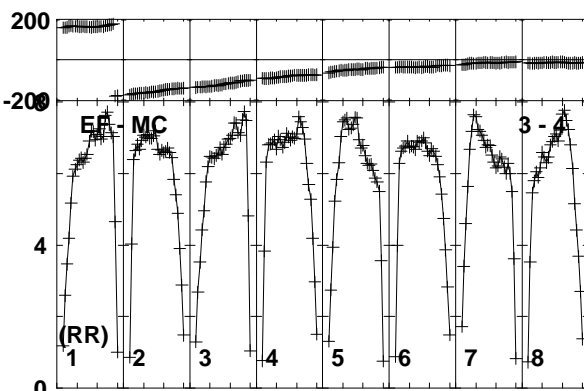
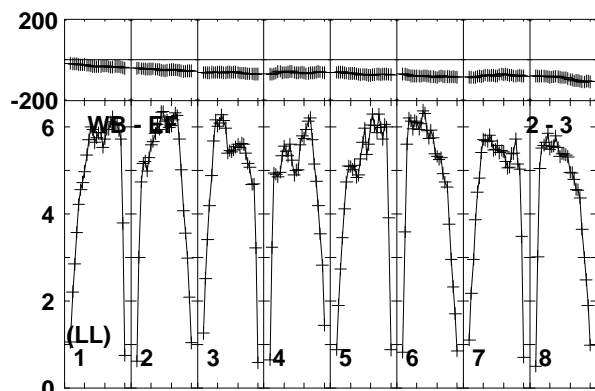
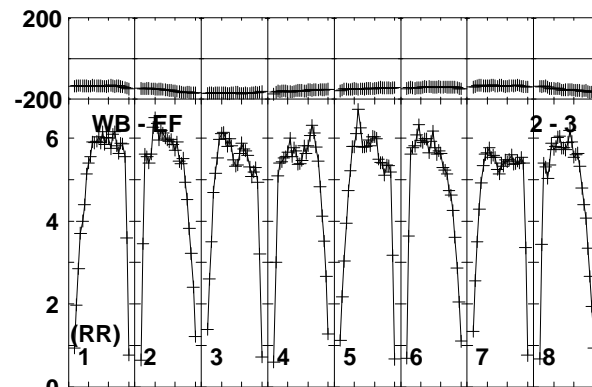
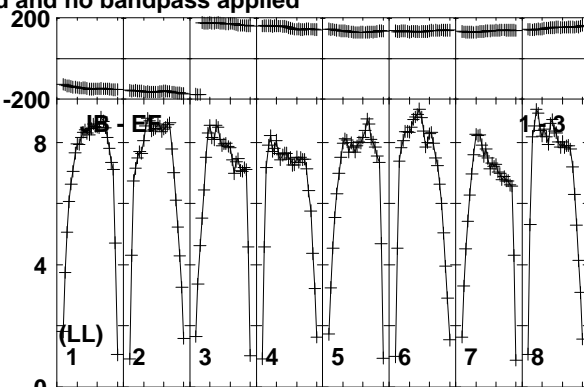
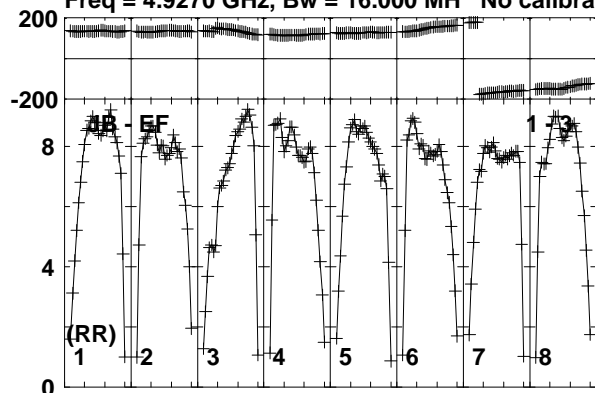

Lower frame: Milli Ampl Jy Top frame: Phas deg  
Vector averaged cross-power spectrum Baseline: JB (01) - EF (03)  
Timerange: 00:18:01:31 to 00:18:02:29



Plot file version 947 created 19-DEC-2018 17:59:13

J1619+2247 RY007C.UVDATA.1

Freq = 4.9270 GHz, Bw = 16.000 MH No calibration applied and no bandpass applied

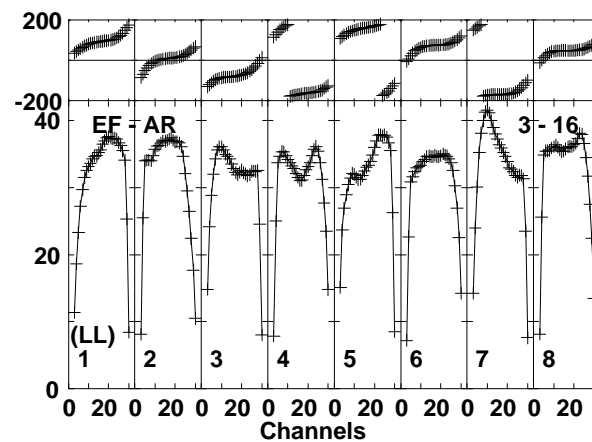
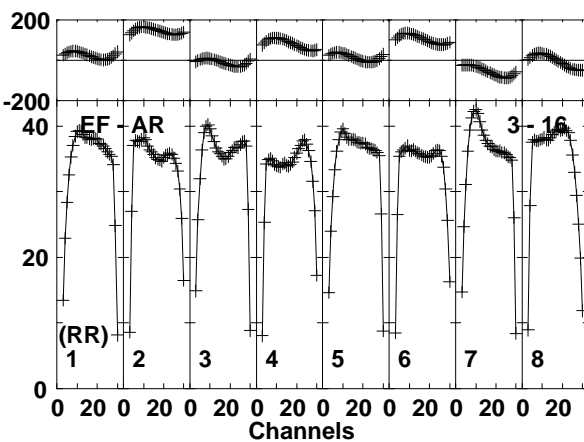
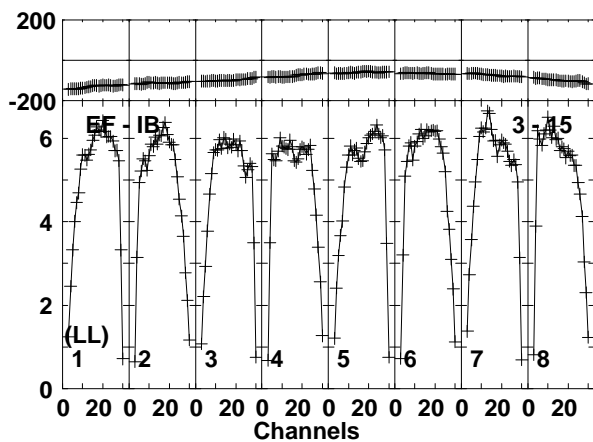
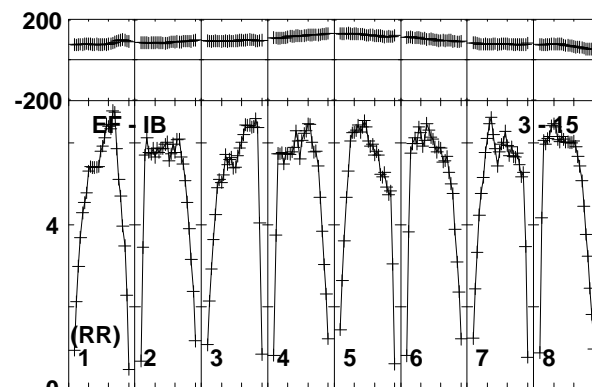
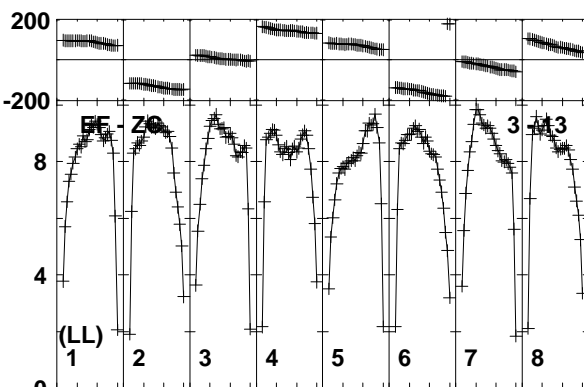
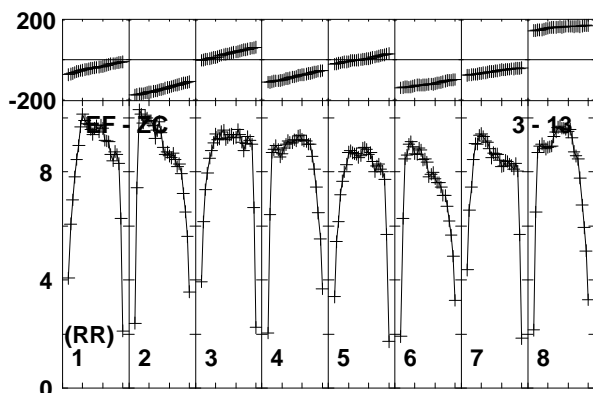
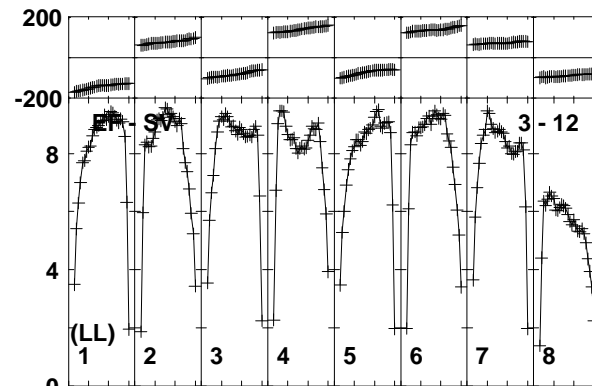
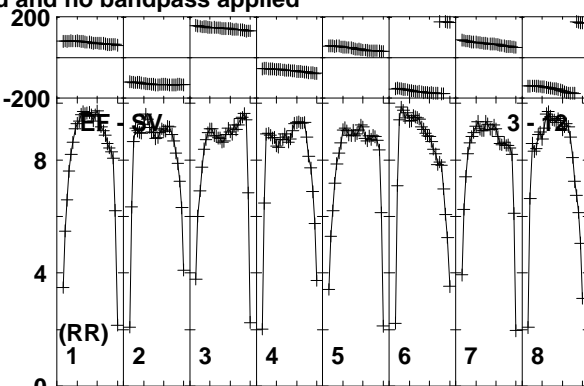
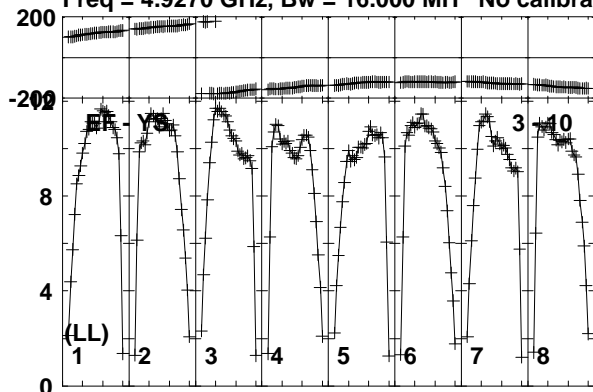

Lower frame: Milli Ampl Jy Top frame: Phas deg  
Vector averaged cross-power spectrum Baseline: EF (03) - YS (10)  
Timerange: 00/18:01:31 to 00/18:02:29

Plot file version 948 created 19-DEC-2018 17:59:13

VLA1 RY007C.UVDATA.1

Freq = 4.9270 GHz, Bw = 16.000 MH No calibration applied and no bandpass applied

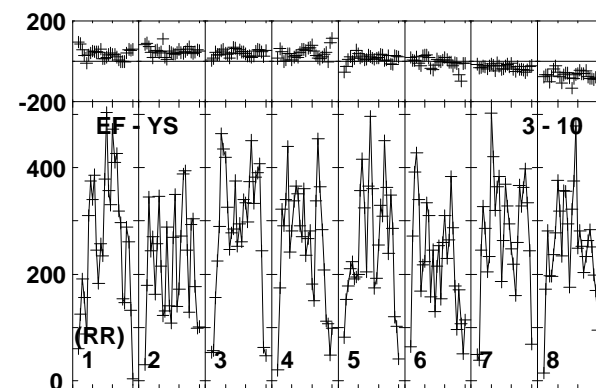
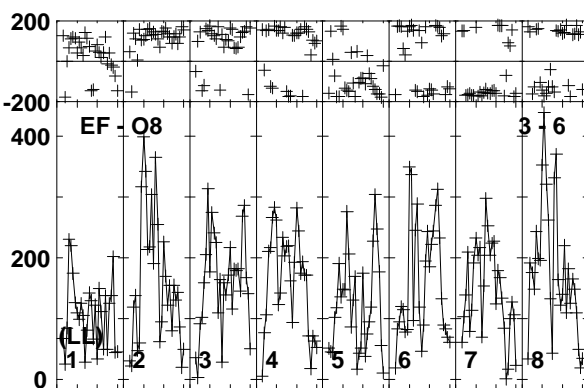
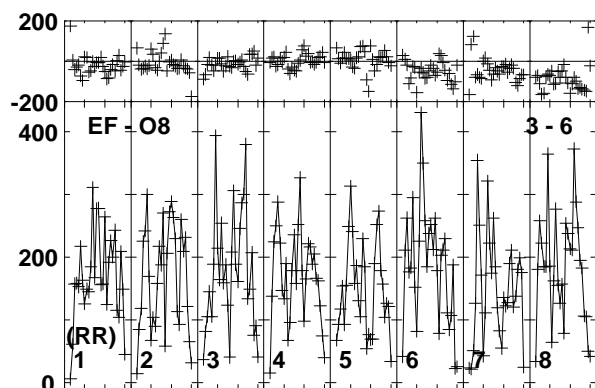
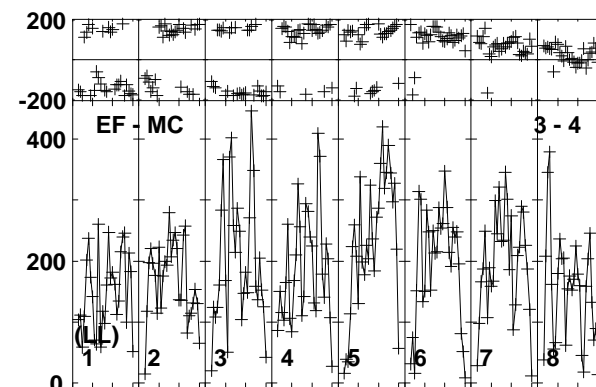
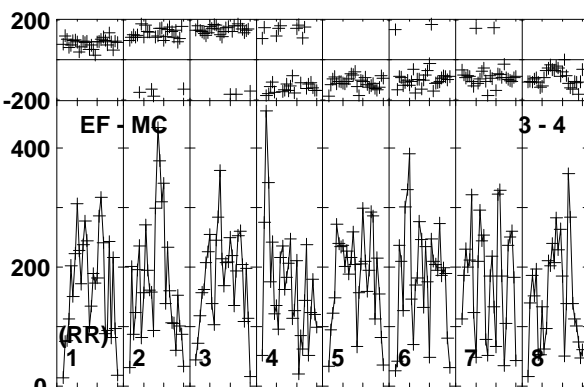
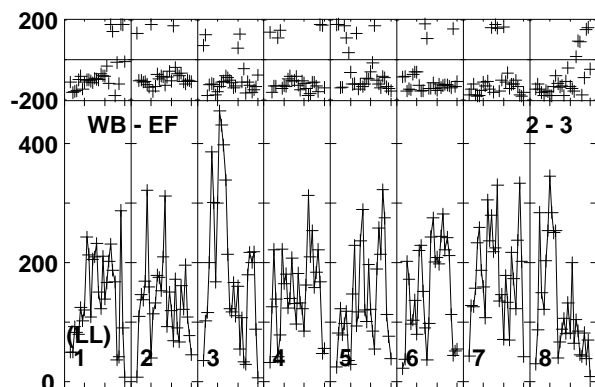
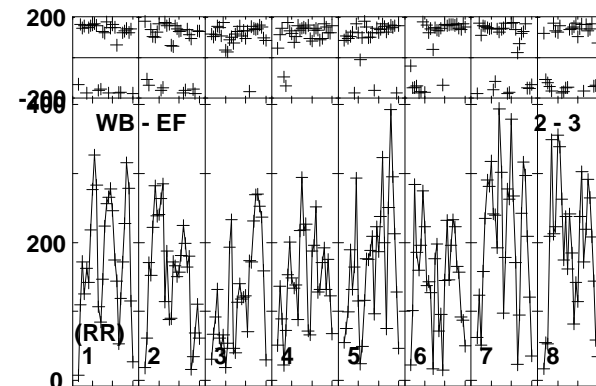
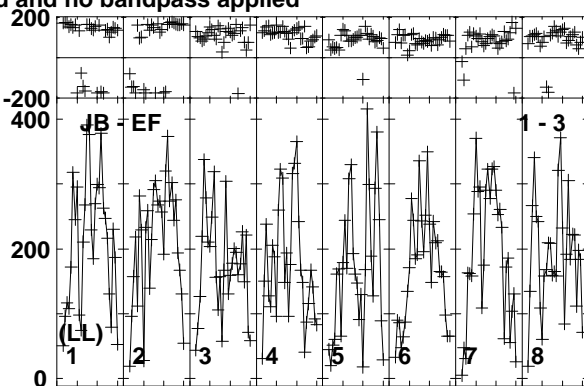
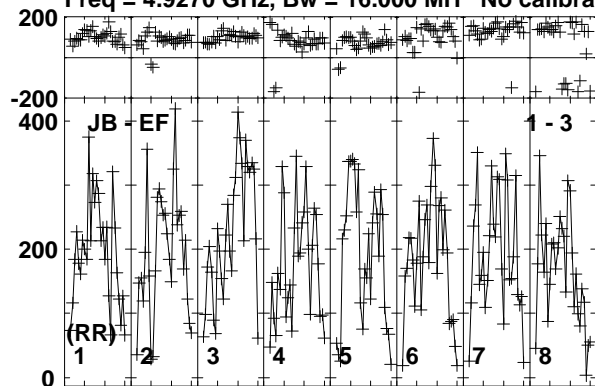

Lower frame: Micro Ampl Jy Top frame: Phas deg  
Vector averaged cross-power spectrum Baseline: JB (01) - EF (03)  
Timerange: 00/18:03:01 to 00/18:04:59

Plot file version 949 created 19-DEC-2018 17:59:13

VLA1 RY007C.UVDATA.1

Freq = 4.9270 GHz, Bw = 16.000 MH No calibration applied and no bandpass applied

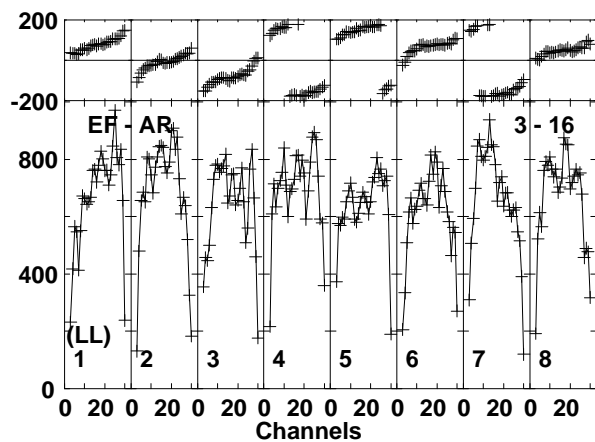
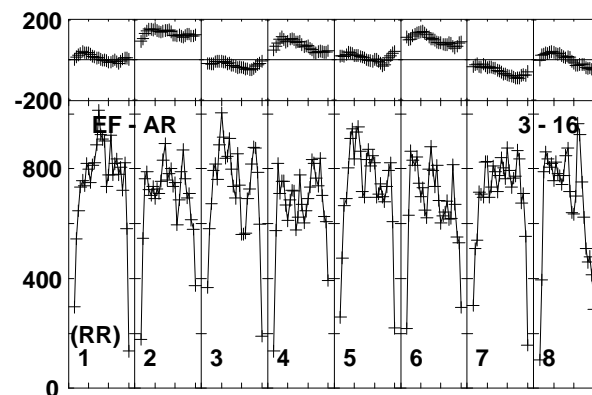
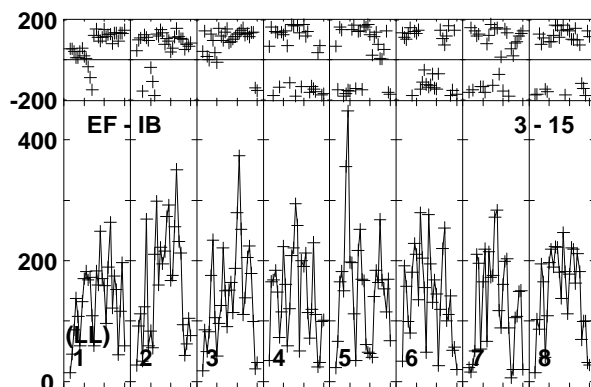
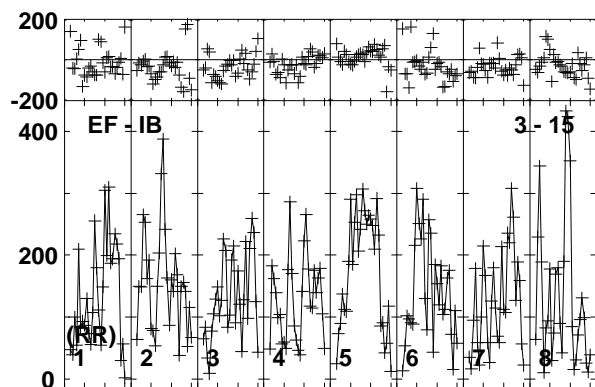
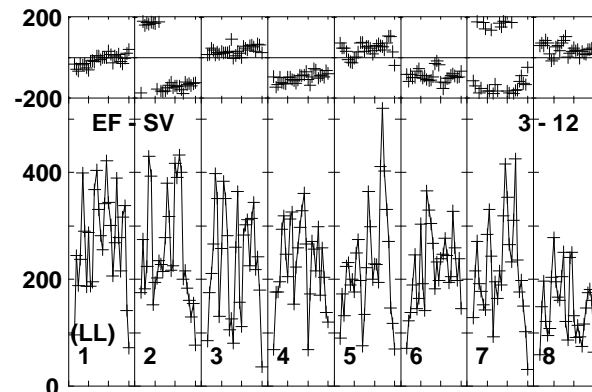
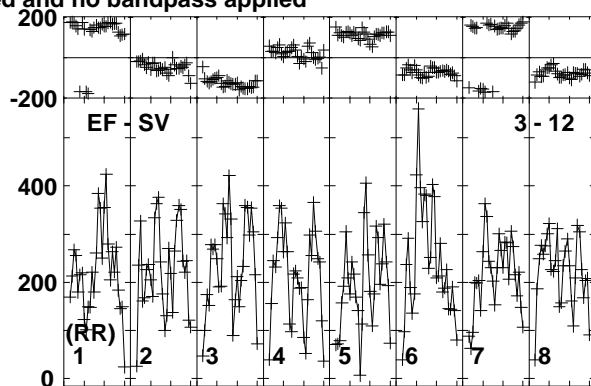
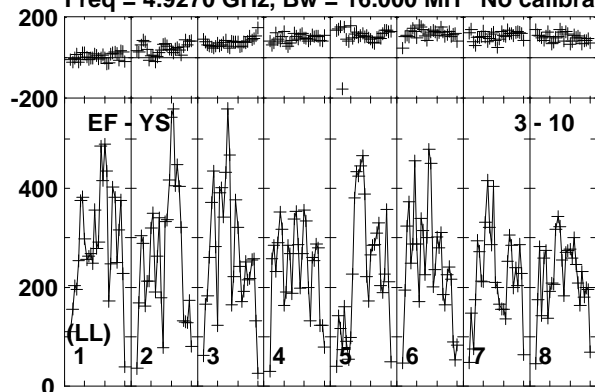

Lower frame: Micro Ampl Jy Top frame: Phas deg  
Vector averaged cross-power spectrum Baseline: EF (03) - YS (10)  
Timerange: 00:18:03:01 to 00:18:04:59

Plot file version 950 created 19-DEC-2018 17:59:13

J1619+2247 RY007C.UVDATA.1

Freq = 4.9270 GHz, Bw = 16.000 MH No calibration applied and no bandpass applied

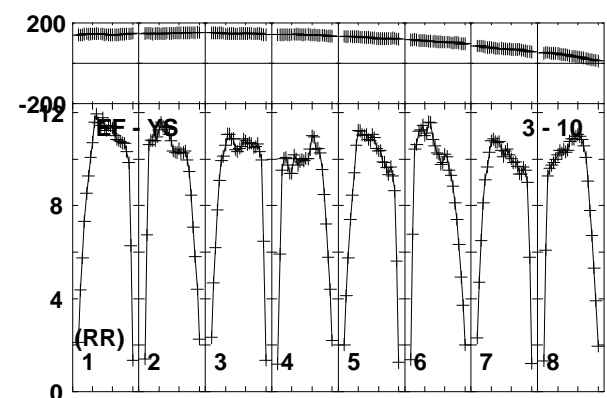
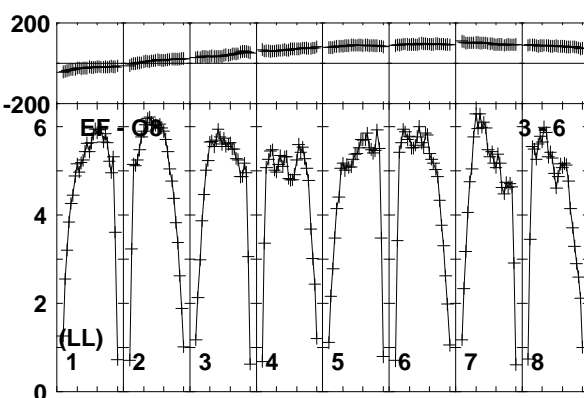
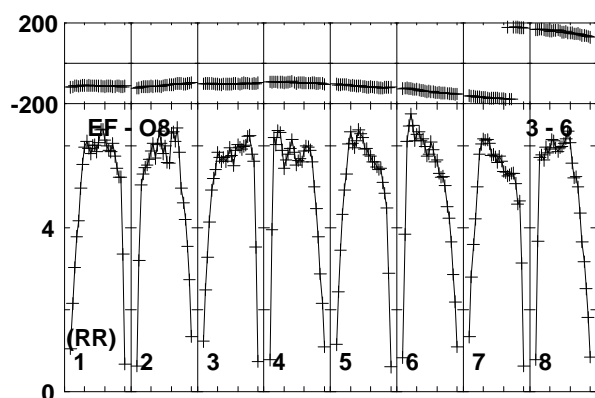
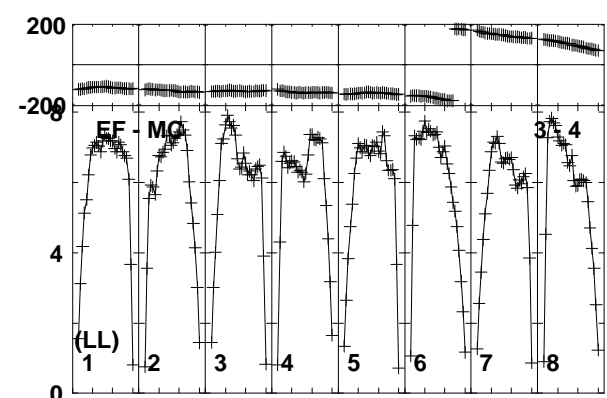
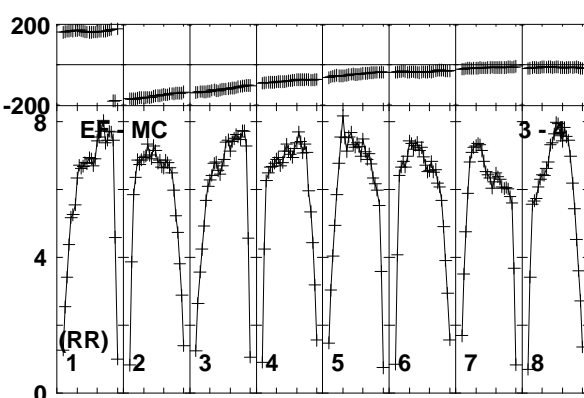
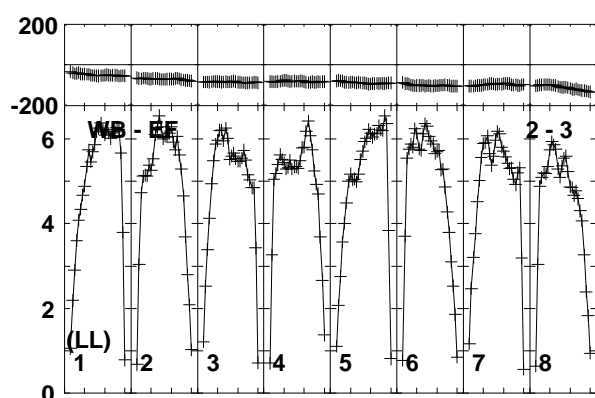
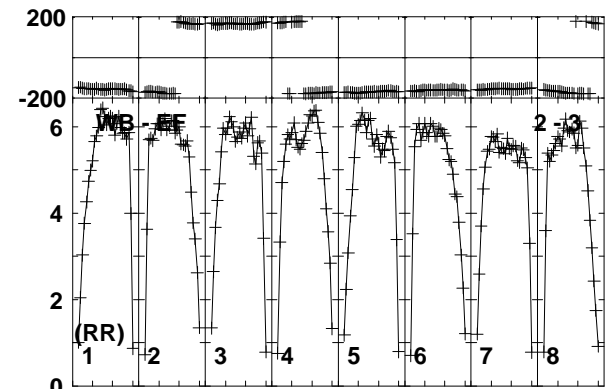
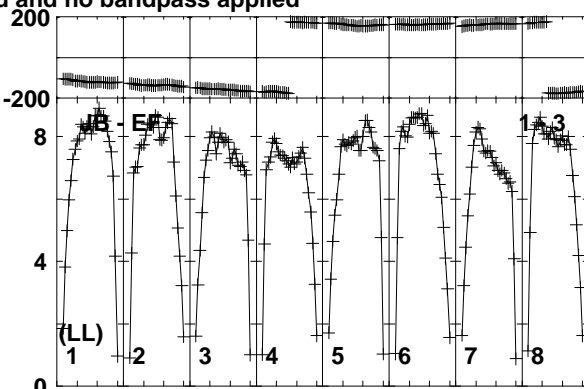
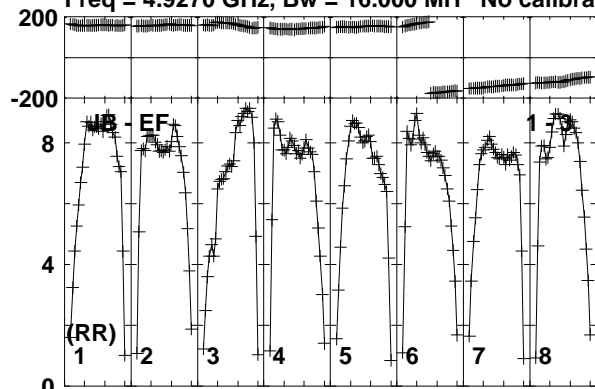

Lower frame: Milli Ampl Jy Top frame: Phas deg  
Vector averaged cross-power spectrum Baseline: JB (01) - EF (03)  
Timerange: 00/18:05:01 to 00/18:05:59

Plot file version 951 created 19-DEC-2018 17:59:13

J1619+2247 RY007C.UVDATA.1

Freq = 4.9270 GHz, Bw = 16.000 MH No calibration applied and no bandpass applied

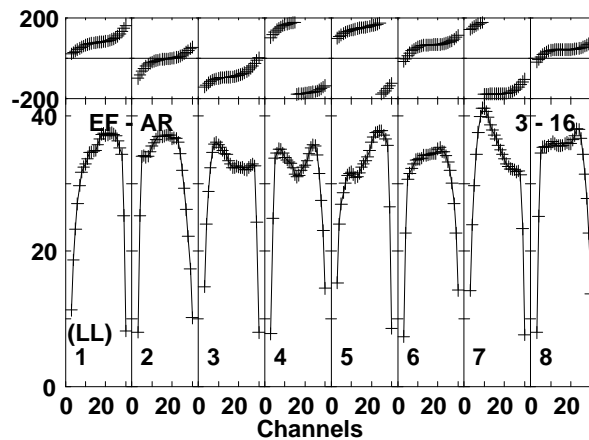
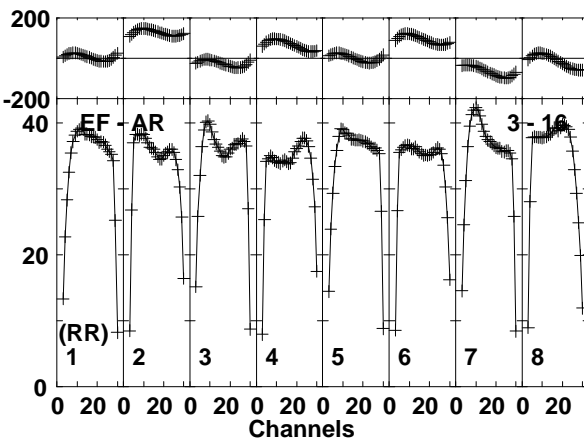
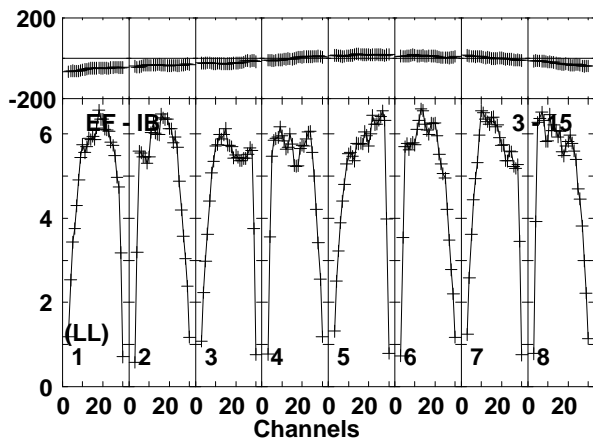
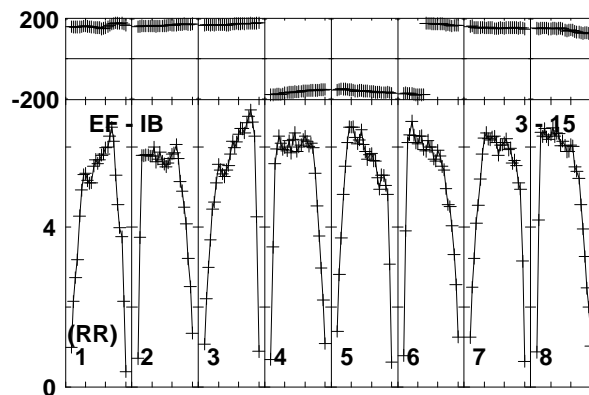
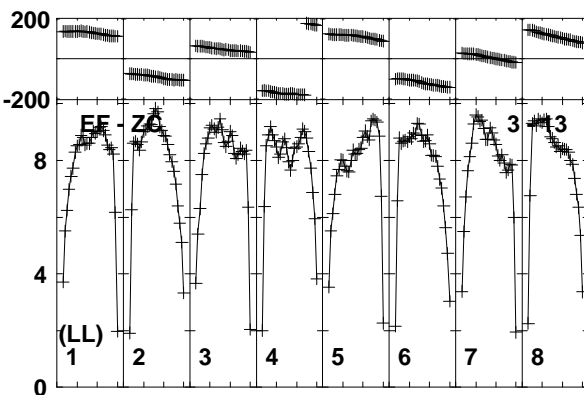
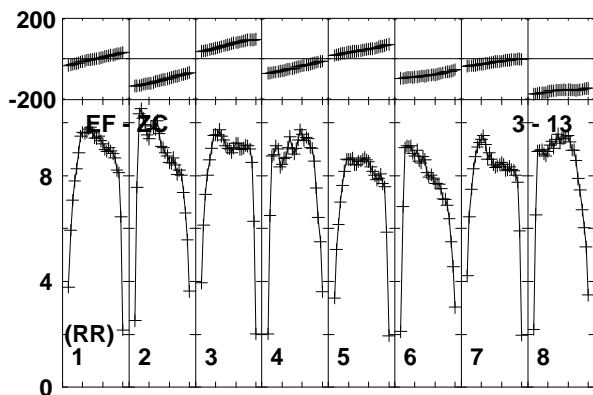
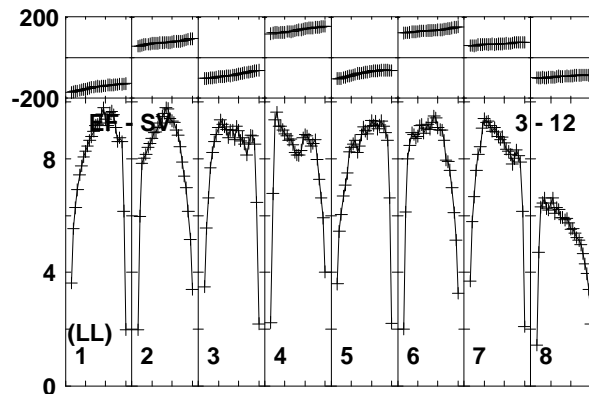
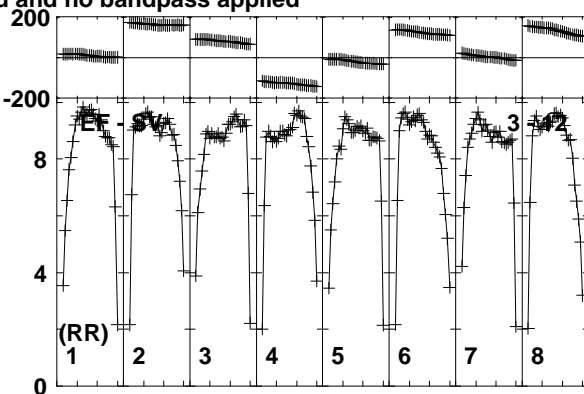
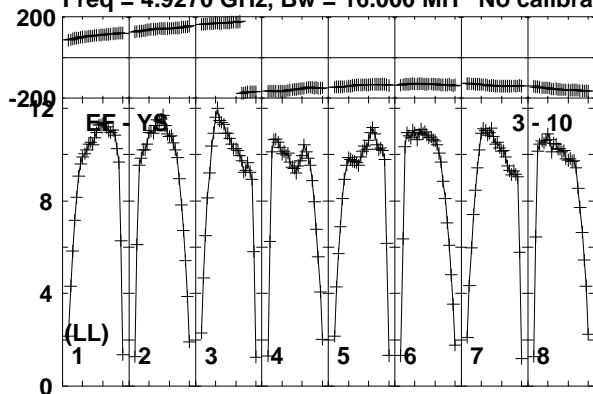

Lower frame: Milli Ampl Jy Top frame: Phas deg  
Vector averaged cross-power spectrum Baseline: EF (03) - YS (10)  
Timerange: 00/18:05:01 to 00/18:05:59

Plot file version 952 created 19-DEC-2018 17:59:13

AT2018\_RY007C.UVDATA.1

Freq = 4.9270 GHz, Bw = 16.000 MH No calibration applied and no bandpass applied

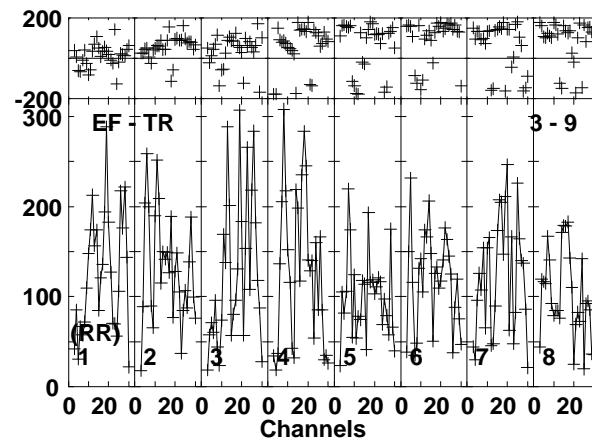
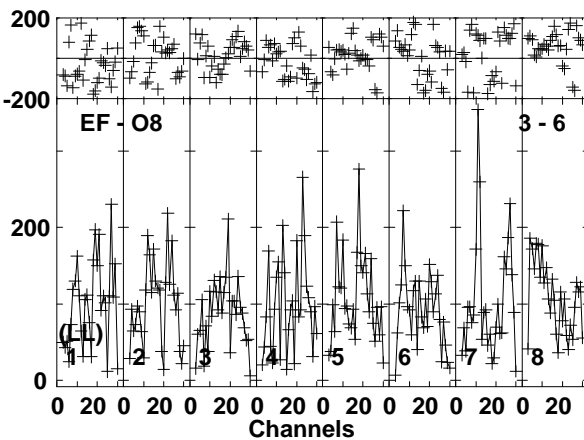
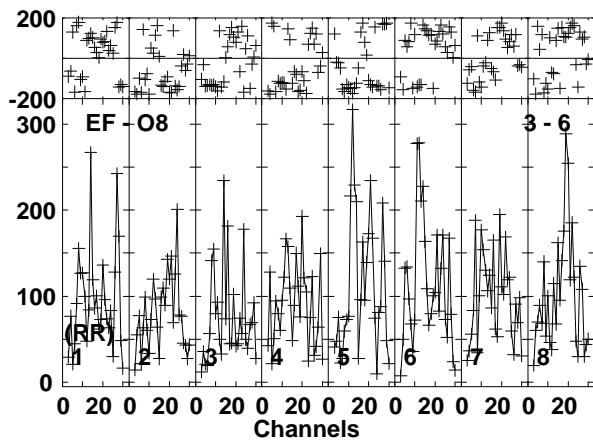
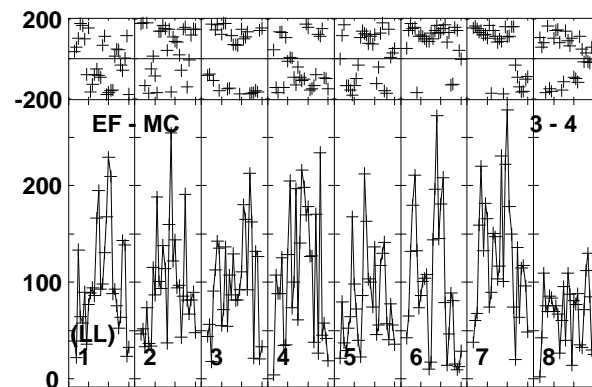
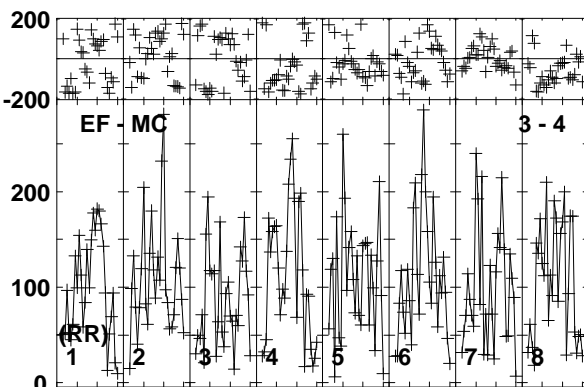
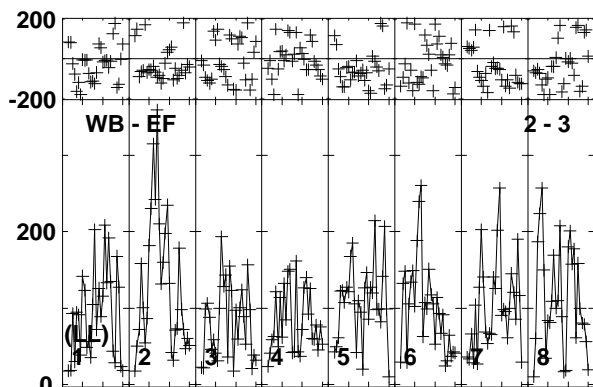
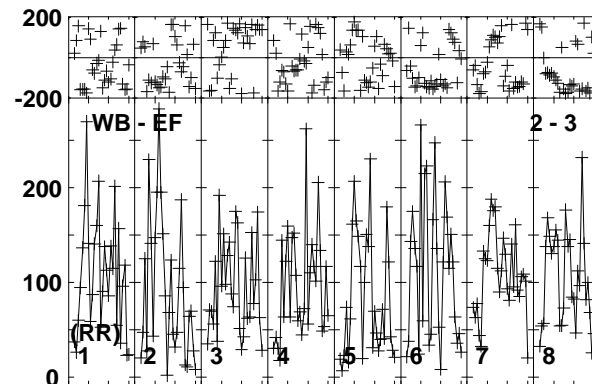
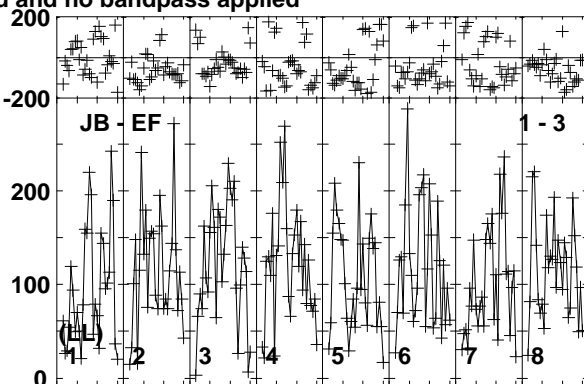
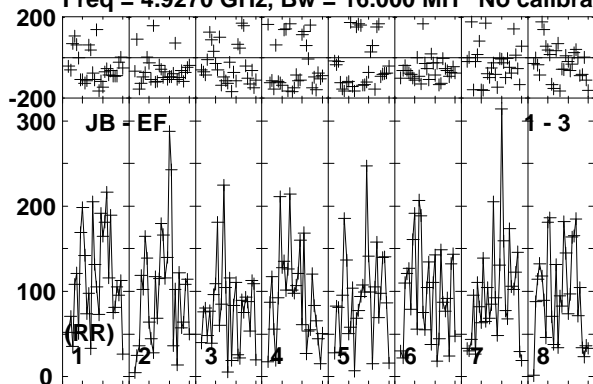

Lower frame: Micro Ampl Jy Top frame: Phas deg  
Vector averaged cross-power spectrum Baseline: JB (01) - EF (03)  
Timerange: 00/18:06:01 to 00/18:08:59

Plot file version 953 created 19-DEC-2018 17:59:14

AT2018\_RY007C.UVDATA.1

Freq = 4.9270 GHz, Bw = 16.000 MH No calibration applied and no bandpass applied

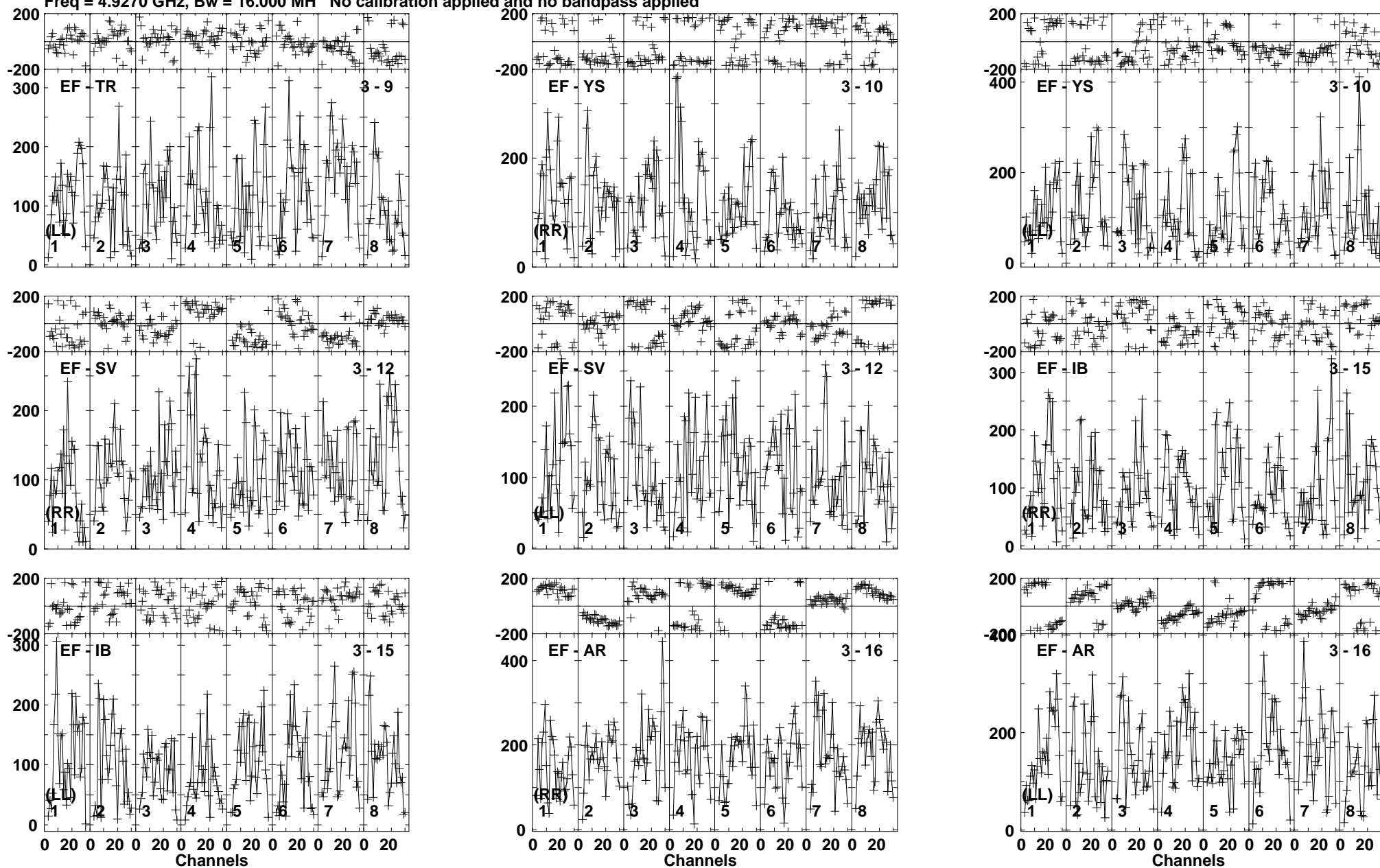

Lower frame: Micro Ampl Jy Top frame: Phas deg  
Vector averaged cross-power spectrum Baseline: EF (03) - TR (09)  
Timerange: 00/18:06:01 to 00/18:08:59

Plot file version 954 created 19-DEC-2018 17:59:14

J1619+2247 RY007C.UVDATA.1

Freq = 4.9270 GHz, Bw = 16.000 MH No calibration applied and no bandpass applied

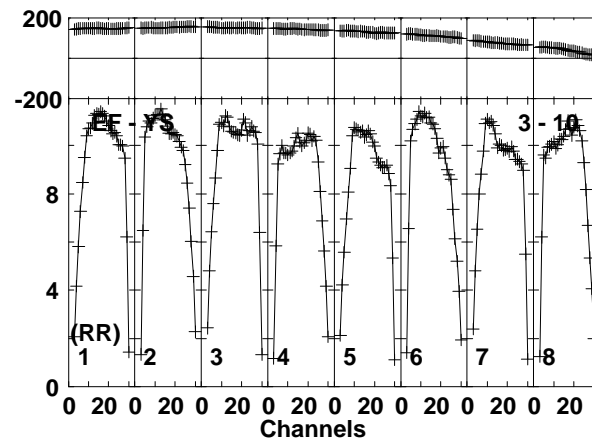
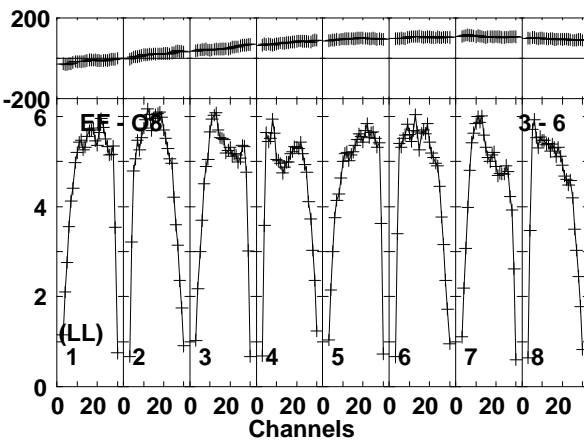
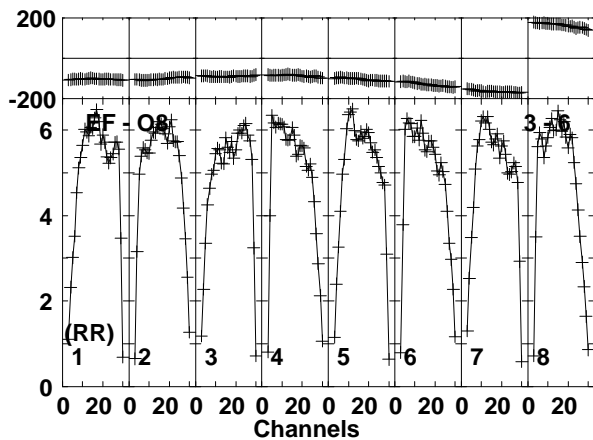
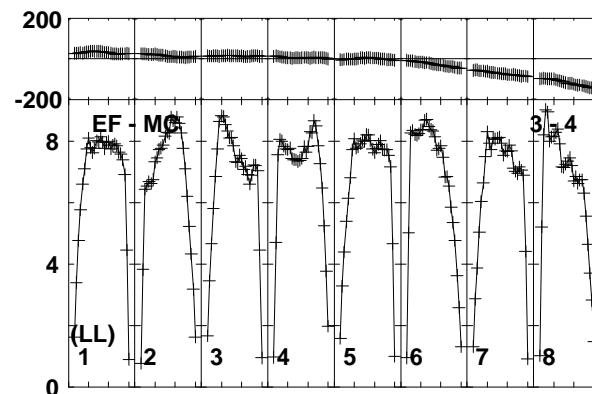
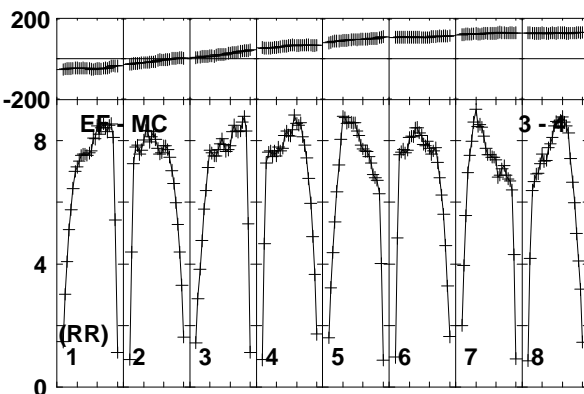
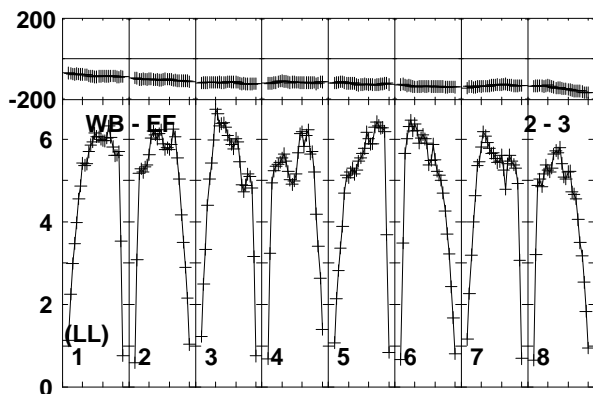
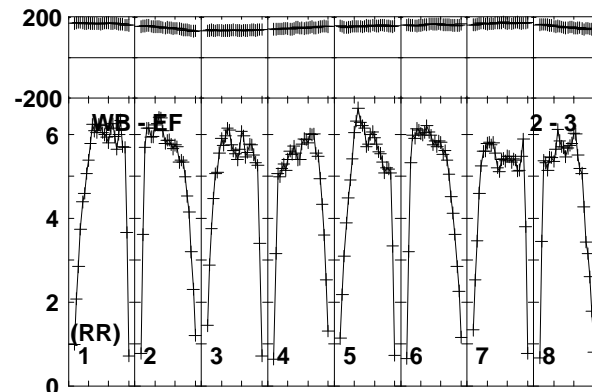
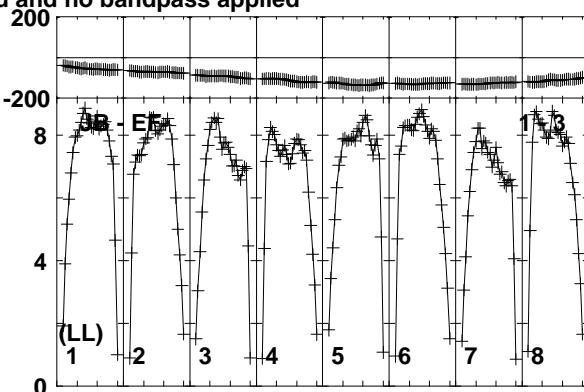
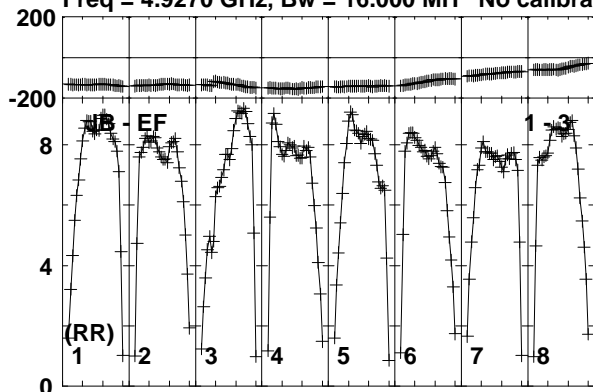

Lower frame: Milli Ampl Jy Top frame: Phas deg  
Vector averaged cross-power spectrum Baseline: JB (01) - EF (03)  
Timerange: 00/18:09:01 to 00/18:09:59



Plot file version 955 created 19-DEC-2018 17:59:14

J1619+2247 RY007C.UVDATA.1

Freq = 4.9270 GHz, Bw = 16.000 MH No calibration applied and no bandpass applied

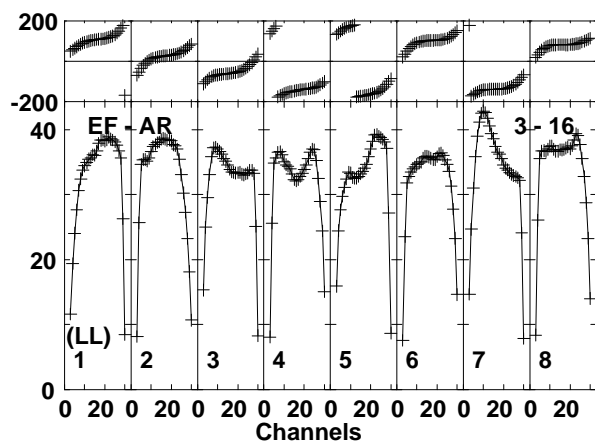
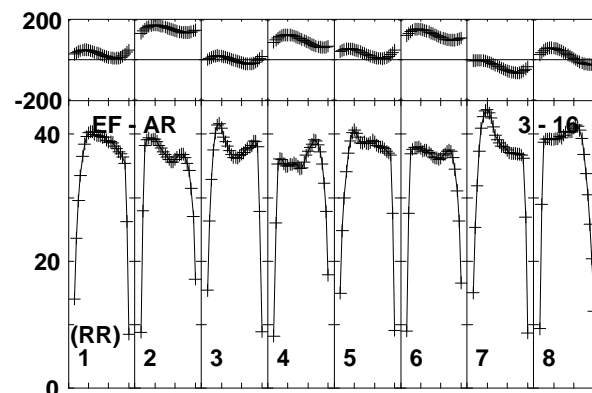
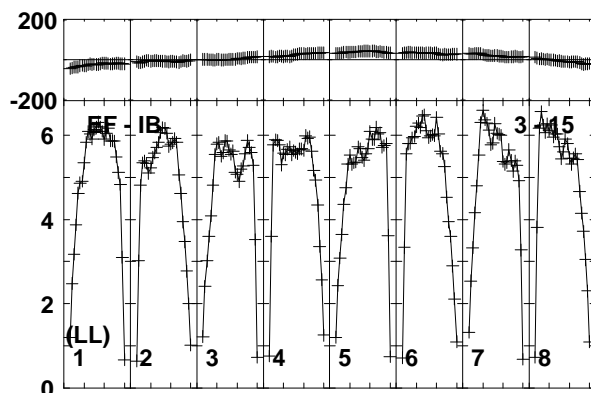
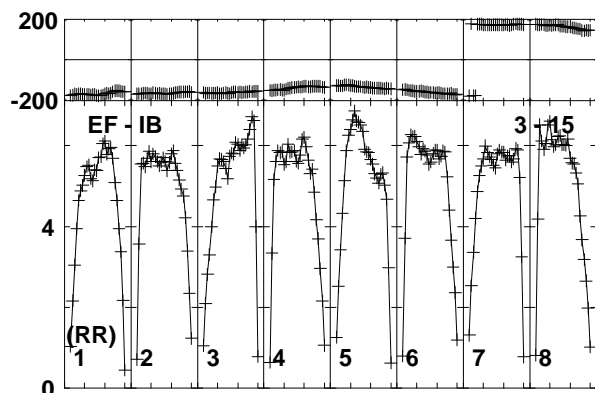
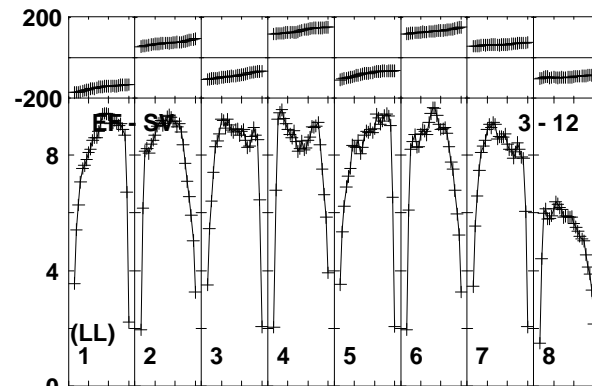
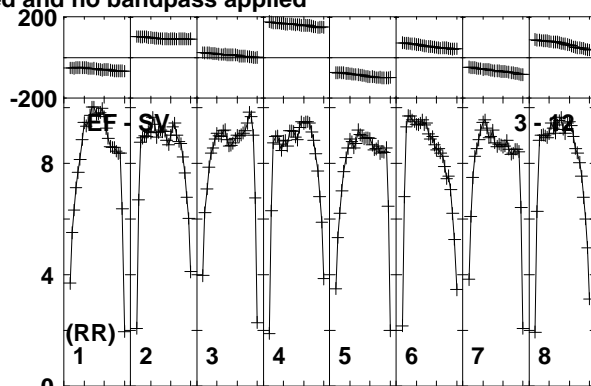
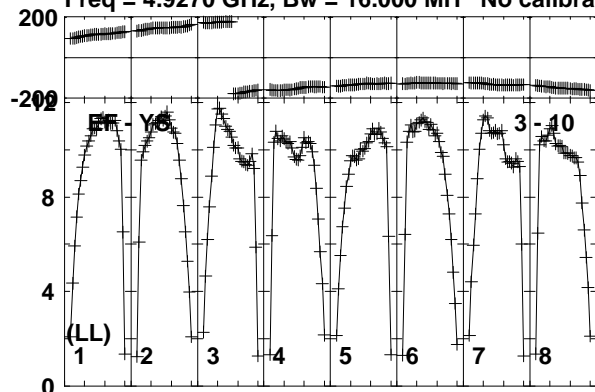

Lower frame: Milli Ampl Jy Top frame: Phas deg  
Vector averaged cross-power spectrum Baseline: EF (03) - YS (10)  
Timerange: 00/18:09:01 to 00/18:09:59

Plot file version 956 created 19-DEC-2018 17:59:14

AT2018\_RY007C.UVDATA.1

Freq = 4.9270 GHz, Bw = 16.000 MH No calibration applied and no bandpass applied

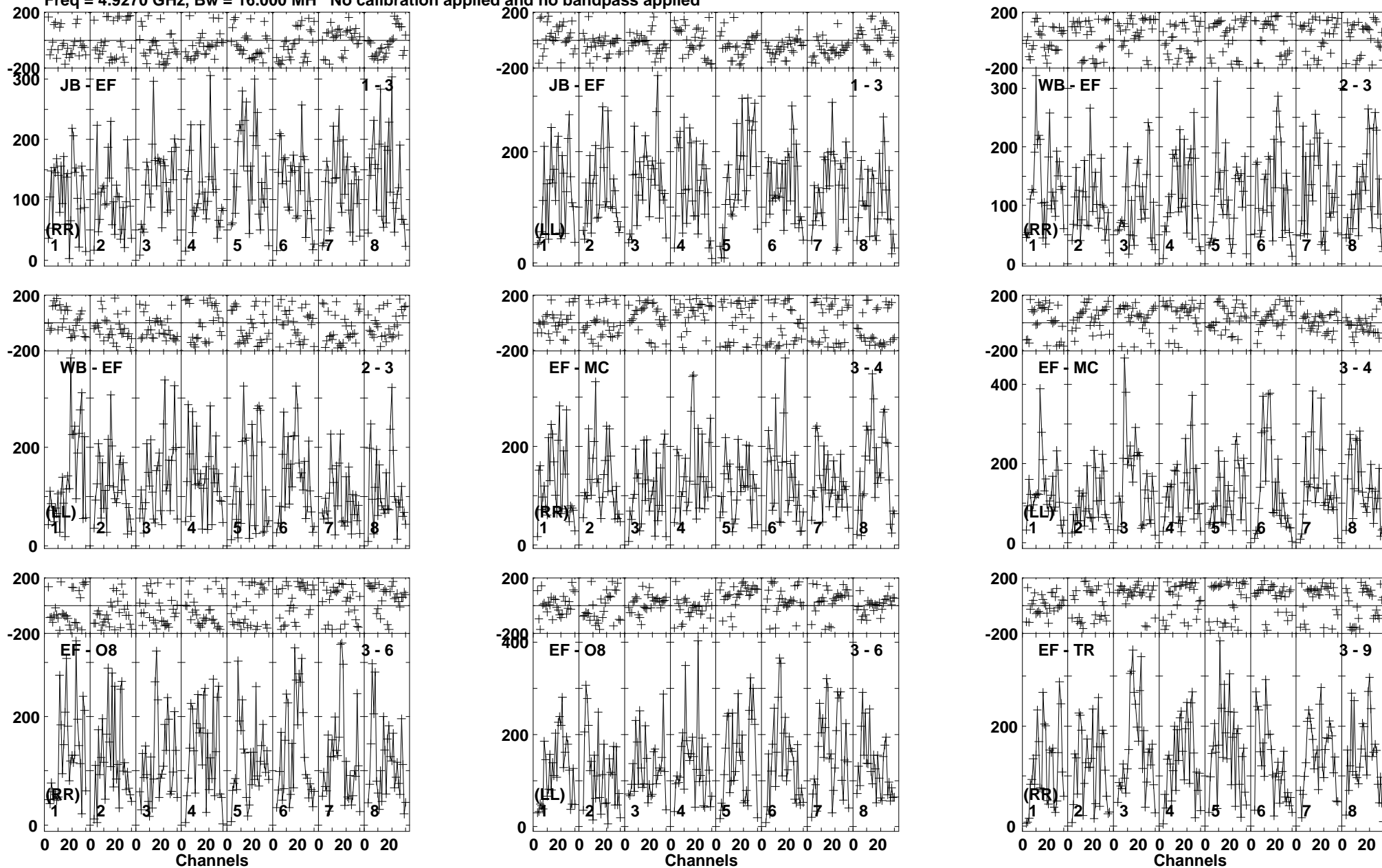

Lower frame: Micro Ampl Jy Top frame: Phas deg  
Vector averaged cross-power spectrum Baseline: JB (01) - EF (03)  
Timerange: 00:18:10:01 to 00:18:11:59

Plot file version 957 created 19-DEC-2018 17:59:14  
AT2018\_RY007C.UVDATA.1

Freq = 4.9270 GHz, Bw = 16.000 MH No calibration applied and no bandpass applied

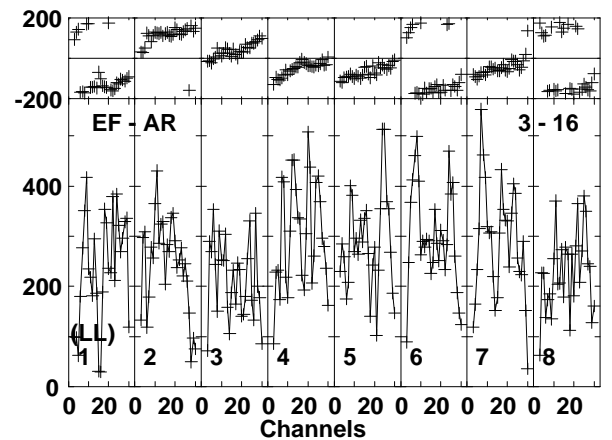
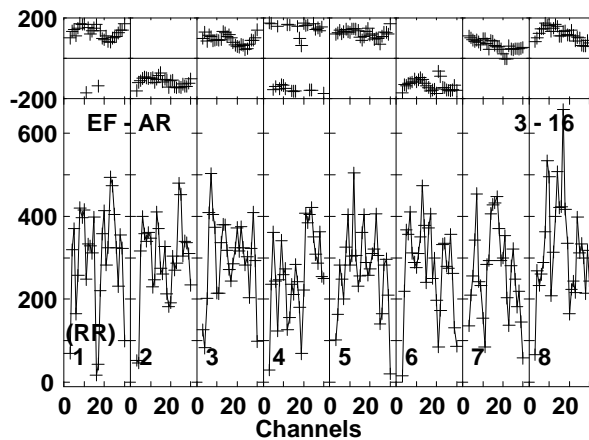
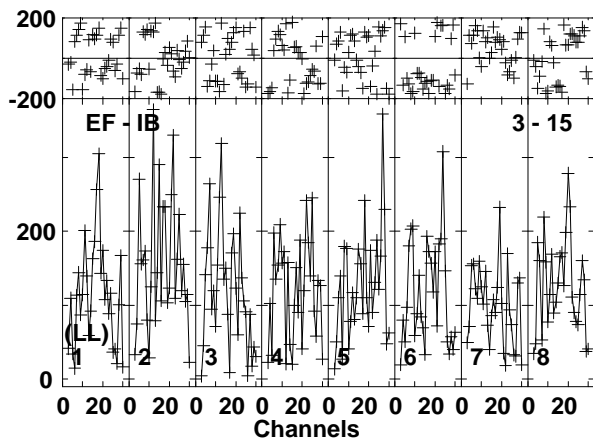
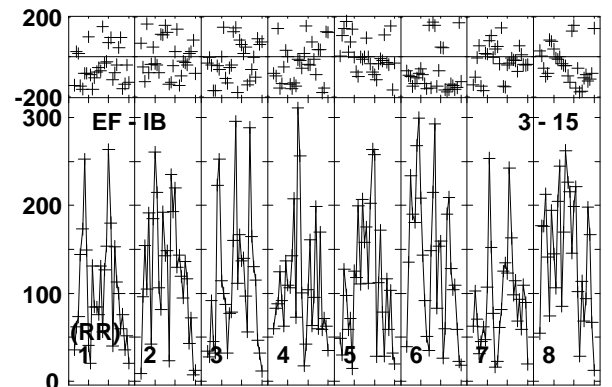
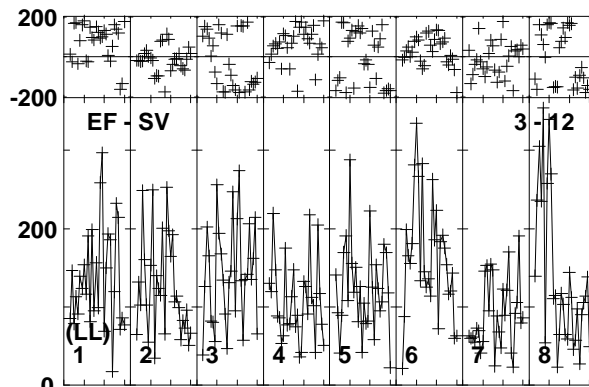
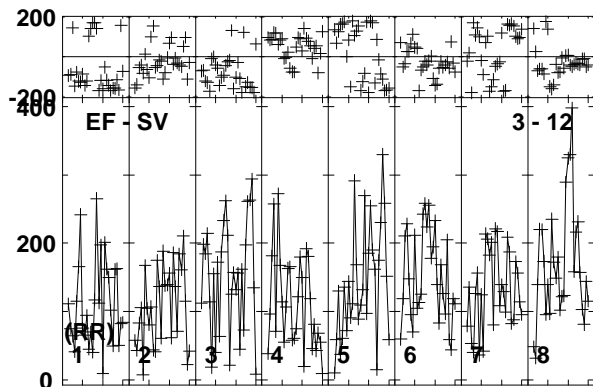
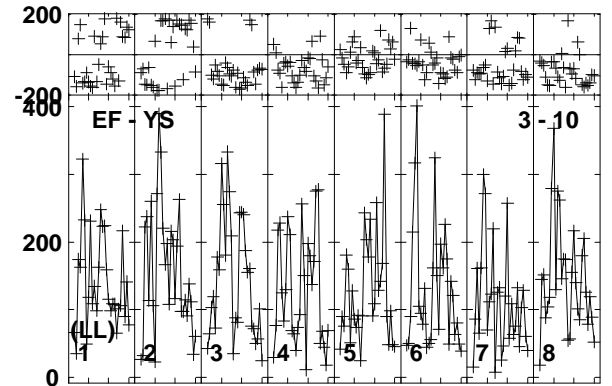
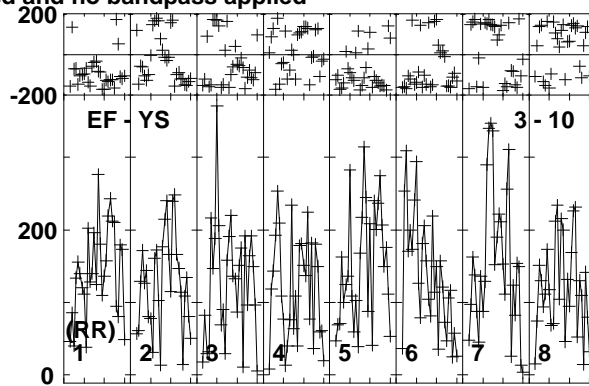
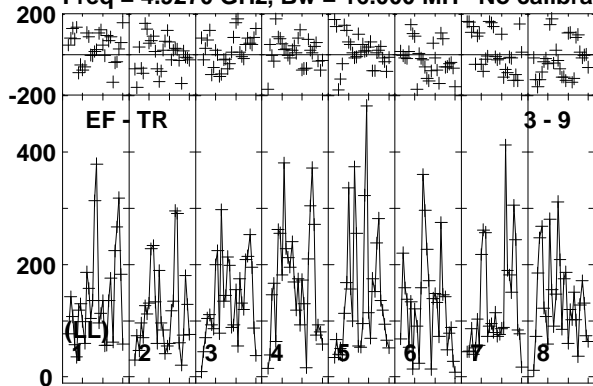

Lower frame: Micro Ampl Jy Top frame: Phas deg  
Vector averaged cross-power spectrum Baseline: EF (03) - TR (09)  
Timerange: 00/18:10:01 to 00/18:11:59

Plot file version 958 created 19-DEC-2018 17:59:14

VLA2 RY007C.UVDATA.1

Freq = 4.9270 GHz, Bw = 16.000 MH No calibration applied and no bandpass applied

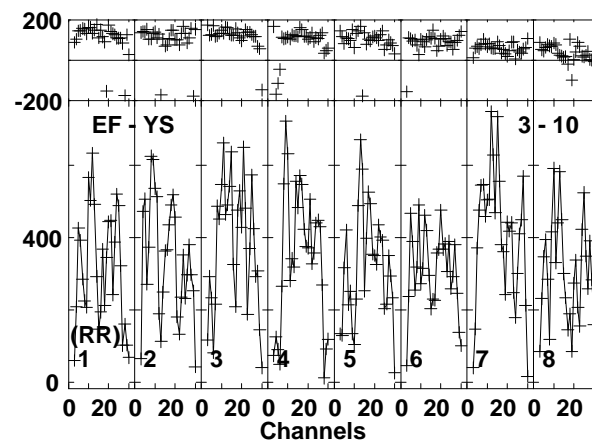
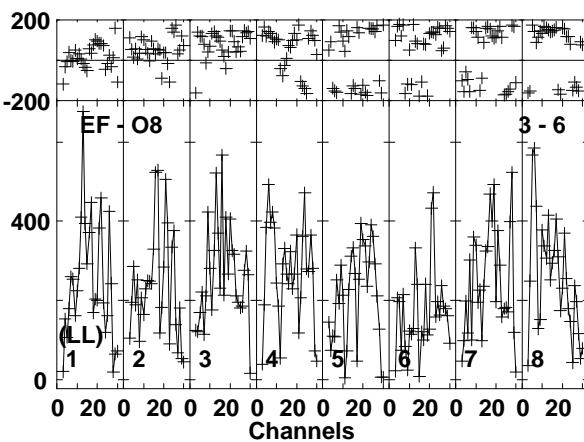
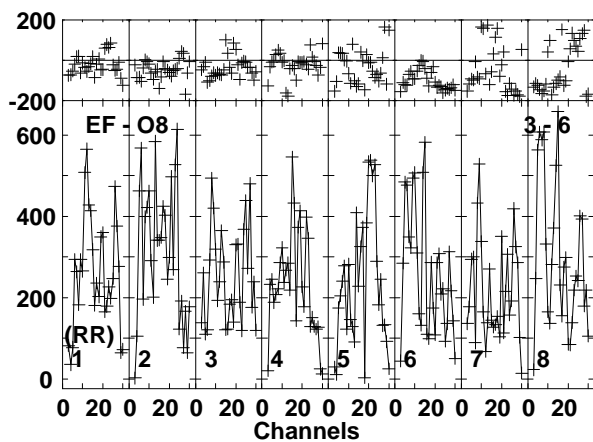
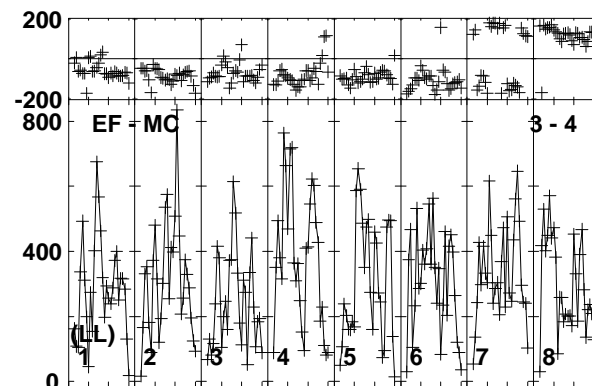
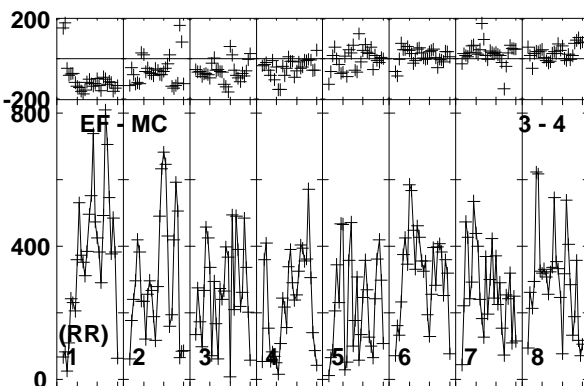
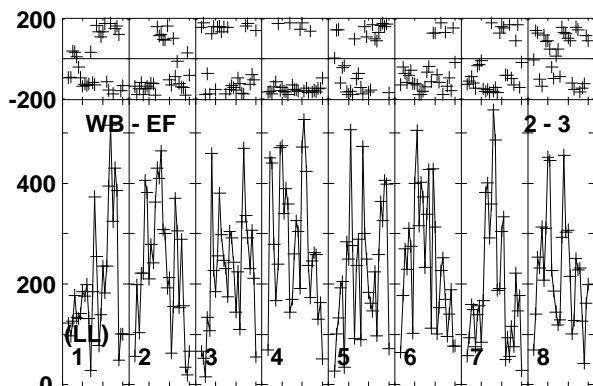
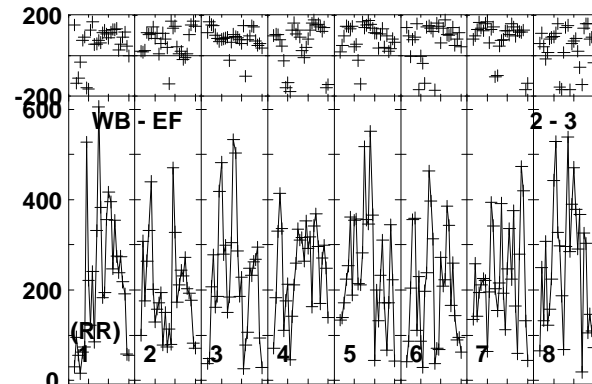
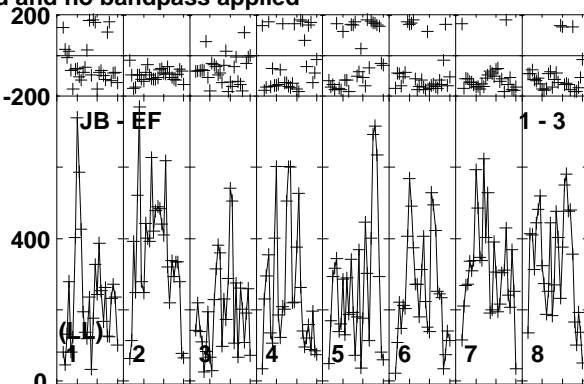
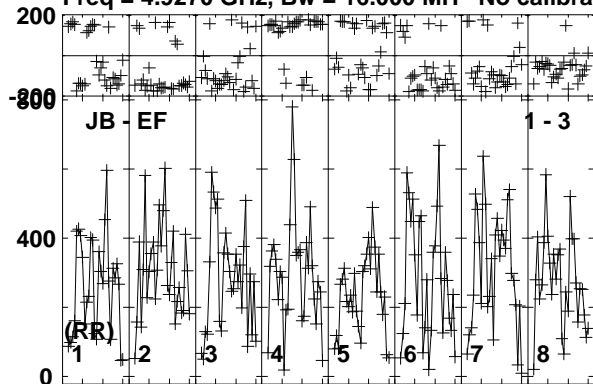

Lower frame: Micro Ampl Jy Top frame: Phas deg  
Vector averaged cross-power spectrum Baseline: JB (01) - EF (03)  
Timerange: 00/18:12:01 to 00/18:12:59

Plot file version 959 created 19-DEC-2018 17:59:14

VLA2 RY007C.UVDATA.1

Freq = 4.9270 GHz, Bw = 16.000 MH No calibration applied and no bandpass applied

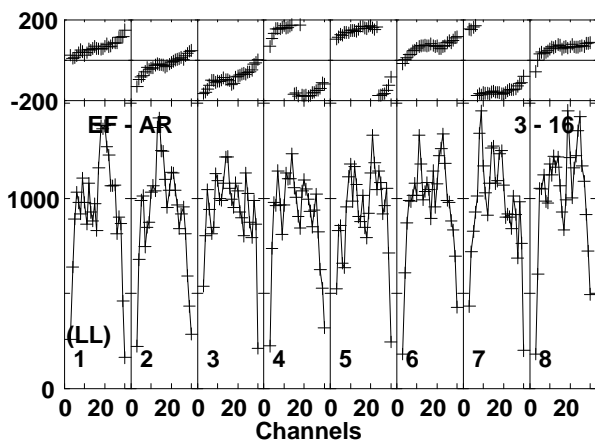
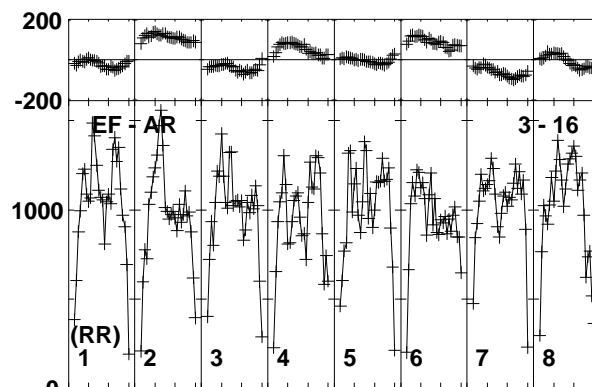
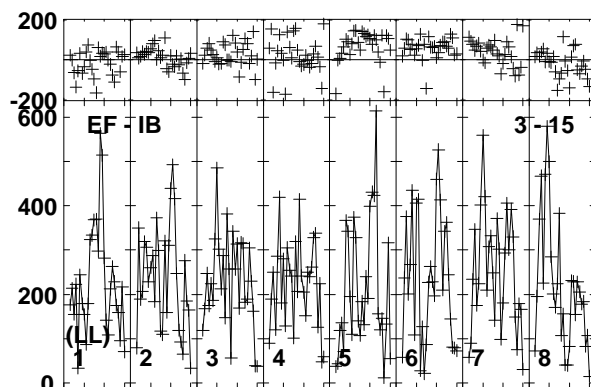
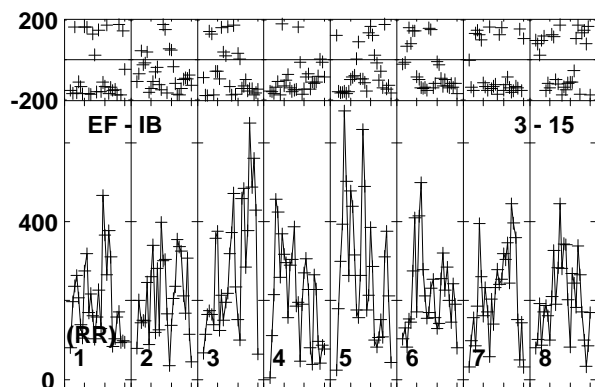
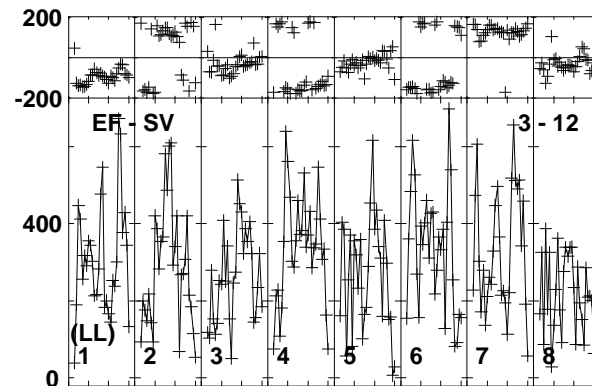
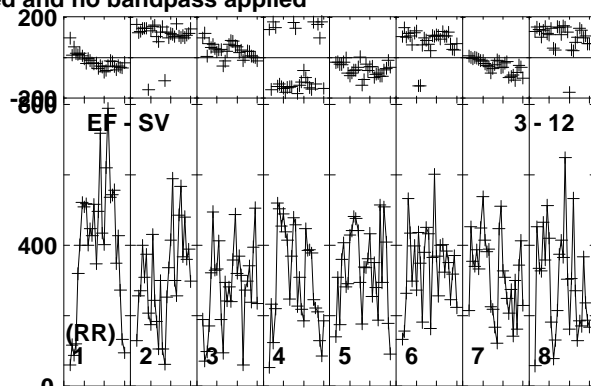
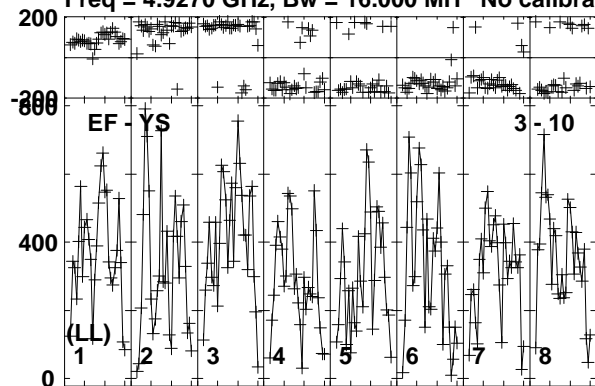

Lower frame: Micro Ampl Jy Top frame: Phas deg  
Vector averaged cross-power spectrum Baseline: EF (03) - YS (10)  
Timerange: 00/18:12:01 to 00/18:12:59

Plot file version 960 created 19-DEC-2018 17:59:14

J1619+2247 RY007C.UVDATA.1

Freq = 4.9270 GHz, Bw = 16.000 MH No calibration applied and no bandpass applied

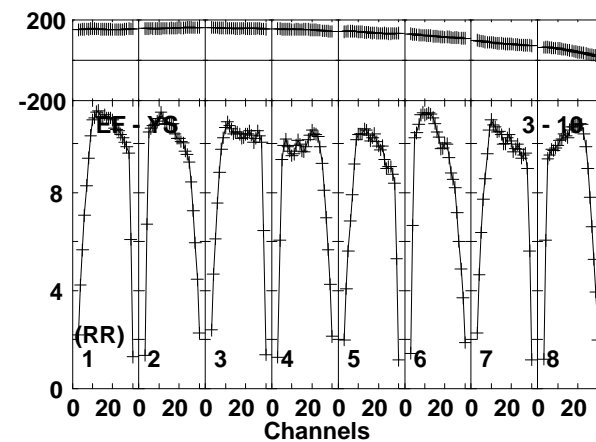
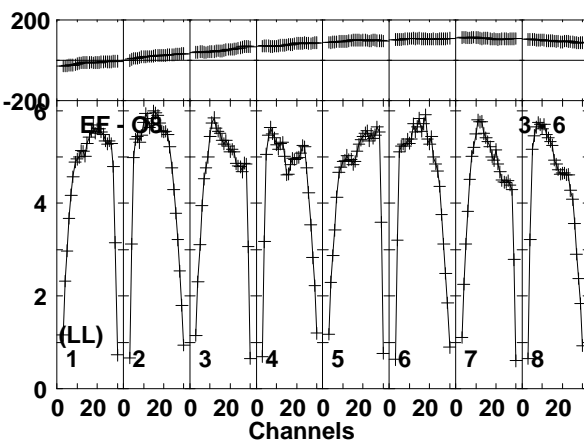
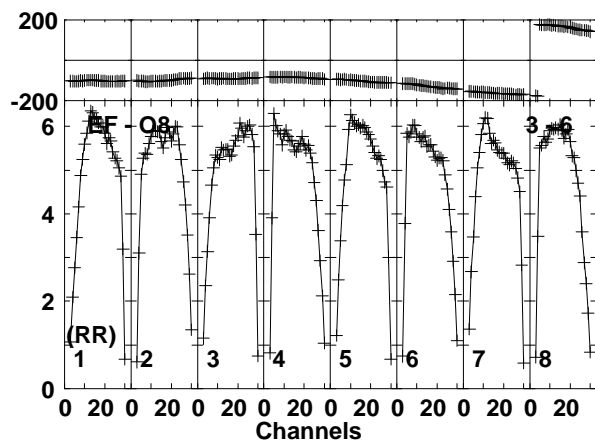
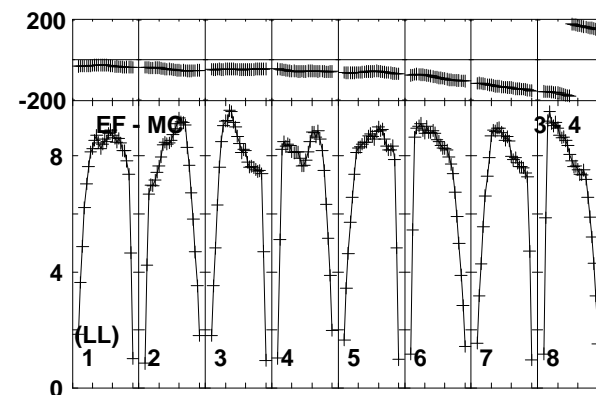
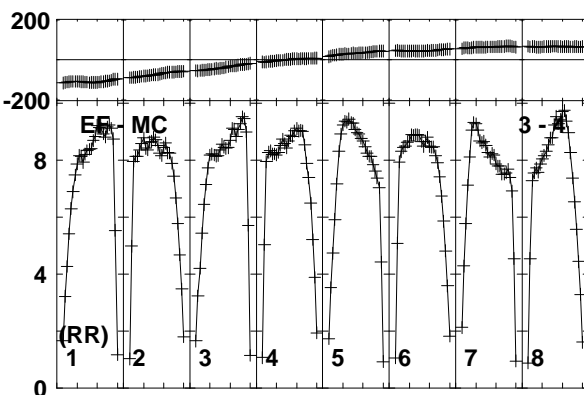
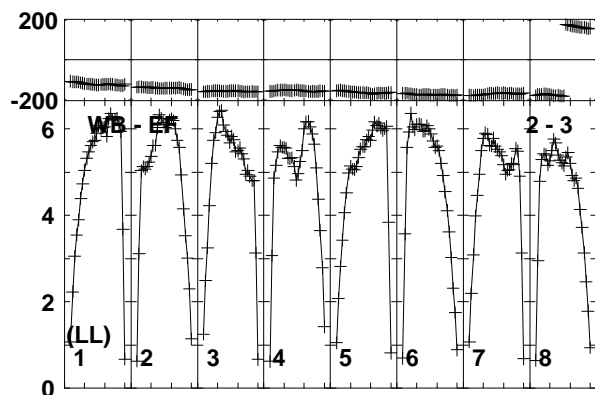
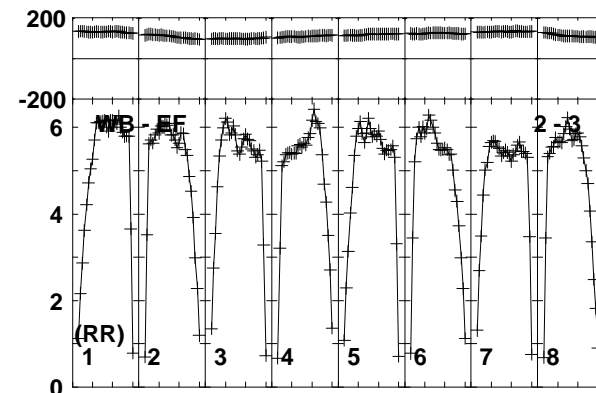
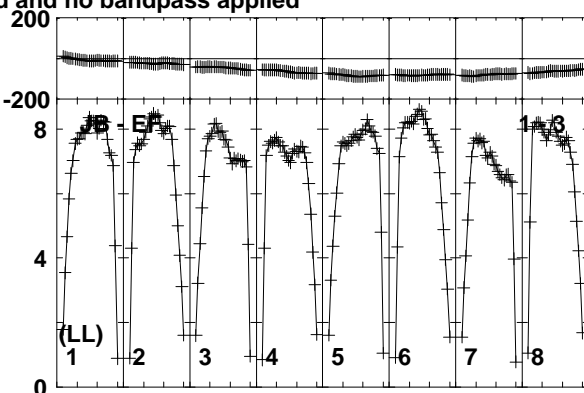
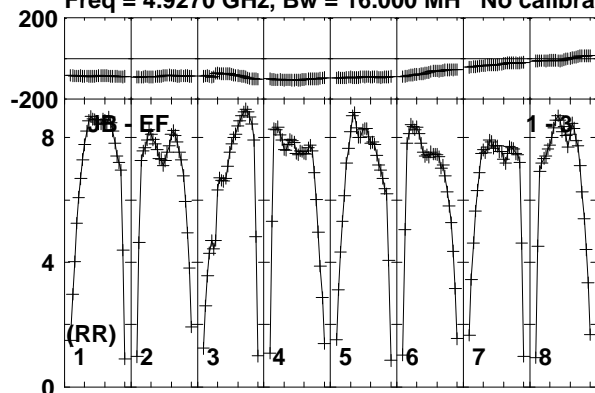

Lower frame: Milli Ampl Jy Top frame: Phas deg  
Vector averaged cross-power spectrum Baseline: JB (01) - EF (03)  
Timerange: 00/18:13:31 to 00/18:14:29

Plot file version 961 created 19-DEC-2018 17:59:14

J1619+2247 RY007C.UVDATA.1

Freq = 4.9270 GHz, Bw = 16.000 MH No calibration applied and no bandpass applied

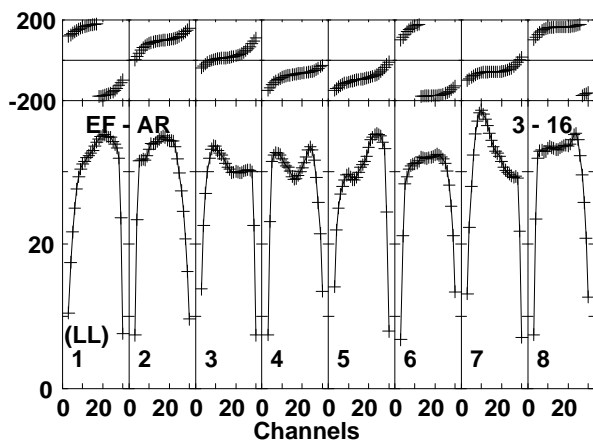
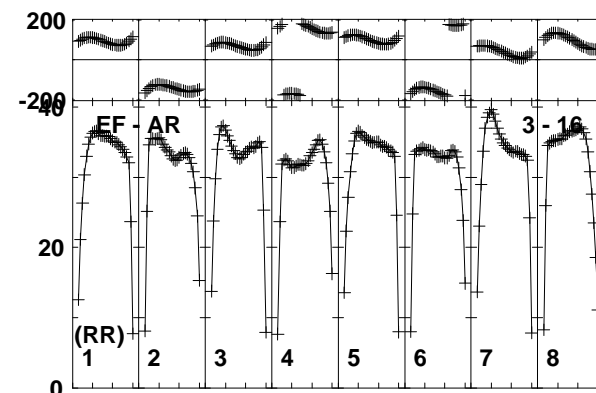
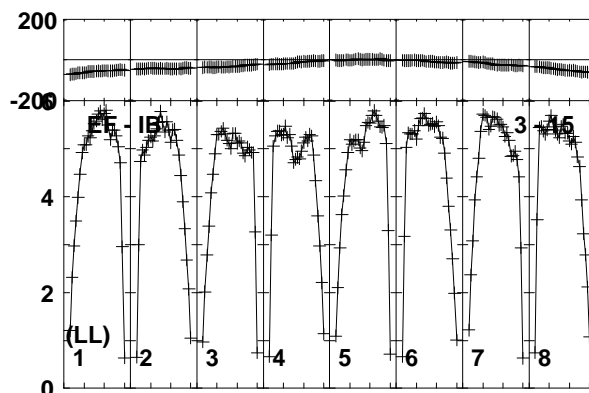
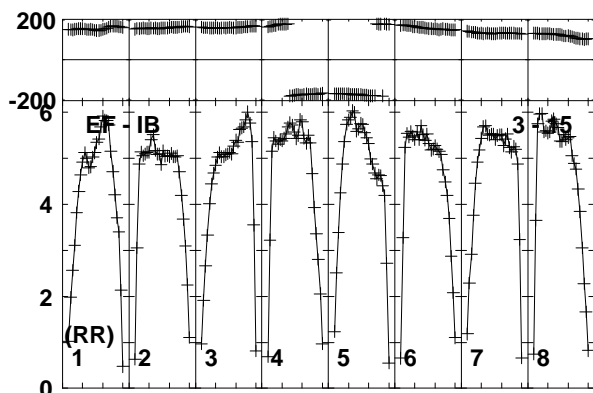
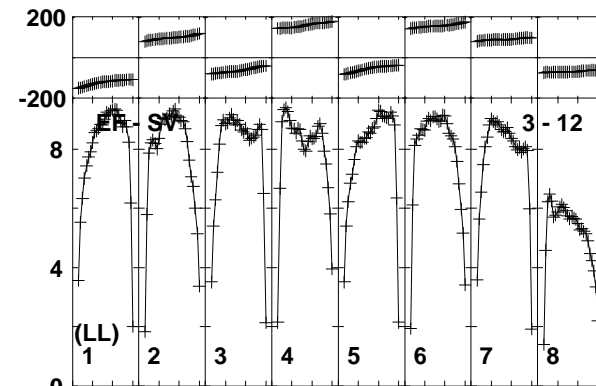
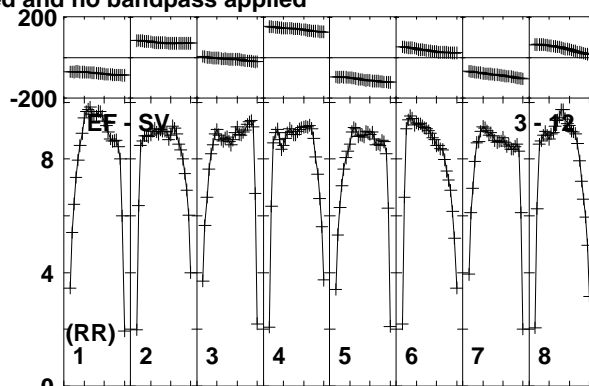
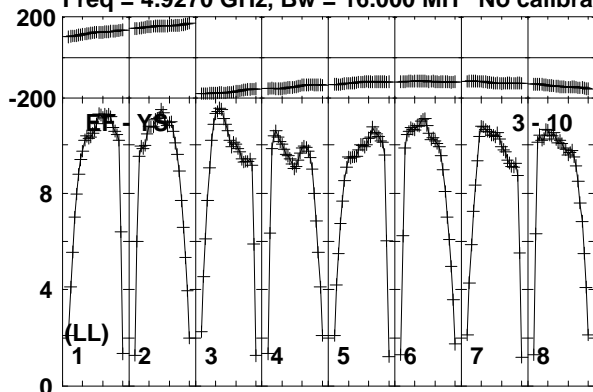

Lower frame: Milli Ampl Jy Top frame: Phas deg  
Vector averaged cross-power spectrum Baseline: EF (03) - YS (10)  
Timerange: 00/18:13:31 to 00/18:14:29

Plot file version 962 created 19-DEC-2018 17:59:14

AT2018\_RY007C.UVDATA.1

Freq = 4.9270 GHz, Bw = 16.000 MH No calibration applied and no bandpass applied

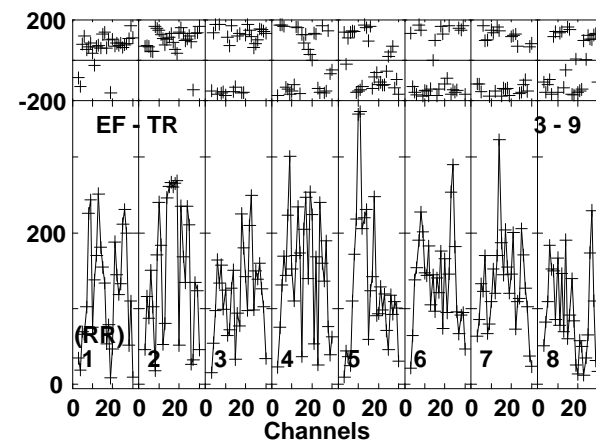
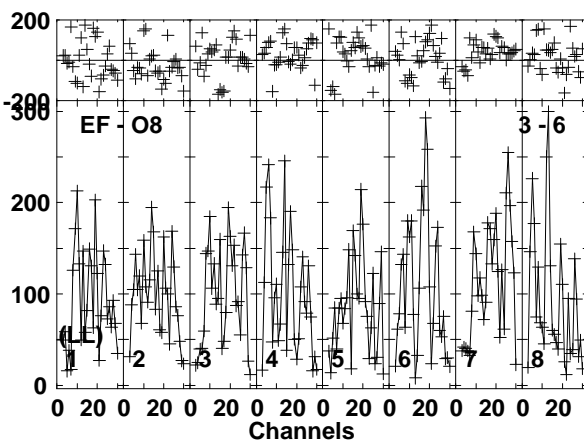
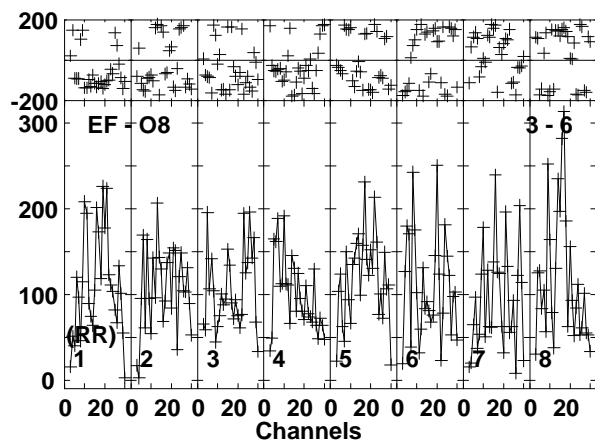
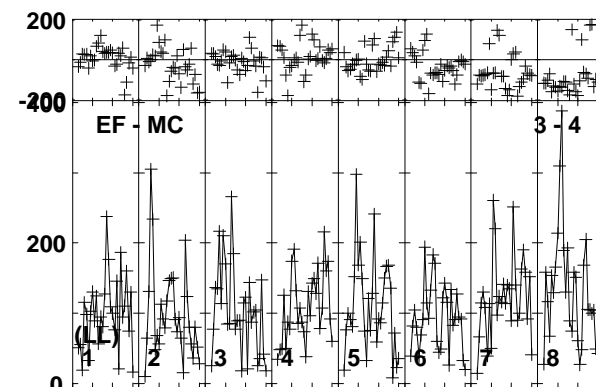
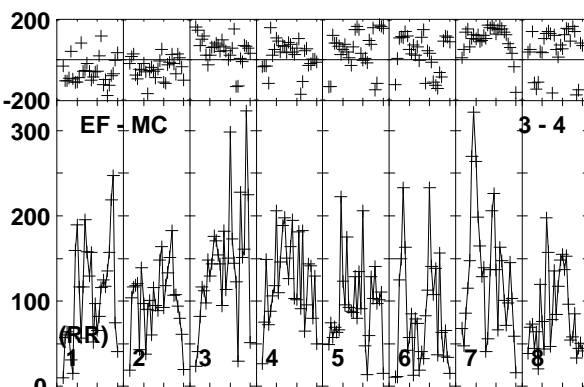
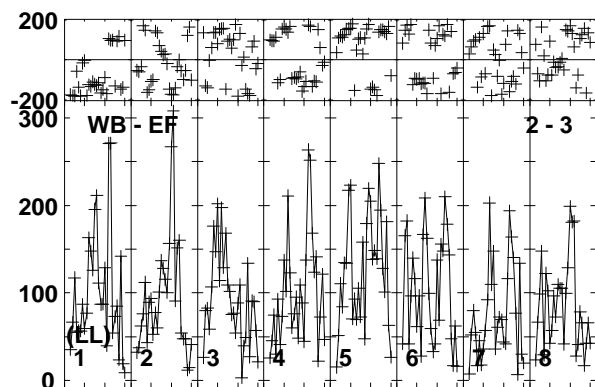
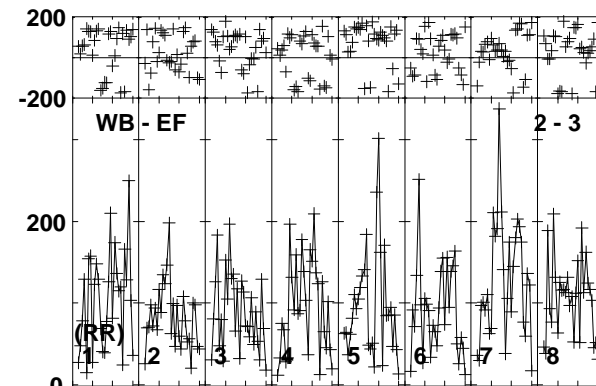
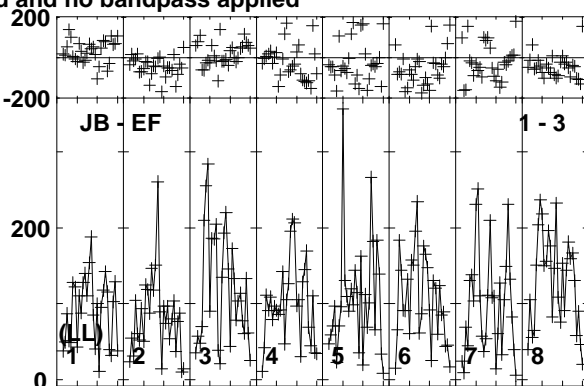
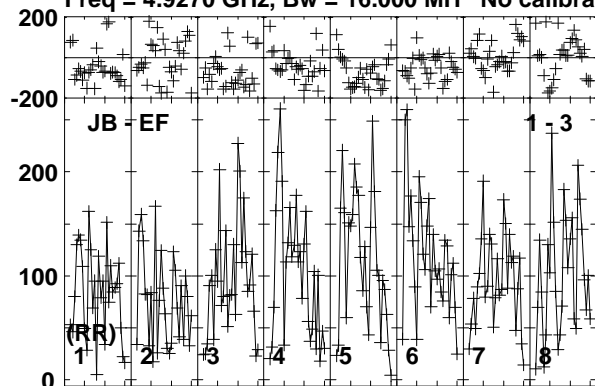

Lower frame: Micro Ampl Jy Top frame: Phas deg  
Vector averaged cross-power spectrum Baseline: JB (01) - EF (03)  
Timerange: 00/18:14:31 to 00/18:17:29



Plot file version 963 created 19-DEC-2018 17:59:14

AT2018\_RY007C.UVDATA.1

Freq = 4.9270 GHz, Bw = 16.000 MH No calibration applied and no bandpass applied

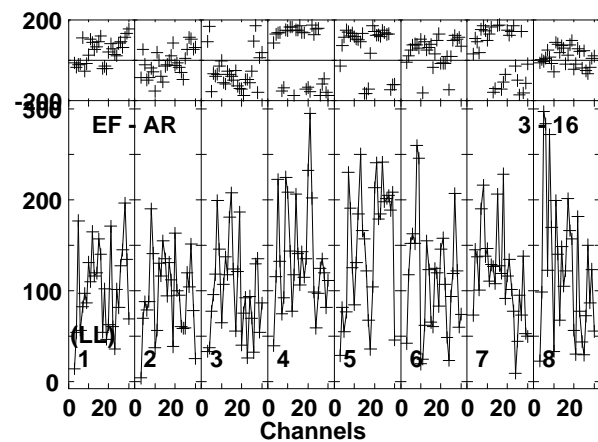
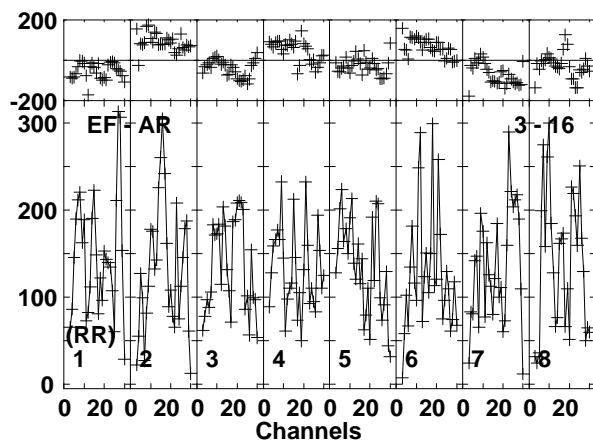
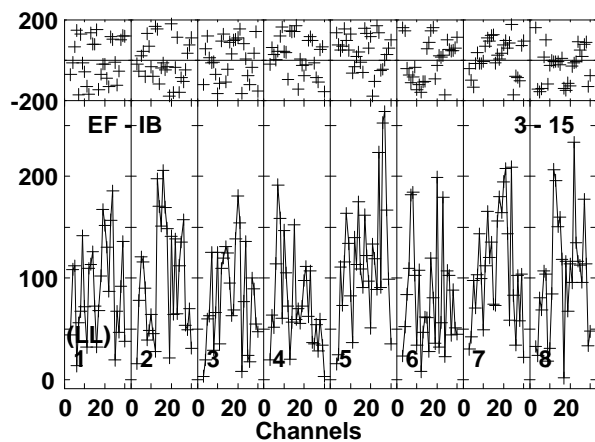
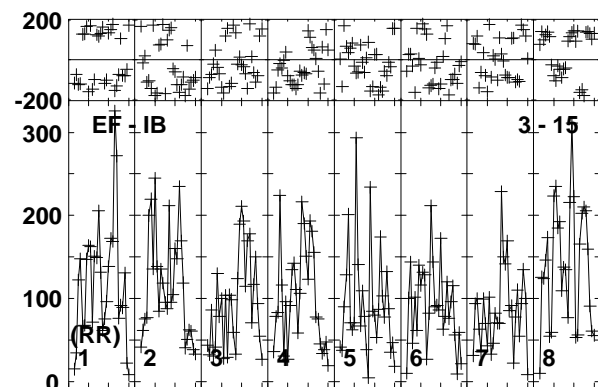
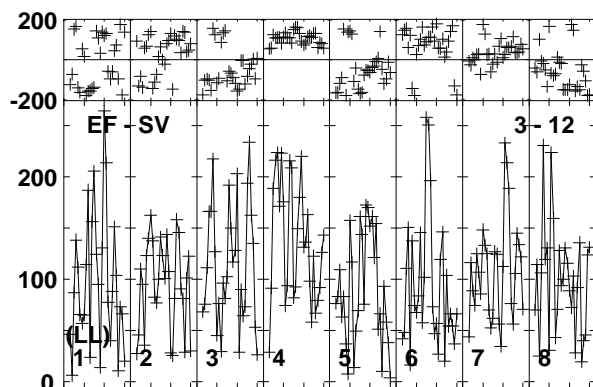
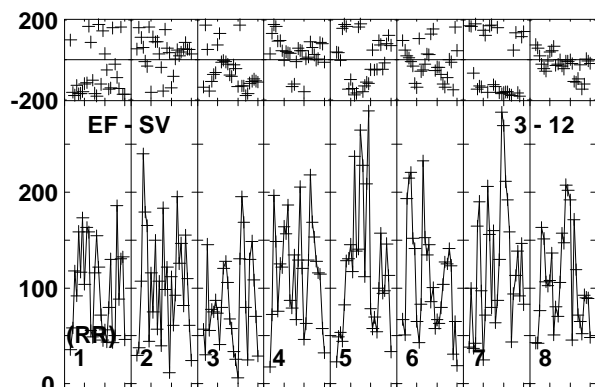
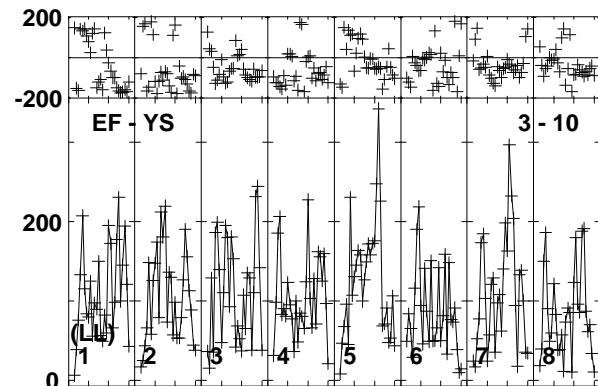
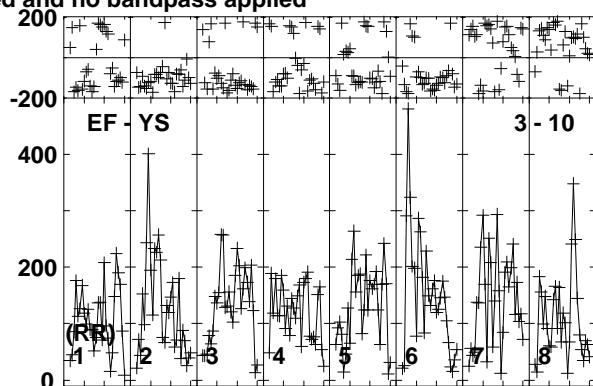
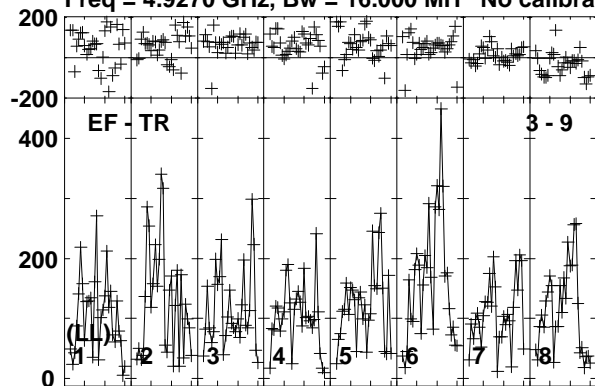

Lower frame: Micro Ampl Jy Top frame: Phas deg  
Vector averaged cross-power spectrum Baseline: EF (03) - TR (09)  
Timerange: 00/18:14:31 to 00/18:17:29

Plot file version 964 created 19-DEC-2018 17:59:14

J1619+2247 RY007C.UVDATA.1

Freq = 4.9270 GHz, Bw = 16.000 MH No calibration applied and no bandpass applied

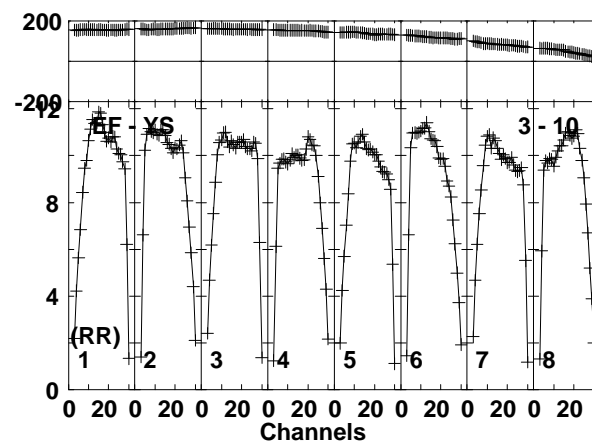
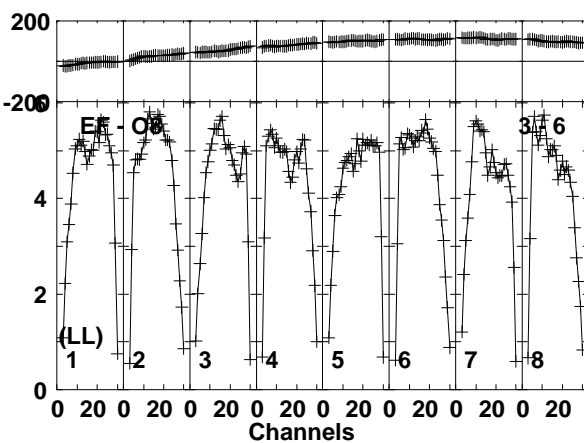
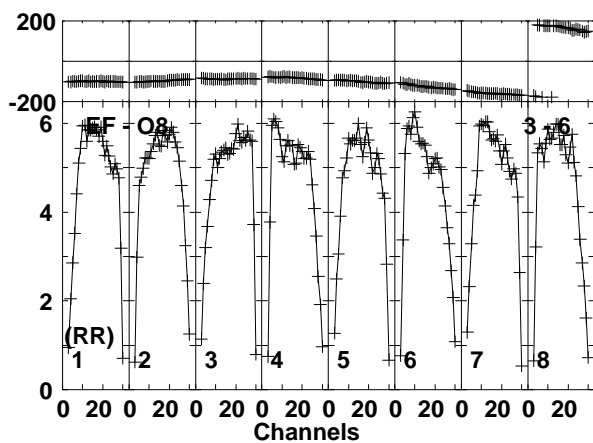
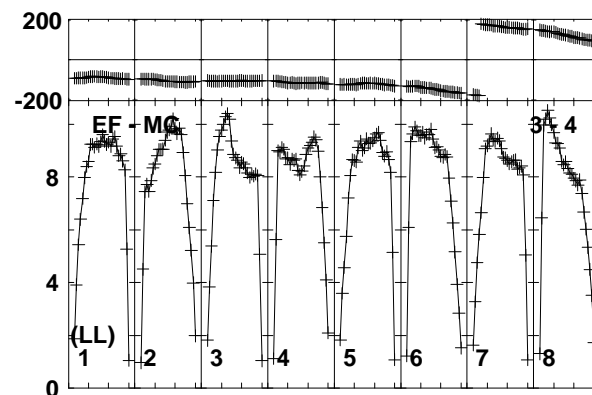
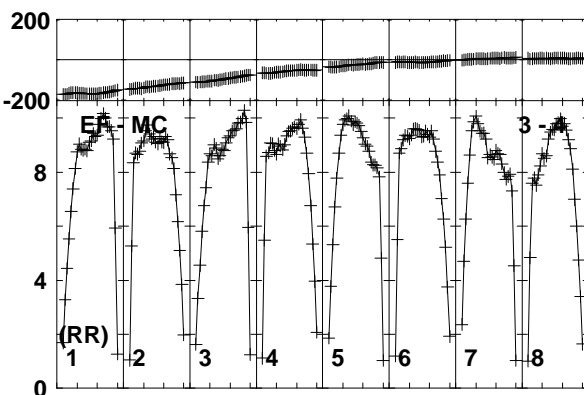
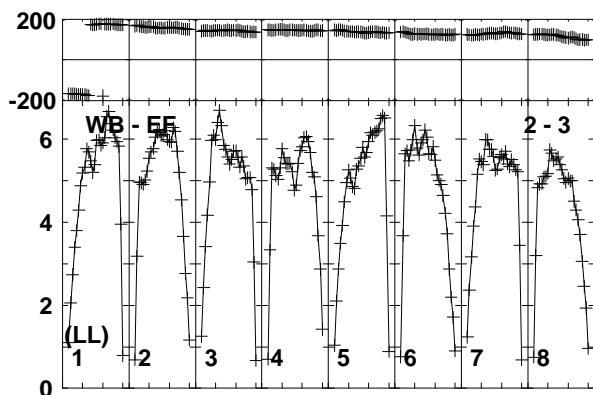
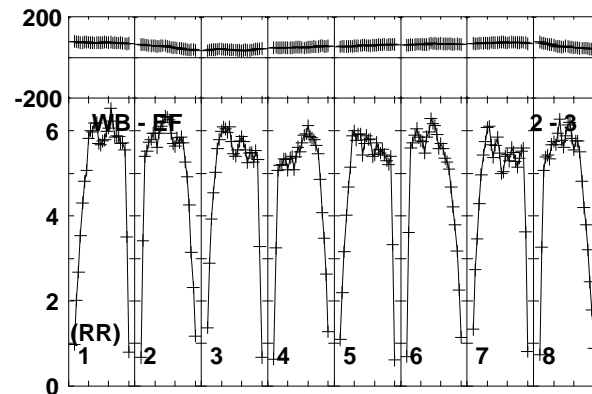
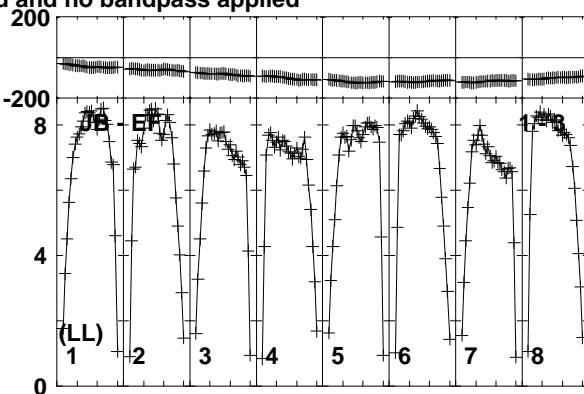
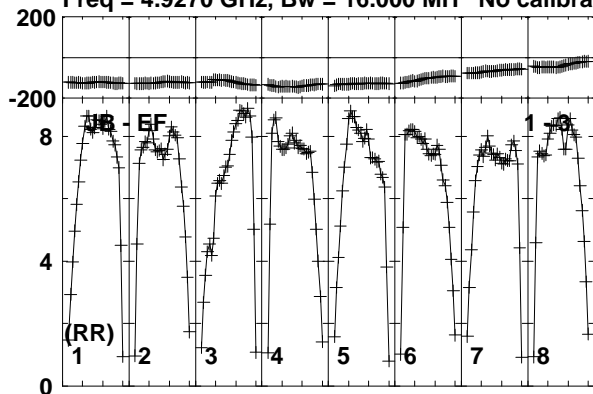

Lower frame: Milli Ampl Jy Top frame: Phas deg  
Vector averaged cross-power spectrum Baseline: JB (01) - EF (03)  
Timerange: 00/18:17:31 to 00/18:18:29

Plot file version 965 created 19-DEC-2018 17:59:14

J1619+2247 RY007C.UVDATA.1

Freq = 4.9270 GHz, Bw = 16.000 MH No calibration applied and no bandpass applied

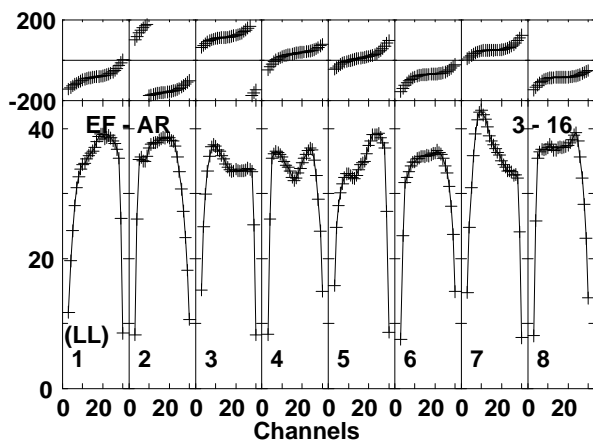
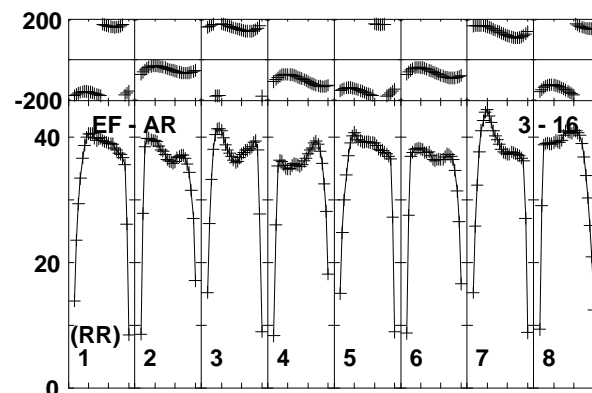
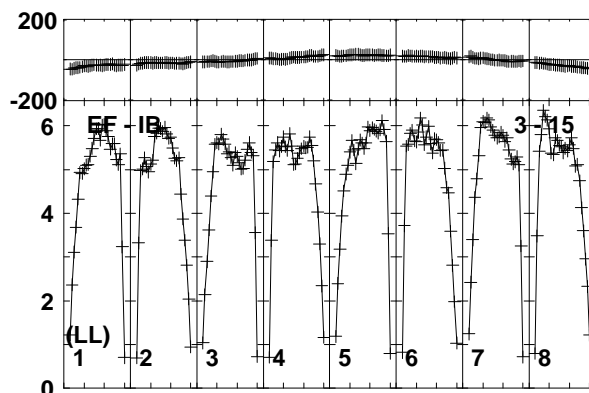
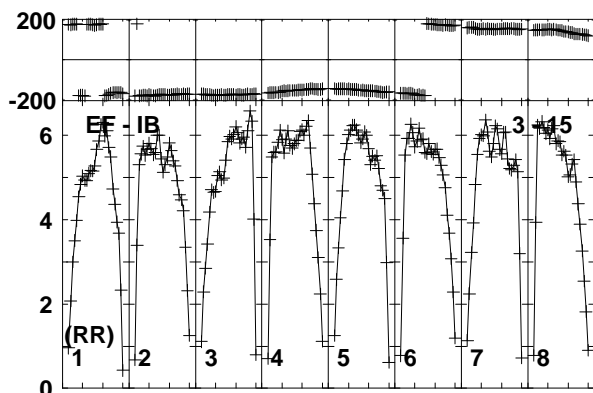
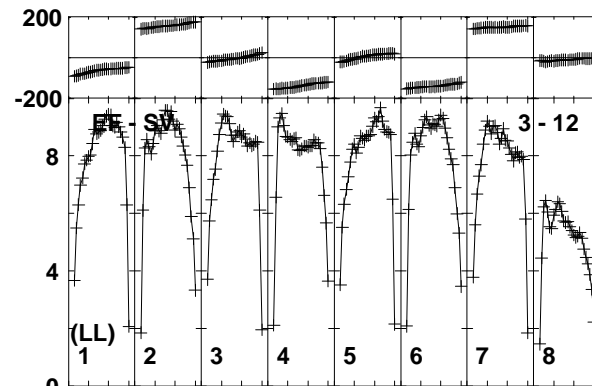
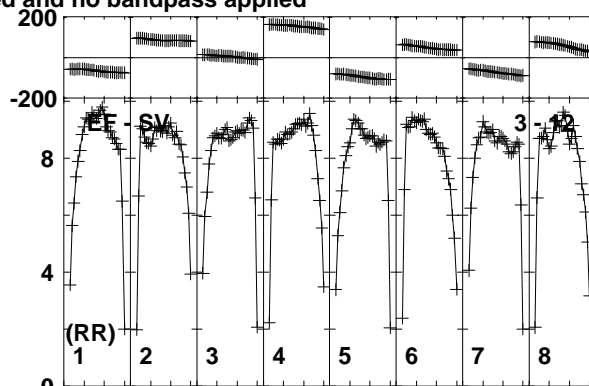
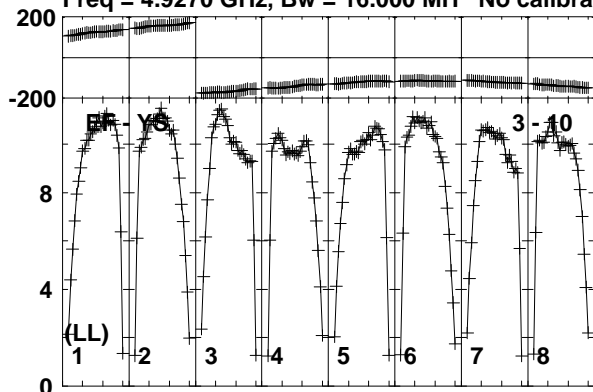

Lower frame: Milli Ampl Jy Top frame: Phas deg  
Vector averaged cross-power spectrum Baseline: EF (03) - YS (10)  
Timerange: 00/18:17:31 to 00/18:18:29

Plot file version 966 created 19-DEC-2018 17:59:14

AT2018\_RY007C.UVDATA.1

Freq = 4.9270 GHz, Bw = 16.000 MH No calibration applied and no bandpass applied

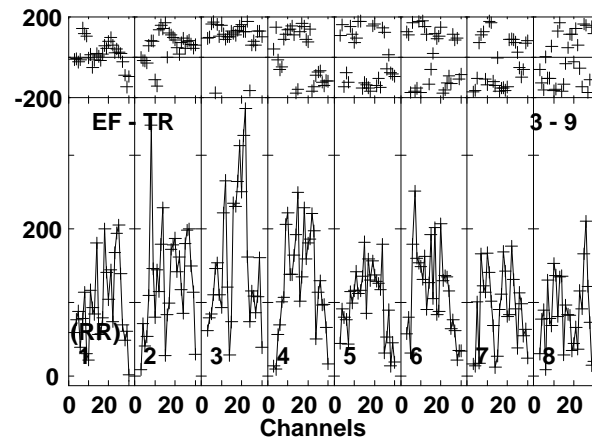
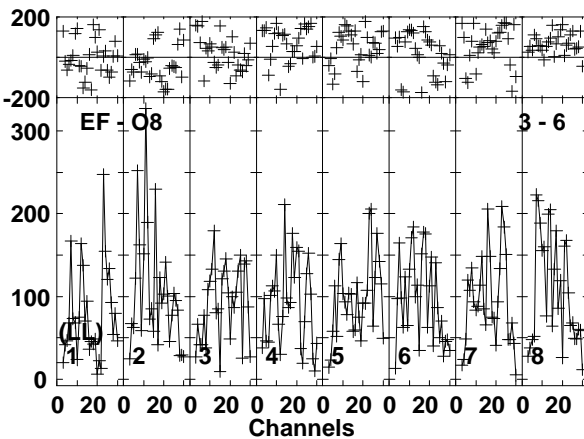
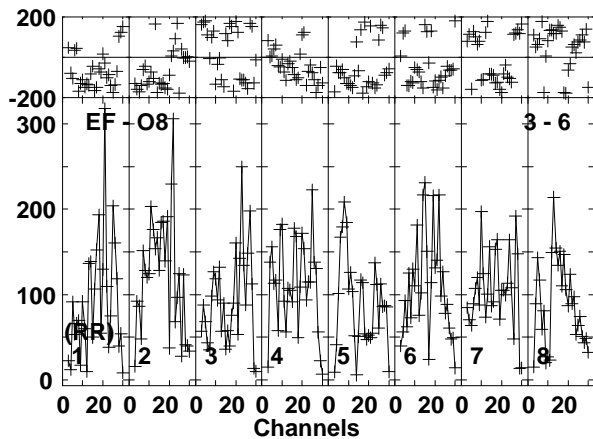
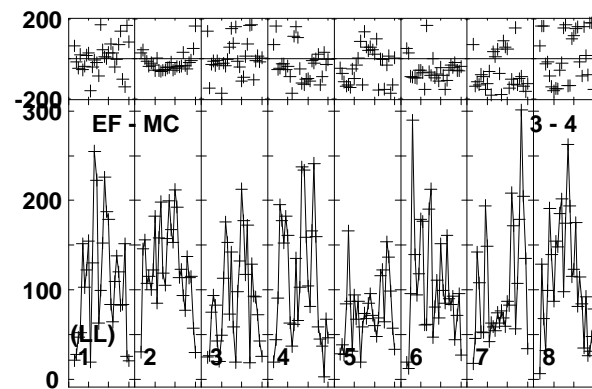
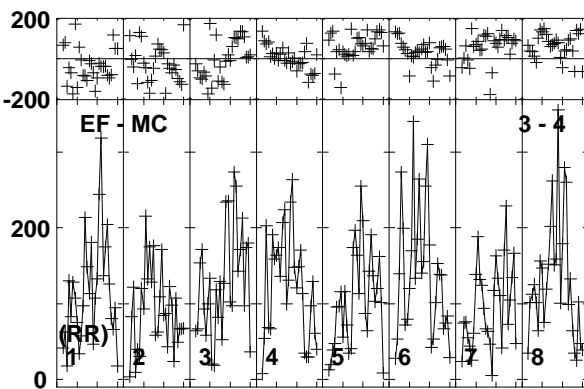
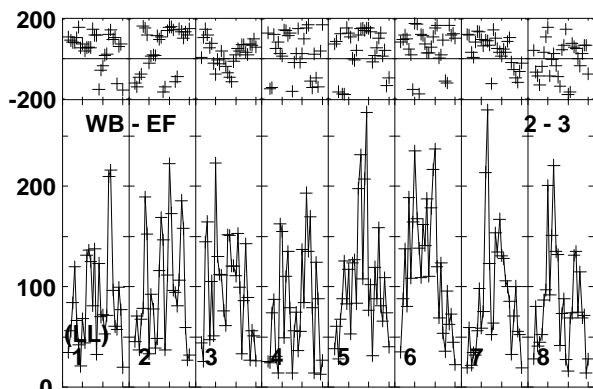
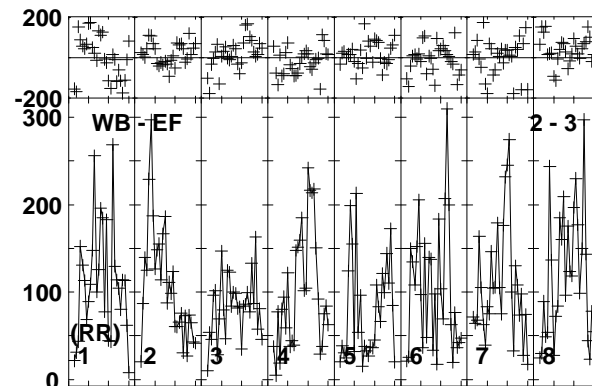
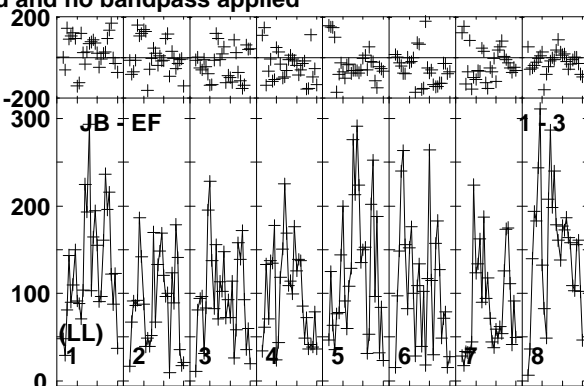
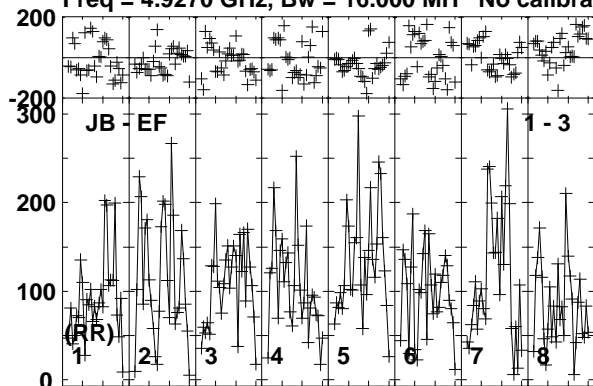

Lower frame: Micro Ampl Jy Top frame: Phas deg  
Vector averaged cross-power spectrum Baseline: JB (01) - EF (03)  
Timerange: 00/18:18:31 to 00/18:21:29

Plot file version 967 created 19-DEC-2018 17:59:14  
AT2018\_RY007C.UVDATA.1

Freq = 4.9270 GHz, Bw = 16.000 MH No calibration applied and no bandpass applied

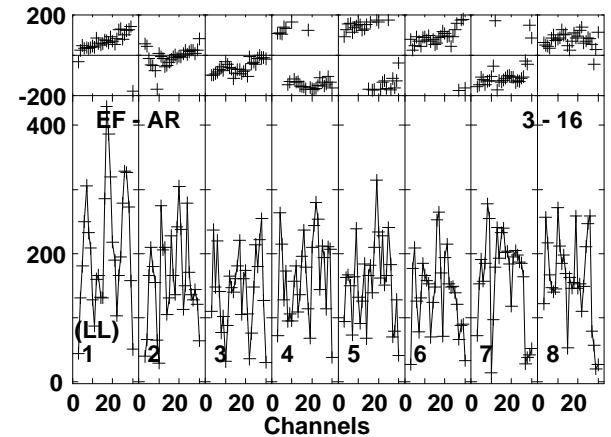
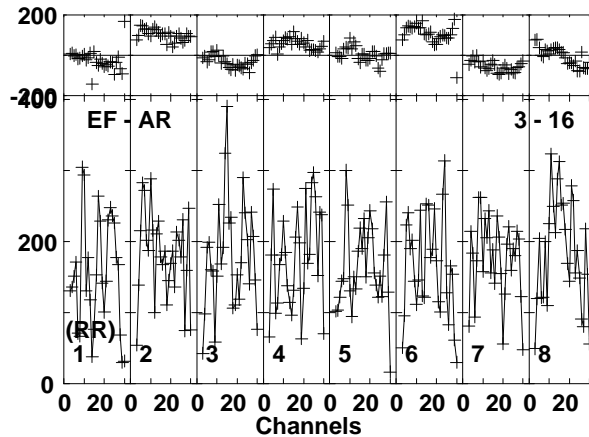
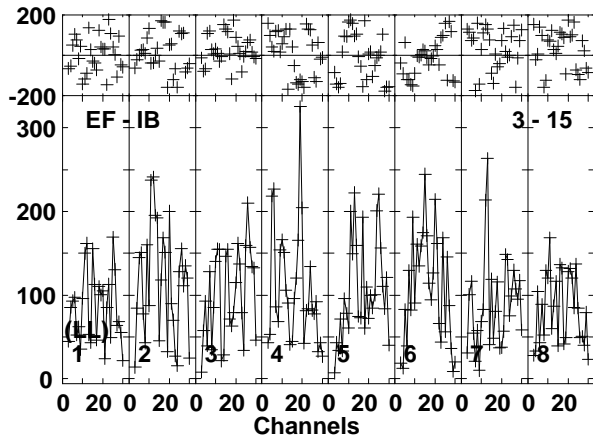
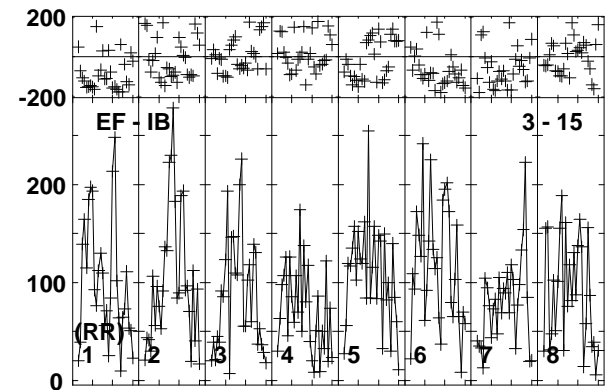
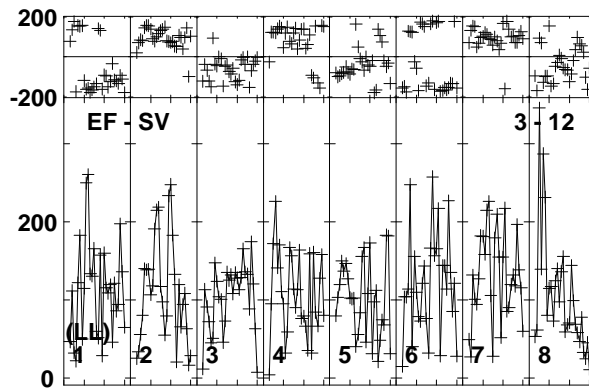
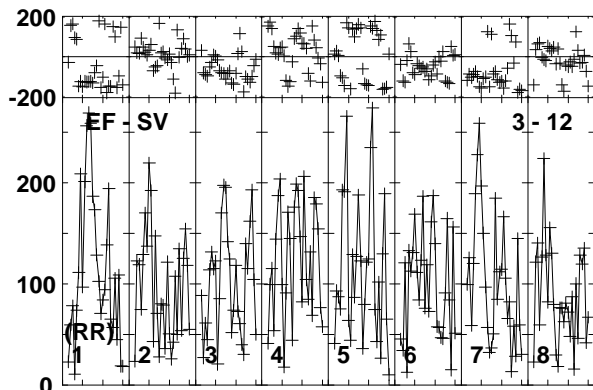
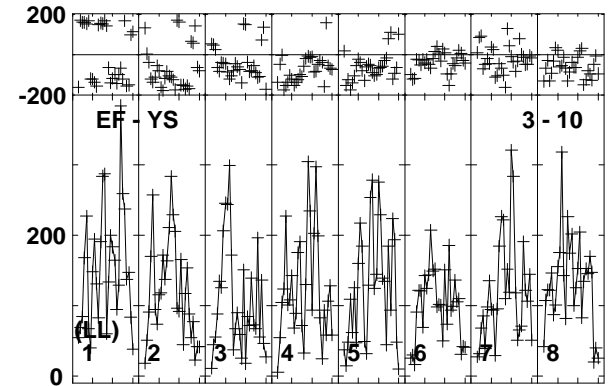
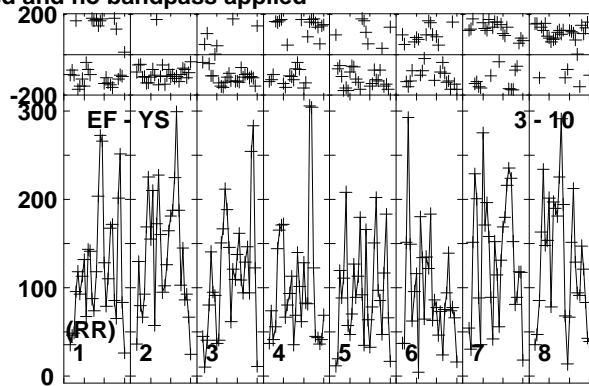
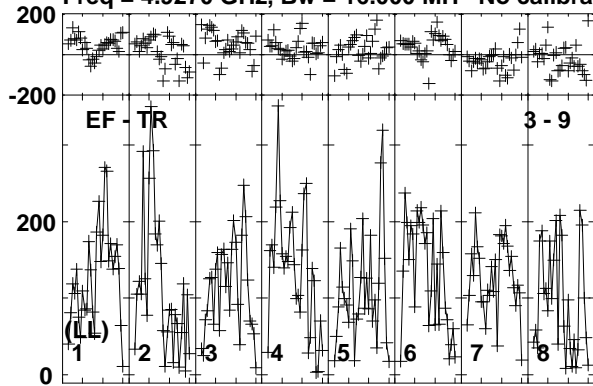

Lower frame: Micro Ampl Jy Top frame: Phas deg  
Vector averaged cross-power spectrum Baseline: EF (03) - TR (09)  
Timerange: 00/18:18:31 to 00/18:21:29

Plot file version 968 created 19-DEC-2018 17:59:15

J1619+2247 RY007C.UVDATA.1

Freq = 4.9270 GHz, Bw = 16.000 MH No calibration applied and no bandpass applied

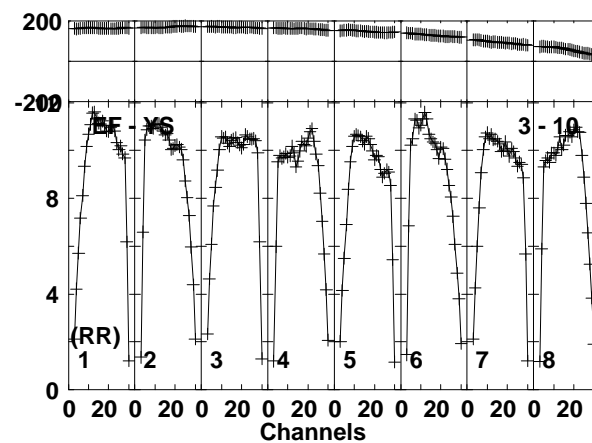
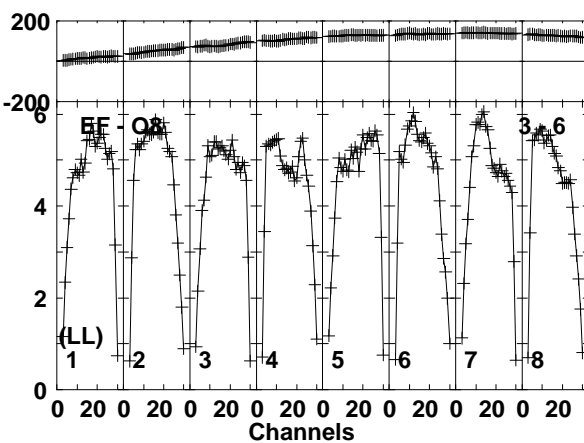
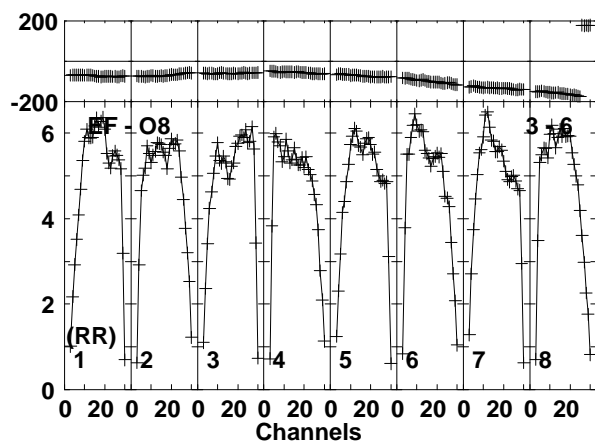
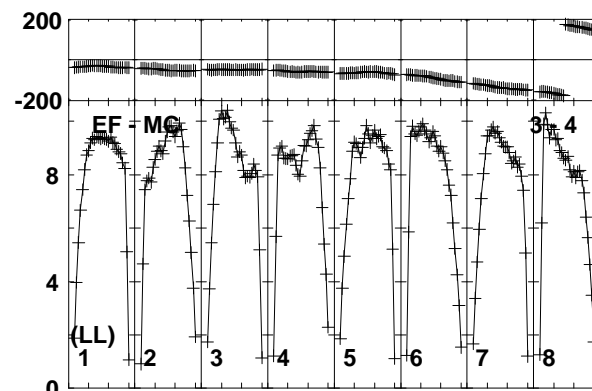
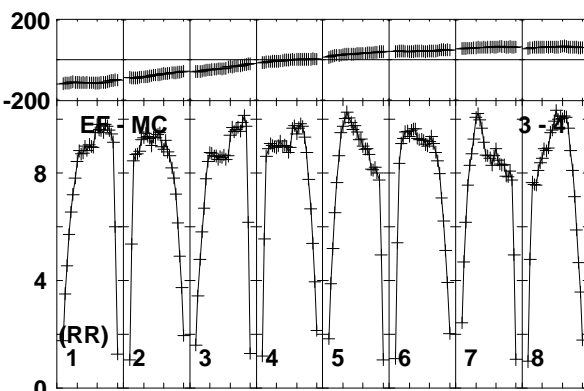
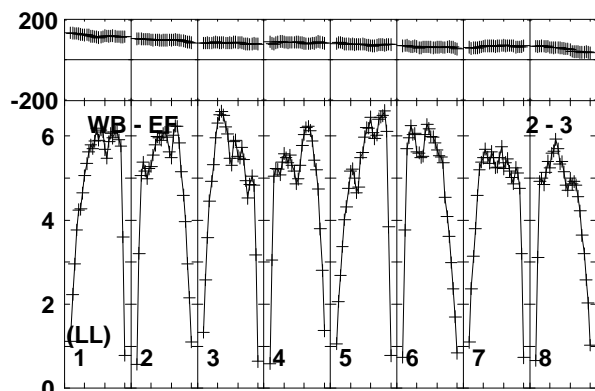
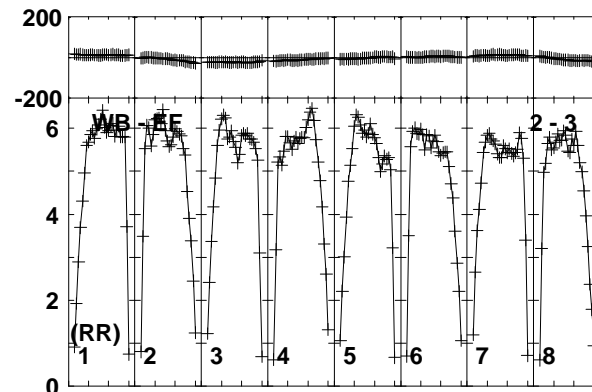
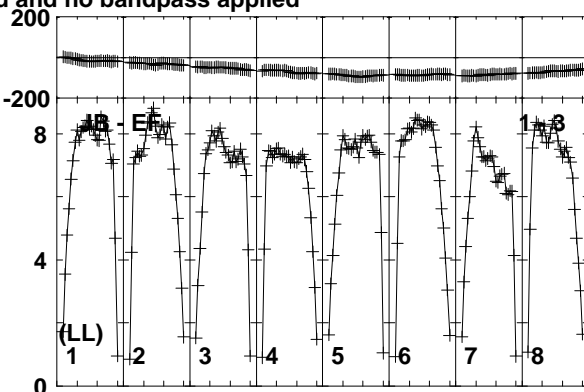
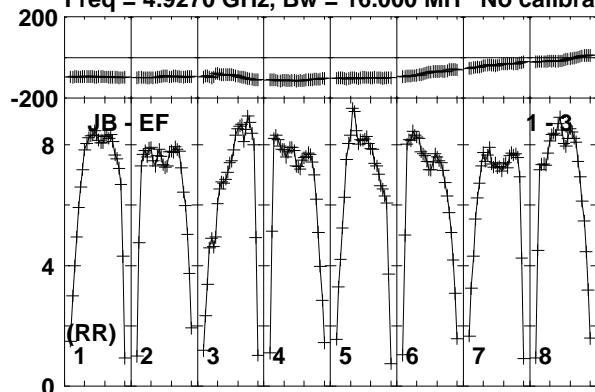

Lower frame: Milli Ampl Jy Top frame: Phas deg  
Vector averaged cross-power spectrum Baseline: JB (01) - EF (03)  
Timerange: 00/18:21:31 to 00/18:22:29

Plot file version 969 created 19-DEC-2018 17:59:15

J1619+2247 RY007C.UVDATA.1

Freq = 4.9270 GHz, Bw = 16.000 MH No calibration applied and no bandpass applied

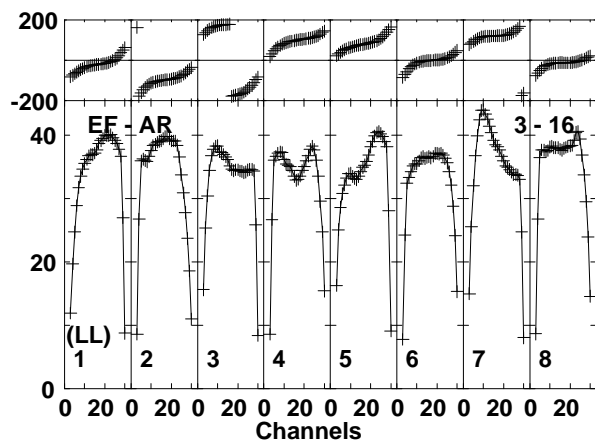
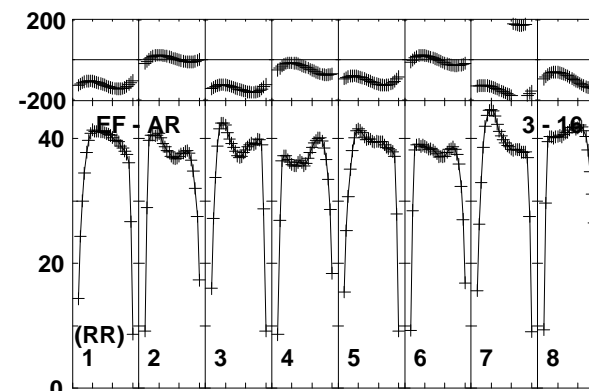
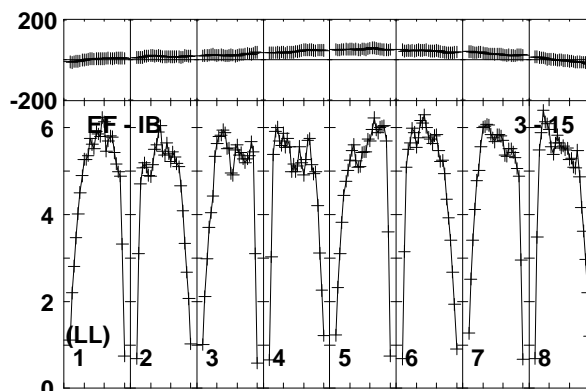
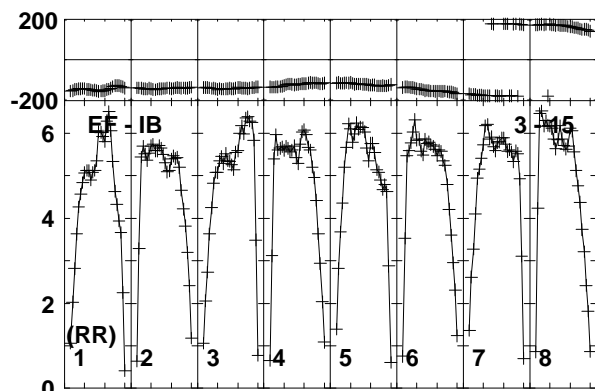
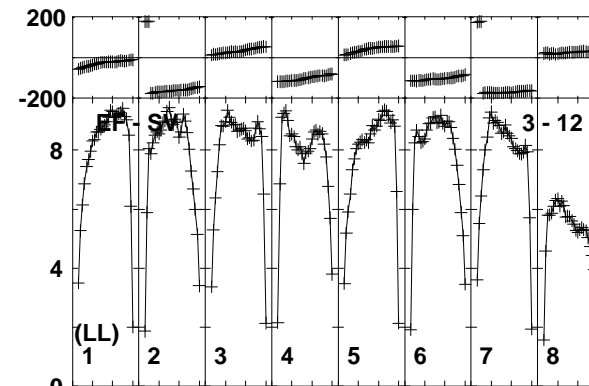
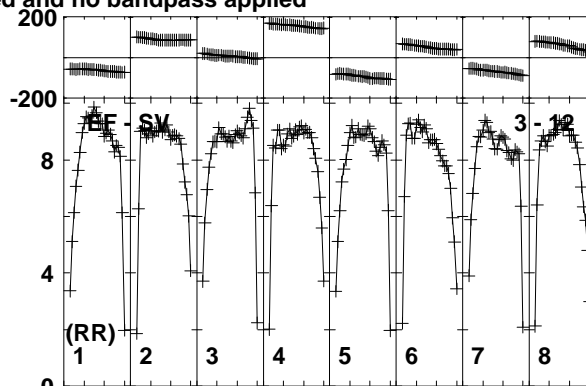
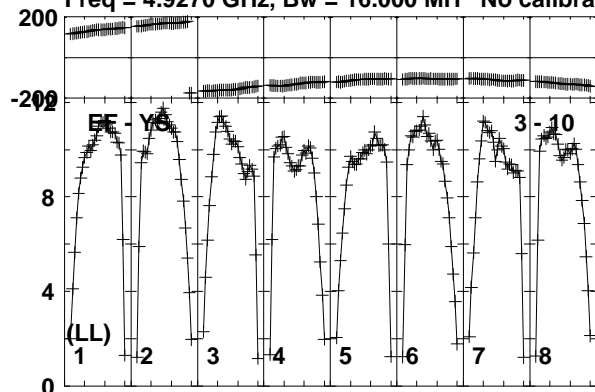

Lower frame: Milli Ampl Jy Top frame: Phas deg  
Vector averaged cross-power spectrum Baseline: EF (03) - YS (10)  
Timerange: 00/18:21:31 to 00/18:22:29

Plot file version 970 created 19-DEC-2018 17:59:15

VLA1 RY007C.UVDATA.1

Freq = 4.9270 GHz, Bw = 16.000 MH No calibration applied and no bandpass applied

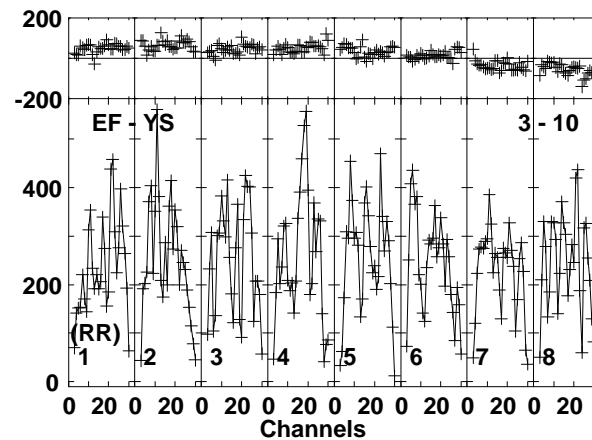
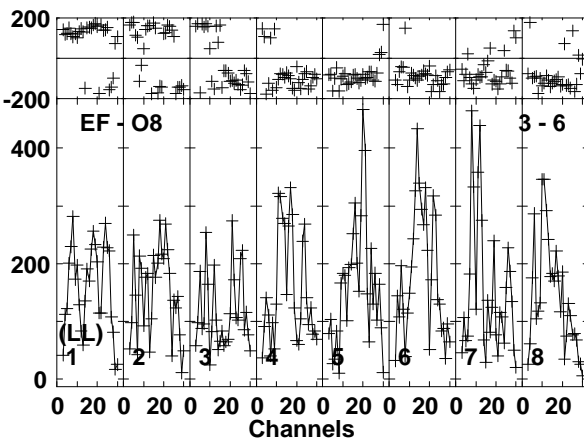
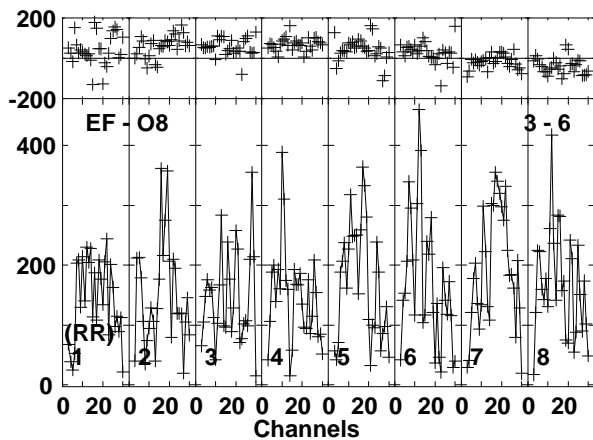
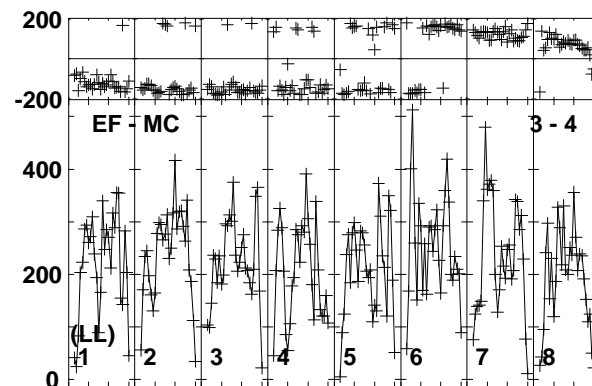
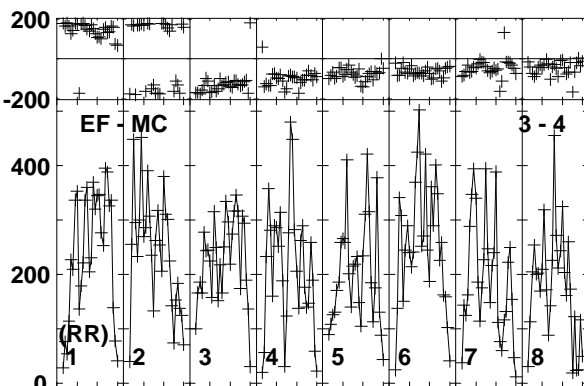
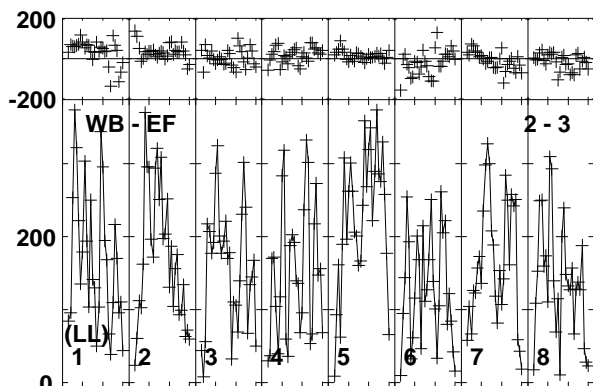
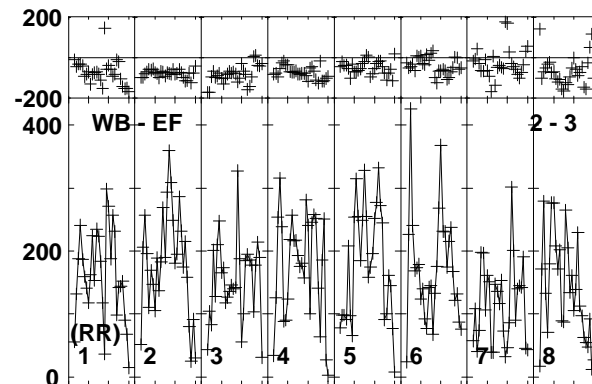
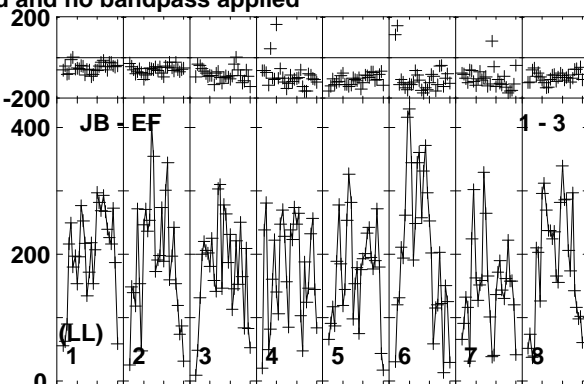
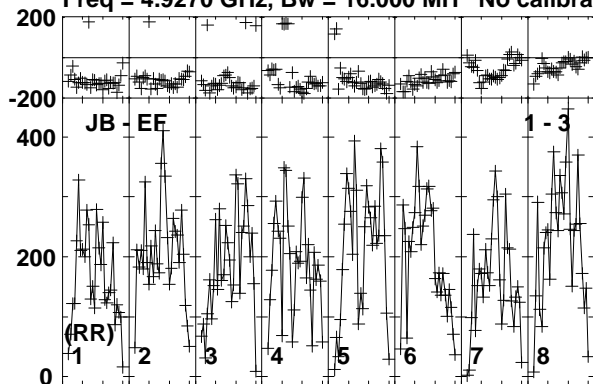

Lower frame: Micro Ampl Jy Top frame: Phas deg  
Vector averaged cross-power spectrum Baseline: JB (01) - EF (03)  
Timerange: 00/18:23:01 to 00/18:24:59



Plot file version 971 created 19-DEC-2018 17:59:15

VLA1 RY007C.UVDATA.1

Freq = 4.9270 GHz, Bw = 16.000 MH No calibration applied and no bandpass applied

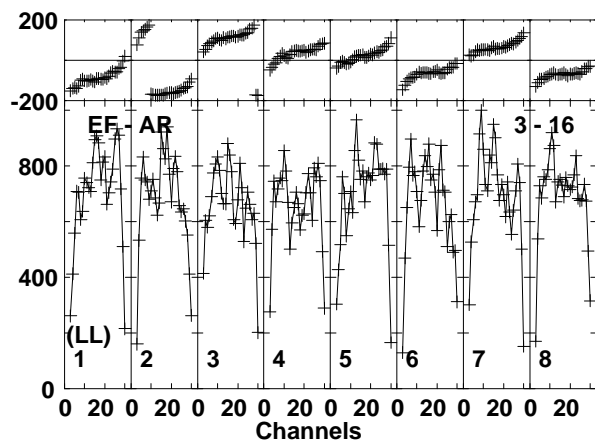
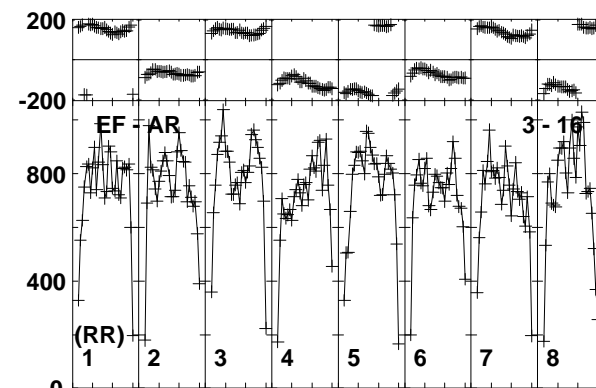
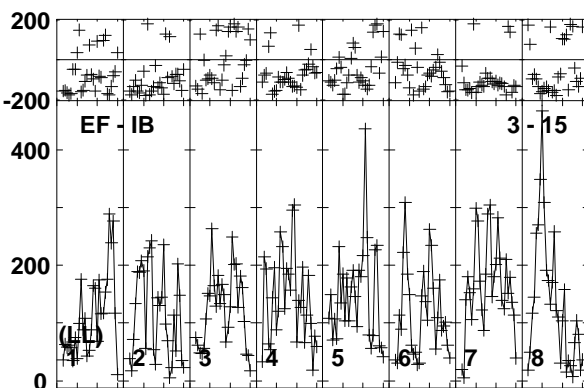
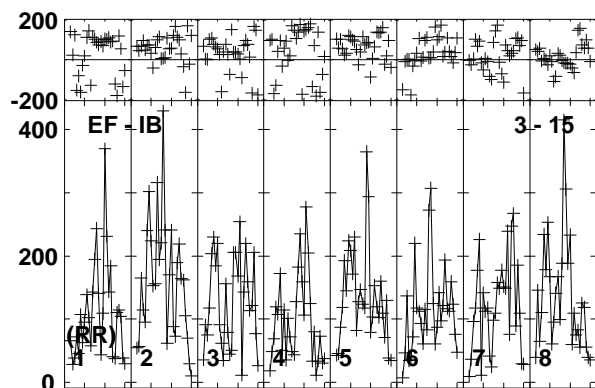
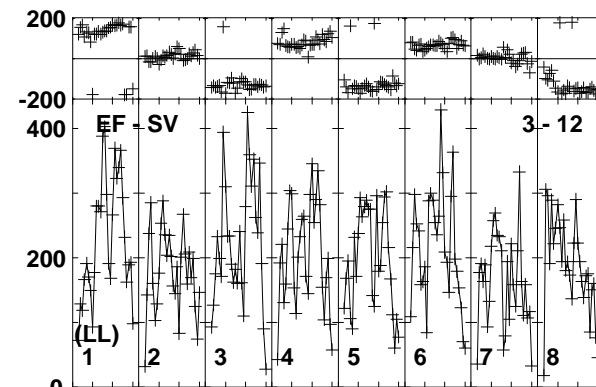
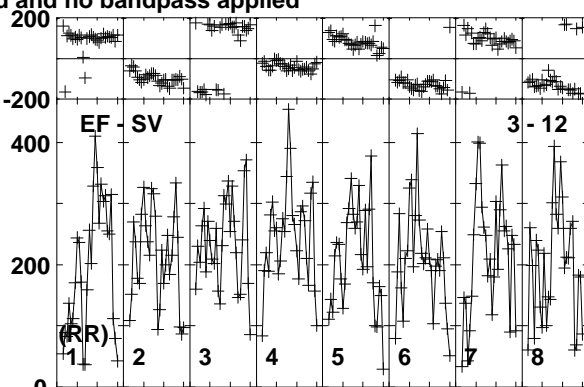
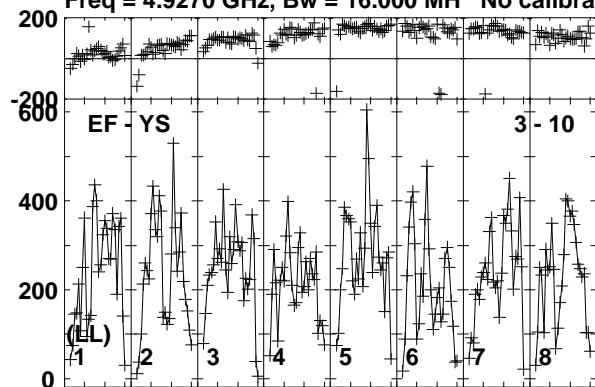

Lower frame: Micro Ampl Jy Top frame: Phas deg  
Vector averaged cross-power spectrum Baseline: EF (03) - YS (10)  
Timerange: 00:18:23:01 to 00:18:24:59

Plot file version 972 created 19-DEC-2018 17:59:15

J1619+2247 RY007C.UVDATA.1

Freq = 4.9270 GHz, Bw = 16.000 MH No calibration applied and no bandpass applied

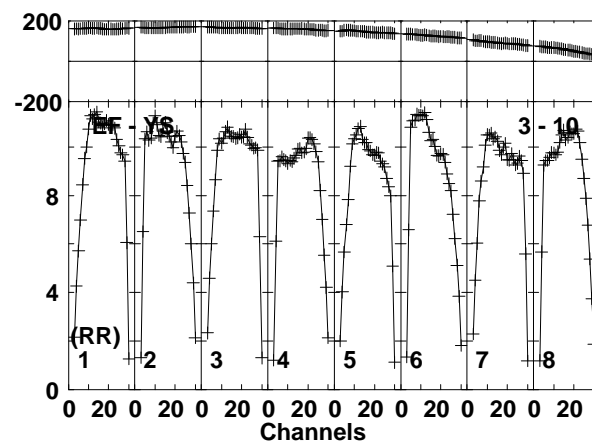
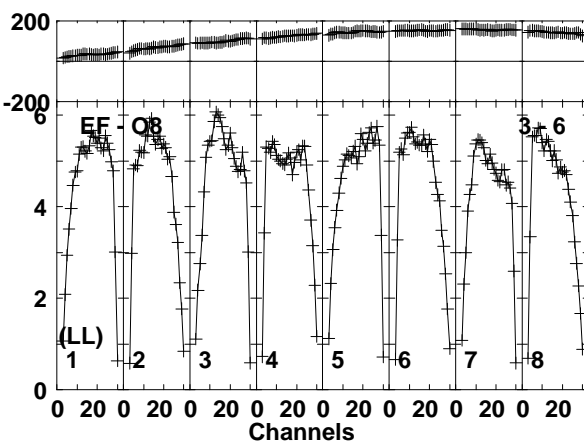
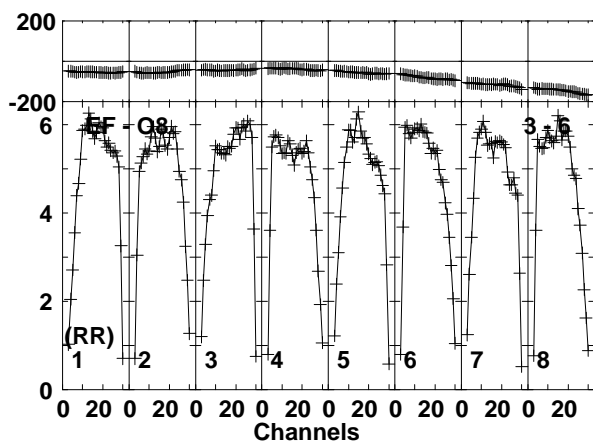
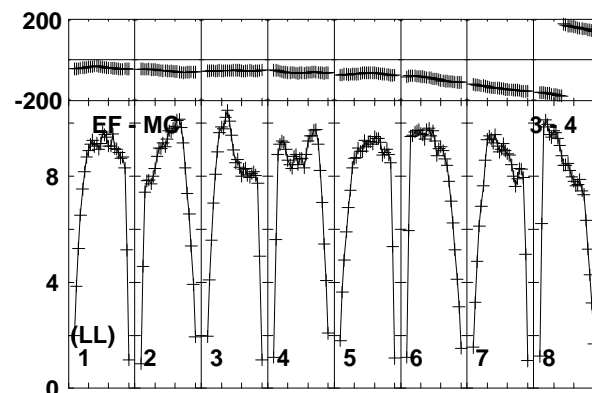
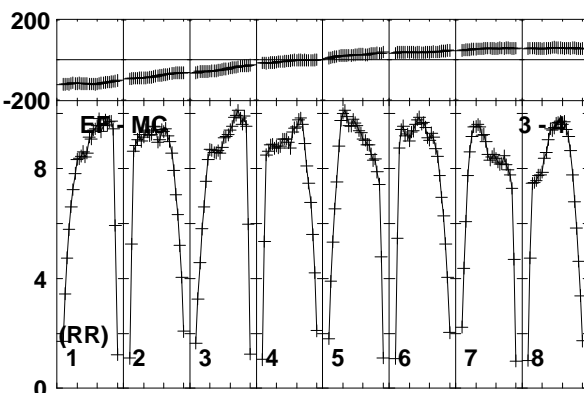
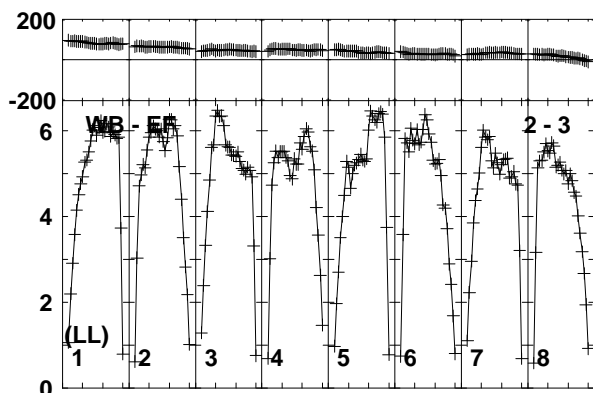
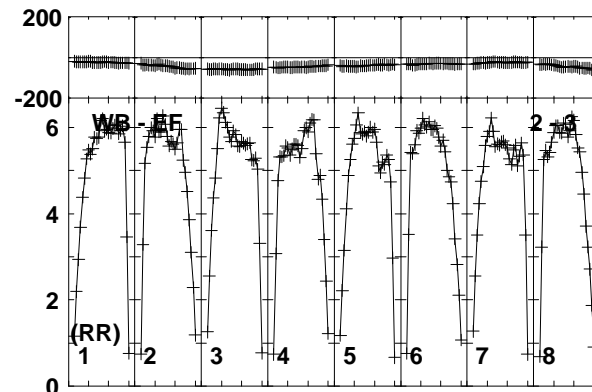
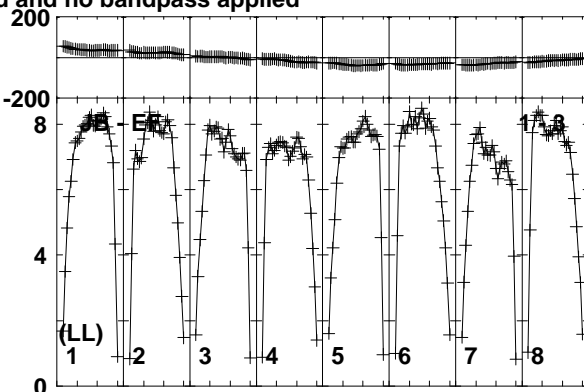
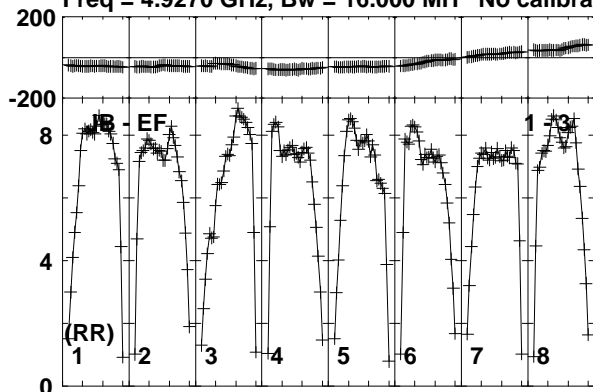

Lower frame: Milli Ampl Jy Top frame: Phas deg  
Vector averaged cross-power spectrum Baseline: JB (01) - EF (03)  
Timerange: 00/18:25:01 to 00/18:25:59

Plot file version 973 created 19-DEC-2018 17:59:15

J1619+2247 RY007C.UVDATA.1

Freq = 4.9270 GHz, Bw = 16.000 MH No calibration applied and no bandpass applied

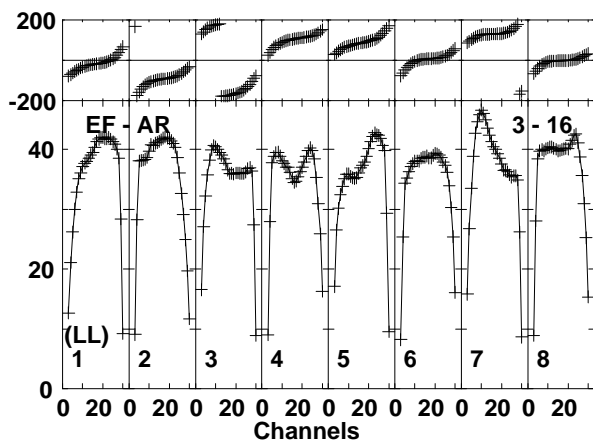
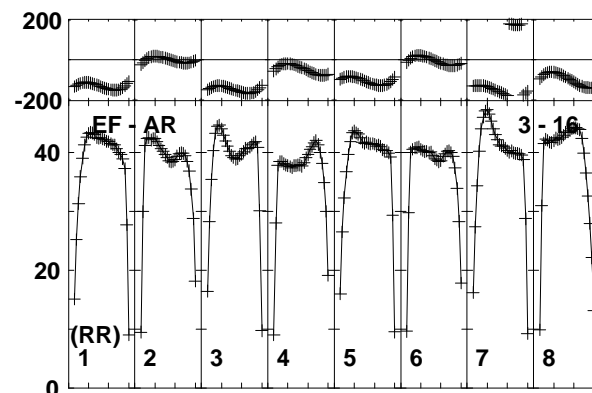
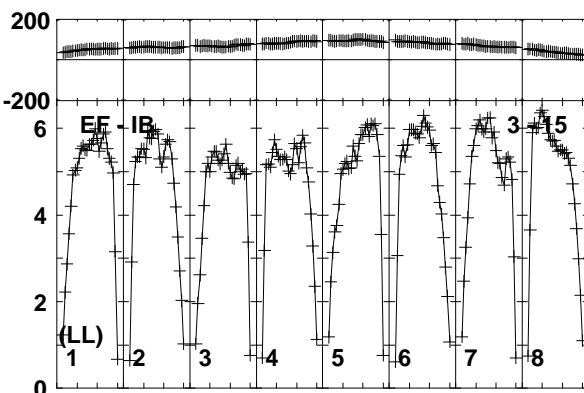
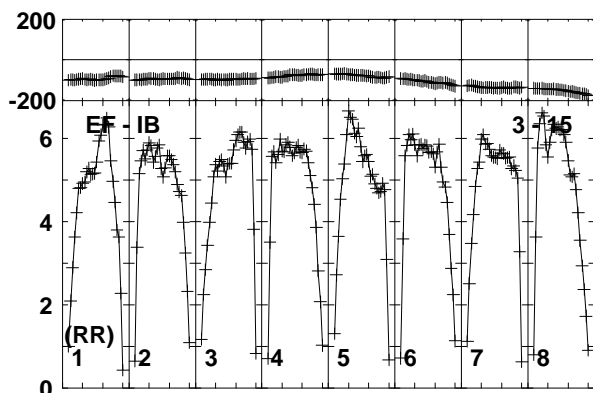
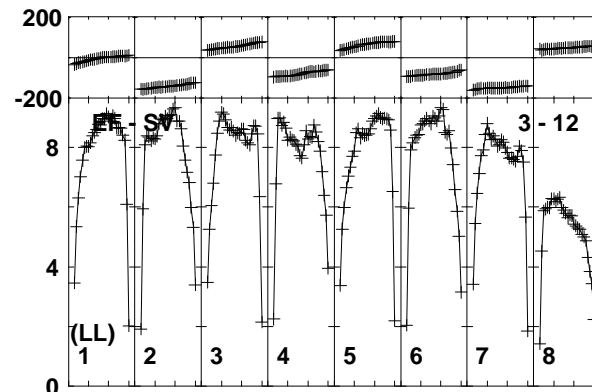
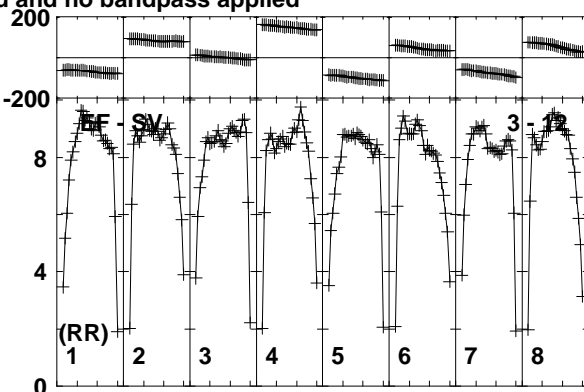
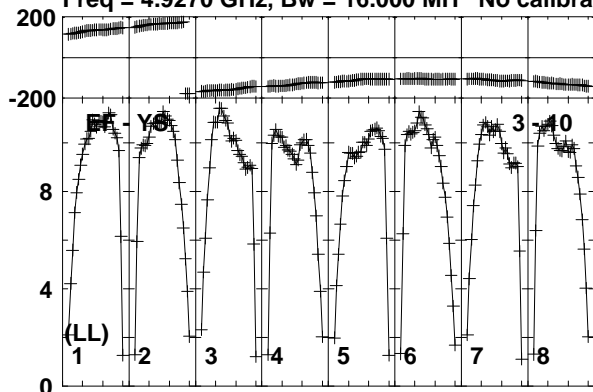

Lower frame: Milli Ampl Jy Top frame: Phas deg  
Vector averaged cross-power spectrum Baseline: EF (03) - YS (10)  
Timerange: 00/18:25:01 to 00/18:25:59

Plot file version 974 created 19-DEC-2018 17:59:15

AT2018\_RY007C.UVDATA.1

Freq = 4.9270 GHz, Bw = 16.000 MH No calibration applied and no bandpass applied

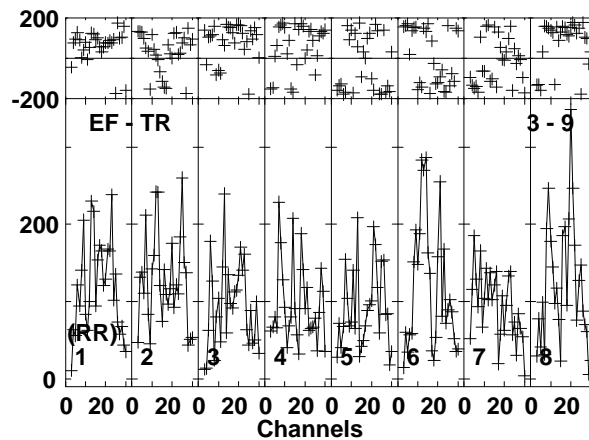
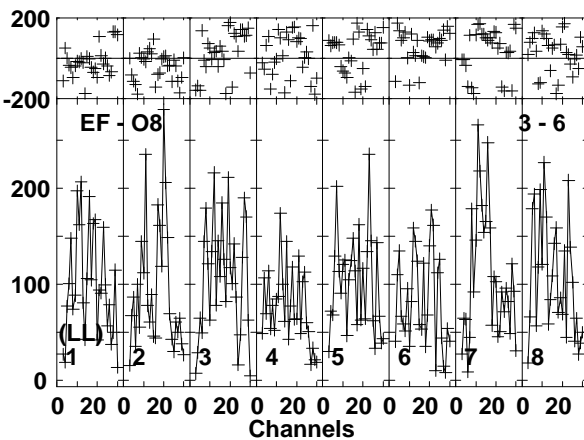
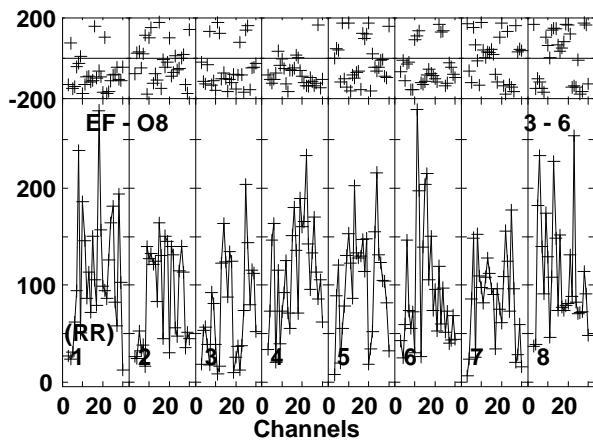
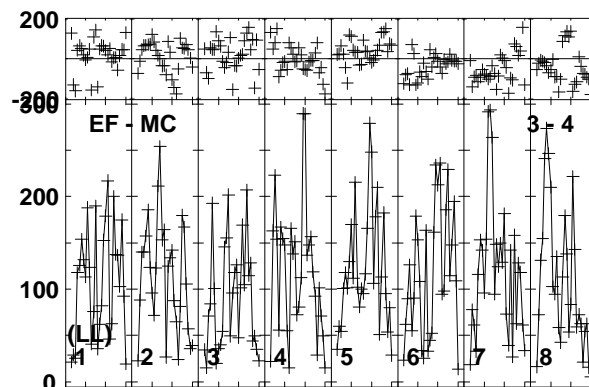
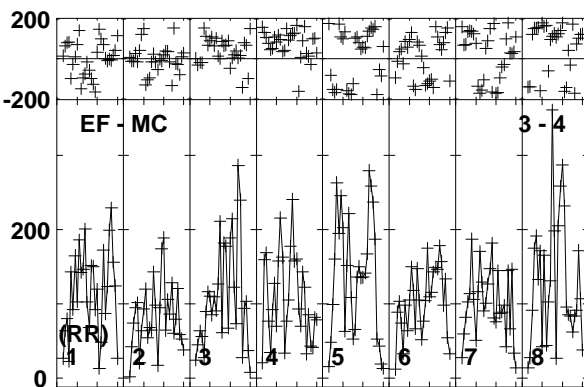
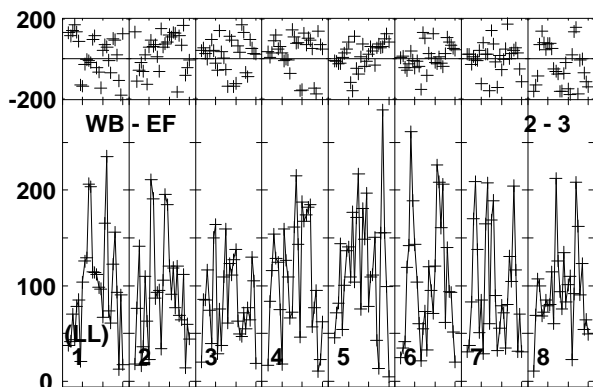
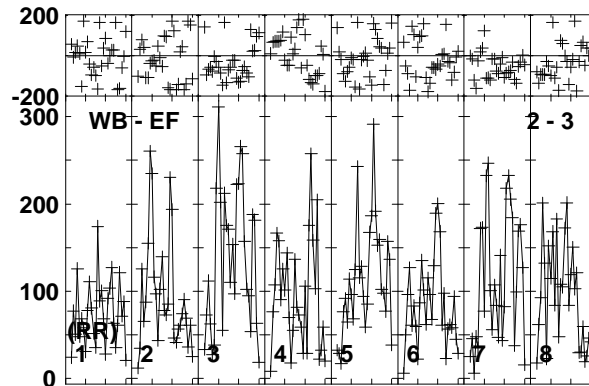
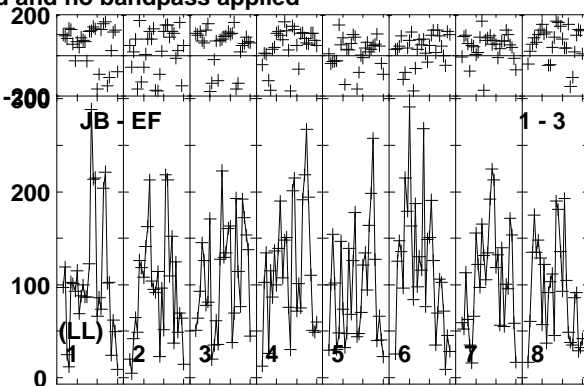
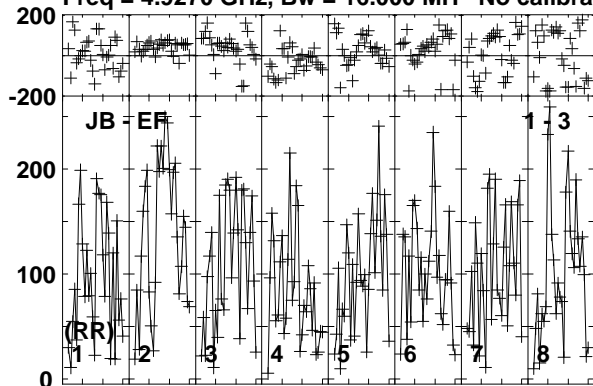

Lower frame: Micro Ampl Jy Top frame: Phas deg  
Vector averaged cross-power spectrum Baseline: JB (01) - EF (03)  
Timerange: 00/18:26:01 to 00/18:28:59

Plot file version 975 created 19-DEC-2018 17:59:15

AT2018\_RY007C.UVDATA.1

Freq = 4.9270 GHz, Bw = 16.000 MH No calibration applied and no bandpass applied

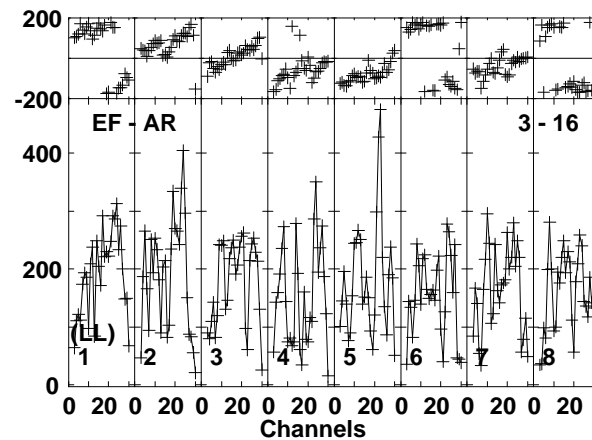
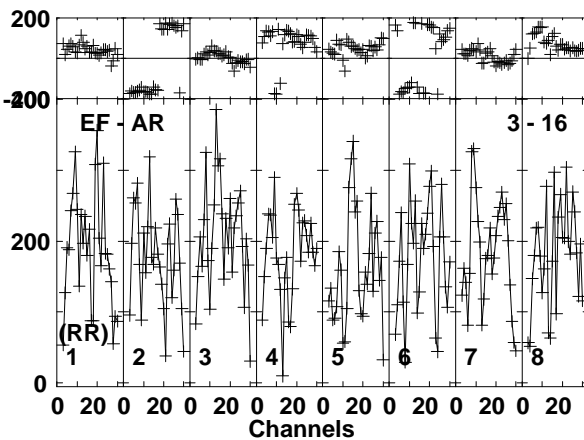
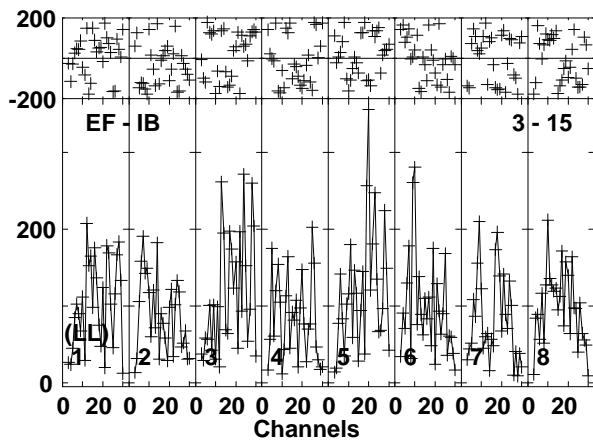
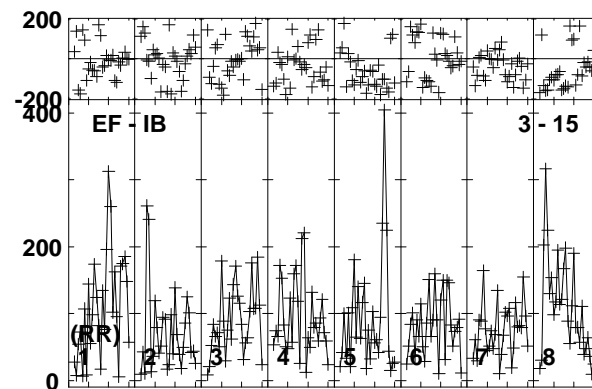
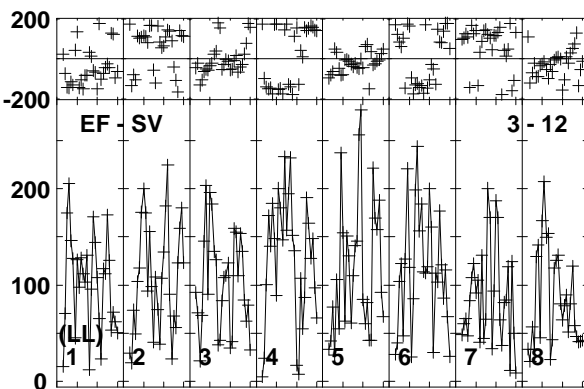
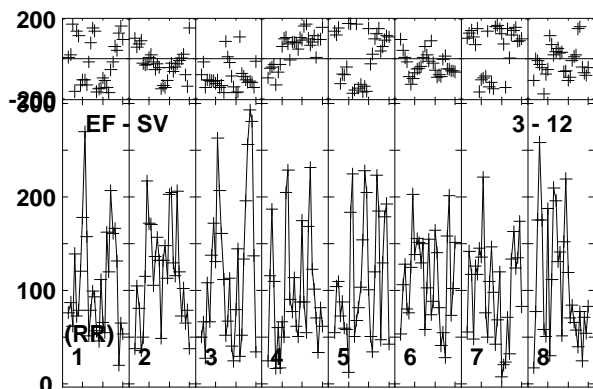
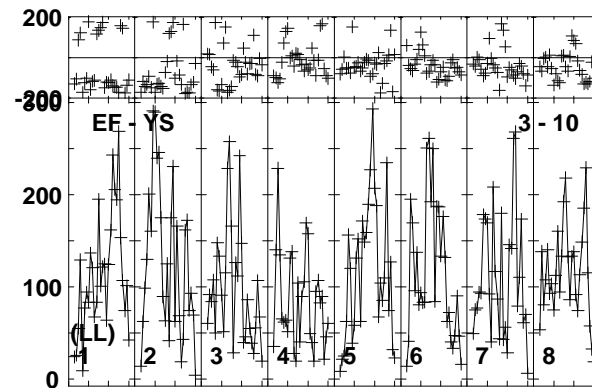
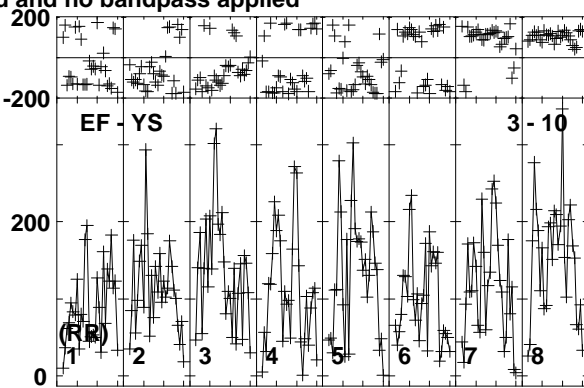
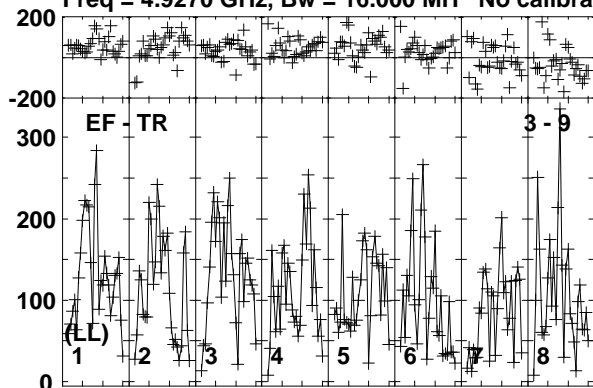

Lower frame: Micro Ampl Jy Top frame: Phas deg  
Vector averaged cross-power spectrum Baseline: EF (03) - TR (09)  
Timerange: 00/18:26:01 to 00/18:28:59

Plot file version 976 created 19-DEC-2018 17:59:15

J1619+2247 RY007C.UVDATA.1

Freq = 4.9270 GHz, Bw = 16.000 MH No calibration applied and no bandpass applied

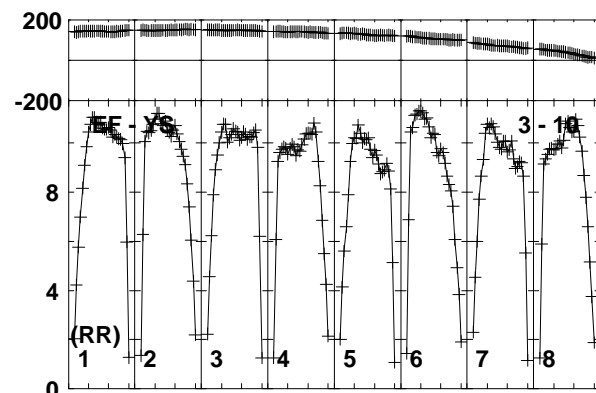
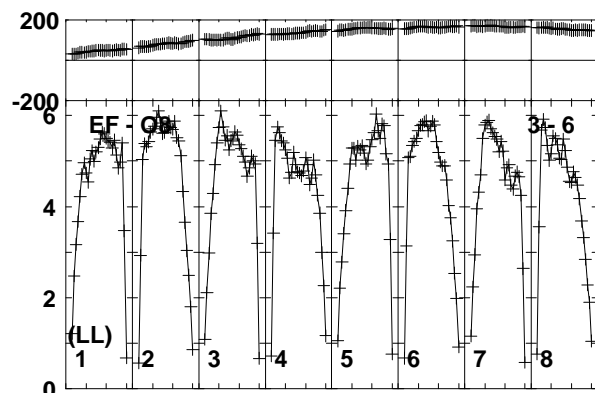
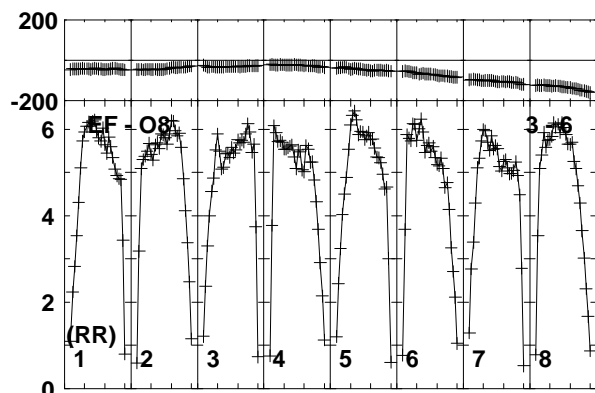
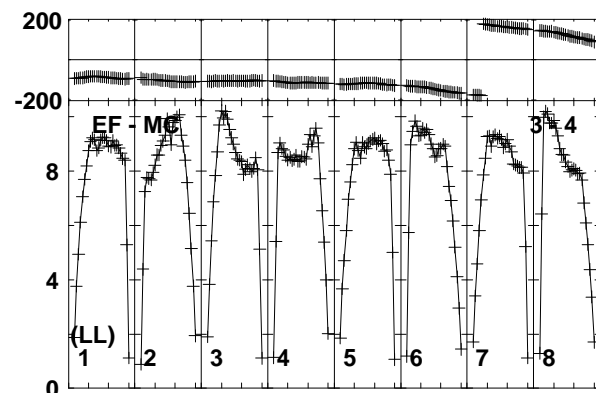
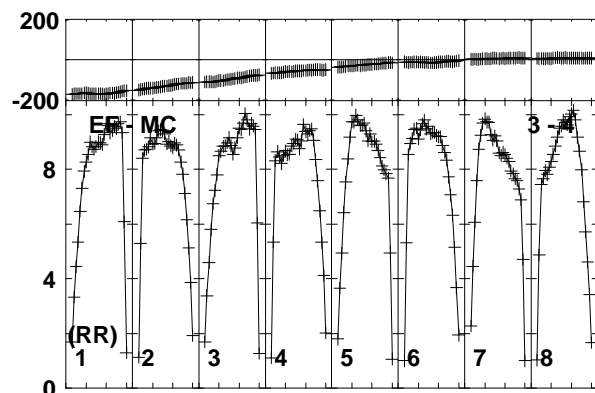
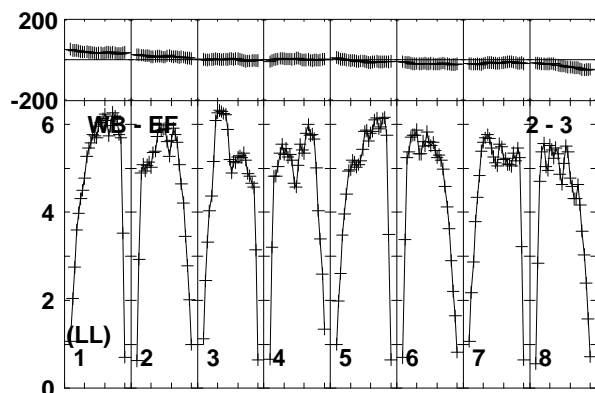
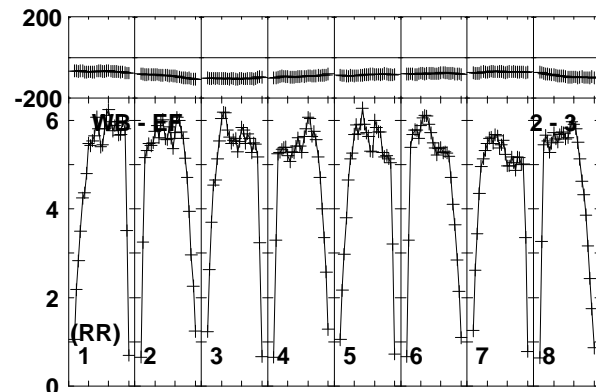
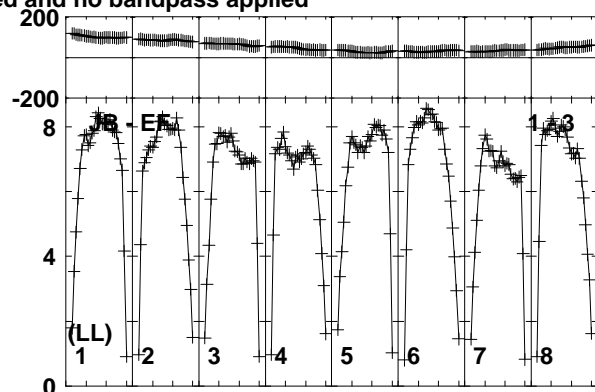
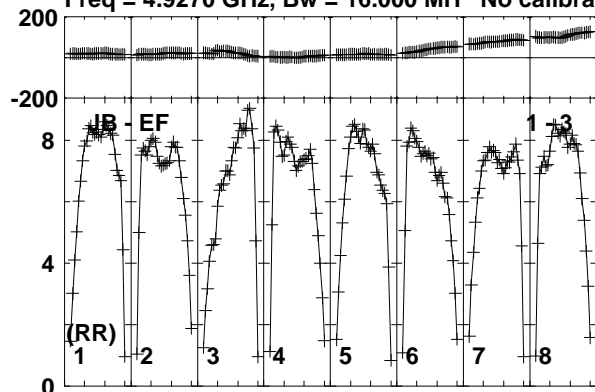

Lower frame: Milli Ampl Jy Top frame: Phas deg  
Vector averaged cross-power spectrum Baseline: JB (01) - EF (03)  
Timerange: 00/18:29:01 to 00/18:29:59

Plot file version 977 created 19-DEC-2018 17:59:15

J1619+2247 RY007C.UVDATA.1

Freq = 4.9270 GHz, Bw = 16.000 MH No calibration applied and no bandpass applied

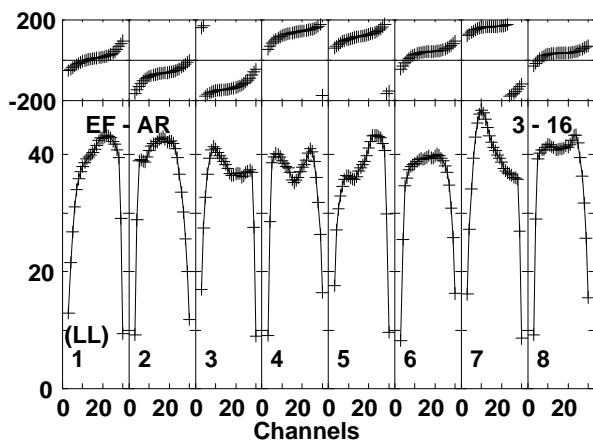
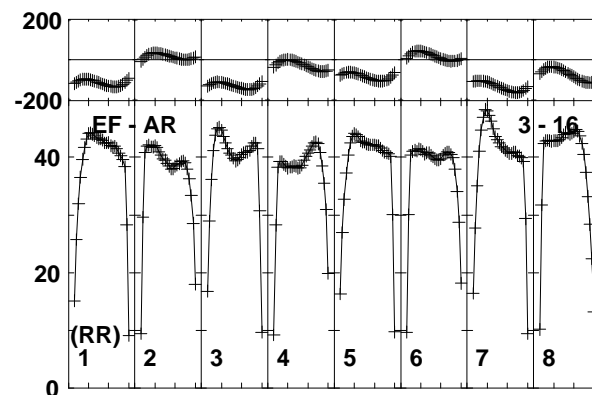
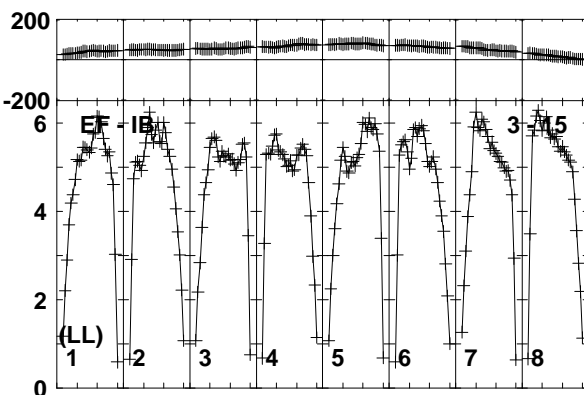
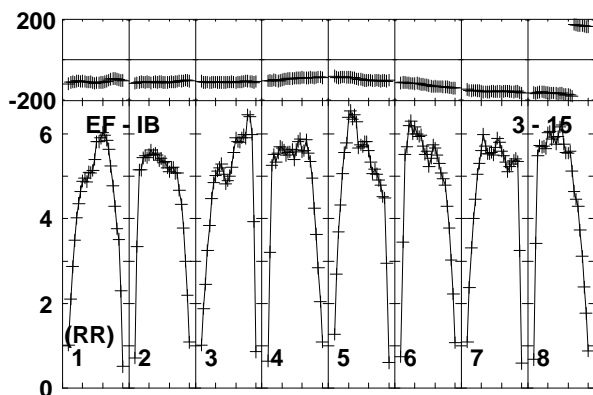
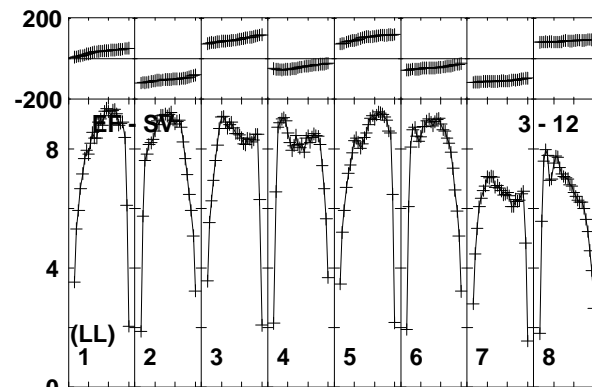
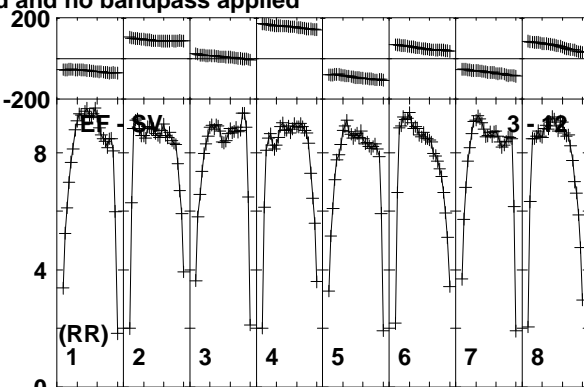
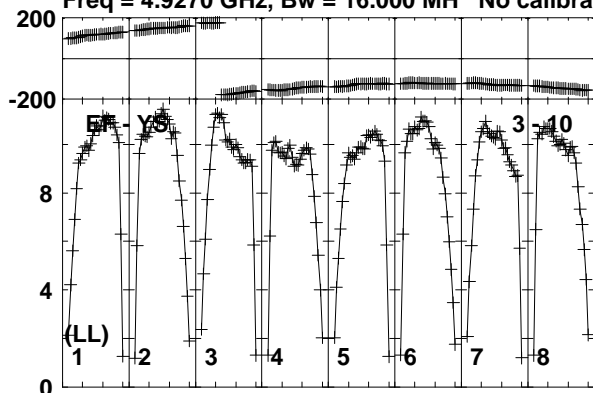

Lower frame: Milli Ampl Jy Top frame: Phas deg  
Vector averaged cross-power spectrum Baseline: EF (03) - YS (10)  
Timerange: 00/18:29:01 to 00/18:29:59

Plot file version 978 created 19-DEC-2018 17:59:15

AT2018\_RY007C.UVDATA.1

Freq = 4.9270 GHz, Bw = 16.000 MH No calibration applied and no bandpass applied

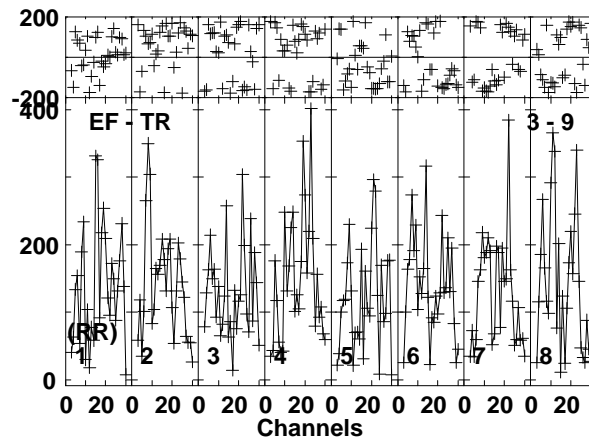
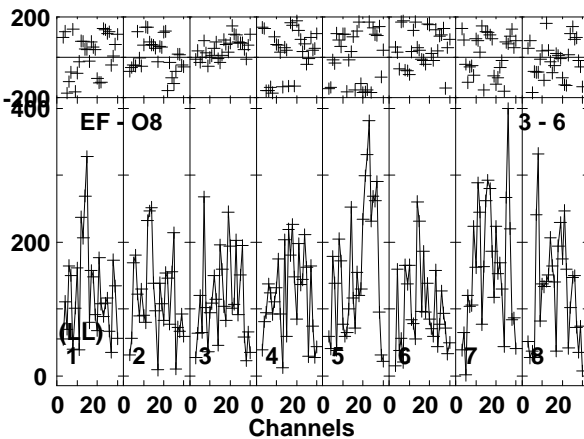
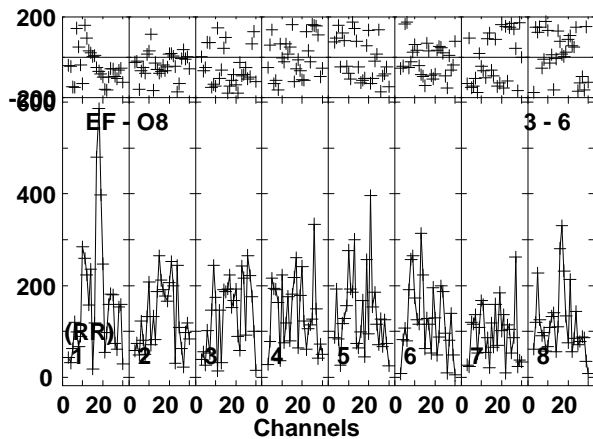
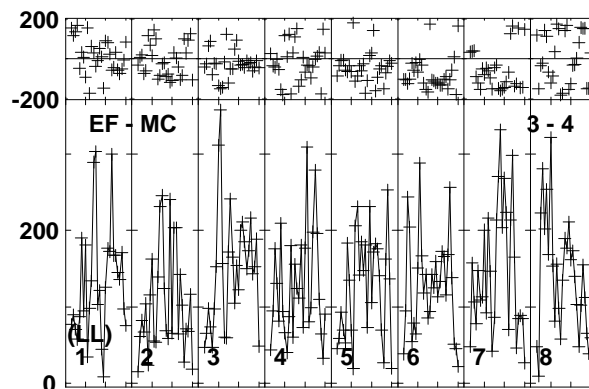
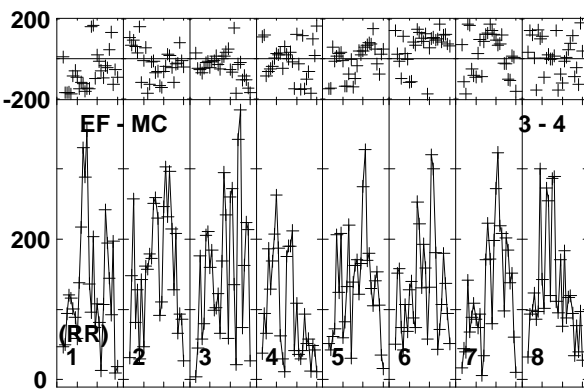
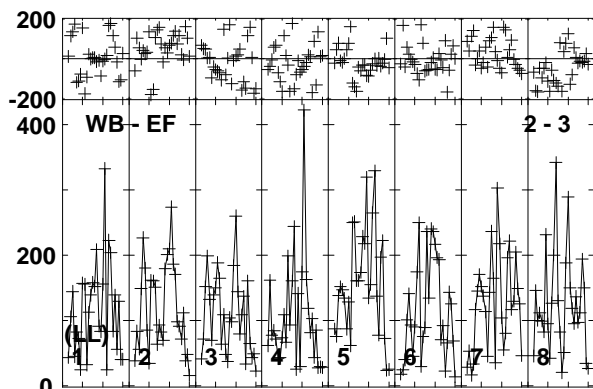
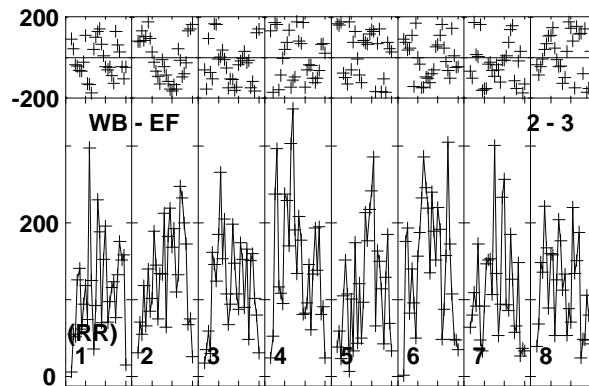
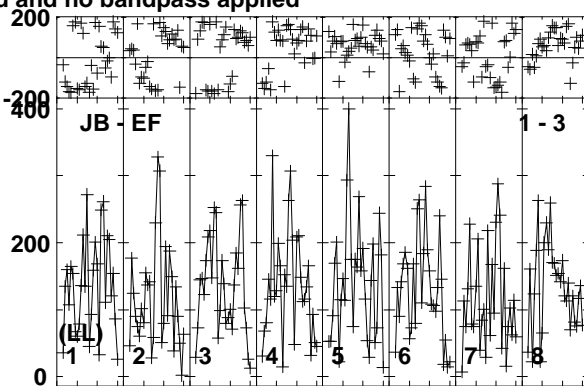
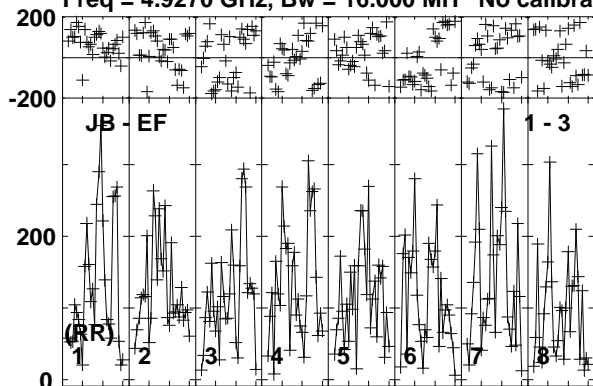

Lower frame: Micro Ampl Jy Top frame: Phas deg  
Vector averaged cross-power spectrum Baseline: JB (01) - EF (03)  
Timerange: 00:18:30:01 to 00:18:31:59



Plot file version 979 created 19-DEC-2018 17:59:15

AT2018\_RY007C.UVDATA.1

Freq = 4.9270 GHz, Bw = 16.000 MH No calibration applied and no bandpass applied

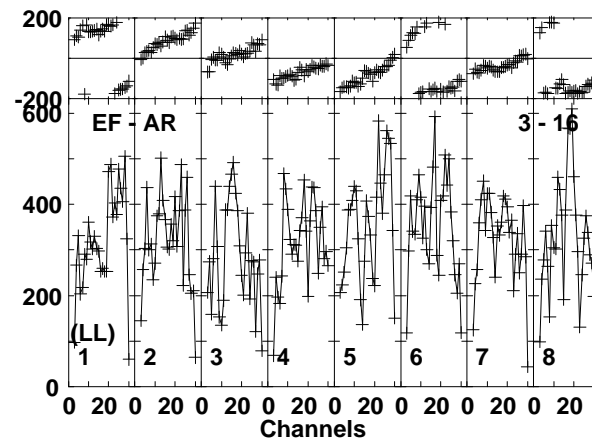
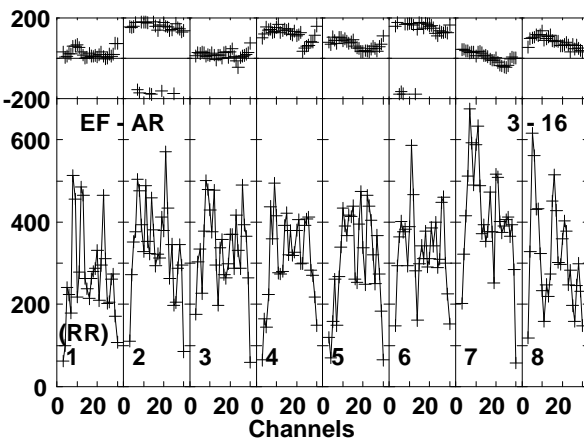
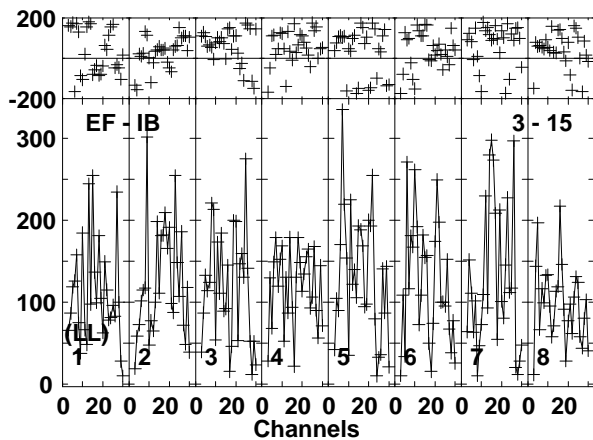
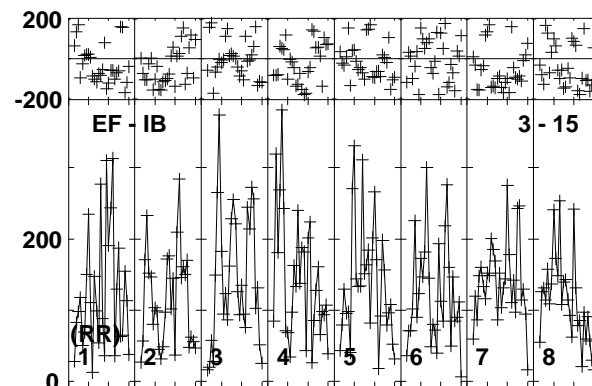
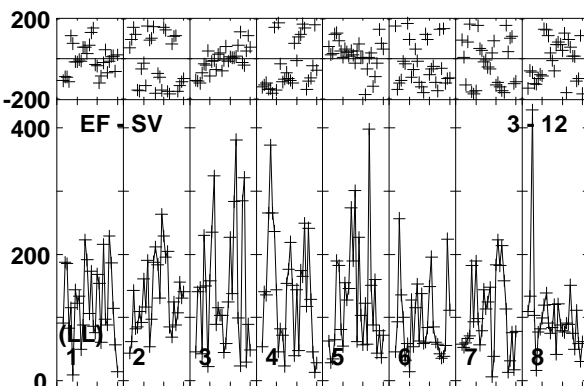
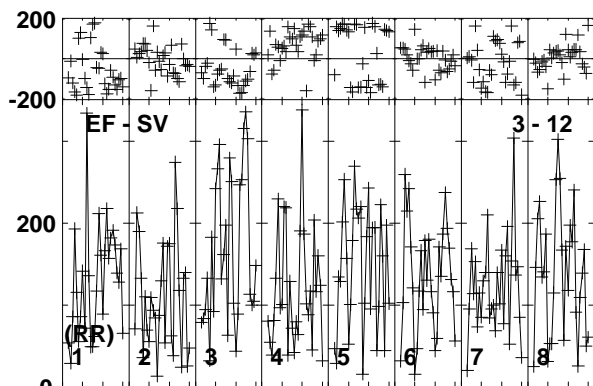
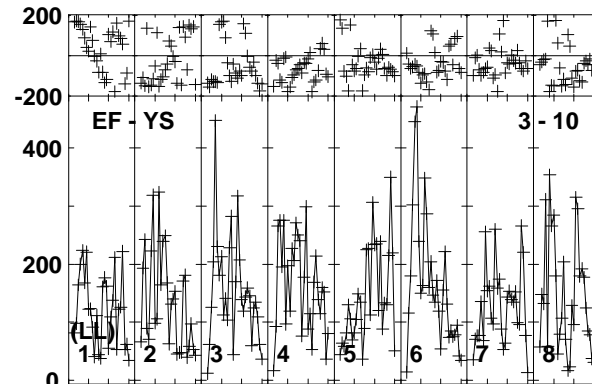
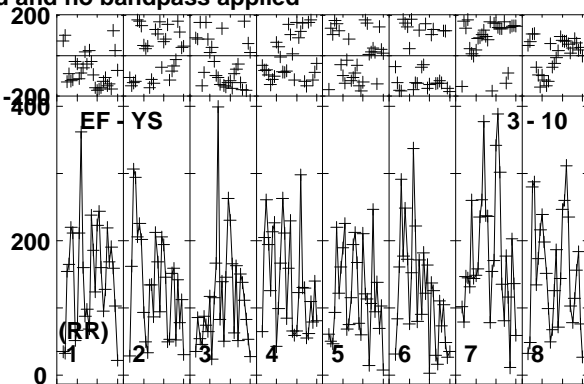
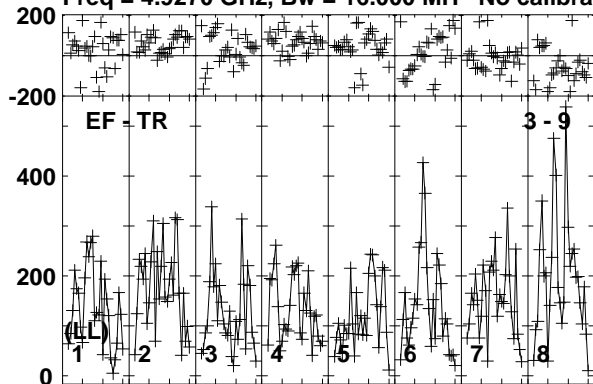

Lower frame: Micro Ampl Jy Top frame: Phas deg  
Vector averaged cross-power spectrum Baseline: EF (03) - TR (09)  
Timerange: 00/18:30:01 to 00/18:31:59

Plot file version 980 created 19-DEC-2018 17:59:15

VLA2 RY007C.UVDATA.1

Freq = 4.9270 GHz, Bw = 16.000 MH No calibration applied and no bandpass applied

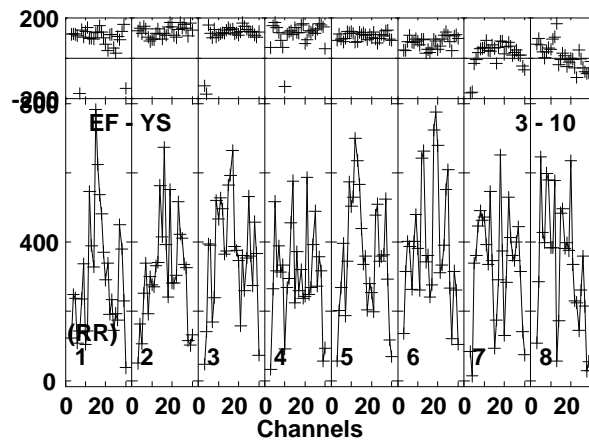
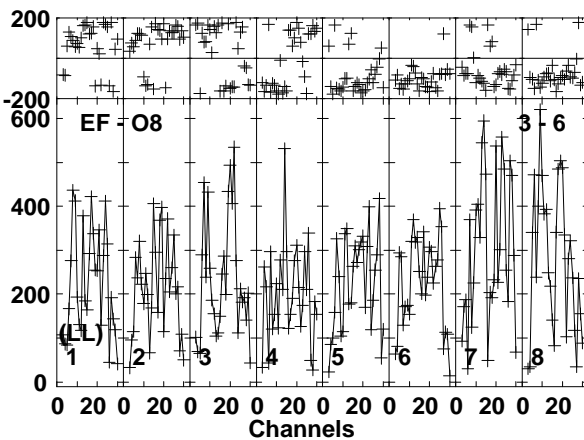
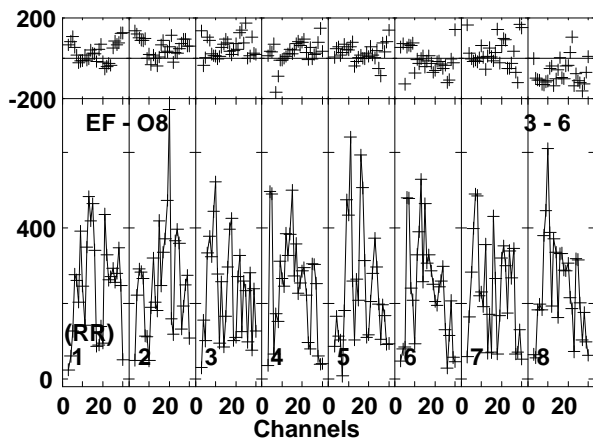
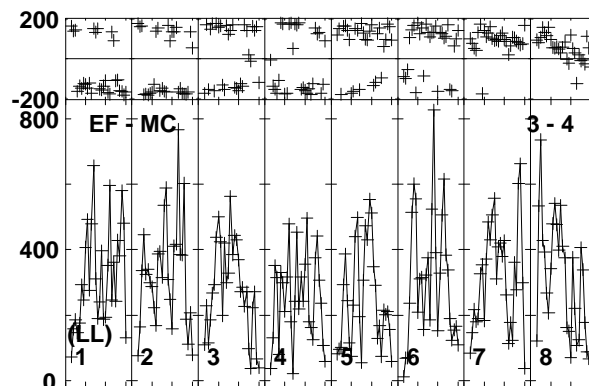
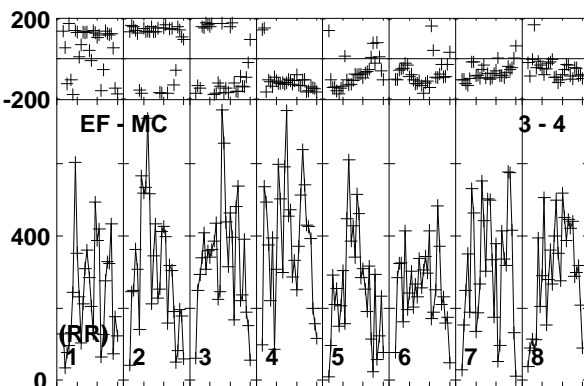
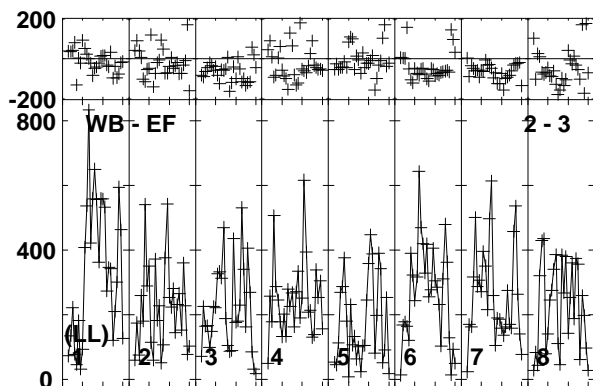
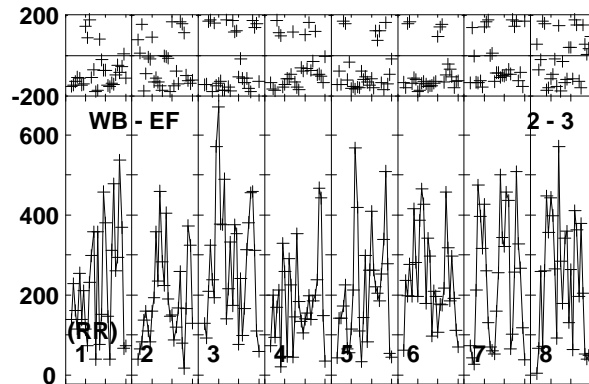
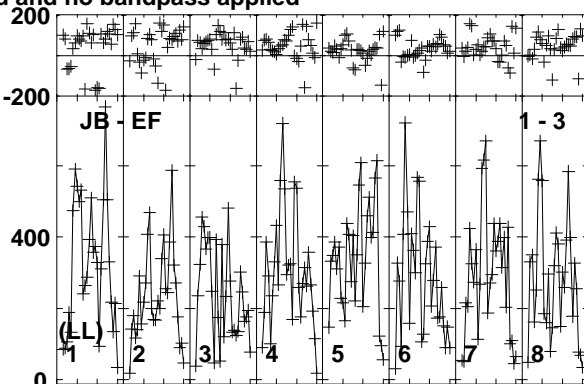
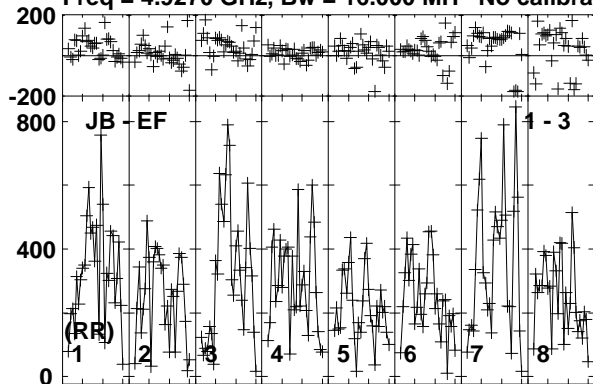

Lower frame: Micro Ampl Jy Top frame: Phas deg  
Vector averaged cross-power spectrum Baseline: JB (01) - EF (03)  
Timerange: 00/18:32:01 to 00/18:32:59

Plot file version 981 created 19-DEC-2018 17:59:15

VLA2 RY007C.UVDATA.1

Freq = 4.9270 GHz, Bw = 16.000 MH No calibration applied and no bandpass applied

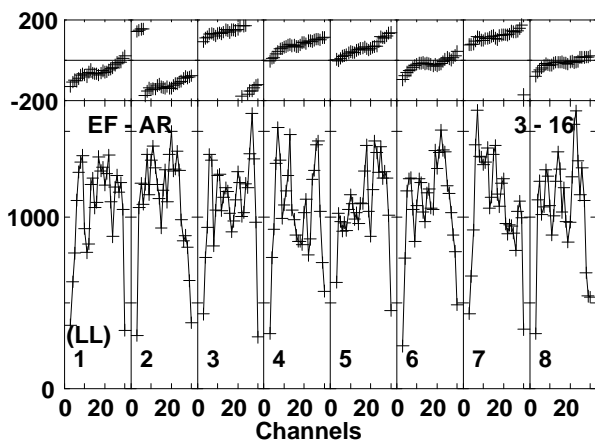
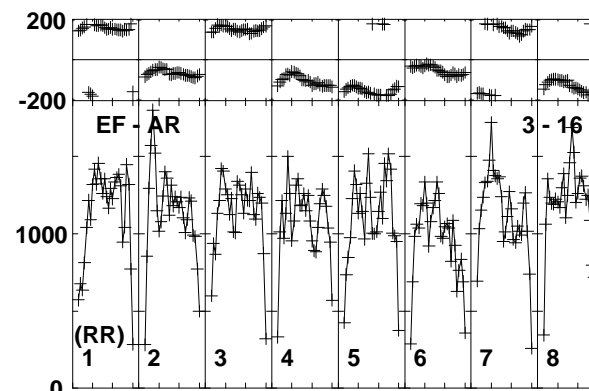
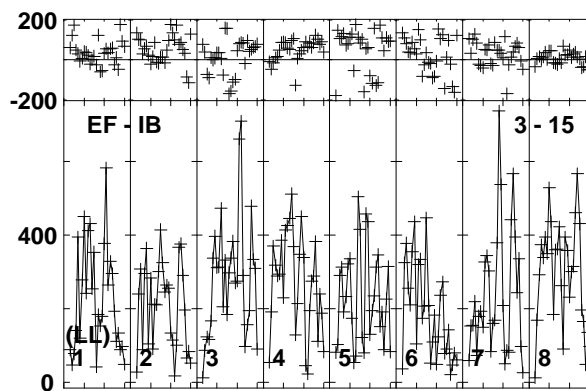
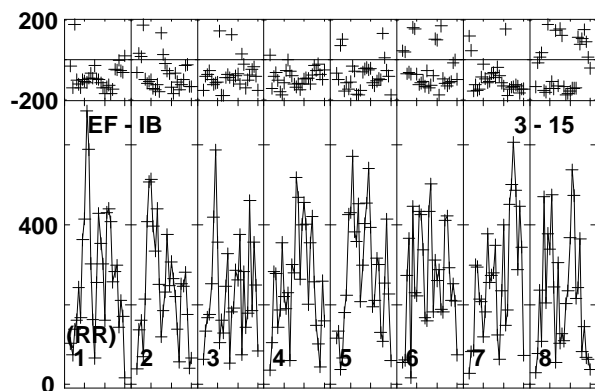
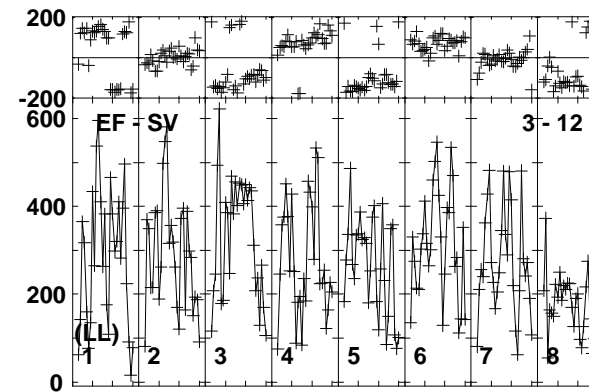
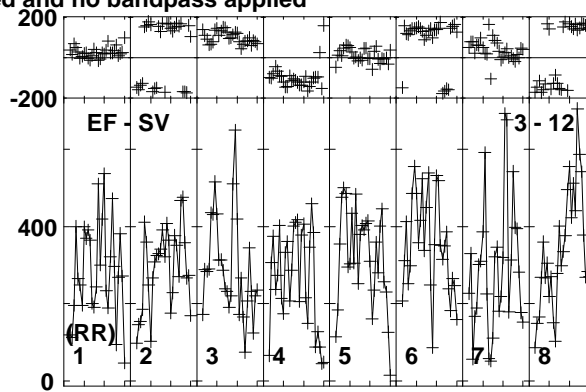
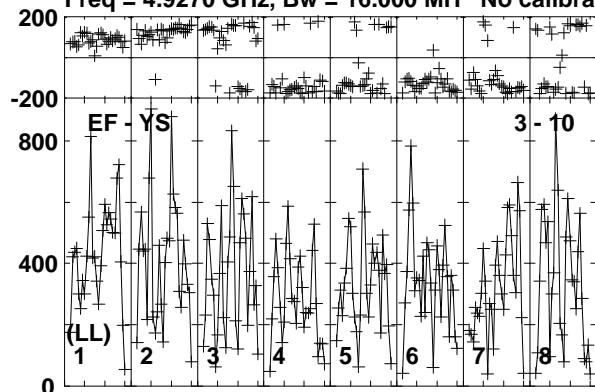

Lower frame: Micro Ampl Jy Top frame: Phas deg  
Vector averaged cross-power spectrum Baseline: EF (03) - YS (10)  
Timerange: 00/18:32:01 to 00/18:32:59

Plot file version 982 created 19-DEC-2018 17:59:15

J1619+2247 RY007C.UVDATA.1

Freq = 4.9270 GHz, Bw = 16.000 MH No calibration applied and no bandpass applied

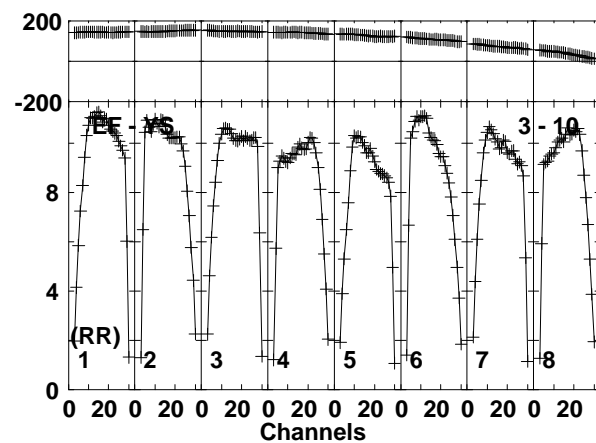
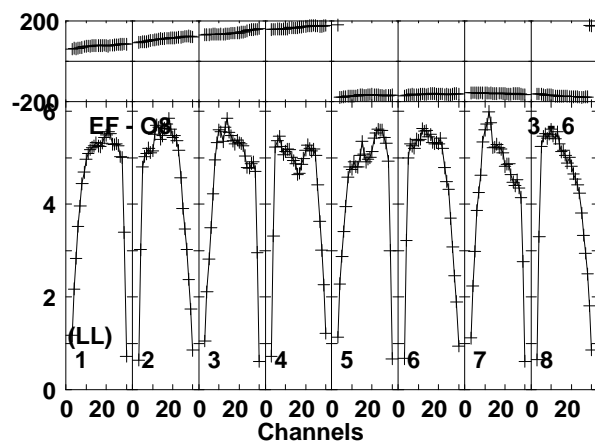
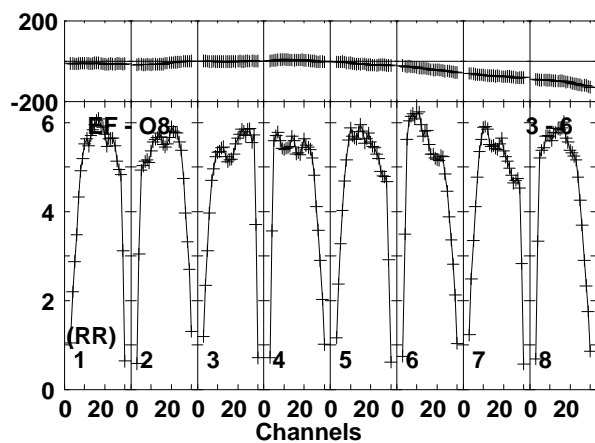
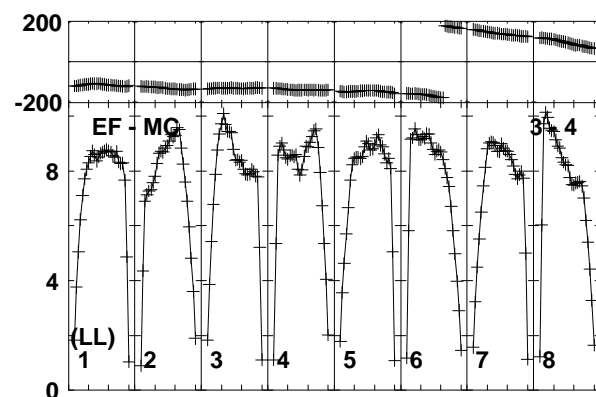
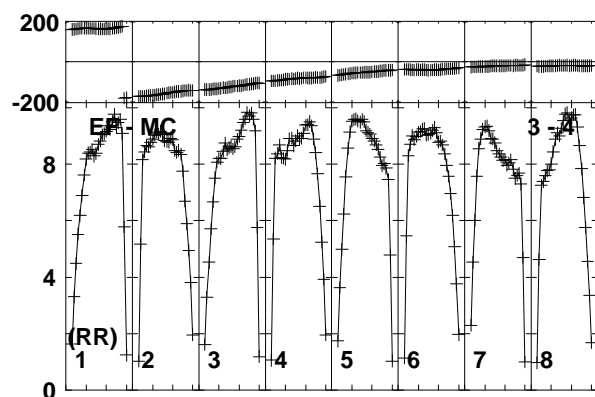
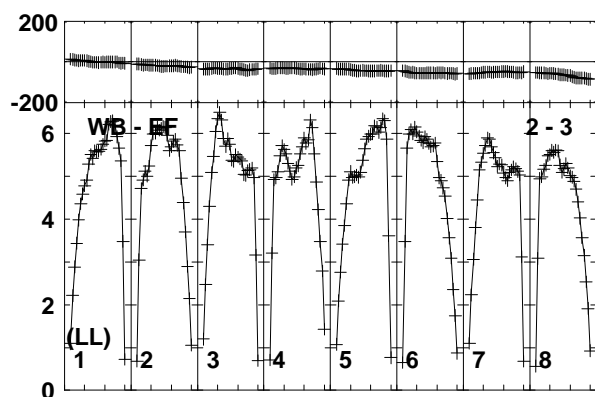
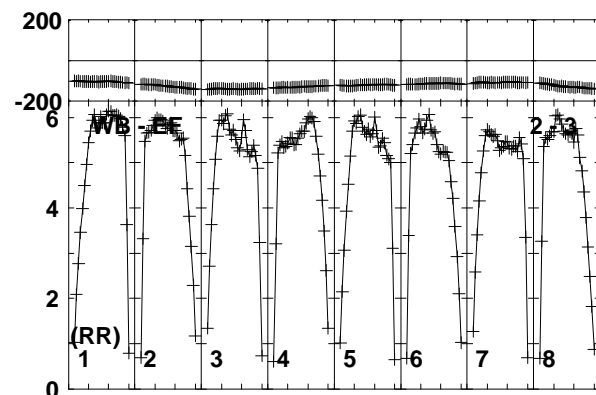
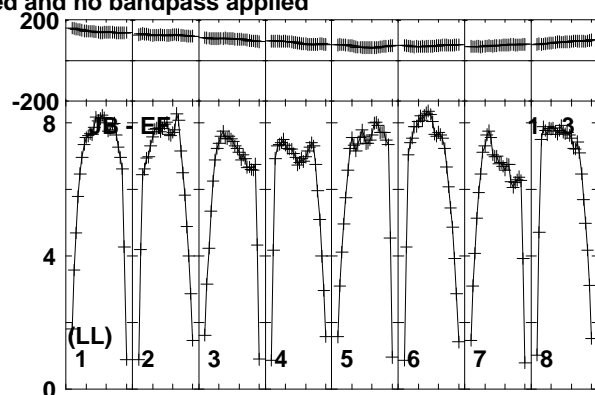
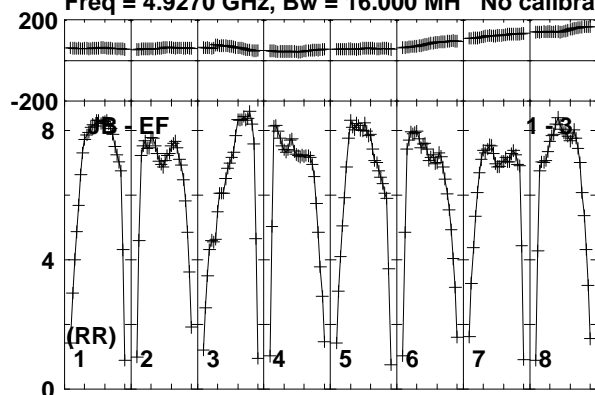

Lower frame: Milli Ampl Jy Top frame: Phas deg  
Vector averaged cross-power spectrum Baseline: JB (01) - EF (03)  
Timerange: 00/18:33:31 to 00/18:34:29

Plot file version 983 created 19-DEC-2018 17:59:15

J1619+2247 RY007C.UVDATA.1

Freq = 4.9270 GHz, Bw = 16.000 MH No calibration applied and no bandpass applied

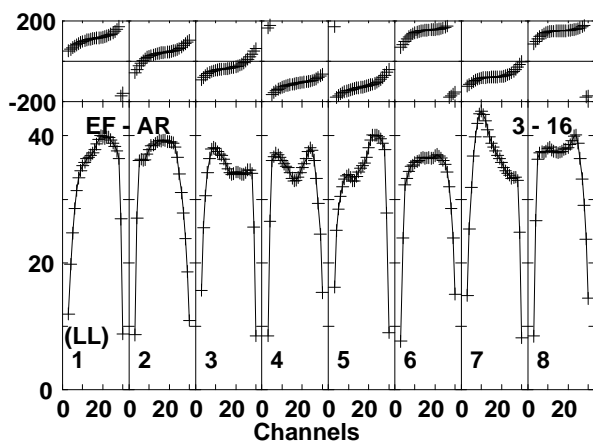
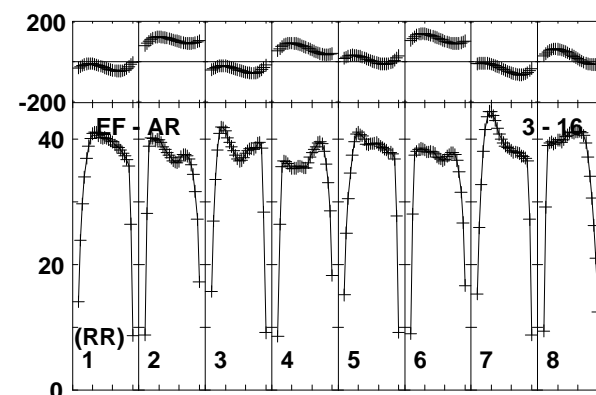
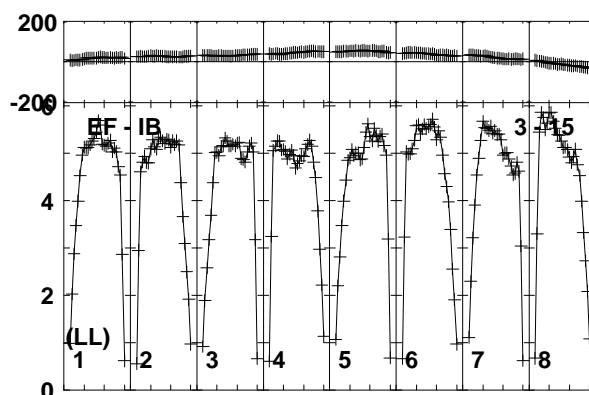
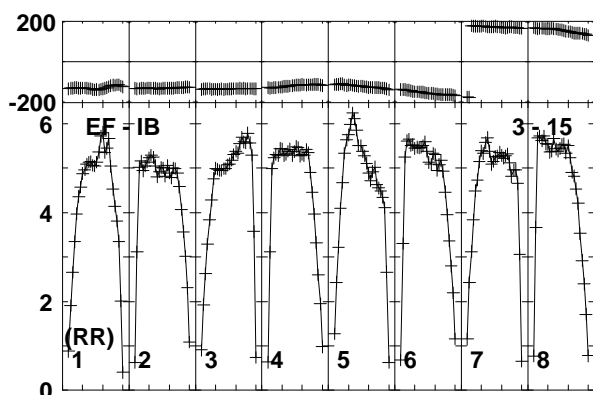
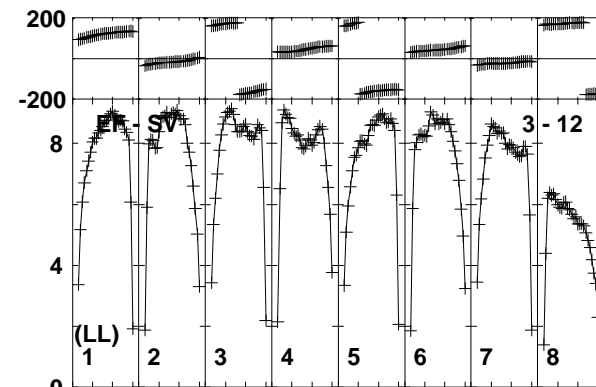
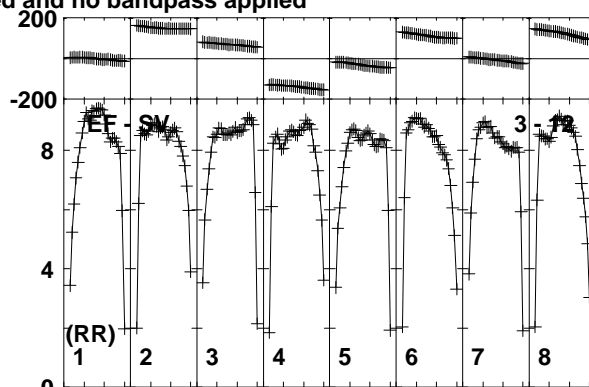
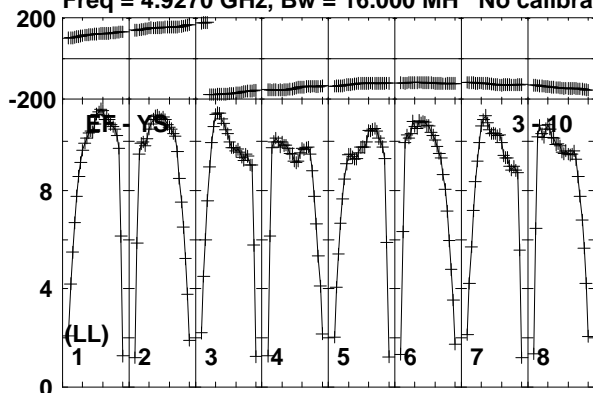

Lower frame: Milli Ampl Jy Top frame: Phas deg  
Vector averaged cross-power spectrum Baseline: EF (03) - YS (10)  
Timerange: 00/18:33:31 to 00/18:34:29

Plot file version 984 created 19-DEC-2018 17:59:15  
AT2018\_RY007C.UVDATA.1

Freq = 4.9270 GHz, Bw = 16.000 MH No calibration applied and no bandpass applied

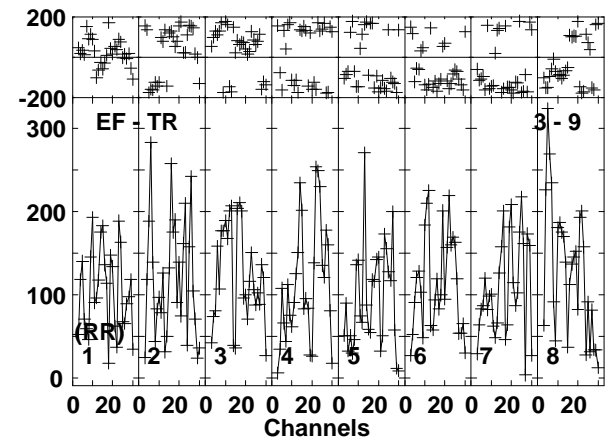
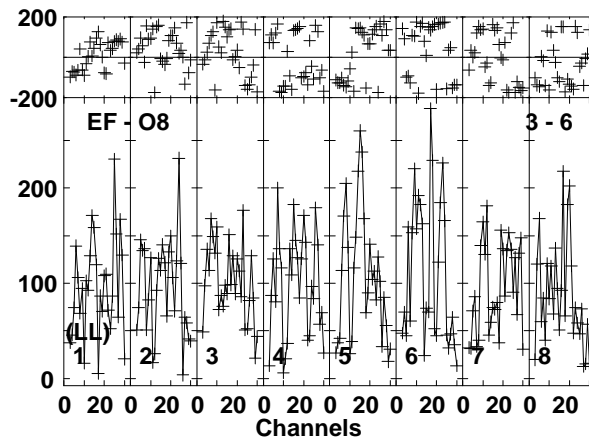
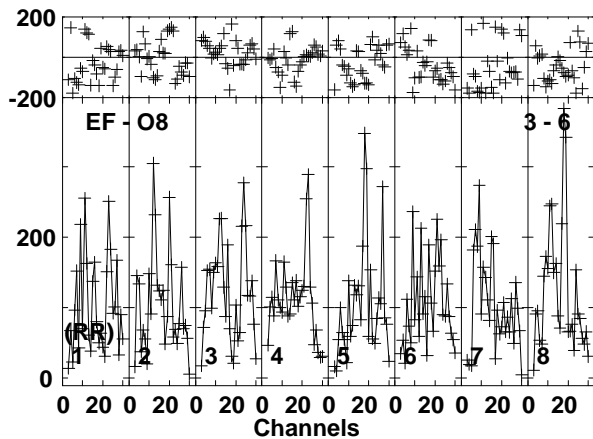
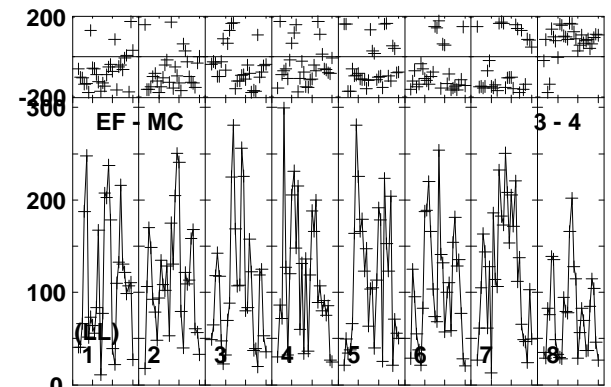
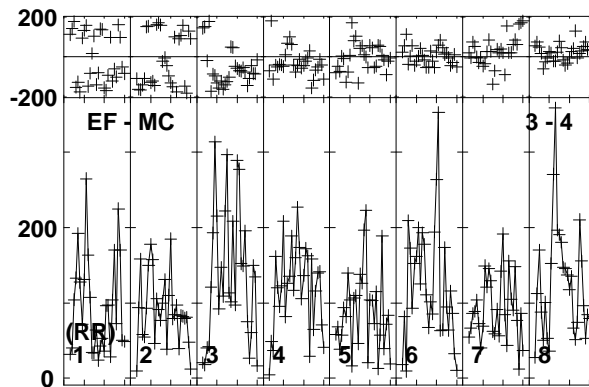
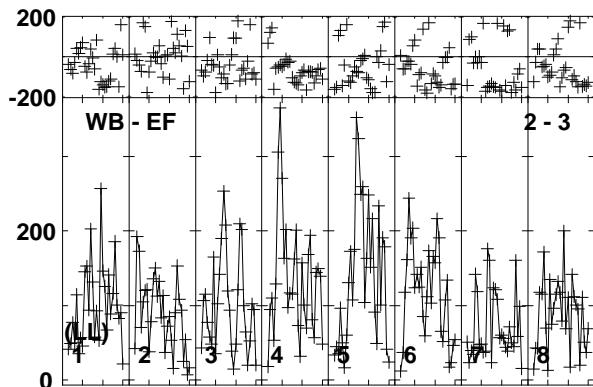
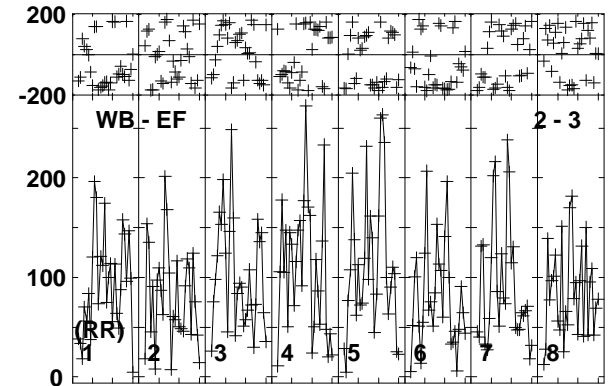
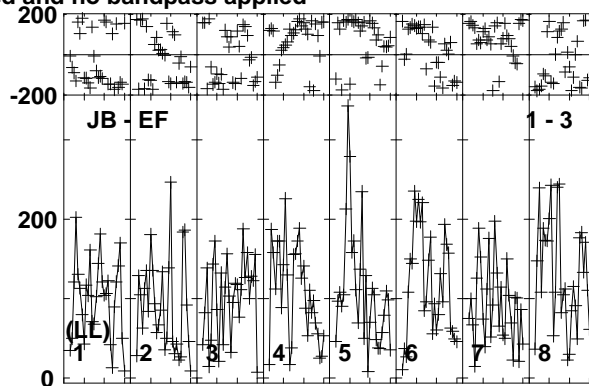
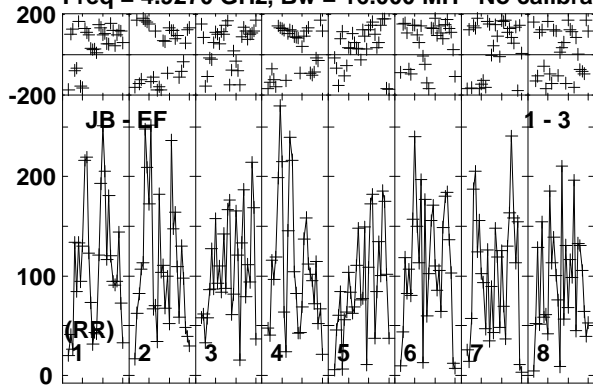

Lower frame: Micro Ampl Jy Top frame: Phas deg  
Vector averaged cross-power spectrum Baseline: JB (01) - EF (03)  
Timerange: 00/18:34:31 to 00/18:37:29

Plot file version 985 created 19-DEC-2018 17:59:15

AT2018\_RY007C.UVDATA.1

Freq = 4.9270 GHz, Bw = 16.000 MH No calibration applied and no bandpass applied

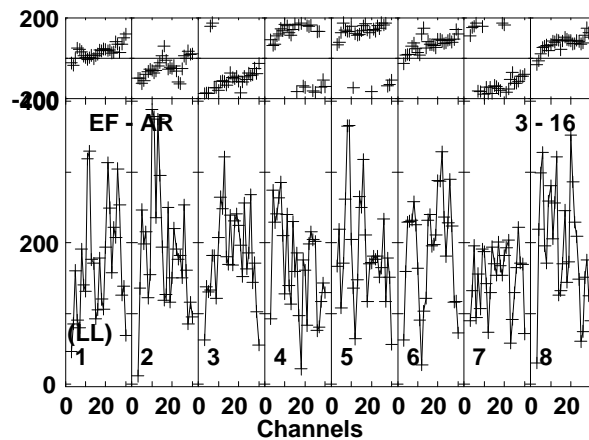
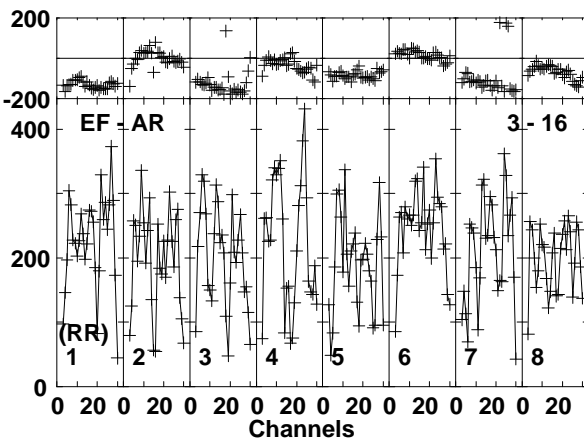
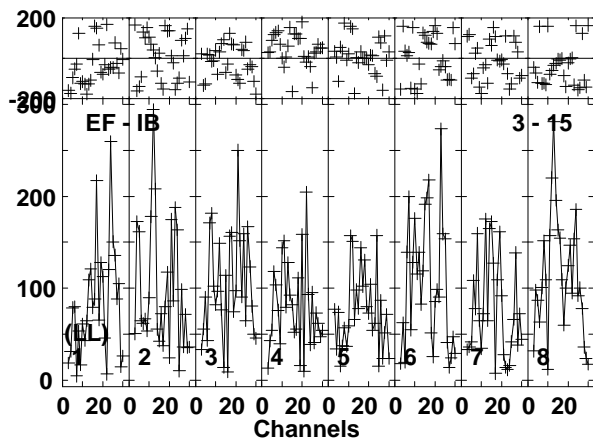
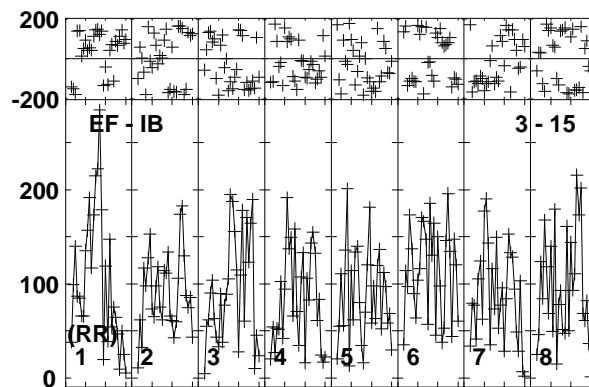
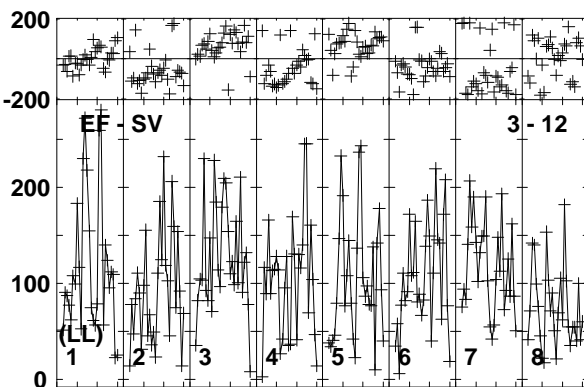
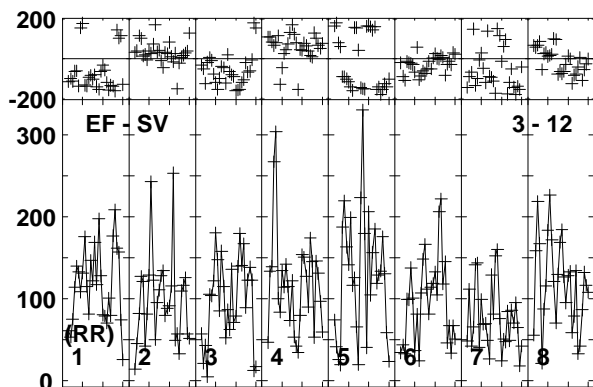
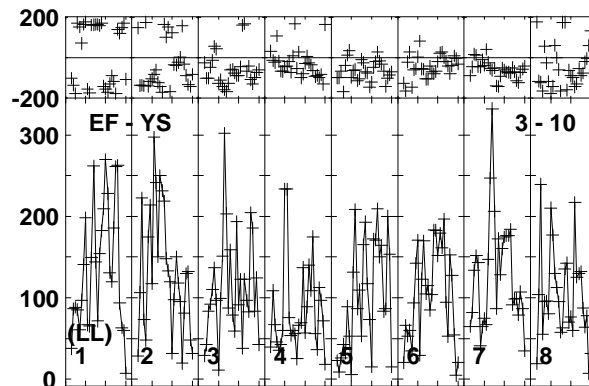
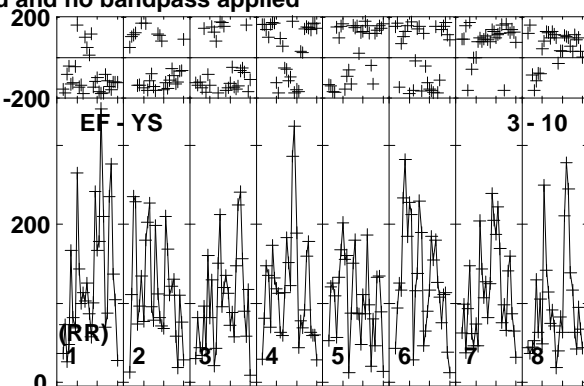
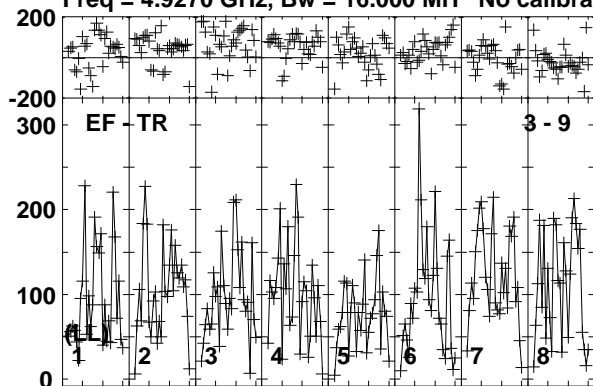

Lower frame: Micro Ampl Jy Top frame: Phas deg  
Vector averaged cross-power spectrum Baseline: EF (03) - TR (09)  
Timerange: 00/18:34:31 to 00/18:37:29

Plot file version 986 created 19-DEC-2018 17:59:16

J1619+2247 RY007C.UVDATA.1

Freq = 4.9270 GHz, Bw = 16.000 MH No calibration applied and no bandpass applied

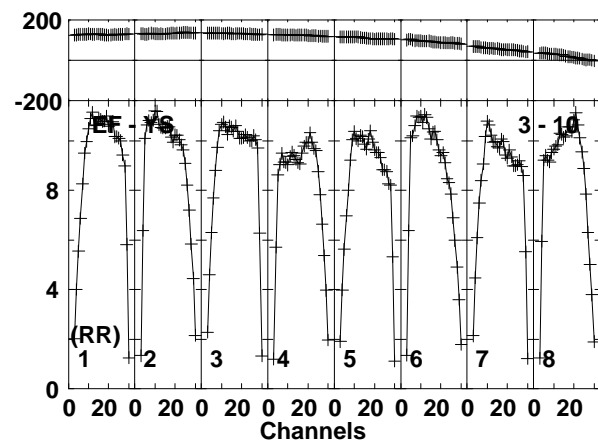
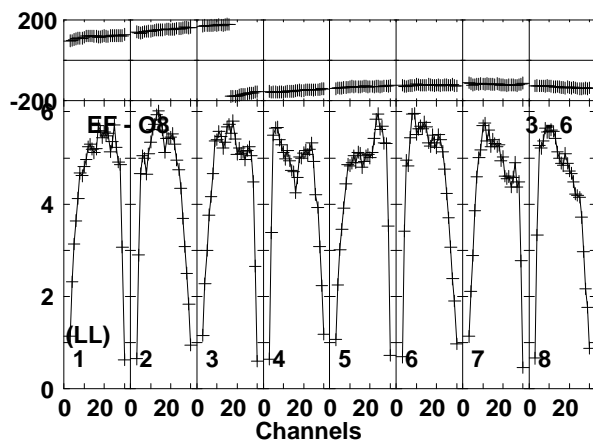
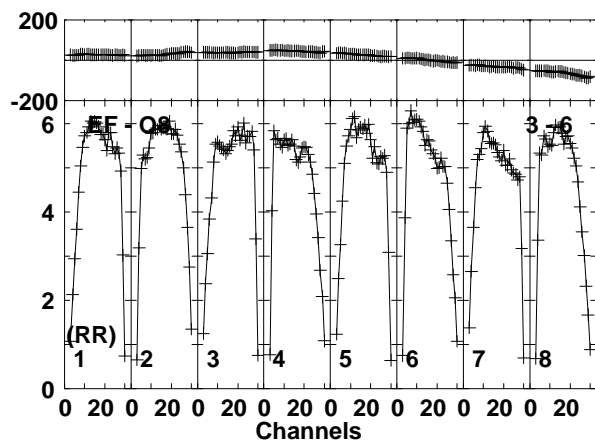
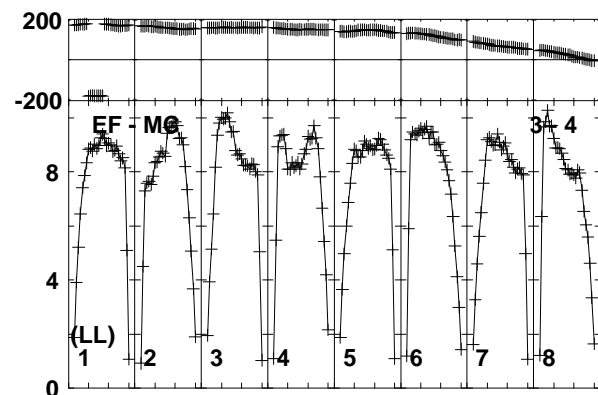
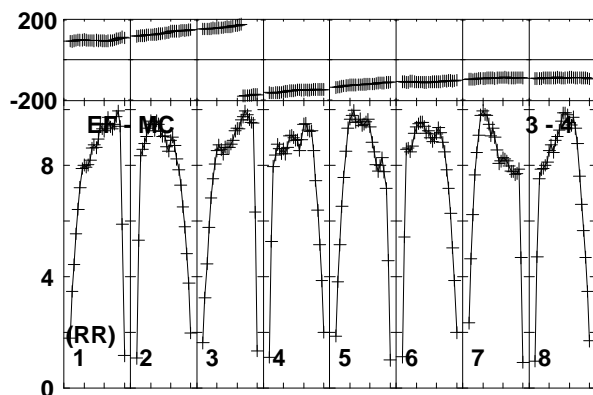
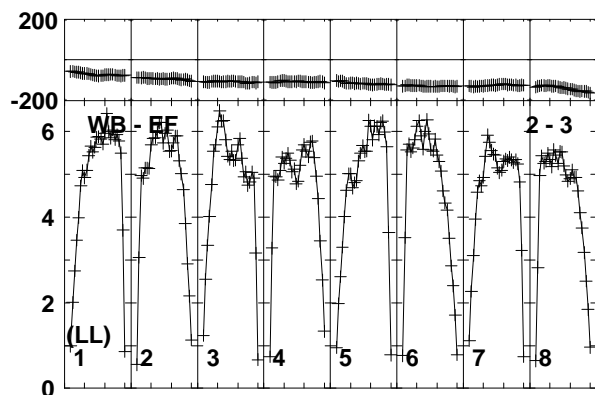
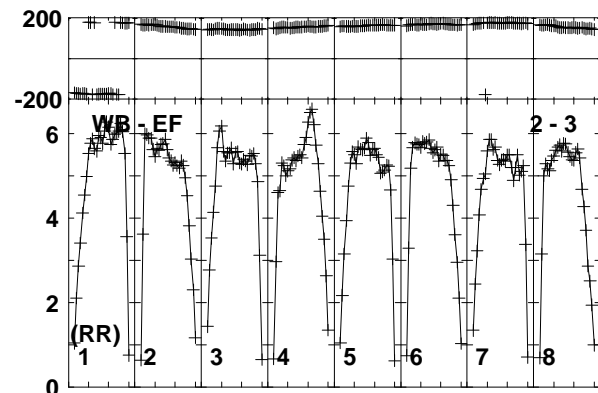
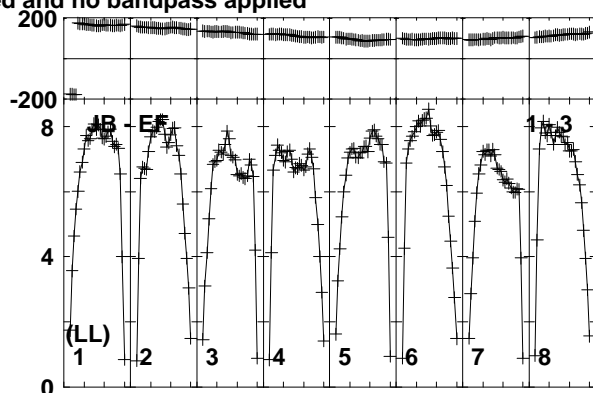
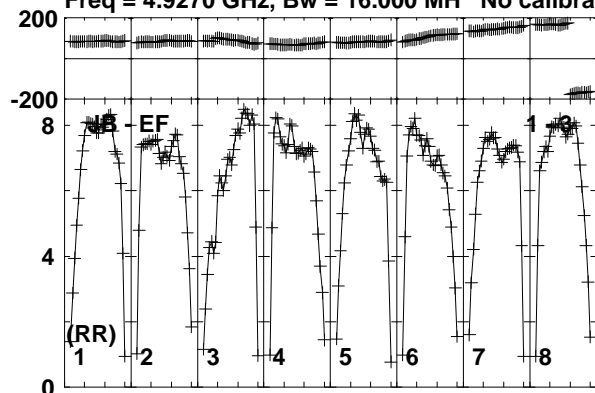

Lower frame: Milli Ampl Jy Top frame: Phas deg  
Vector averaged cross-power spectrum Baseline: JB (01) - EF (03)  
Timerange: 00/18:37:31 to 00/18:38:29



Plot file version 987 created 19-DEC-2018 17:59:16

J1619+2247 RY007C.UVDATA.1

Freq = 4.9270 GHz, Bw = 16.000 MH No calibration applied and no bandpass applied

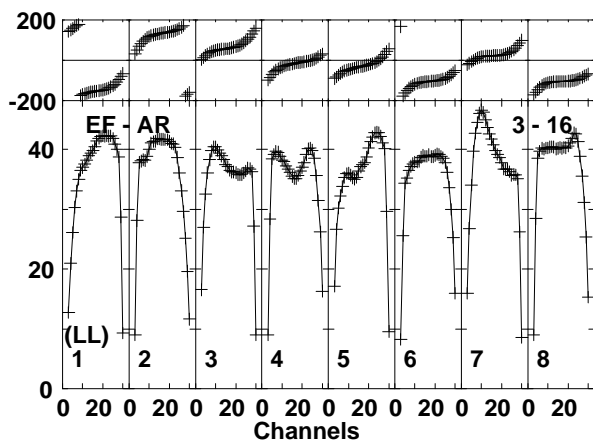
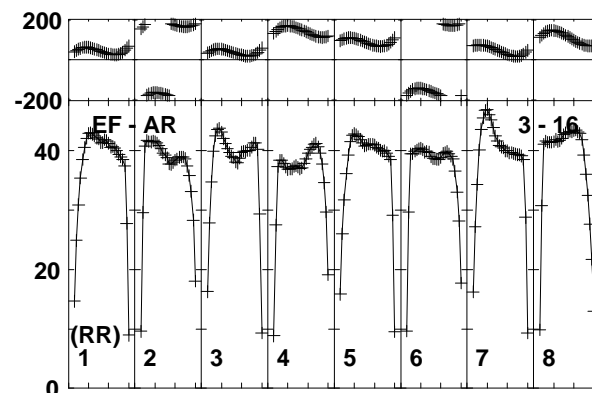
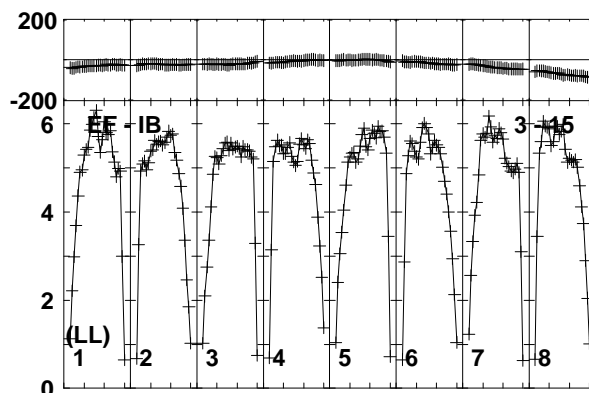
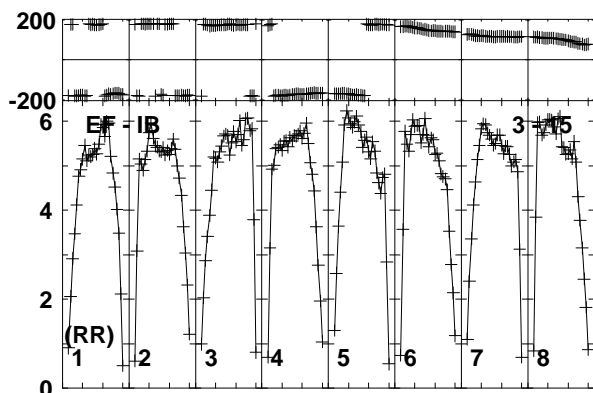
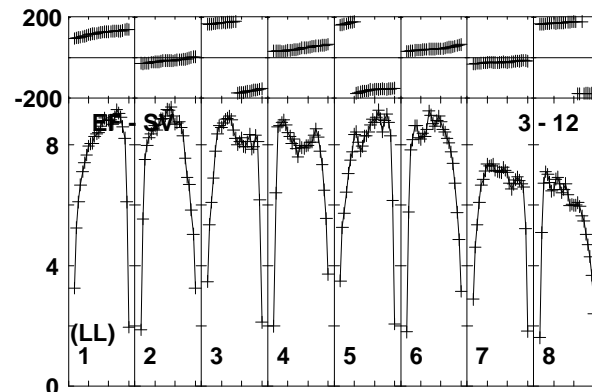
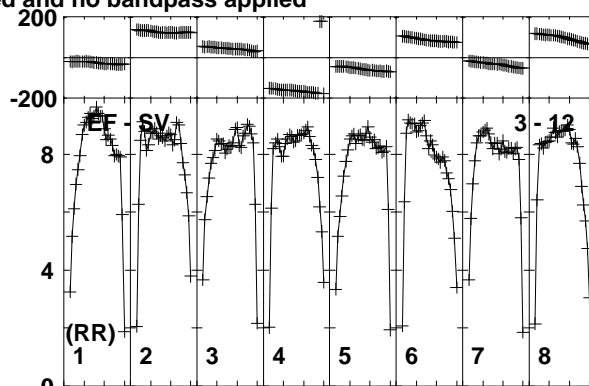
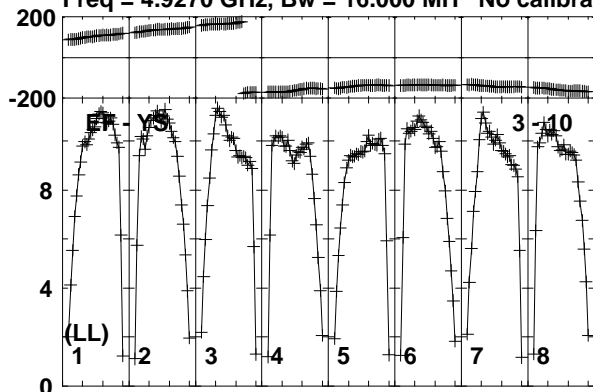

Lower frame: Milli Ampl Jy Top frame: Phas deg  
Vector averaged cross-power spectrum Baseline: EF (03) - YS (10)  
Timerange: 00/18:37:31 to 00/18:38:29

Plot file version 988 created 19-DEC-2018 17:59:16

AT2018\_RY007C.UVDATA.1

Freq = 4.9270 GHz, Bw = 16.000 MH No calibration applied and no bandpass applied

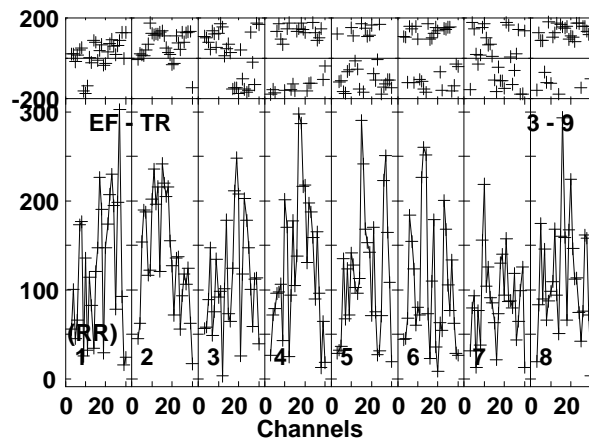
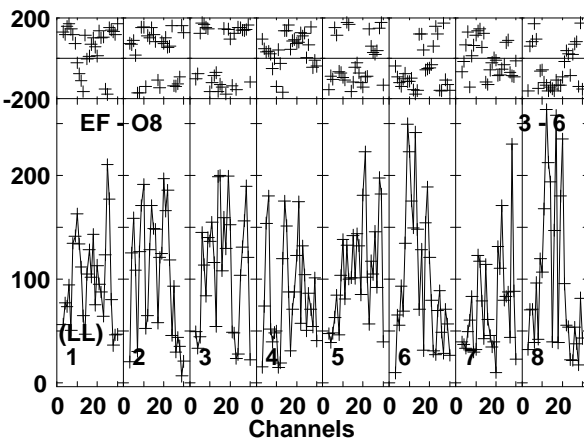
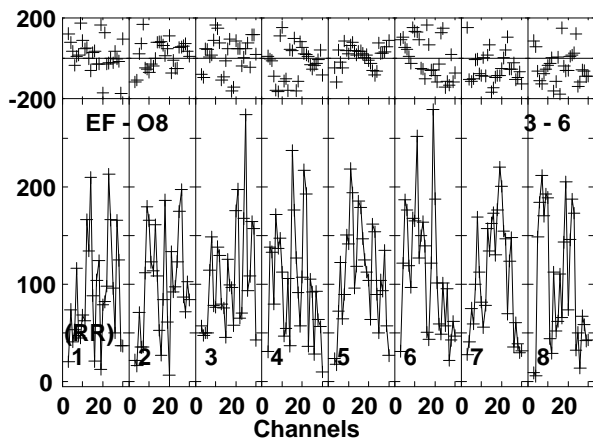
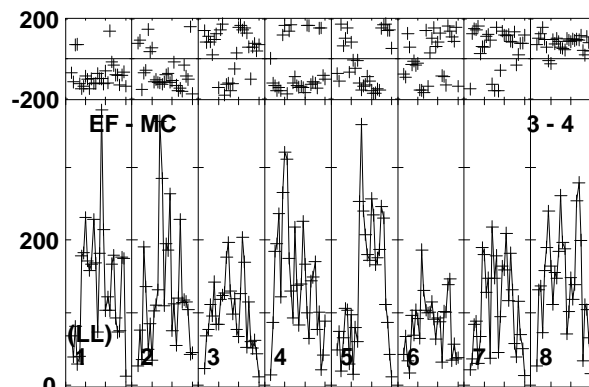
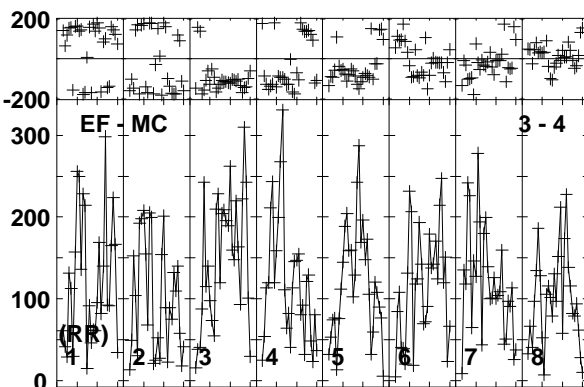
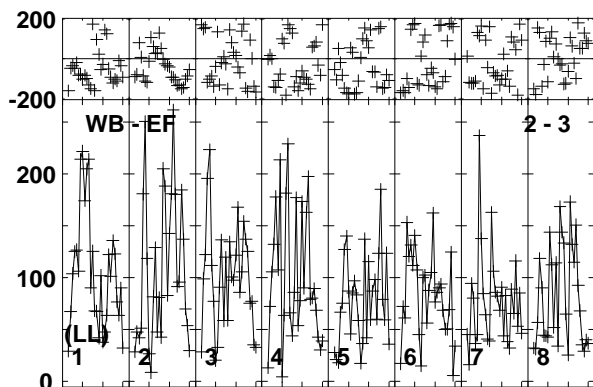
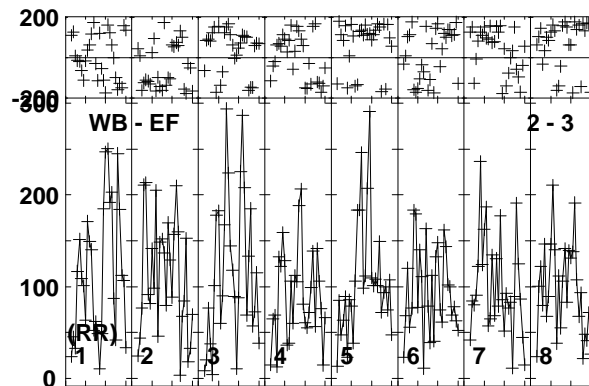
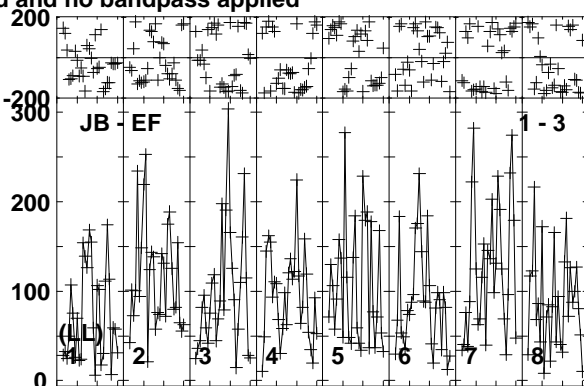
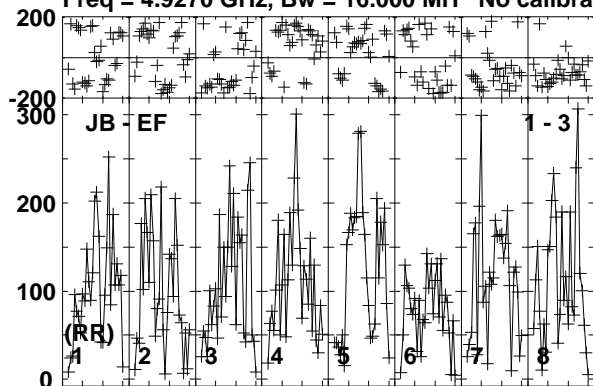

Lower frame: Micro Ampl Jy Top frame: Phas deg  
Vector averaged cross-power spectrum Baseline: JB (01) - EF (03)  
Timerange: 00:18:38:31 to 00:18:41:29

Plot file version 989 created 19-DEC-2018 17:59:16  
AT2018\_RY007C.UVDATA.1

Freq = 4.9270 GHz, Bw = 16.000 MH No calibration applied and no bandpass applied

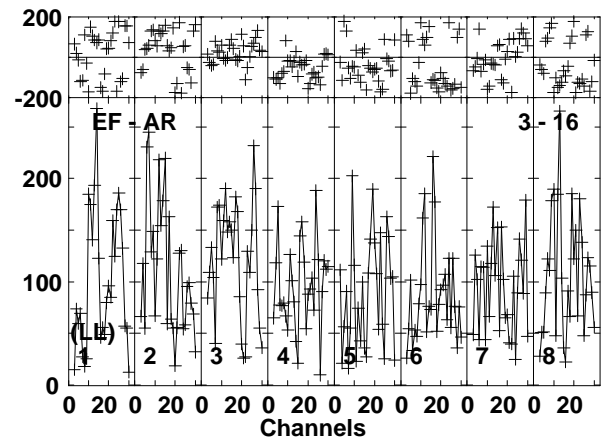
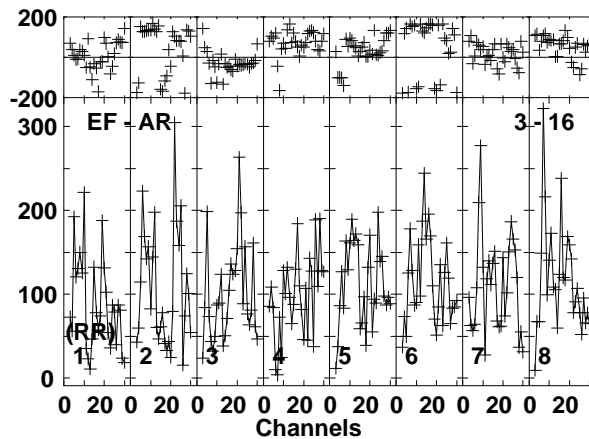
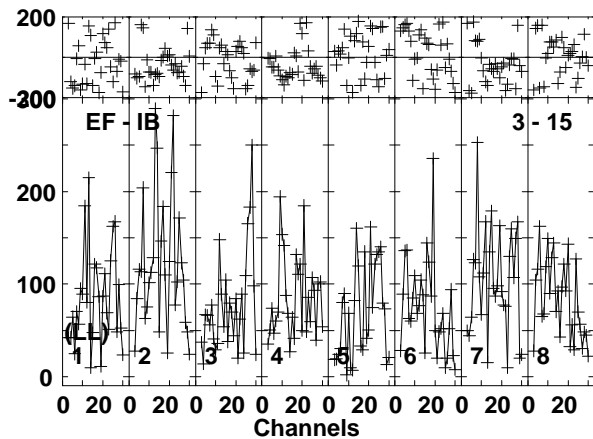
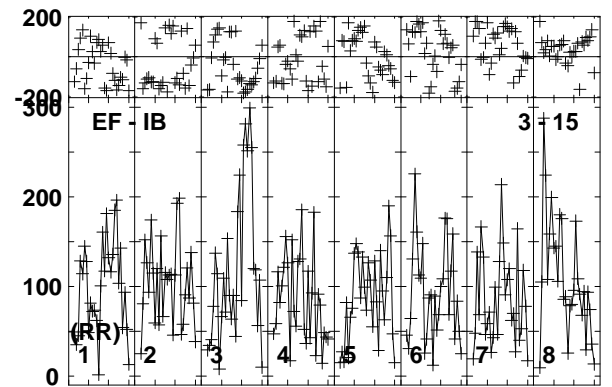
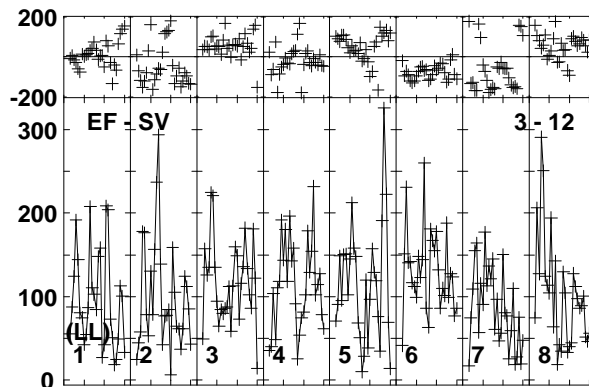
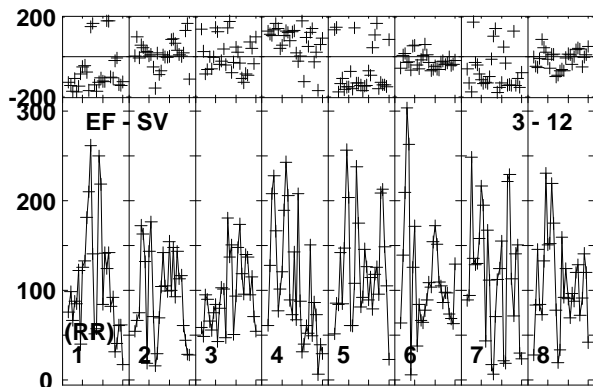
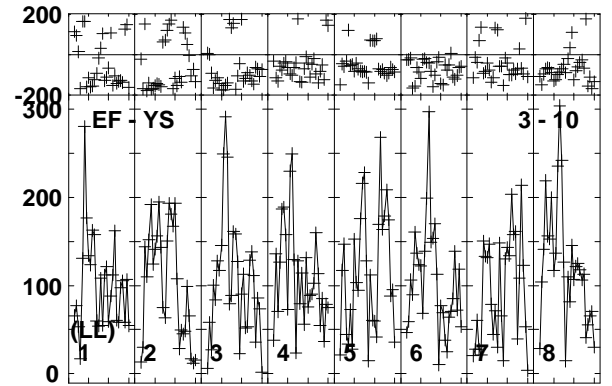
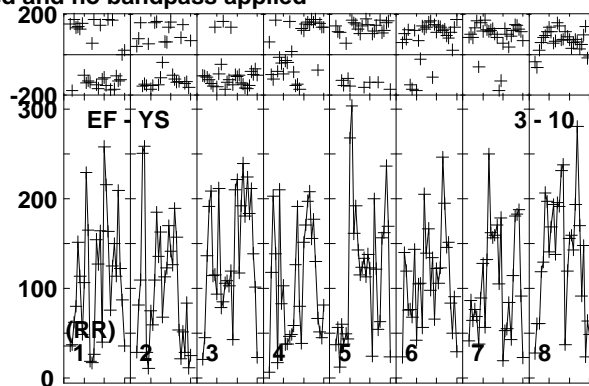
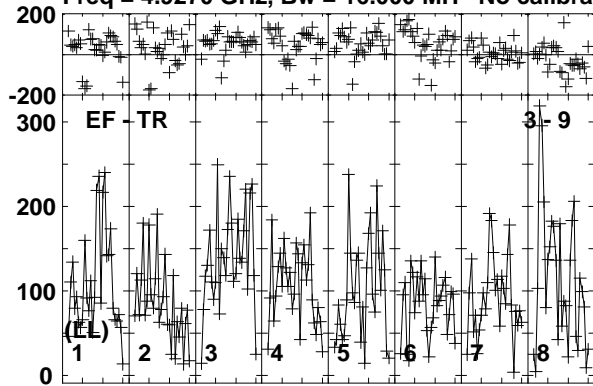

Lower frame: Micro Ampl Jy Top frame: Phas deg  
Vector averaged cross-power spectrum Baseline: EF (03) - TR (09)  
Timerange: 00:18:38:31 to 00:18:41:29

Plot file version 990 created 19-DEC-2018 17:59:16

J1619+2247 RY007C.UVDATA.1

Freq = 4.9270 GHz, Bw = 16.000 MH No calibration applied and no bandpass applied

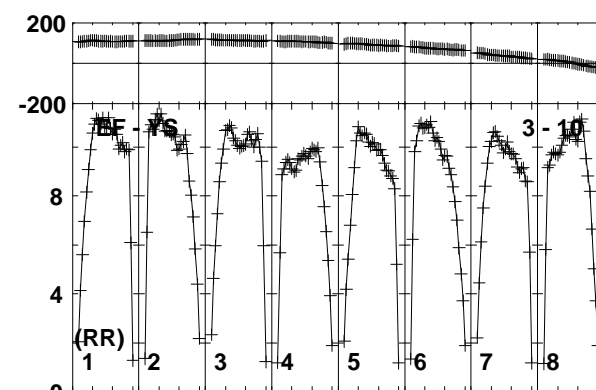
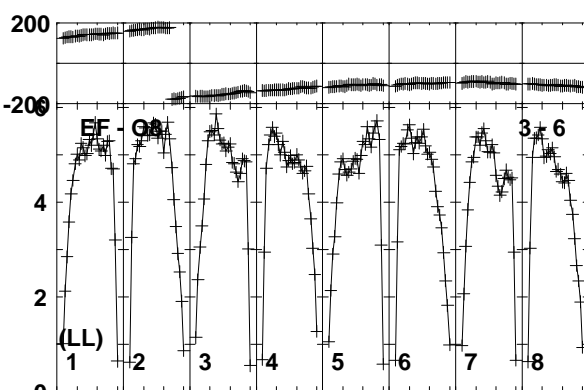
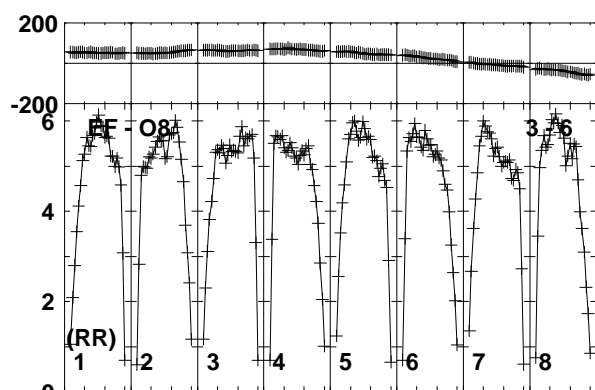
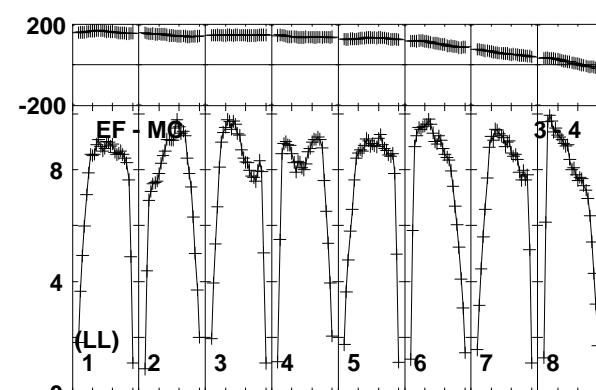
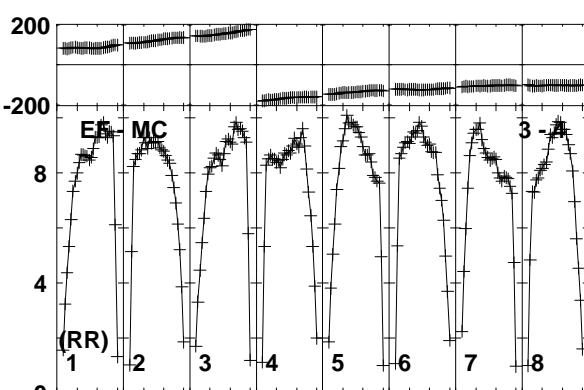
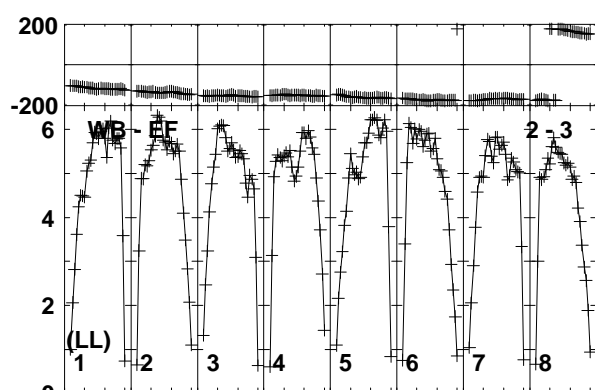
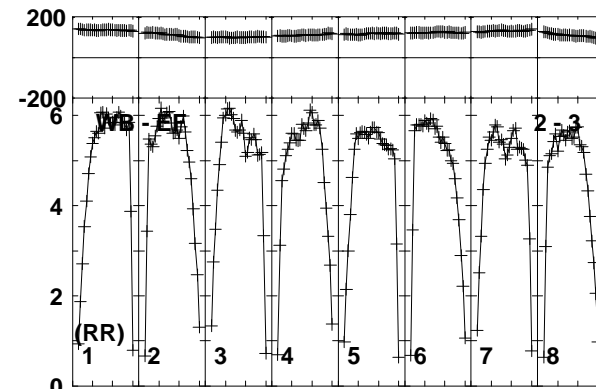
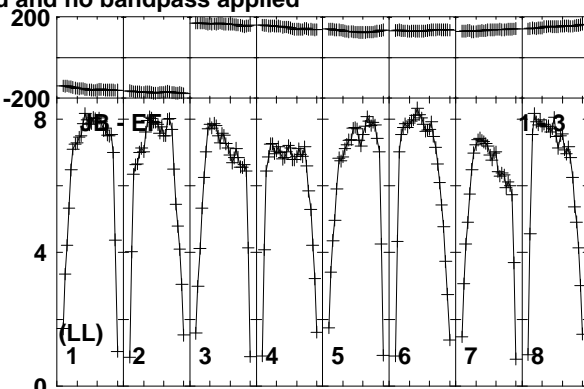
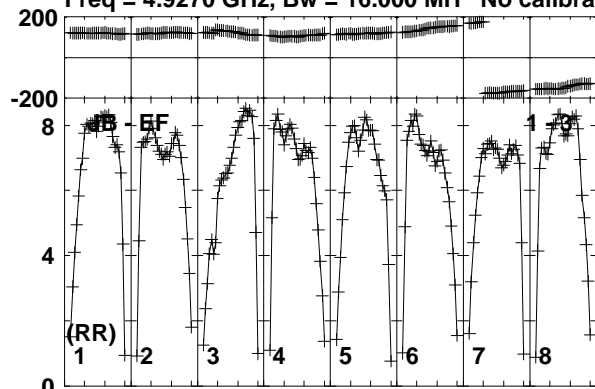

Lower frame: Milli Ampl Jy Top frame: Phas deg  
Vector averaged cross-power spectrum Baseline: JB (01) - EF (03)  
Timerange: 00/18:41:31 to 00/18:42:29

Plot file version 991 created 19-DEC-2018 17:59:16

J1619+2247 RY007C.UVDATA.1

Freq = 4.9270 GHz, Bw = 16.000 MH No calibration applied and no bandpass applied

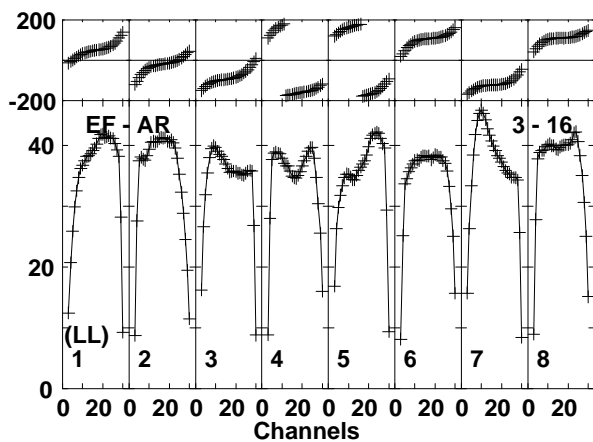
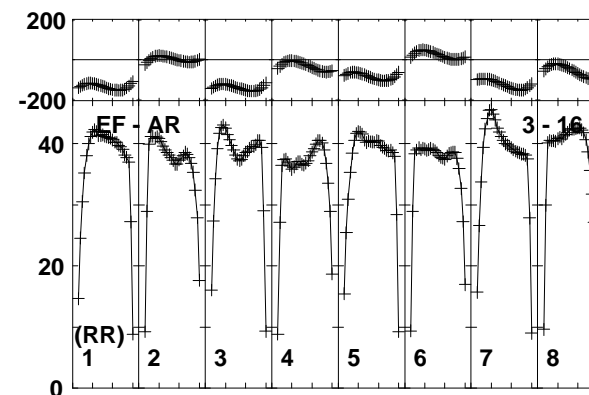
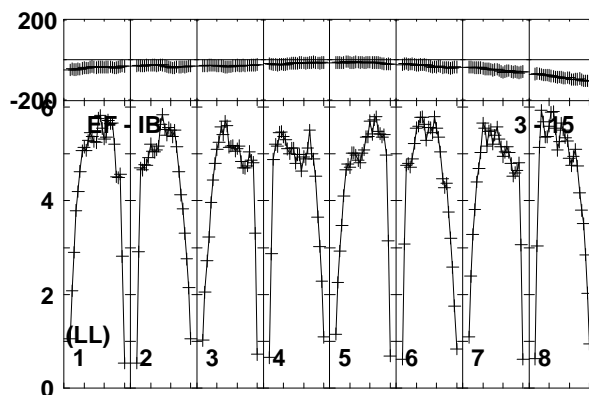
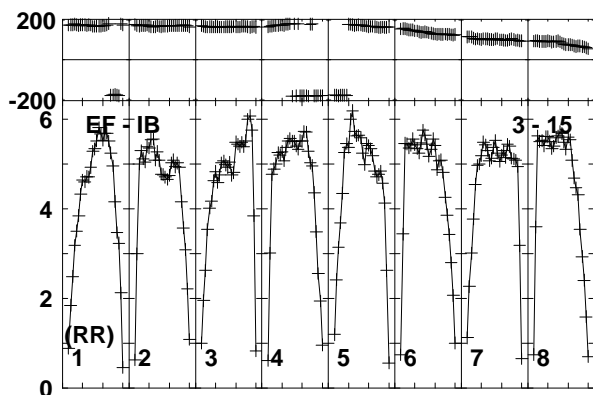
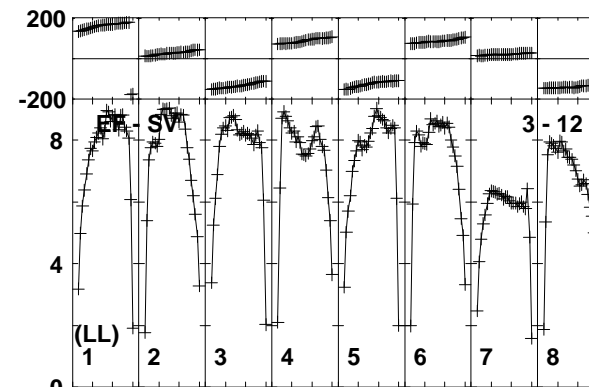
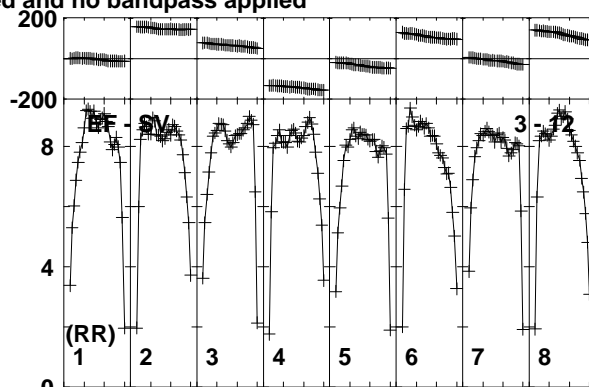
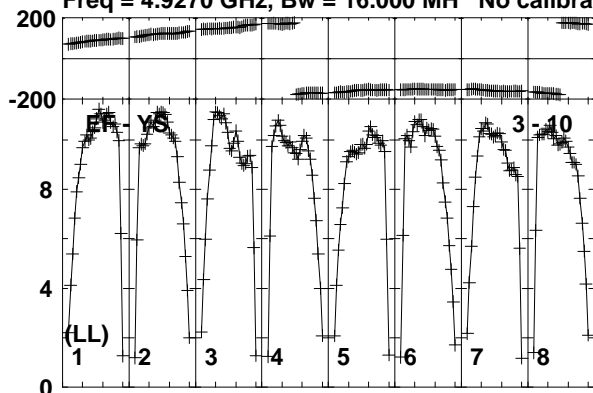

Lower frame: Milli Ampl Jy Top frame: Phas deg  
Vector averaged cross-power spectrum Baseline: EF (03) - YS (10)  
Timerange: 00/18:41:31 to 00/18:42:29

Plot file version 992 created 19-DEC-2018 17:59:16

VLA1 RY007C.UVDATA.1

Freq = 4.9270 GHz, Bw = 16.000 MH No calibration applied and no bandpass applied

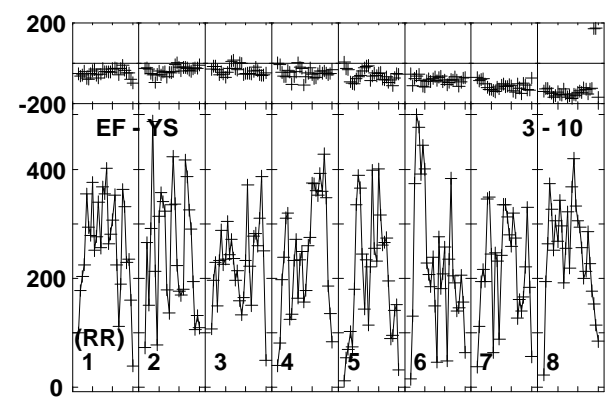
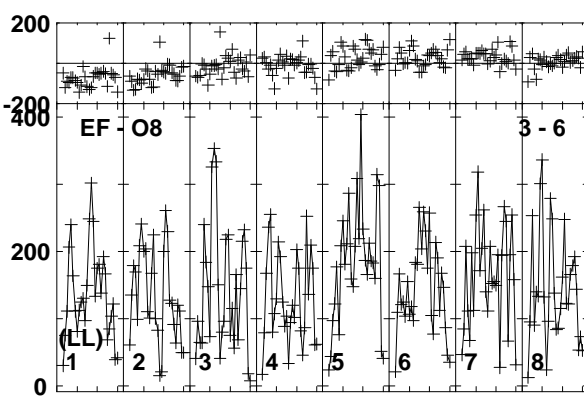
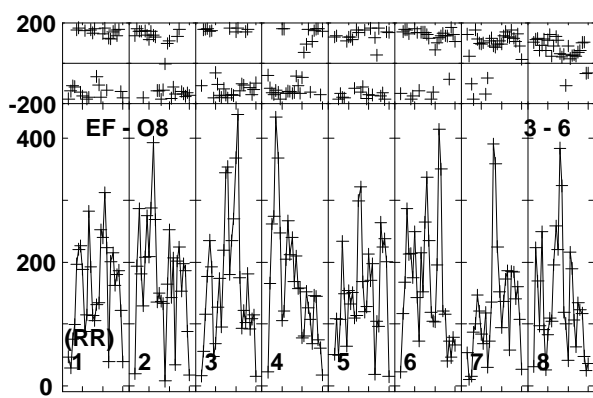
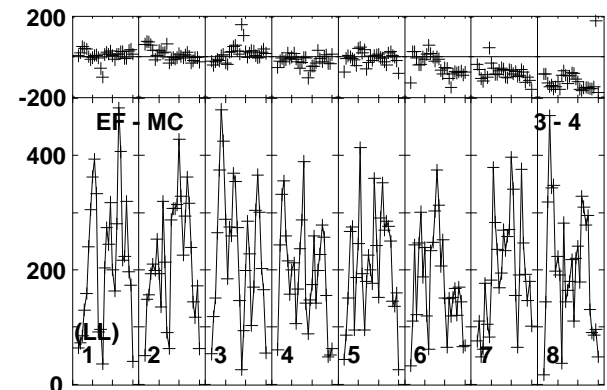
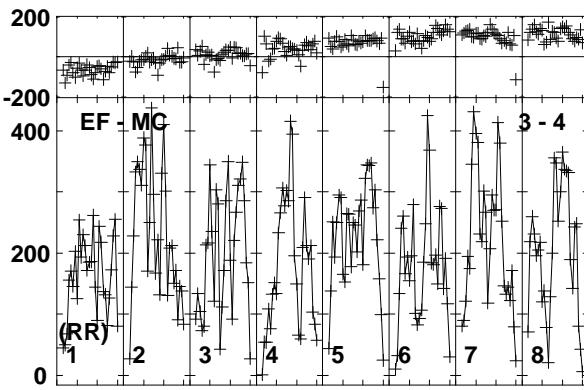
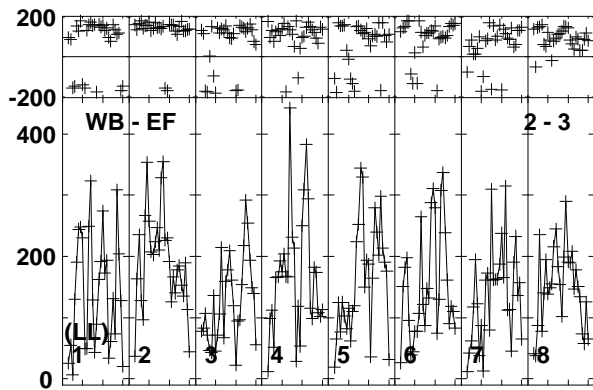
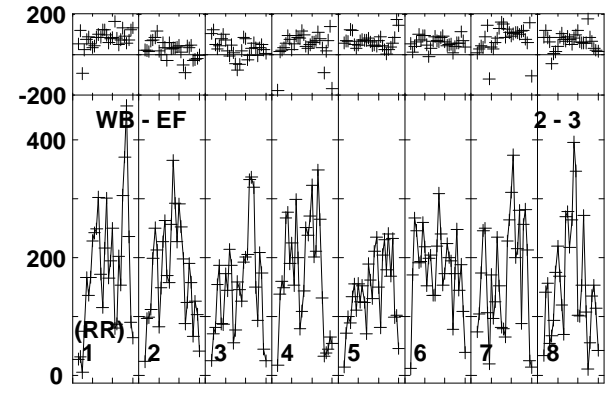
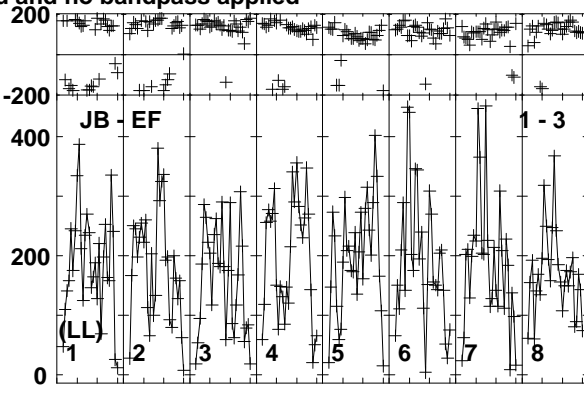
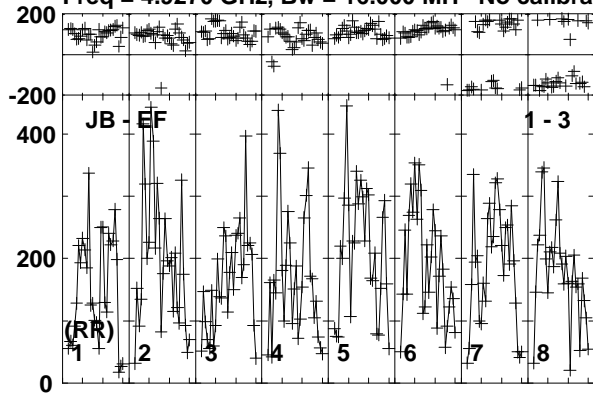

Lower frame: Micro Ampl Jy Top frame: Phas deg  
Vector averaged cross-power spectrum Baseline: JB (01) - EF (03)  
Timerange: 00/18:43:01 to 00/18:44:59

Plot file version 993 created 19-DEC-2018 17:59:16

VLA1 RY007C.UVDATA.1

Freq = 4.9270 GHz, Bw = 16.000 MH No calibration applied and no bandpass applied

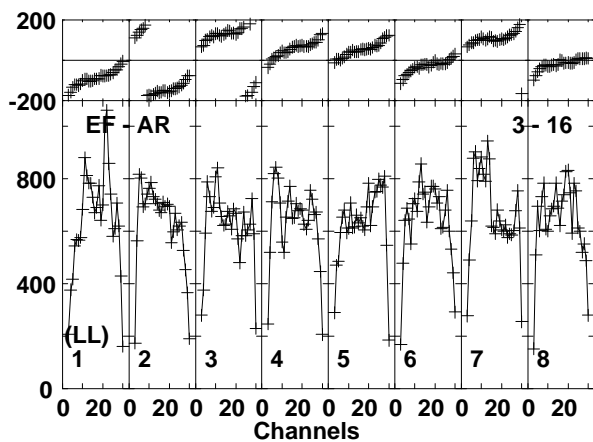
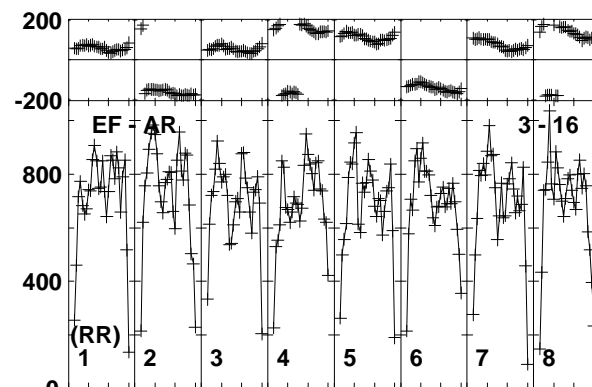
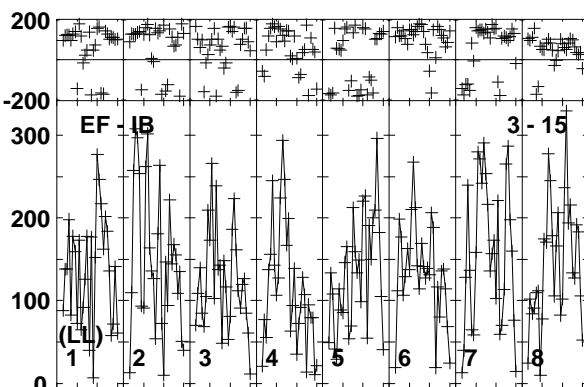
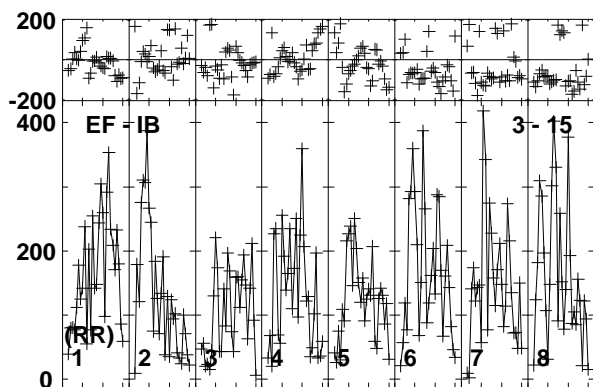
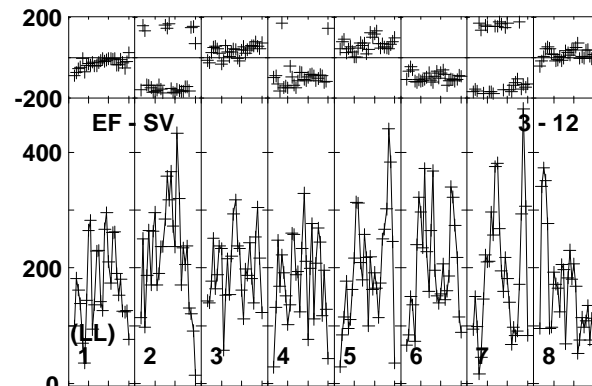
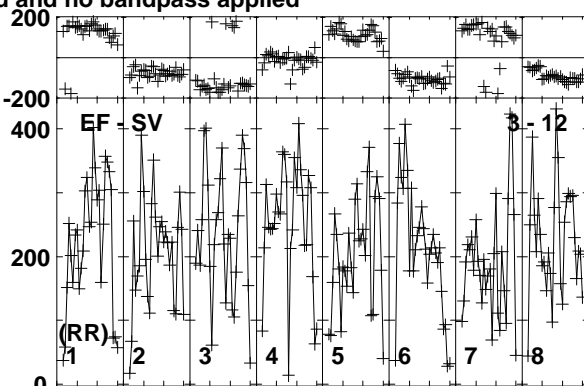
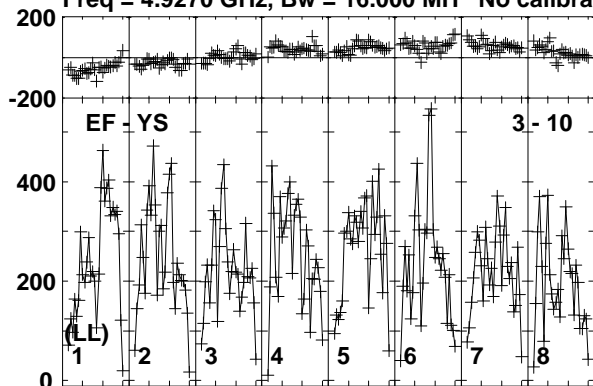

Lower frame: Micro Ampl Jy Top frame: Phas deg  
Vector averaged cross-power spectrum Baseline: EF (03) - YS (10)  
Timerange: 00/18:43:01 to 00/18:44:59

Plot file version 994 created 19-DEC-2018 17:59:16

J1619+2247 RY007C.UVDATA.1

Freq = 4.9270 GHz, Bw = 16.000 MH No calibration applied and no bandpass applied

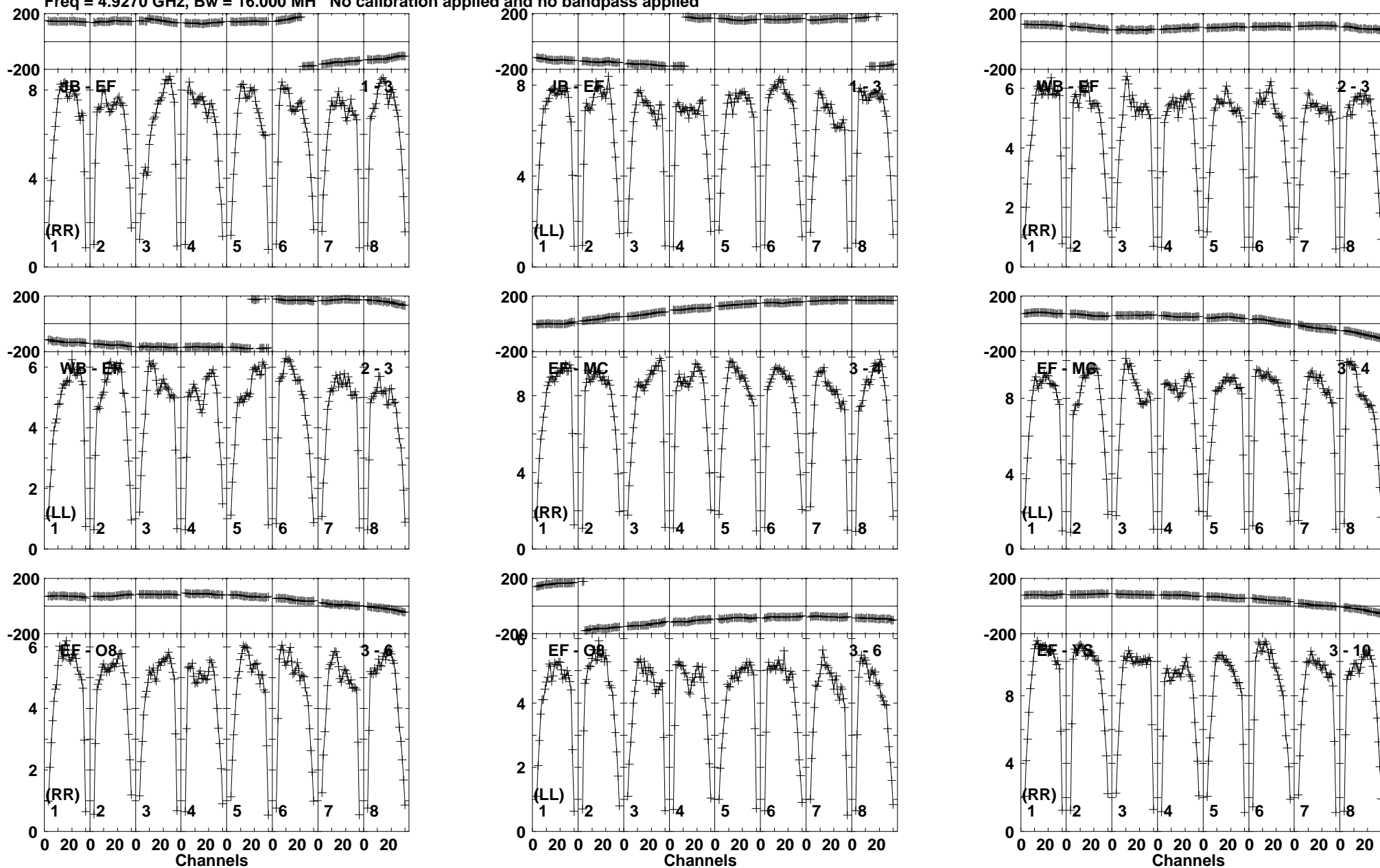

Lower frame: Milli Ampl Jy Top frame: Phas deg  
Vector averaged cross-power spectrum Baseline: JB (01) - EF (03)  
Timerange: 00:18:45:01 to 00:18:45:59



Plot file version 995 created 19-DEC-2018 17:59:16

J1619+2247 RY007C.UVDATA.1

Freq = 4.9270 GHz, Bw = 16.000 MH No calibration applied and no bandpass applied

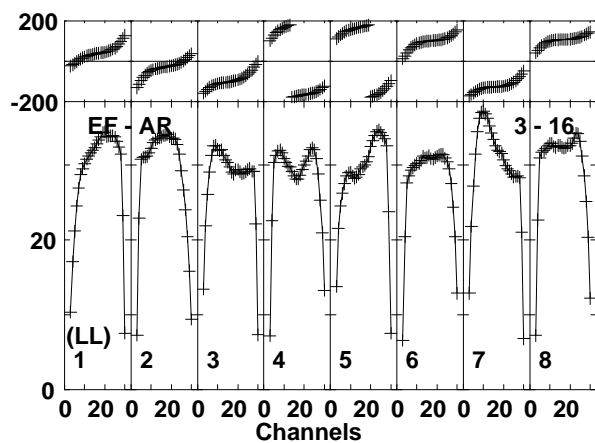
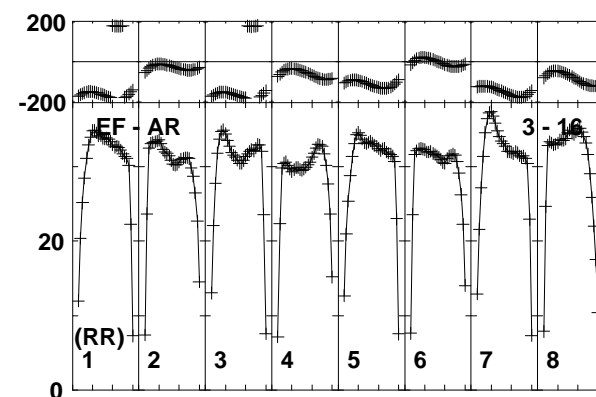
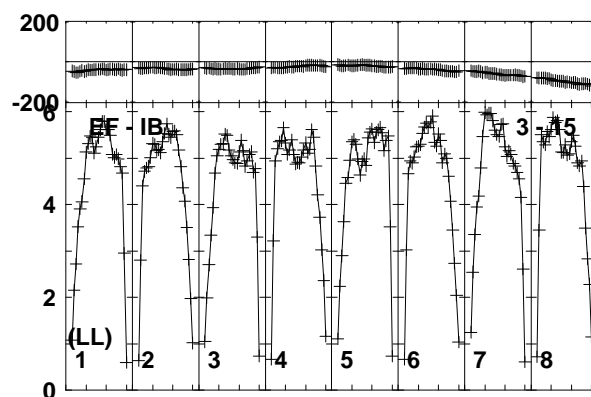
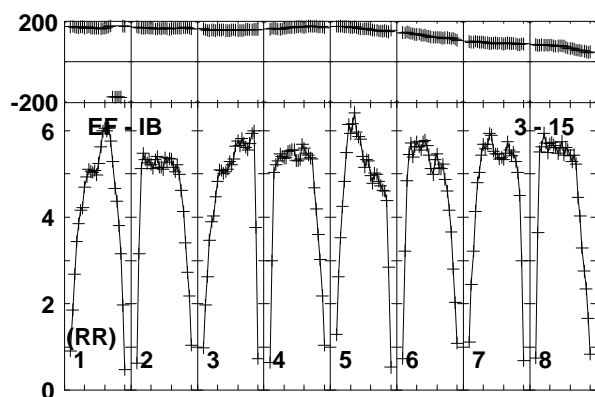
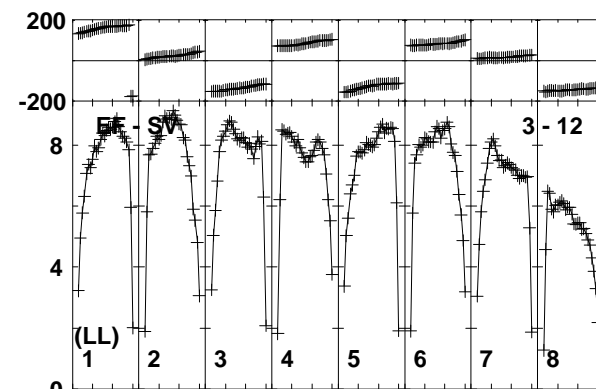
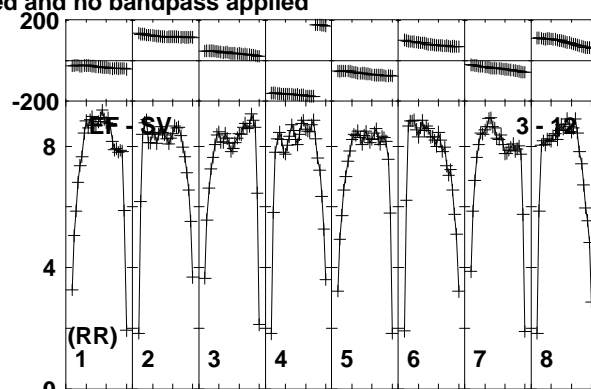
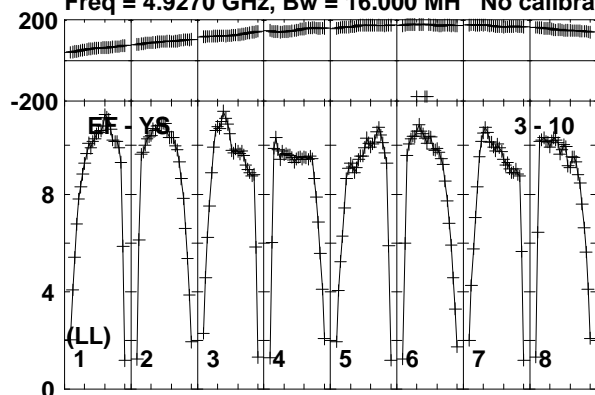

Lower frame: Milli Ampl Jy Top frame: Phas deg  
Vector averaged cross-power spectrum Baseline: EF (03) - YS (10)  
Timerange: 00/18:45:01 to 00/18:45:59

Plot file version 996 created 19-DEC-2018 17:59:16

AT2018\_RY007C.UVDATA.1

Freq = 4.9270 GHz, Bw = 16.000 MH No calibration applied and no bandpass applied

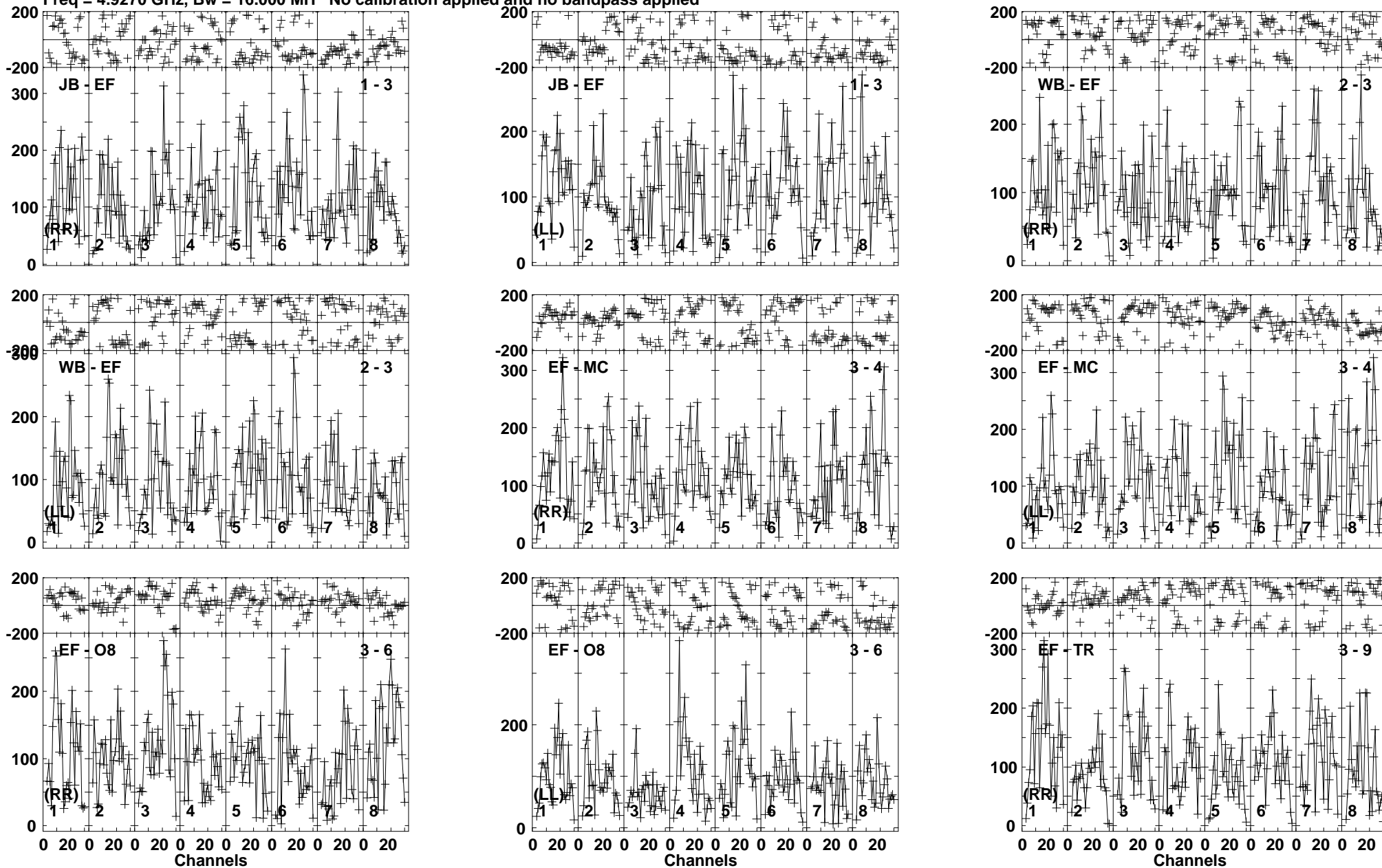

Lower frame: Micro Ampl Jy Top frame: Phas deg  
Vector averaged cross-power spectrum Baseline: JB (01) - EF (03)  
Timerange: 00/18:46:01 to 00/18:48:59

Plot file version 997 created 19-DEC-2018 17:59:16  
 AT2018\_RY007C.UVDATA.1

Freq = 4.9270 GHz, Bw = 16.000 MH No calibration applied and no bandpass applied

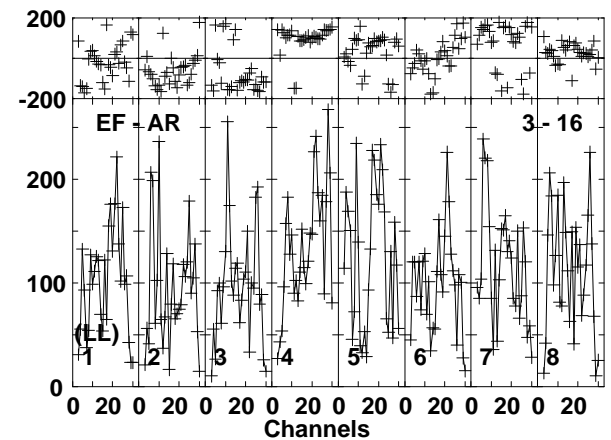
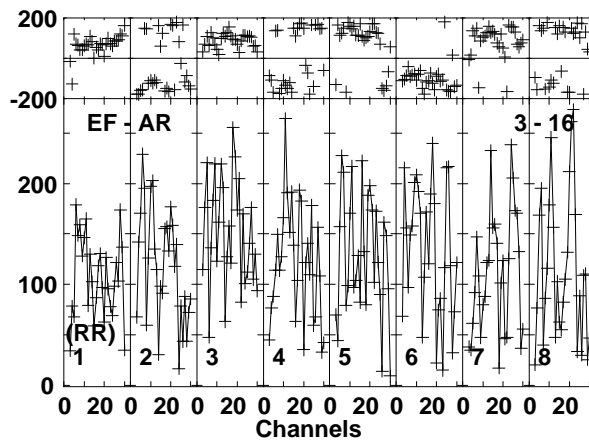
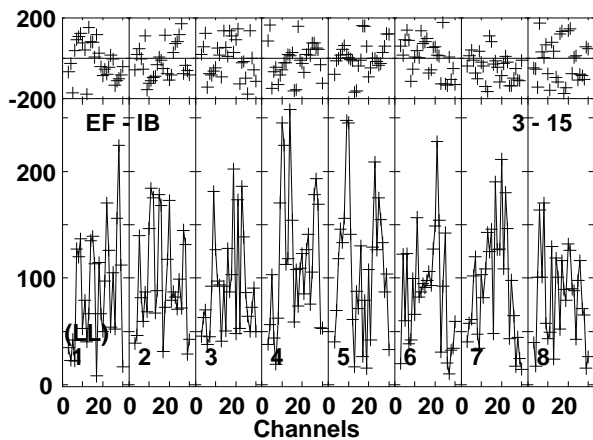
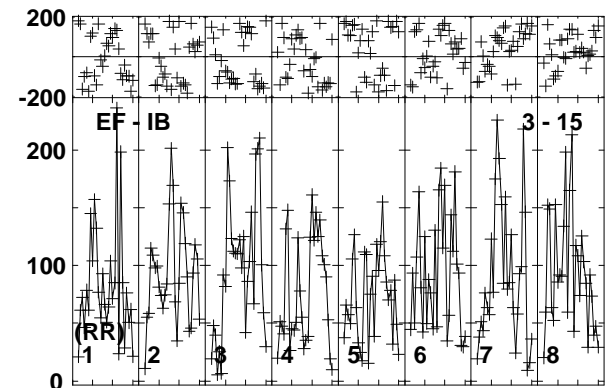
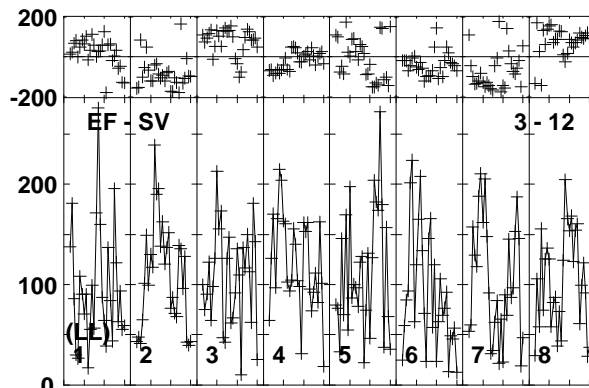
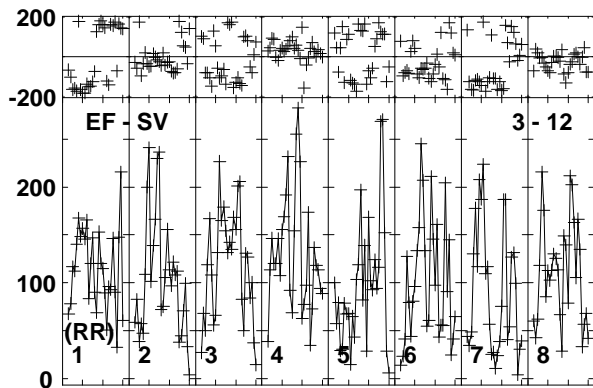
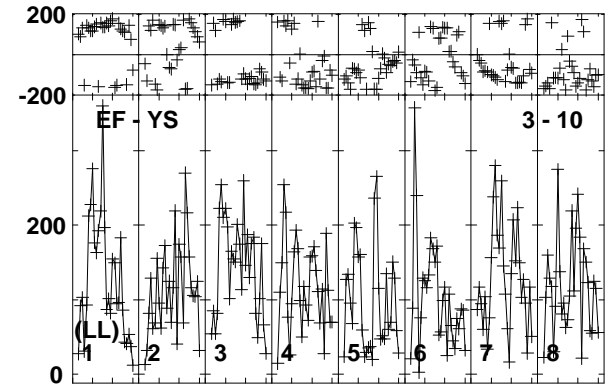
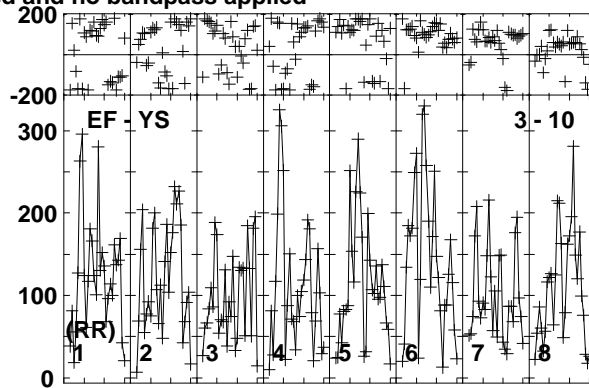
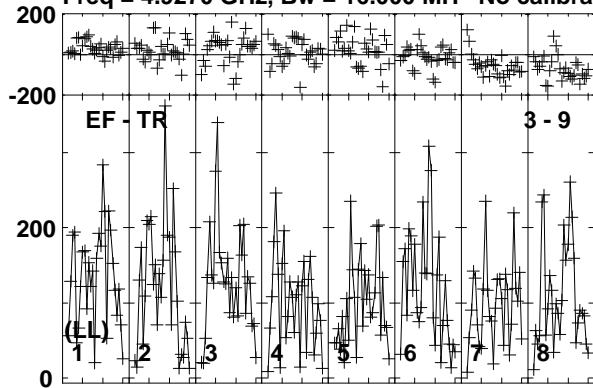

Lower frame: Micro Ampl Jy Top frame: Phas deg  
 Vector averaged cross-power spectrum Baseline: EF (03) - TR (09)  
 Timerange: 00:18:46:01 to 00:18:48:59

Plot file version 998 created 19-DEC-2018 17:59:16

J1619+2247 RY007C.UVDATA.1

Freq = 4.9270 GHz, Bw = 16.000 MH No calibration applied and no bandpass applied

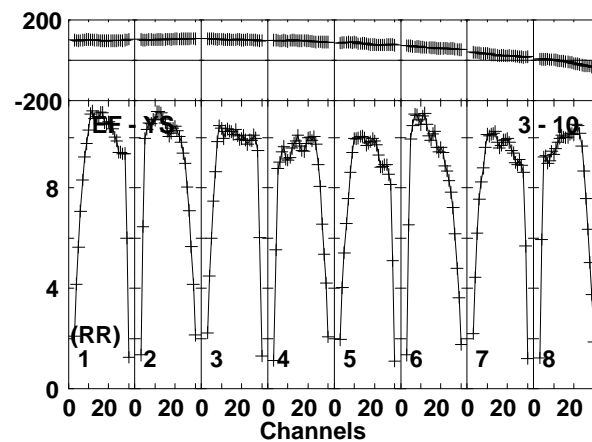
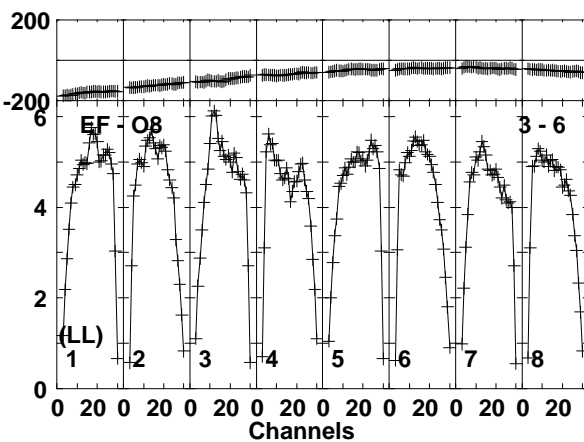
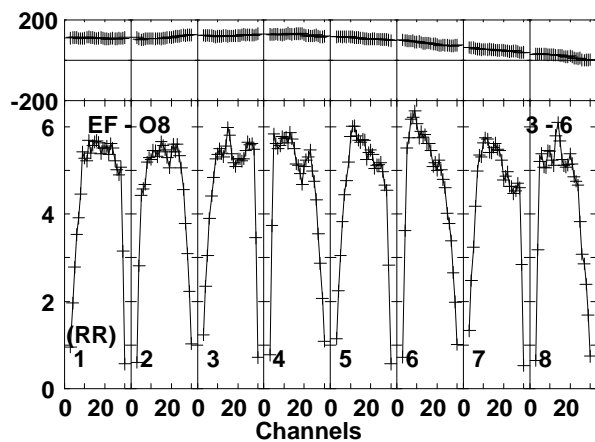
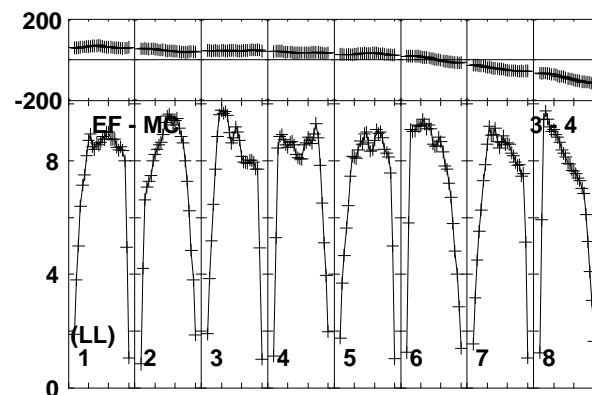
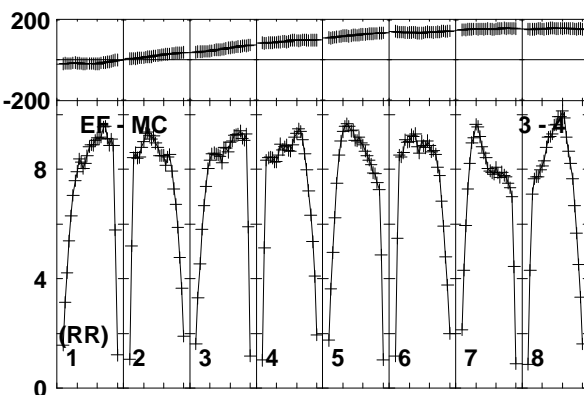
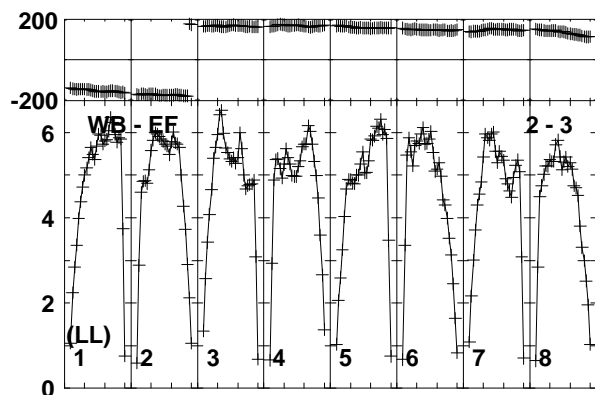
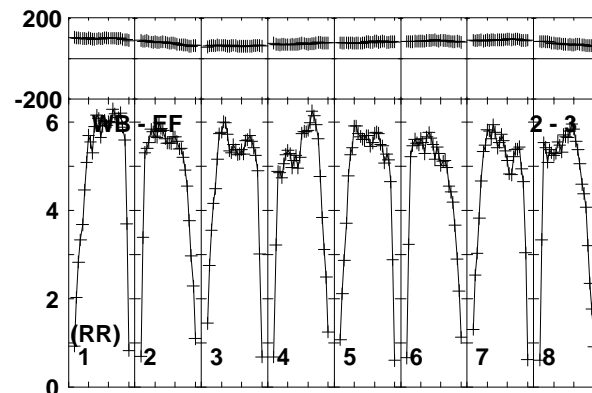
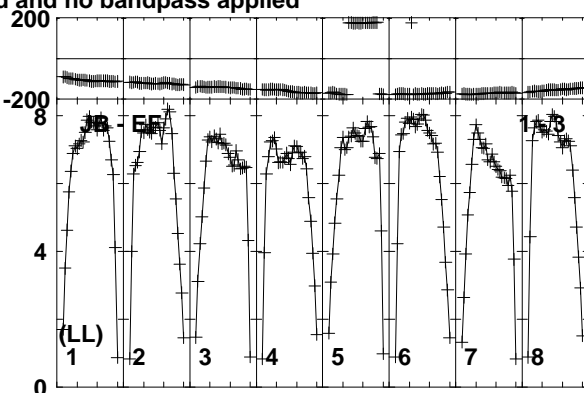
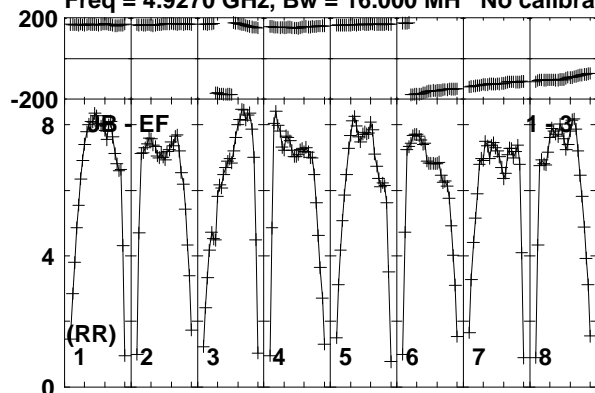

Lower frame: Milli Ampl Jy Top frame: Phas deg  
Vector averaged cross-power spectrum Baseline: JB (01) - EF (03)  
Timerange: 00:18:49:01 to 00:18:49:59

Plot file version 999 created 19-DEC-2018 17:59:16

J1619+2247 RY007C.UVDATA.1

Freq = 4.9270 GHz, Bw = 16.000 MH No calibration applied and no bandpass applied

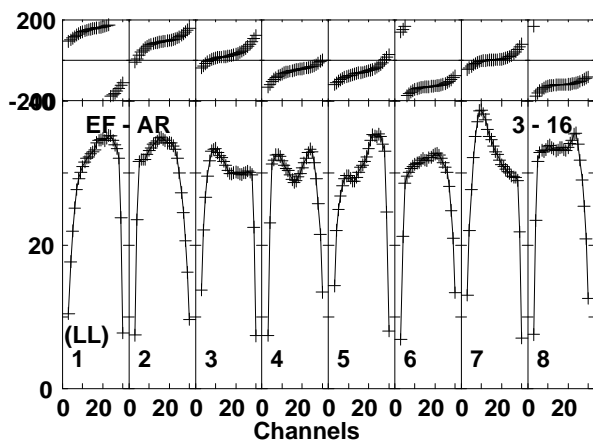
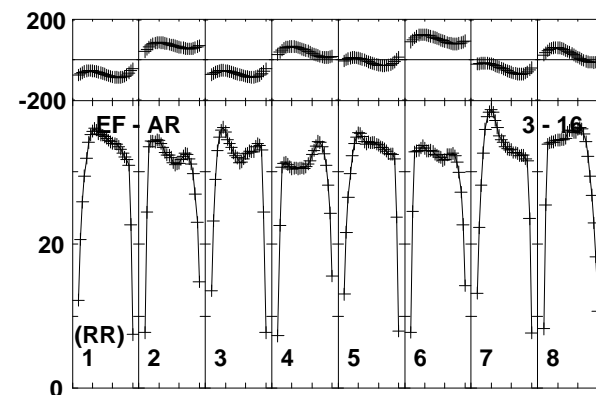
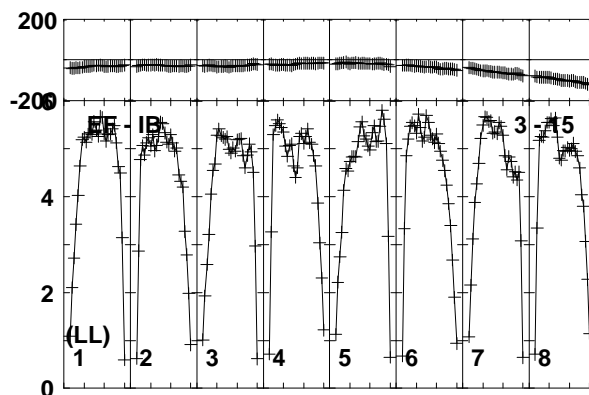
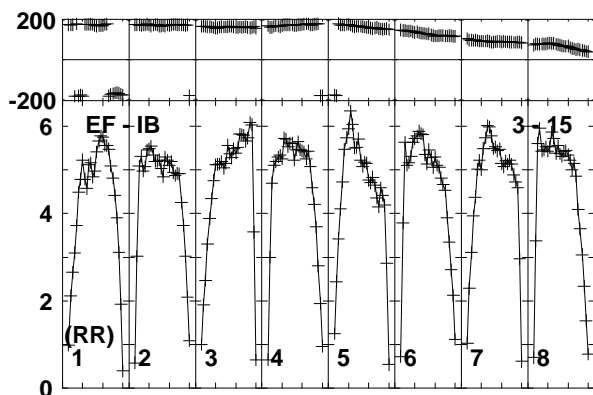
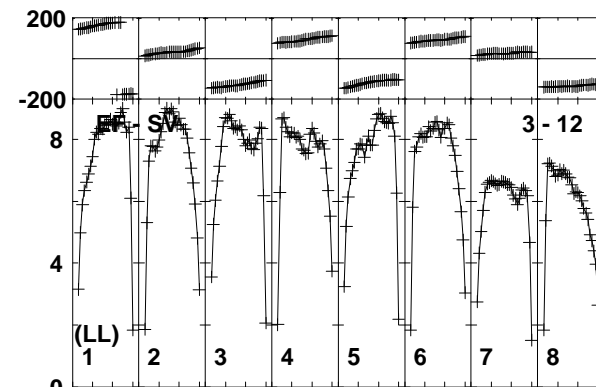
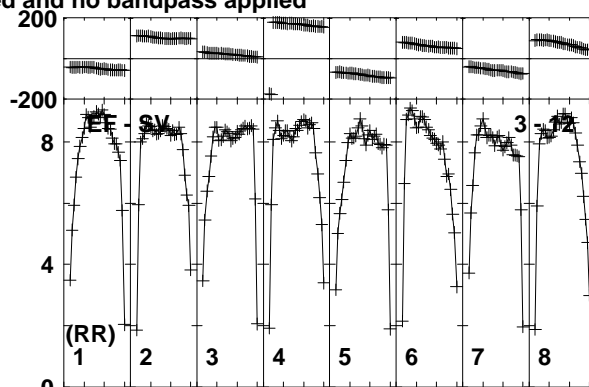
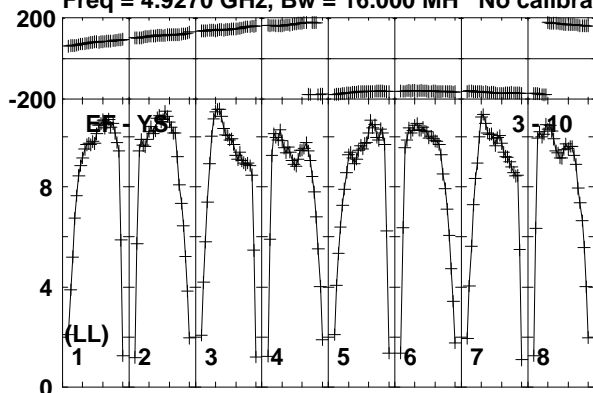

Lower frame: Milli Ampl Jy Top frame: Phas deg  
Vector averaged cross-power spectrum Baseline: EF (03) - YS (10)  
Timerange: 00/18:49:01 to 00/18:49:59

Plot file version1000 created 19-DEC-2018 17:59:16  
 AT2018\_RY007C.UVDATA.1

Freq = 4.9270 GHz, Bw = 16.000 MH No calibration applied and no bandpass applied

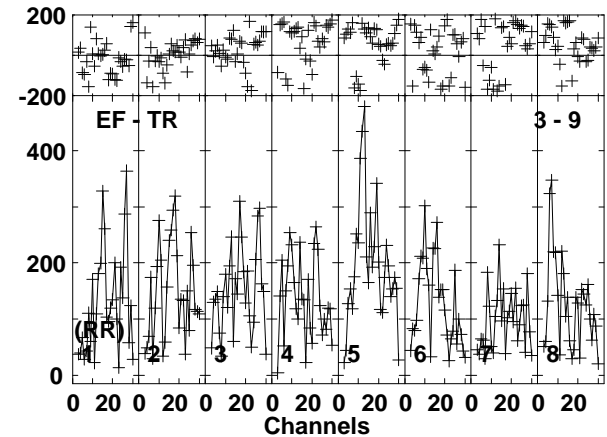
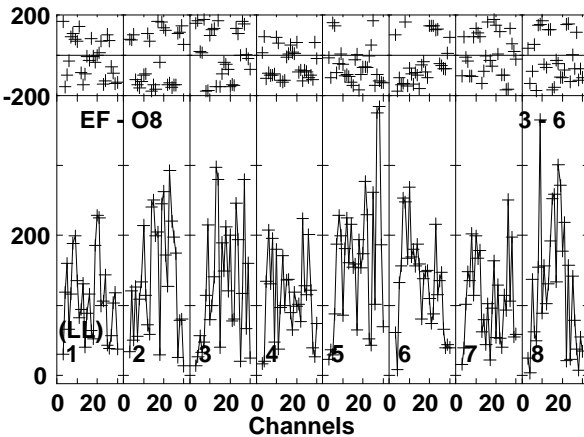
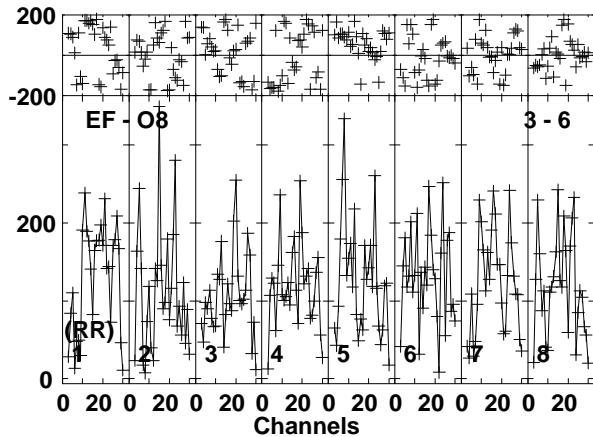
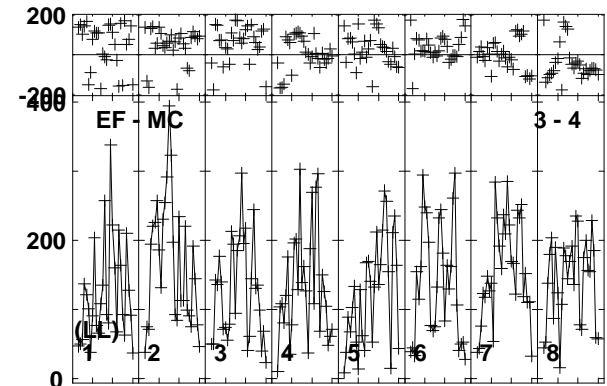
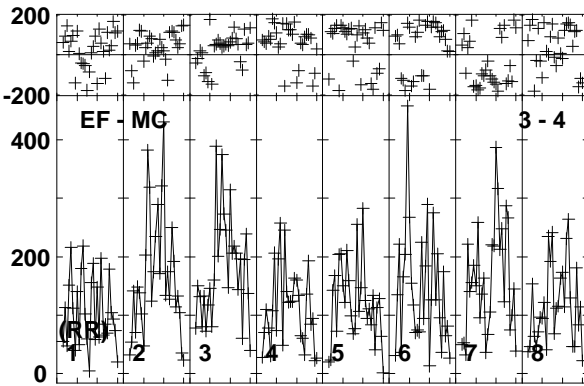
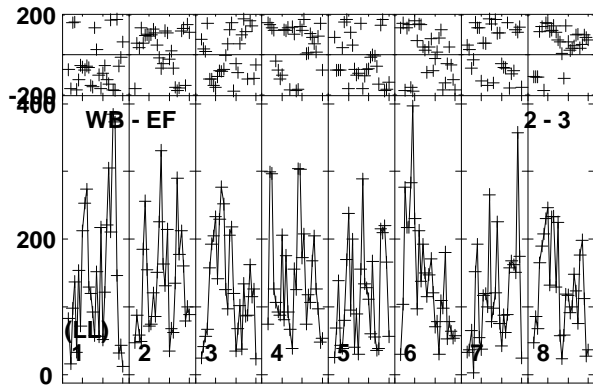
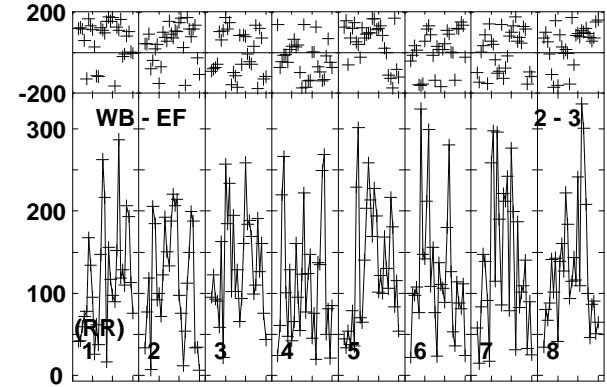
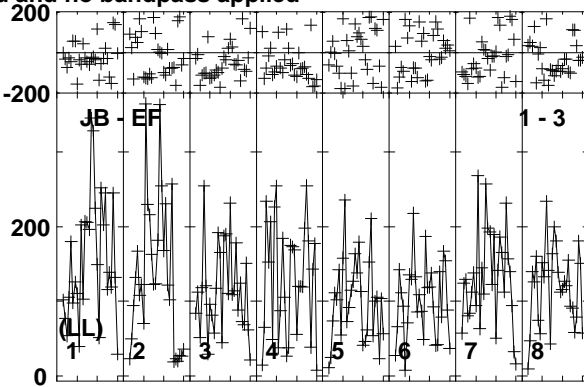
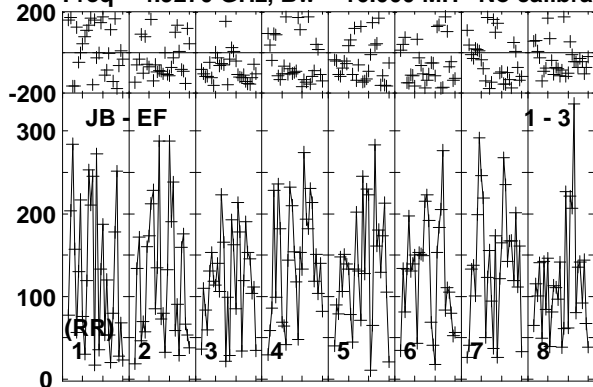

Lower frame: Micro Ampl Jy Top frame: Phas deg  
 Vector averaged cross-power spectrum Baseline: JB (01) - EF (03)  
 Timerange: 00/18:50:01 to 00/18:51:59

Plot file version1001 created 19-DEC-2018 17:59:16

AT2018\_RY007C.UVDATA.1

Freq = 4.9270 GHz, Bw = 16.000 MH No calibration applied and no bandpass applied

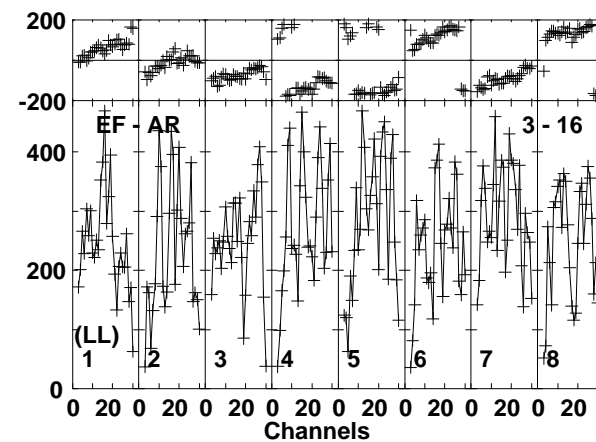
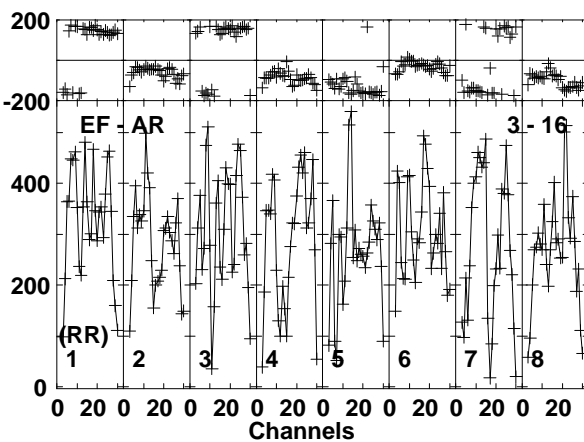
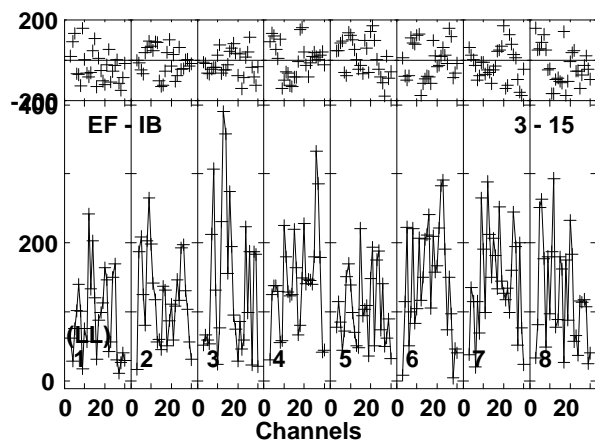
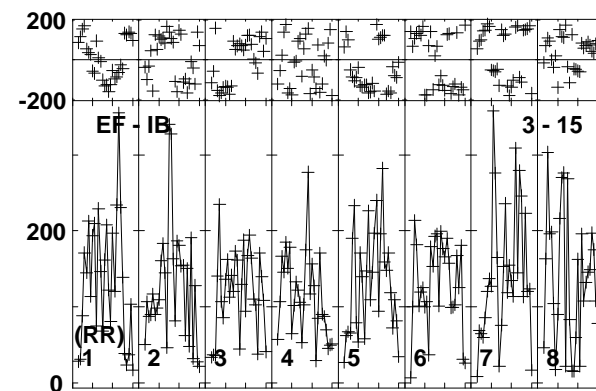
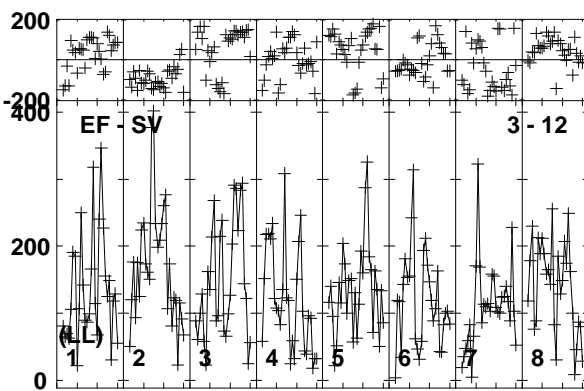
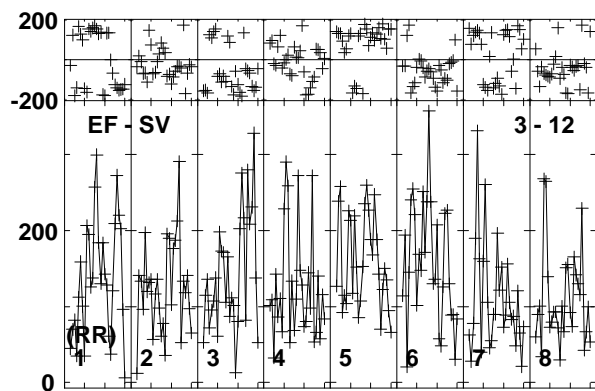
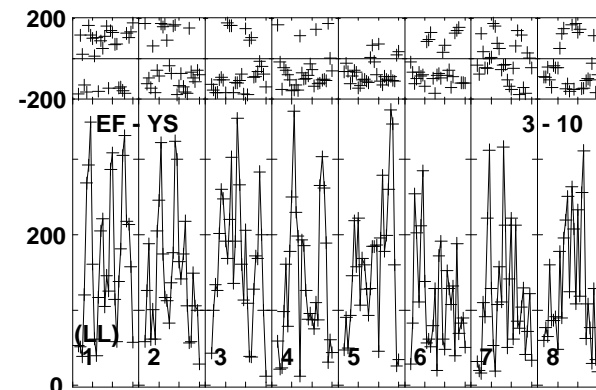
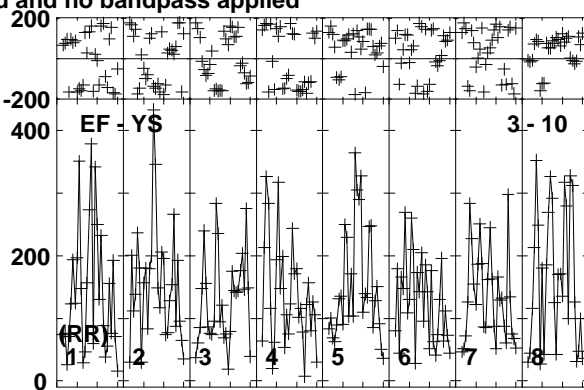
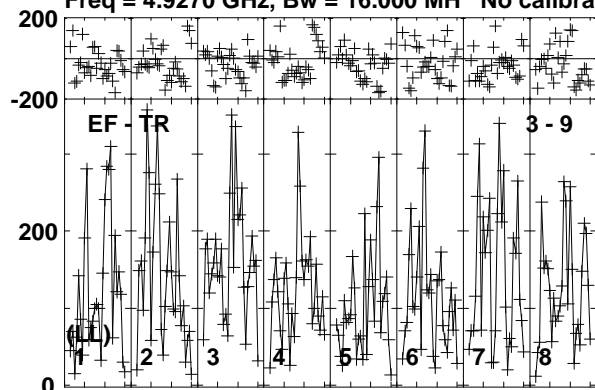

Lower frame: Micro Ampl Jy Top frame: Phas deg  
Vector averaged cross-power spectrum Baseline: EF (03) - TR (09)  
Timerange: 00:18:50:01 to 00:18:51:59

Plot file version1002 created 19-DEC-2018 17:59:17

VLA2 RY007C.UVDATA.1

Freq = 4.9270 GHz, Bw = 16.000 MH No calibration applied and no bandpass applied

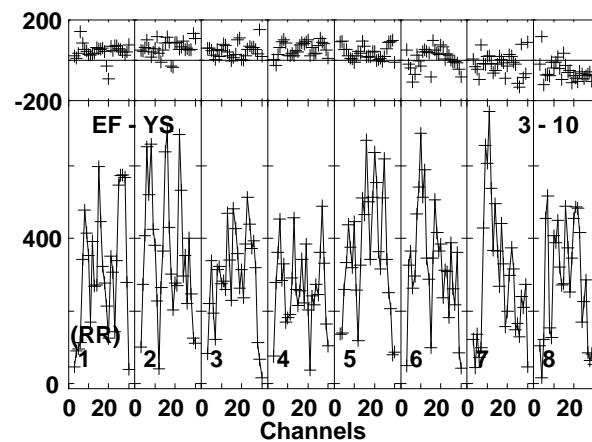
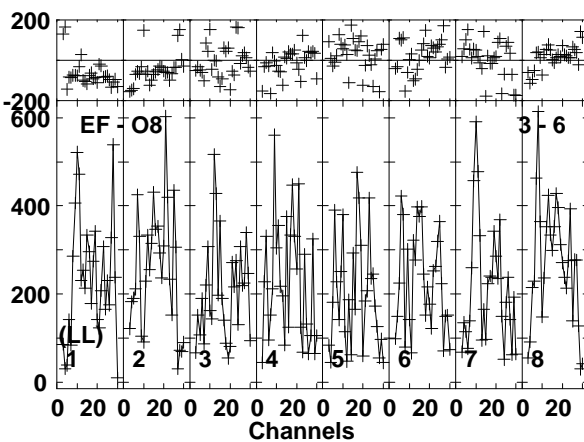
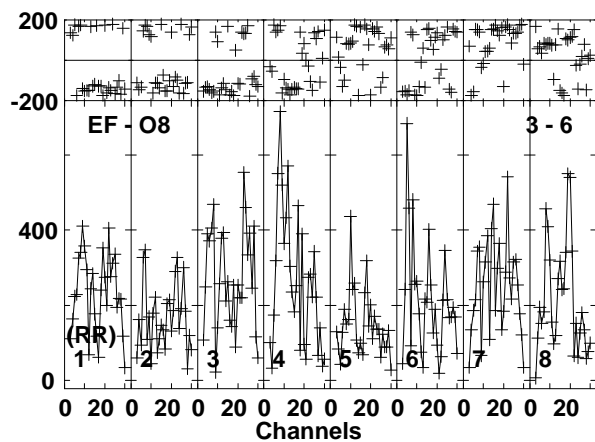
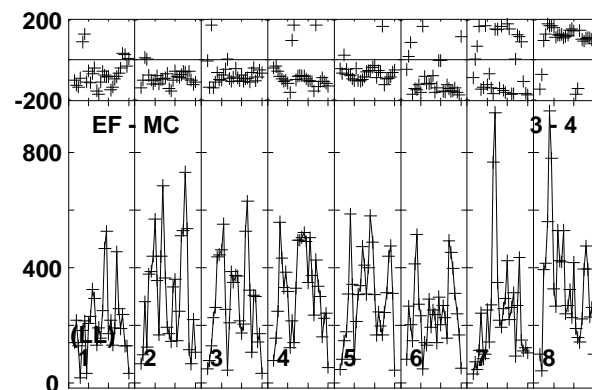
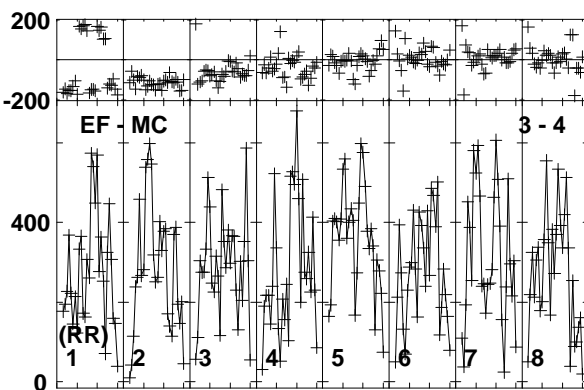
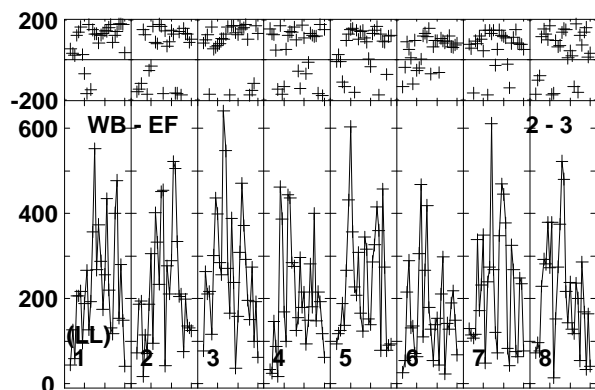
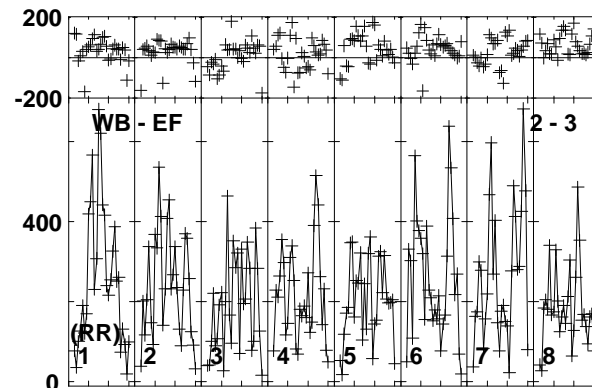
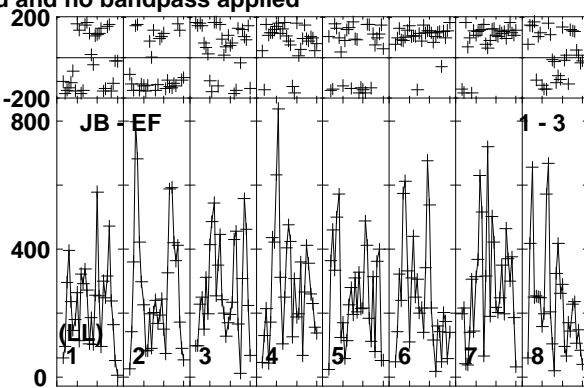
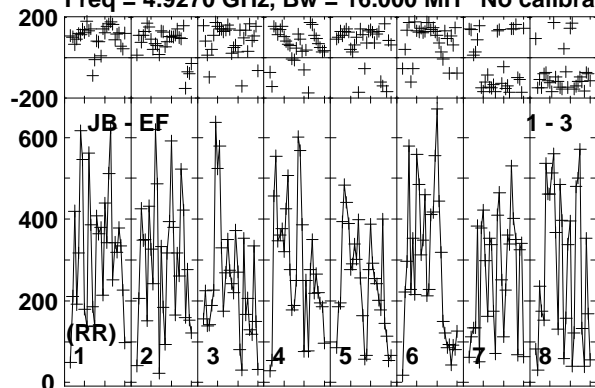

Lower frame: Micro Ampl Jy Top frame: Phas deg  
Vector averaged cross-power spectrum Baseline: JB (01) - EF (03)  
Timerange: 00/18:52:01 to 00/18:52:59



Plot file version1003 created 19-DEC-2018 17:59:17

VLA2 RY007C.UVDATA.1

Freq = 4.9270 GHz, Bw = 16.000 MH No calibration applied and no bandpass applied

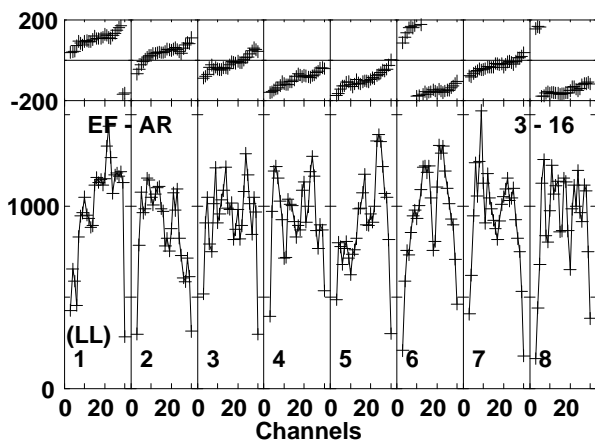
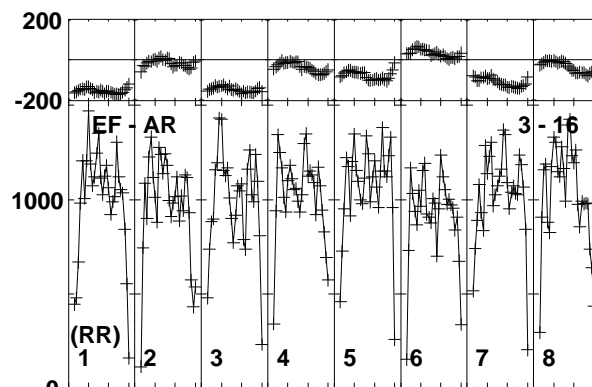
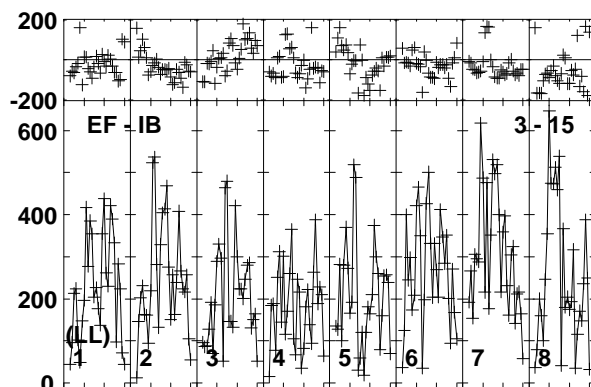
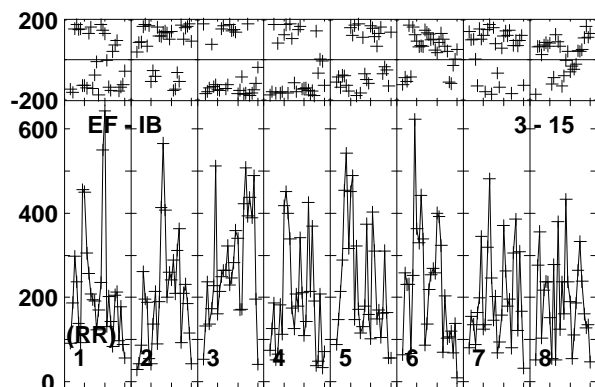
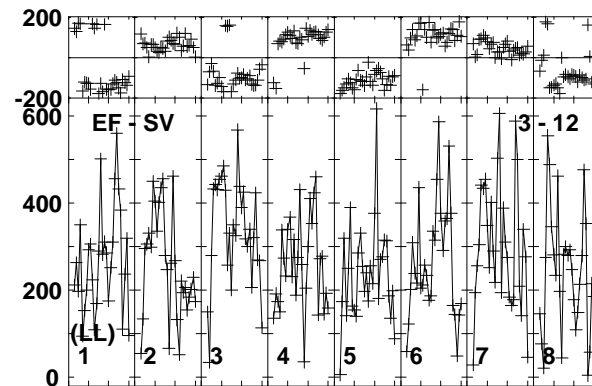
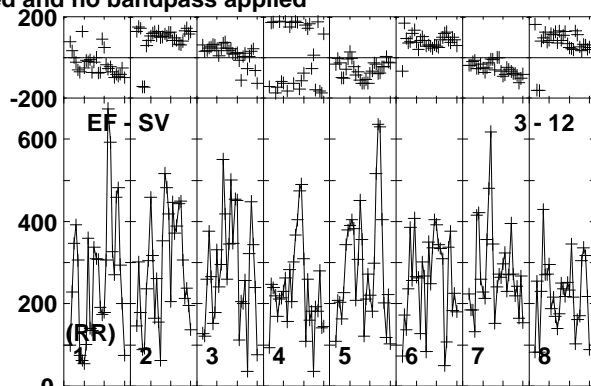
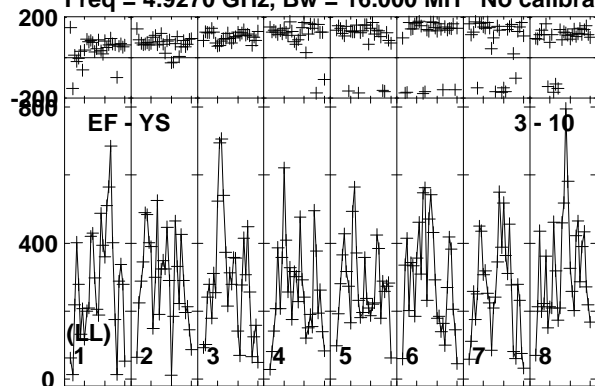

Lower frame: Micro Ampl Jy Top frame: Phas deg  
Vector averaged cross-power spectrum Baseline: EF (03) - YS (10)  
Timerange: 00/18:52:01 to 00/18:52:59

Plot file version1004 created 19-DEC-2018 17:59:17

J1619+2247 RY007C.UVDATA.1

Freq = 4.9270 GHz, Bw = 16.000 MH No calibration applied and no bandpass applied

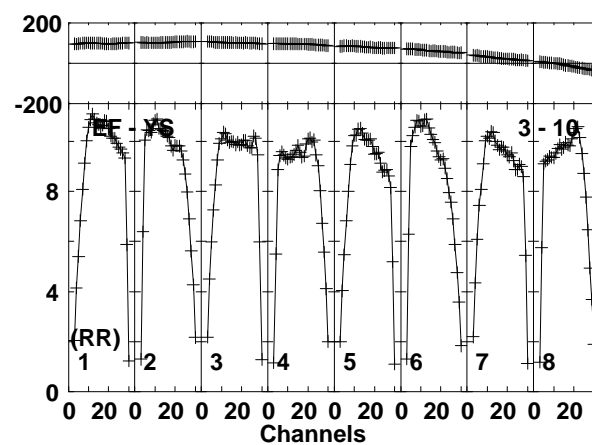
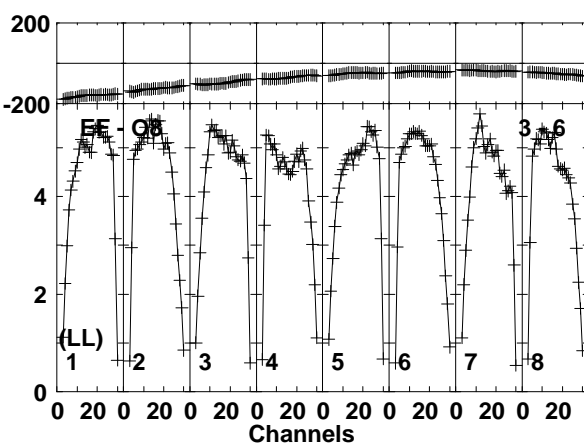
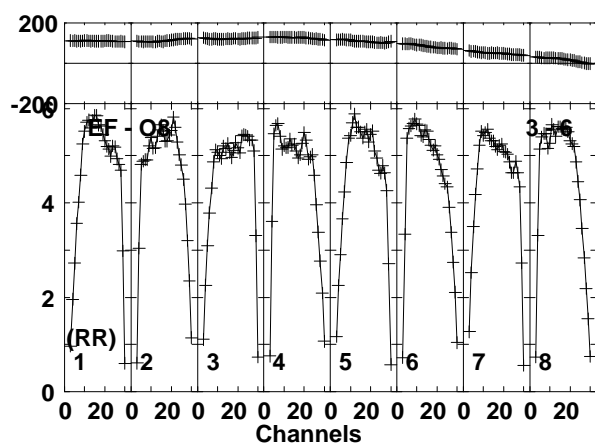
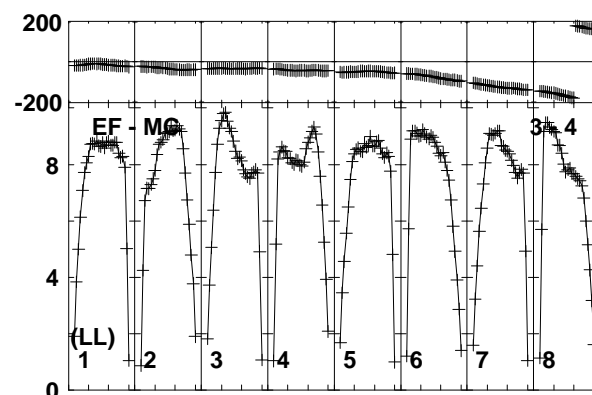
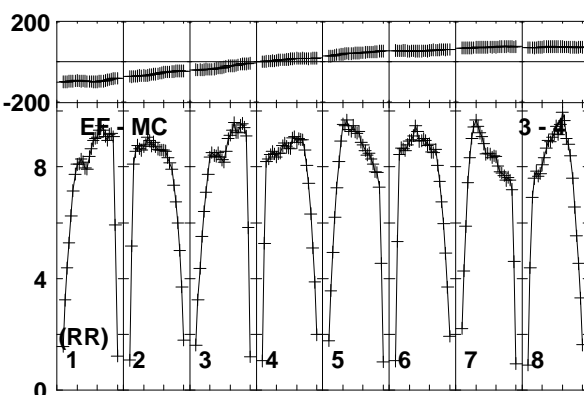
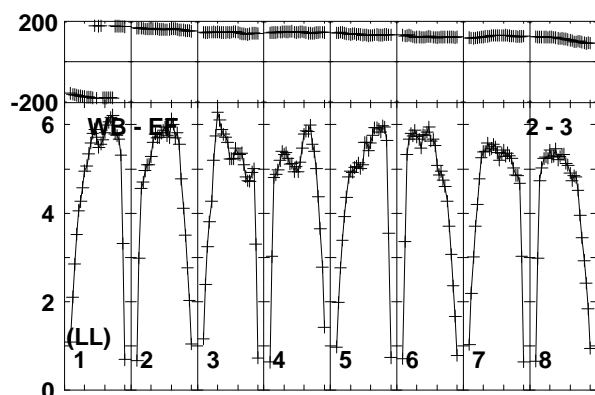
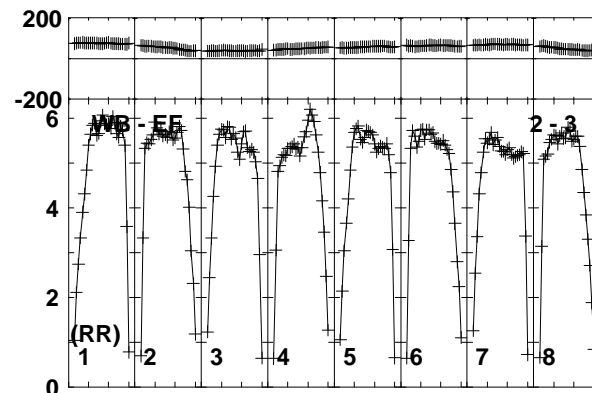
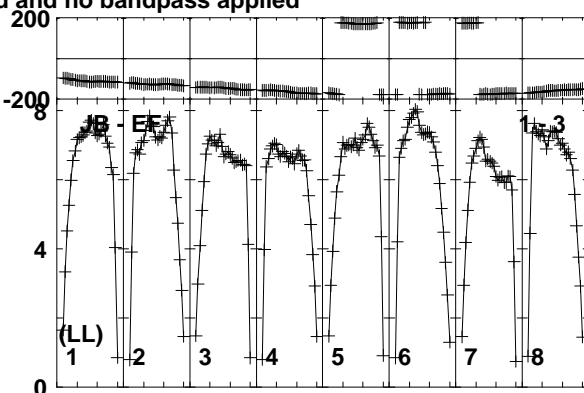
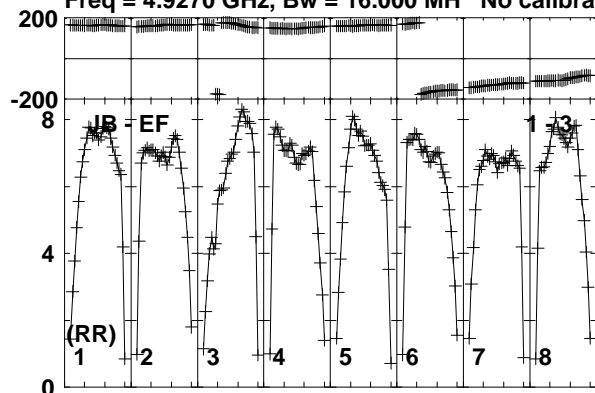

Lower frame: Milli Ampl Jy Top frame: Phas deg  
Vector averaged cross-power spectrum Baseline: JB (01) - EF (03)  
Timerange: 00:18:53:31 to 00:18:54:29

Plot file version1005 created 19-DEC-2018 17:59:17

J1619+2247 RY007C.UVDATA.1

Freq = 4.9270 GHz, Bw = 16.000 MH No calibration applied and no bandpass applied

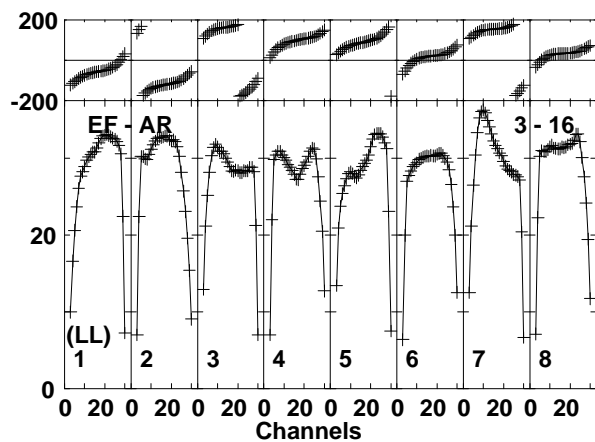
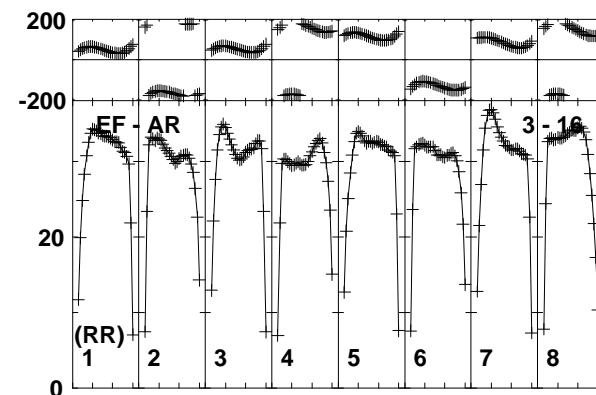
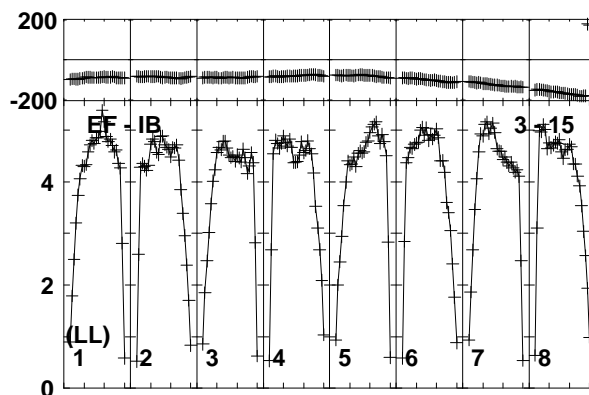
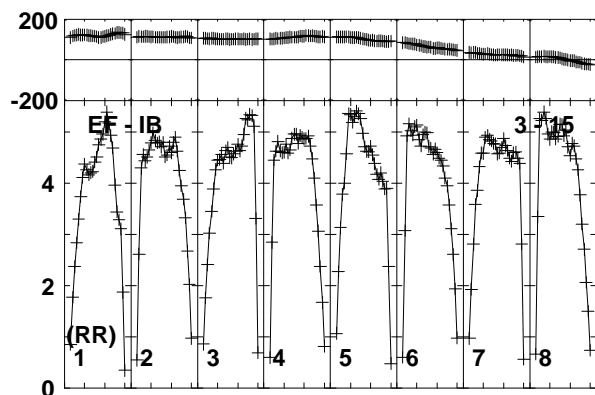
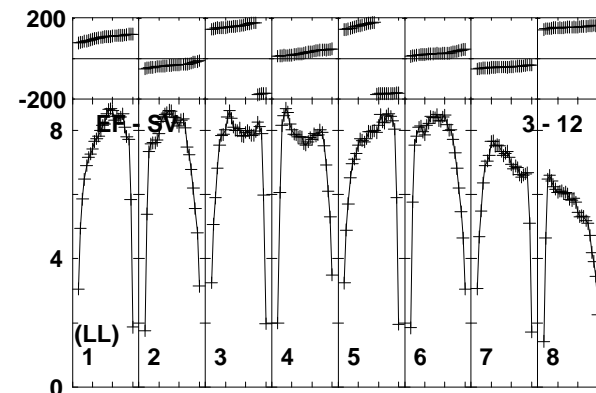
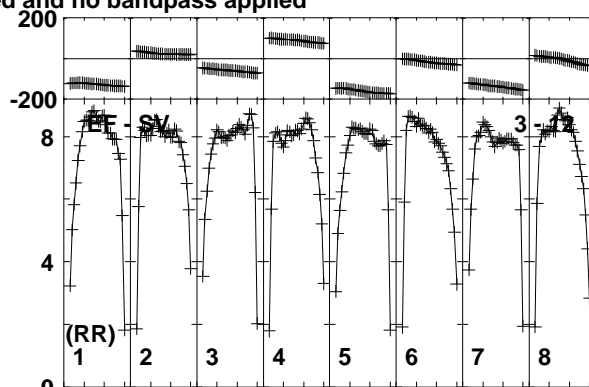
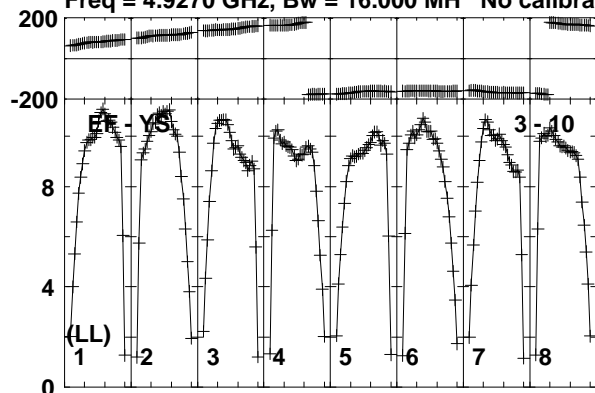

Lower frame: Milli Ampl Jy Top frame: Phas deg  
Vector averaged cross-power spectrum Baseline: EF (03) - YS (10)  
Timerange: 00/18:53:31 to 00/18:54:29

Plot file version1006 created 19-DEC-2018 17:59:17  
 AT2018\_RY007C.UVDATA.1

Freq = 4.9270 GHz, Bw = 16.000 MH No calibration applied and no bandpass applied

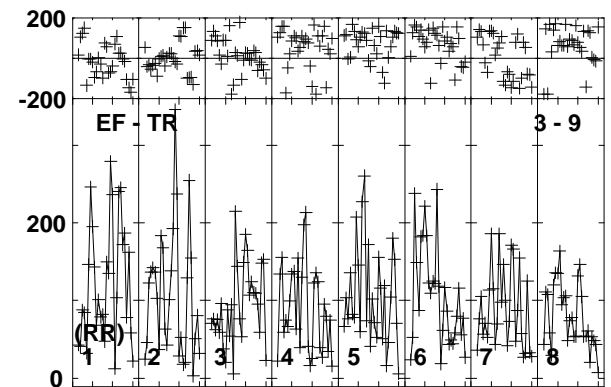
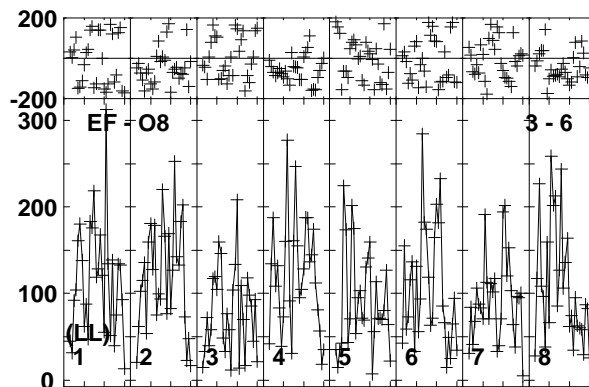
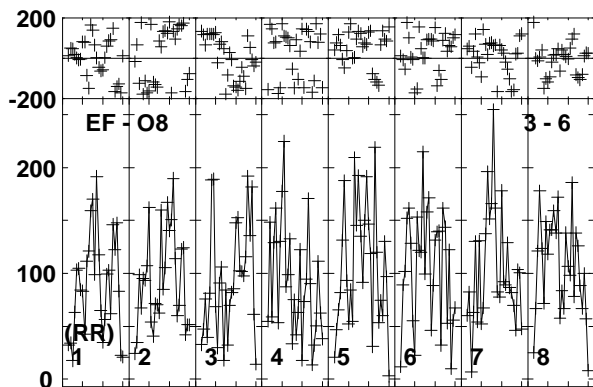
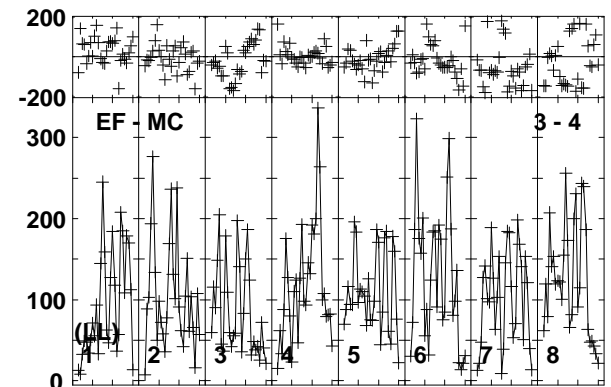
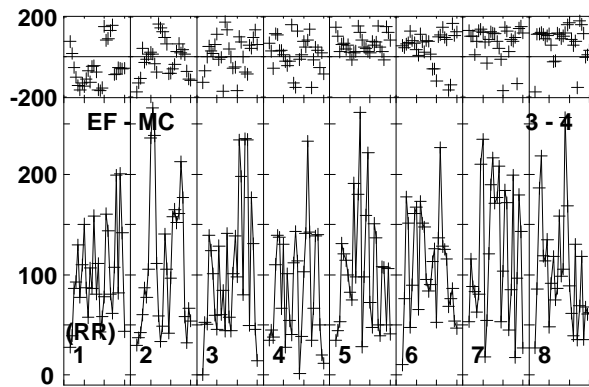
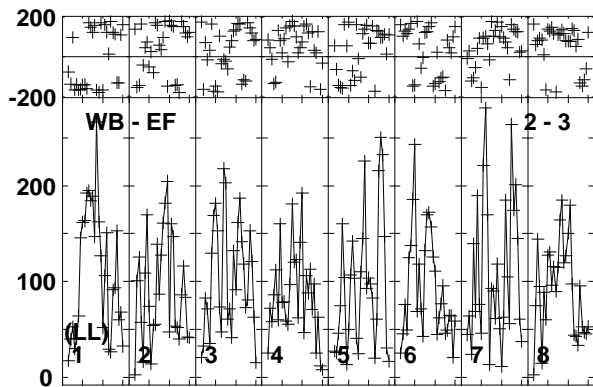
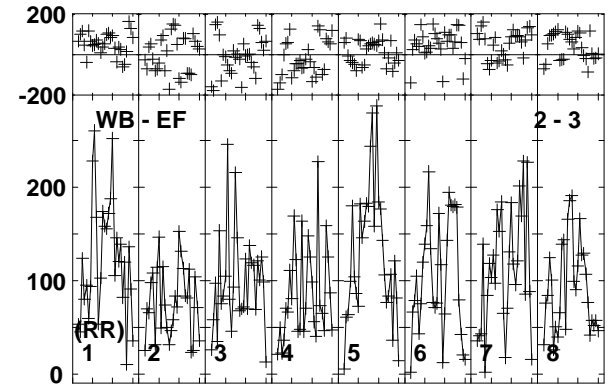
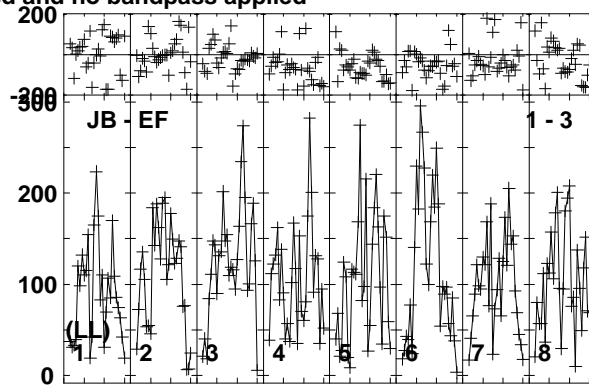
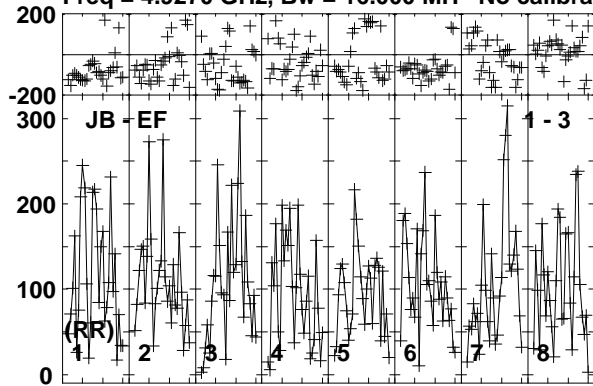

Lower frame: Micro Ampl Jy Top frame: Phas deg  
 Vector averaged cross-power spectrum Baseline: JB (01) - EF (03)  
 Timerange: 00/18:54:31 to 00/18:57:29

Plot file version1007 created 19-DEC-2018 17:59:17

AT2018\_RY007C.UVDATA.1

Freq = 4.9270 GHz, Bw = 16.000 MH No calibration applied and no bandpass applied

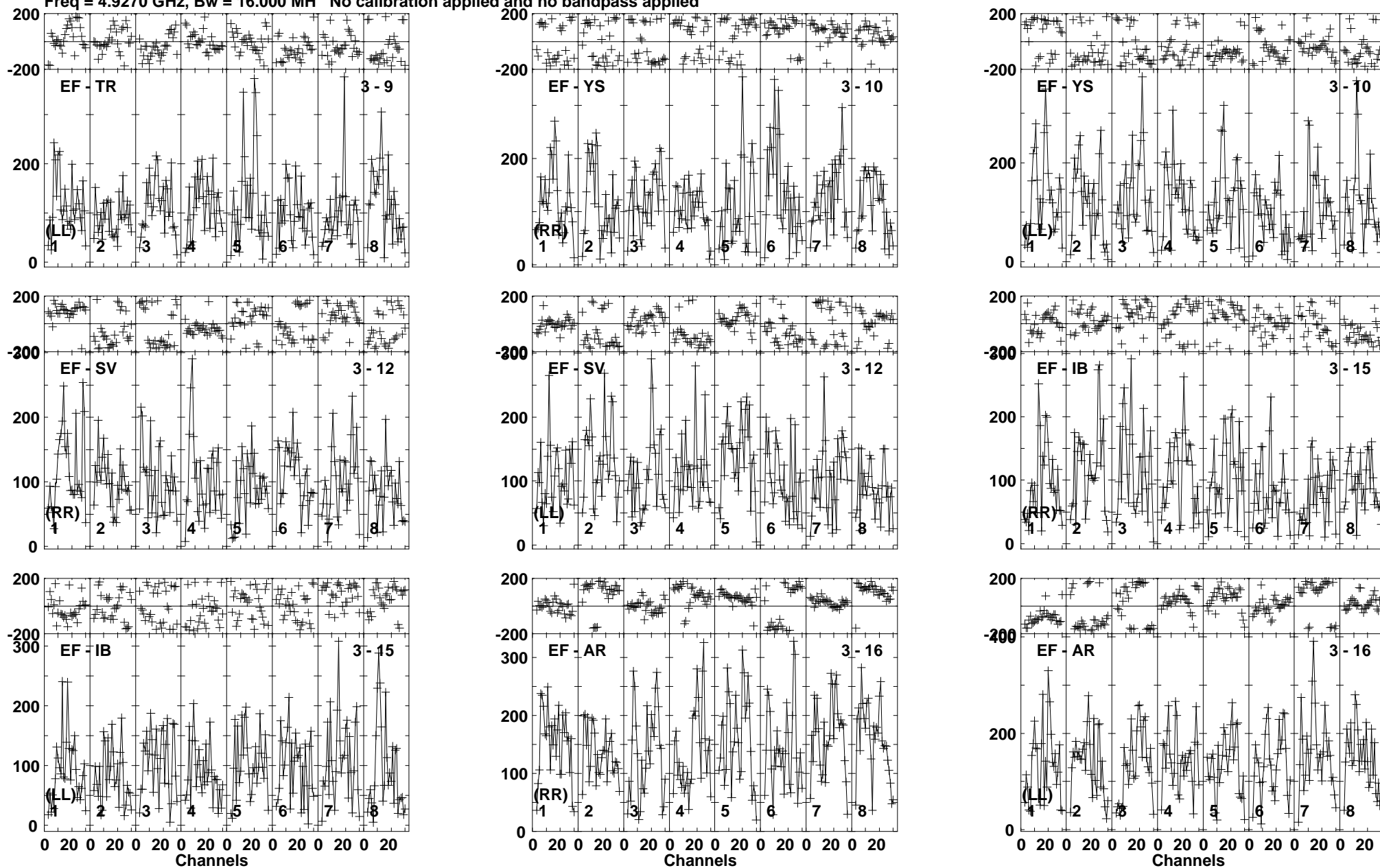

Lower frame: Micro Ampl Jy Top frame: Phas deg  
Vector averaged cross-power spectrum Baseline: EF (03) - TR (09)  
Timerange: 00:18:54:31 to 00:18:57:29

Plot file version1008 created 19-DEC-2018 17:59:17

J1619+2247 RY007C.UVDATA.1

Freq = 4.9270 GHz, Bw = 16.000 MH No calibration applied and no bandpass applied

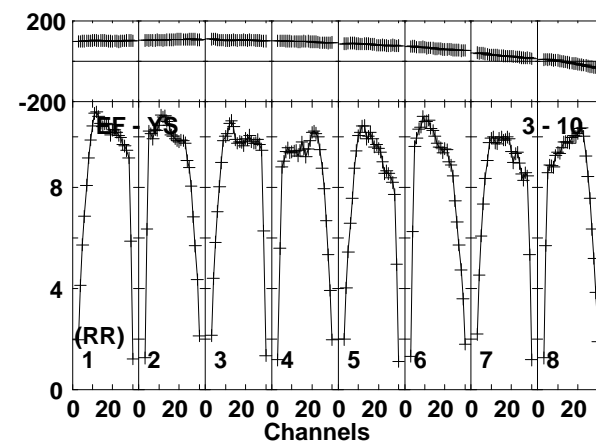
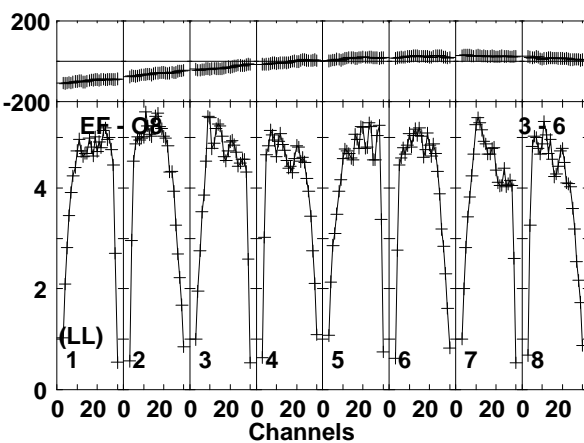
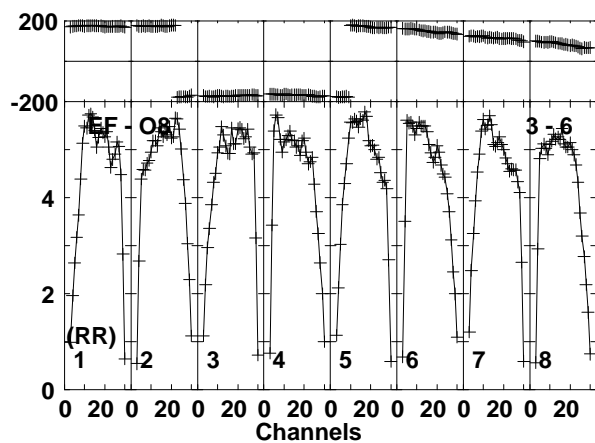
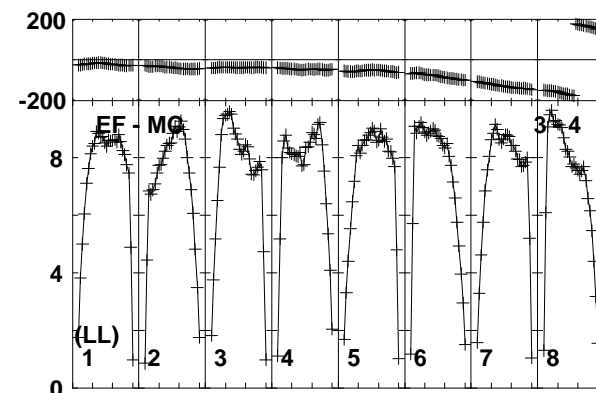
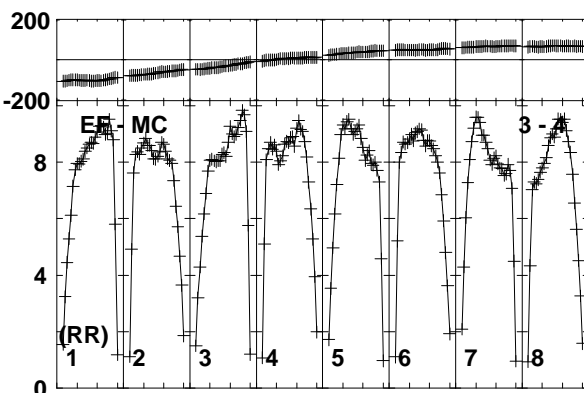
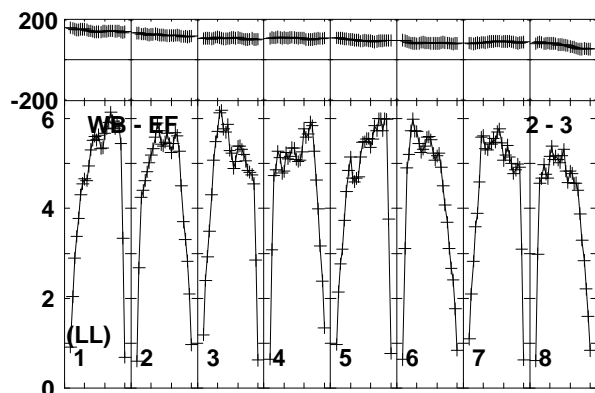
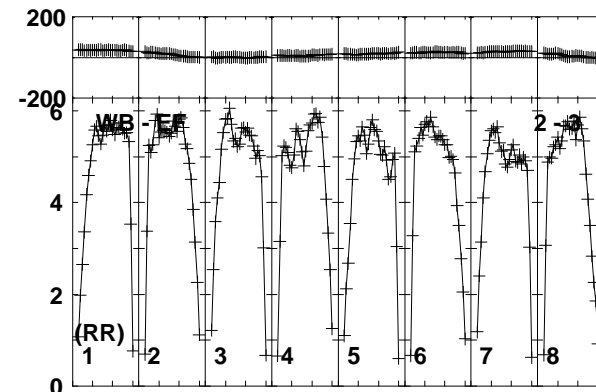
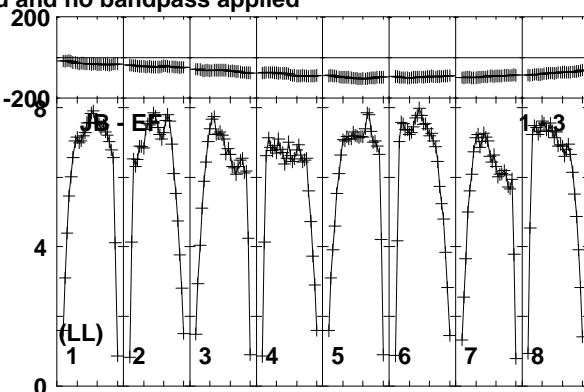
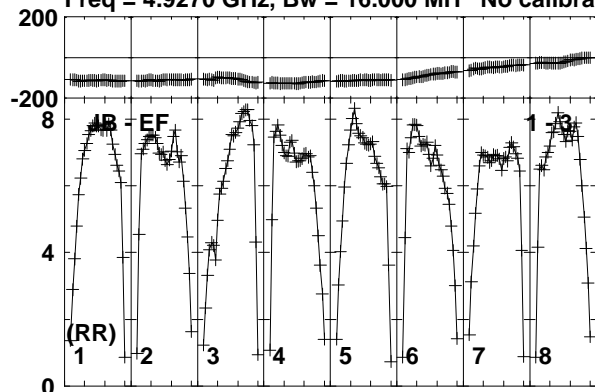

Lower frame: Milli Ampl Jy Top frame: Phas deg  
Vector averaged cross-power spectrum Baseline: JB (01) - EF (03)  
Timerange: 00/18:57:31 to 00/18:58:29

Plot file version1009 created 19-DEC-2018 17:59:17

J1619+2247 RY007C.UVDATA.1

Freq = 4.9270 GHz, Bw = 16.000 MH No calibration applied and no bandpass applied

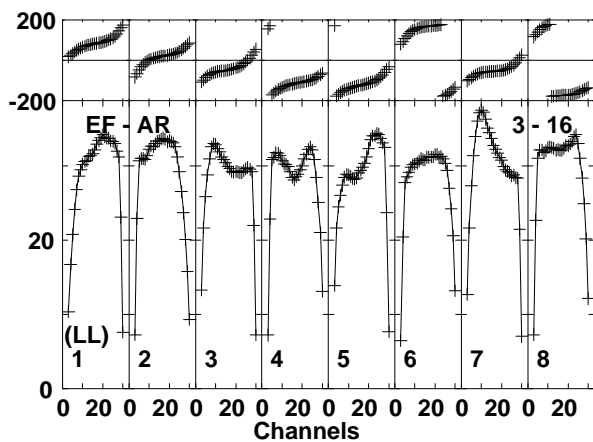
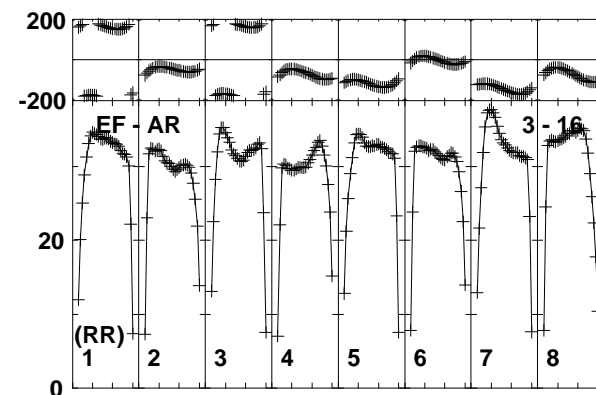
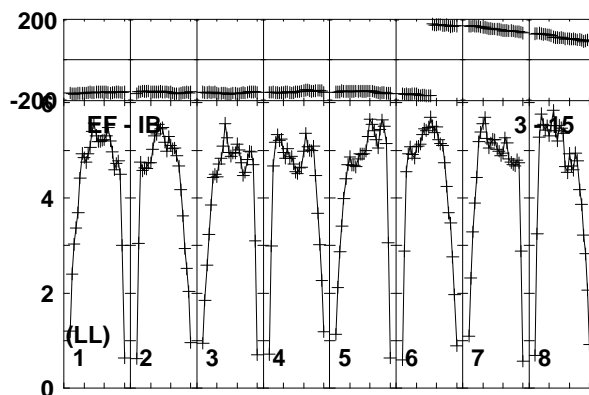
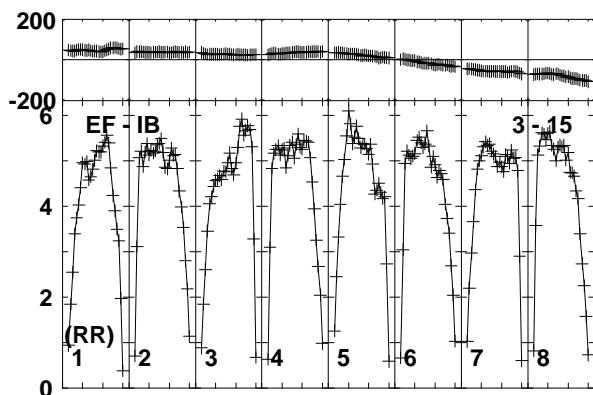
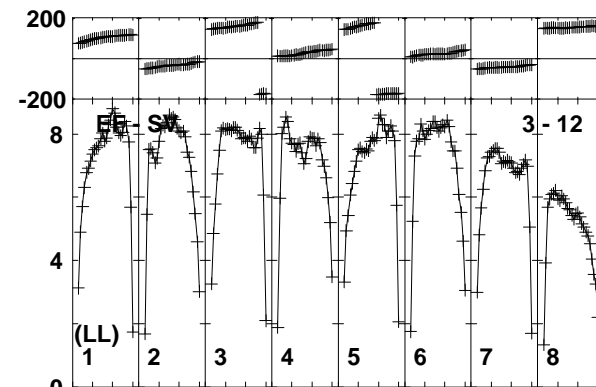
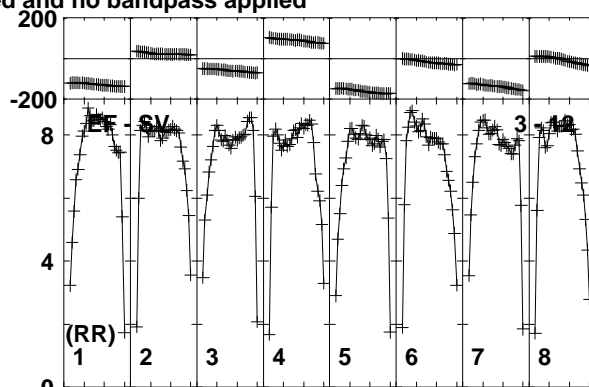
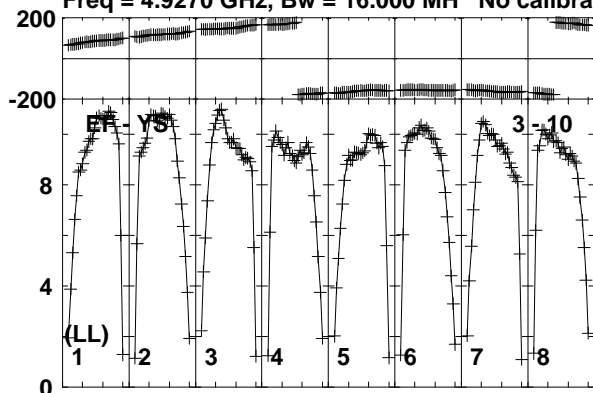

Lower frame: Milli Ampl Jy Top frame: Phas deg  
Vector averaged cross-power spectrum Baseline: EF (03) - YS (10)  
Timerange: 00/18:57:31 to 00/18:58:29

Plot file version1010 created 19-DEC-2018 17:59:17

AT2018\_RY007C.UVDATA.1

Freq = 4.9270 GHz, Bw = 16.000 MH No calibration applied and no bandpass applied

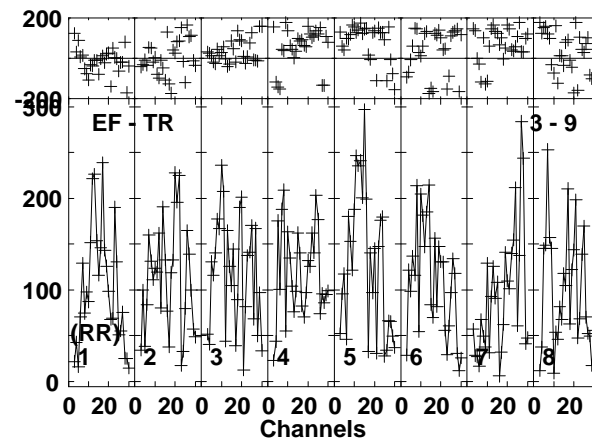
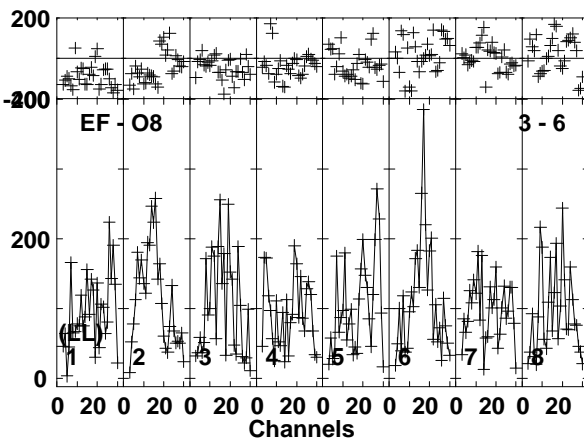
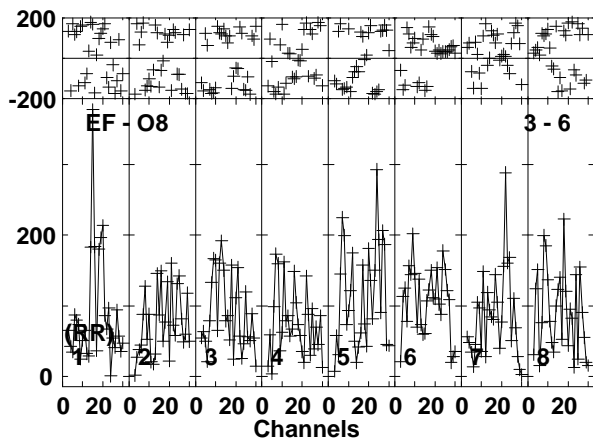
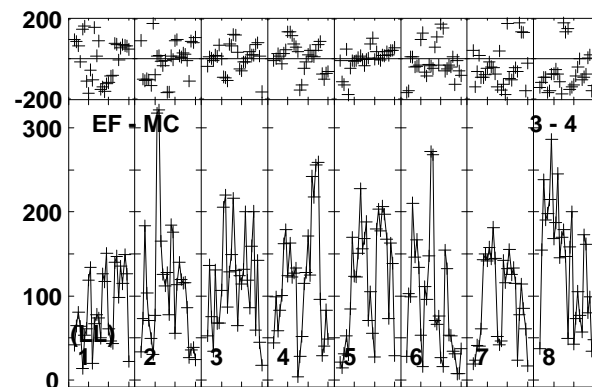
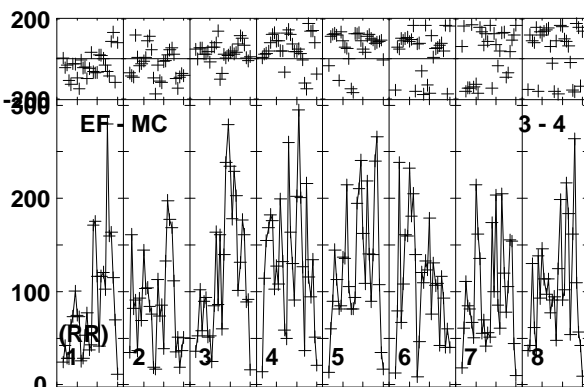
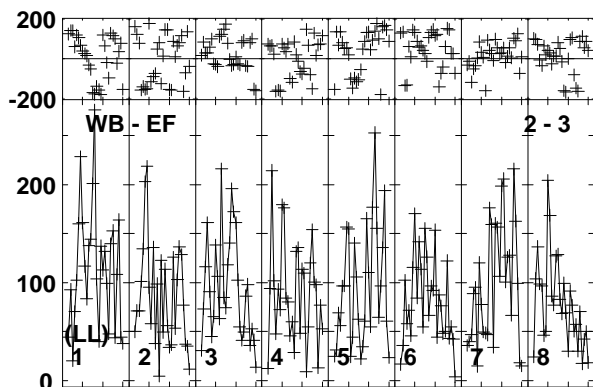
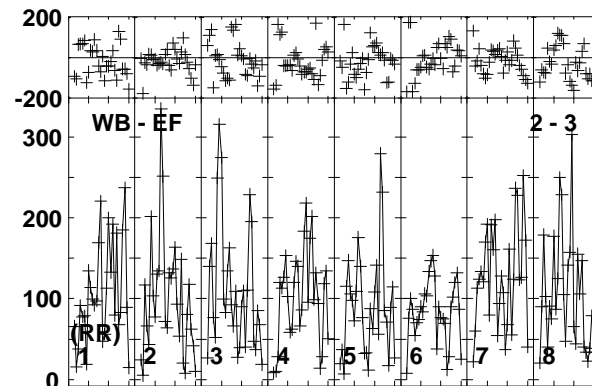
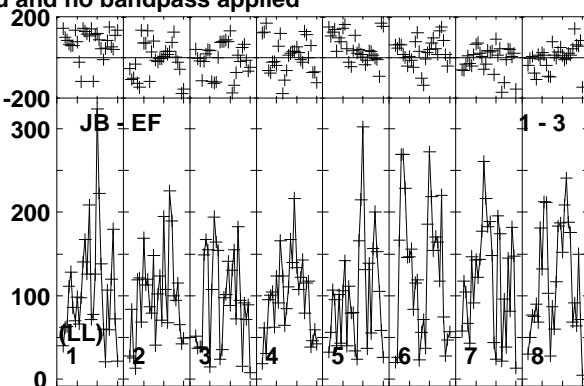
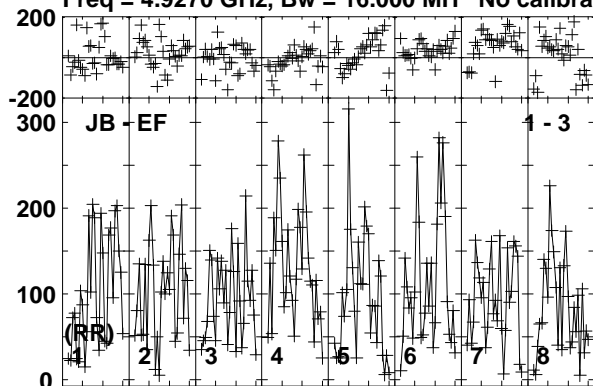

Lower frame: Micro Ampl Jy Top frame: Phas deg  
Vector averaged cross-power spectrum Baseline: JB (01) - EF (03)  
Timerange: 00:18:58:31 to 00:19:01:29



Plot file version1011 created 19-DEC-2018 17:59:17  
AT2018\_RY007C.UVDATA.1

Freq = 4.9270 GHz, Bw = 16.000 MH No calibration applied and no bandpass applied

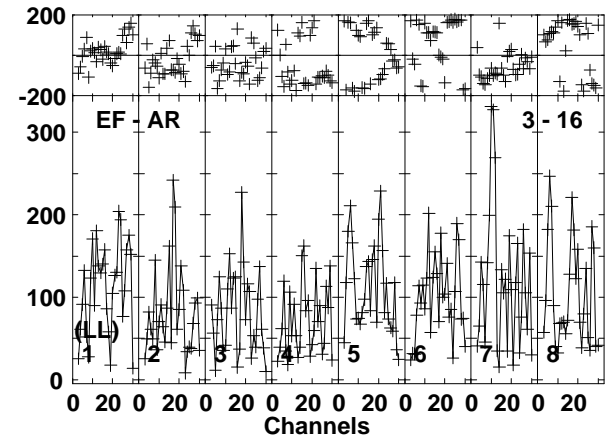
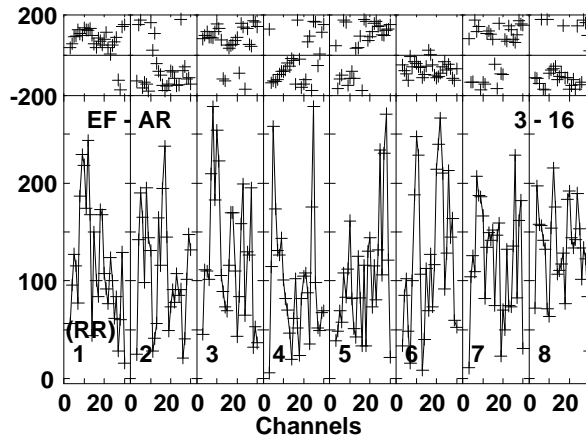
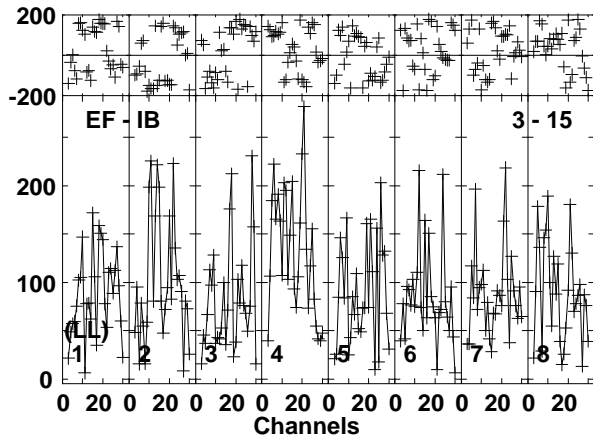
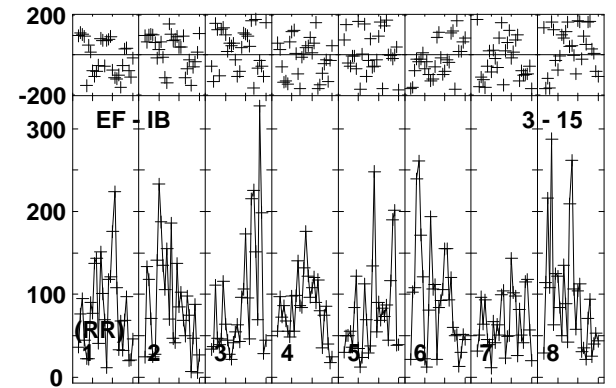
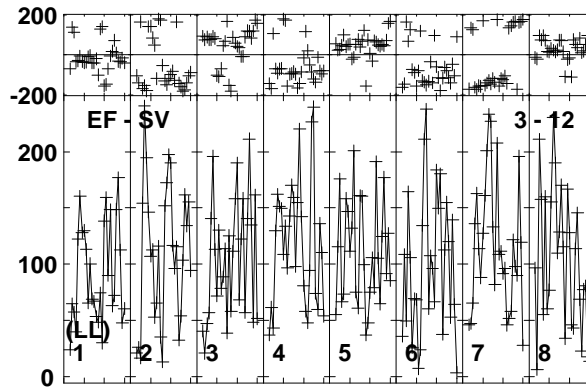
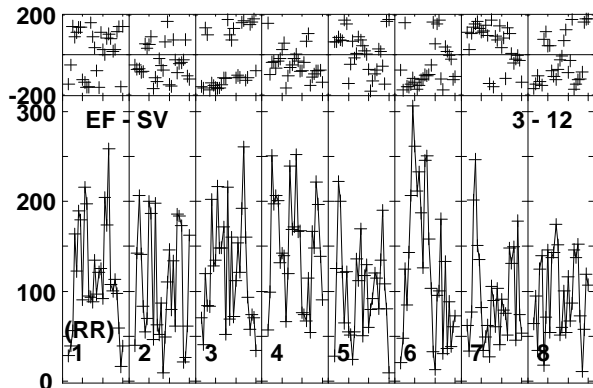
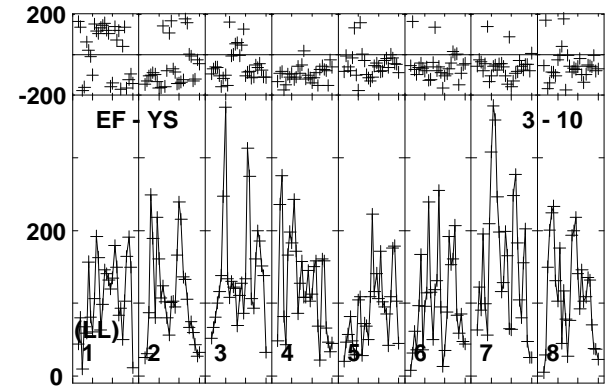
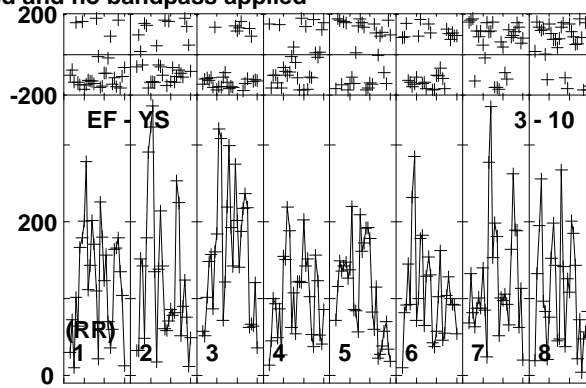
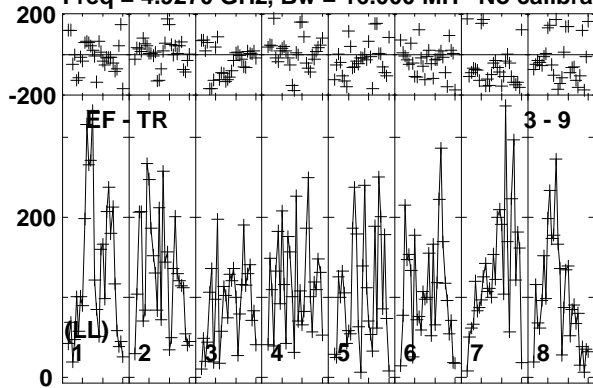

Lower frame: Micro Ampl Jy Top frame: Phas deg  
Vector averaged cross-power spectrum Baseline: EF (03) - TR (09)  
Timerange: 00/18:58:31 to 00/19:01:29

Plot file version1012 created 19-DEC-2018 17:59:17

J1619+2247 RY007C.UVDATA.1

Freq = 4.9270 GHz, Bw = 16.000 MH No calibration applied and no bandpass applied

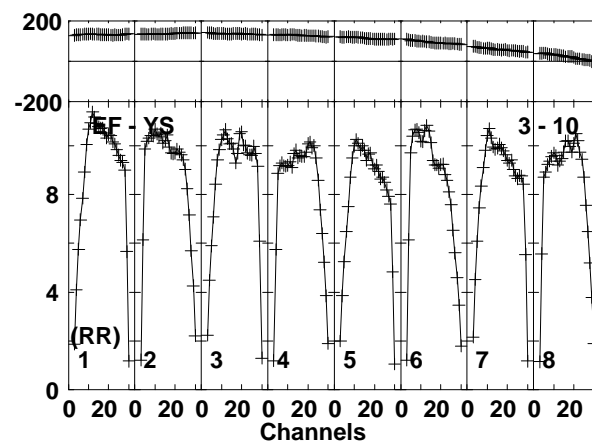
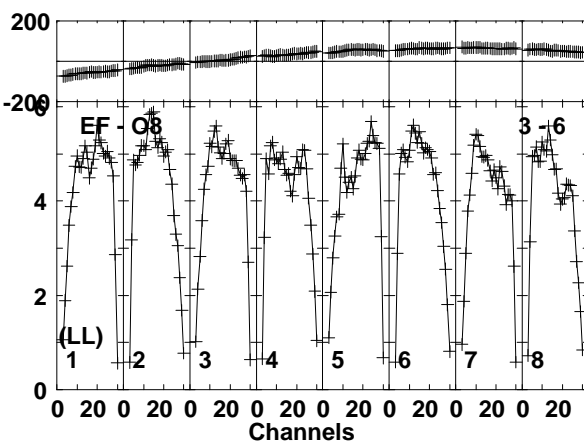
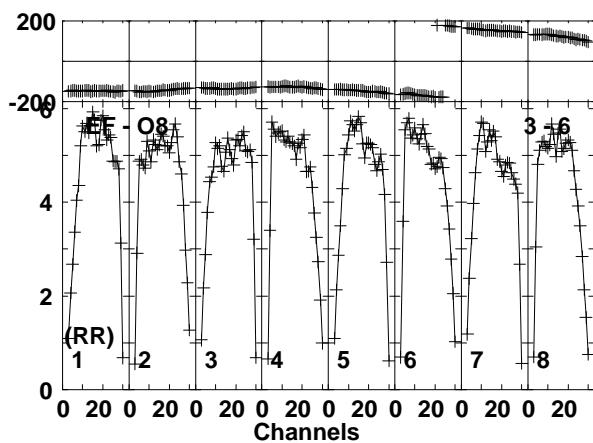
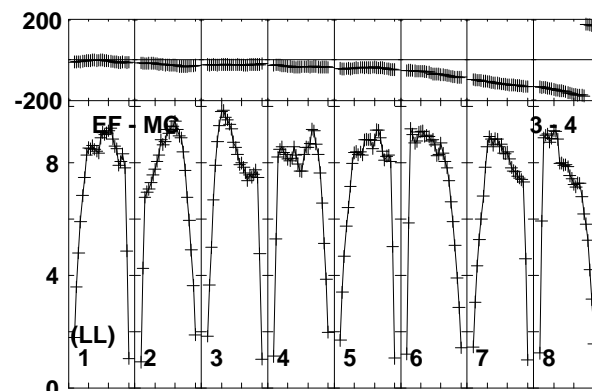
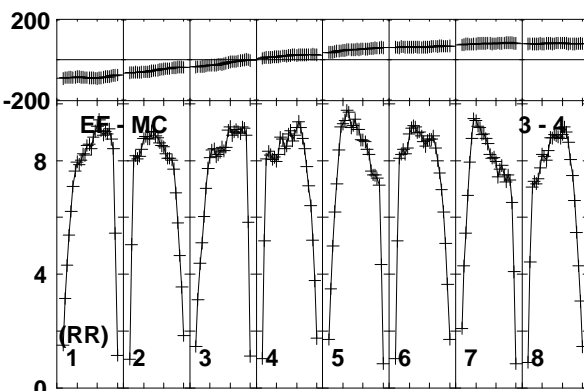
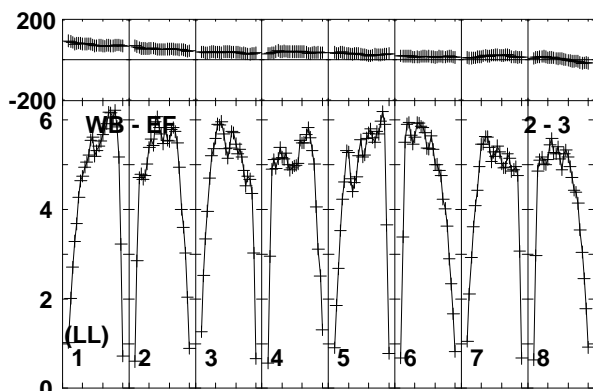
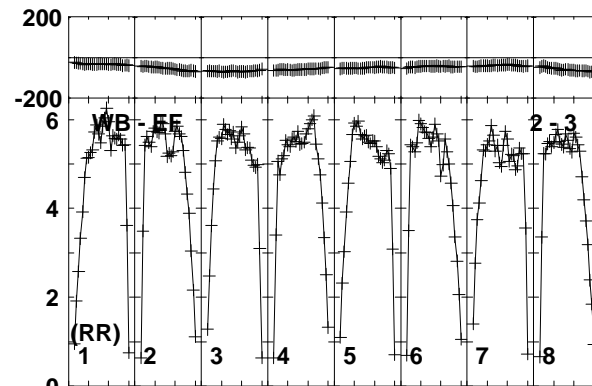
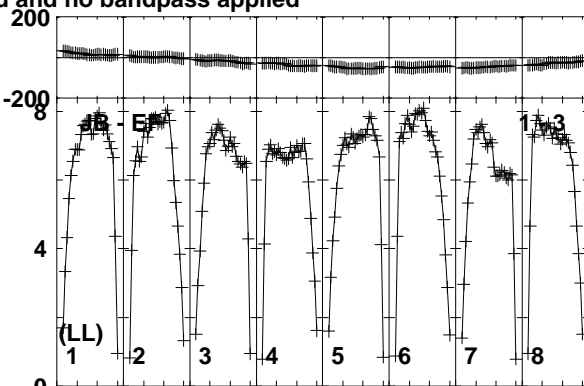
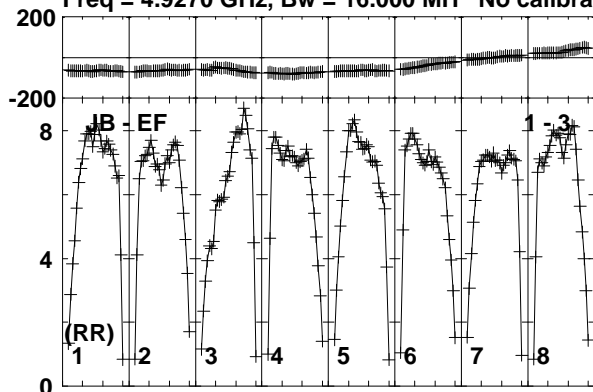

Lower frame: Milli Ampl Jy Top frame: Phas deg  
Vector averaged cross-power spectrum Baseline: JB (01) - EF (03)  
Timerange: 00/19:01:31 to 00/19:02:29

Plot file version1013 created 19-DEC-2018 17:59:17

J1619+2247 RY007C.UVDATA.1

Freq = 4.9270 GHz, Bw = 16.000 MH No calibration applied and no bandpass applied

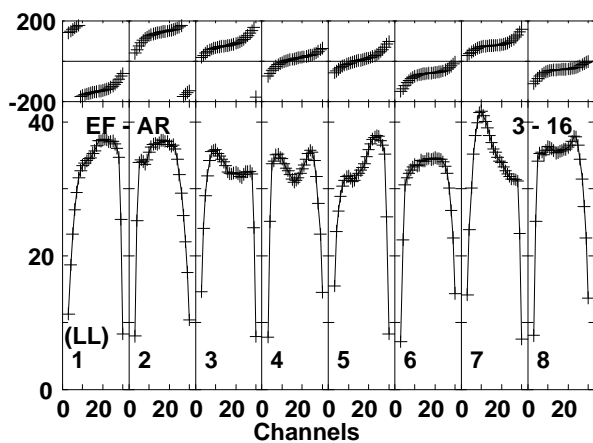
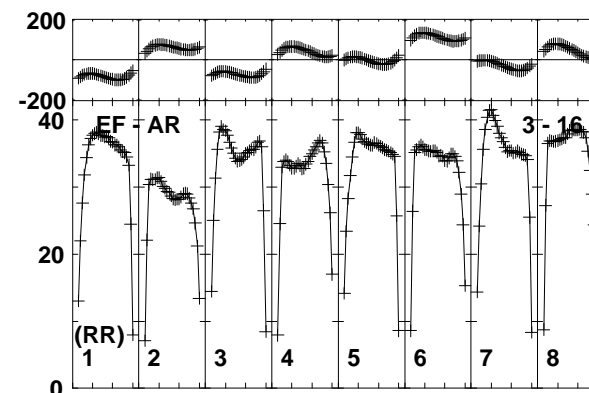
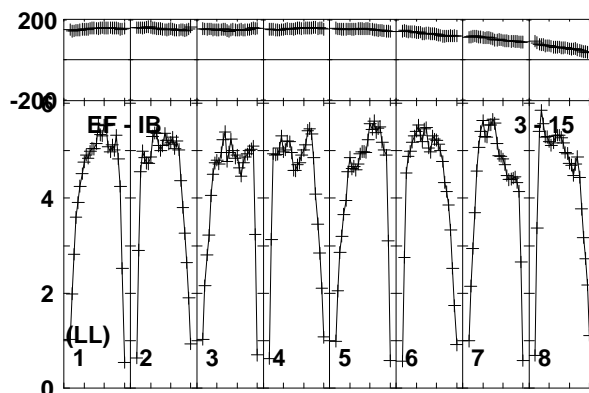
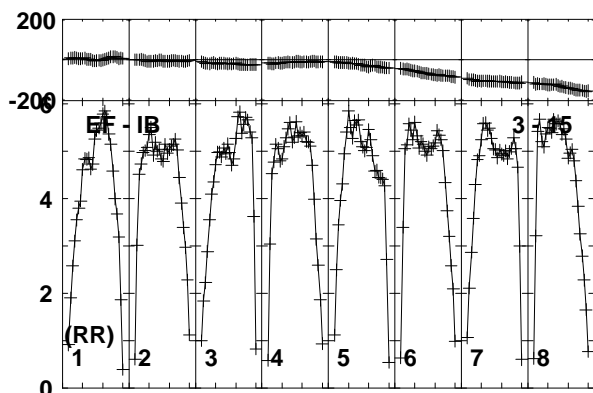
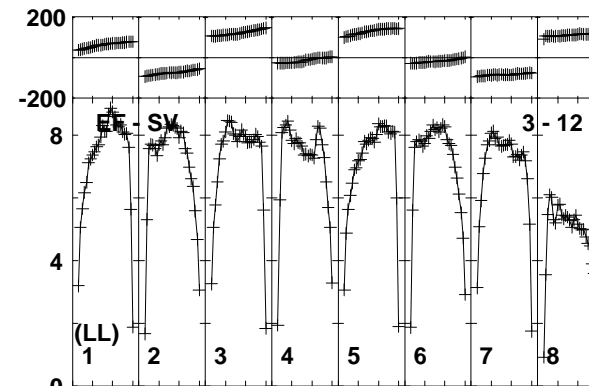
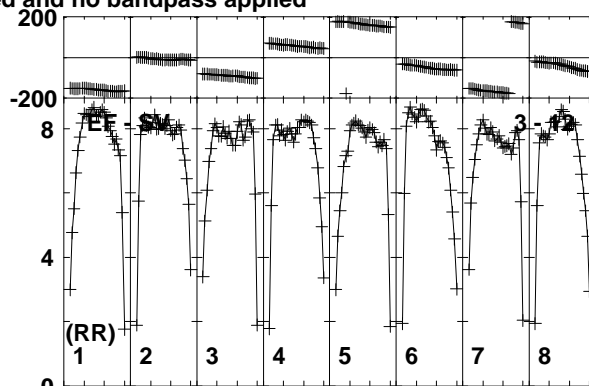
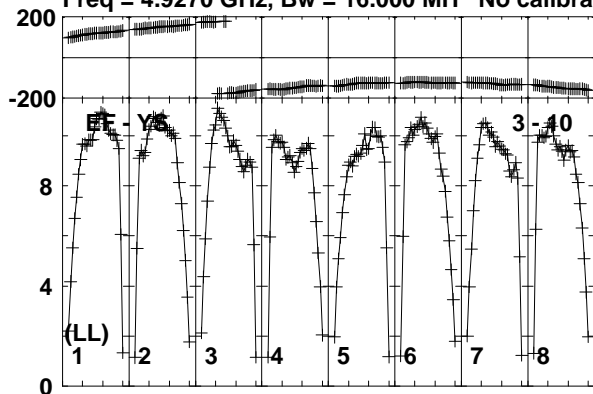

Lower frame: Milli Ampl Jy Top frame: Phas deg  
Vector averaged cross-power spectrum Baseline: EF (03) - YS (10)  
Timerange: 00/19:01:31 to 00/19:02:29

Plot file version1014 created 19-DEC-2018 17:59:17

VLA1 RY007C.UVDATA.1

Freq = 4.9270 GHz, Bw = 16.000 MH No calibration applied and no bandpass applied

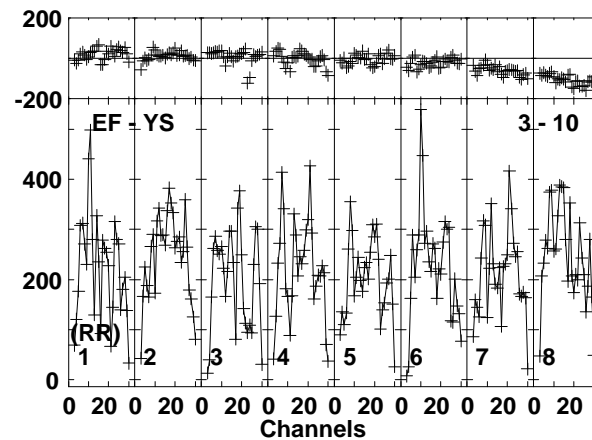
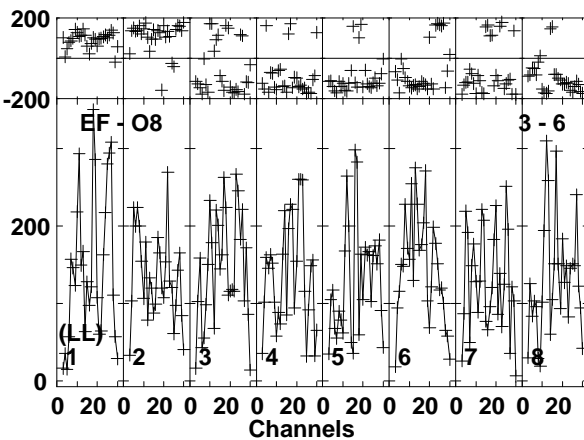
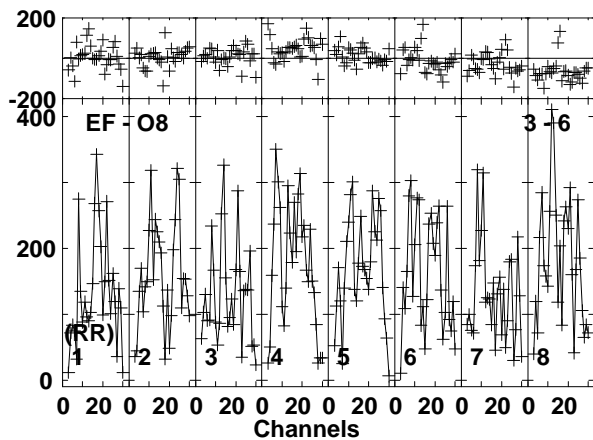
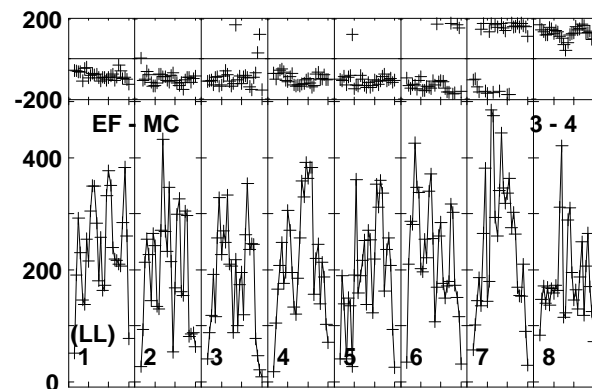
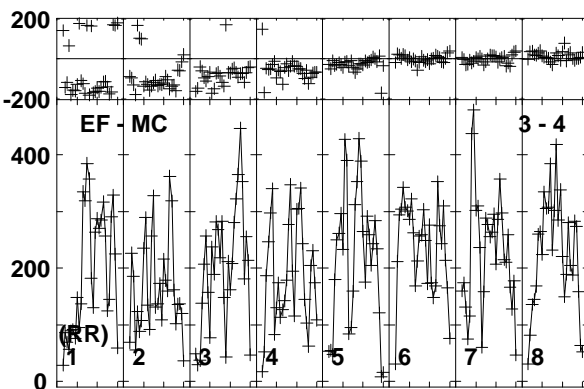
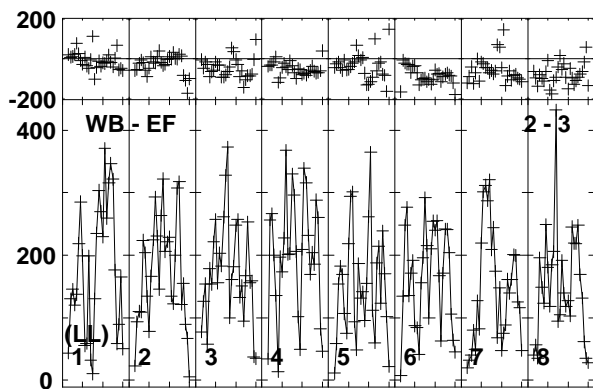
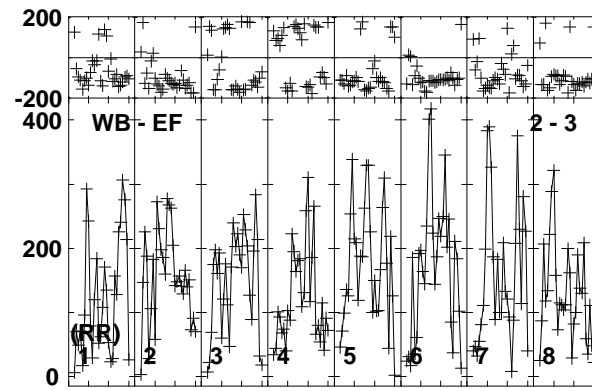
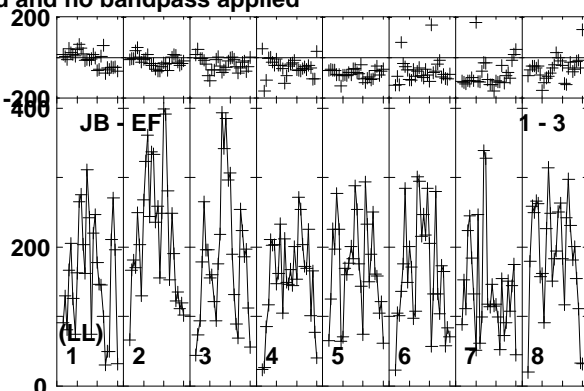
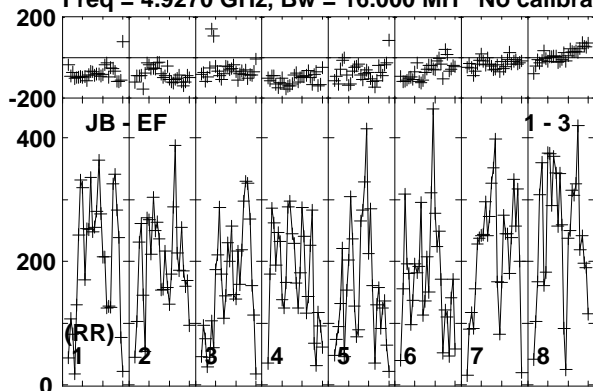

Lower frame: Micro Ampl Jy Top frame: Phas deg  
Vector averaged cross-power spectrum Baseline: JB (01) - EF (03)  
Timerange: 00/19:03:01 to 00/19:04:59

Plot file version1015 created 19-DEC-2018 17:59:17

VLA1 RY007C.UVDATA.1

Freq = 4.9270 GHz, Bw = 16.000 MH No calibration applied and no bandpass applied

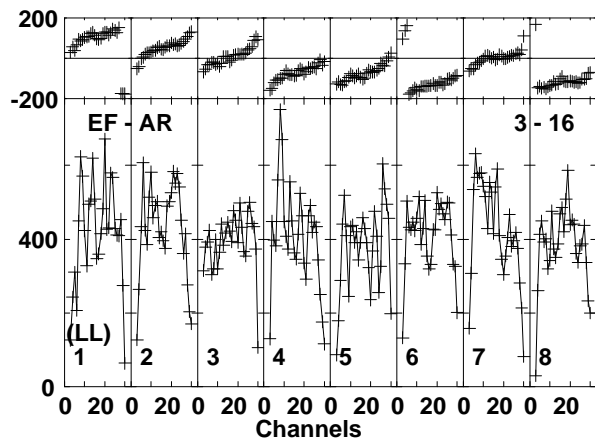
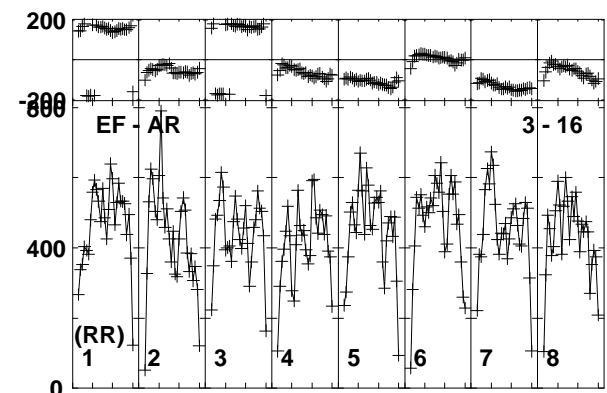
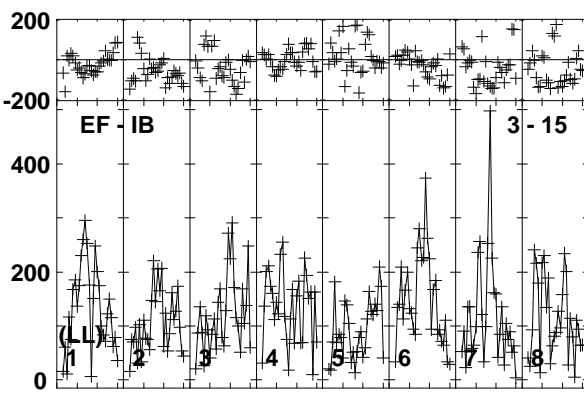
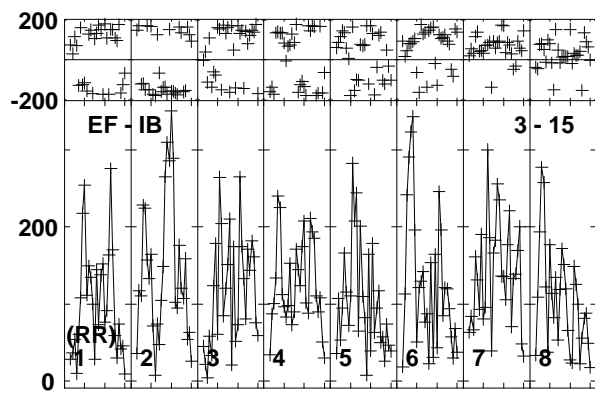
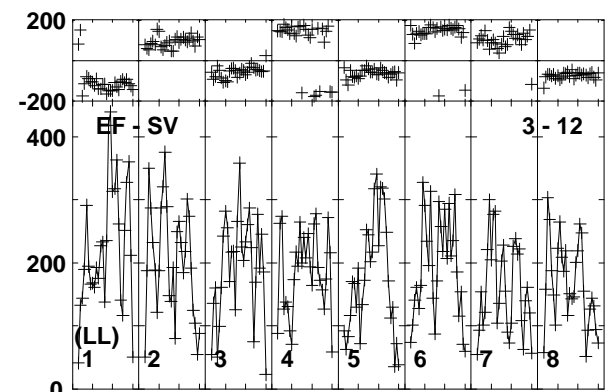
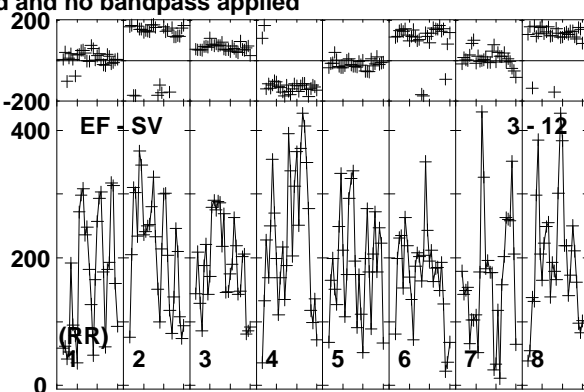
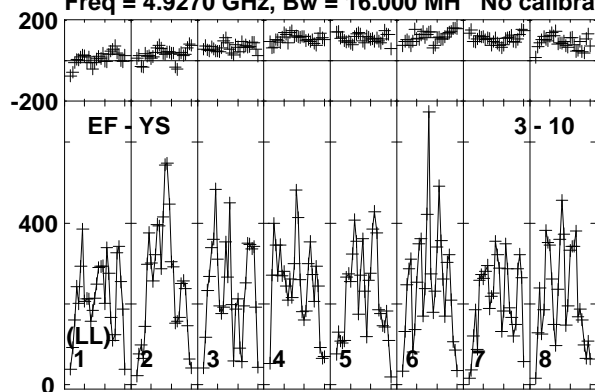

Lower frame: Micro Ampl Jy Top frame: Phas deg  
Vector averaged cross-power spectrum Baseline: EF (03) - YS (10)  
Timerange: 00/19:03:01 to 00/19:04:59

Plot file version1016 created 19-DEC-2018 17:59:17

J1619+2247 RY007C.UVDATA.1

Freq = 4.9270 GHz, Bw = 16.000 MH No calibration applied and no bandpass applied

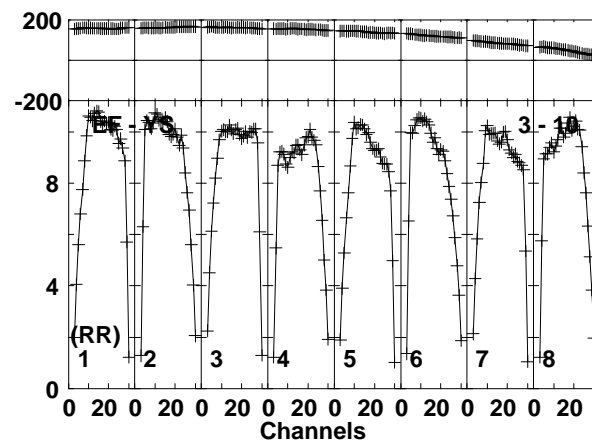
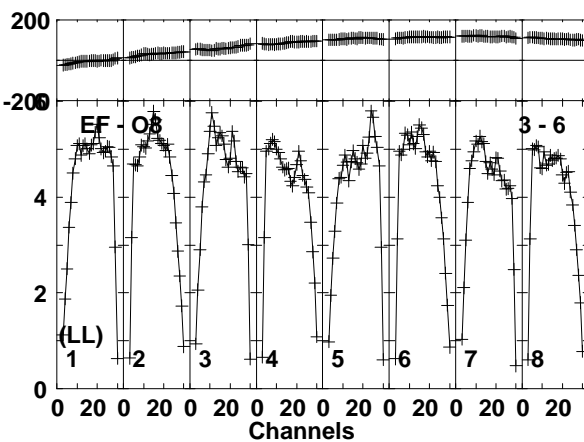
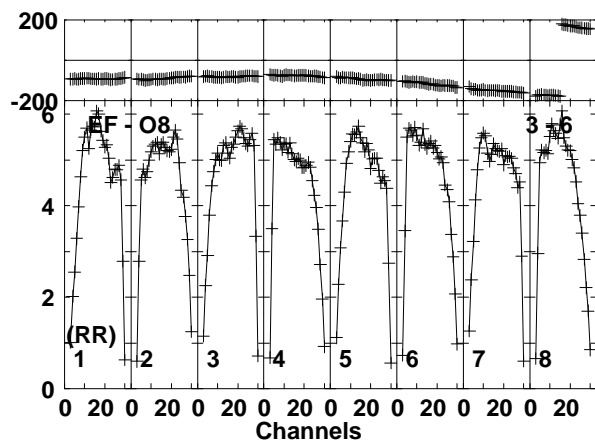
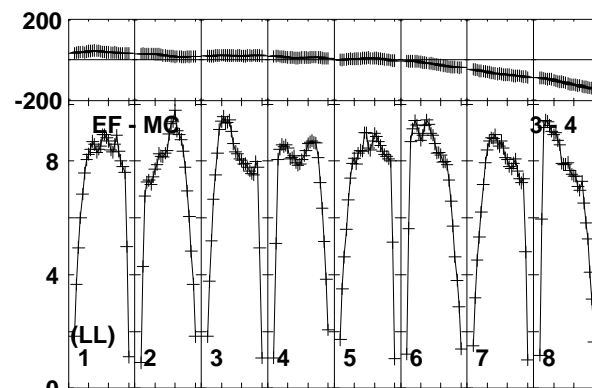
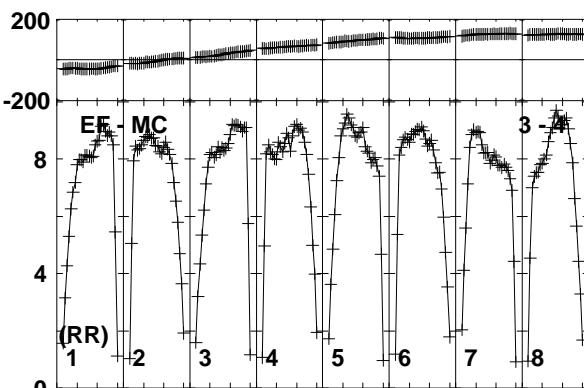
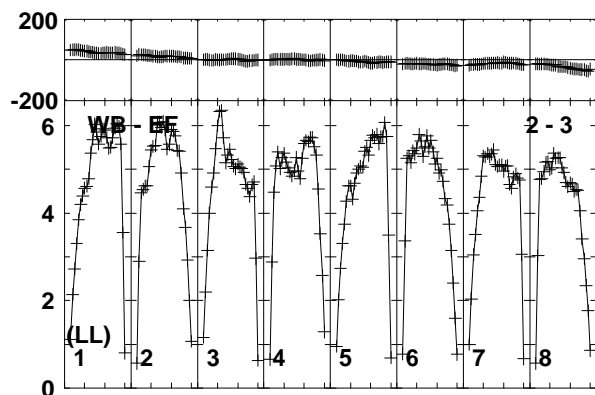
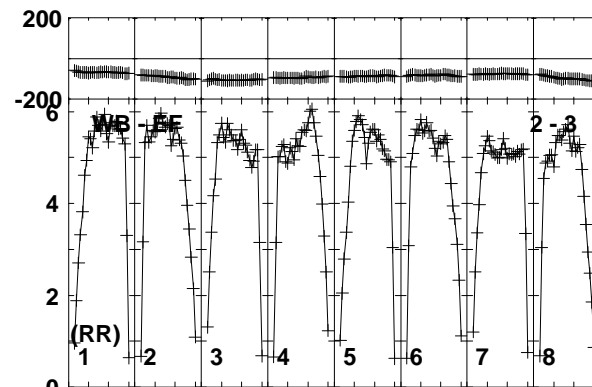
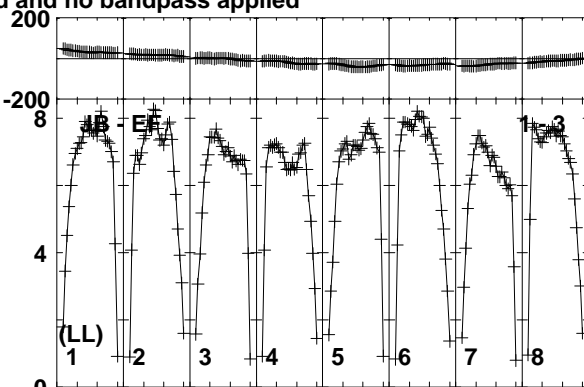
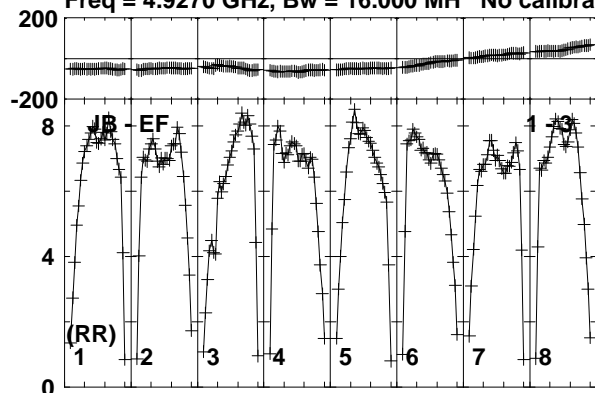

Lower frame: Milli Ampl Jy Top frame: Phas deg  
Vector averaged cross-power spectrum Baseline: JB (01) - EF (03)  
Timerange: 00/19:05:01 to 00/19:05:59

Plot file version1017 created 19-DEC-2018 17:59:17

J1619+2247 RY007C.UVDATA.1

Freq = 4.9270 GHz, Bw = 16.000 MH No calibration applied and no bandpass applied

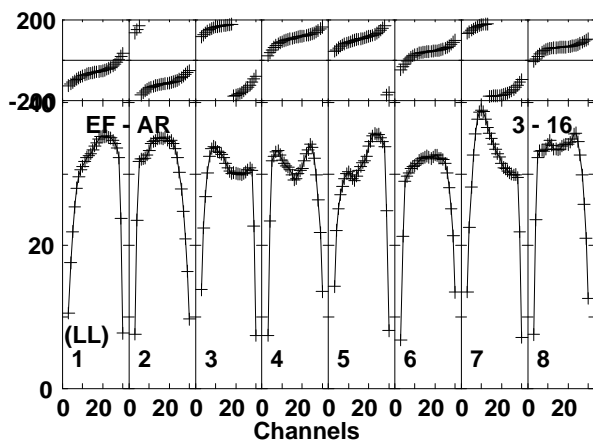
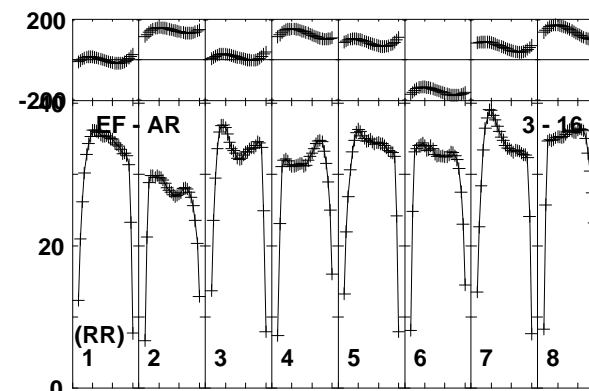
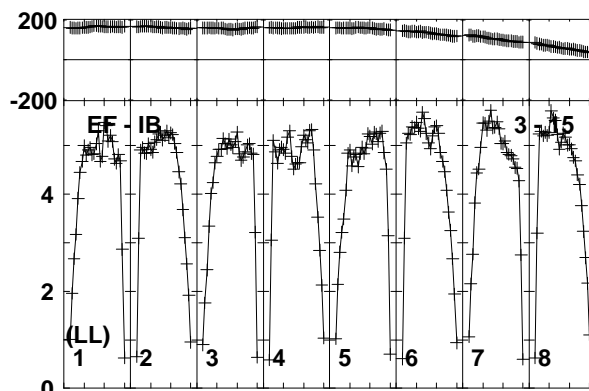
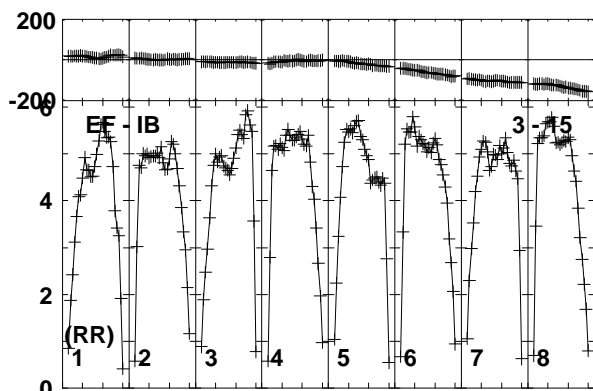
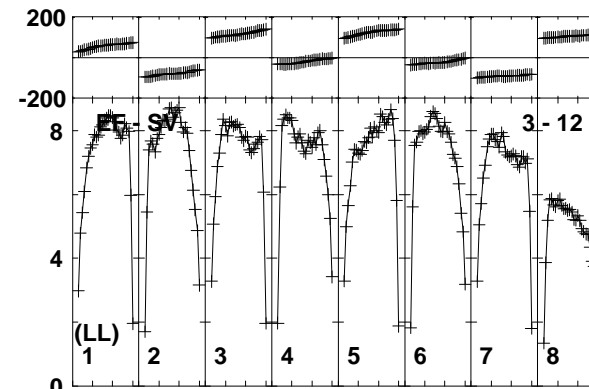
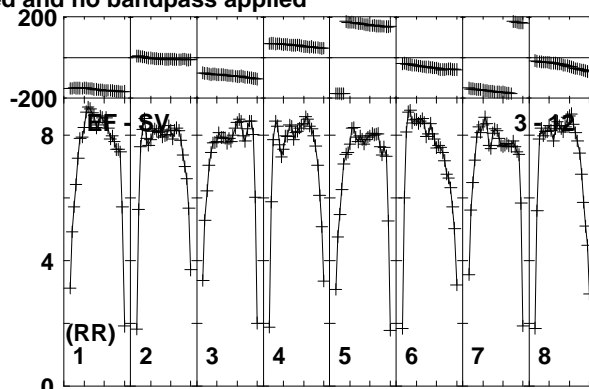
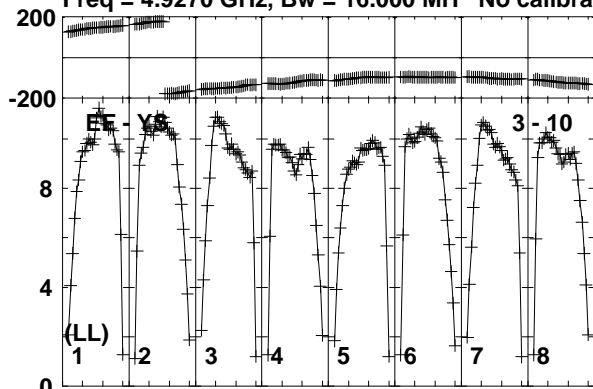

Lower frame: Milli Ampl Jy Top frame: Phas deg  
Vector averaged cross-power spectrum Baseline: EF (03) - YS (10)  
Timerange: 00/19:05:01 to 00/19:05:59

Plot file version1018 created 19-DEC-2018 17:59:17

AT2018\_RY007C.UVDATA.1

Freq = 4.9270 GHz, Bw = 16.000 MH No calibration applied and no bandpass applied

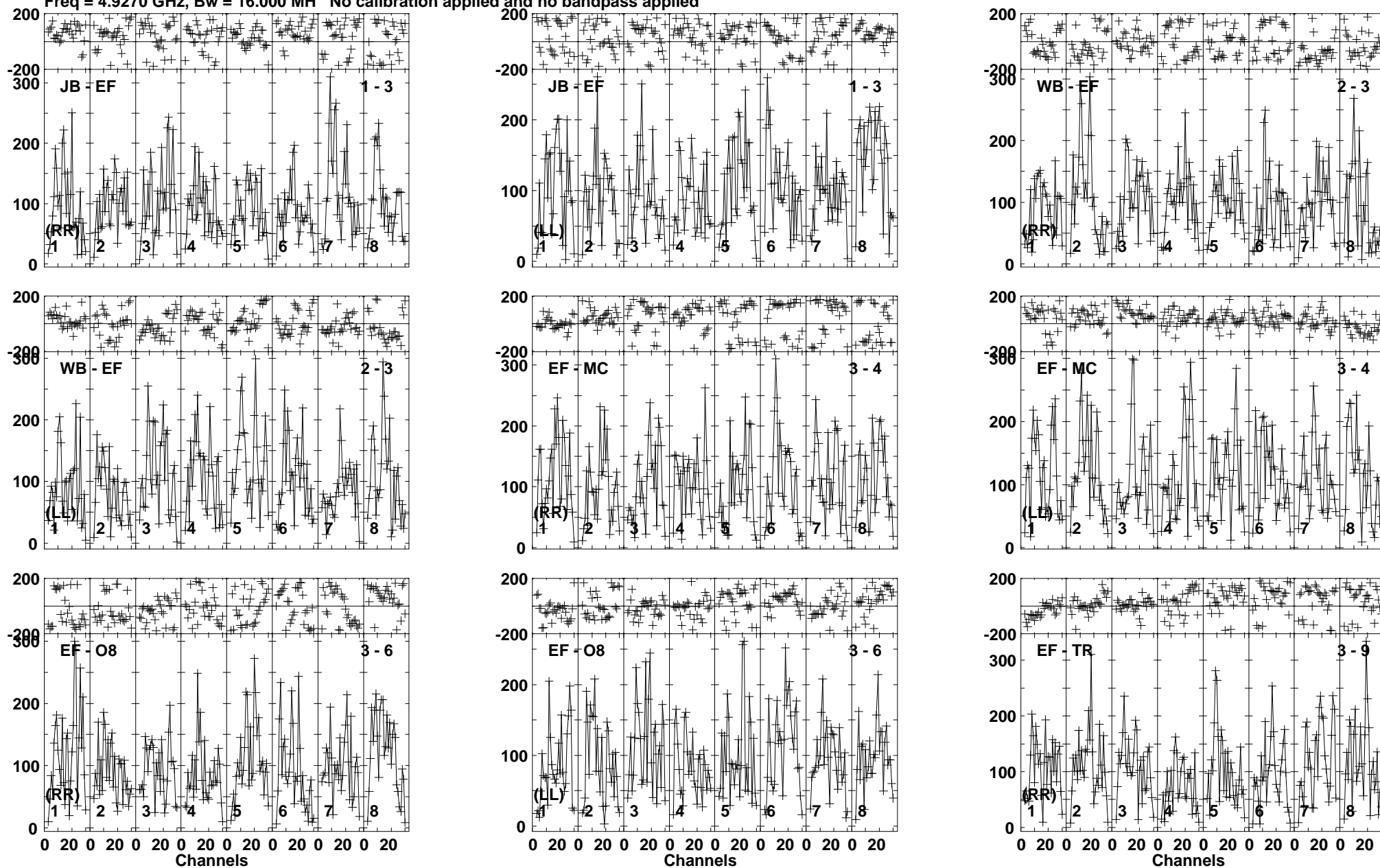

Lower frame: Micro Ampl Jy Top frame: Phas deg  
Vector averaged cross-power spectrum Baseline: JB (01) - EF (03)  
Timerange: 00/19:06:01 to 00/19:08:59



Plot file version1019 created 19-DEC-2018 17:59:18

AT2018\_RY007C.UVDATA.1

Freq = 4.9270 GHz, Bw = 16.000 MH No calibration applied and no bandpass applied

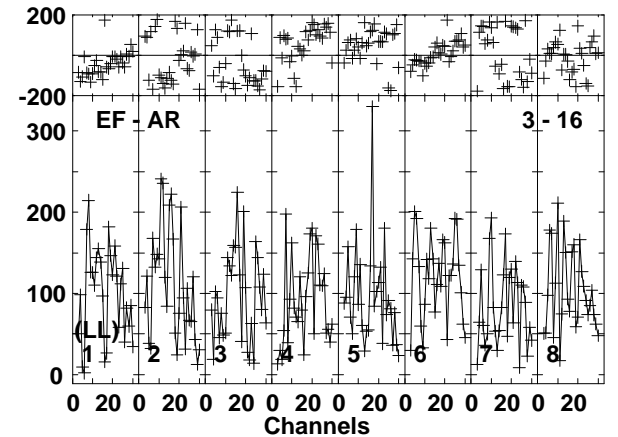
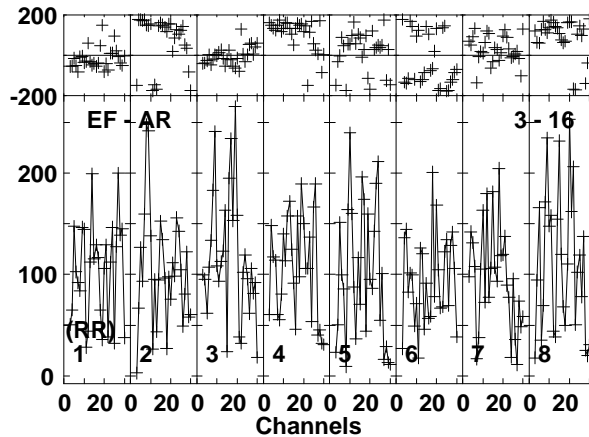
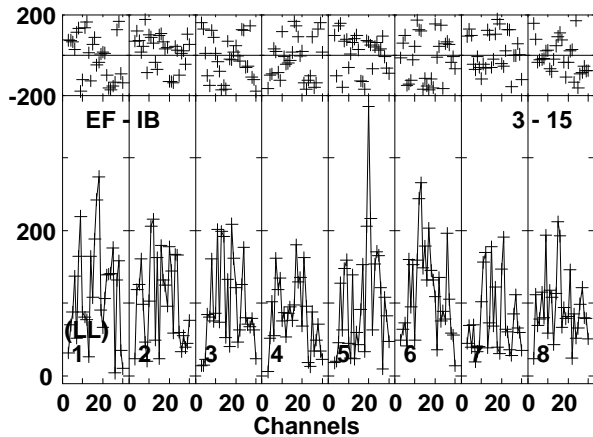
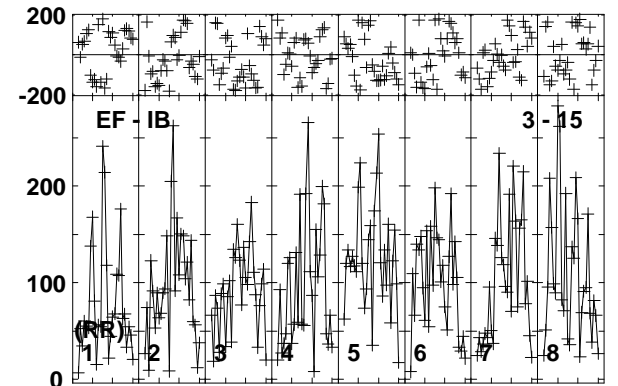
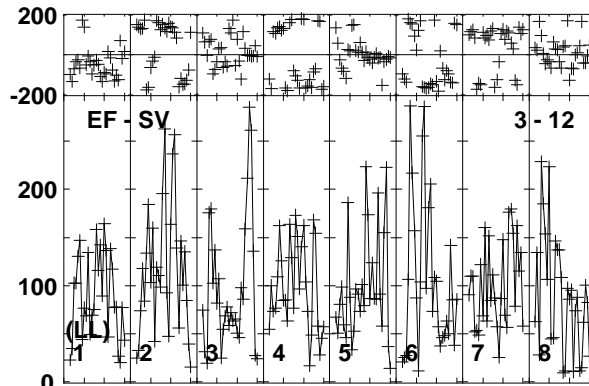
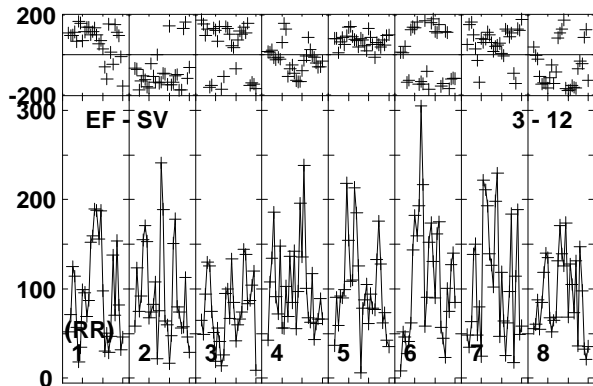
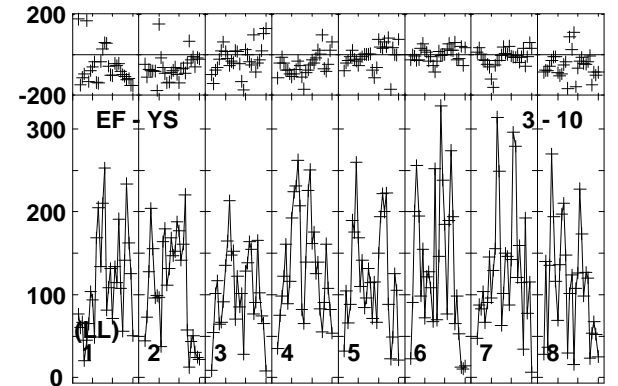
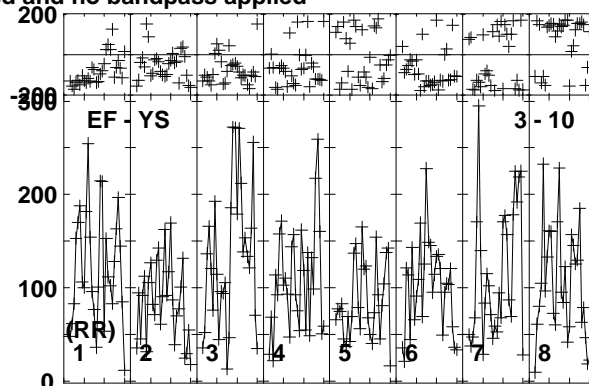
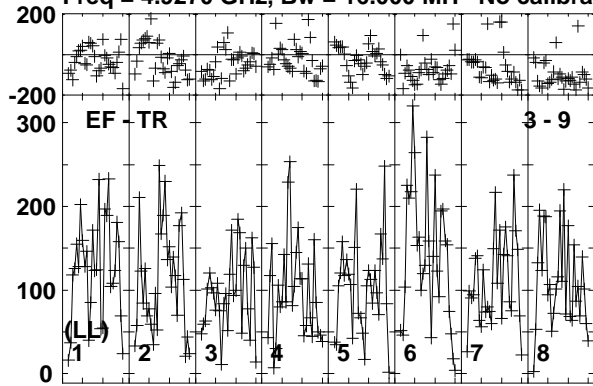

Lower frame: Micro Ampl Jy Top frame: Phas deg  
Vector averaged cross-power spectrum Baseline: EF (03) - TR (09)  
Timerange: 00/19:06:01 to 00/19:08:59

Plot file version1020 created 19-DEC-2018 17:59:18

J1619+2247 RY007C.UVDATA.1

Freq = 4.9270 GHz, Bw = 16.000 MH No calibration applied and no bandpass applied

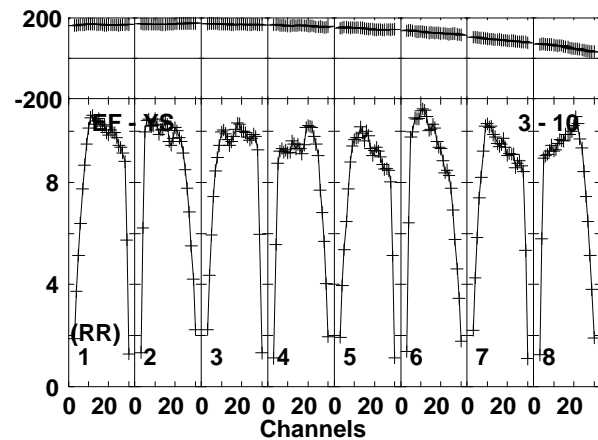
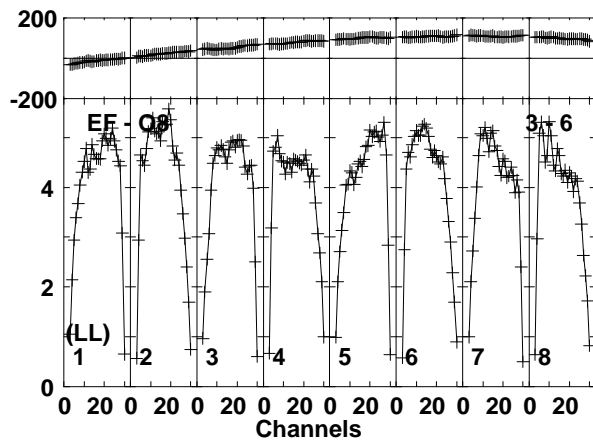
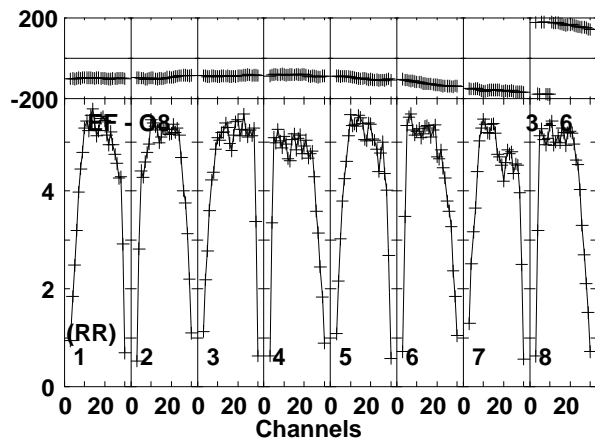
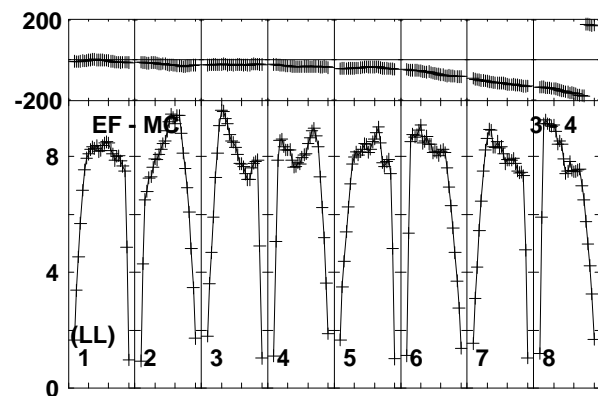
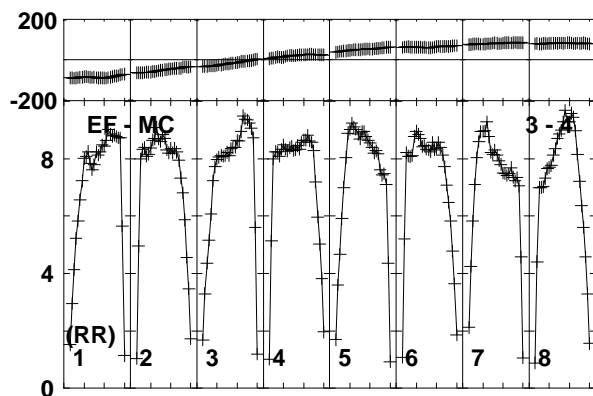
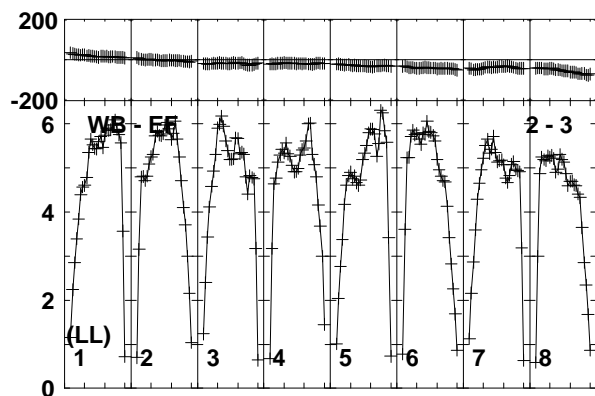
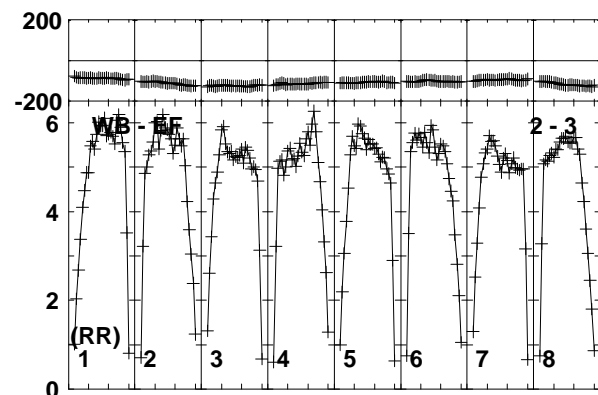
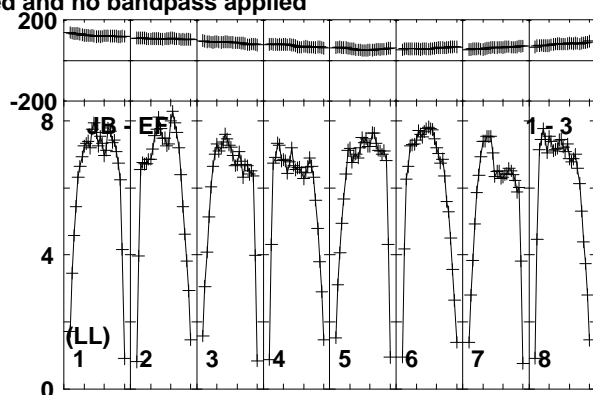
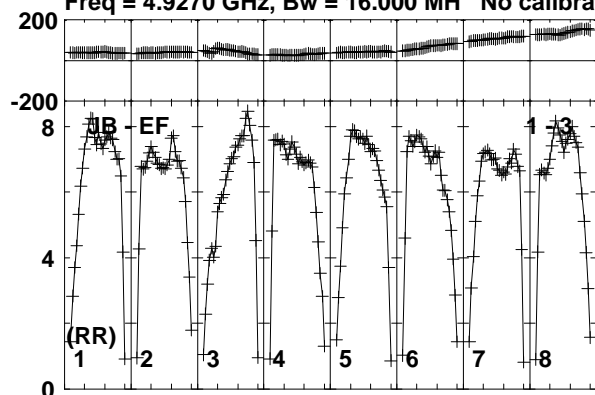

Lower frame: Milli Ampl Jy Top frame: Phas deg  
Vector averaged cross-power spectrum Baseline: JB (01) - EF (03)  
Timerange: 00/19:09:01 to 00/19:09:59

Plot file version1021 created 19-DEC-2018 17:59:18

J1619+2247 RY007C.UVDATA.1

Freq = 4.9270 GHz, Bw = 16.000 MH No calibration applied and no bandpass applied

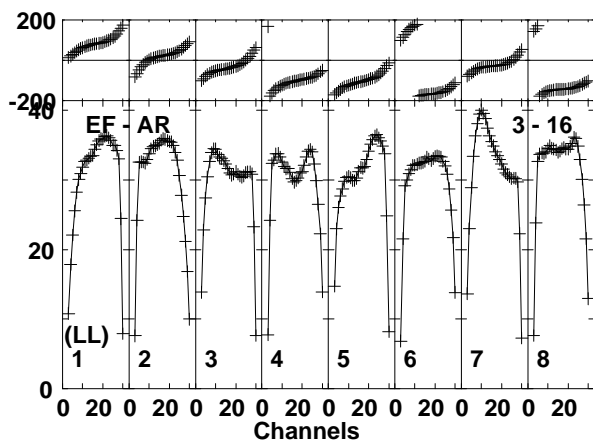
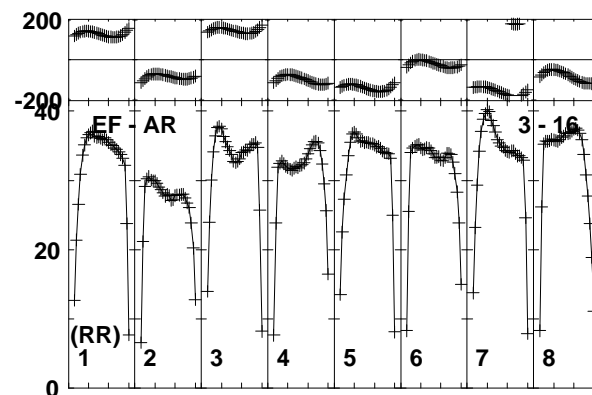
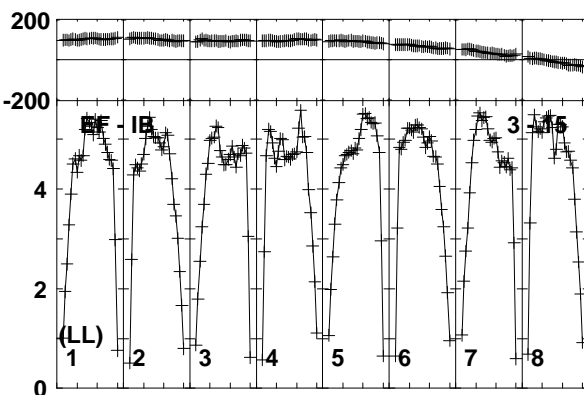
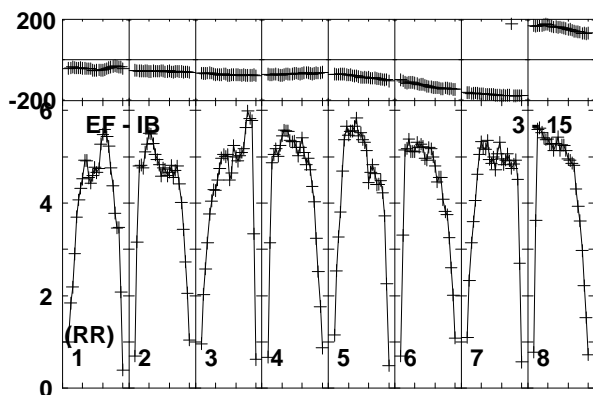
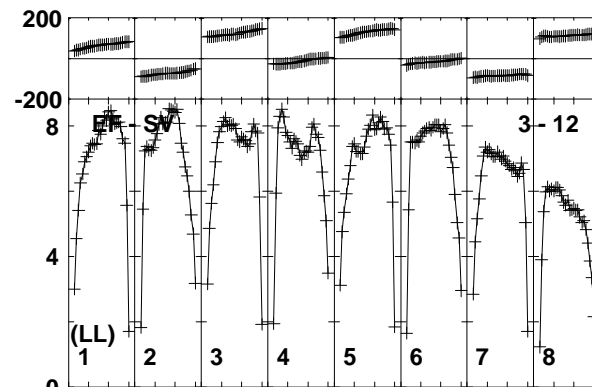
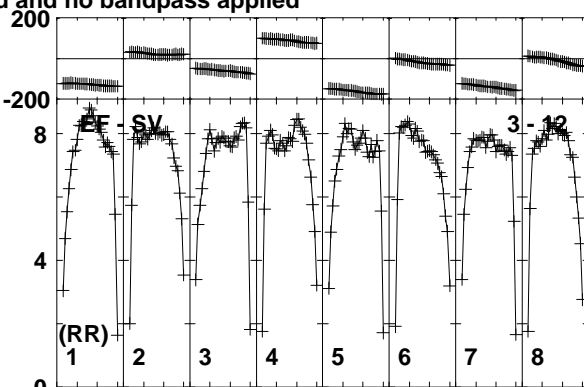
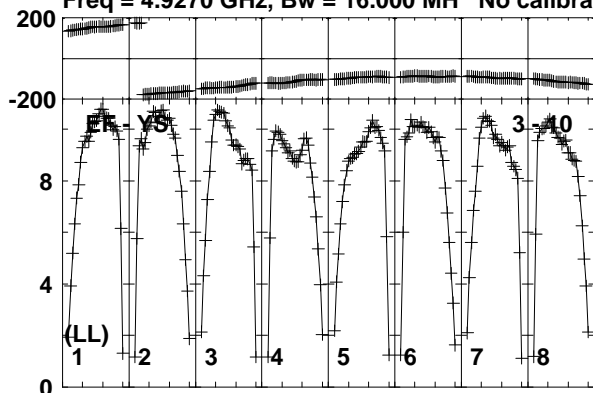

Lower frame: Milli Ampl Jy Top frame: Phas deg  
Vector averaged cross-power spectrum Baseline: EF (03) - YS (10)  
Timerange: 00/19:09:01 to 00/19:09:59

Plot file version1022 created 19-DEC-2018 17:59:18

AT2018\_RY007C.UVDATA.1

Freq = 4.9270 GHz, Bw = 16.000 MH No calibration applied and no bandpass applied

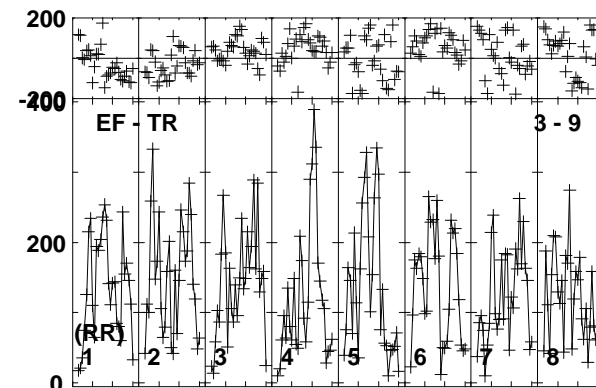
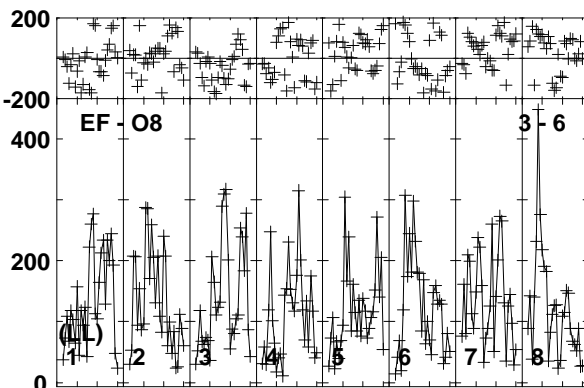
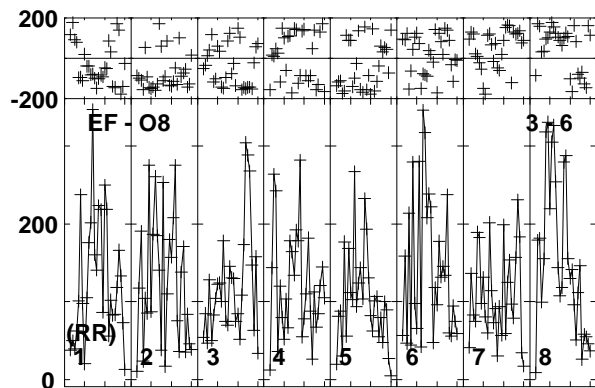
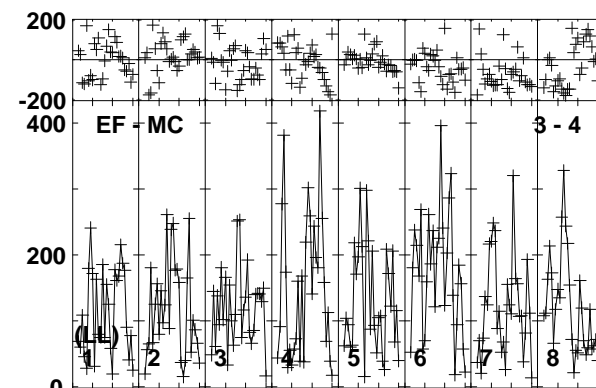
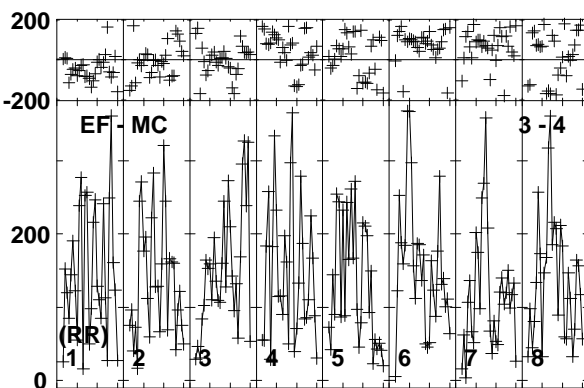
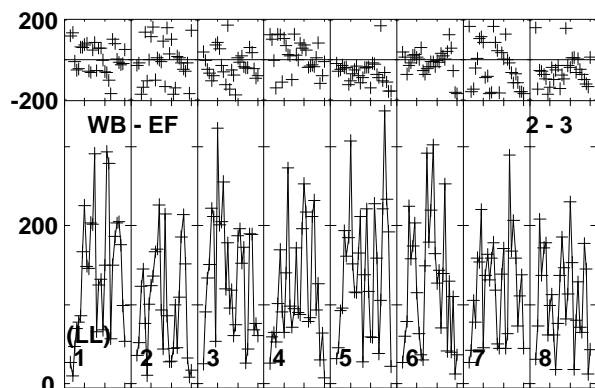
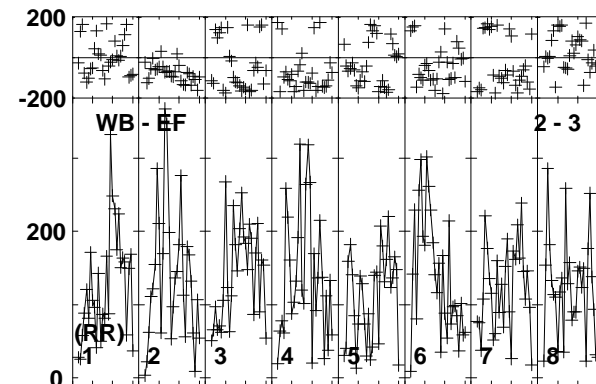
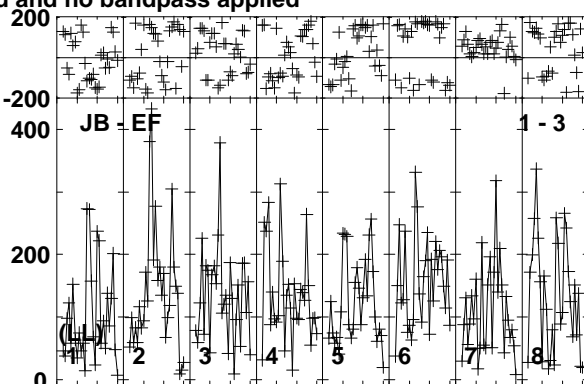
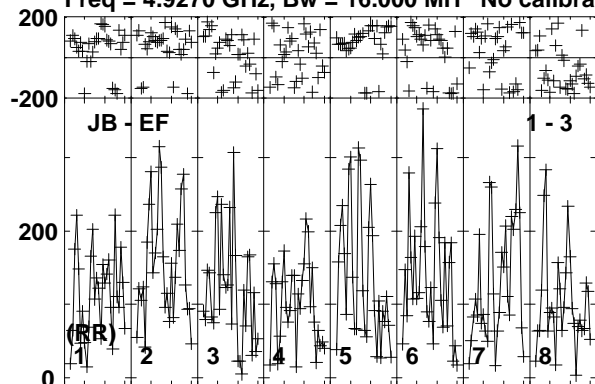

Lower frame: Micro Ampl Jy Top frame: Phas deg  
Vector averaged cross-power spectrum Baseline: JB (01) - EF (03)  
Timerange: 00/19:10:01 to 00/19:11:59

Plot file version1023 created 19-DEC-2018 17:59:18  
AT2018\_RY007C.UVDATA.1

Freq = 4.9270 GHz, Bw = 16.000 MH No calibration applied and no bandpass applied

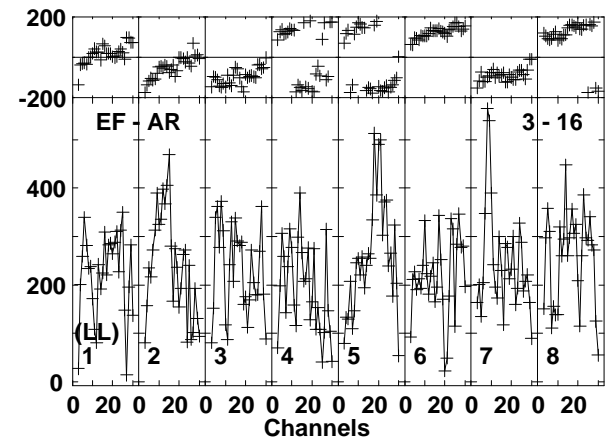
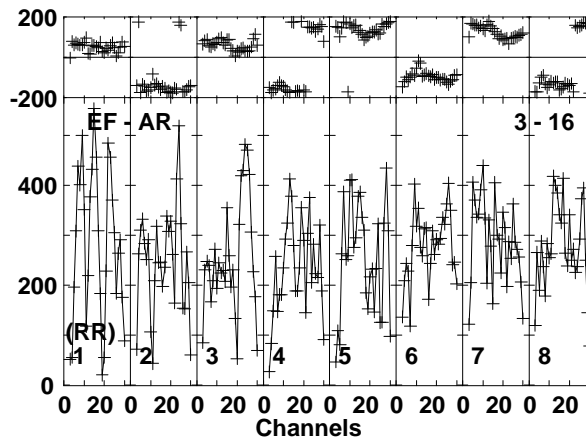
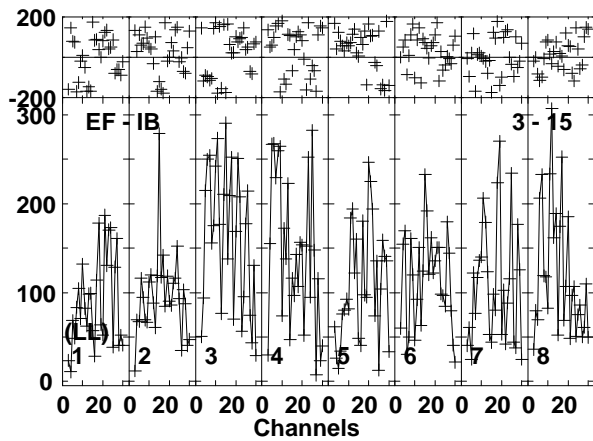
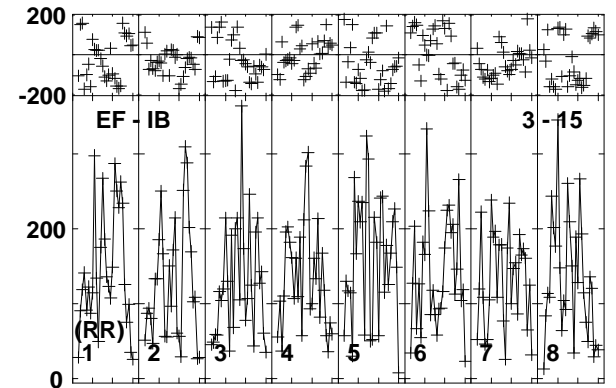
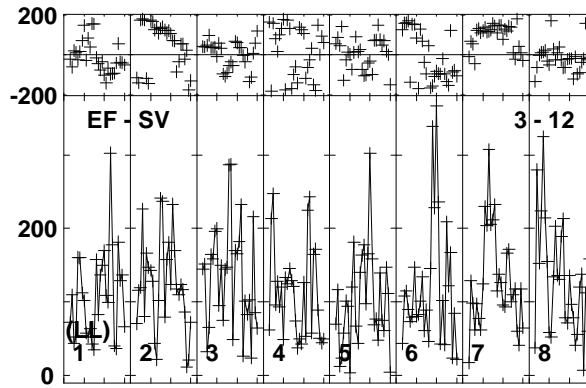
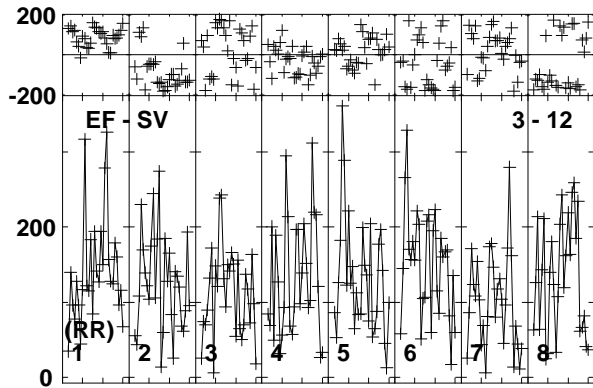
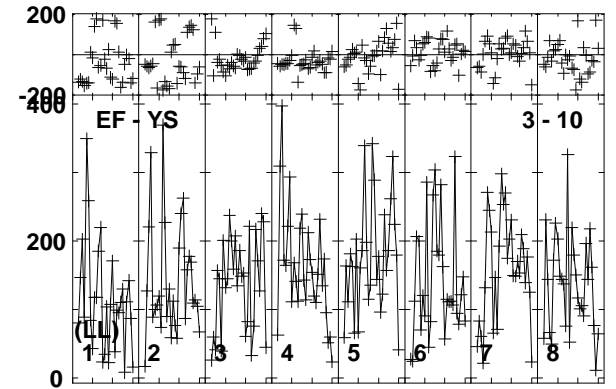
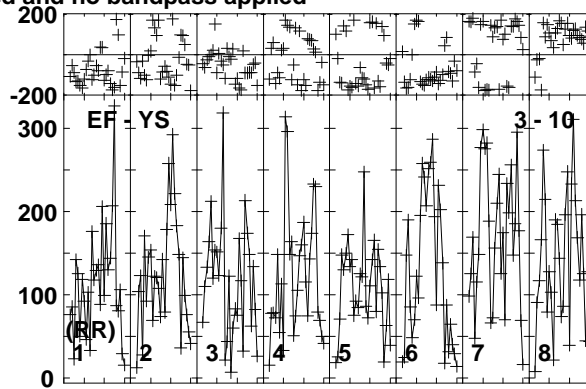
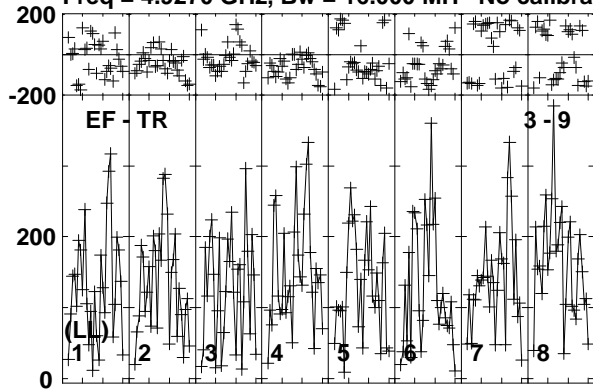

Lower frame: Micro Ampl Jy Top frame: Phas deg  
Vector averaged cross-power spectrum Baseline: EF (03) - TR (09)  
Timerange: 00:19:10:01 to 00:19:11:59

Plot file version1024 created 19-DEC-2018 17:59:18

VLA2 RY007C.UVDATA.1

Freq = 4.9270 GHz, Bw = 16.000 MH No calibration applied and no bandpass applied

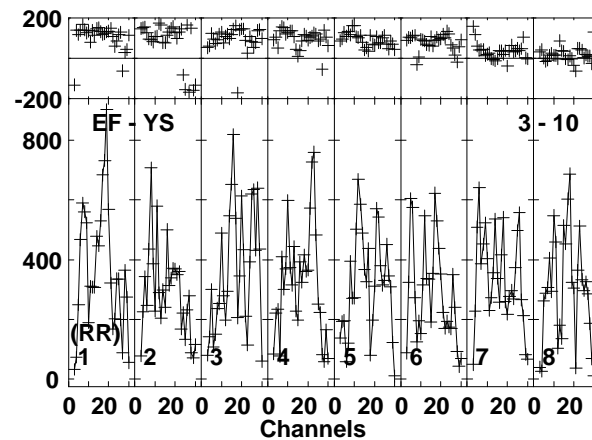
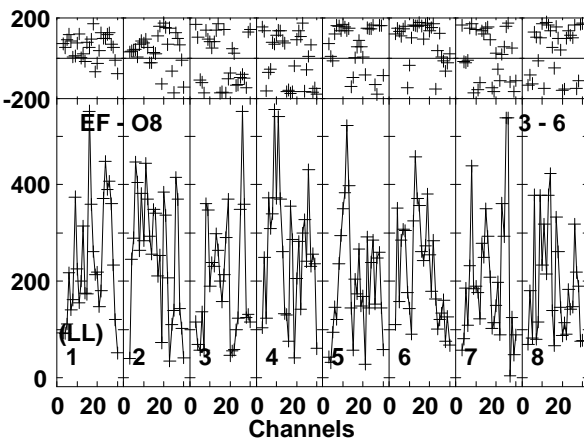
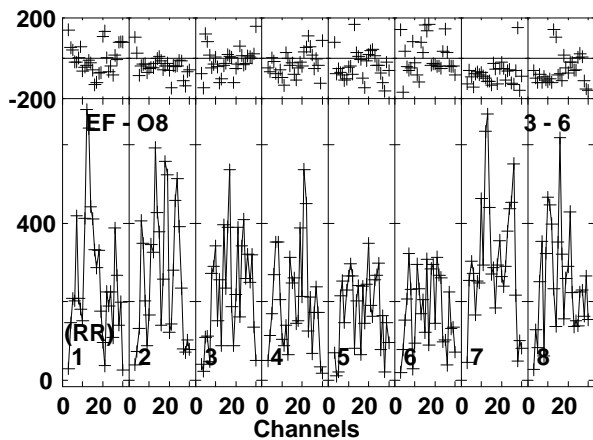
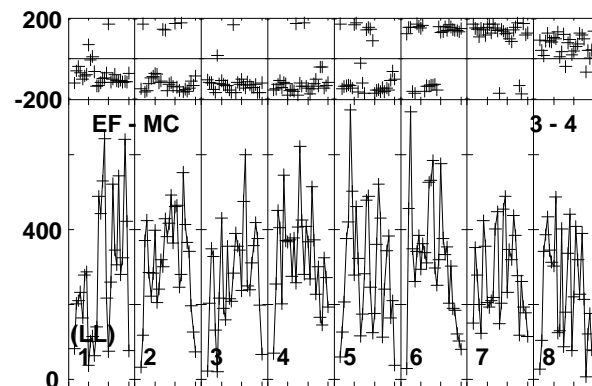
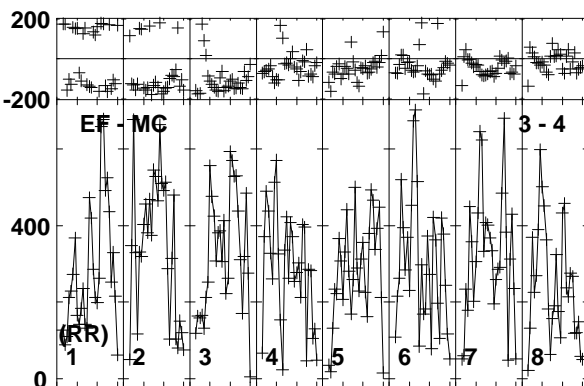
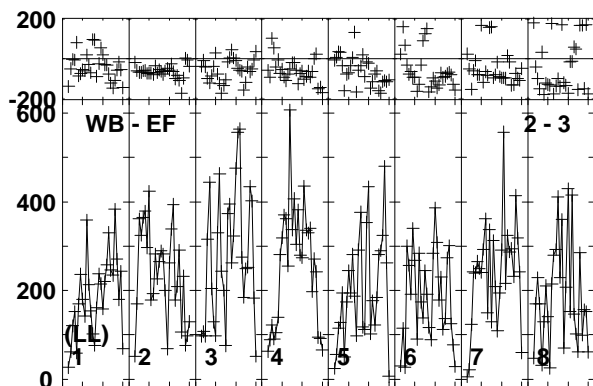
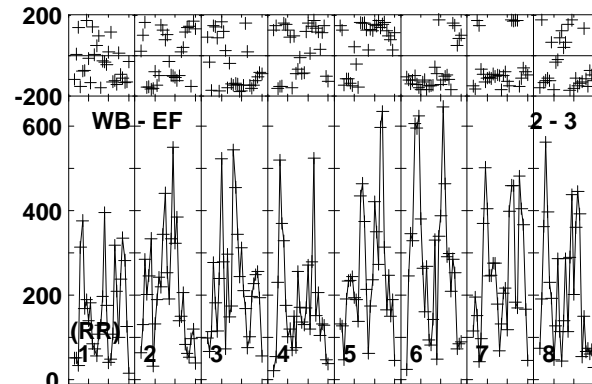
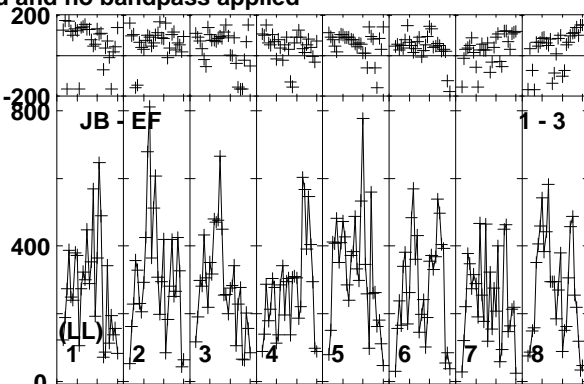
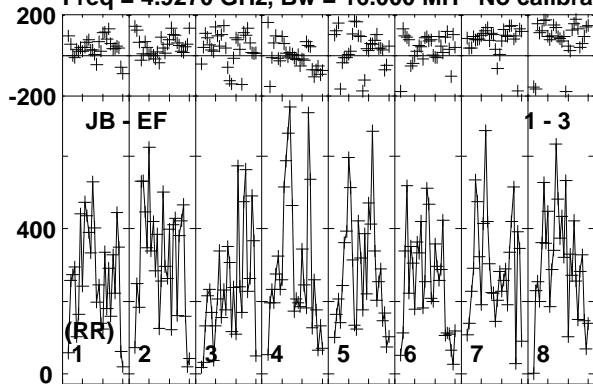

Lower frame: Micro Ampl Jy Top frame: Phas deg  
Vector averaged cross-power spectrum Baseline: JB (01) - EF (03)  
Timerange: 00/19:12:01 to 00/19:12:59

Plot file version1025 created 19-DEC-2018 17:59:18

VLA2 RY007C.UVDATA.1

Freq = 4.9270 GHz, Bw = 16.000 MH No calibration applied and no bandpass applied

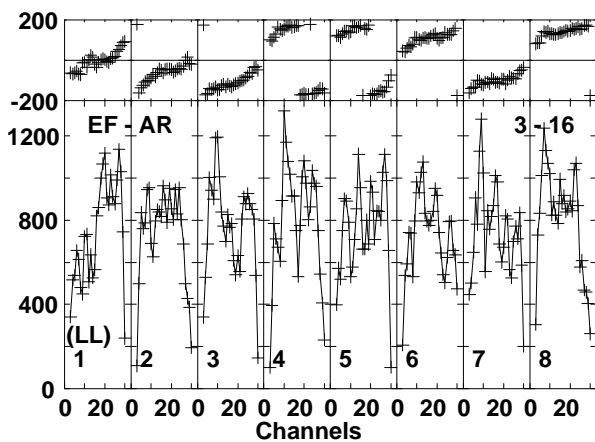
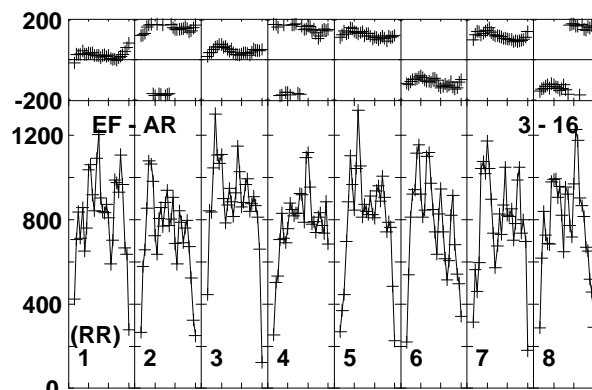
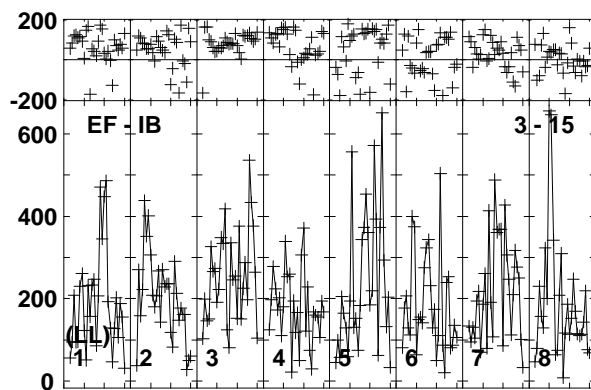
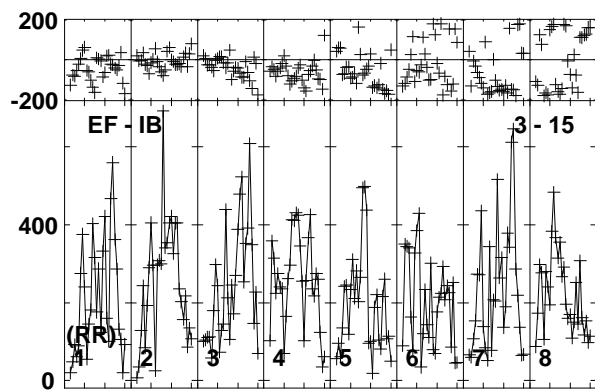
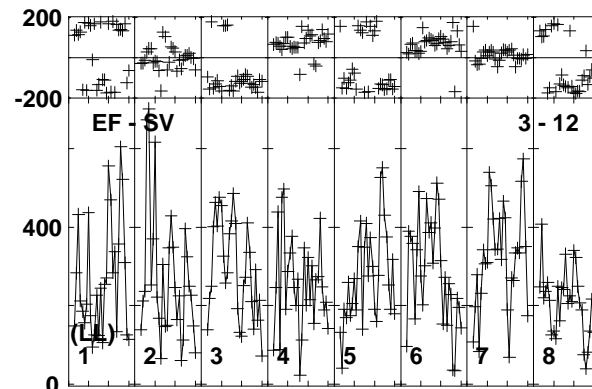
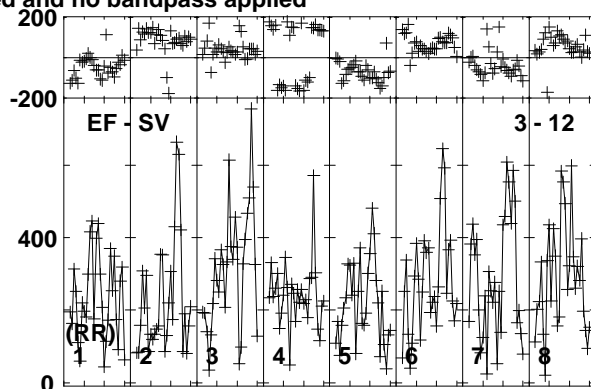
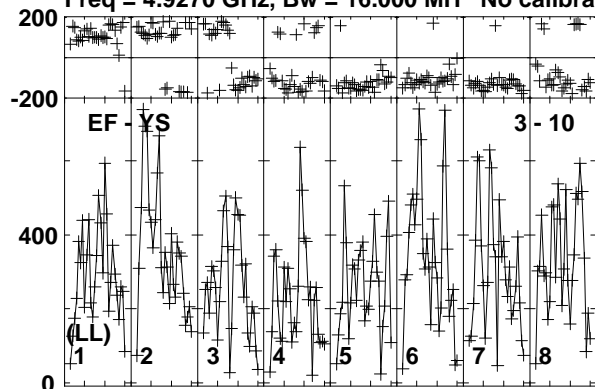

Lower frame: Micro Ampl Jy Top frame: Phas deg  
Vector averaged cross-power spectrum Baseline: EF (03) - YS (10)  
Timerange: 00/19:12:01 to 00/19:12:59

Plot file version1026 created 19-DEC-2018 17:59:18

J1619+2247 RY007C.UVDATA.1

Freq = 4.9270 GHz, Bw = 16.000 MH No calibration applied and no bandpass applied

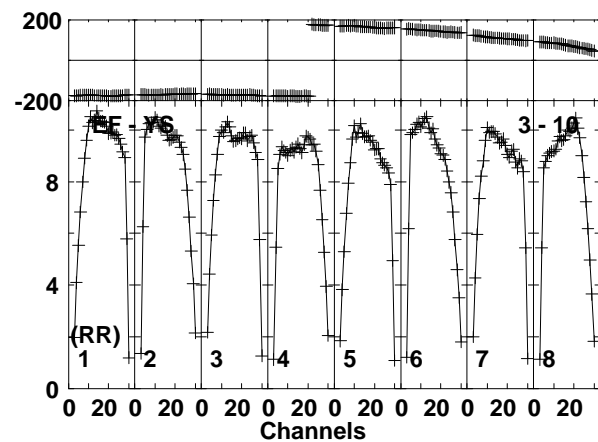
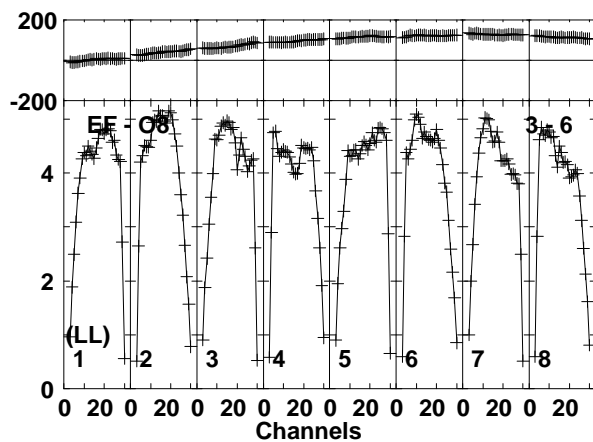
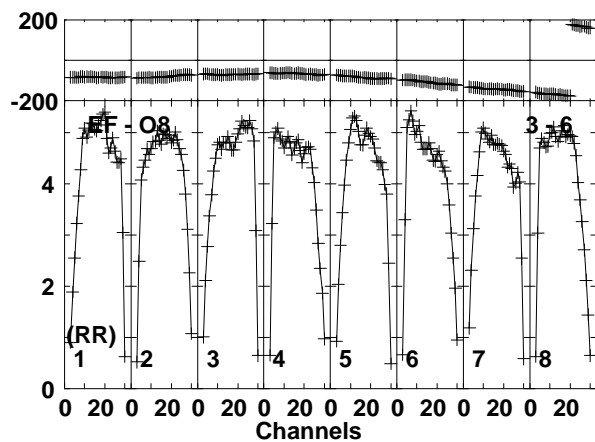
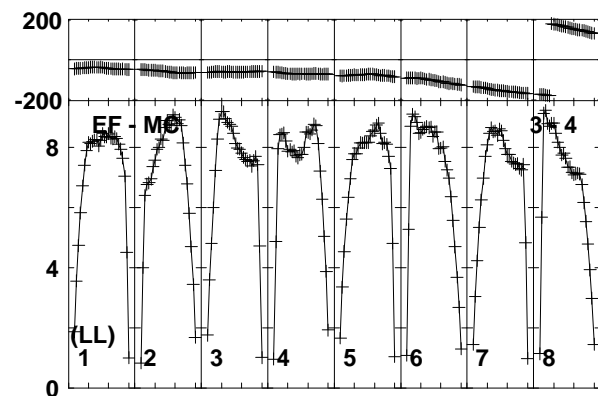
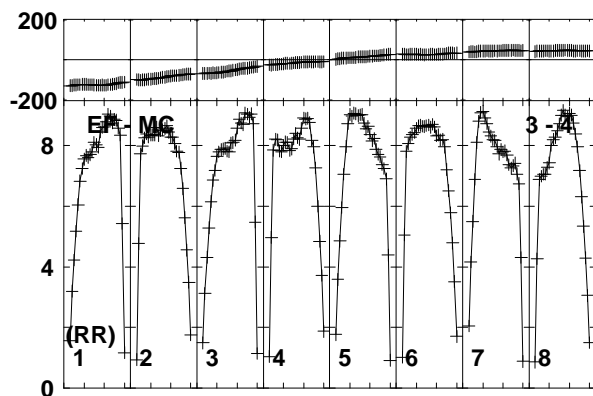
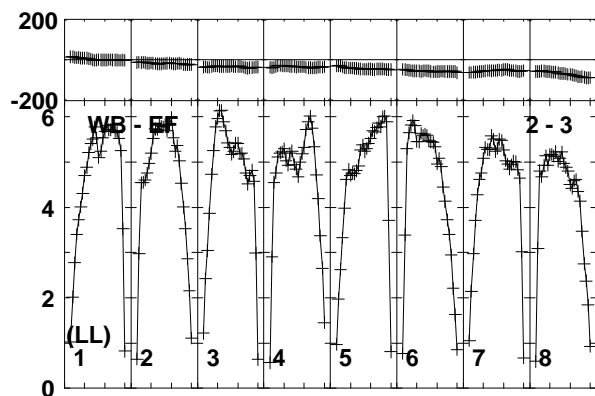
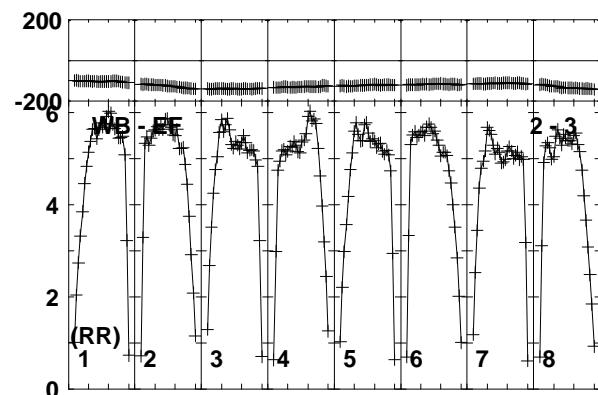
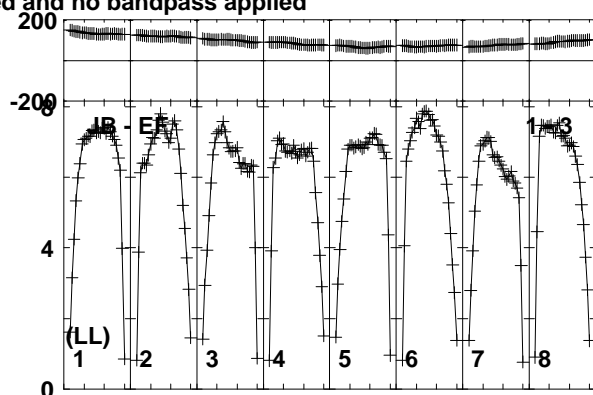
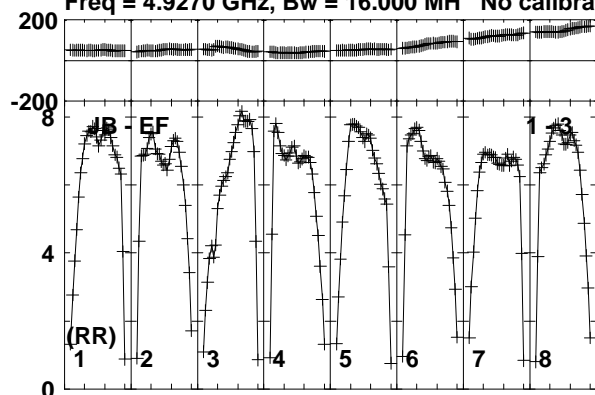

Lower frame: Milli Ampl Jy Top frame: Phas deg  
Vector averaged cross-power spectrum Baseline: JB (01) - EF (03)  
Timerange: 00/19:13:31 to 00/19:14:29



Plot file version1027 created 19-DEC-2018 17:59:18

J1619+2247 RY007C.UVDATA.1

Freq = 4.9270 GHz, Bw = 16.000 MH No calibration applied and no bandpass applied

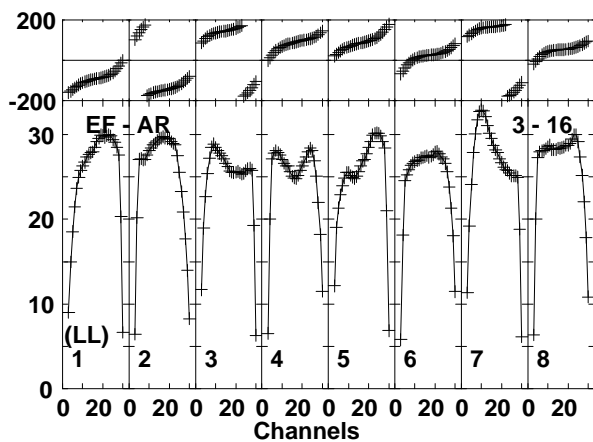
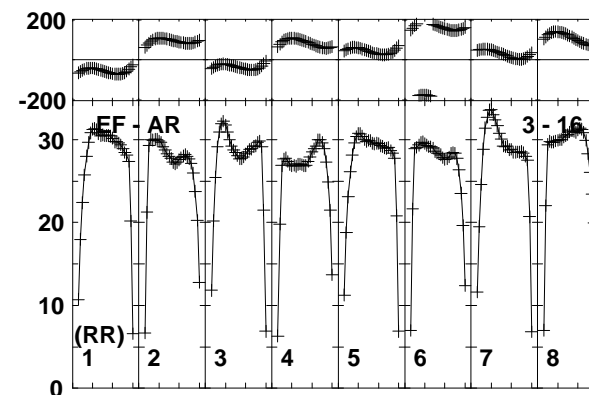
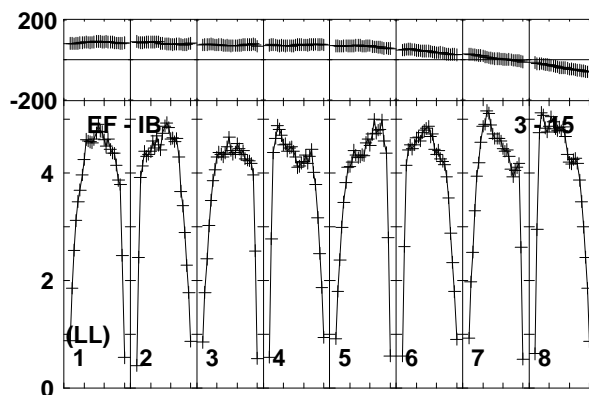
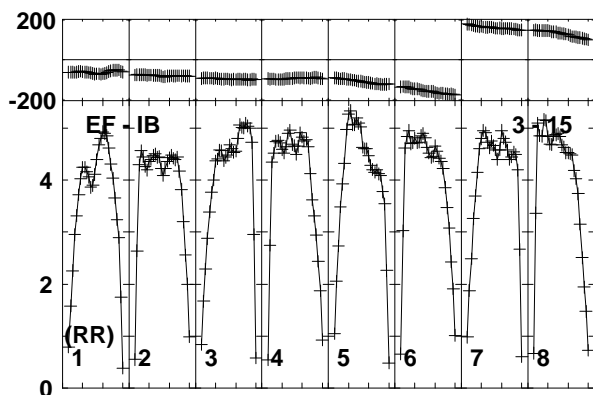
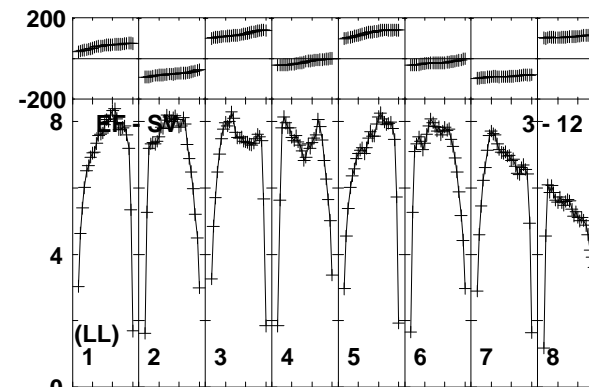
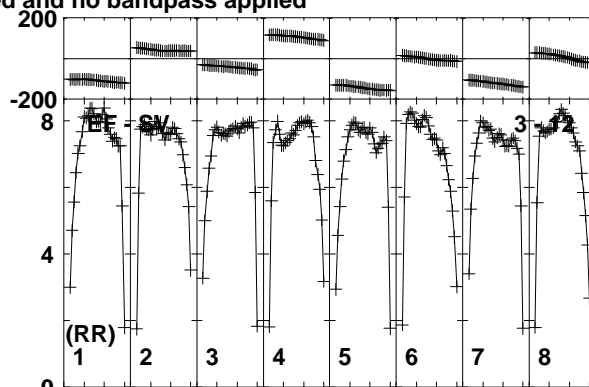
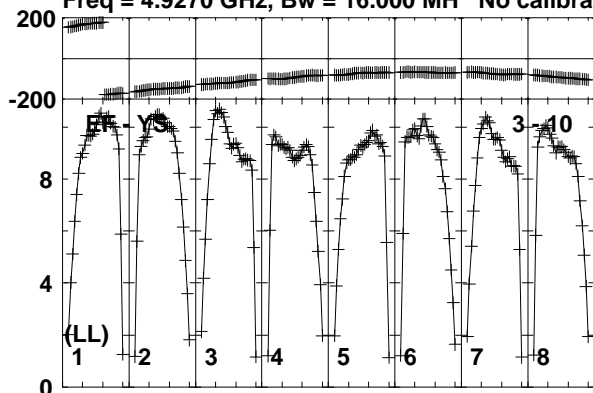

Lower frame: Milli Ampl Jy Top frame: Phas deg  
Vector averaged cross-power spectrum Baseline: EF (03) - YS (10)  
Timerange: 00/19:13:31 to 00/19:14:29

Plot file version1028 created 19-DEC-2018 17:59:18

AT2018\_RY007C.UVDATA.1

Freq = 4.9270 GHz, Bw = 16.000 MH No calibration applied and no bandpass applied

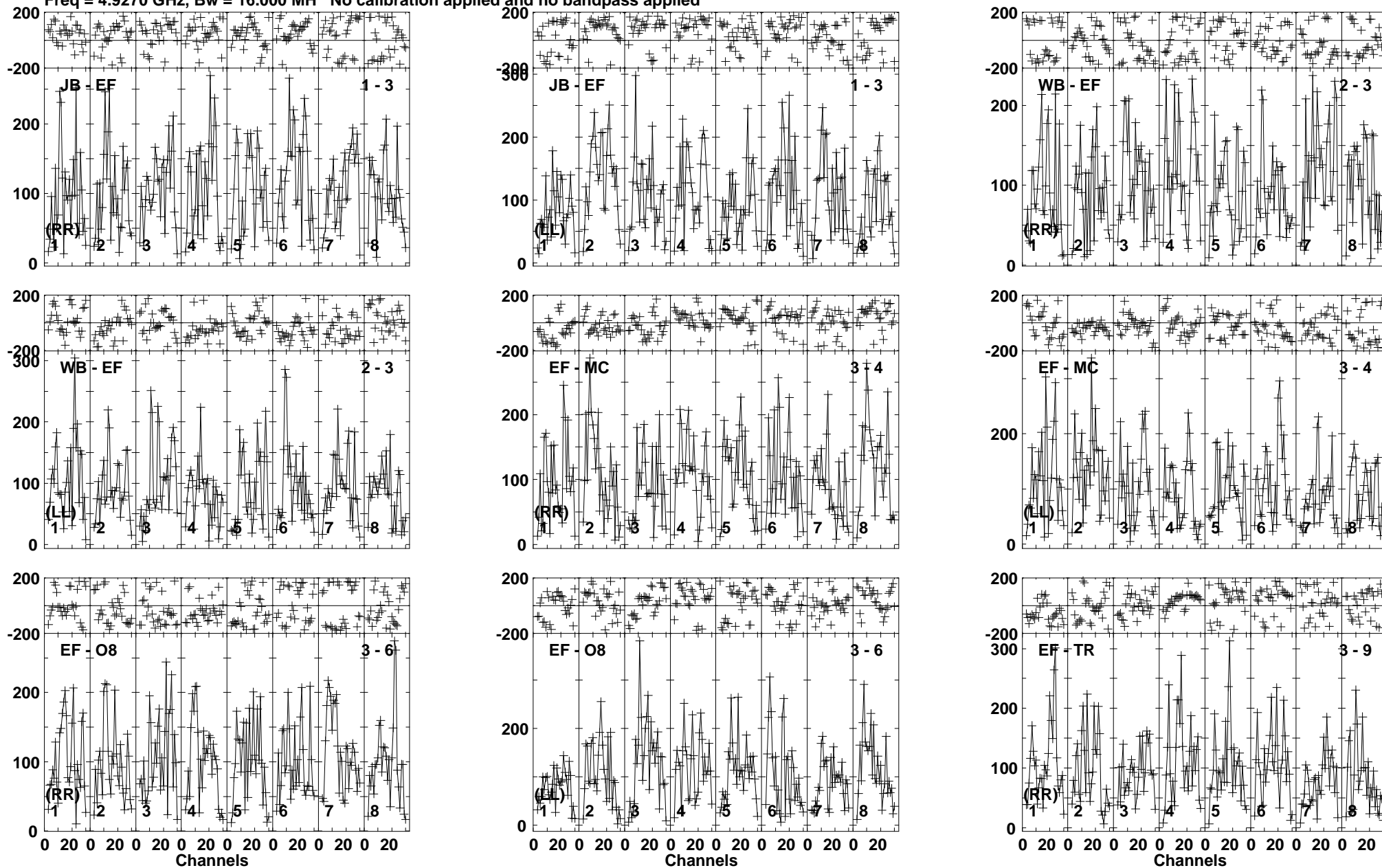

Lower frame: Micro Ampl Jy Top frame: Phas deg  
Vector averaged cross-power spectrum Baseline: JB (01) - EF (03)  
Timerange: 00/19:14:31 to 00/19:17:29

Plot file version1029 created 19-DEC-2018 17:59:18

AT2018\_RY007C.UVDATA.1

Freq = 4.9270 GHz, Bw = 16.000 MH No calibration applied and no bandpass applied

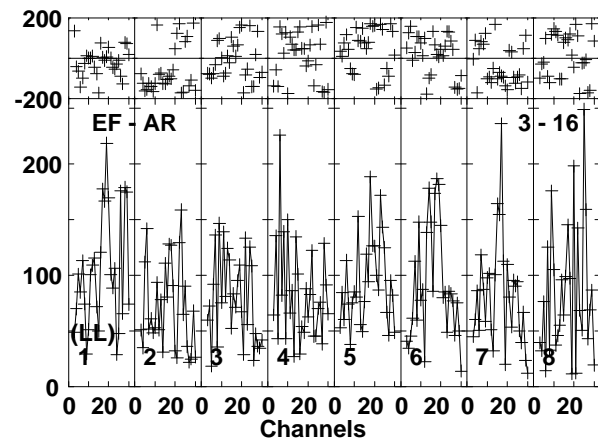
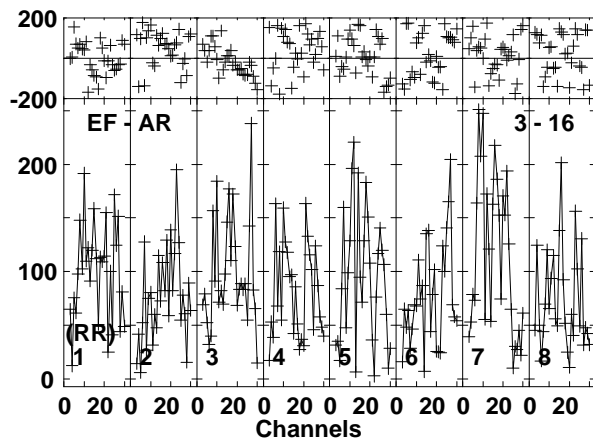
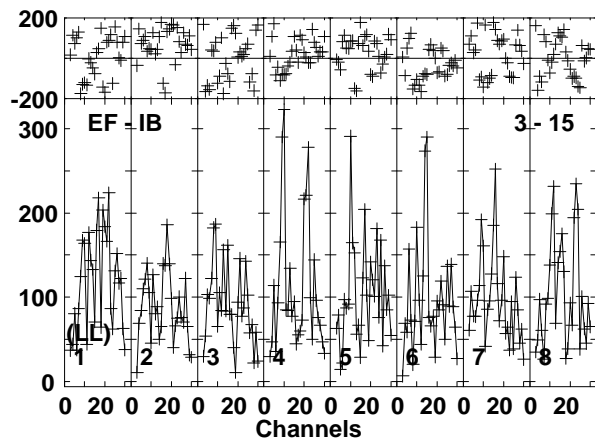
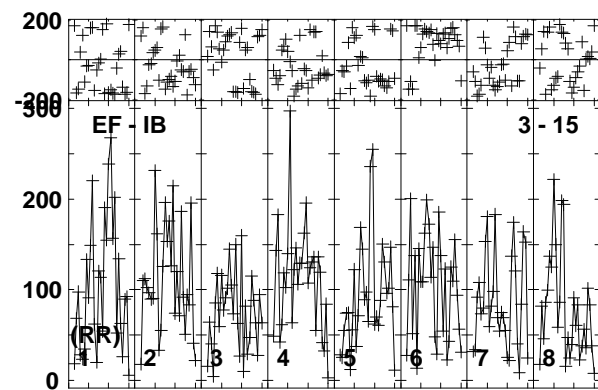
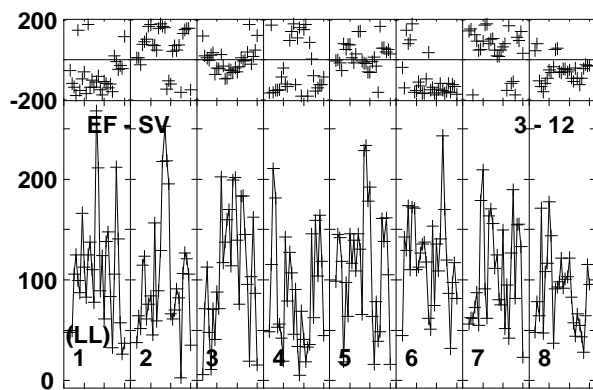
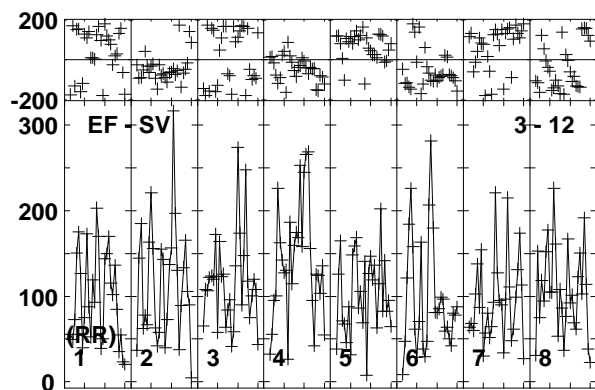
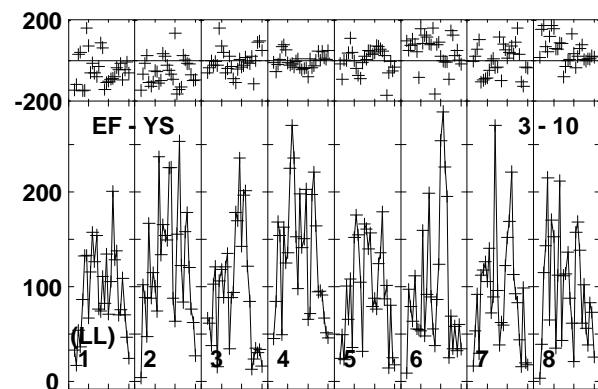
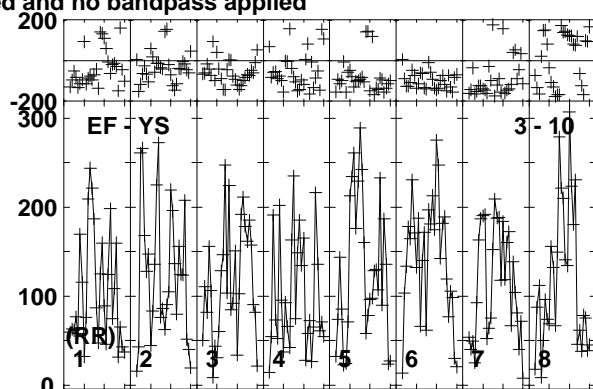
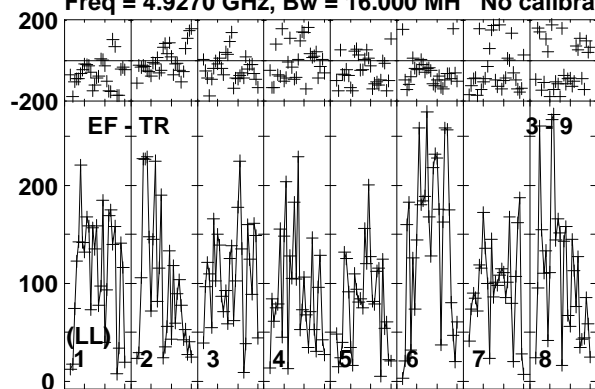

Lower frame: Micro Ampl Jy Top frame: Phas deg  
Vector averaged cross-power spectrum Baseline: EF (03) - TR (09)  
Timerange: 00/19:14:31 to 00/19:17:29

Plot file version1030 created 19-DEC-2018 17:59:18

J1619+2247 RY007C.UVDATA.1

Freq = 4.9270 GHz, Bw = 16.000 MH No calibration applied and no bandpass applied

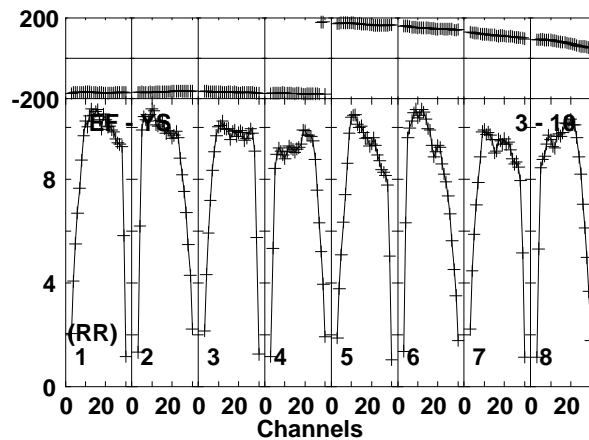
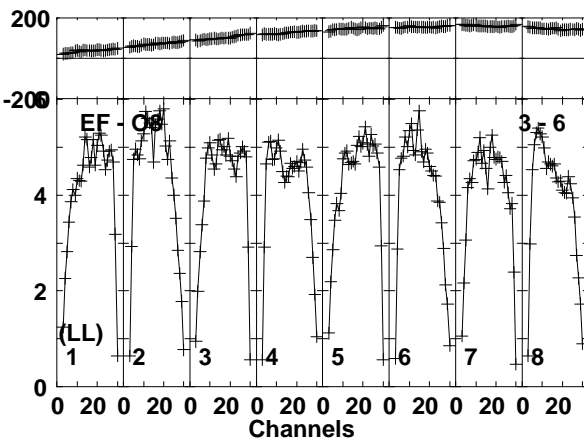
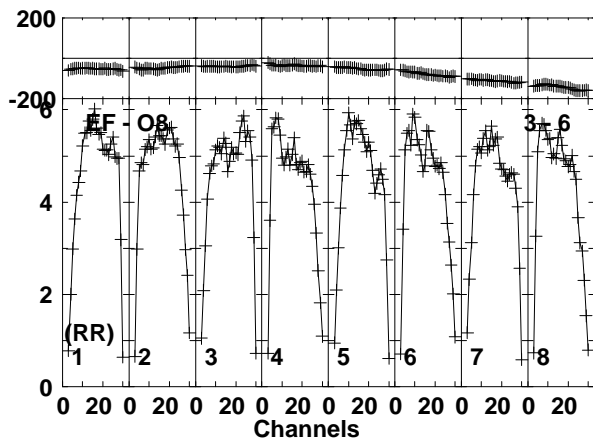
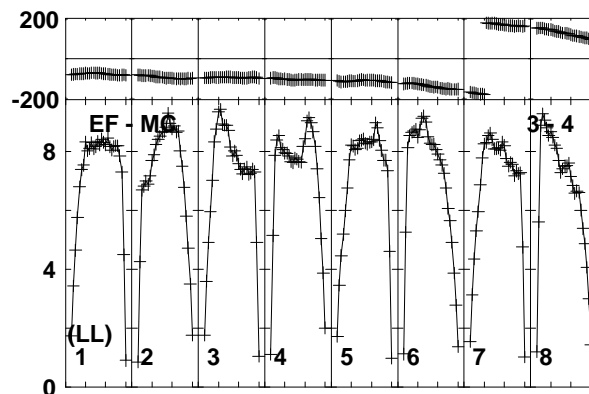
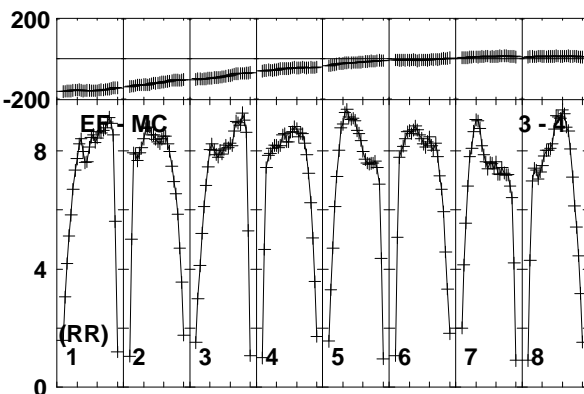
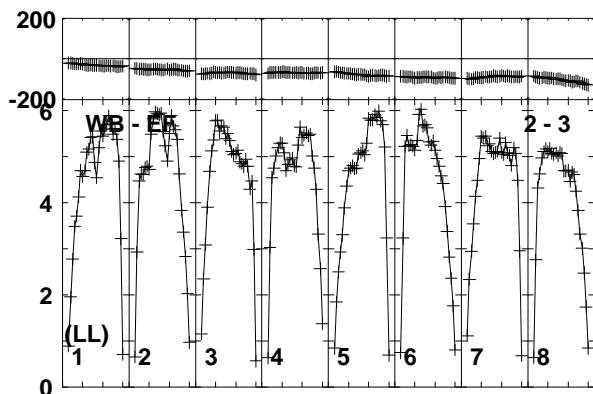
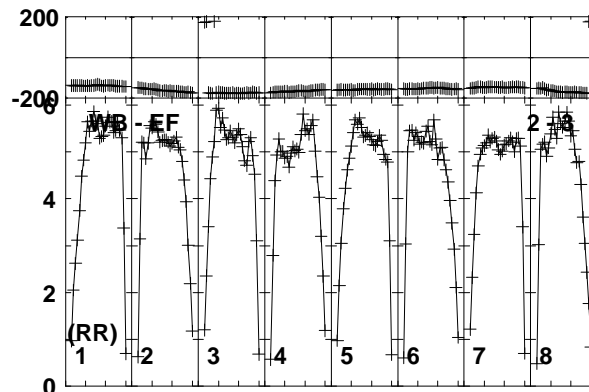
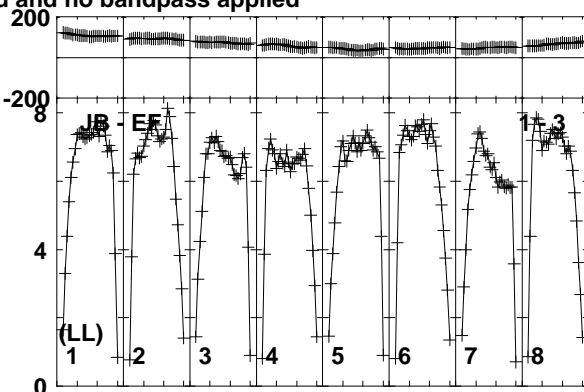
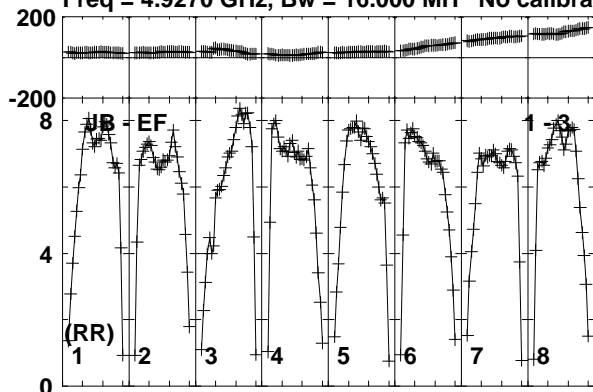

Lower frame: Milli Ampl Jy Top frame: Phas deg  
Vector averaged cross-power spectrum Baseline: JB (01) - EF (03)  
Timerange: 00/19:17:31 to 00/19:18:29

Plot file version1031 created 19-DEC-2018 17:59:18

J1619+2247 RY007C.UVDATA.1

Freq = 4.9270 GHz, Bw = 16.000 MH No calibration applied and no bandpass applied

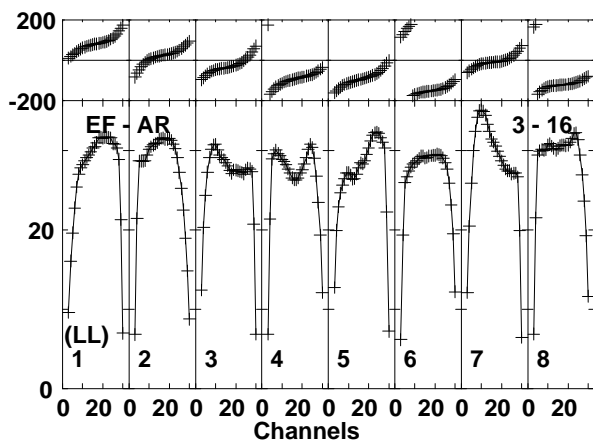
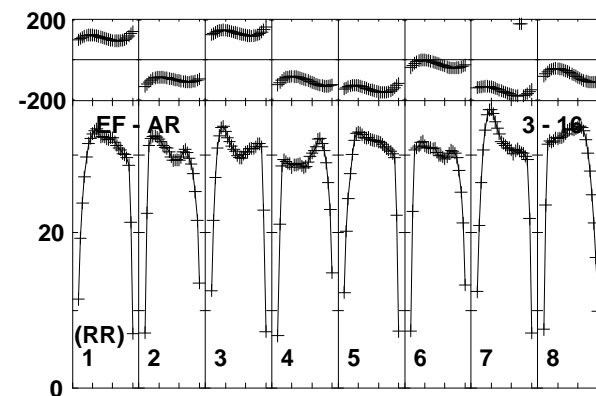
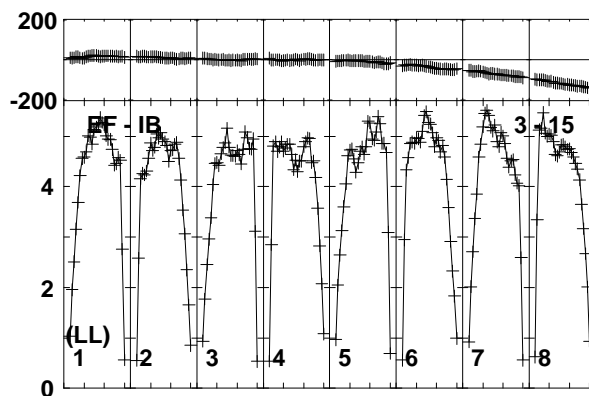
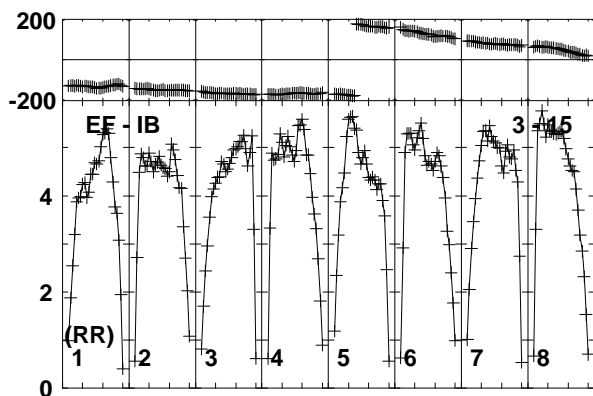
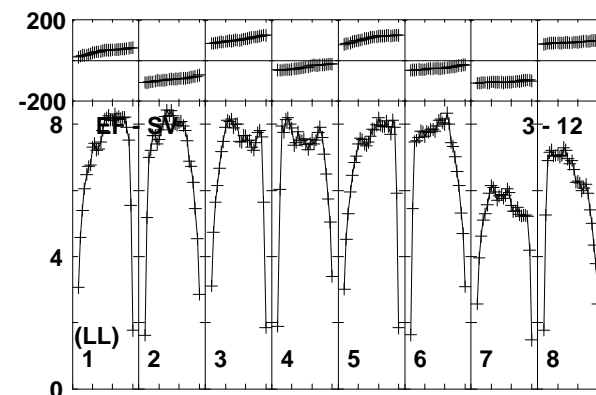
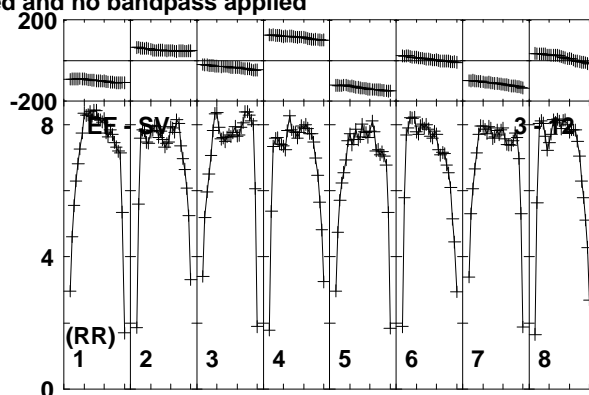
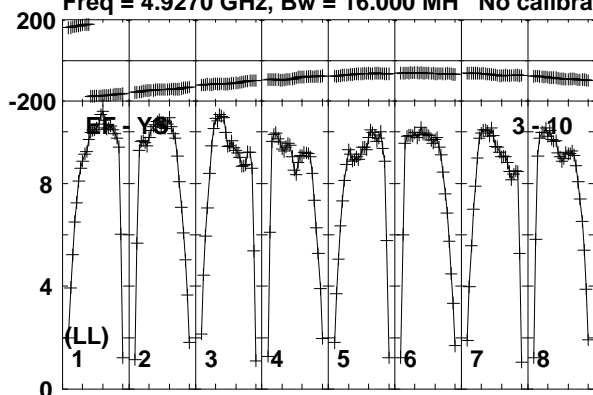

Lower frame: Milli Ampl Jy Top frame: Phas deg  
Vector averaged cross-power spectrum Baseline: EF (03) - YS (10)  
Timerange: 00/19:17:31 to 00/19:18:29

Plot file version1032 created 19-DEC-2018 17:59:18

AT2018\_RY007C.UVDATA.1

Freq = 4.9270 GHz, Bw = 16.000 MH No calibration applied and no bandpass applied

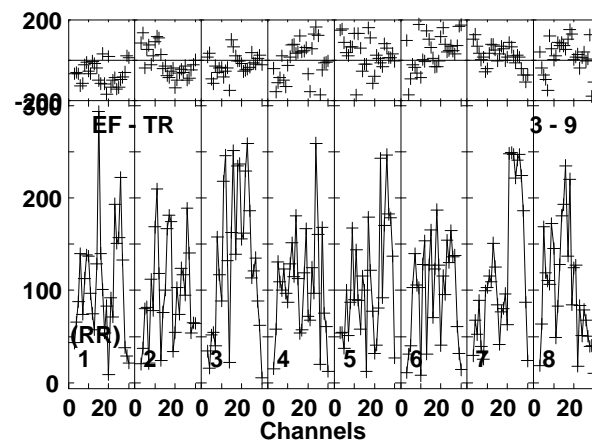
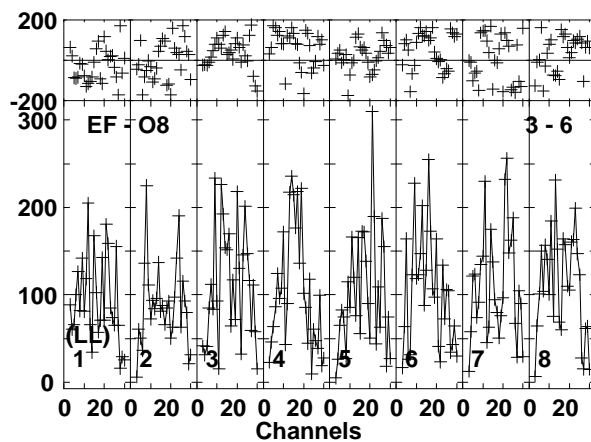
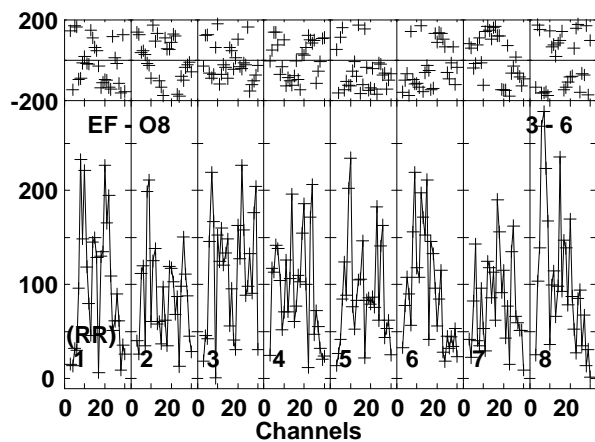
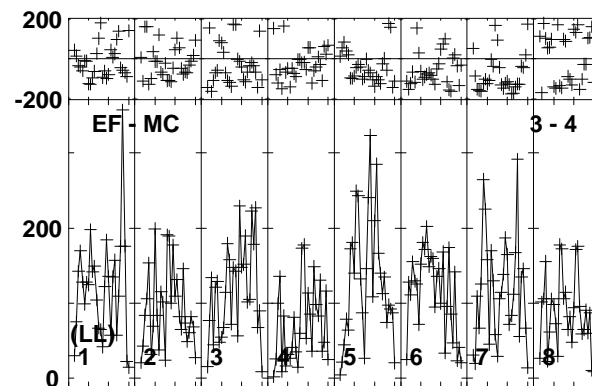
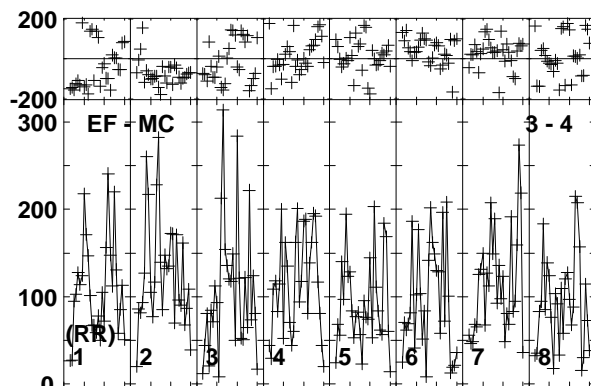
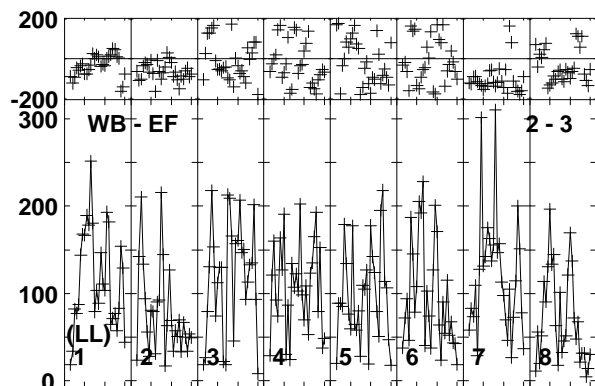
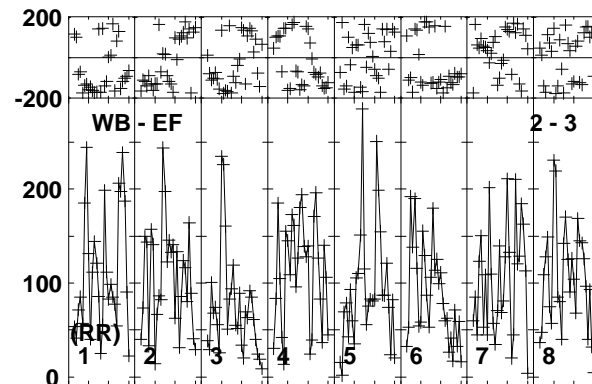
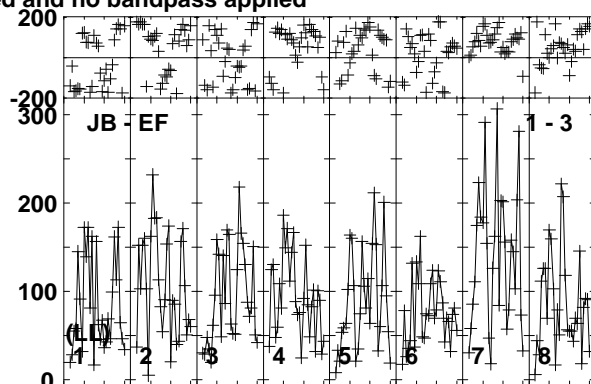
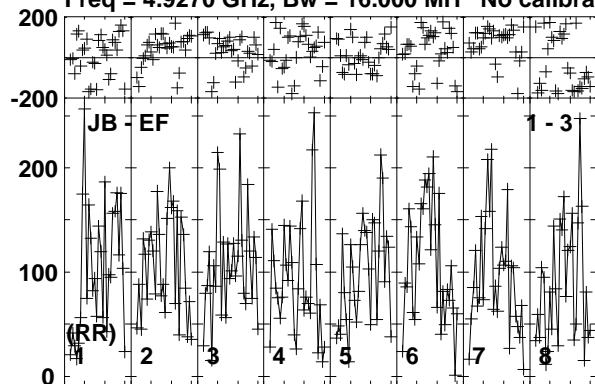

Lower frame: Micro Ampl Jy Top frame: Phas deg  
Vector averaged cross-power spectrum Baseline: JB (01) - EF (03)  
Timerange: 00/19:18:31 to 00/19:21:29

Plot file version1033 created 19-DEC-2018 17:59:18

AT2018\_RY007C.UVDATA.1

Freq = 4.9270 GHz, Bw = 16.000 MH No calibration applied and no bandpass applied

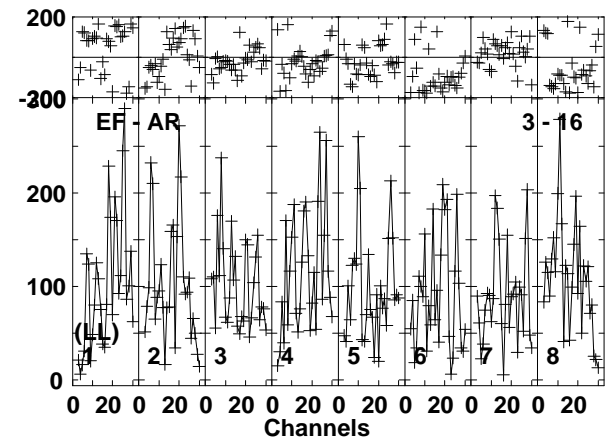
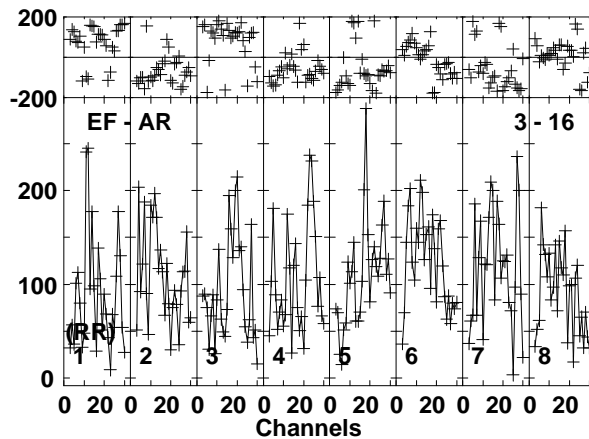
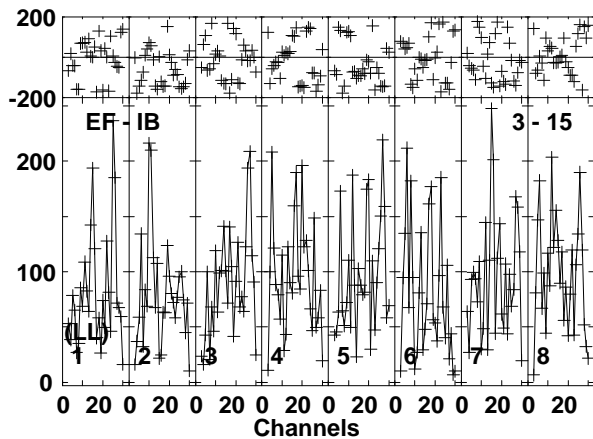
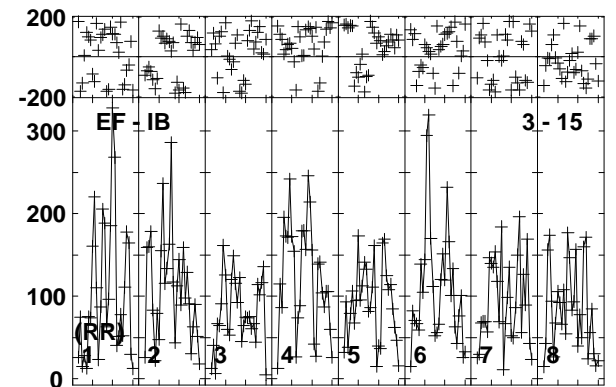
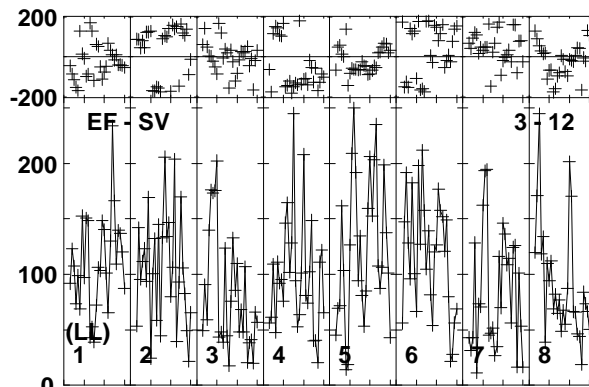
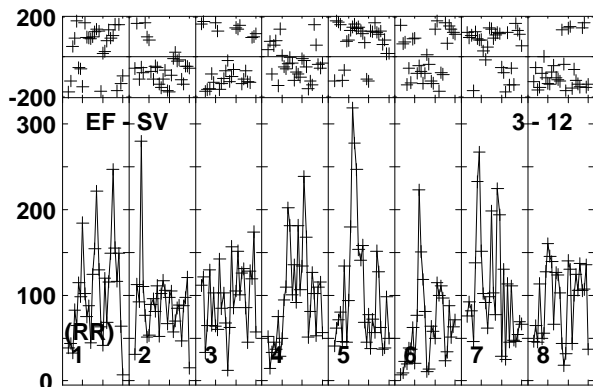
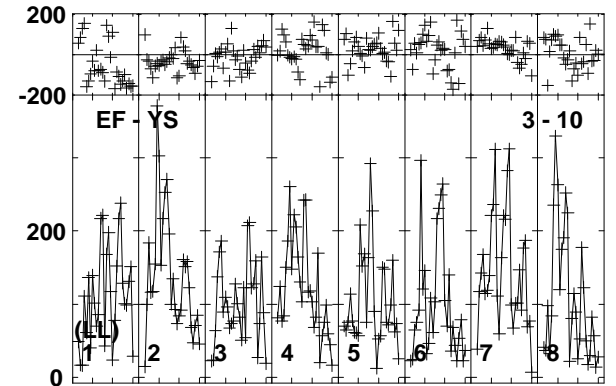
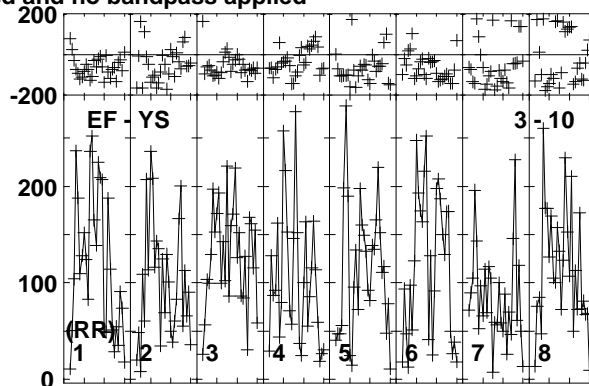
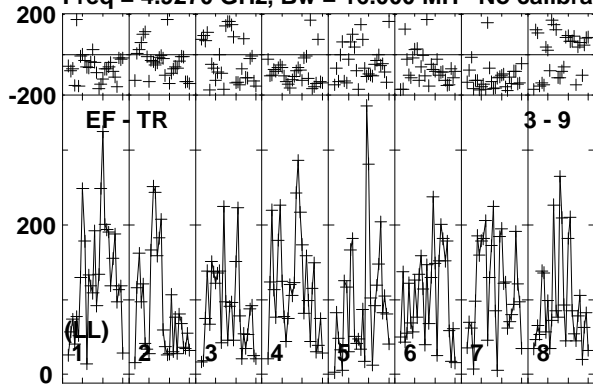

Lower frame: Micro Ampl Jy Top frame: Phas deg  
Vector averaged cross-power spectrum Baseline: EF (03) - TR (09)  
Timerange: 00/19:18:31 to 00/19:21:29

Plot file version1034 created 19-DEC-2018 17:59:18

J1619+2247 RY007C.UVDATA.1

Freq = 4.9270 GHz, Bw = 16.000 MH No calibration applied and no bandpass applied

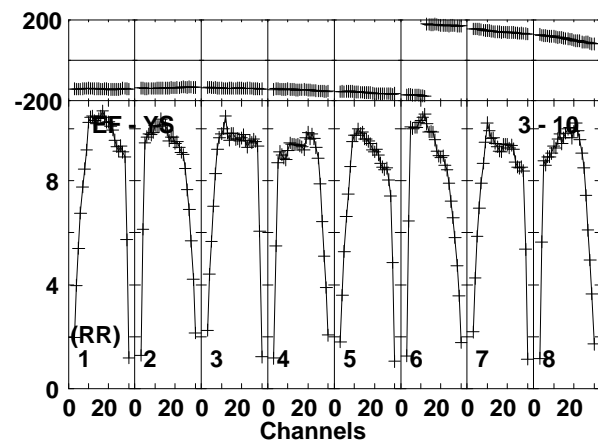
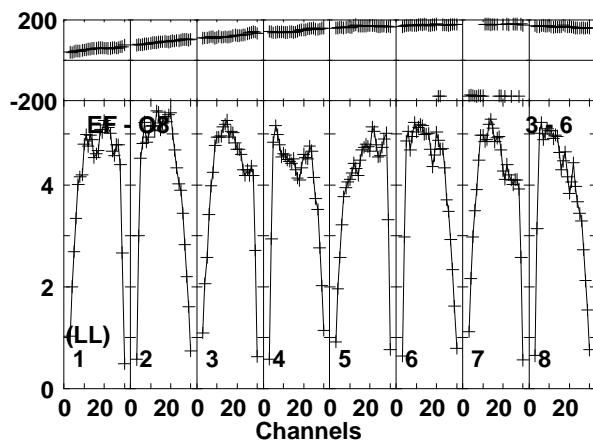
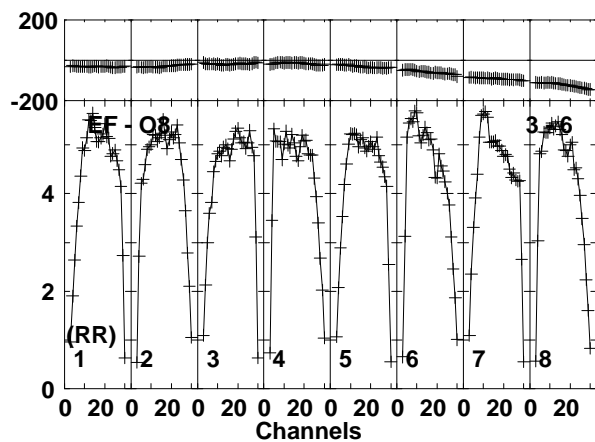
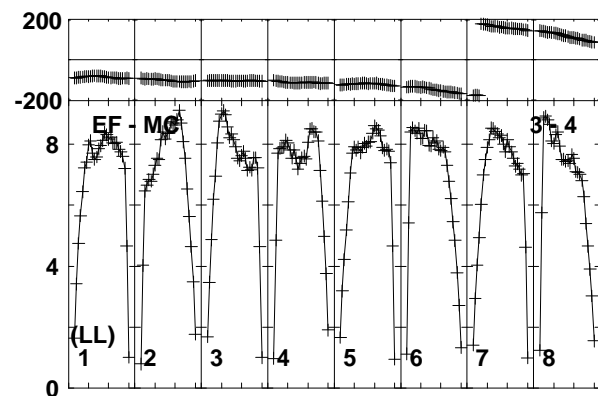
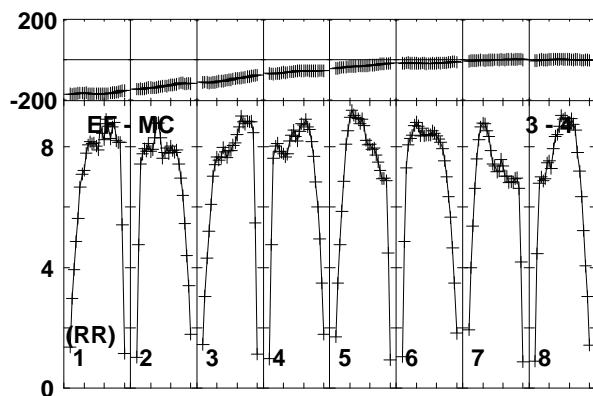
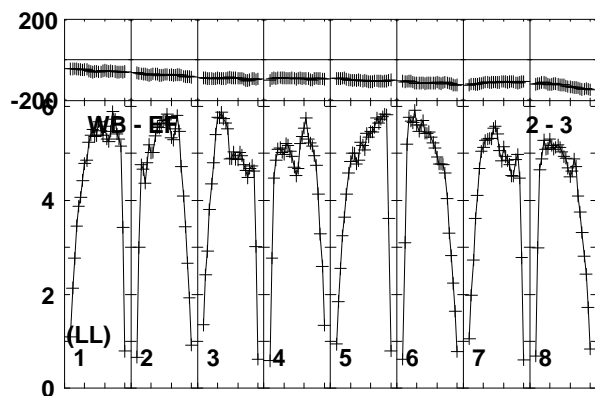
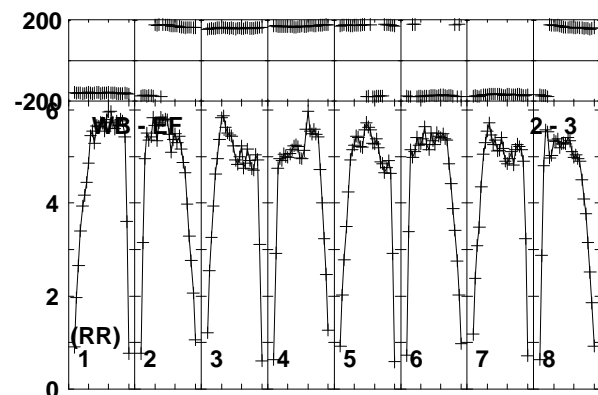
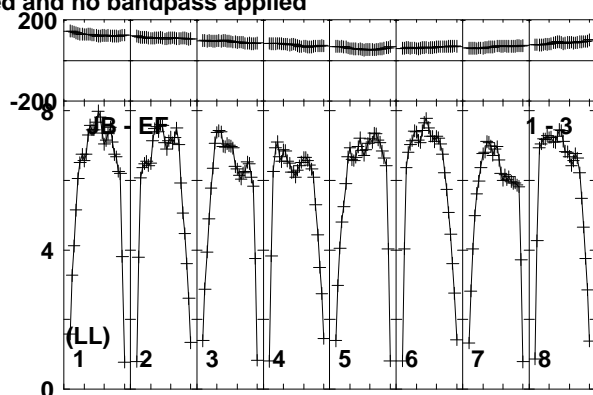
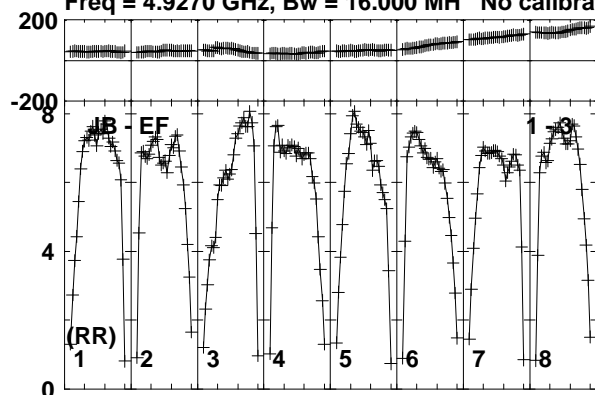

Lower frame: Milli Ampl Jy Top frame: Phas deg  
Vector averaged cross-power spectrum Baseline: JB (01) - EF (03)  
Timerange: 00/19:21:31 to 00/19:22:29



Plot file version1035 created 19-DEC-2018 17:59:18

J1619+2247 RY007C.UVDATA.1

Freq = 4.9270 GHz, Bw = 16.000 MH No calibration applied and no bandpass applied

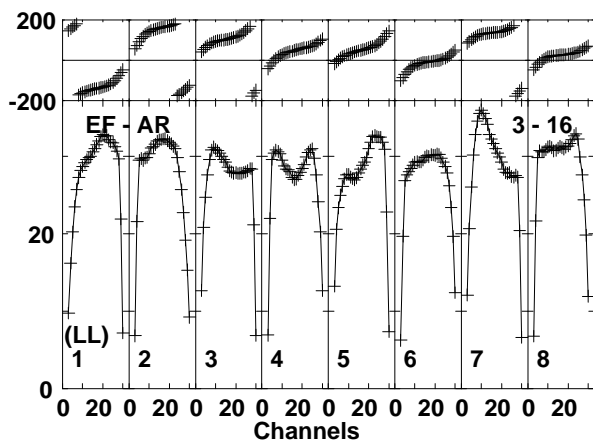
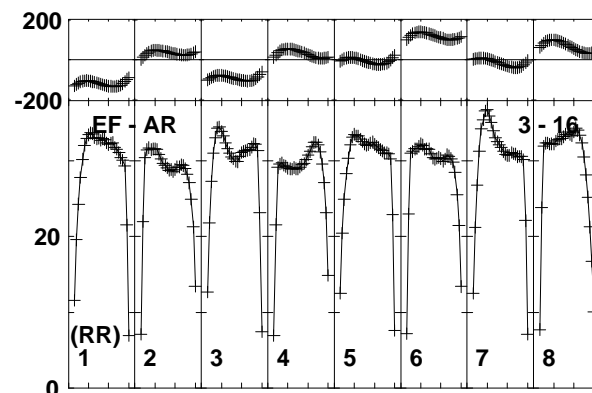
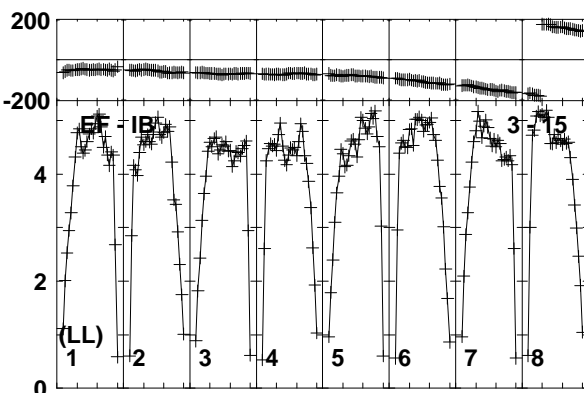
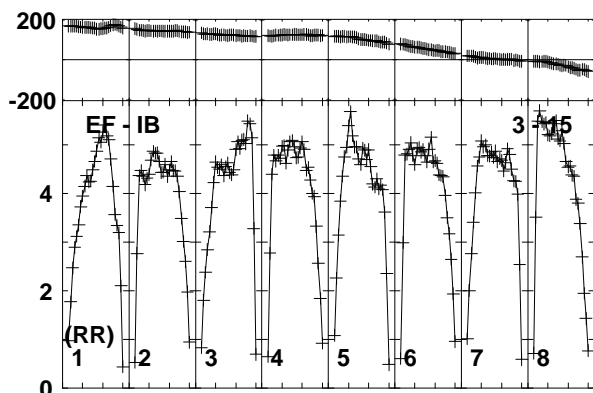
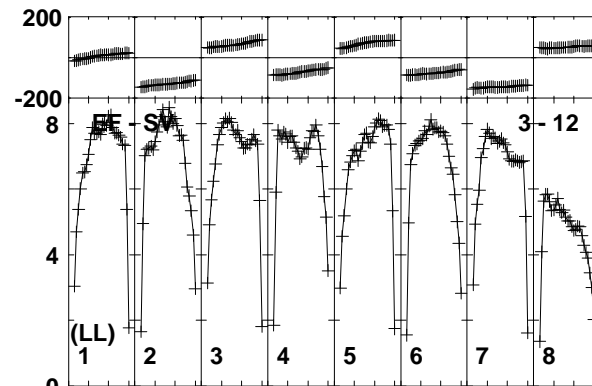
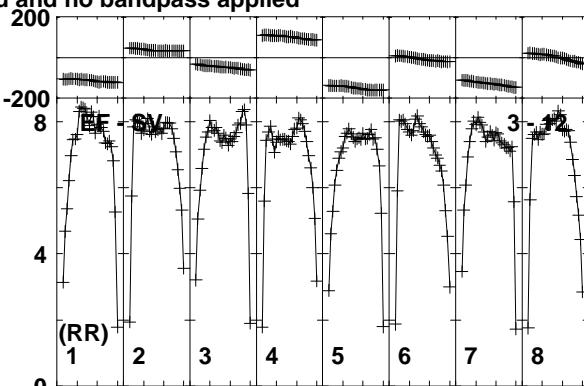
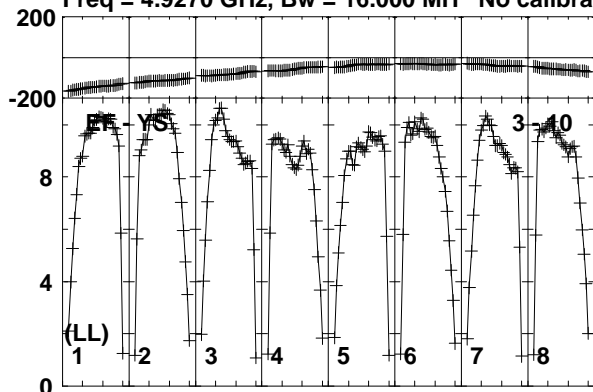

Lower frame: Milli Ampl Jy Top frame: Phas deg  
Vector averaged cross-power spectrum Baseline: EF (03) - YS (10)  
Timerange: 00/19:21:31 to 00/19:22:29

Plot file version1036 created 19-DEC-2018 17:59:18

VLA1 RY007C.UVDATA.1

Freq = 4.9270 GHz, Bw = 16.000 MH No calibration applied and no bandpass applied

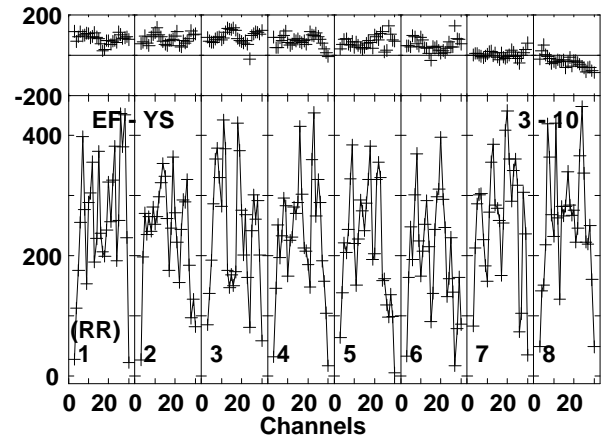
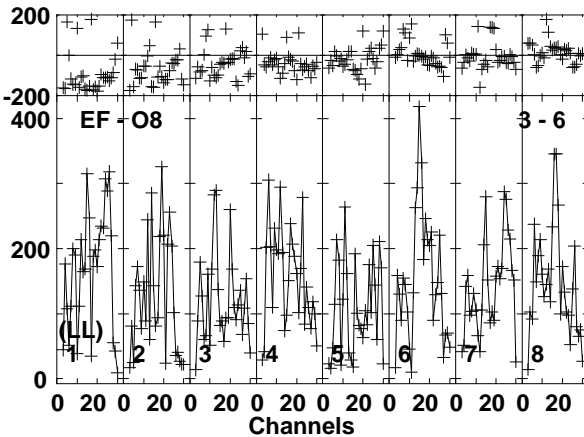
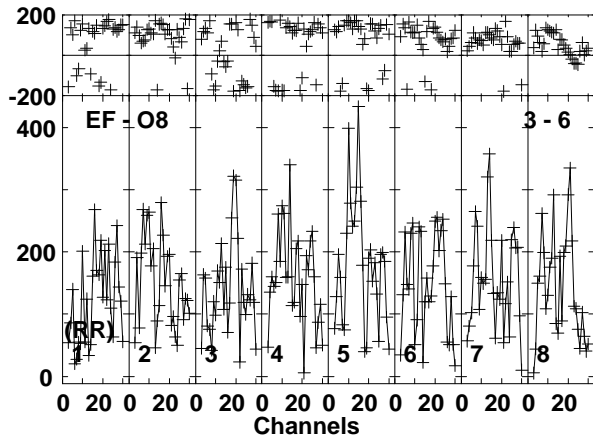
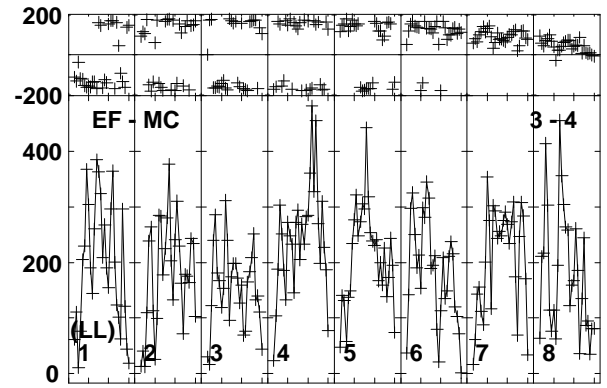
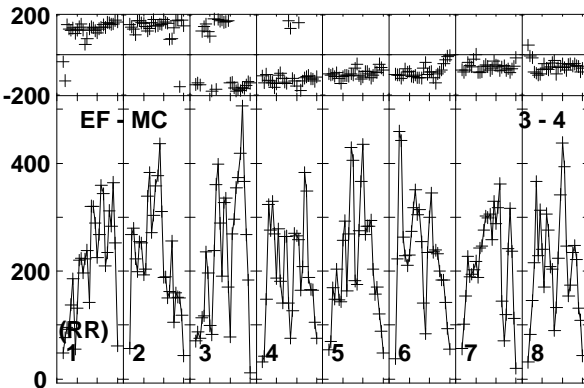
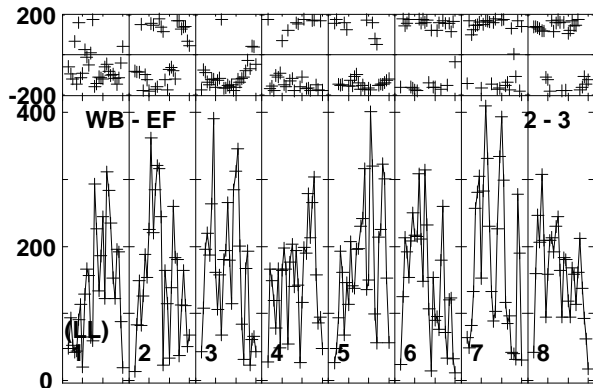
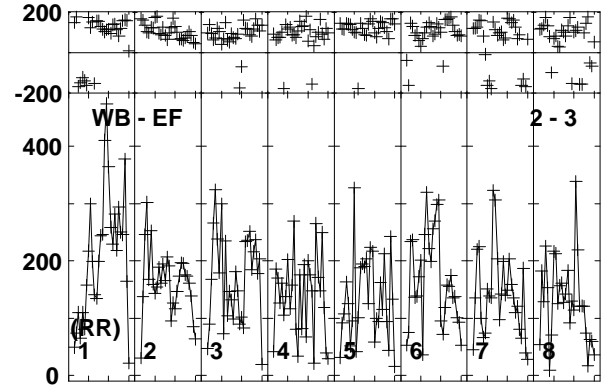
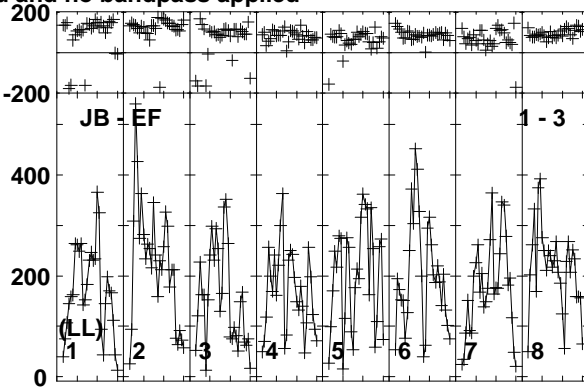
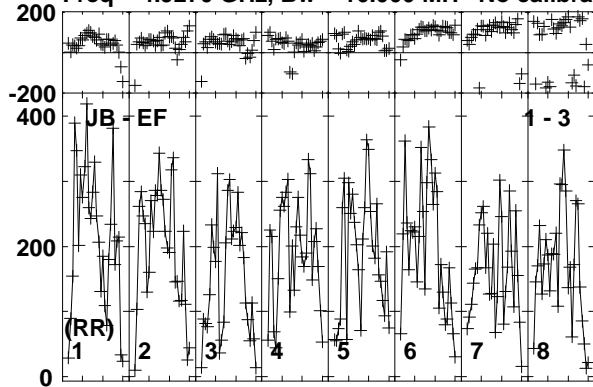

Lower frame: Micro Ampl Jy Top frame: Phas deg  
Vector averaged cross-power spectrum Baseline: JB (01) - EF (03)  
Timerange: 00/19:23:01 to 00/19:24:59

Plot file version1037 created 19-DEC-2018 17:59:18

VLA1 RY007C.UVDATA.1

Freq = 4.9270 GHz, Bw = 16.000 MH No calibration applied and no bandpass applied

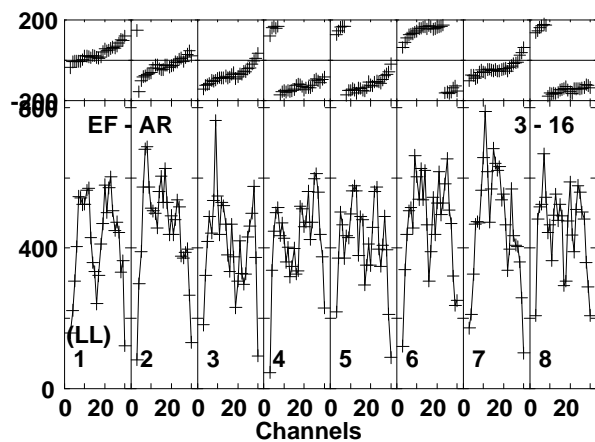
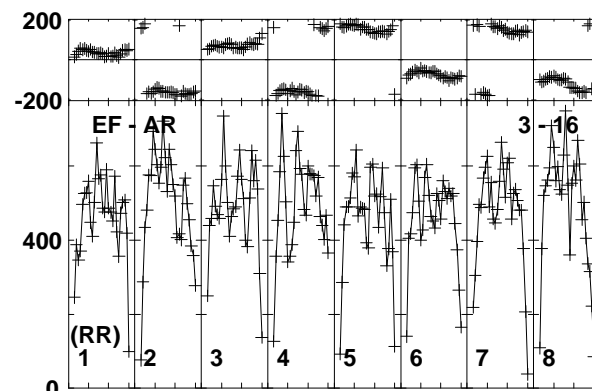
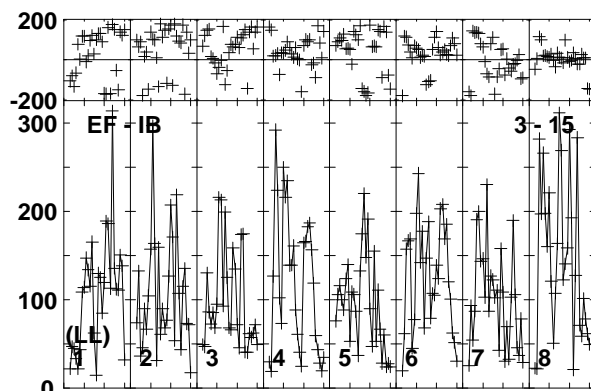
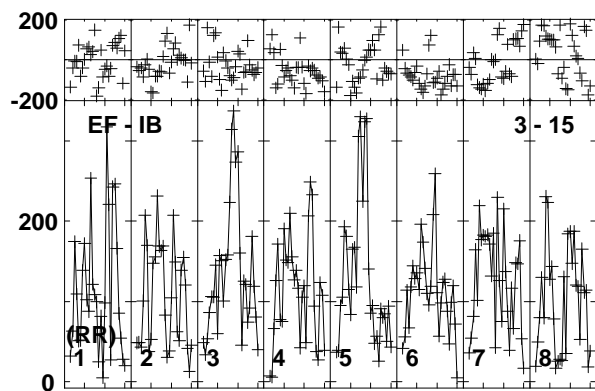
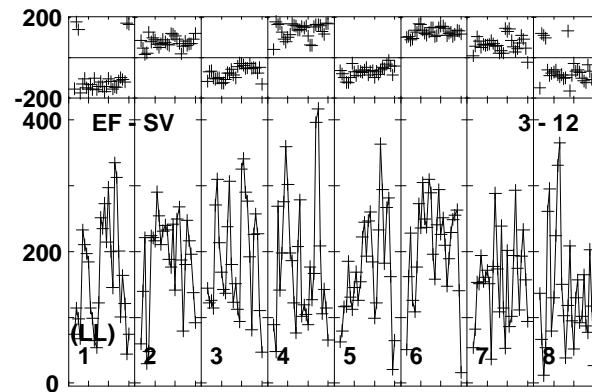
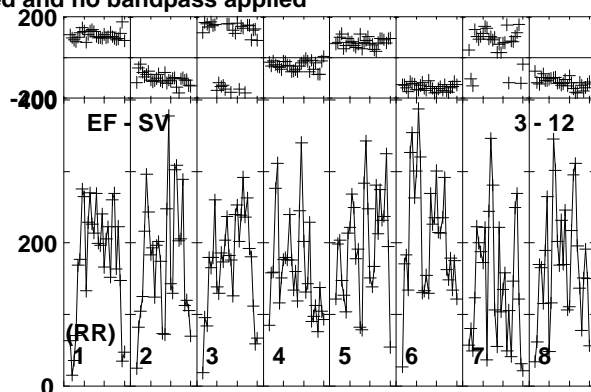
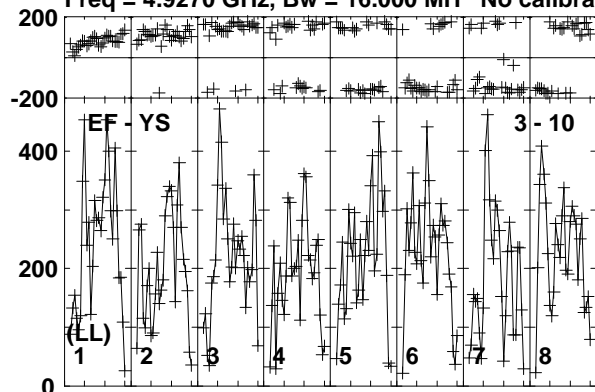

Lower frame: Micro Ampl Jy Top frame: Phas deg  
Vector averaged cross-power spectrum Baseline: EF (03) - YS (10)  
Timerange: 00/19:23:01 to 00/19:24:59

Plot file version1038 created 19-DEC-2018 17:59:19

J1619+2247 RY007C.UVDATA.1

Freq = 4.9270 GHz, Bw = 16.000 MH No calibration applied and no bandpass applied

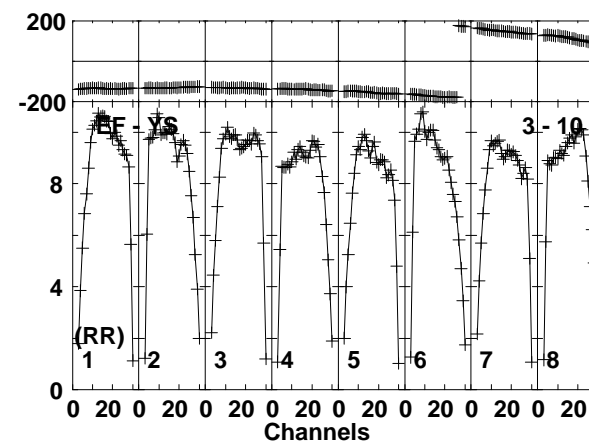
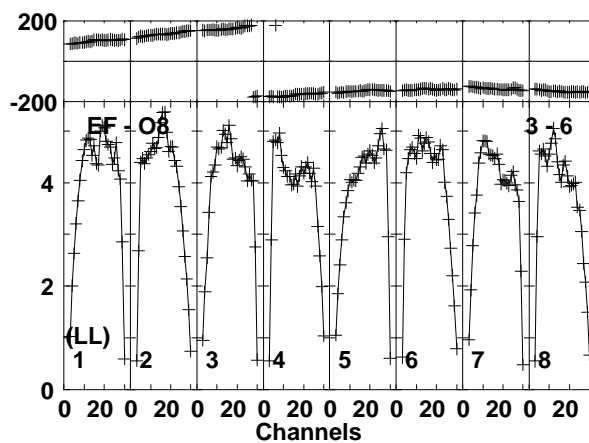
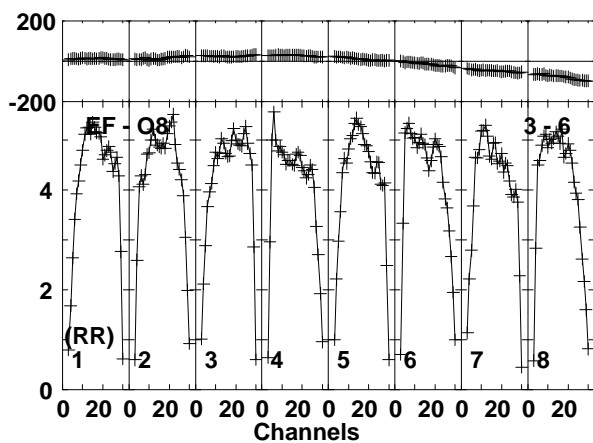
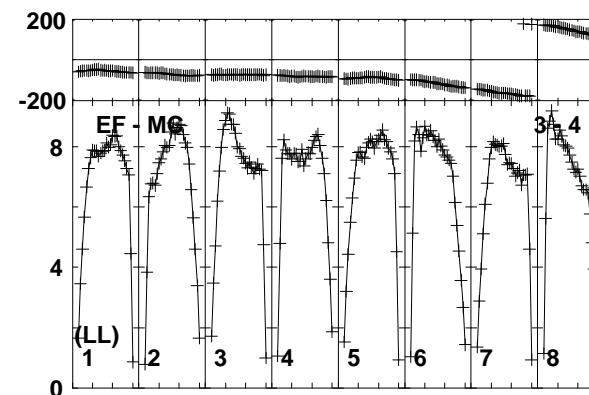
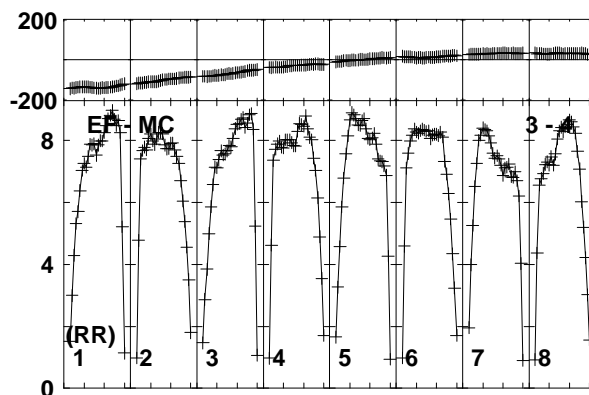
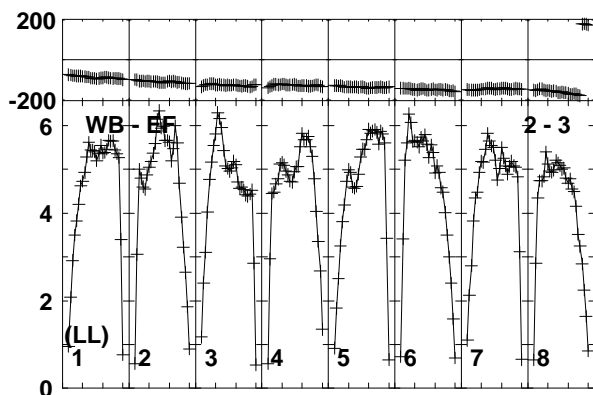
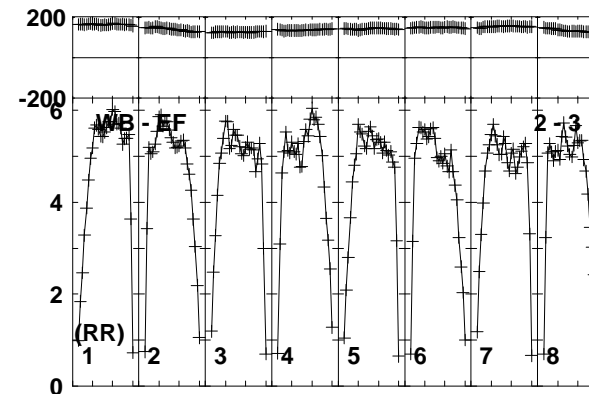
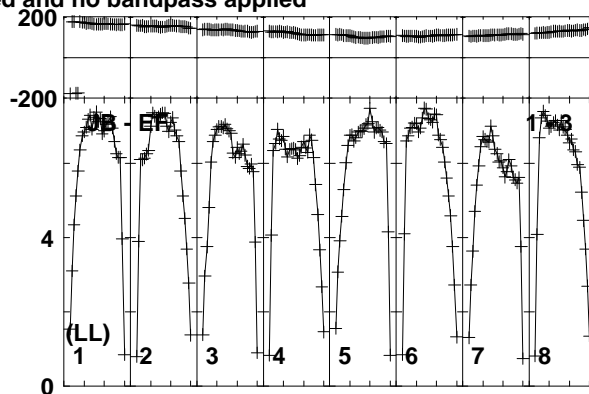
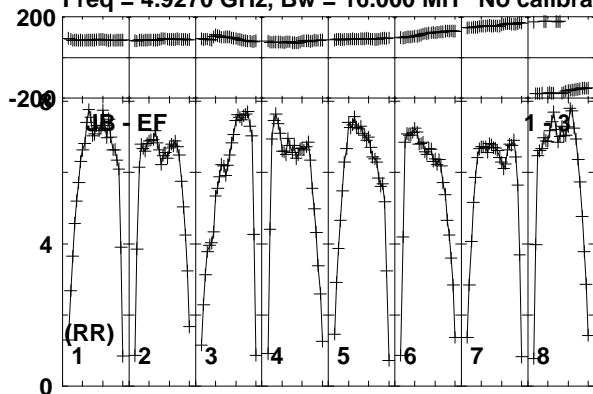

Lower frame: Milli Ampl Jy Top frame: Phas deg  
Vector averaged cross-power spectrum Baseline: JB (01) - EF (03)  
Timerange: 00/19:25:01 to 00/19:25:59

Plot file version1039 created 19-DEC-2018 17:59:19

J1619+2247 RY007C.UVDATA.1

Freq = 4.9270 GHz, Bw = 16.000 MH No calibration applied and no bandpass applied

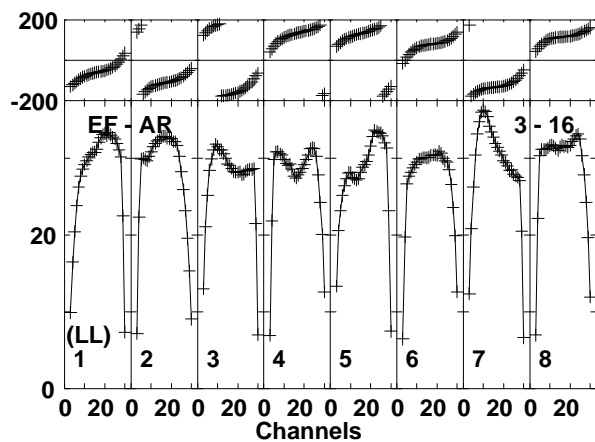
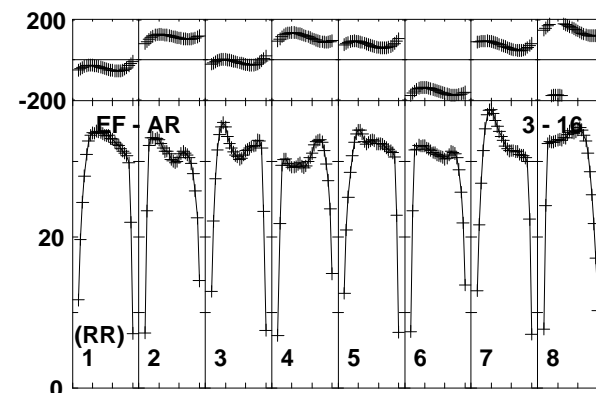
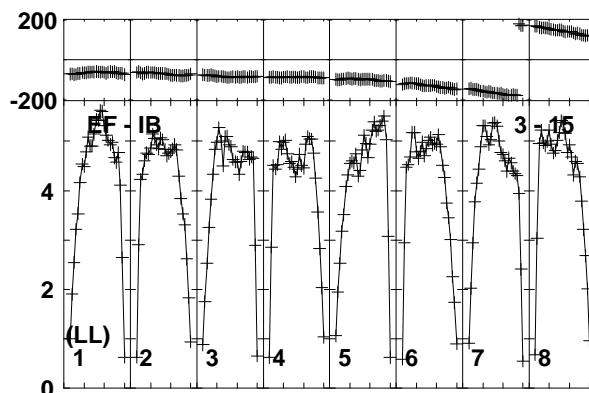
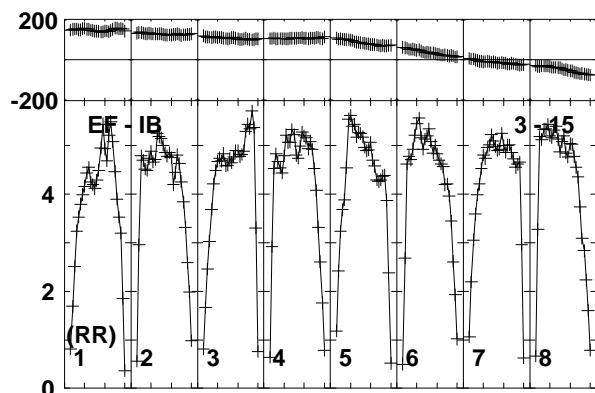
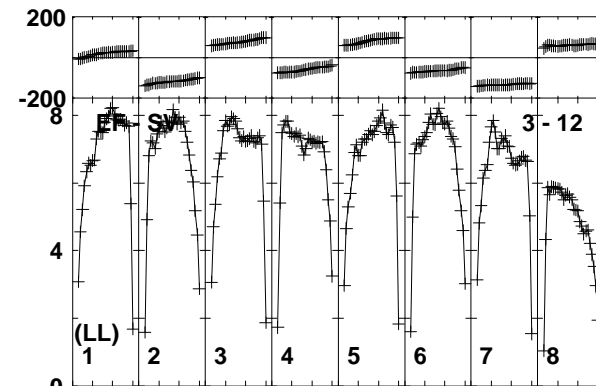
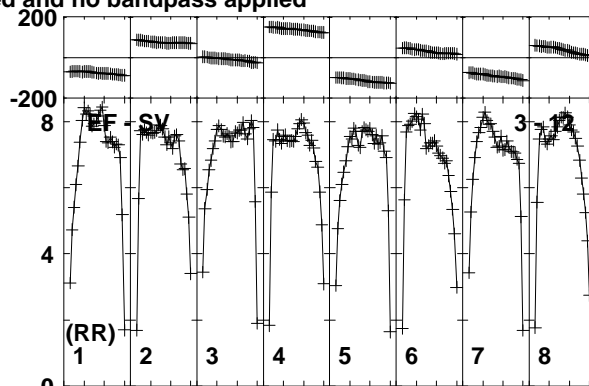
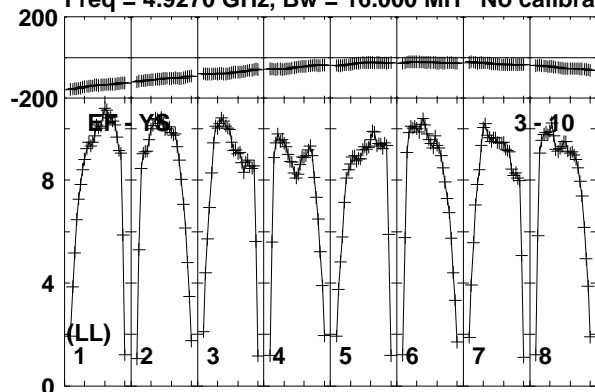

Lower frame: Milli Ampl Jy Top frame: Phas deg  
Vector averaged cross-power spectrum Baseline: EF (03) - YS (10)  
Timerange: 00/19:25:01 to 00/19:25:59

Plot file version1040 created 19-DEC-2018 17:59:19

AT2018\_RY007C.UVDATA.1

Freq = 4.9270 GHz, Bw = 16.000 MH No calibration applied and no bandpass applied

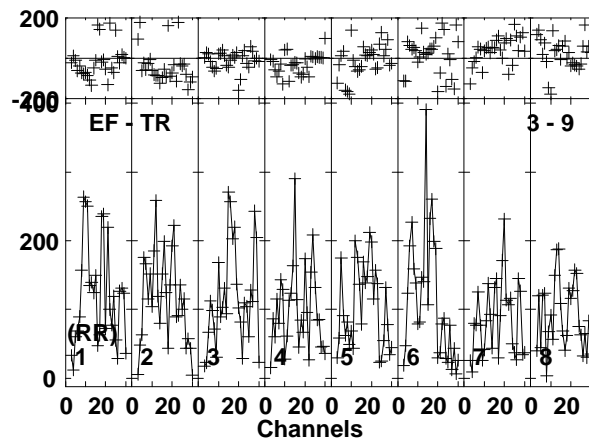
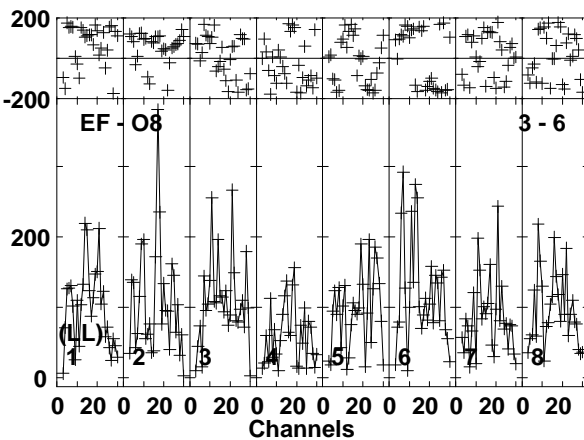
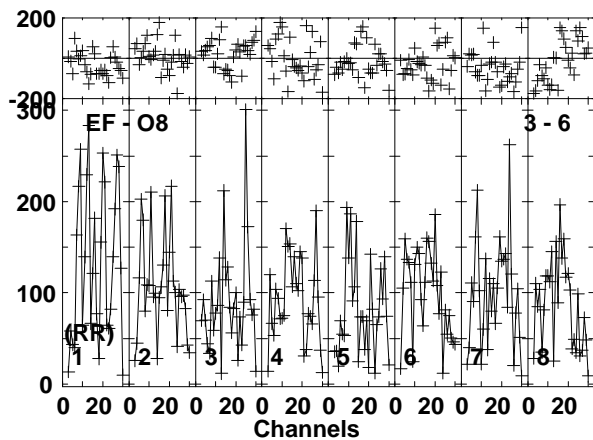
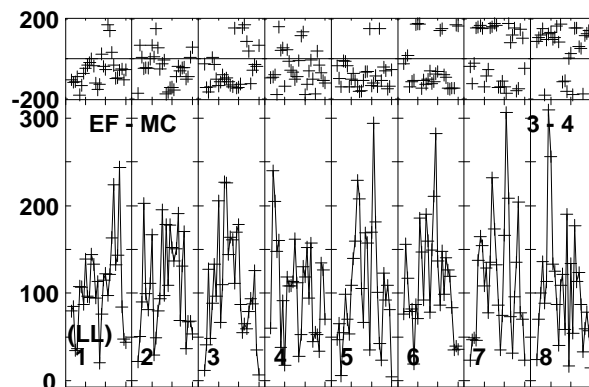
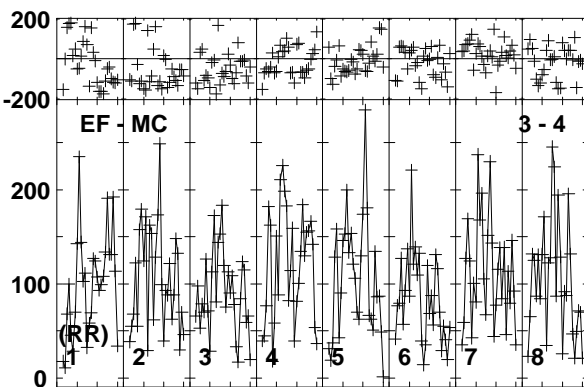
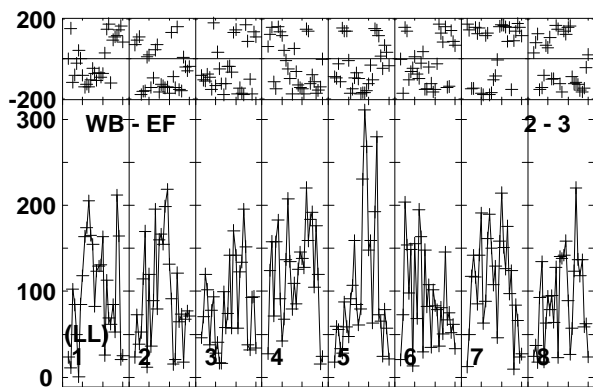
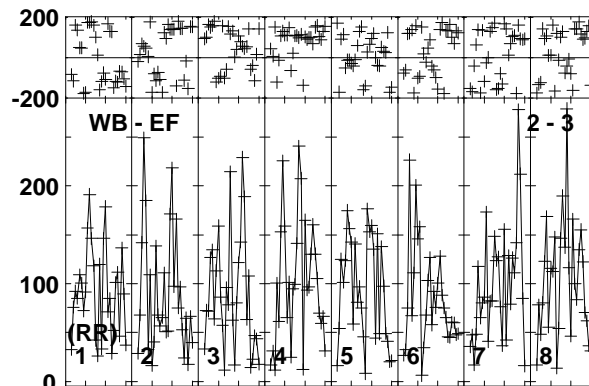
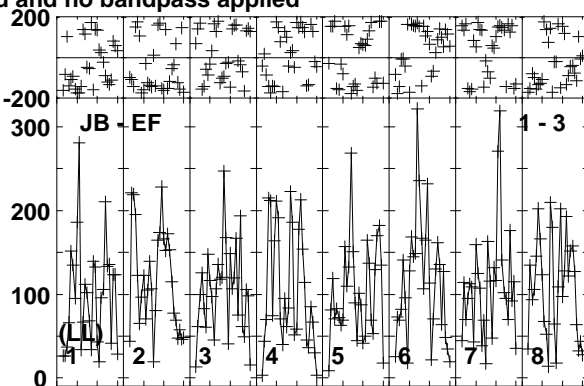
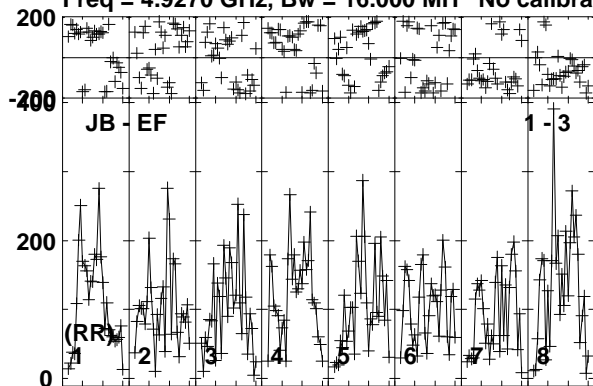

Lower frame: Micro Ampl Jy Top frame: Phas deg  
Vector averaged cross-power spectrum Baseline: JB (01) - EF (03)  
Timerange: 00/19:26:01 to 00/19:28:59

Plot file version1041 created 19-DEC-2018 17:59:19

AT2018\_RY007C.UVDATA.1

Freq = 4.9270 GHz, Bw = 16.000 MH No calibration applied and no bandpass applied

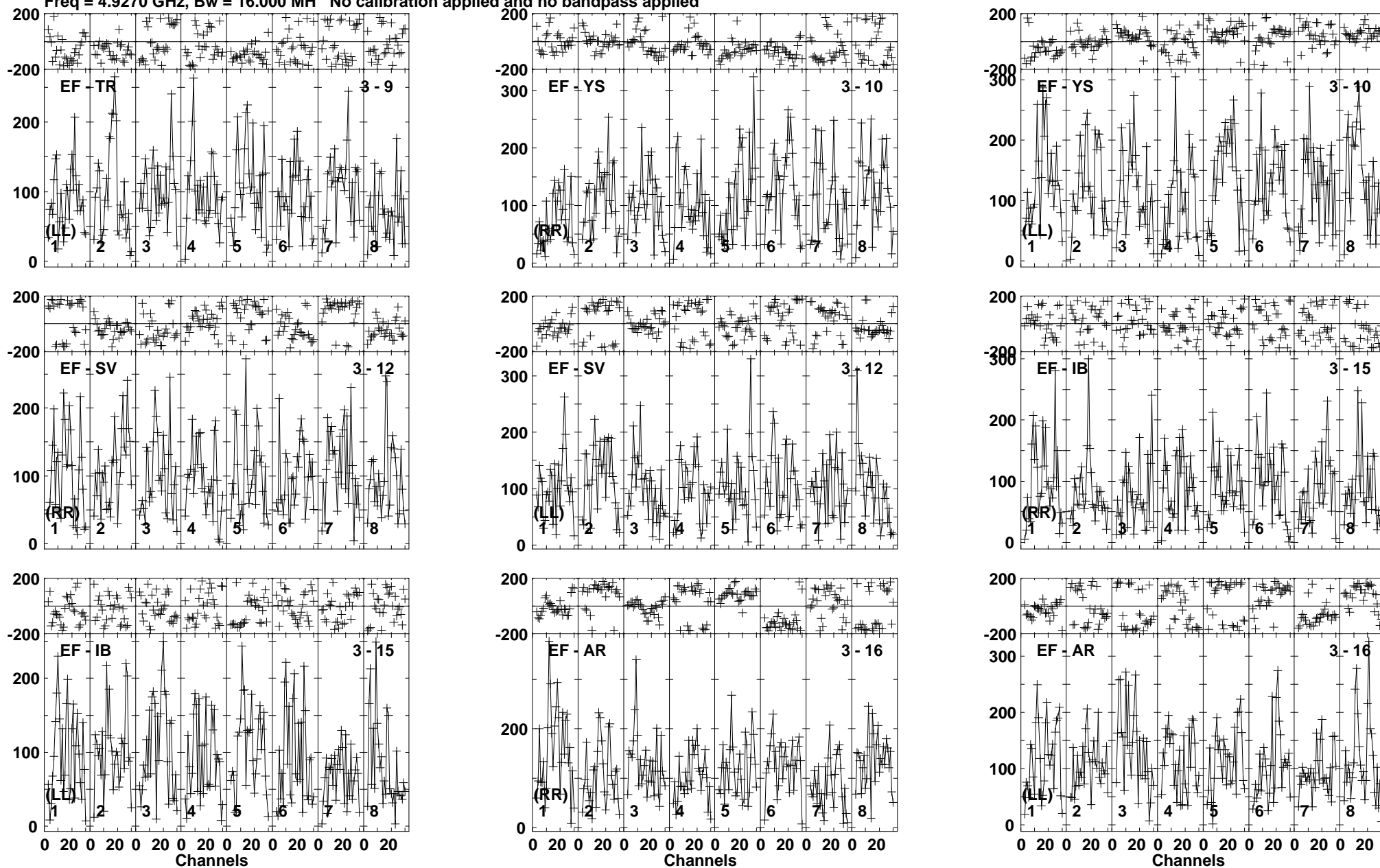

Lower frame: Micro Ampl Jy Top frame: Phas deg  
Vector averaged cross-power spectrum Baseline: EF (03) - TR (09)  
Timerange: 00/19:26:01 to 00/19:28:59

Plot file version1042 created 19-DEC-2018 17:59:19

J1619+2247 RY007C.UVDATA.1

Freq = 4.9270 GHz, Bw = 16.000 MH No calibration applied and no bandpass applied

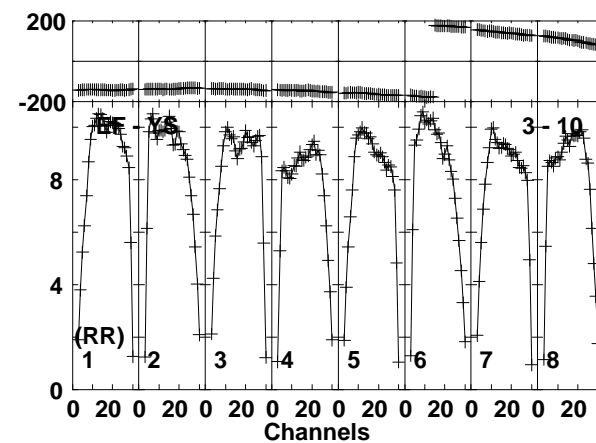
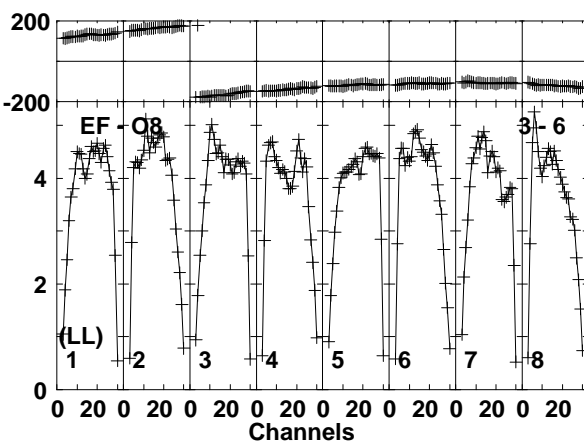
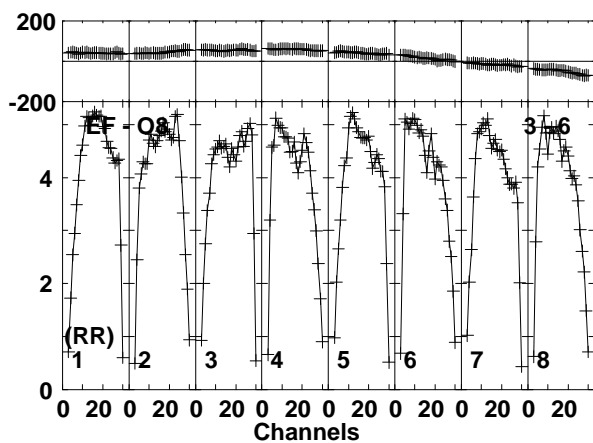
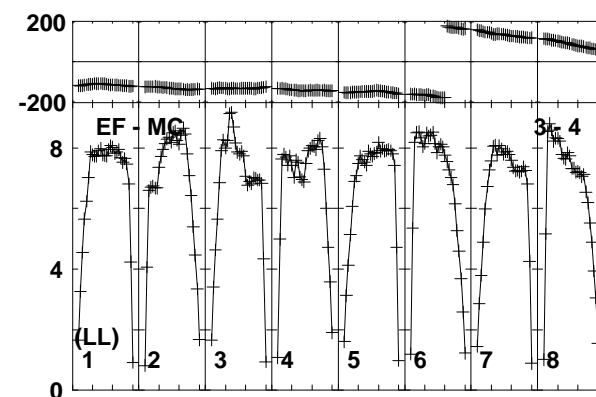
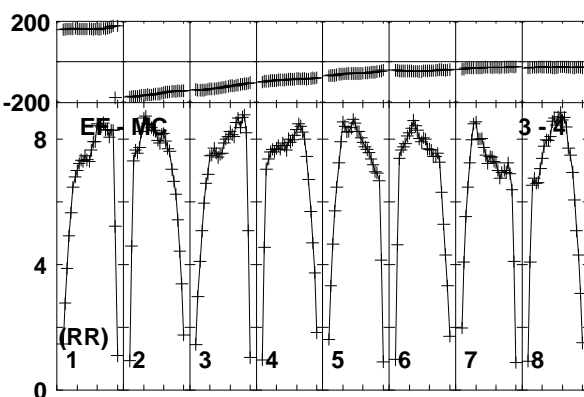
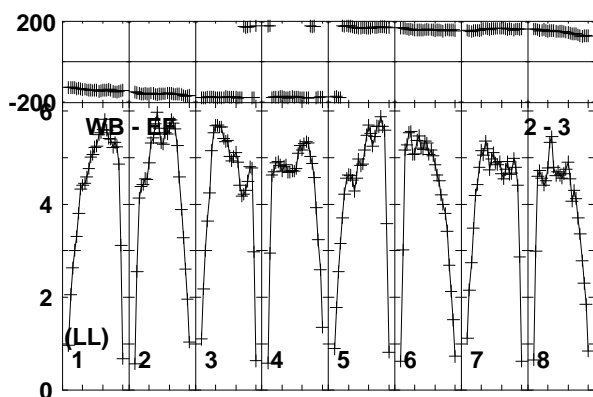
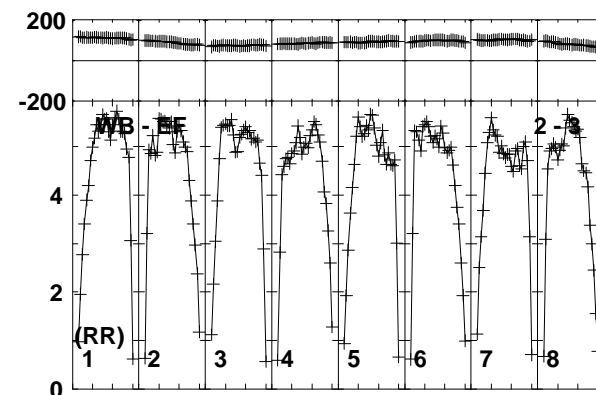
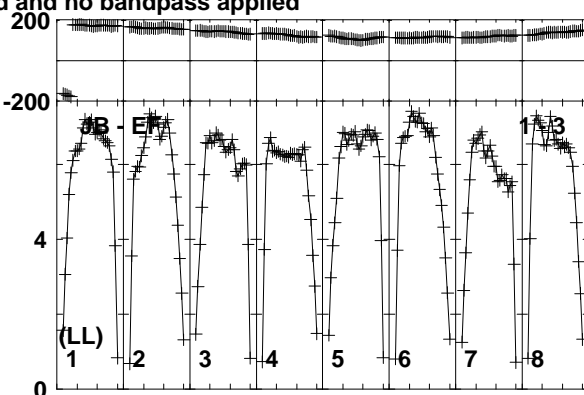
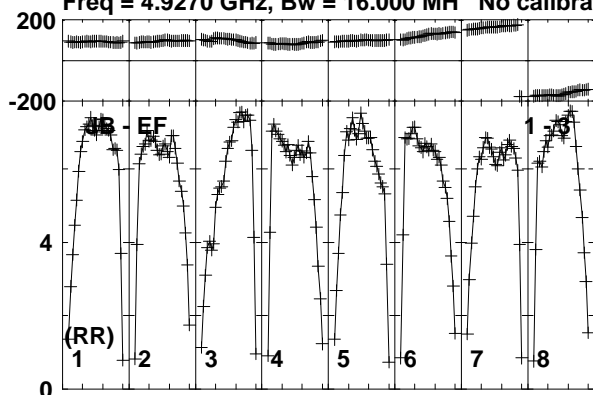

Lower frame: Milli Ampl Jy Top frame: Phas deg  
Vector averaged cross-power spectrum Baseline: JB (01) - EF (03)  
Timerange: 00/19:29:01 to 00/19:29:59



Plot file version1043 created 19-DEC-2018 17:59:19

J1619+2247 RY007C.UVDATA.1

Freq = 4.9270 GHz, Bw = 16.000 MH No calibration applied and no bandpass applied

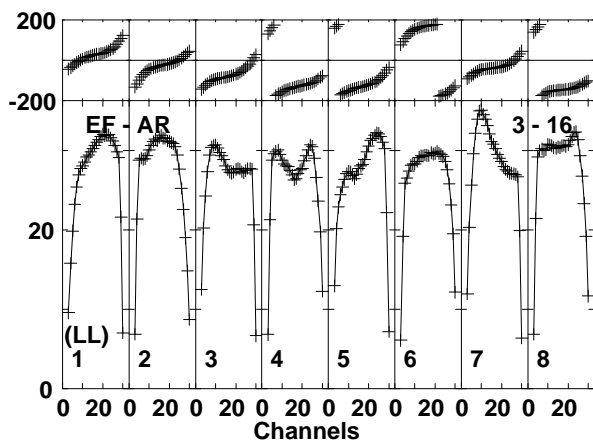
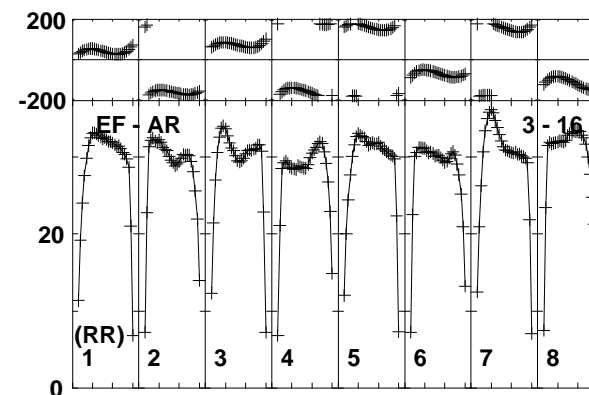
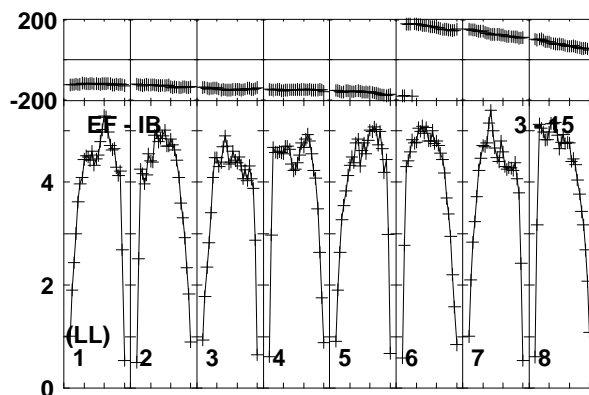
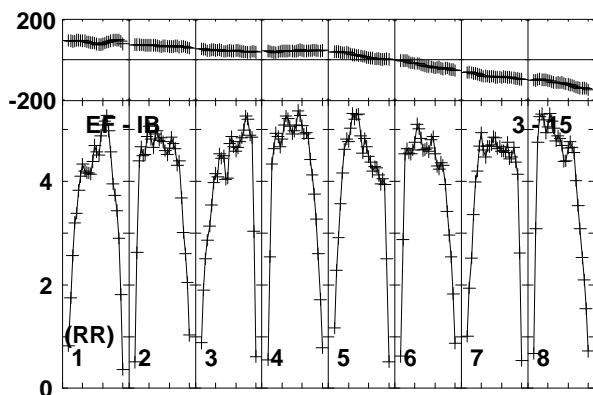
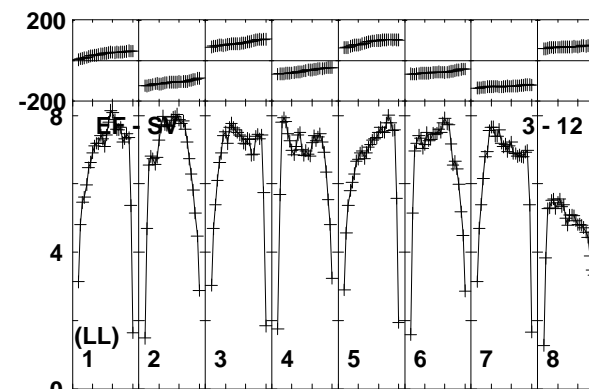
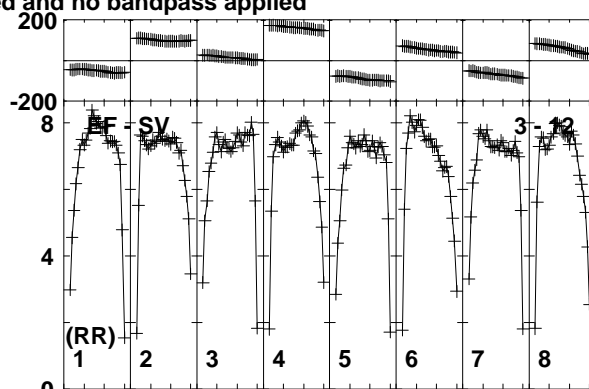
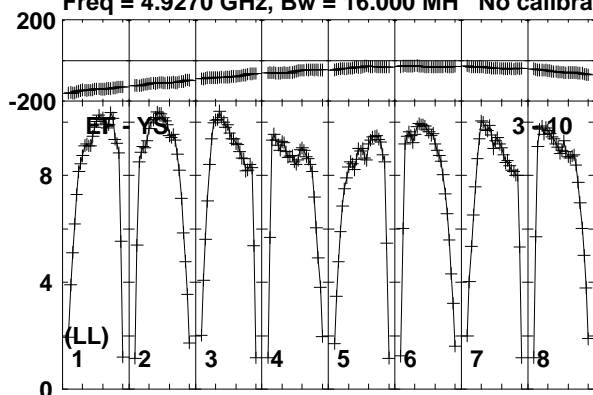

Lower frame: Milli Ampl Jy Top frame: Phas deg  
Vector averaged cross-power spectrum Baseline: EF (03) - YS (10)  
Timerange: 00/19:29:01 to 00/19:29:59

Plot file version1044 created 19-DEC-2018 17:59:19

AT2018\_RY007C.UVDATA.1

Freq = 4.9270 GHz, Bw = 16.000 MH No calibration applied and no bandpass applied

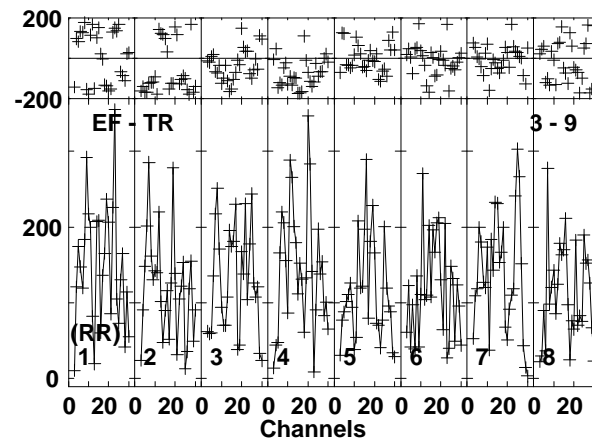
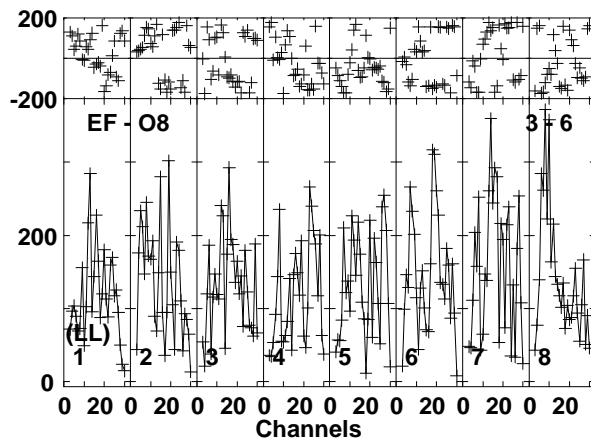
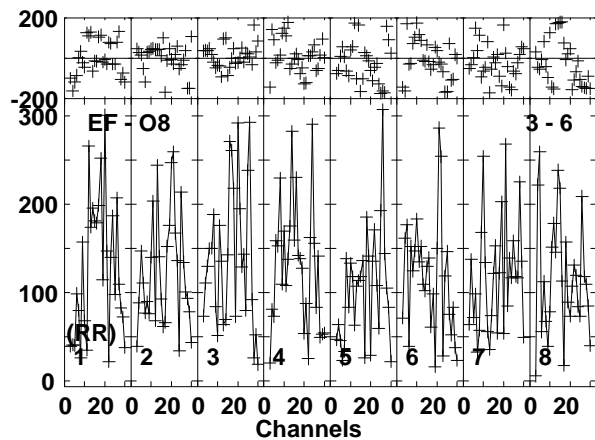
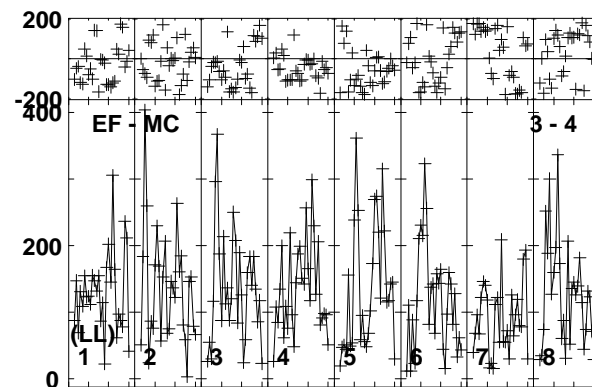
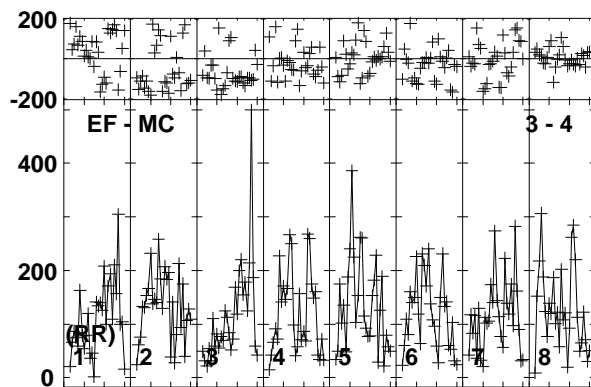
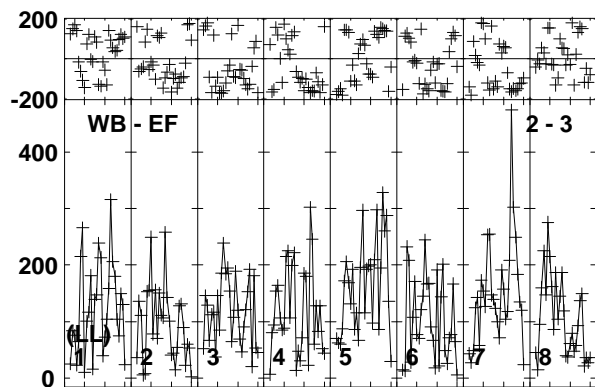
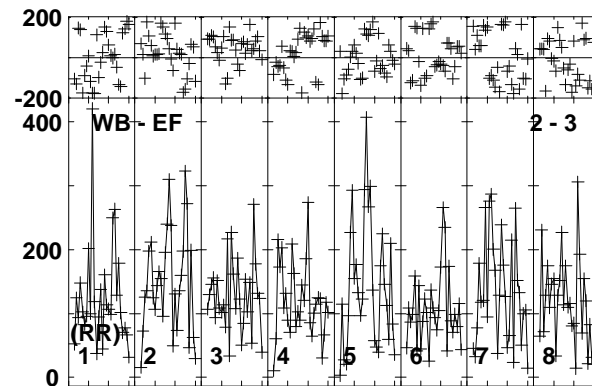
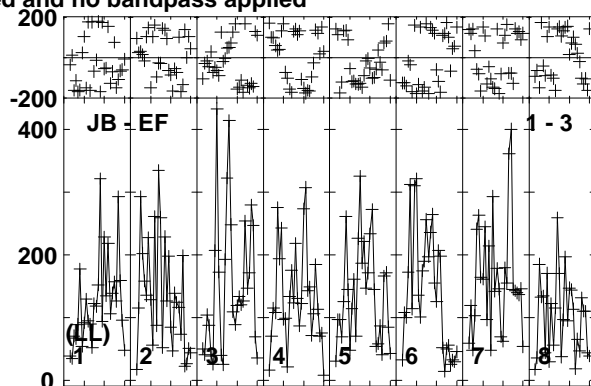
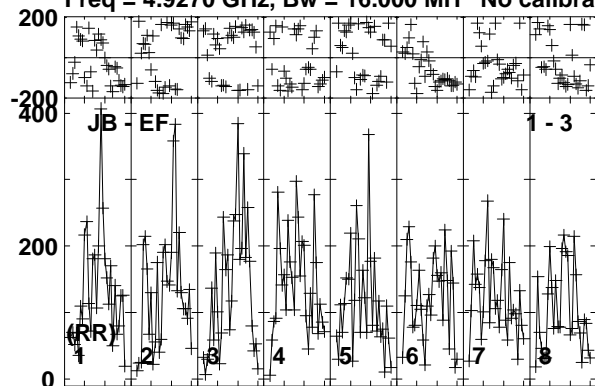

Lower frame: Micro Ampl Jy Top frame: Phas deg  
Vector averaged cross-power spectrum Baseline: JB (01) - EF (03)  
Timerange: 00/19:30:01 to 00/19:31:59

Plot file version1045 created 19-DEC-2018 17:59:19

AT2018\_RY007C.UVDATA.1

Freq = 4.9270 GHz, Bw = 16.000 MH No calibration applied and no bandpass applied

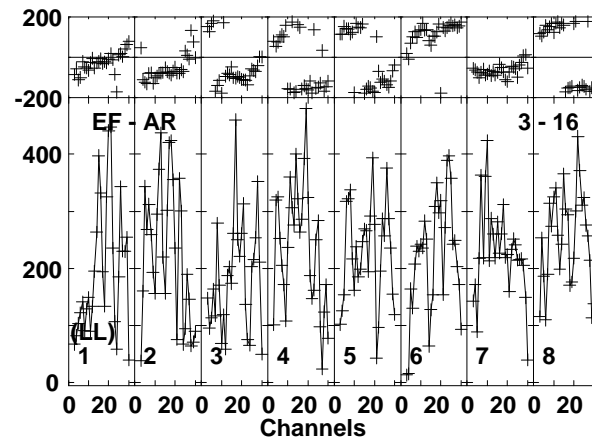
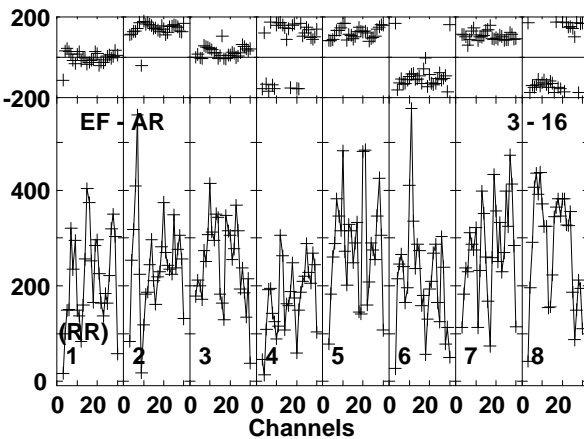
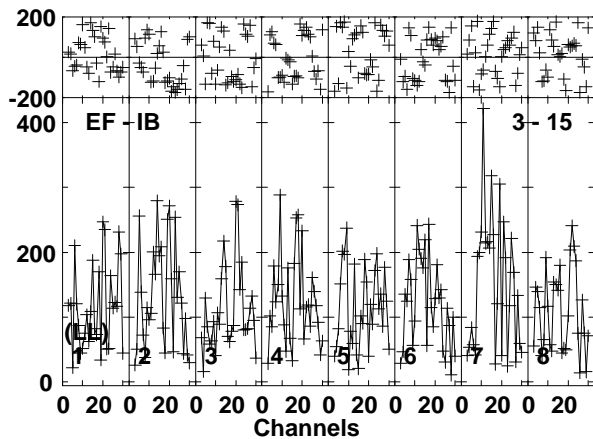
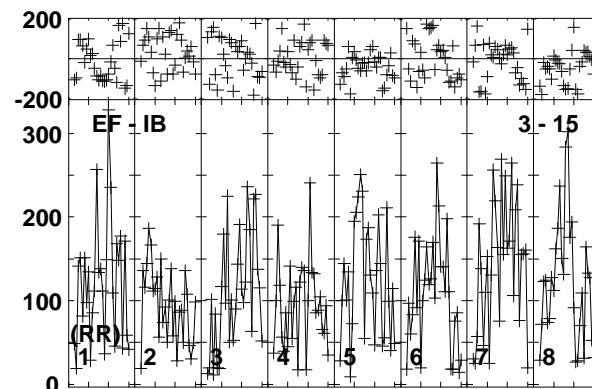
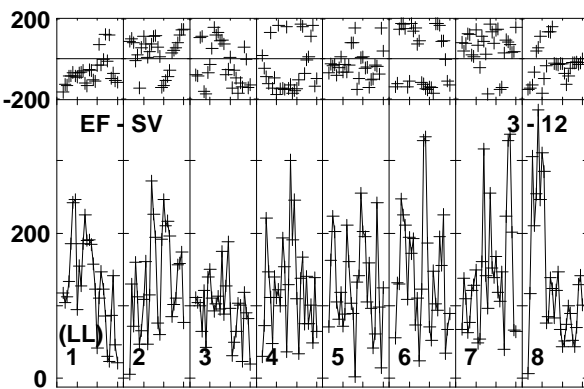
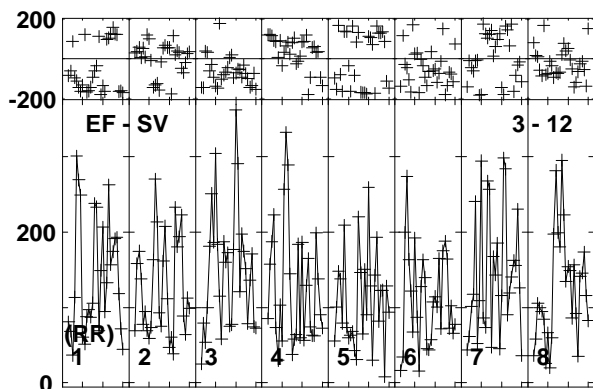
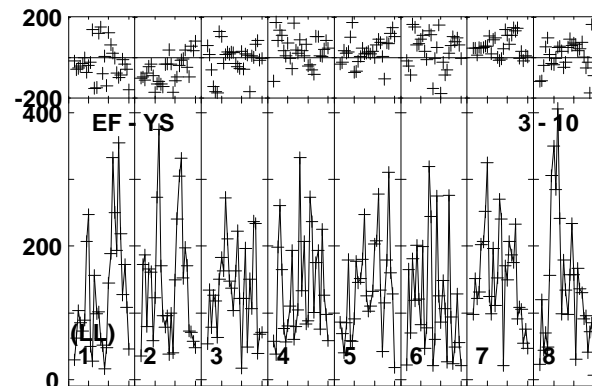
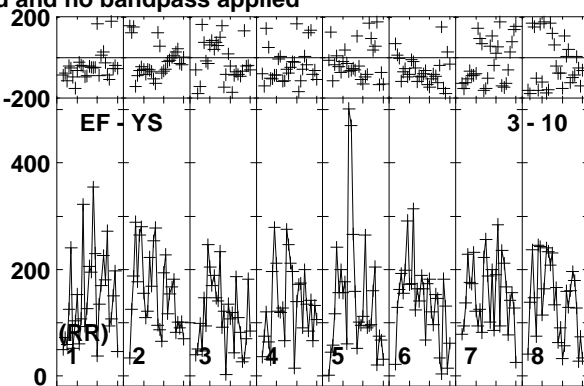
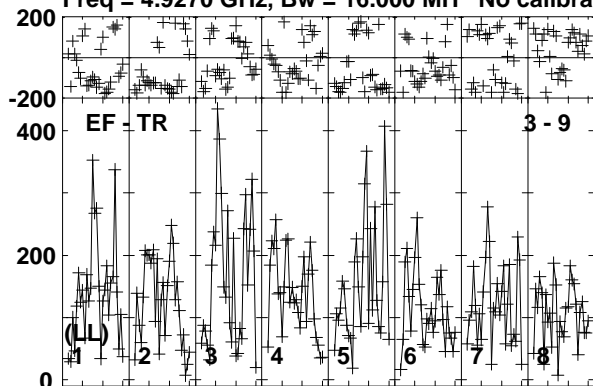

Lower frame: Micro Ampl Jy Top frame: Phas deg  
Vector averaged cross-power spectrum Baseline: EF (03) - TR (09)  
Timerange: 00/19:30:01 to 00/19:31:59

Plot file version1046 created 19-DEC-2018 17:59:19

VLA2 RY007C.UVDATA.1

Freq = 4.9270 GHz, Bw = 16.000 MH No calibration applied and no bandpass applied

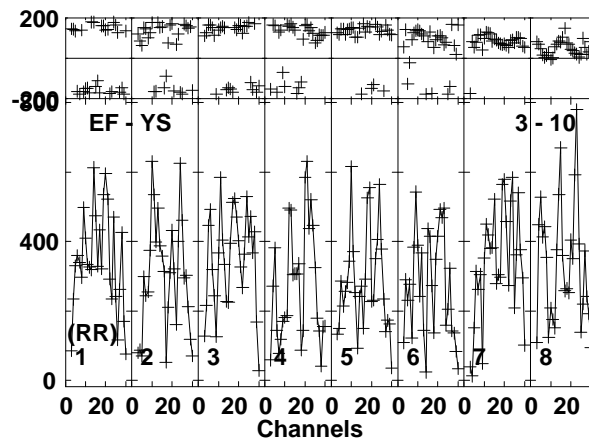
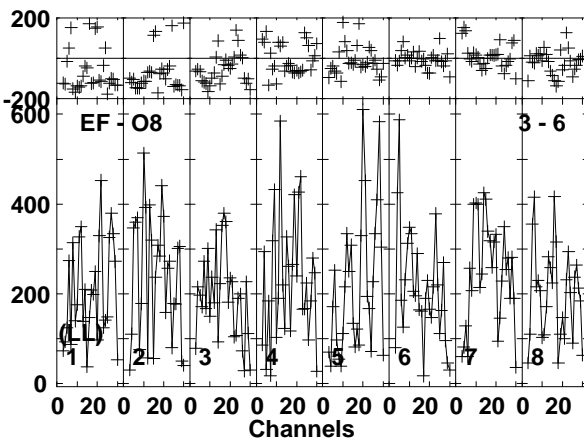
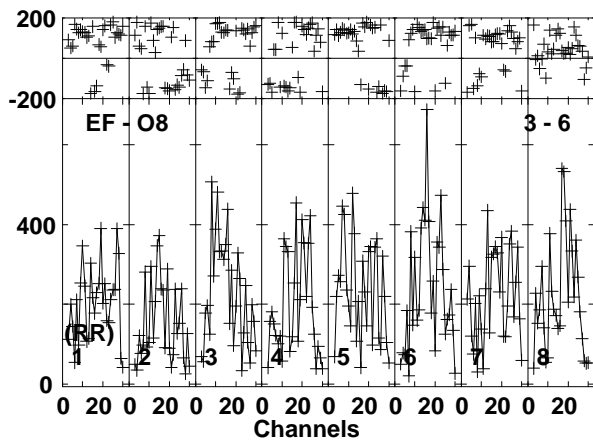
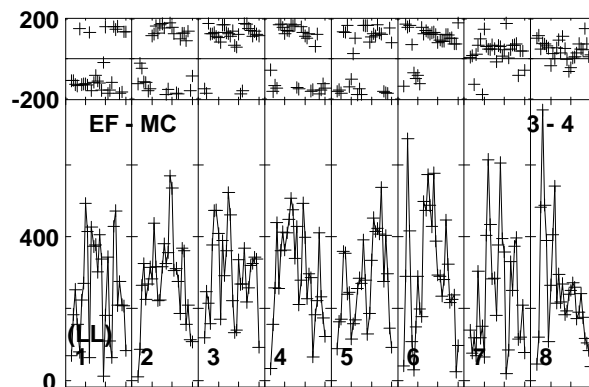
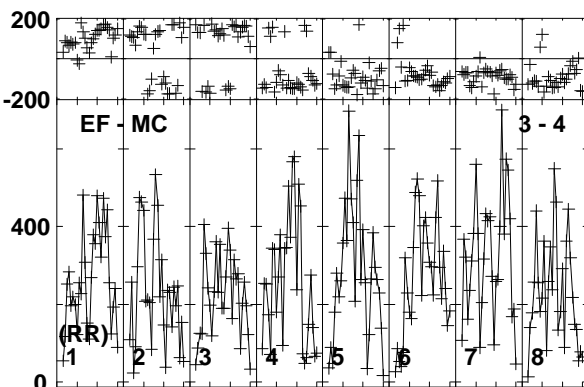
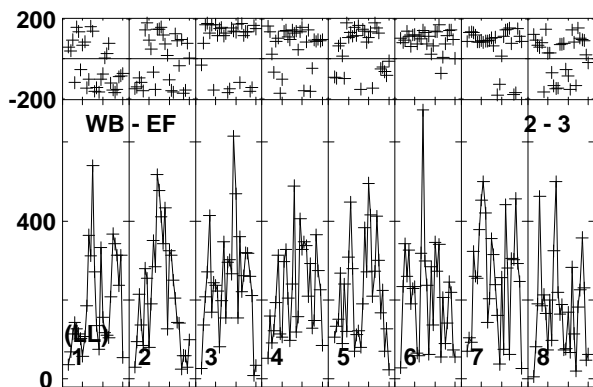
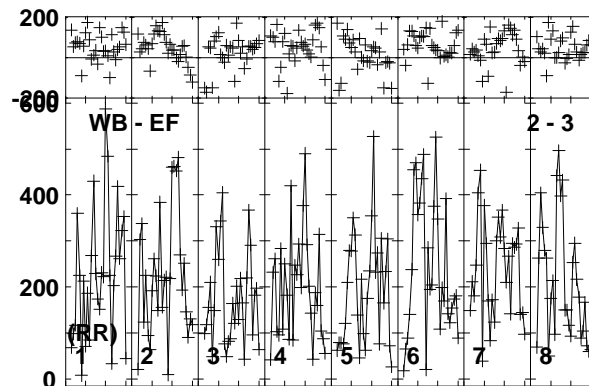
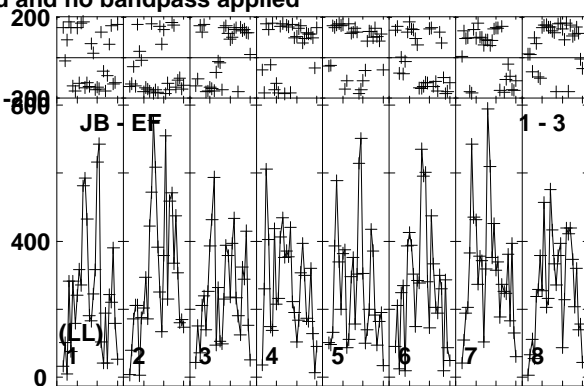
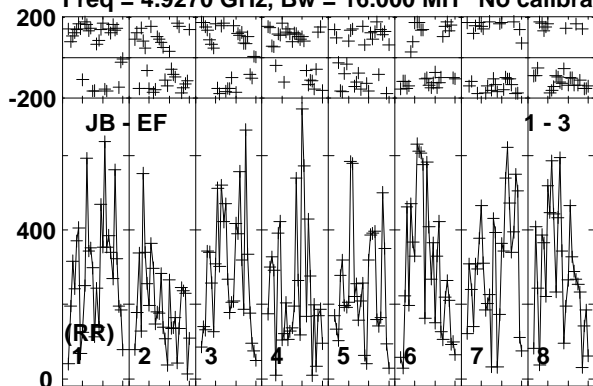

Lower frame: Micro Ampl Jy Top frame: Phas deg  
Vector averaged cross-power spectrum Baseline: JB (01) - EF (03)  
Timerange: 00/19:32:01 to 00/19:32:59

Plot file version1047 created 19-DEC-2018 17:59:19

VLA2 RY007C.UVDATA.1

Freq = 4.9270 GHz, Bw = 16.000 MH No calibration applied and no bandpass applied

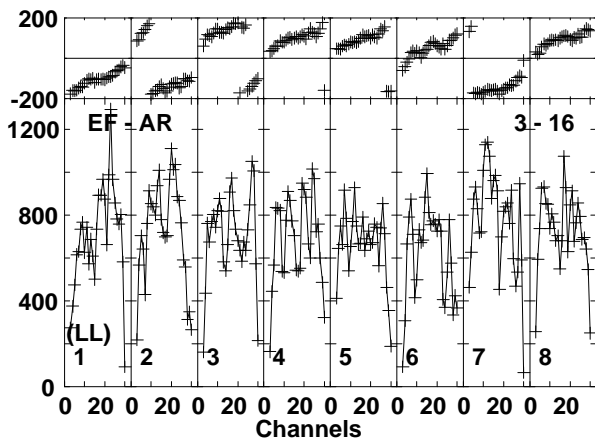
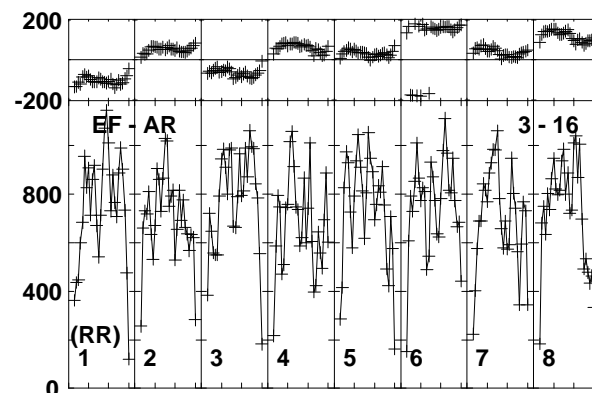
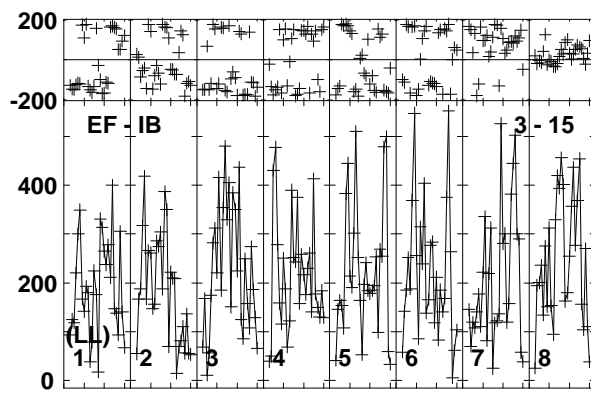
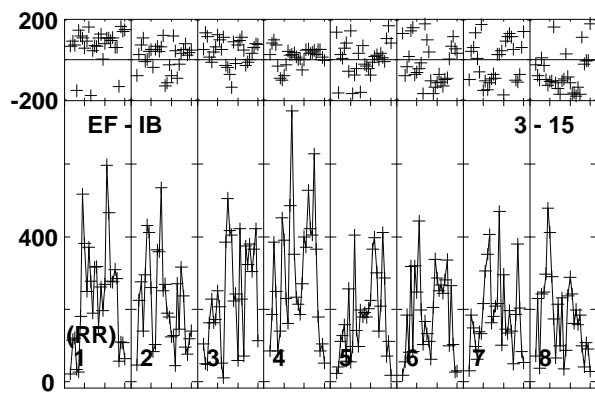
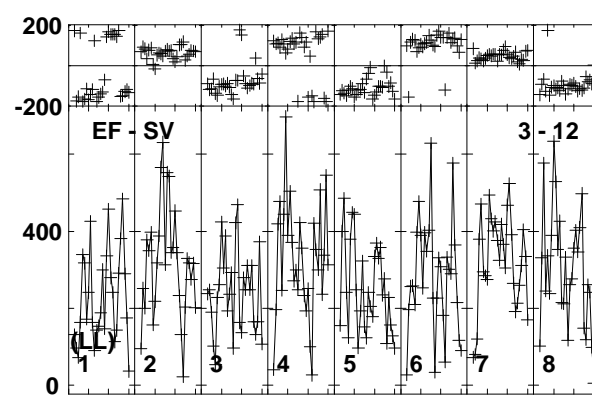
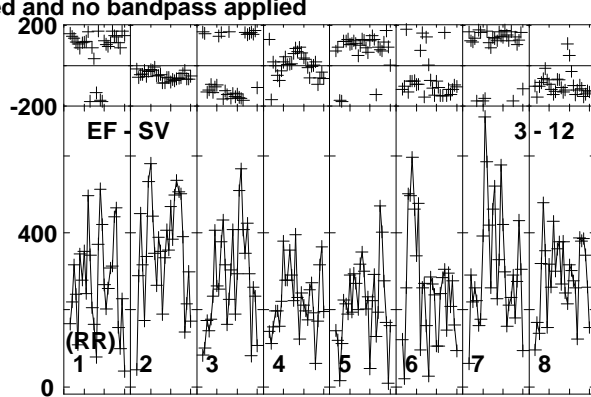
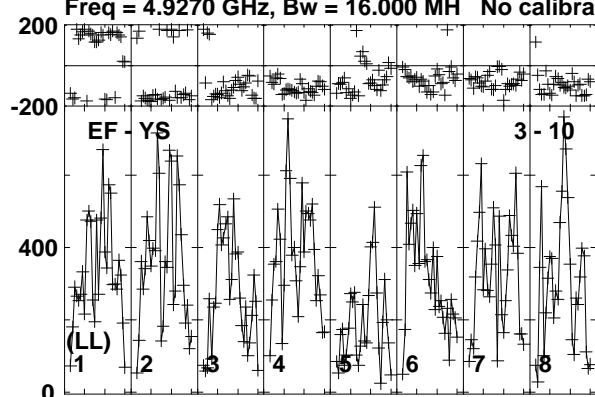

Lower frame: Micro Ampl Jy Top frame: Phas deg  
Vector averaged cross-power spectrum Baseline: EF (03) - YS (10)  
Timerange: 00:19:32:01 to 00:19:32:59

Plot file version1048 created 19-DEC-2018 17:59:19

J1619+2247 RY007C.UVDATA.1

Freq = 4.9270 GHz, Bw = 16.000 MH No calibration applied and no bandpass applied

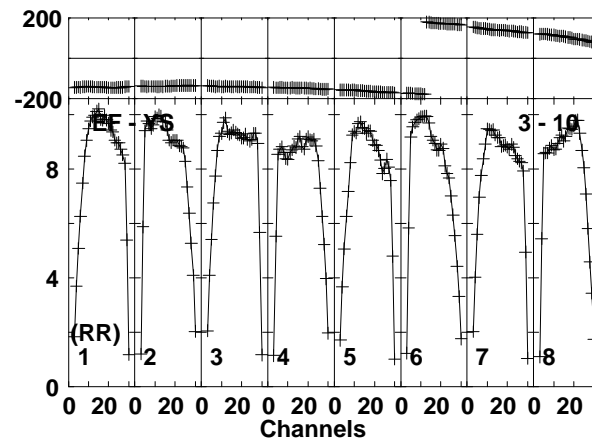
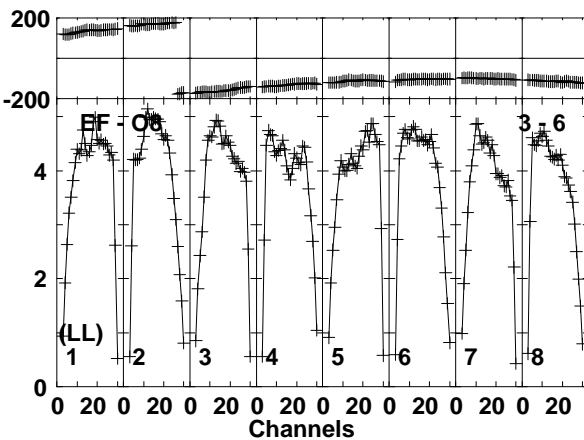
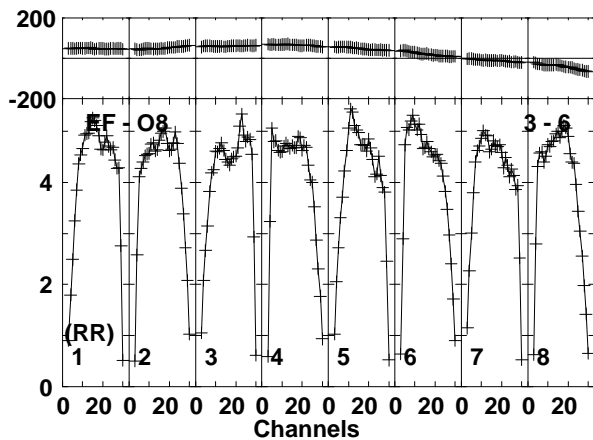
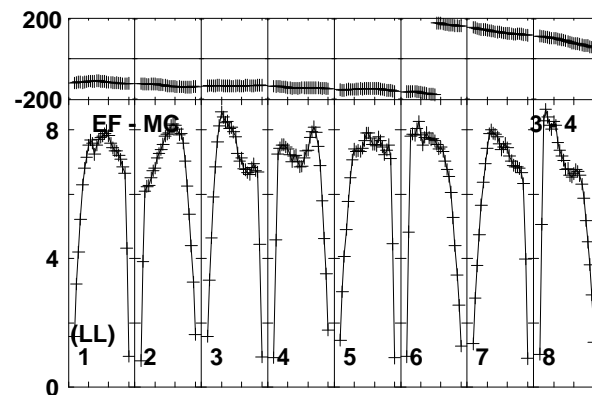
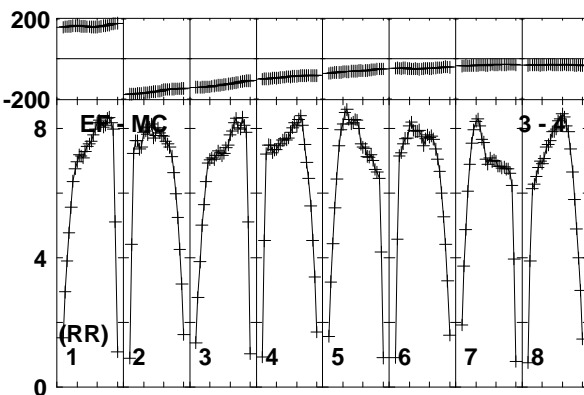
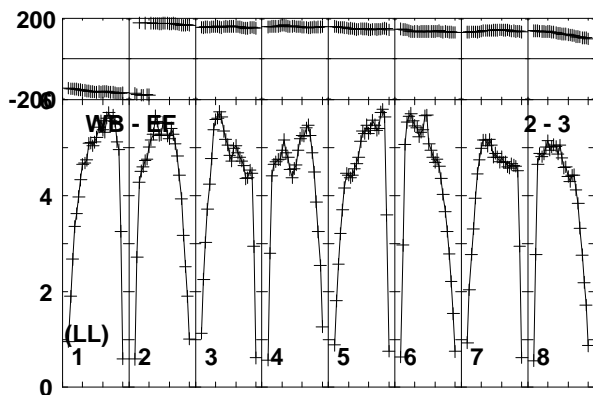
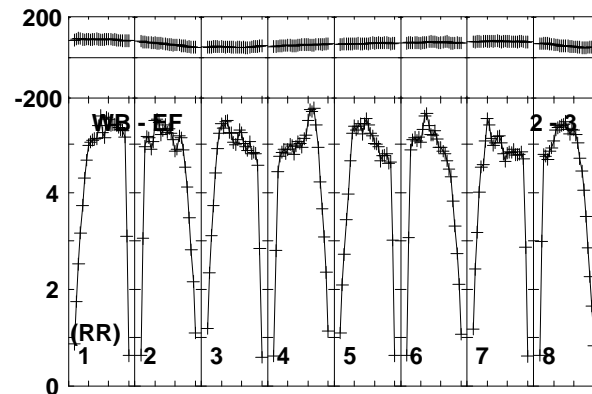
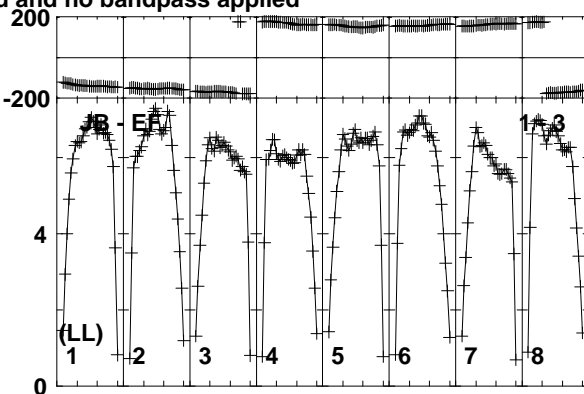
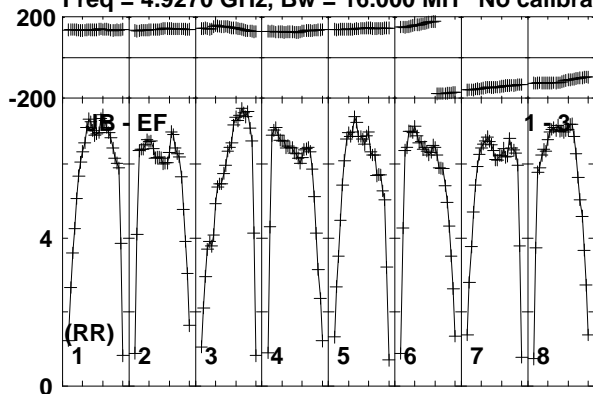

Lower frame: Milli Ampl Jy Top frame: Phas deg  
Vector averaged cross-power spectrum Baseline: JB (01) - EF (03)  
Timerange: 00/19:33:31 to 00/19:34:29

Plot file version1049 created 19-DEC-2018 17:59:19

J1619+2247 RY007C.UVDATA.1

Freq = 4.9270 GHz, Bw = 16.000 MH No calibration applied and no bandpass applied

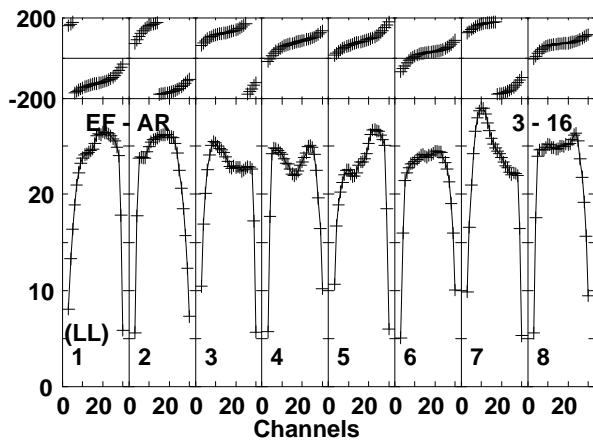
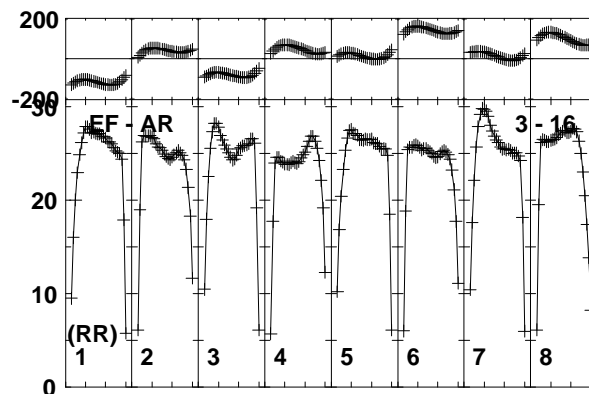
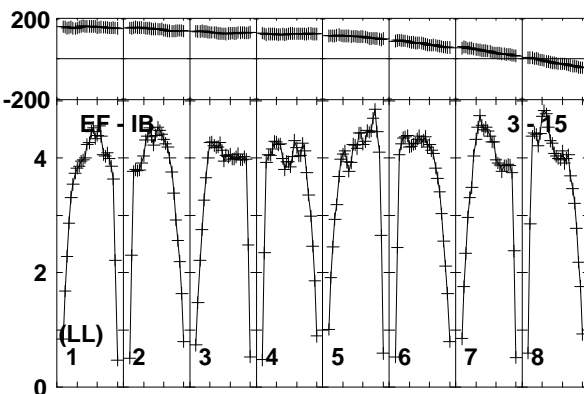
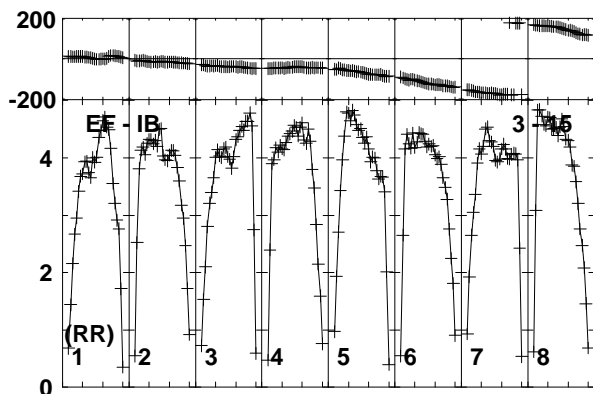
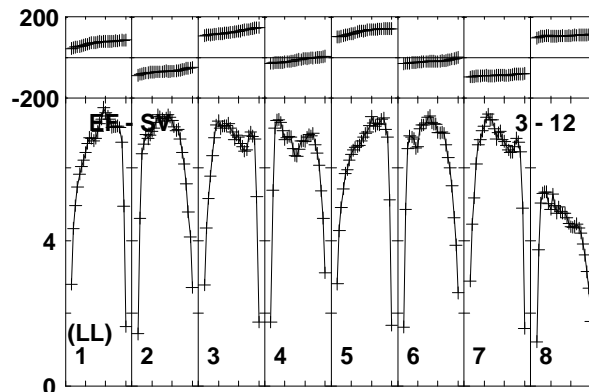
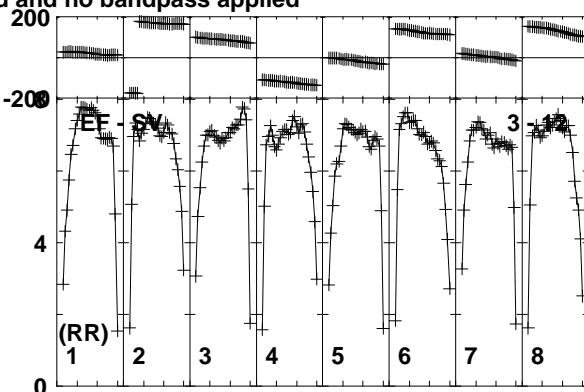
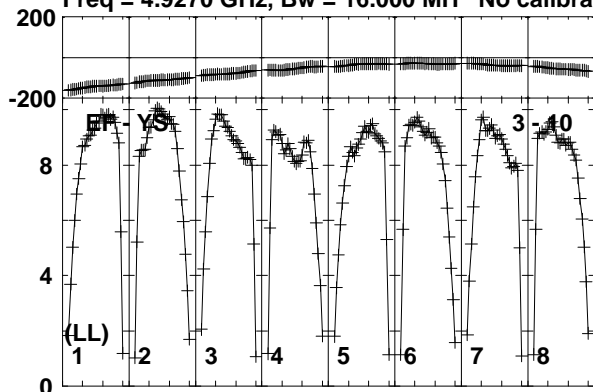

Lower frame: Milli Ampl Jy Top frame: Phas deg  
Vector averaged cross-power spectrum Baseline: EF (03) - YS (10)  
Timerange: 00/19:33:31 to 00/19:34:29

Plot file version1050 created 19-DEC-2018 17:59:19

AT2018\_RY007C.UVDATA.1

Freq = 4.9270 GHz, Bw = 16.000 MH No calibration applied and no bandpass applied

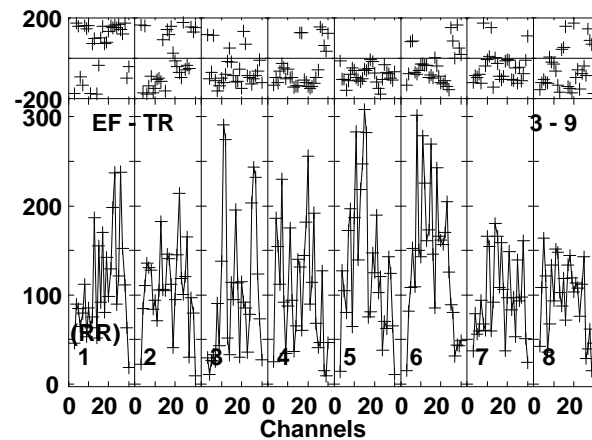
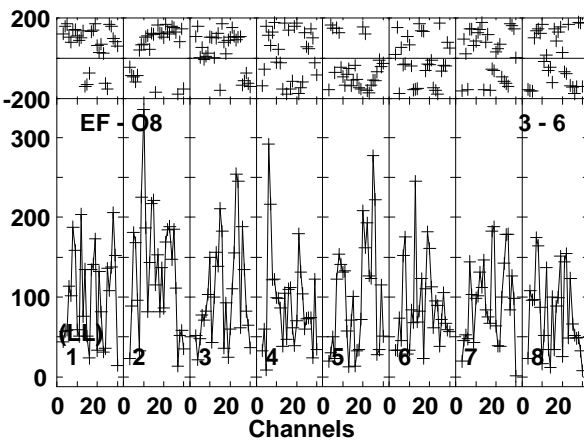
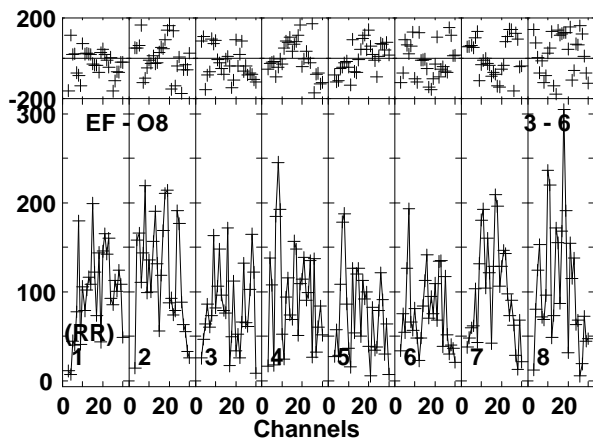
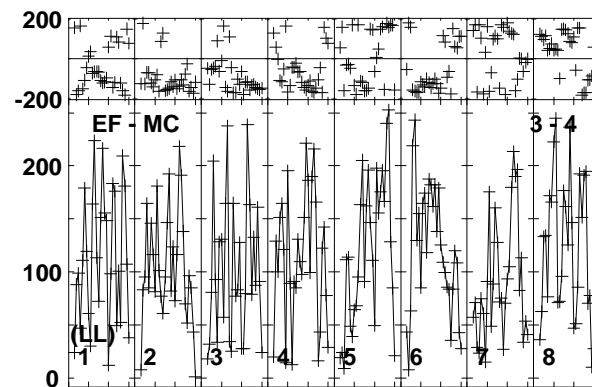
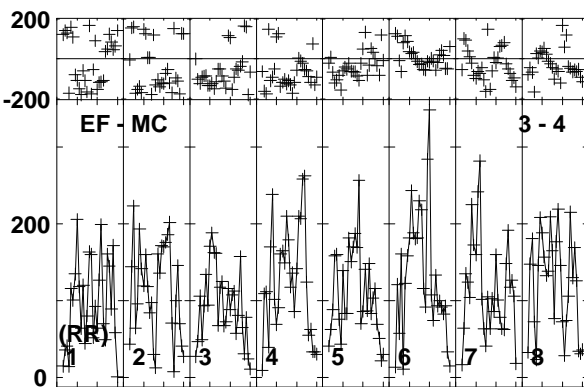
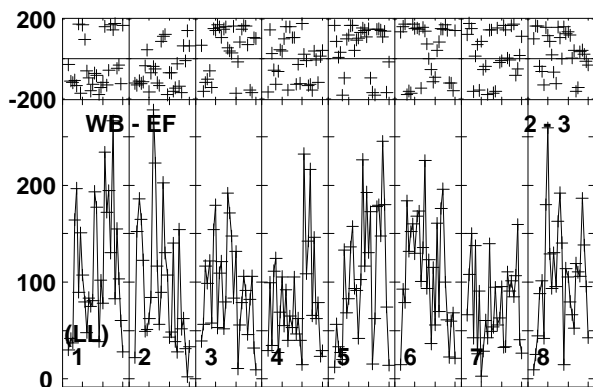
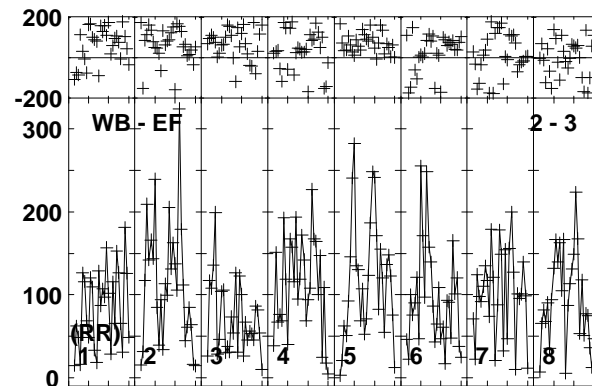
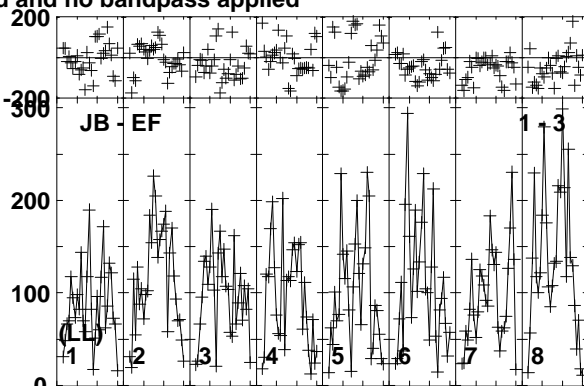
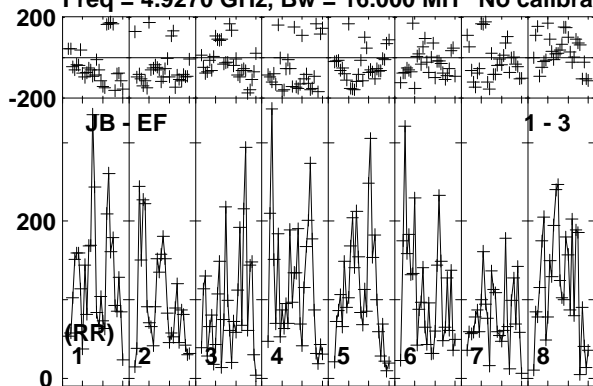

Lower frame: Micro Ampl Jy Top frame: Phas deg  
Vector averaged cross-power spectrum Baseline: JB (01) - EF (03)  
Timerange: 00/19:34:31 to 00/19:37:29



Plot file version1051 created 19-DEC-2018 17:59:19

AT2018\_RY007C.UVDATA.1

Freq = 4.9270 GHz, Bw = 16.000 MH No calibration applied and no bandpass applied

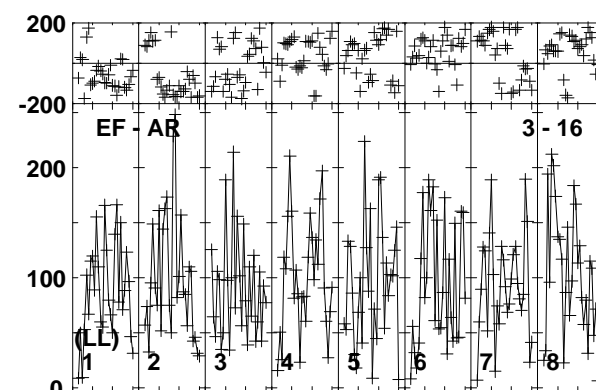
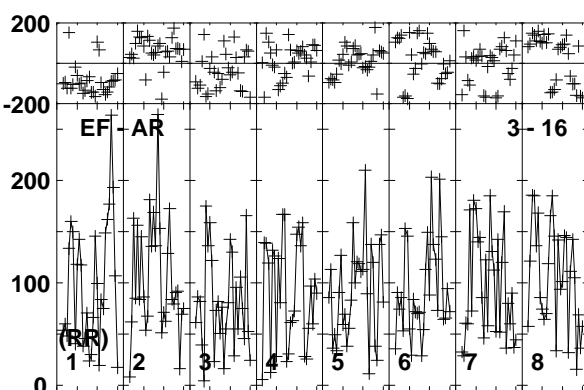
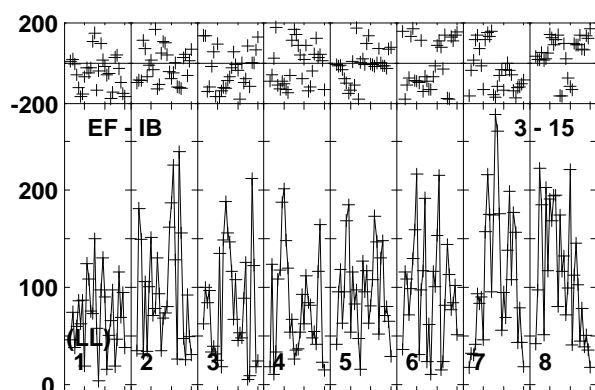
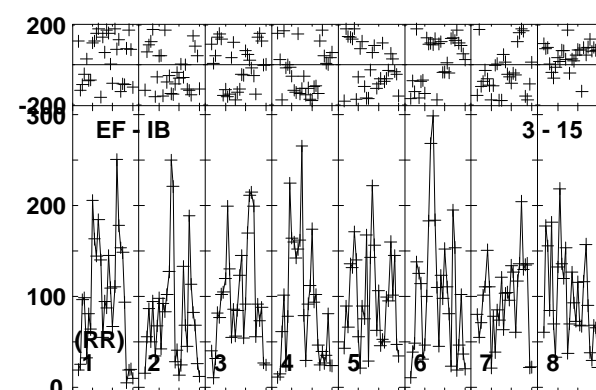
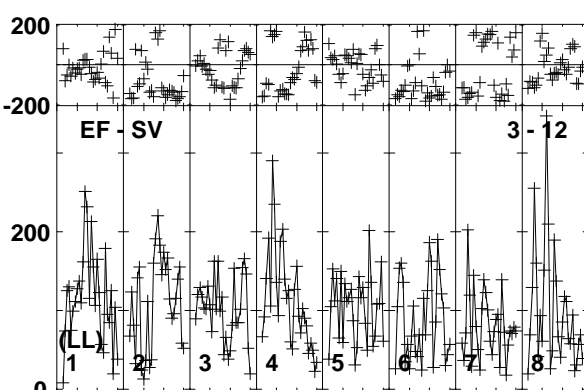
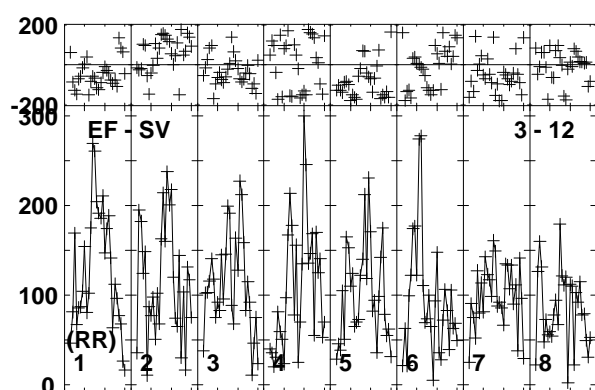
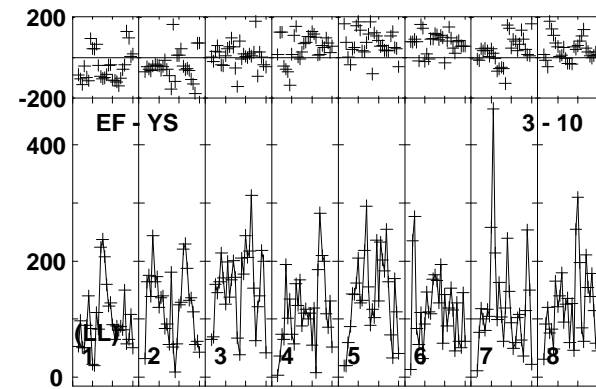
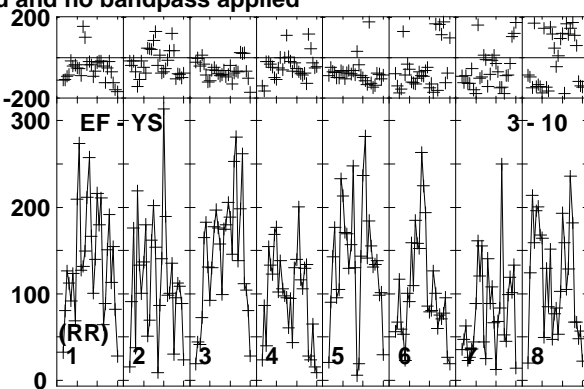
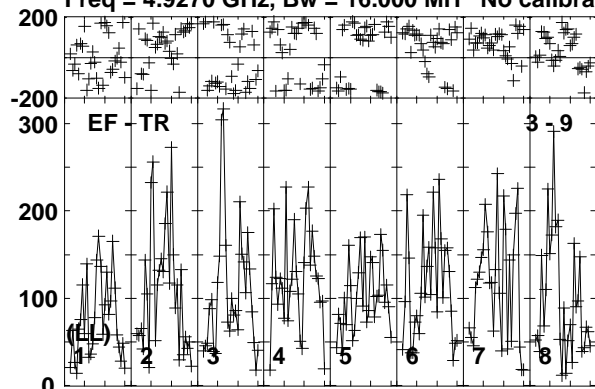

Lower frame: Micro Ampl Jy Top frame: Phas deg  
Vector averaged cross-power spectrum Baseline: EF (03) - TR (09)  
Timerange: 00/19:34:31 to 00/19:37:29

Plot file version1052 created 19-DEC-2018 17:59:19

J1619+2247 RY007C.UVDATA.1

Freq = 4.9270 GHz, Bw = 16.000 MH No calibration applied and no bandpass applied

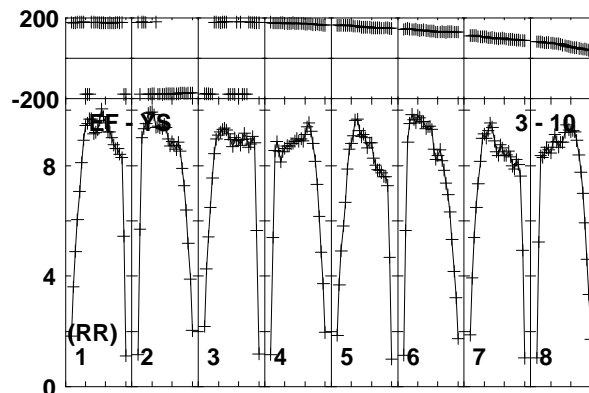
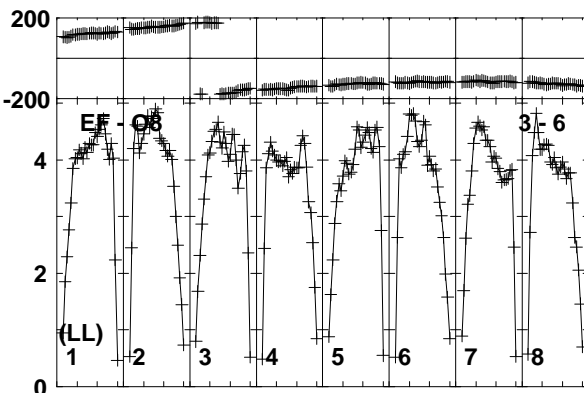
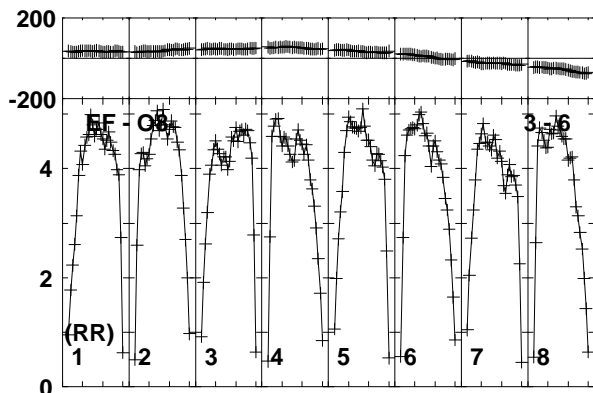
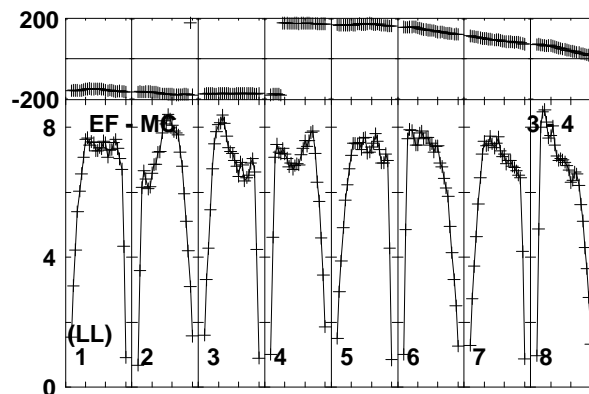
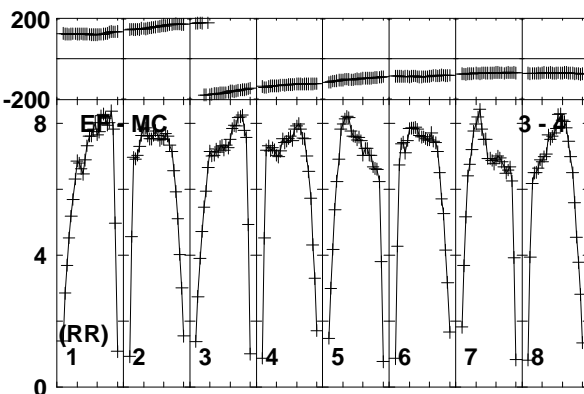
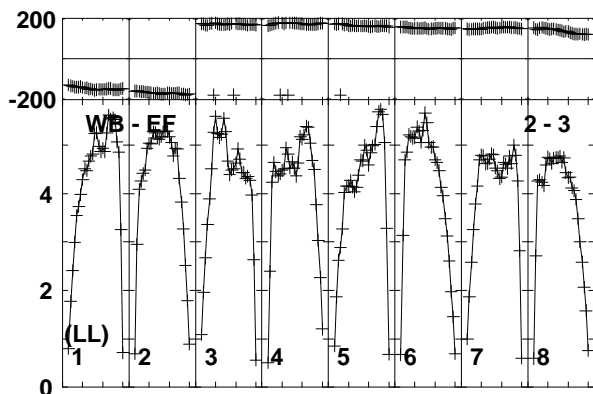
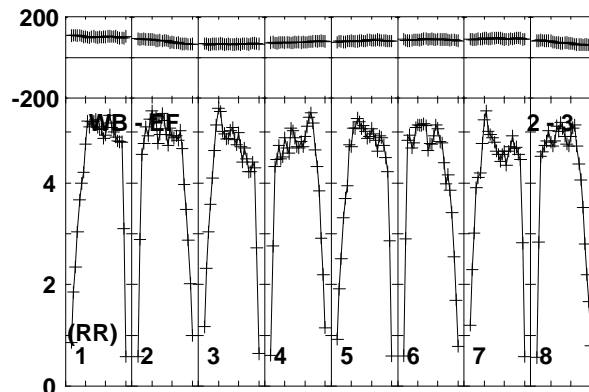
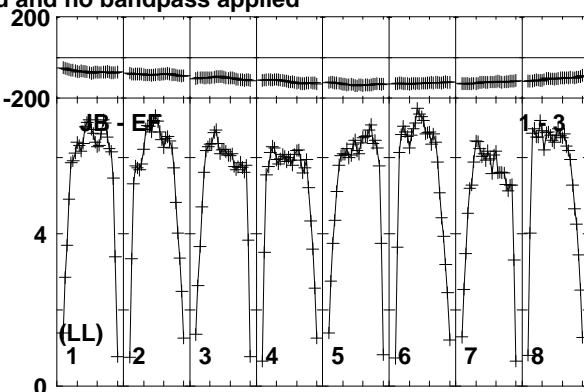
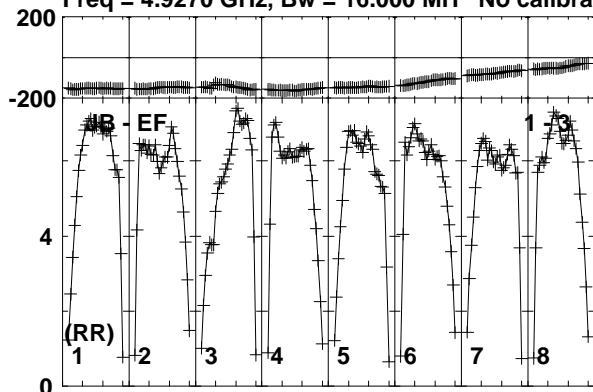

Lower frame: Milli Ampl Jy Top frame: Phas deg  
Vector averaged cross-power spectrum Baseline: JB (01) - EF (03)  
Timerange: 00/19:37:31 to 00/19:38:29

Plot file version1053 created 19-DEC-2018 17:59:19

J1619+2247 RY007C.UVDATA.1

Freq = 4.9270 GHz, Bw = 16.000 MH No calibration applied and no bandpass applied

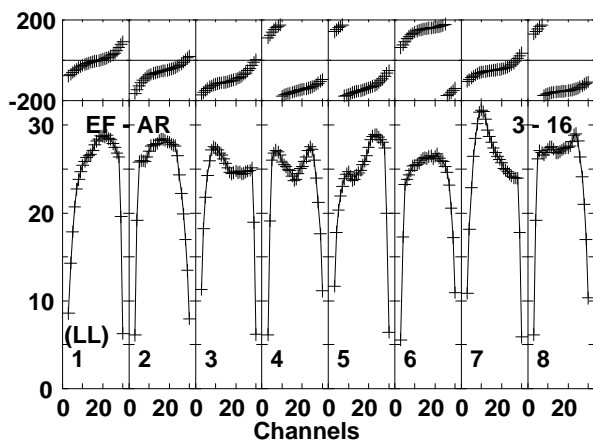
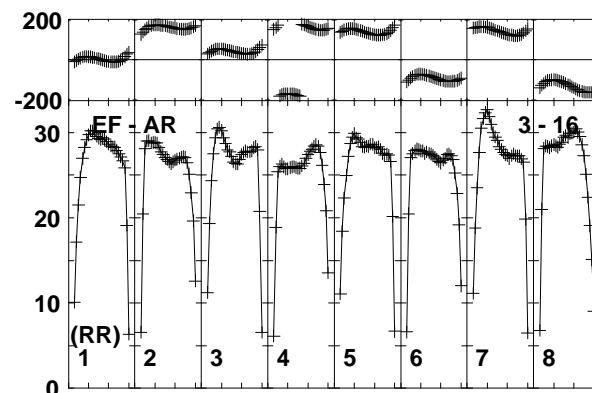
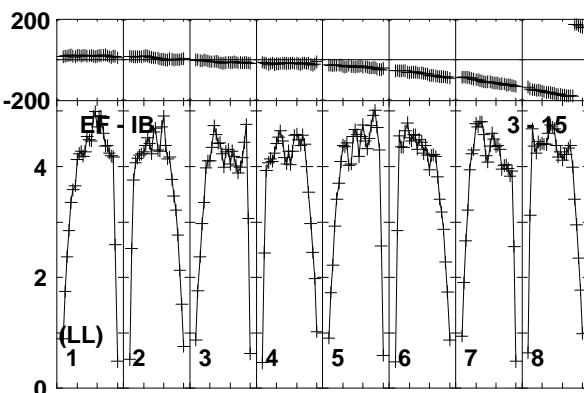
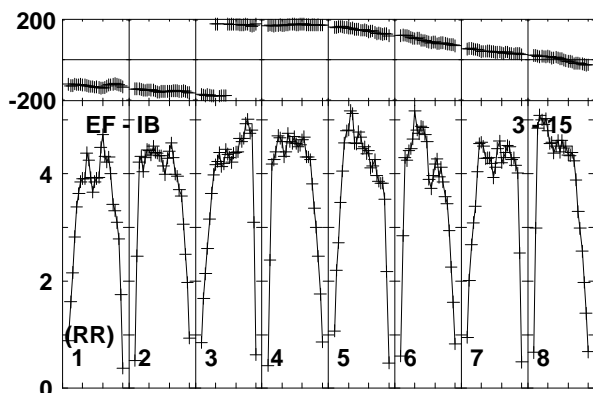
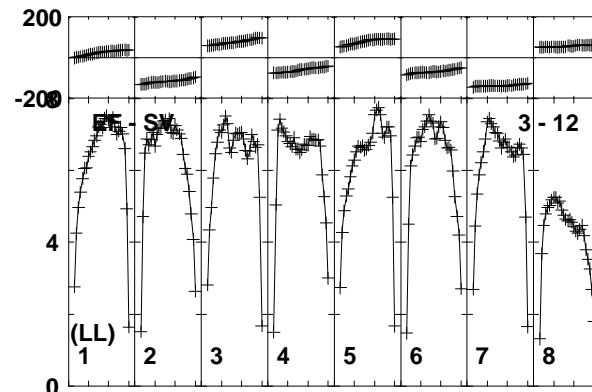
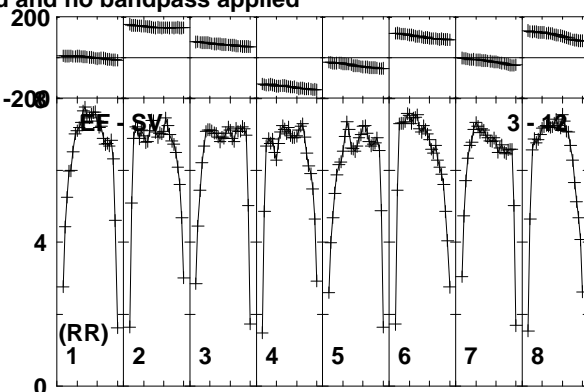
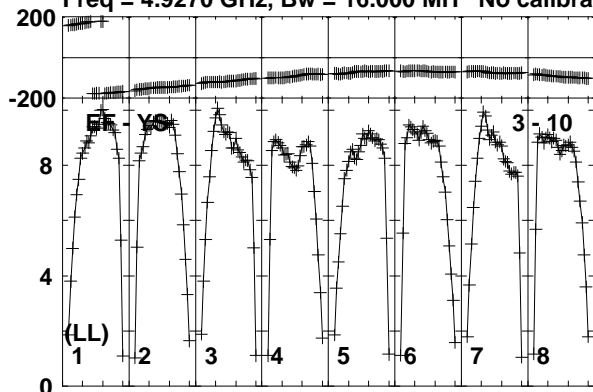

Lower frame: Milli Ampl Jy Top frame: Phas deg  
Vector averaged cross-power spectrum Baseline: EF (03) - YS (10)  
Timerange: 00/19:37:31 to 00/19:38:29

Plot file version1054 created 19-DEC-2018 17:59:19  
AT2018\_RY007C.UVDATA.1

Freq = 4.9270 GHz, Bw = 16.000 MH No calibration applied and no bandpass applied

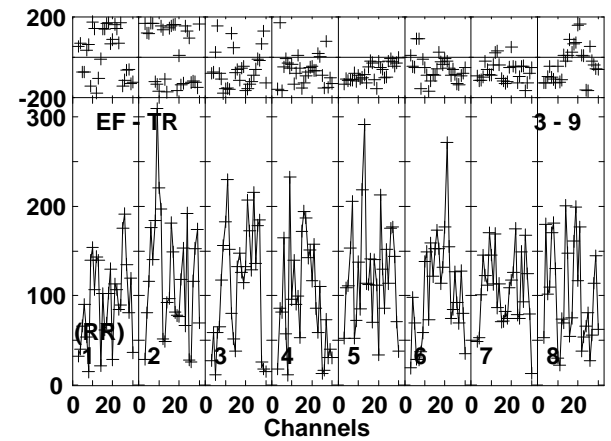
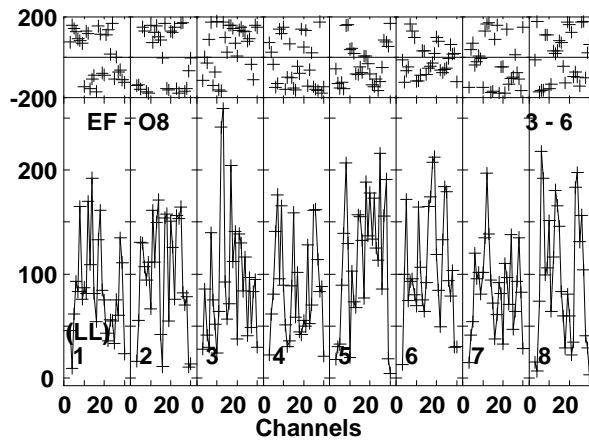
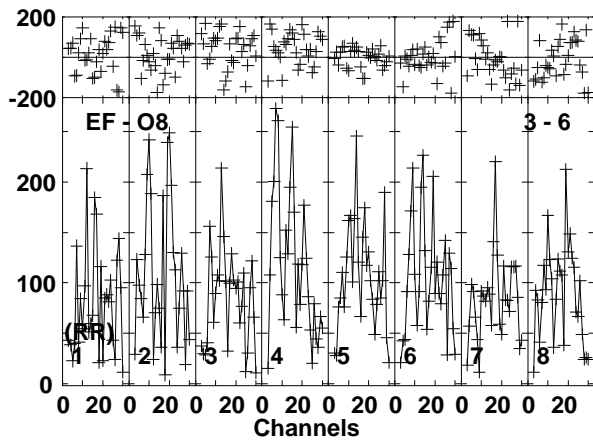
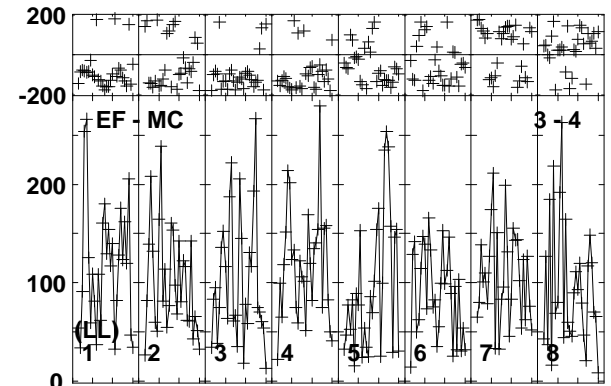
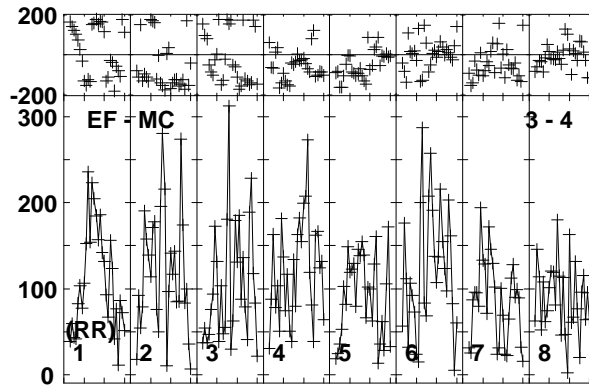
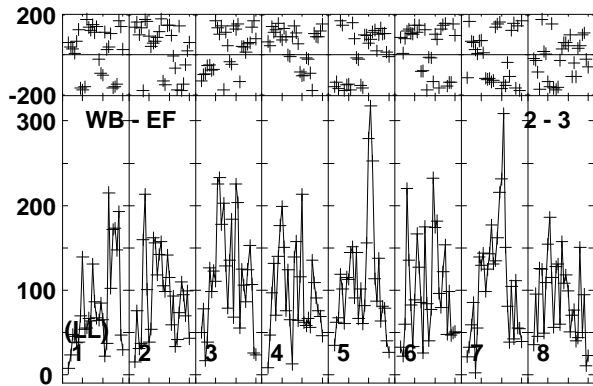
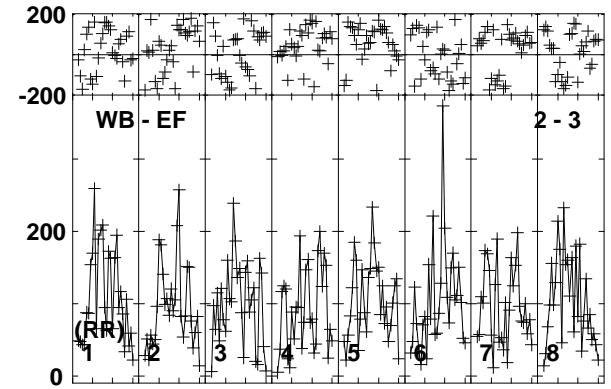
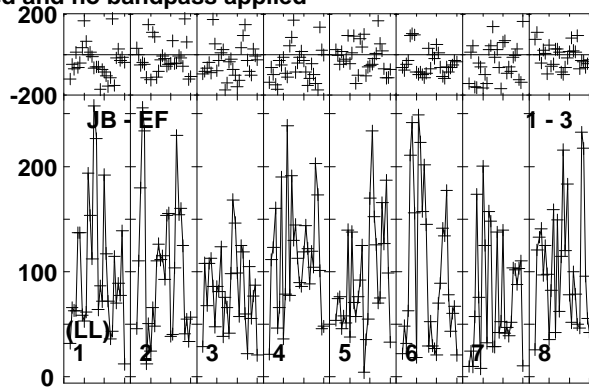
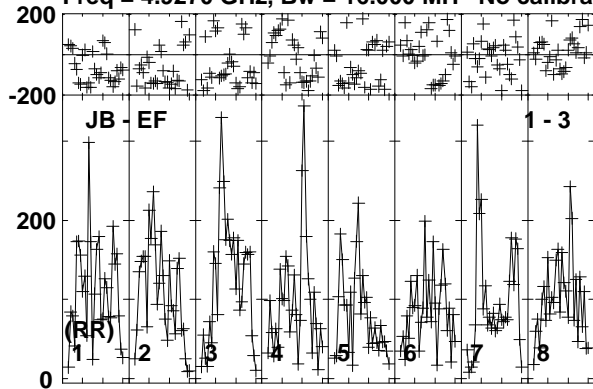

Lower frame: Micro Ampl Jy Top frame: Phas deg  
Vector averaged cross-power spectrum Baseline: JB (01) - EF (03)  
Timerange: 00/19:38:31 to 00/19:41:29

Plot file version1055 created 19-DEC-2018 17:59:20

AT2018\_RY007C.UVDATA.1

Freq = 4.9270 GHz, Bw = 16.000 MH No calibration applied and no bandpass applied

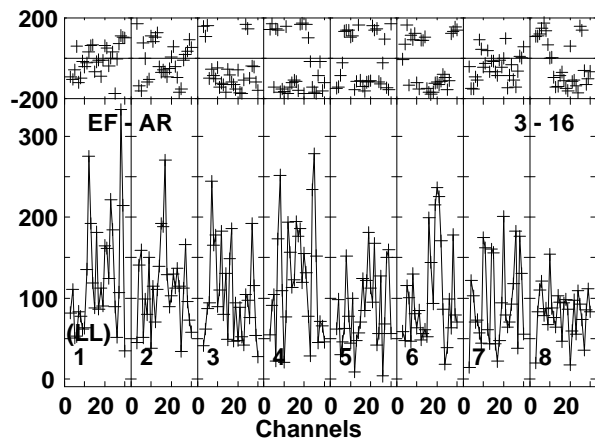
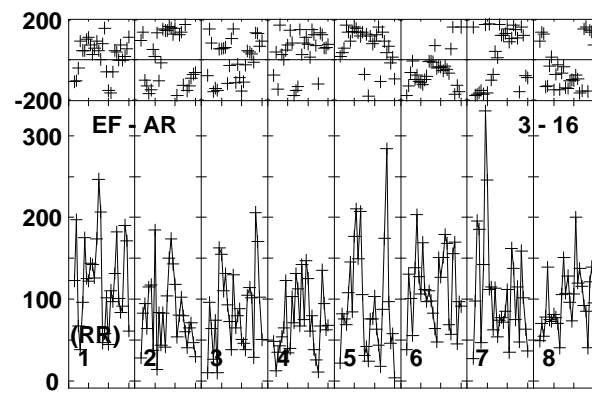
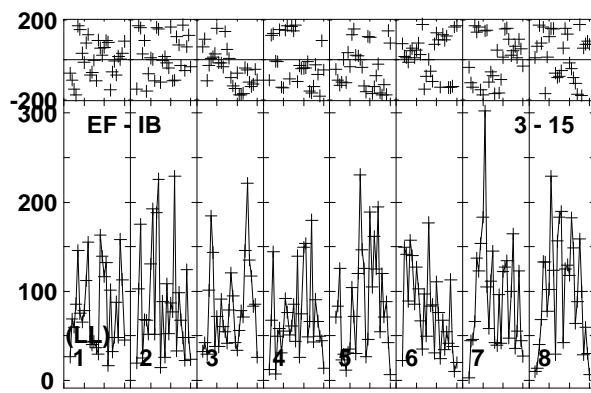
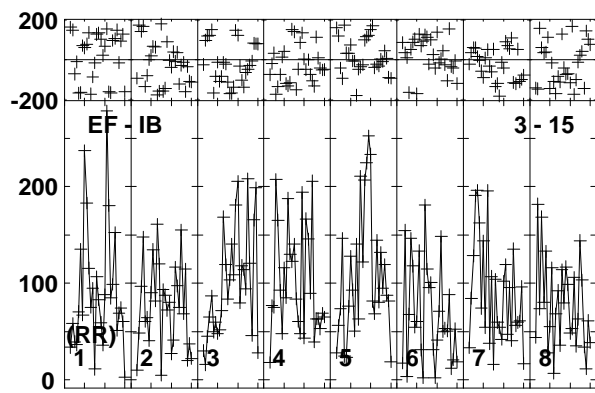
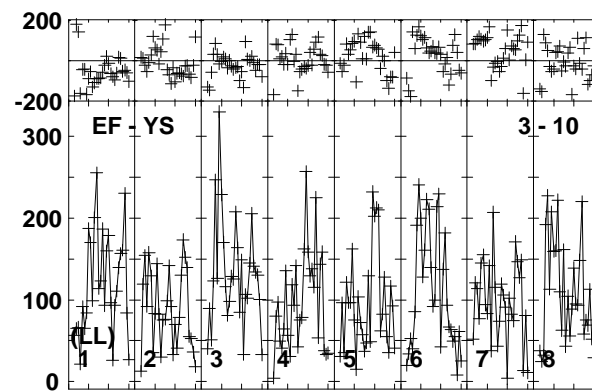
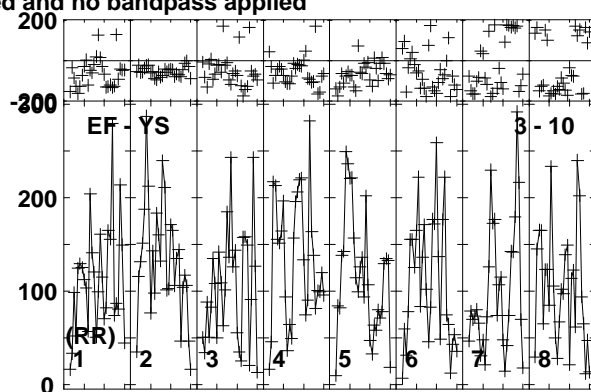
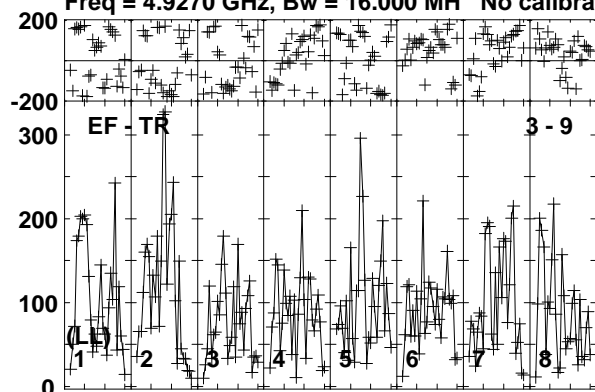

Lower frame: Micro Ampl Jy Top frame: Phas deg  
Vector averaged cross-power spectrum Baseline: EF (03) - TR (09)  
Timerange: 00/19:38:31 to 00/19:41:29

Plot file version1056 created 19-DEC-2018 17:59:20

J1619+2247 RY007C.UVDATA.1

Freq = 4.9270 GHz, Bw = 16.000 MH No calibration applied and no bandpass applied

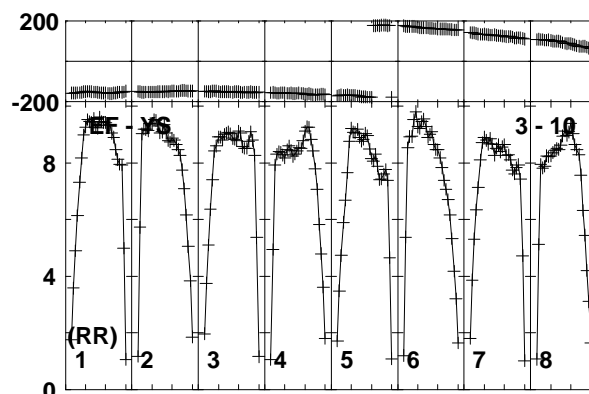
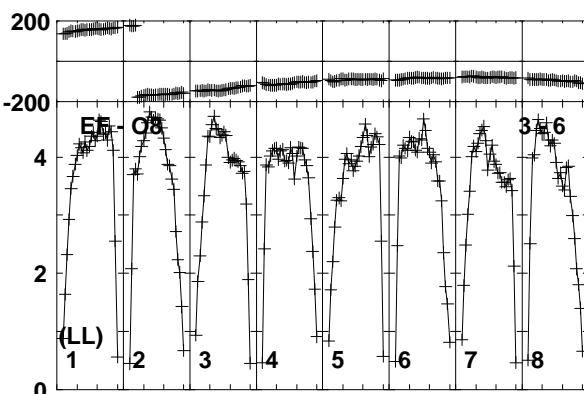
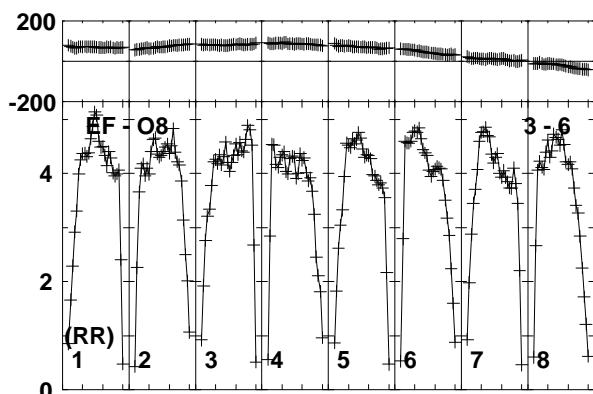
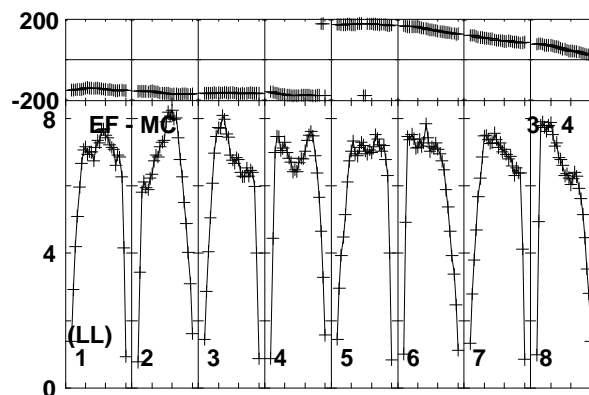
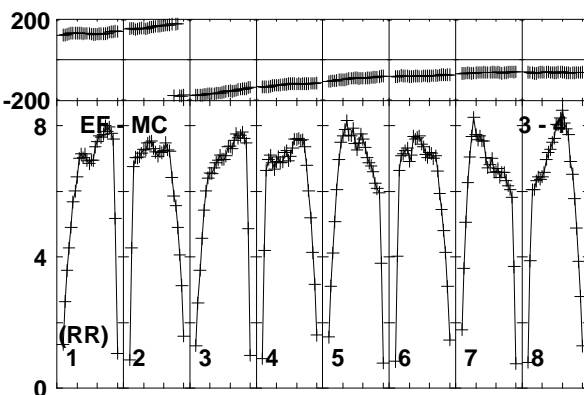
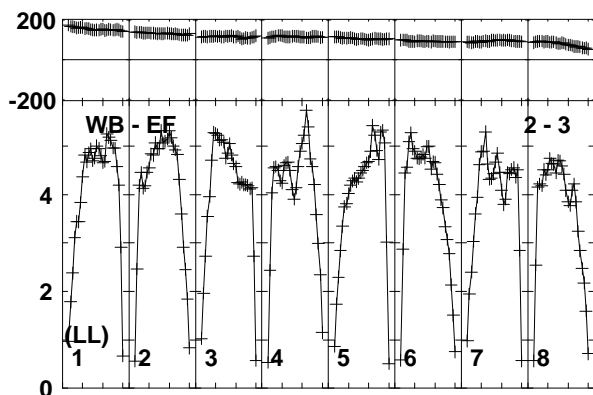
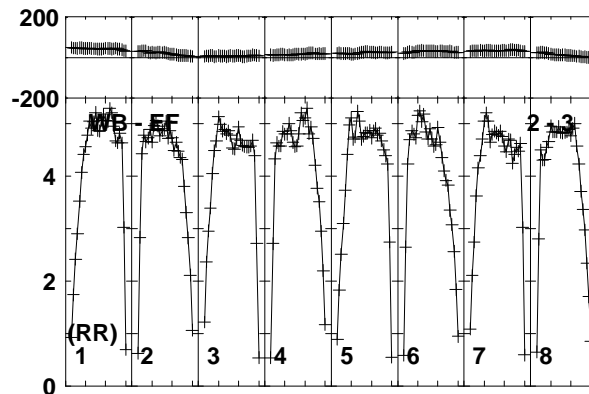
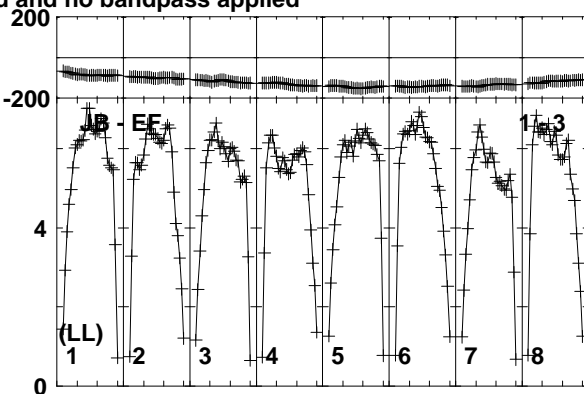
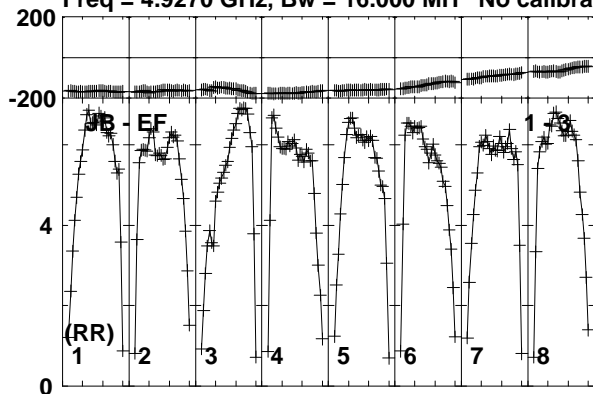

Lower frame: Milli Ampl Jy Top frame: Phas deg  
Vector averaged cross-power spectrum Baseline: JB (01) - EF (03)  
Timerange: 00/19:41:31 to 00/19:42:29

Plot file version1057 created 19-DEC-2018 17:59:20

J1619+2247 RY007C.UVDATA.1

Freq = 4.9270 GHz, Bw = 16.000 MH No calibration applied and no bandpass applied

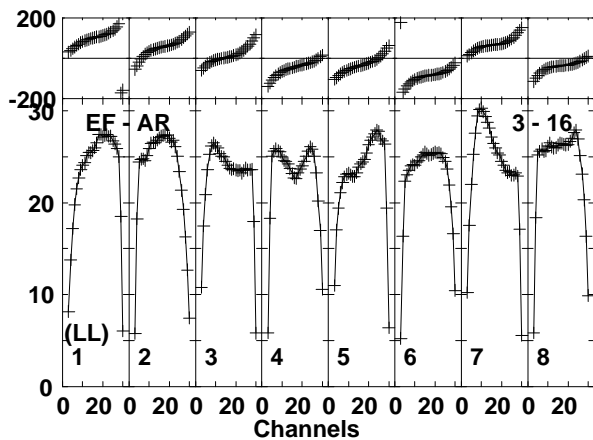
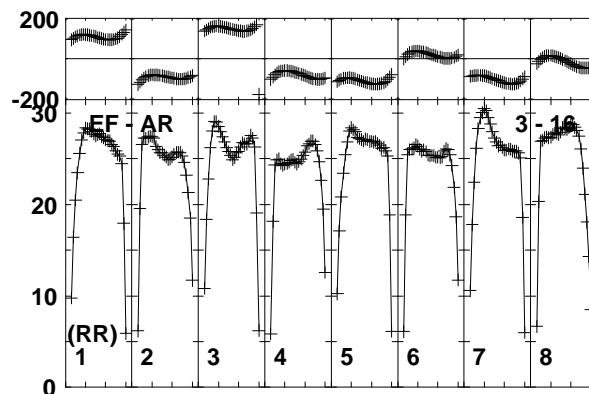
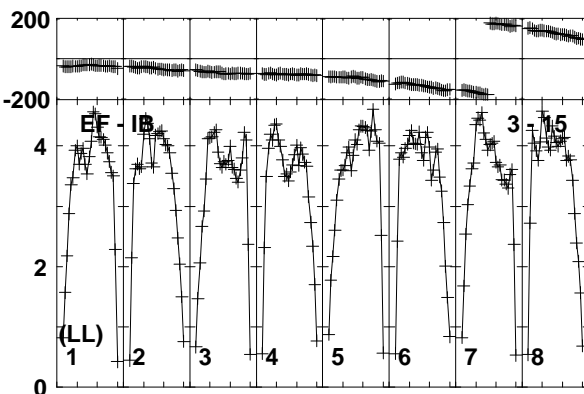
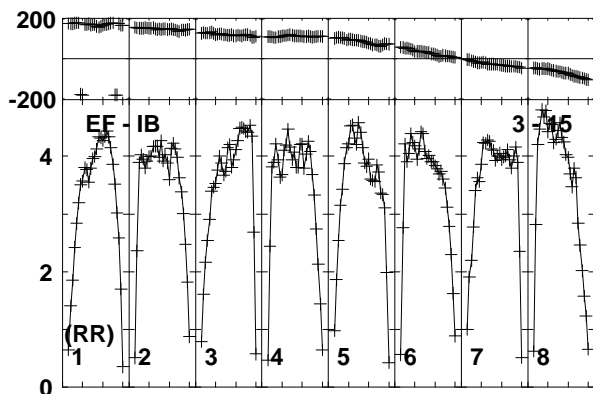
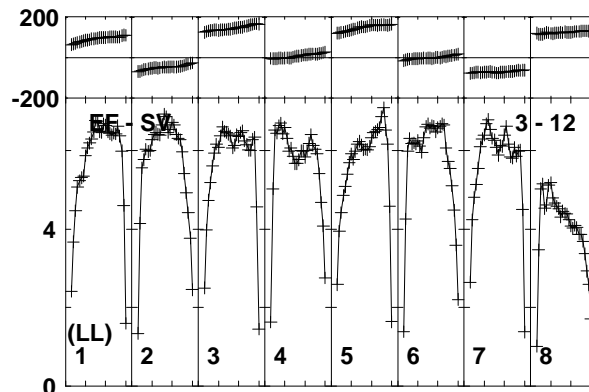
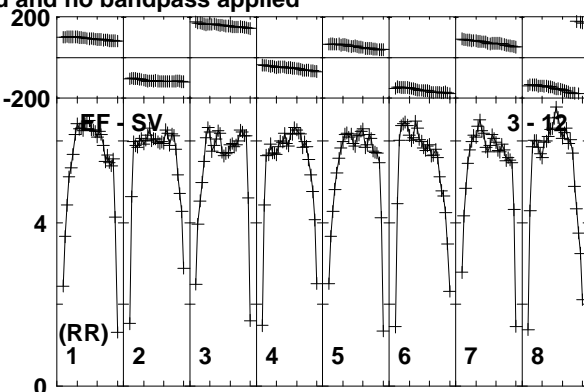
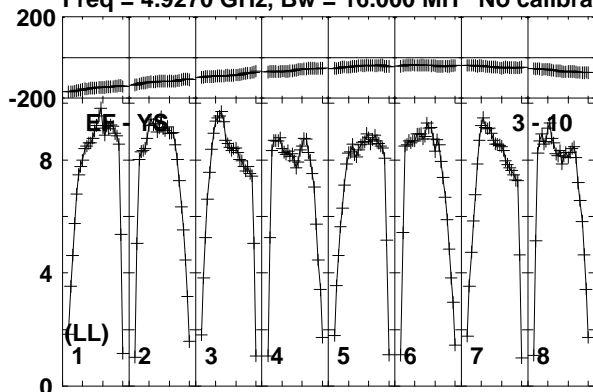

Lower frame: Milli Ampl Jy Top frame: Phas deg  
Vector averaged cross-power spectrum Baseline: EF (03) - YS (10)  
Timerange: 00/19:41:31 to 00/19:42:29

Plot file version1058 created 19-DEC-2018 17:59:20

VLA1 RY007C.UVDATA.1

Freq = 4.9270 GHz, Bw = 16.000 MH No calibration applied and no bandpass applied

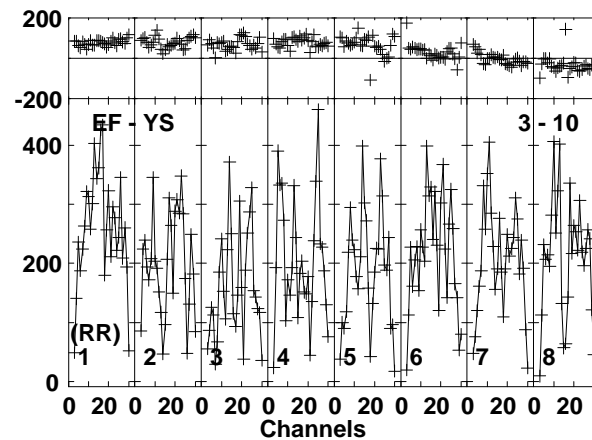
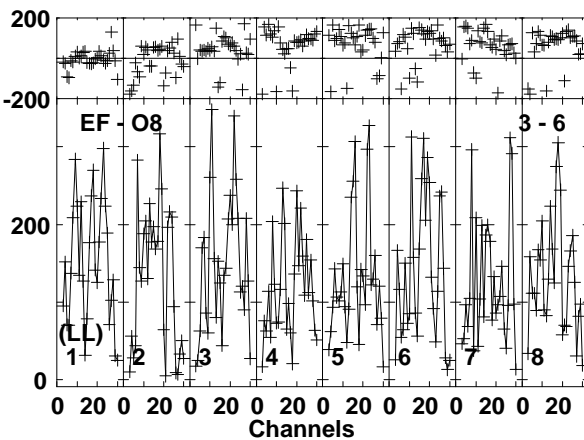
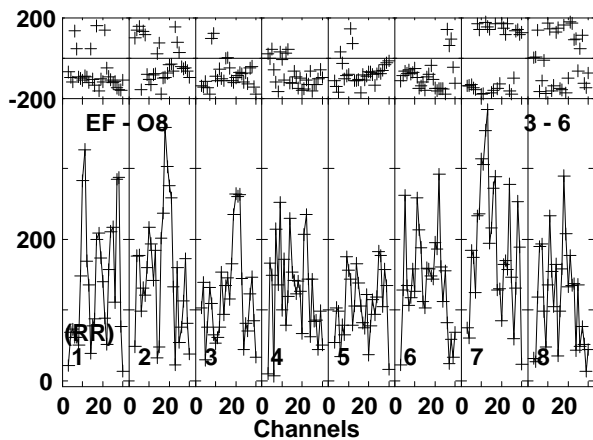
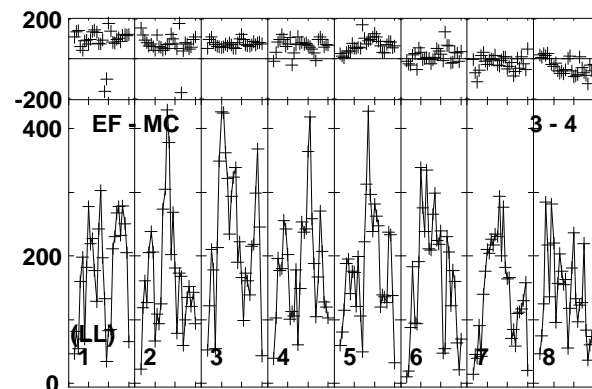
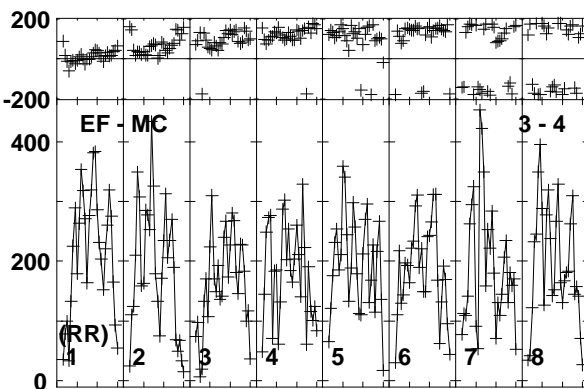
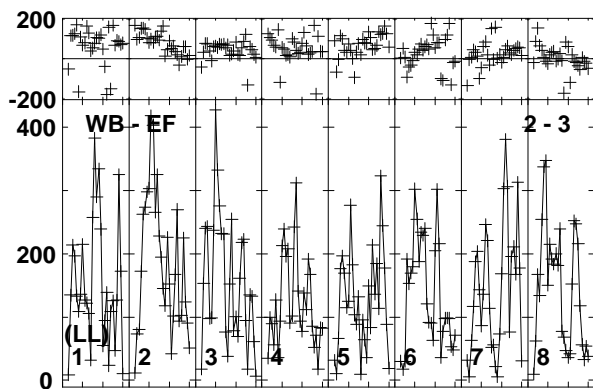
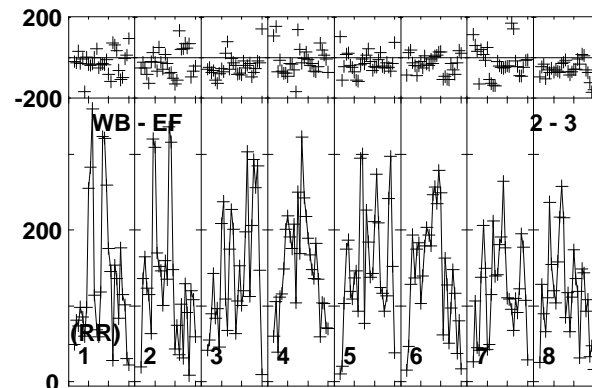
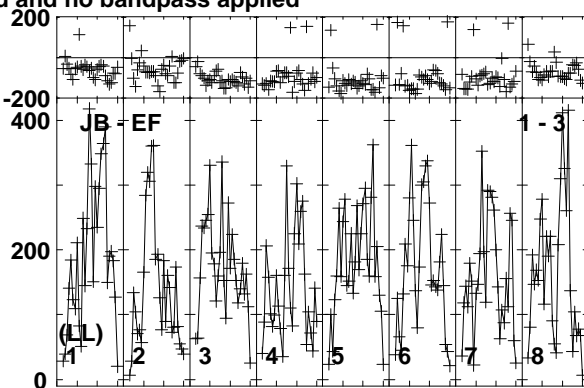
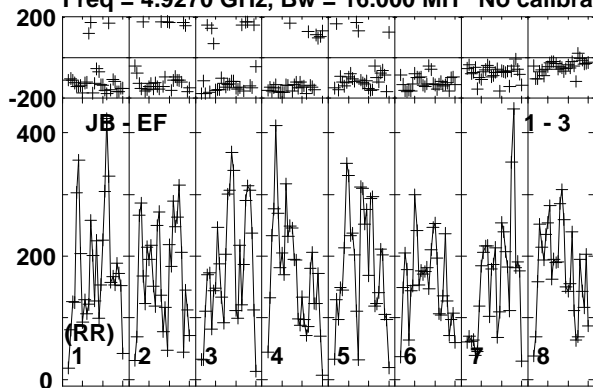

Lower frame: Micro Ampl Jy Top frame: Phas deg  
Vector averaged cross-power spectrum Baseline: JB (01) - EF (03)  
Timerange: 00/19:43:01 to 00/19:44:59



Plot file version1059 created 19-DEC-2018 17:59:20

VLA1 RY007C.UVDATA.1

Freq = 4.9270 GHz, Bw = 16.000 MH No calibration applied and no bandpass applied

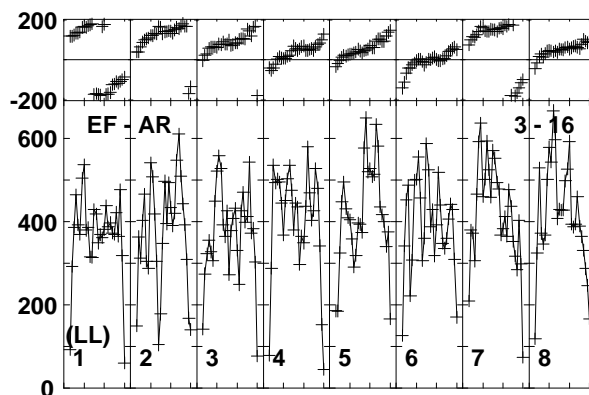
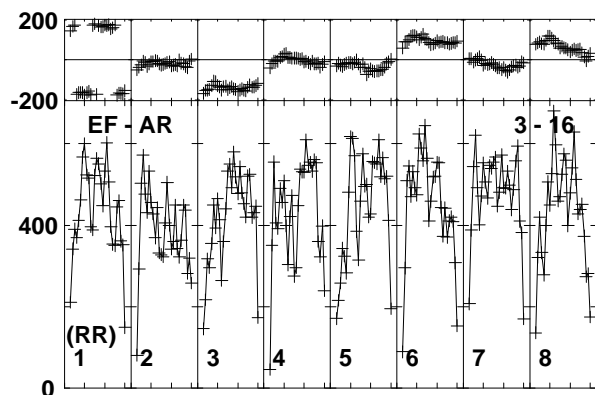
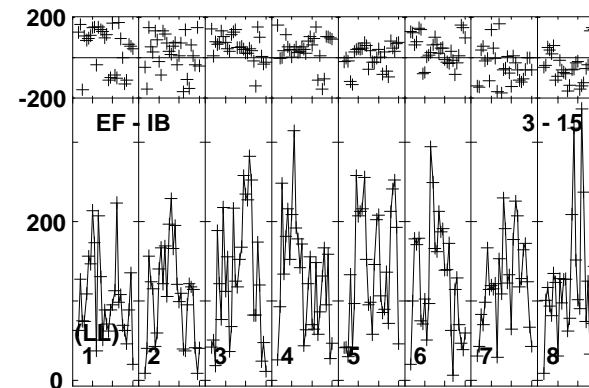
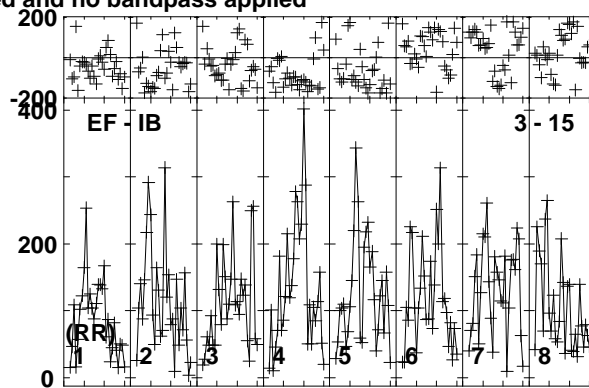
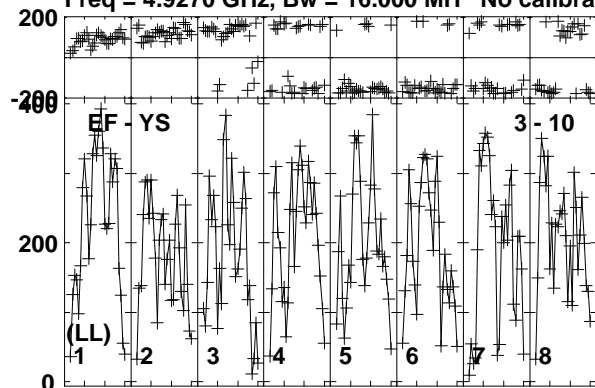

Lower frame: Micro Ampl Jy Top frame: Phas deg  
Vector averaged cross-power spectrum Baseline: EF (03) - YS (10)  
Timerange: 00:19:43:01 to 00:19:44:59

Plot file version1060 created 19-DEC-2018 17:59:20

J1619+2247 RY007C.UVDATA.1

Freq = 4.9270 GHz, Bw = 16.000 MH No calibration applied and no bandpass applied

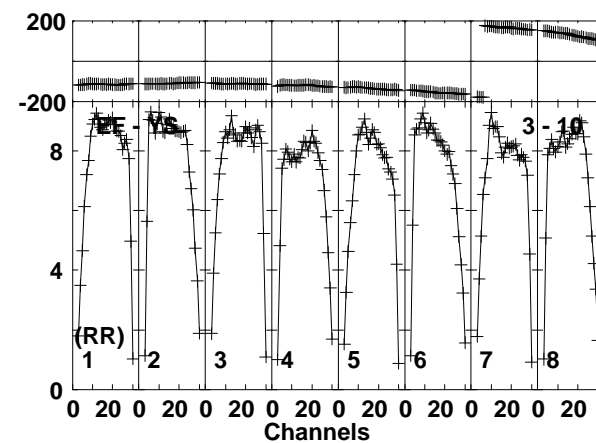
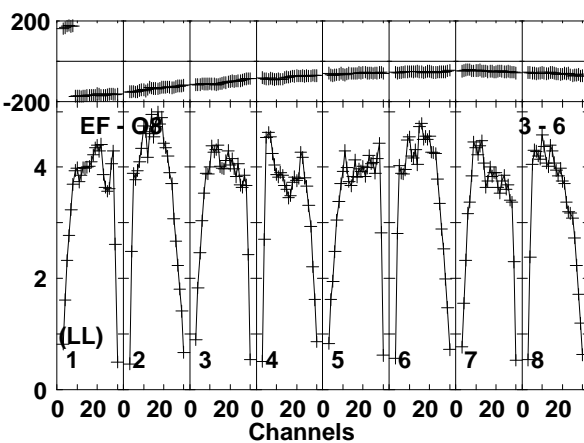
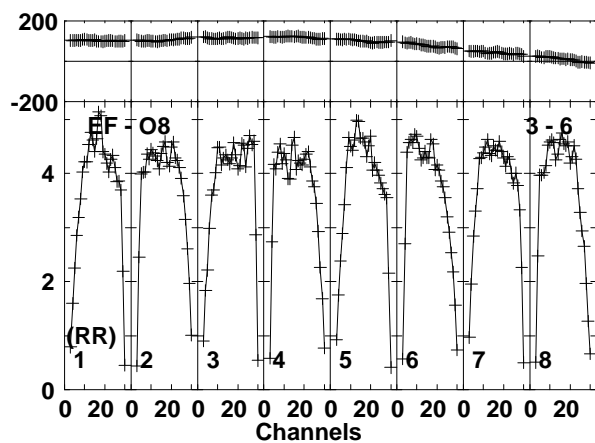
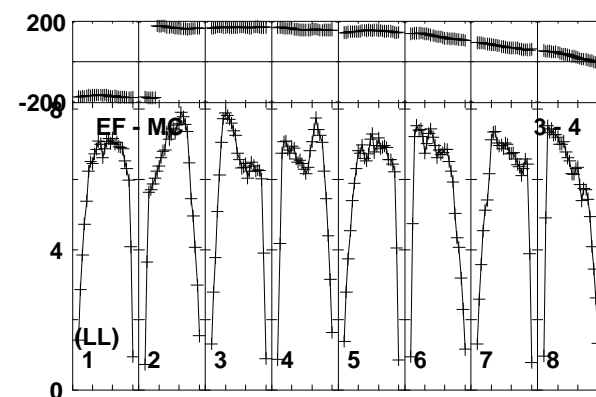
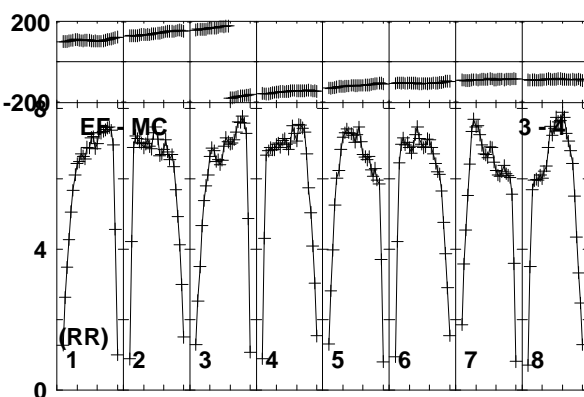
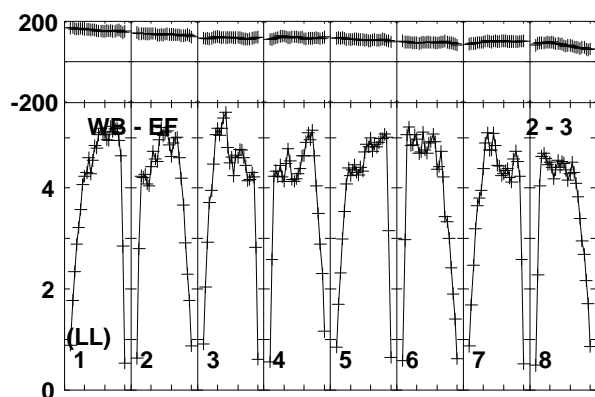
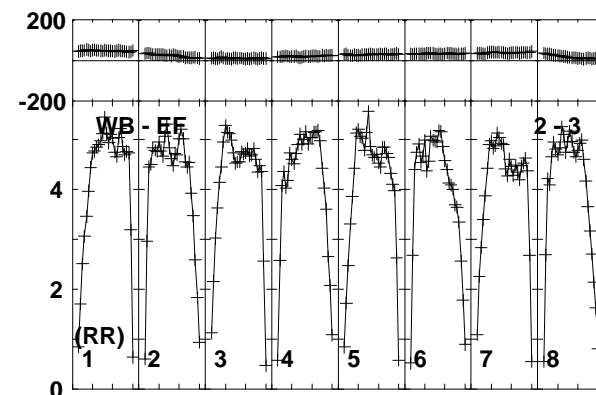
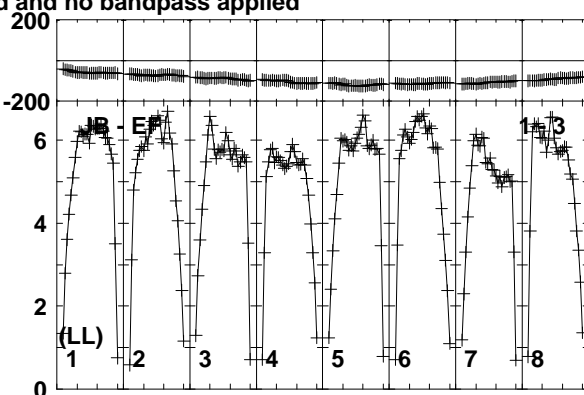
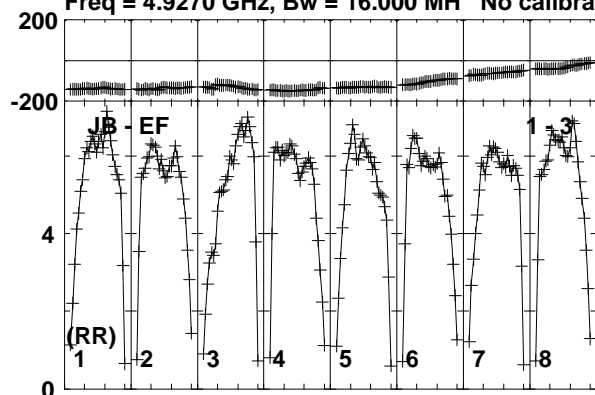

Lower frame: Milli Ampl Jy Top frame: Phas deg  
Vector averaged cross-power spectrum Baseline: JB (01) - EF (03)  
Timerange: 00/19:45:01 to 00/19:45:59

Plot file version1061 created 19-DEC-2018 17:59:20  
J1619+2247 RY007C.UVDATA.1

Freq = 4.9270 GHz, Bw = 16.000 MH No calibration applied and no bandpass applied

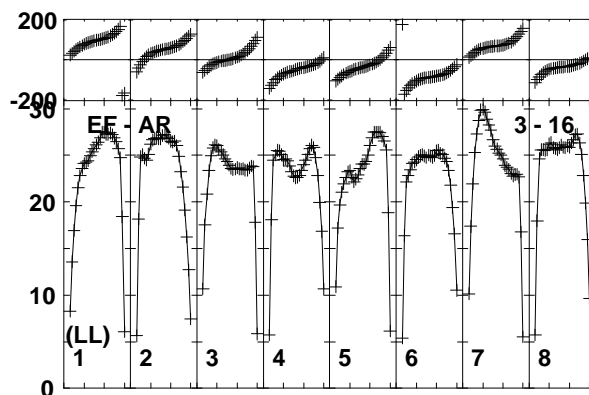
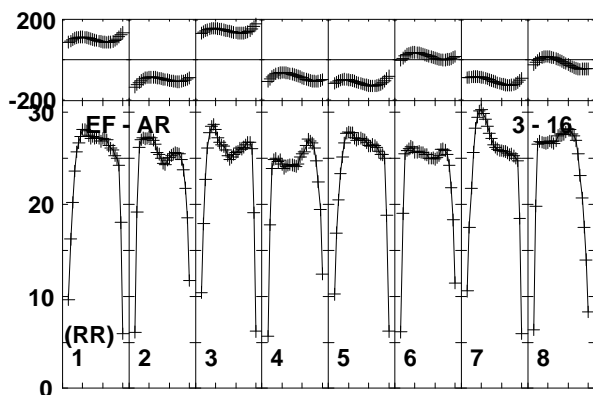
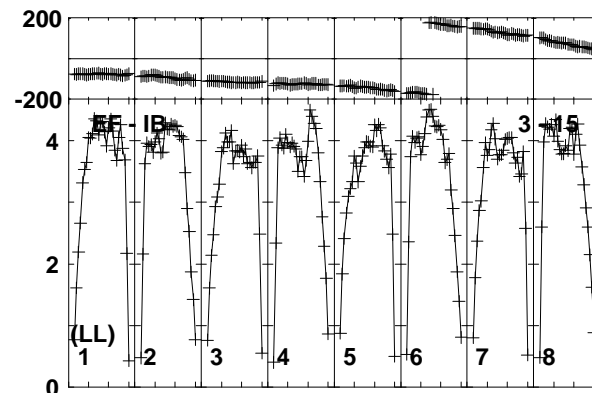
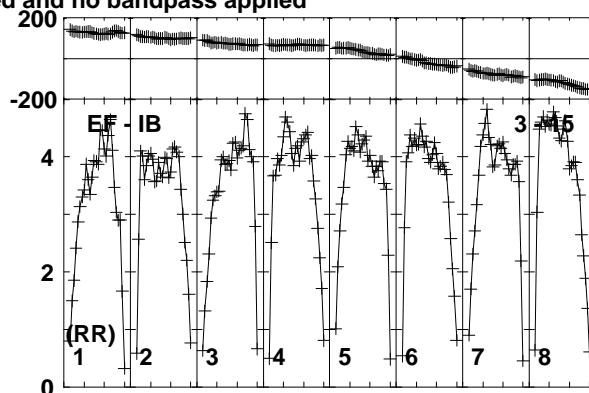
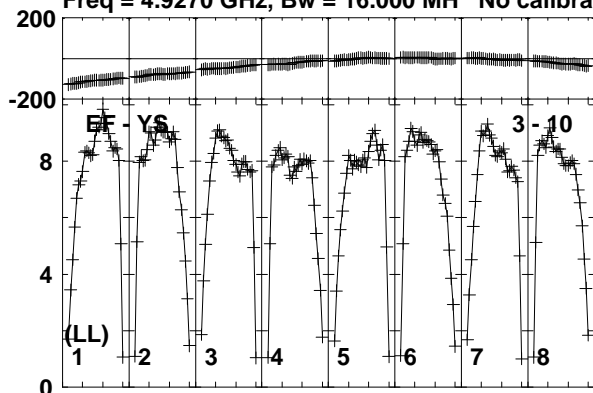

Lower frame: Milli Ampl Jy Top frame: Phas deg  
Vector averaged cross-power spectrum Baseline: EF (03) - YS (10)  
Timerange: 00/19:45:01 to 00/19:45:59

Plot file version1062 created 19-DEC-2018 17:59:20

AT2018\_RY007C.UVDATA.1

Freq = 4.9270 GHz, Bw = 16.000 MH No calibration applied and no bandpass applied

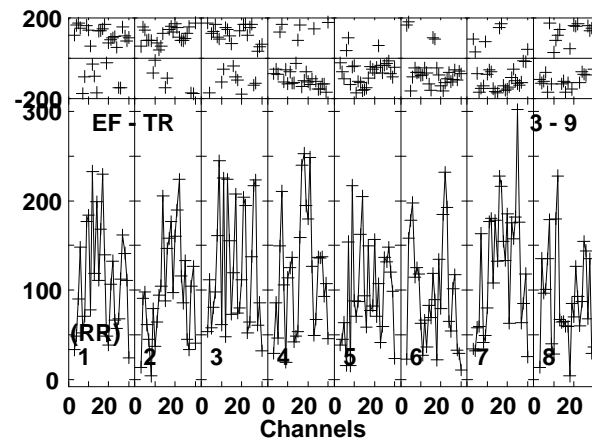
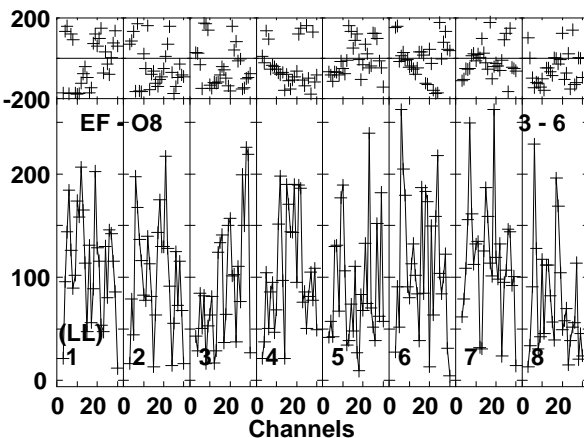
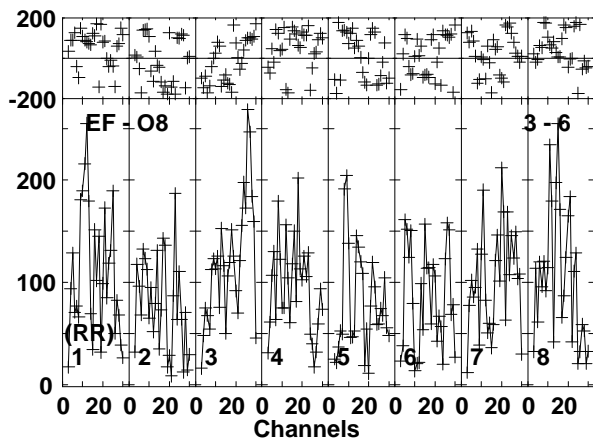
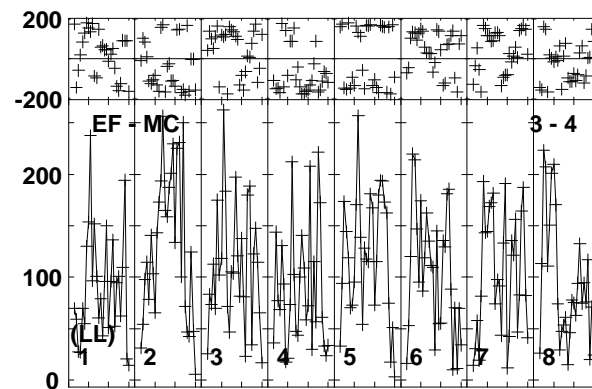
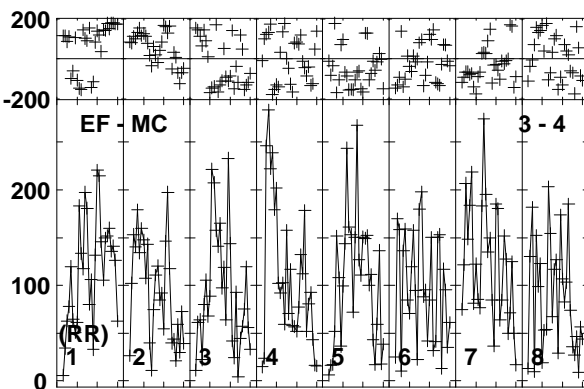
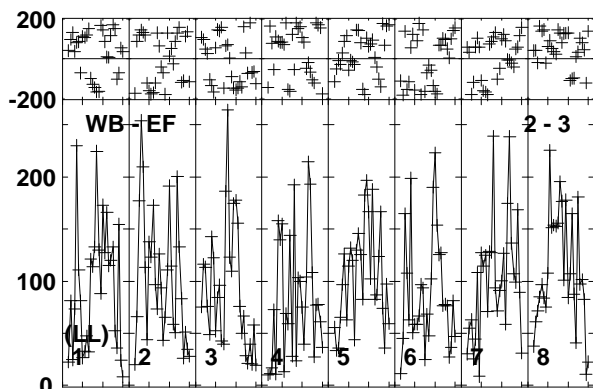
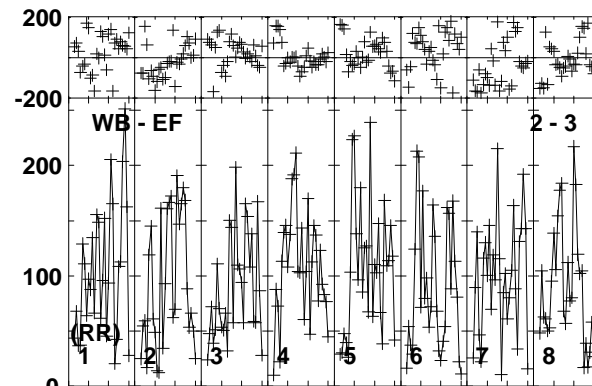
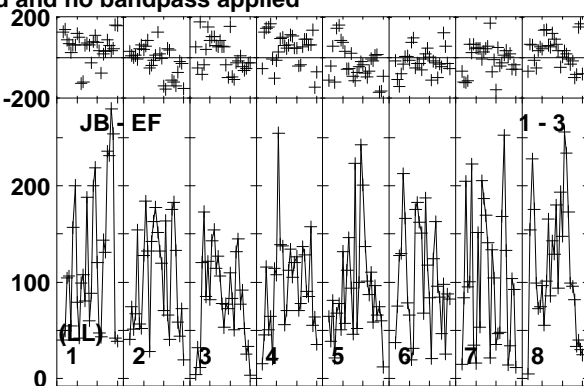
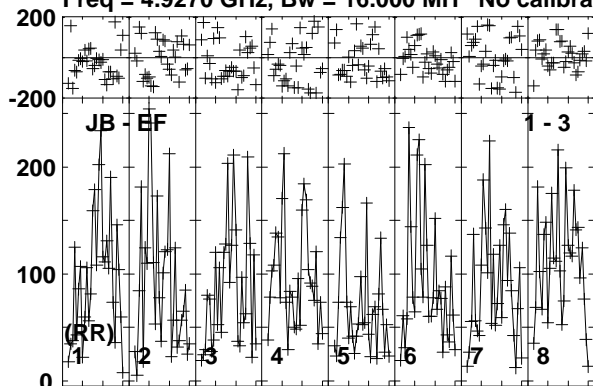

Lower frame: Micro Ampl Jy Top frame: Phas deg  
Vector averaged cross-power spectrum Baseline: JB (01) - EF (03)  
Timerange: 00/19:46:01 to 00/19:48:59

Plot file version1063 created 19-DEC-2018 17:59:20

AT2018\_RY007C.UVDATA.1

Freq = 4.9270 GHz, Bw = 16.000 MH No calibration applied and no bandpass applied

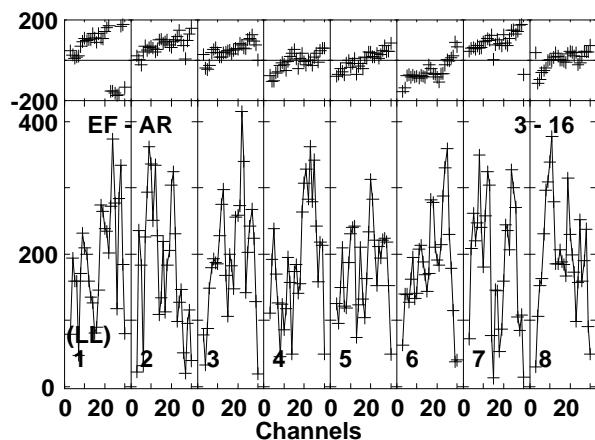
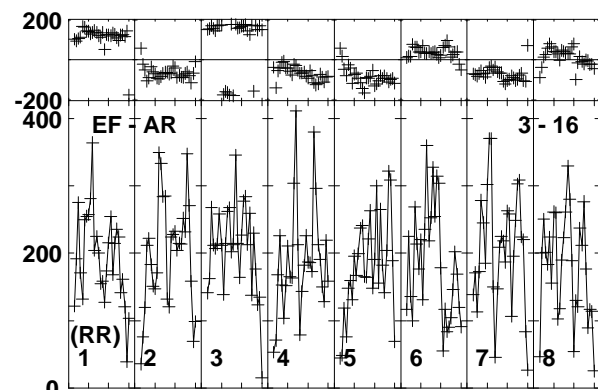
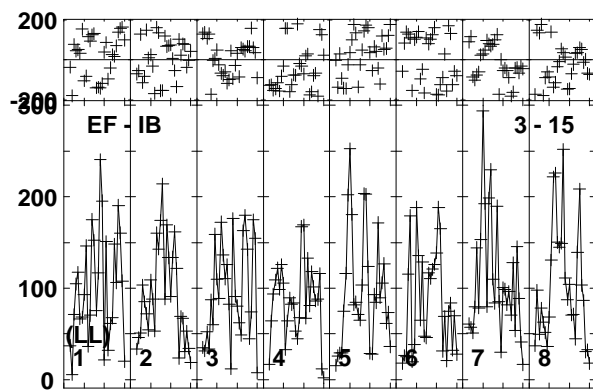
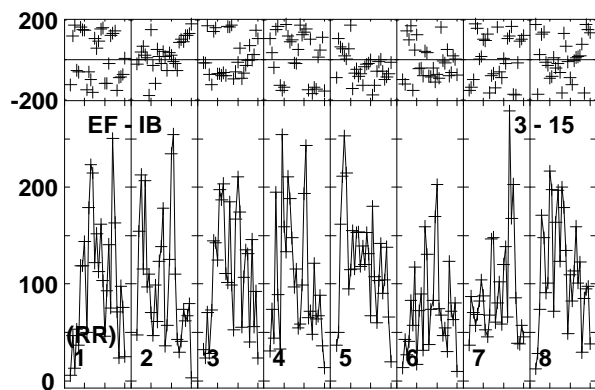
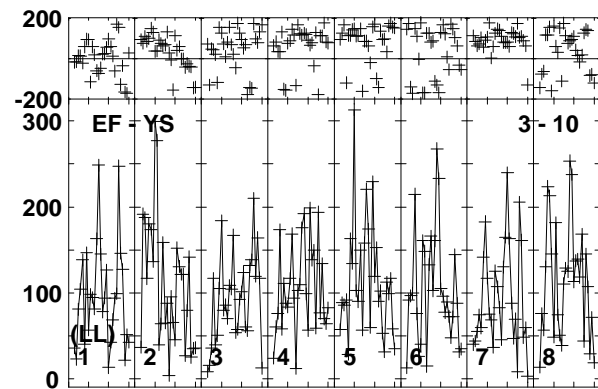
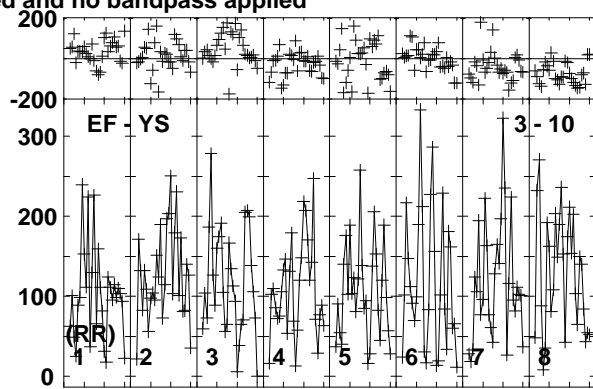
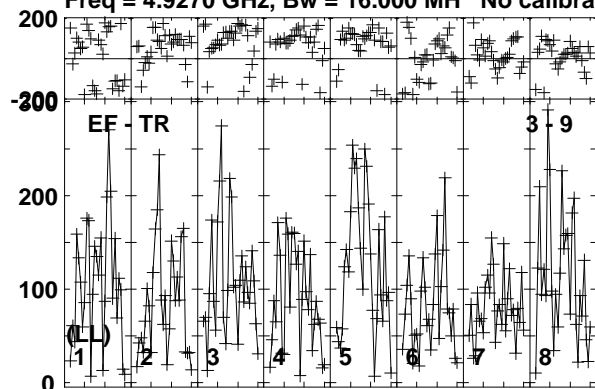

Lower frame: Micro Ampl Jy Top frame: Phas deg  
Vector averaged cross-power spectrum Baseline: EF (03) - TR (09)  
Timerange: 00/19:46:01 to 00/19:48:59

Plot file version1064 created 19-DEC-2018 17:59:20

J1619+2247 RY007C.UVDATA.1

Freq = 4.9270 GHz, Bw = 16.000 MH No calibration applied and no bandpass applied

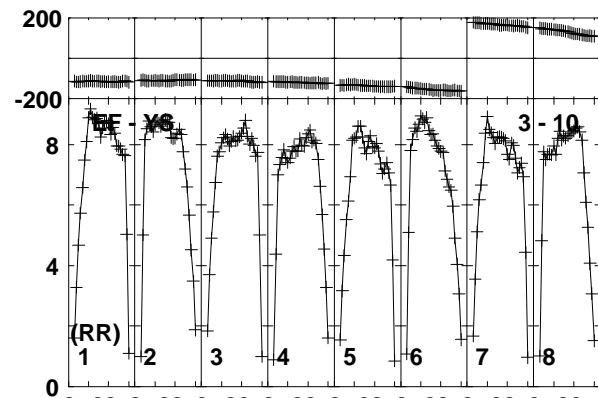
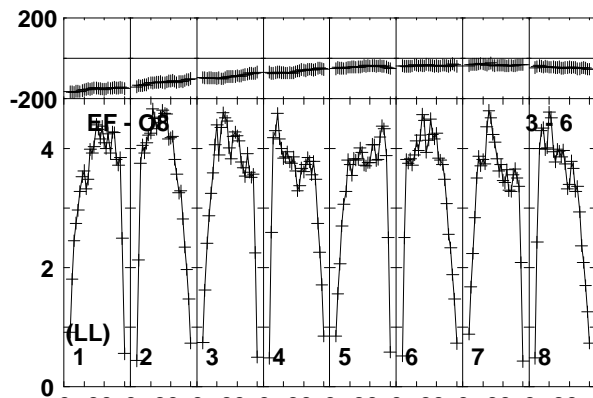
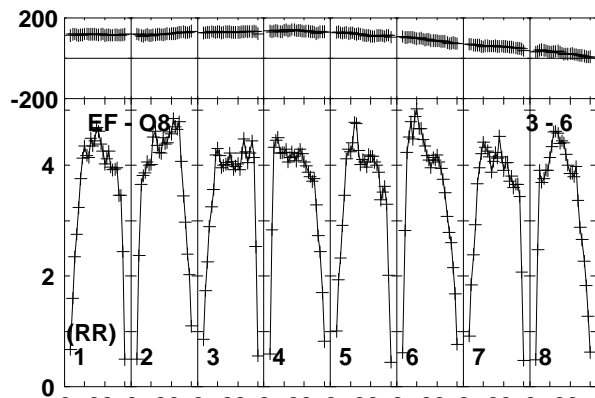
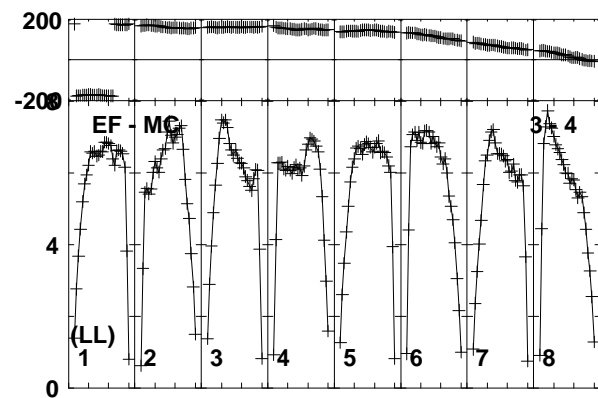
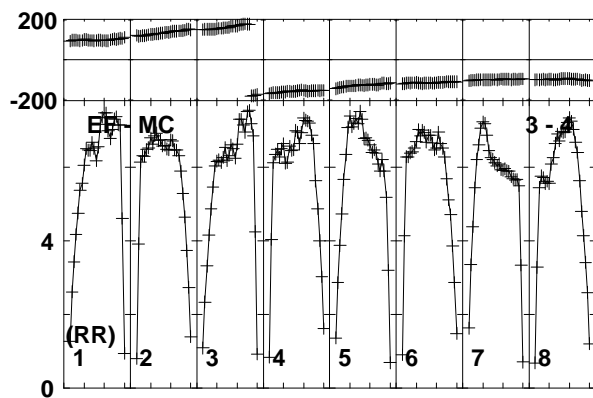
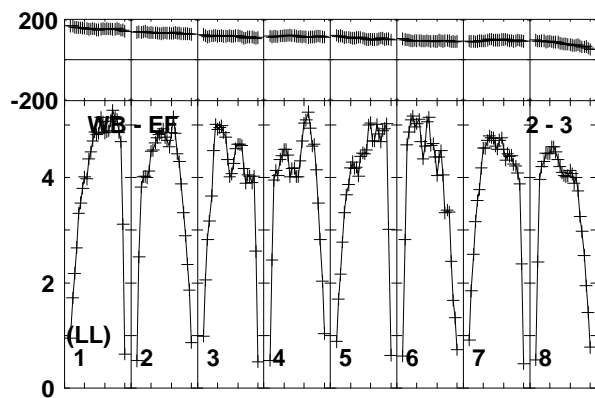
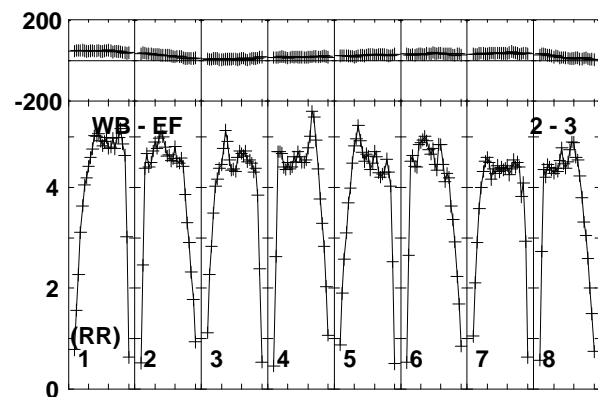
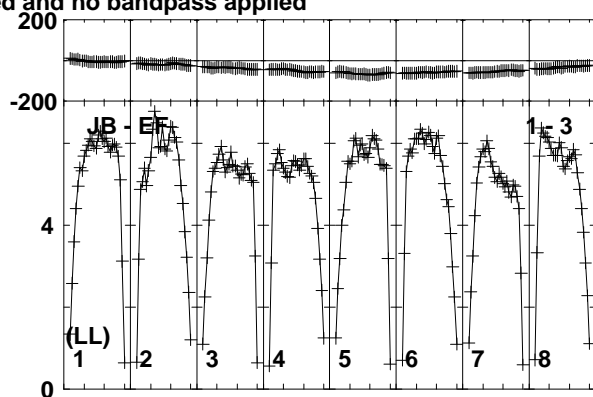
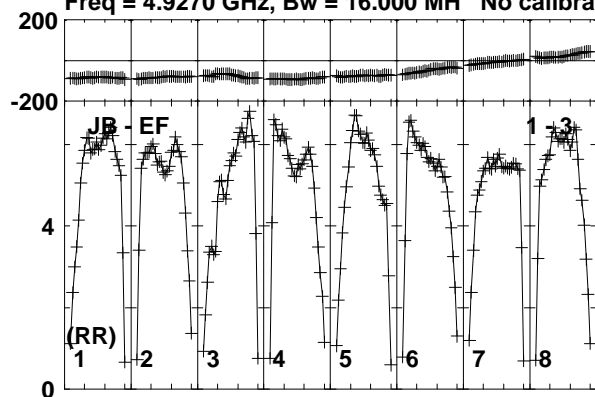

Lower frame: Milli Ampl Jy Top frame: Phas deg  
Vector averaged cross-power spectrum Baseline: JB (01) - EF (03)  
Timerange: 00/19:49:01 to 00/19:49:59

Plot file version1065 created 19-DEC-2018 17:59:20

J1619+2247 RY007C.UVDATA.1

Freq = 4.9270 GHz, Bw = 16.000 MH No calibration applied and no bandpass applied

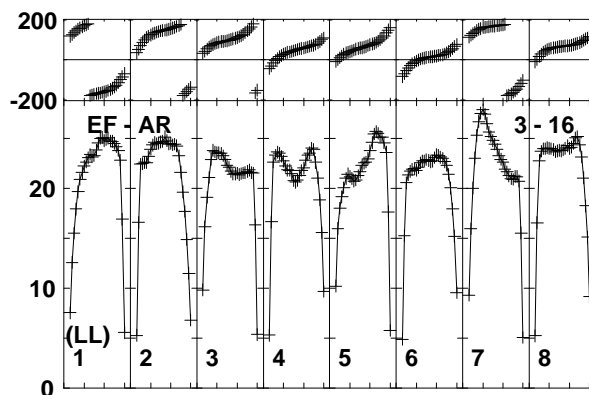
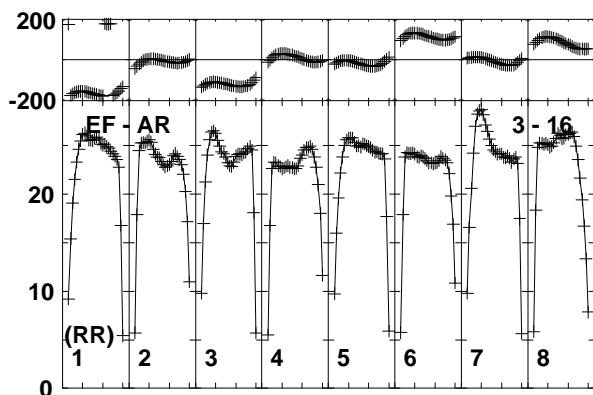
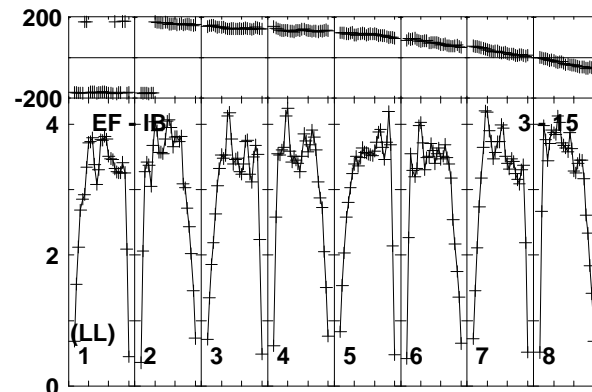
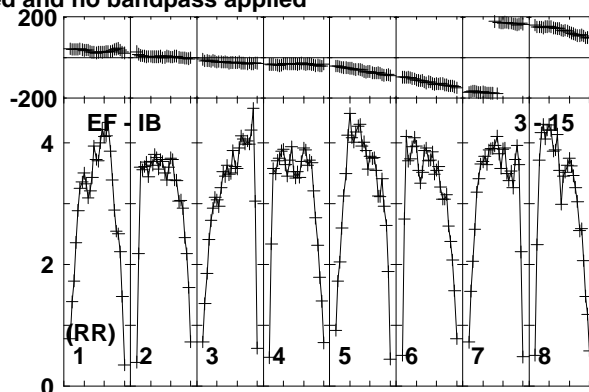
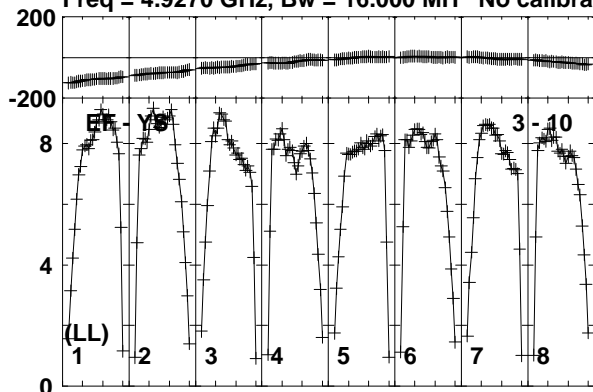

Lower frame: Milli Ampl Jy Top frame: Phas deg  
Vector averaged cross-power spectrum Baseline: EF (03) - YS (10)  
Timerange: 00/19:49:01 to 00/19:49:59

Plot file version1066 created 19-DEC-2018 17:59:20

AT2018\_RY007C.UVDATA.1

Freq = 4.9270 GHz, Bw = 16.000 MH No calibration applied and no bandpass applied

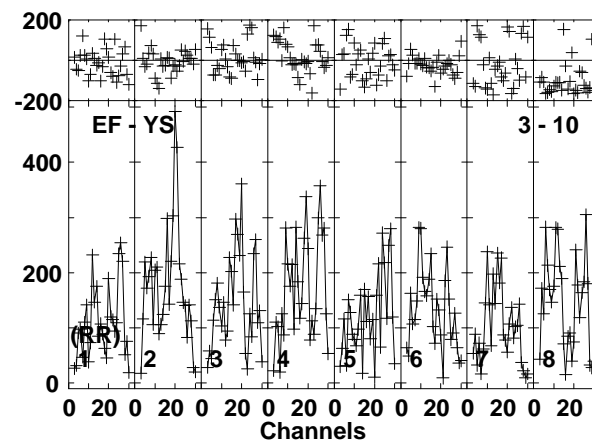
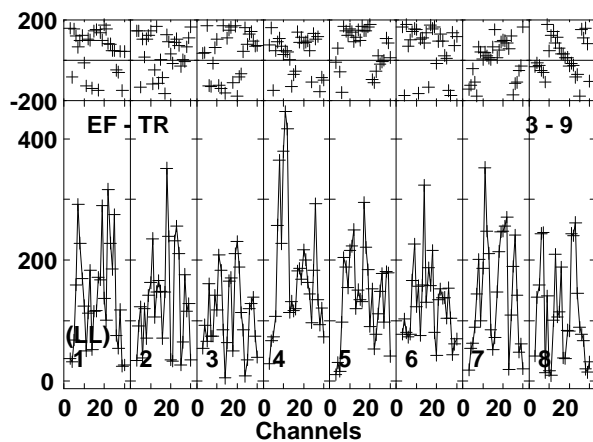
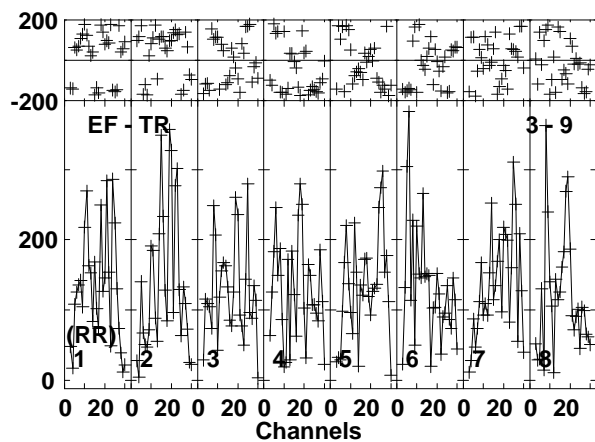
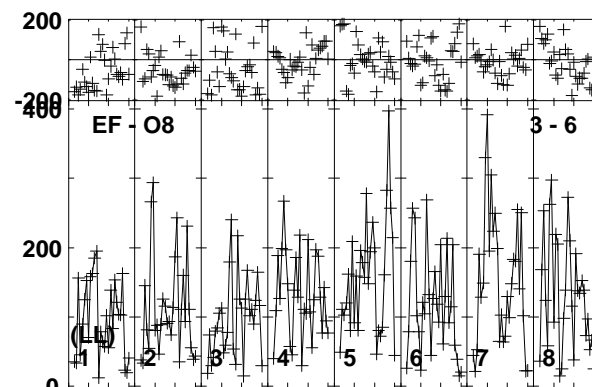
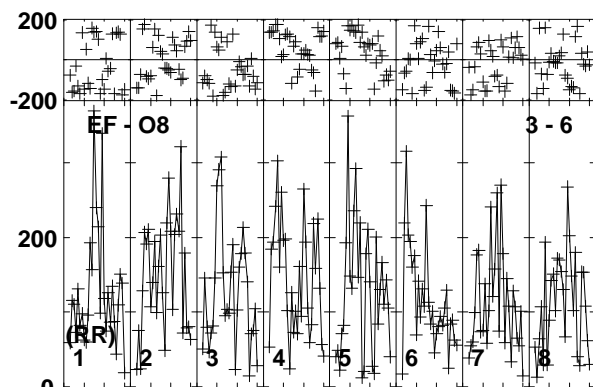
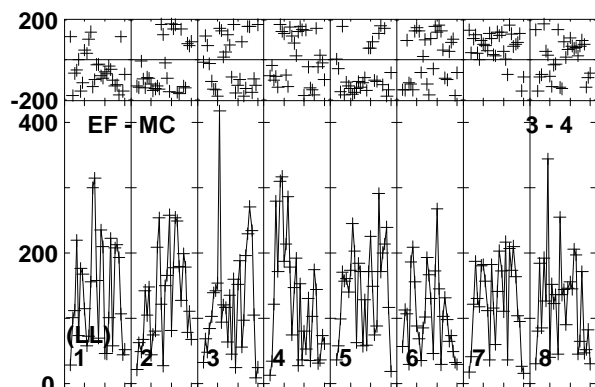
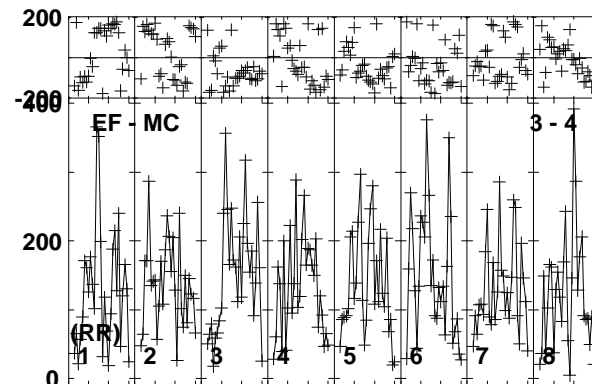
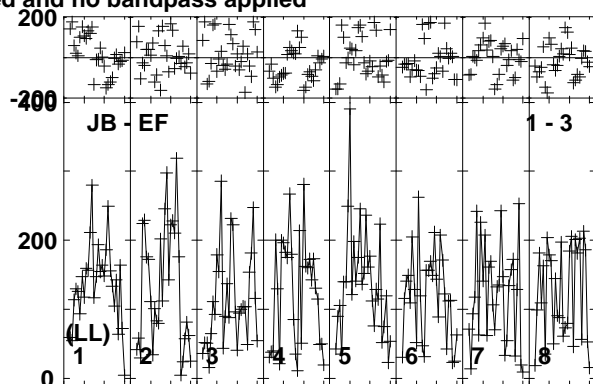
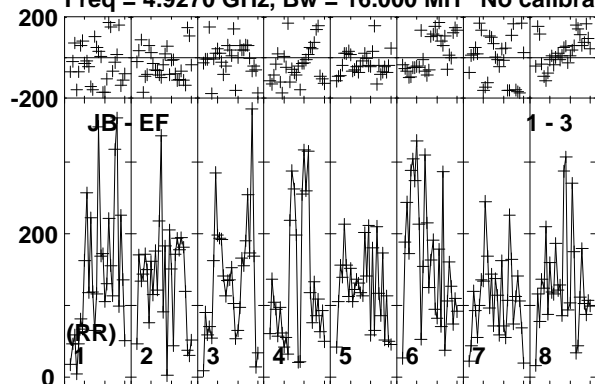

Lower frame: Micro Ampl Jy Top frame: Phas deg  
Vector averaged cross-power spectrum Baseline: JB (01) - EF (03)  
Timerange: 00/19:50:01 to 00/19:51:59



Plot file version1067 created 19-DEC-2018 17:59:20

AT2018\_RY007C.UVDATA.1

Freq = 4.9270 GHz, Bw = 16.000 MH No calibration applied and no bandpass applied

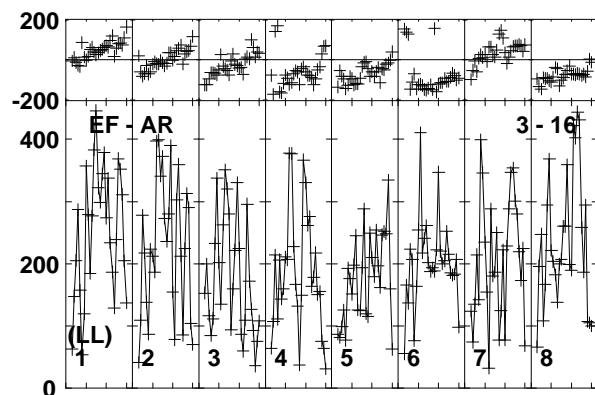
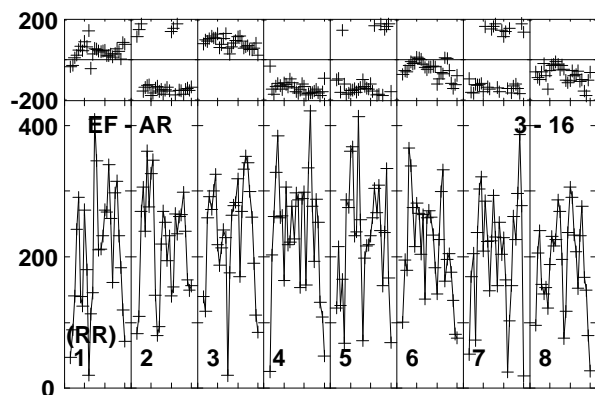
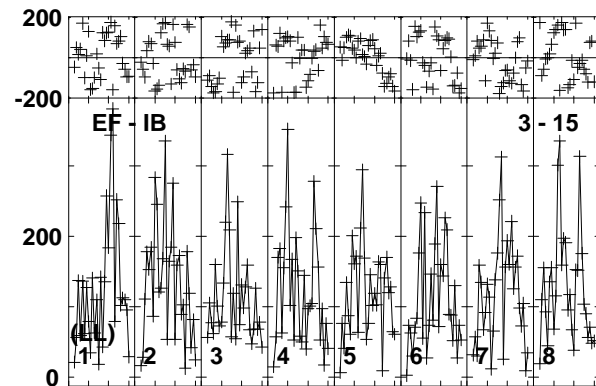
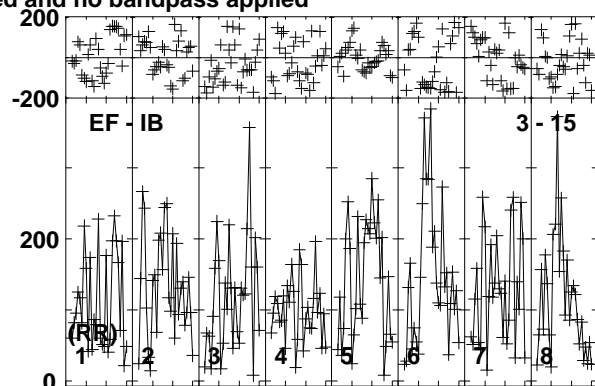
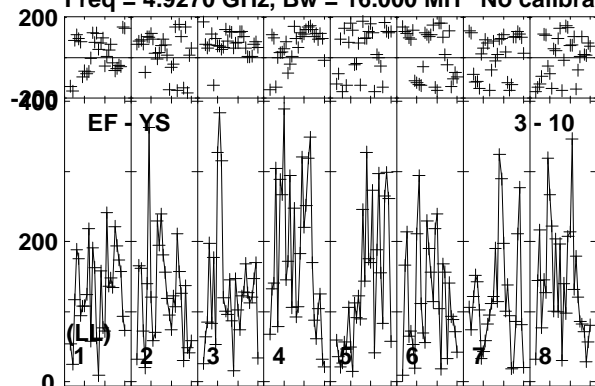

Lower frame: Micro Ampl Jy Top frame: Phas deg  
Vector averaged cross-power spectrum Baseline: EF (03) - YS (10)  
Timerange: 00/19:50:01 to 00/19:51:59

Plot file version1068 created 19-DEC-2018 17:59:20

VLA2 RY007C.UVDATA.1

Freq = 4.9270 GHz, Bw = 16.000 MH No calibration applied and no bandpass applied

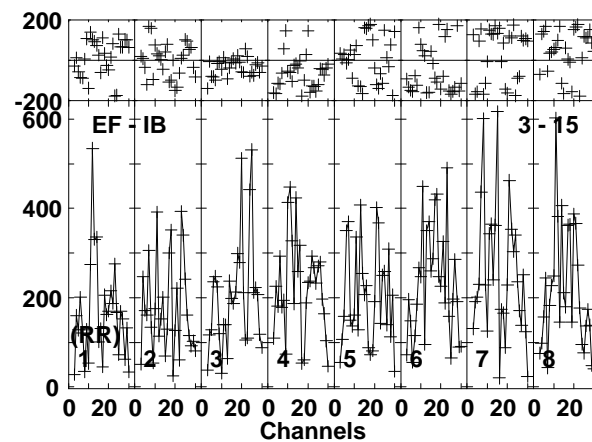
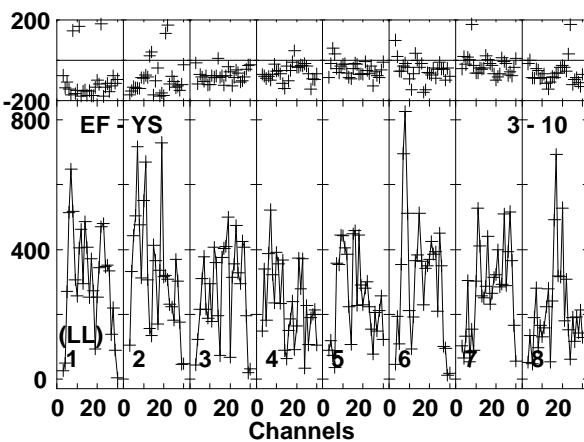
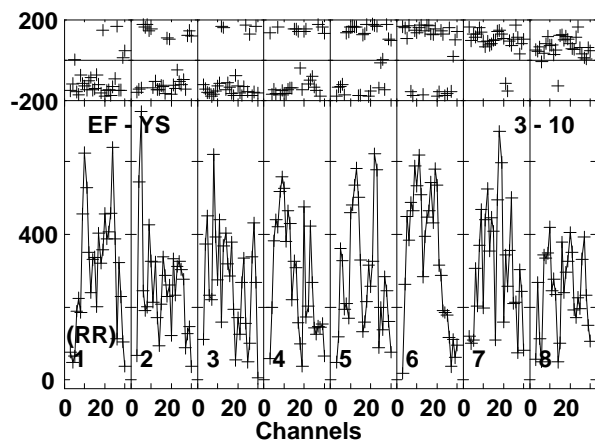
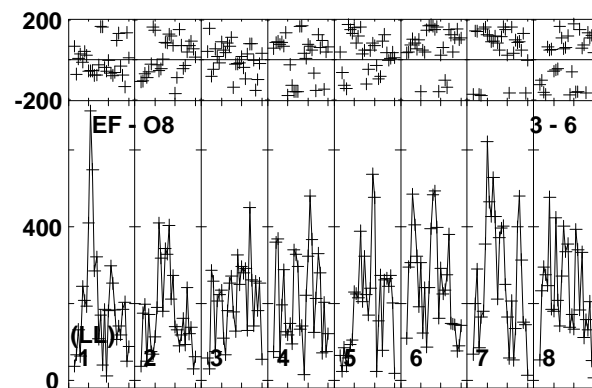
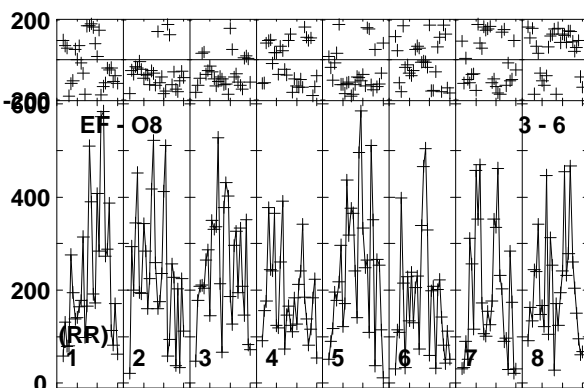
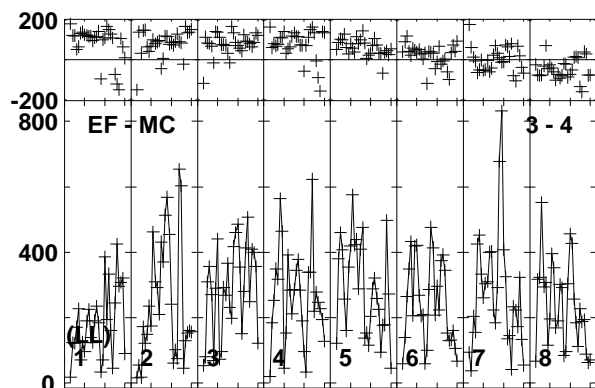
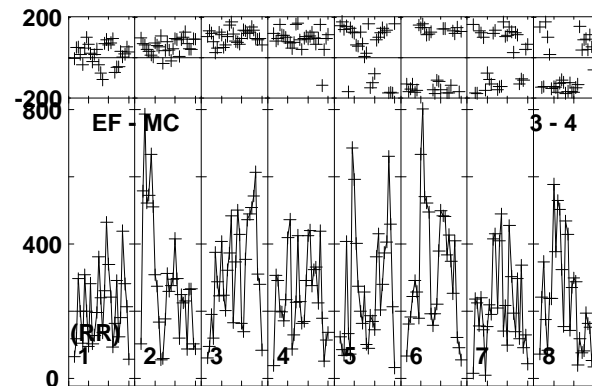
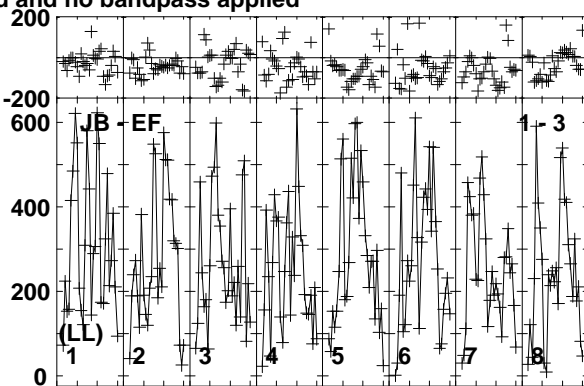
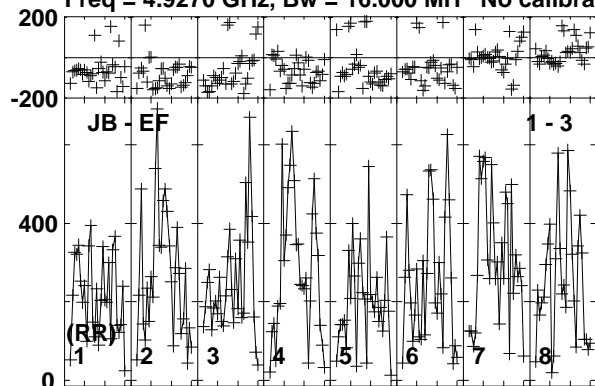

Lower frame: Micro Ampl Jy Top frame: Phas deg  
Vector averaged cross-power spectrum Baseline: JB (01) - EF (03)  
Timerange: 00/19:52:01 to 00/19:52:59

Plot file version1069 created 19-DEC-2018 17:59:20

VLA2 RY007C.UVDATA.1

Freq = 4.9270 GHz, Bw = 16.000 MH No calibration applied and no bandpass applied

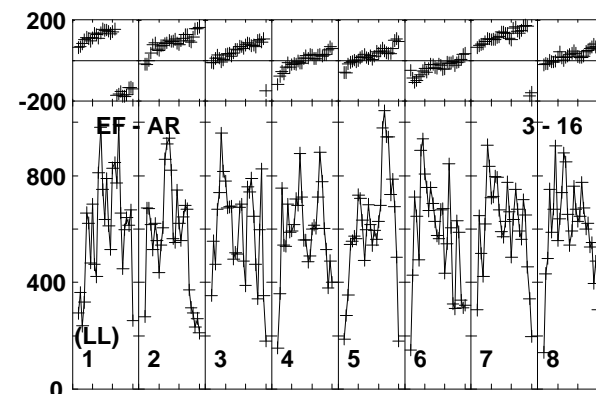
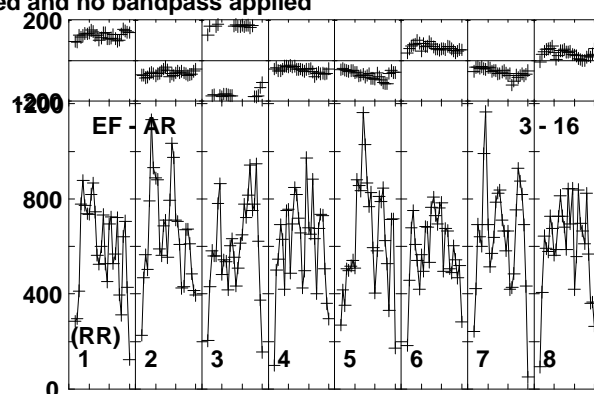
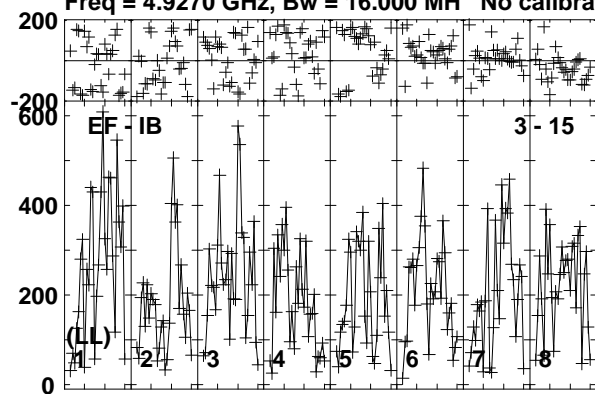

Lower frame: Micro Ampl Jy Top frame: Phas deg  
Vector averaged cross-power spectrum Baseline: EF (03) - IB (15)  
Timerange: 00:19:52:01 to 00:19:52:59

Plot file version1070 created 19-DEC-2018 17:59:20

J1619+2247 RY007C.UVDATA.1

Freq = 4.9270 GHz, Bw = 16.000 MH No calibration applied and no bandpass applied

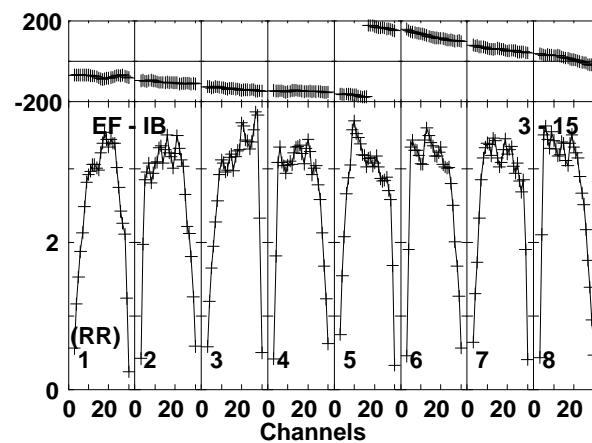
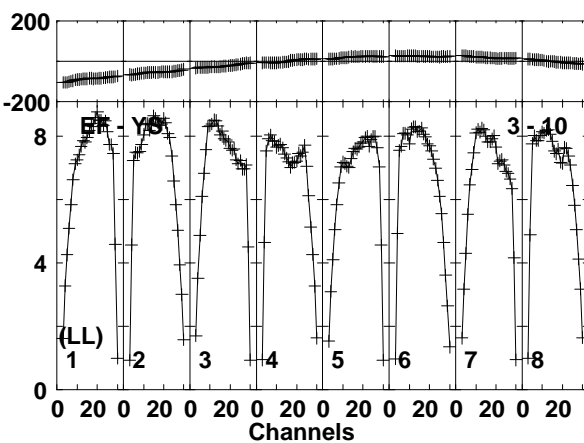
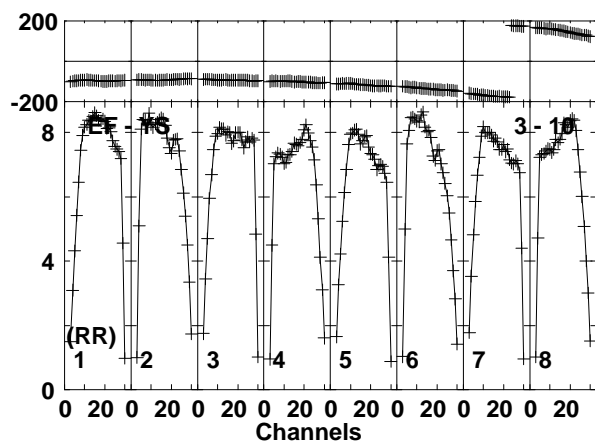
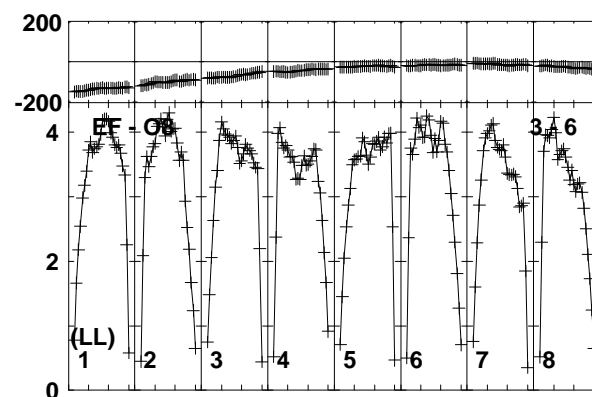
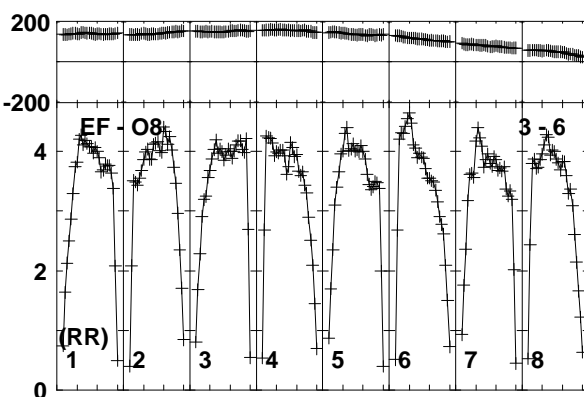
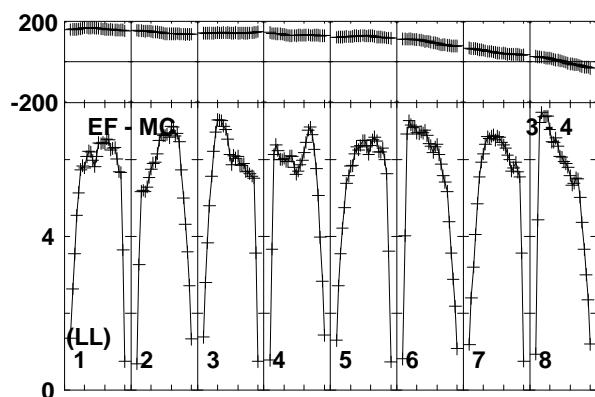
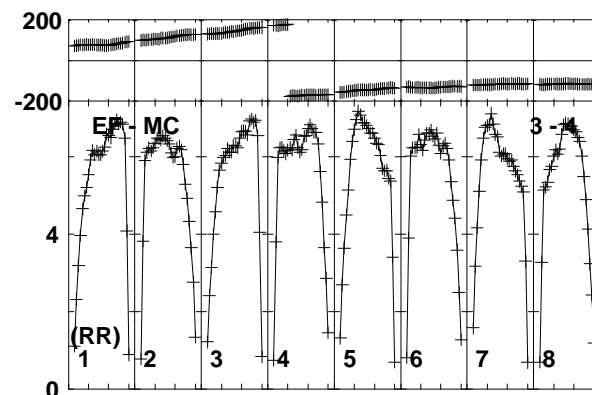
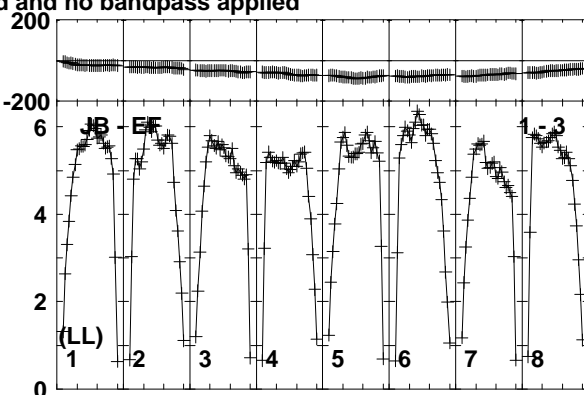
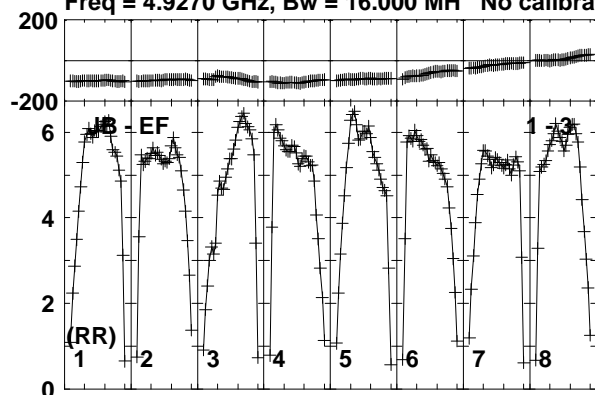

Lower frame: Milli Ampl Jy Top frame: Phas deg  
Vector averaged cross-power spectrum Baseline: JB (01) - EF (03)  
Timerange: 00/19:53:31 to 00/19:54:29

Plot file version1071 created 19-DEC-2018 17:59:20  
J1619+2247 RY007C.UVDATA.1

Freq = 4.9270 GHz, Bw = 16.000 MH No calibration applied and no bandpass applied

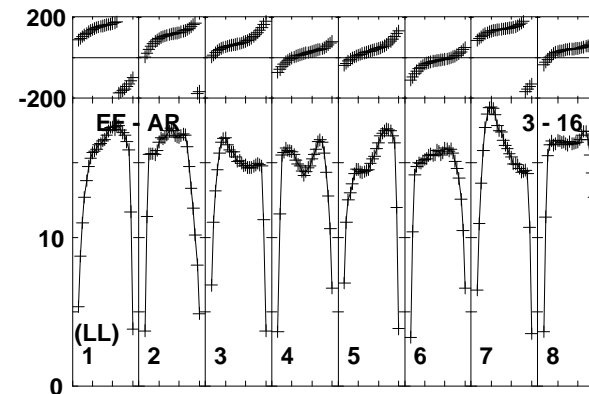
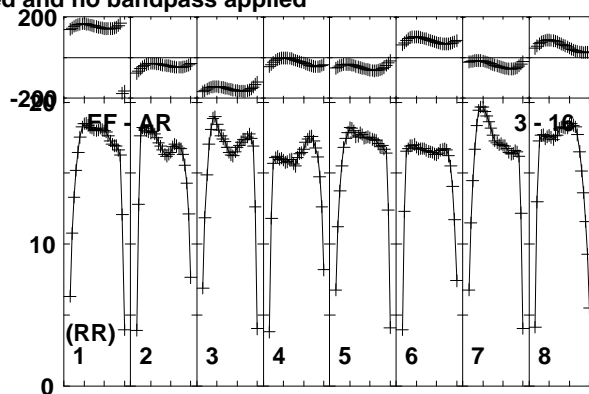
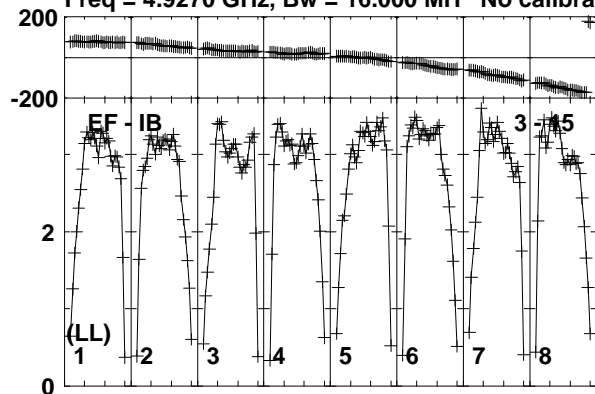

Lower frame: Milli Ampl Jy Top frame: Phas deg  
Vector averaged cross-power spectrum Baseline: EF (03) - IB (15)  
Timerange: 00/19:53:31 to 00/19:54:29

Plot file version1072 created 19-DEC-2018 17:59:20

AT2018\_RY007C.UVDATA.1

Freq = 4.9270 GHz, Bw = 16.000 MH No calibration applied and no bandpass applied

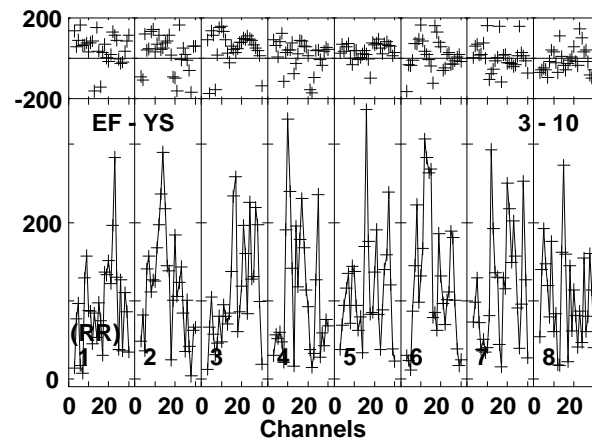
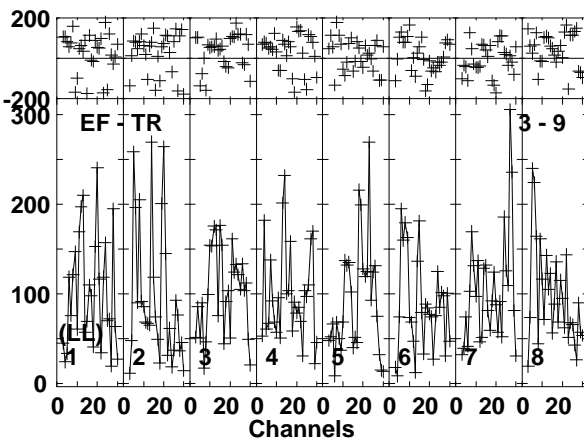
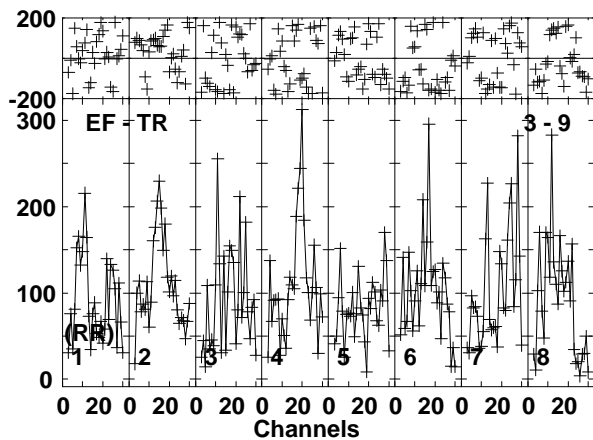
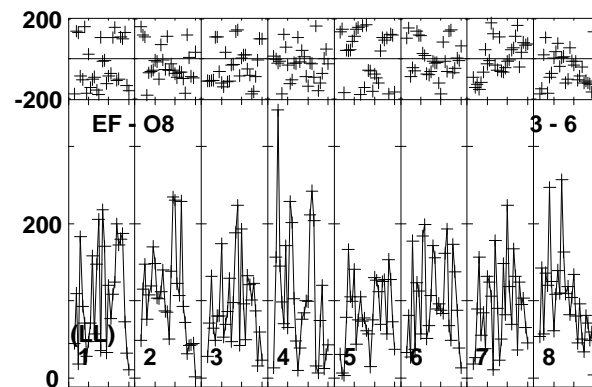
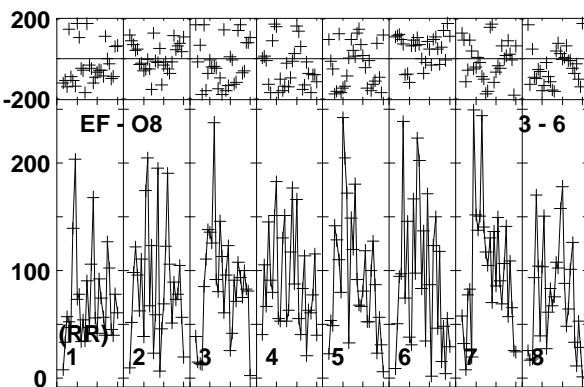
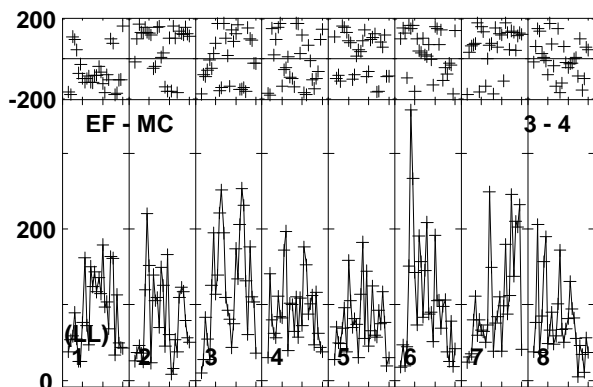
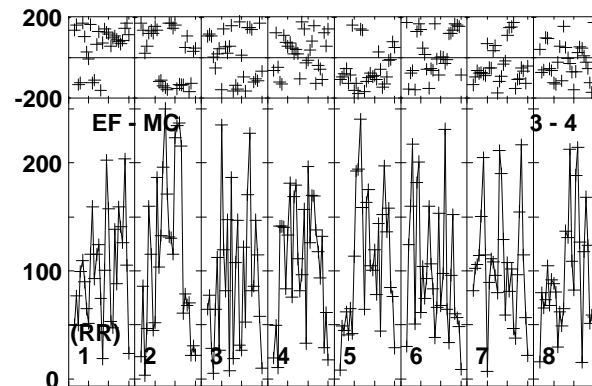
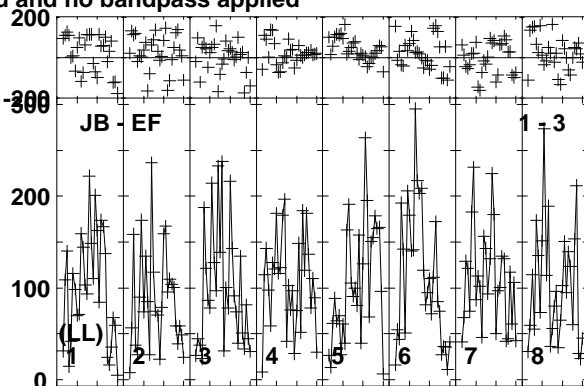
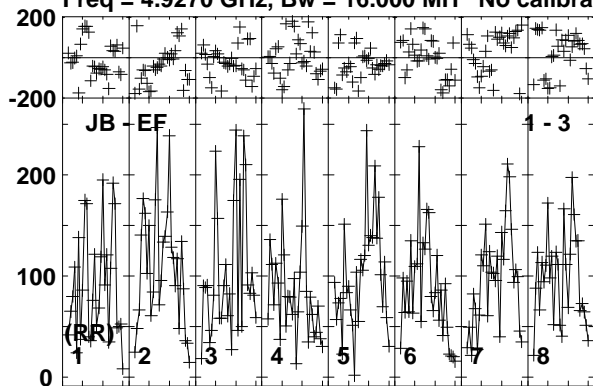

Lower frame: Micro Ampl Jy Top frame: Phas deg  
Vector averaged cross-power spectrum Baseline: JB (01) - EF (03)  
Timerange: 00/19:54:31 to 00/19:57:29

Plot file version1073 created 19-DEC-2018 17:59:20

AT2018\_RY007C.UVDATA.1

Freq = 4.9270 GHz, Bw = 16.000 MH No calibration applied and no bandpass applied

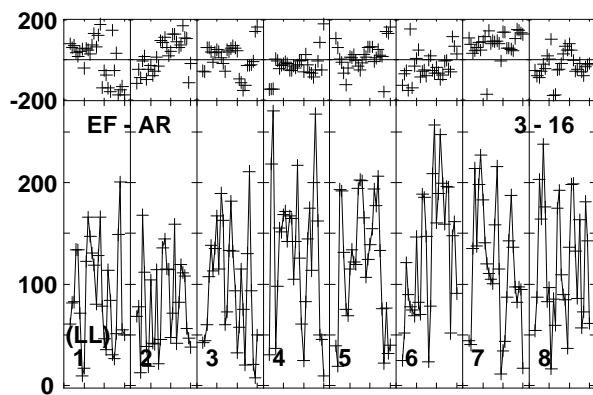
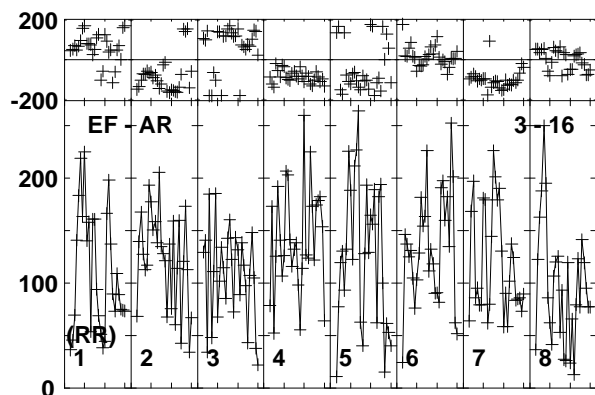
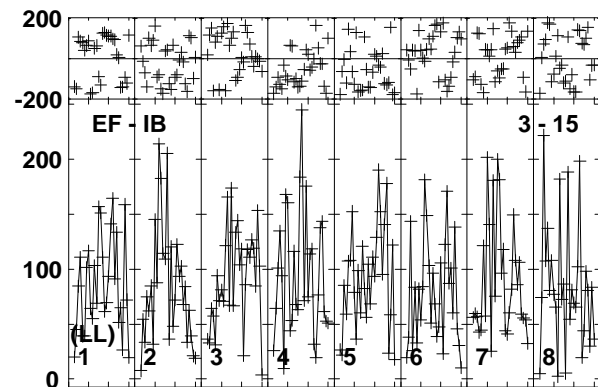
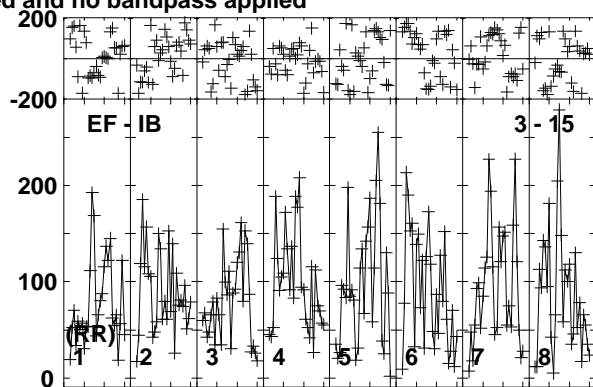
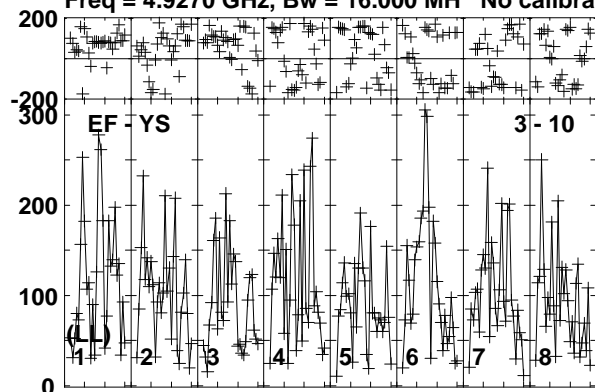

Lower frame: Micro Ampl Jy Top frame: Phas deg  
Vector averaged cross-power spectrum Baseline: EF (03) - YS (10)  
Timerange: 00/19:54:31 to 00/19:57:29

Plot file version1074 created 19-DEC-2018 17:59:20

J1619+2247 RY007C.UVDATA.1

Freq = 4.9270 GHz, Bw = 16.000 MH No calibration applied and no bandpass applied

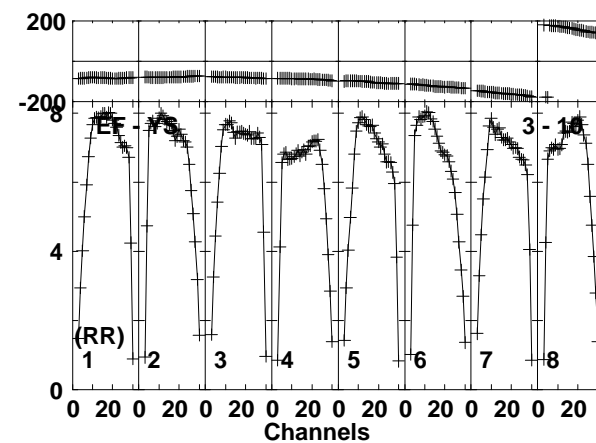
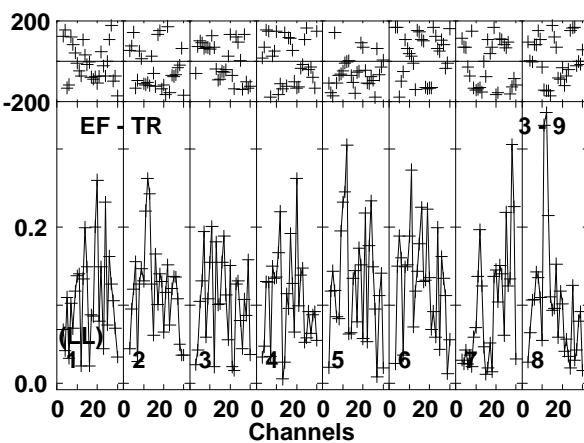
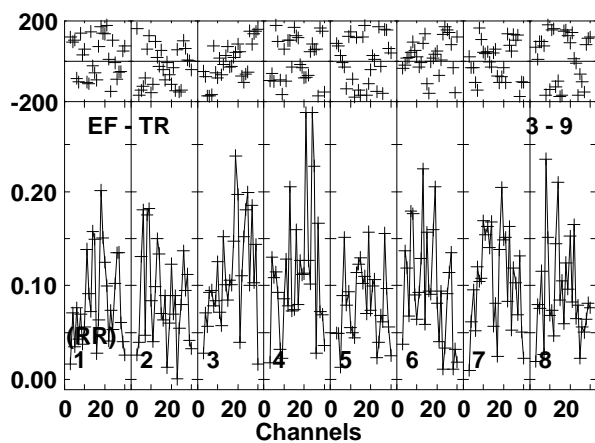
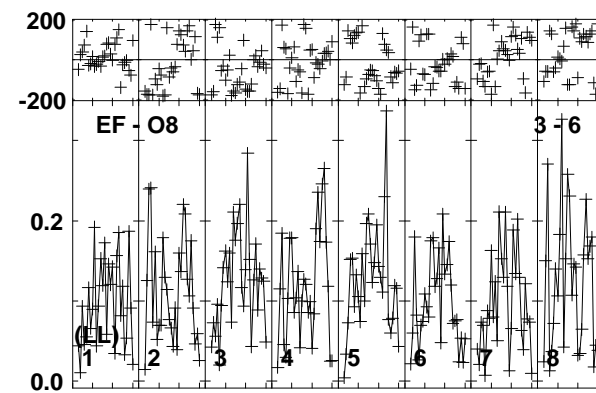
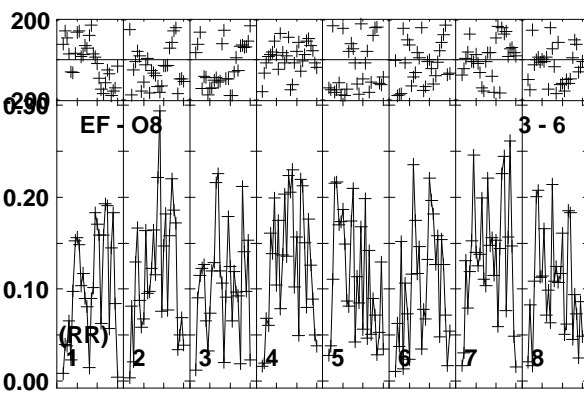
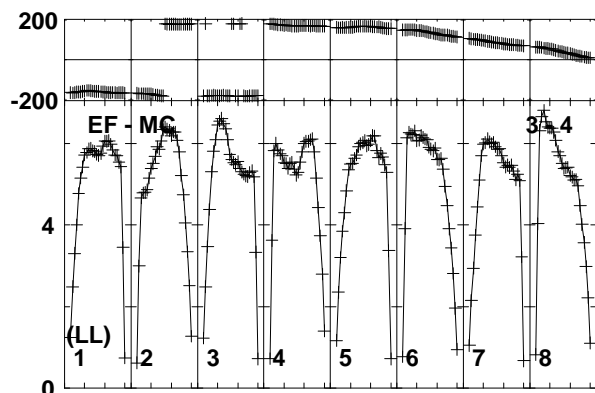
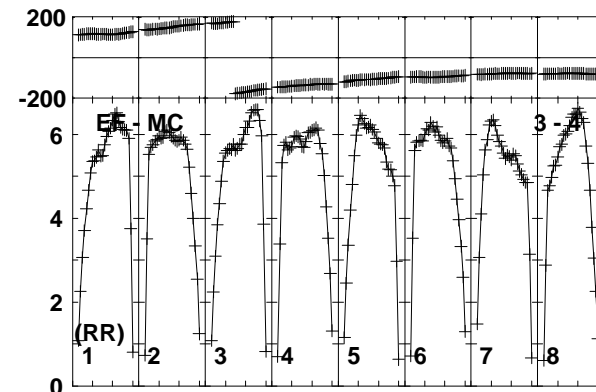
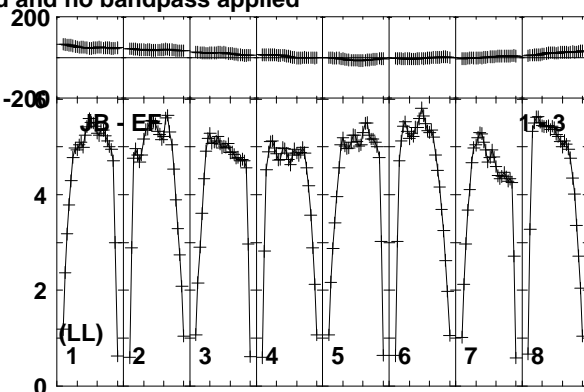
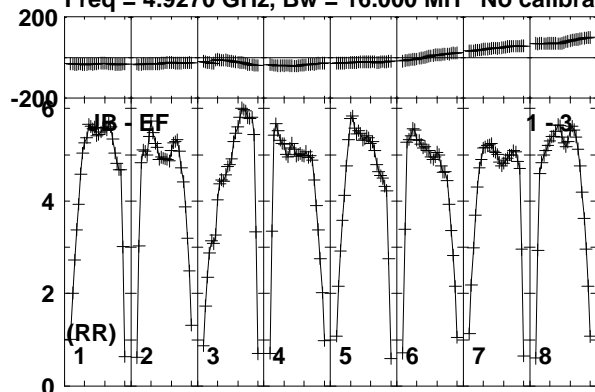

Lower frame: Milli Ampl Jy Top frame: Phas deg  
Vector averaged cross-power spectrum Baseline: JB (01) - EF (03)  
Timerange: 00/19:57:31 to 00/19:59:59



Plot file version1075 created 19-DEC-2018 17:59:21

J1619+2247 RY007C.UVDATA.1

Freq = 4.9270 GHz, Bw = 16.000 MH No calibration applied and no bandpass applied

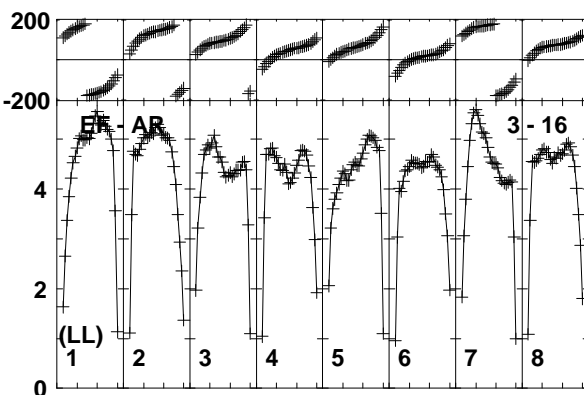
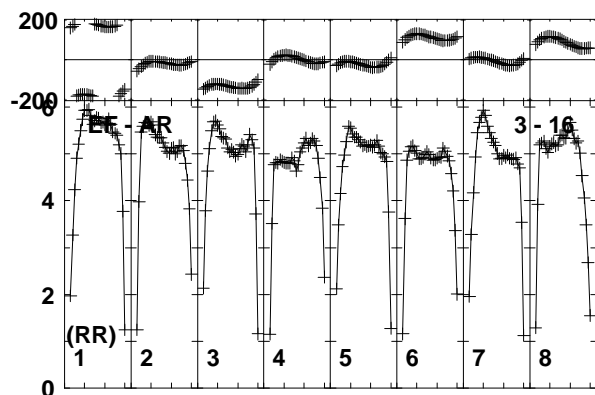
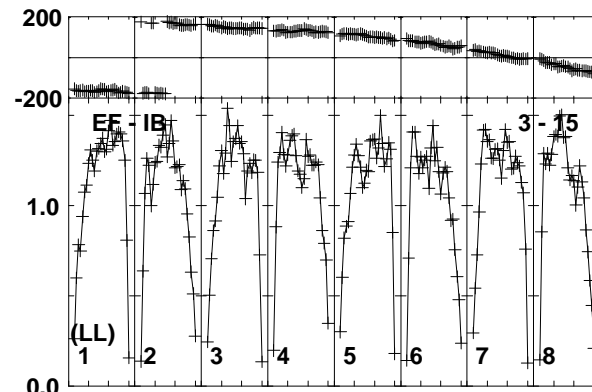
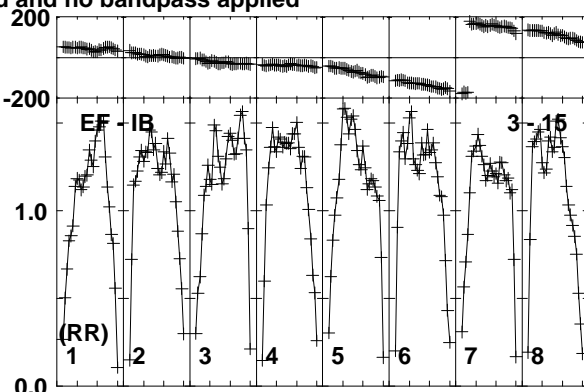
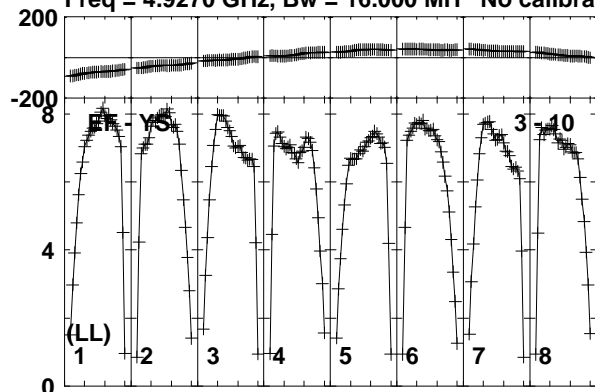

Lower frame: Milli Ampl Jy Top frame: Phas deg  
Vector averaged cross-power spectrum Baseline: EF (03) - YS (10)  
Timerange: 00/19:57:31 to 00/19:59:59